



# STAR WAR



8092



**WARNING: CHOKING HAZARD.**  
Toy contains small parts and a small ball.  
Not for children under 3 years.



1

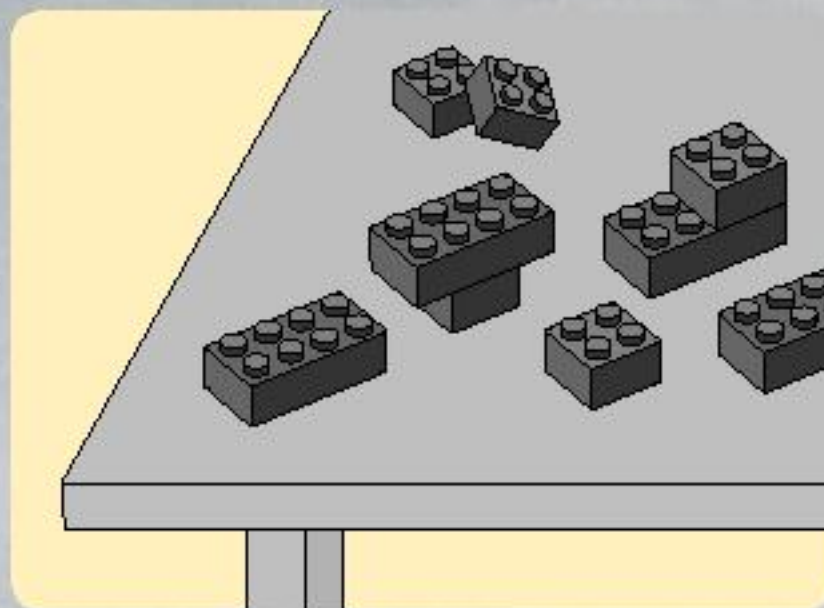
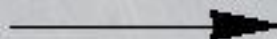
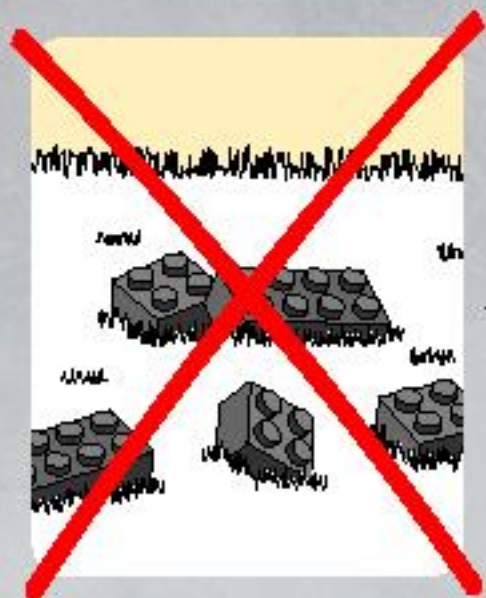

2

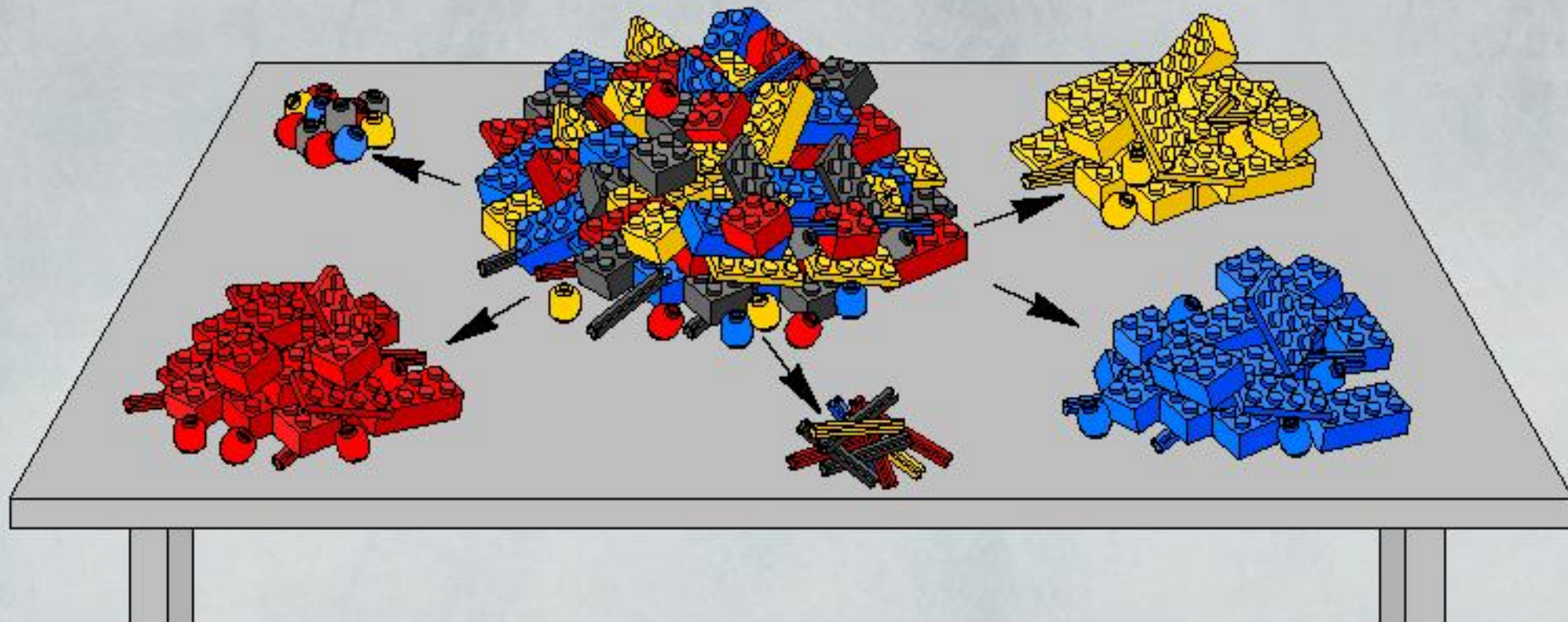

3



1



2



3



**AVERTISSEMENT : RISQUE D'ÉTOUFFEMENT.**  
Le jouet contient des petites pièces ainsi qu'une petite boule.  
Il ne convient pas aux enfants de moins de 3 ans.



**ADVERTENCIA: PELIGRO DE ASFIXIA.**  
Juguete que contiene partes pequeñas y una pelota pequeña.  
No recomendado para niños menores de 3 años.



4

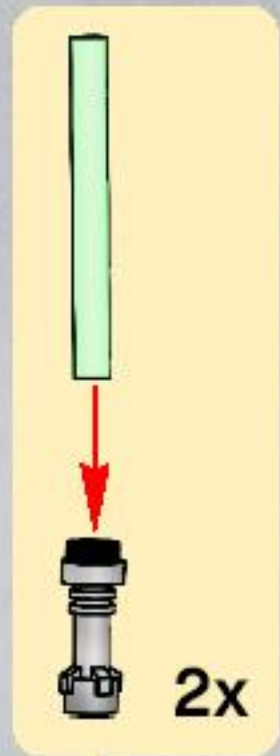

4

5

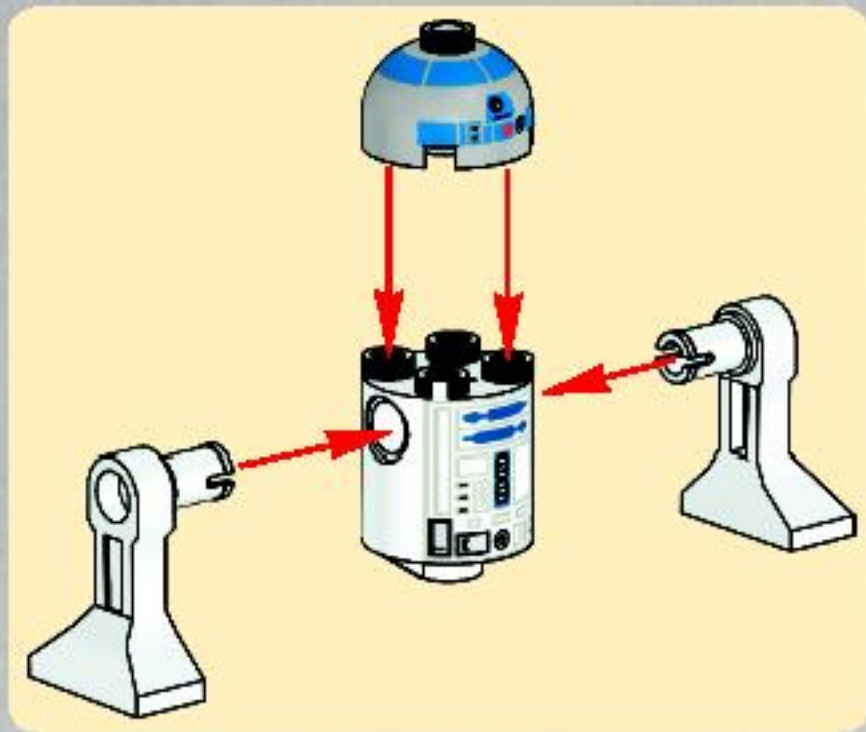



1x



2x



2x



1x



1x



1x

6

1



2



3



4

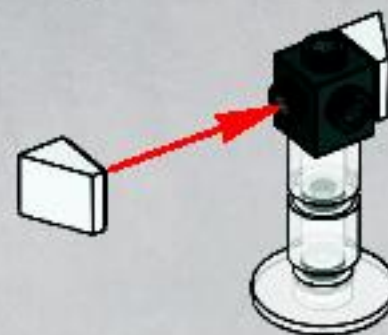

5







1x

1

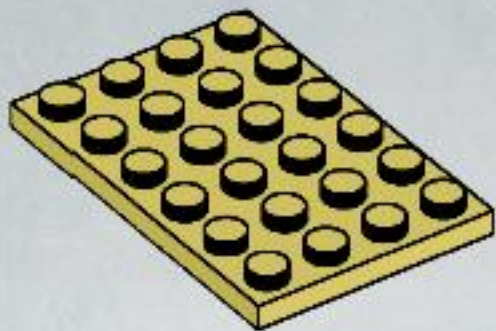

4x

2

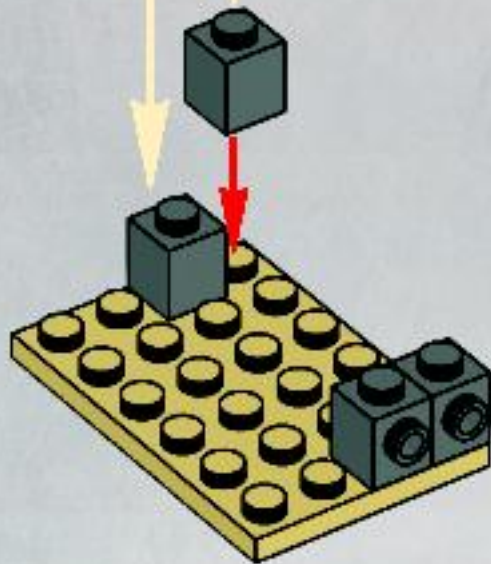



2x

3

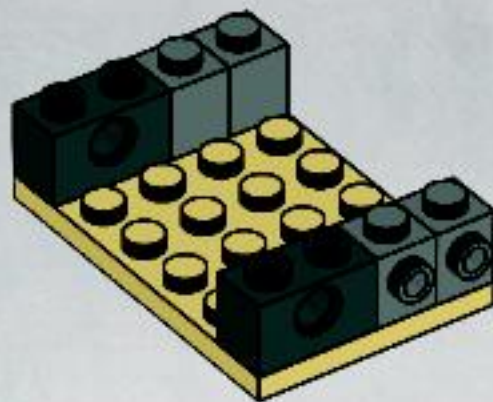

2x

4

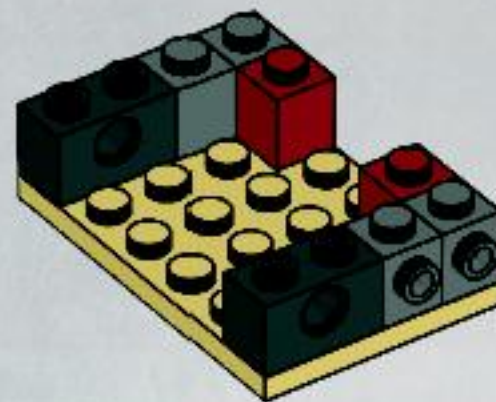

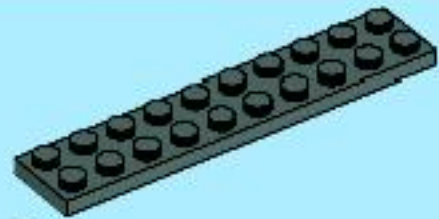

1x

5

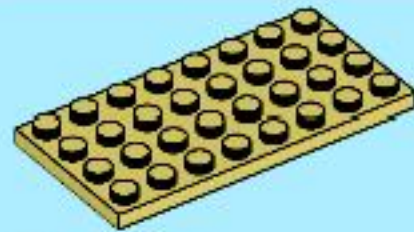
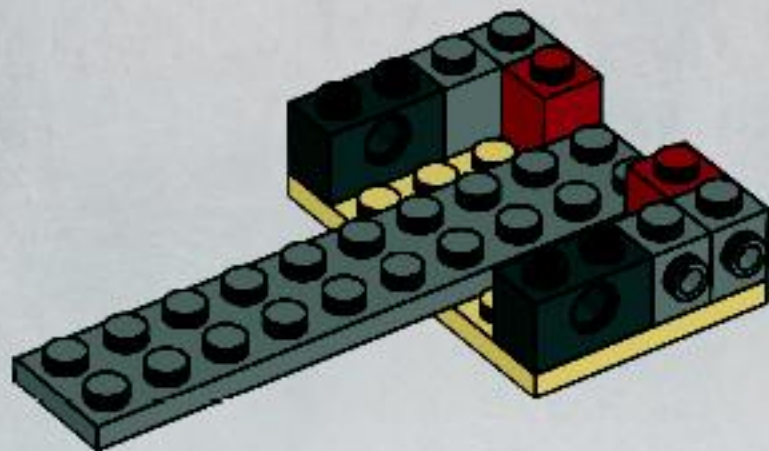

1x

6

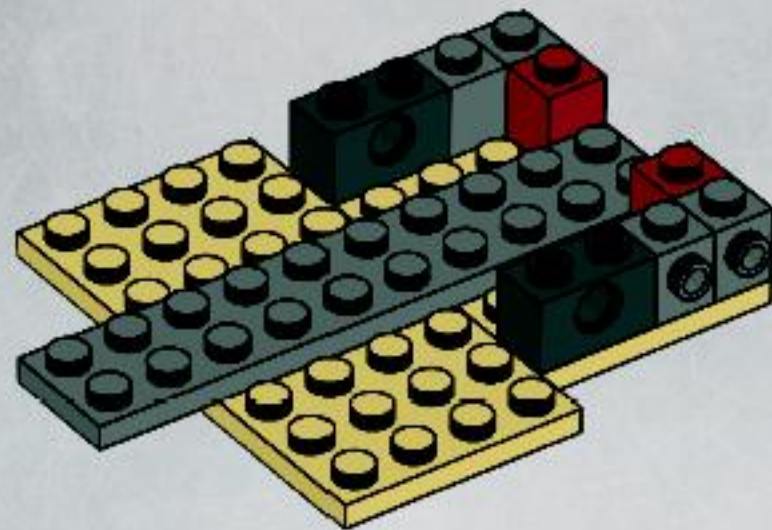



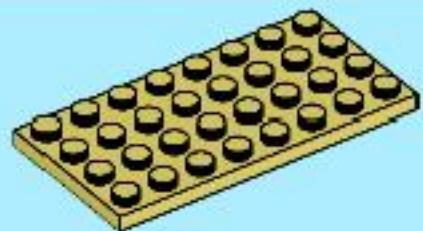

1x

7

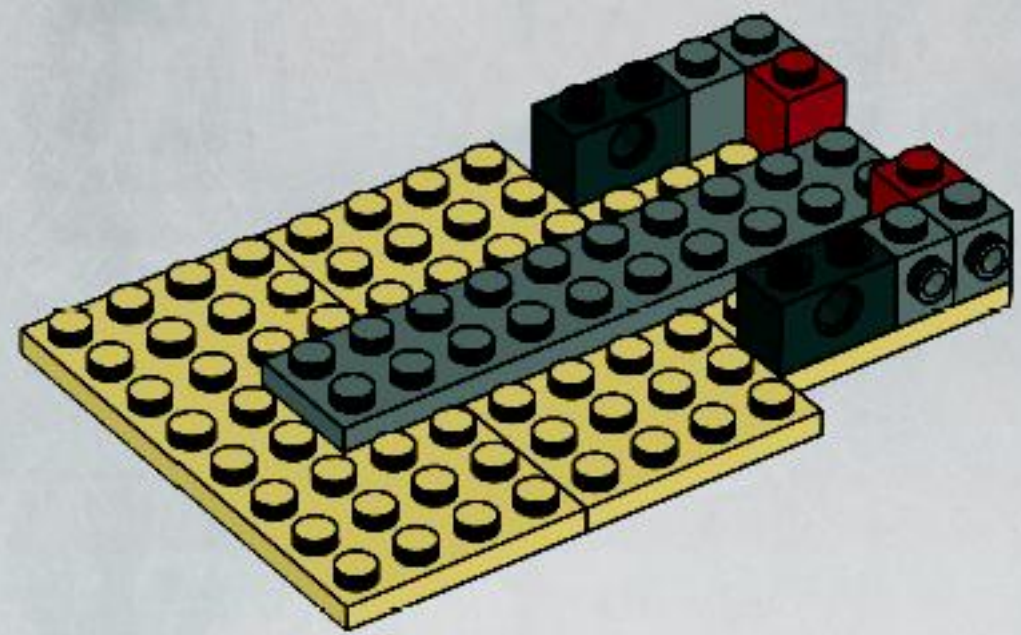

2x

8

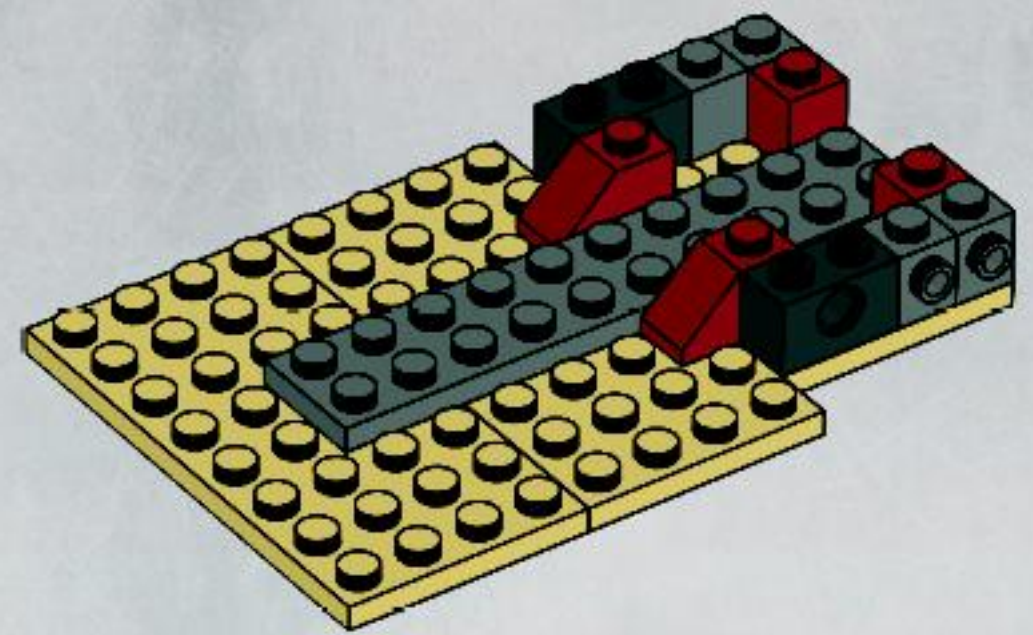



2x



2x

9

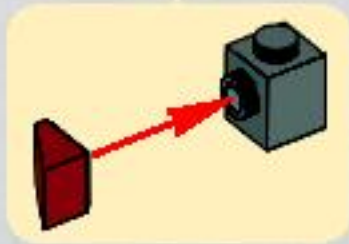
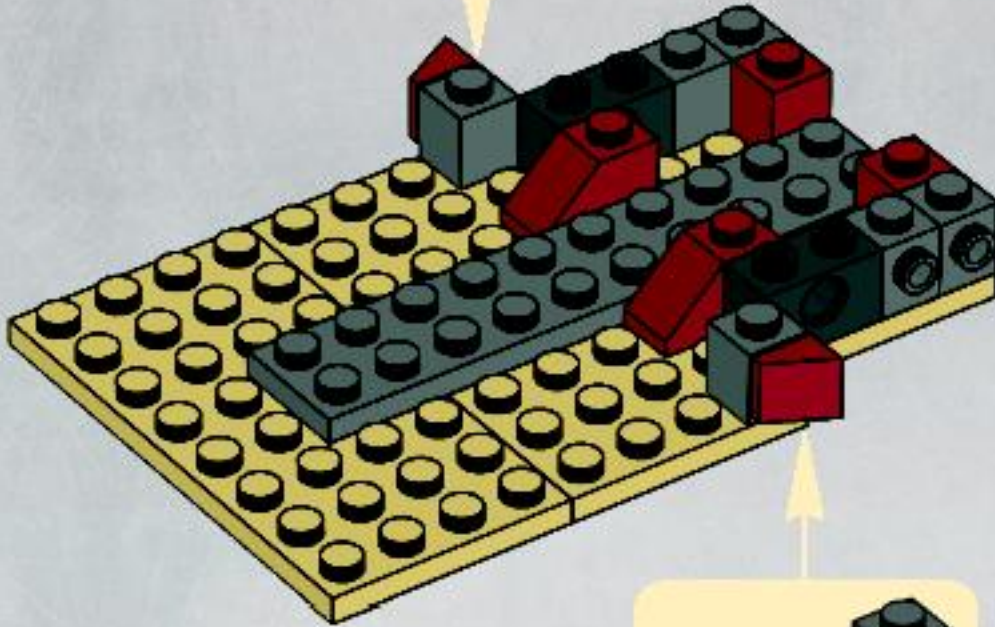
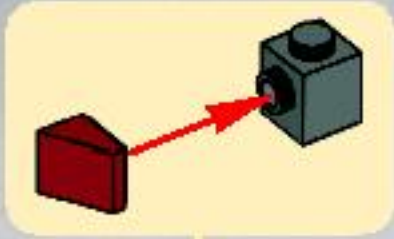

3x



2x

10

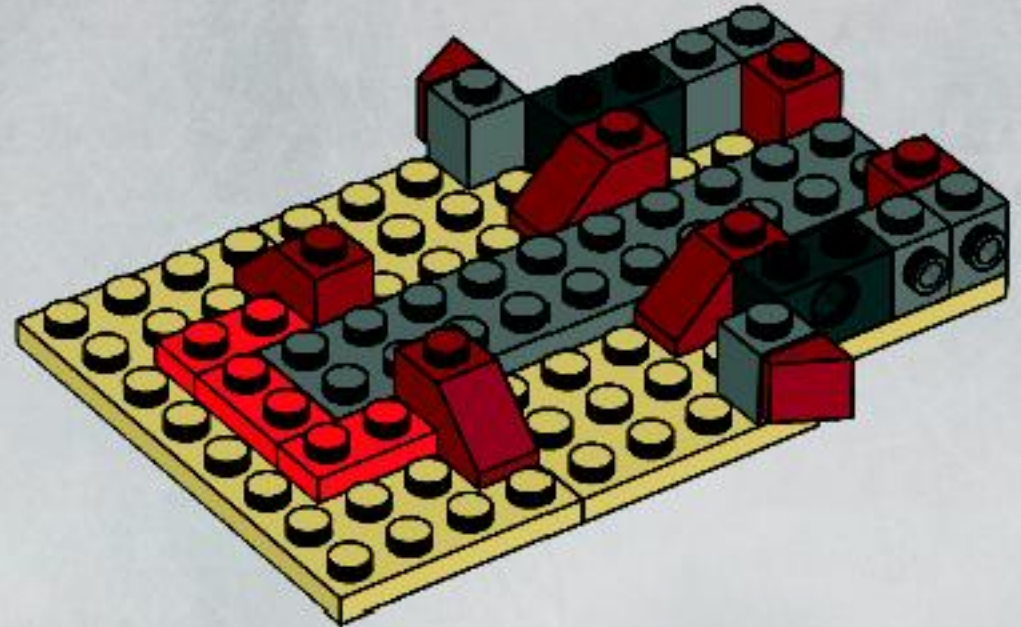





2x

# 11

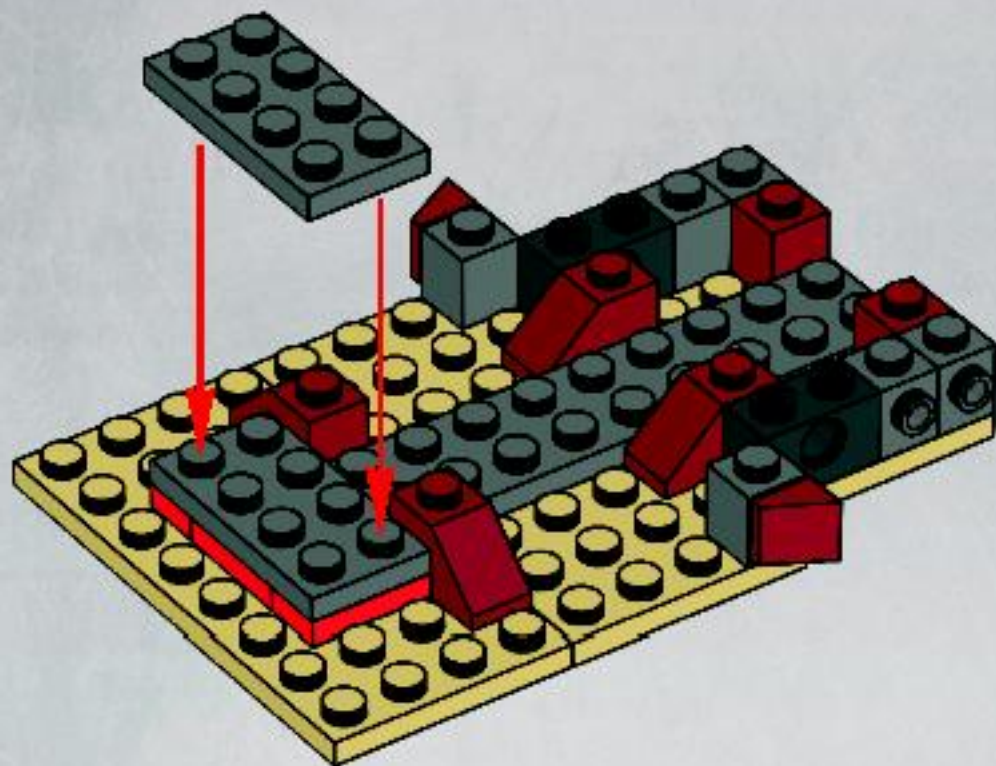

2x

# 12

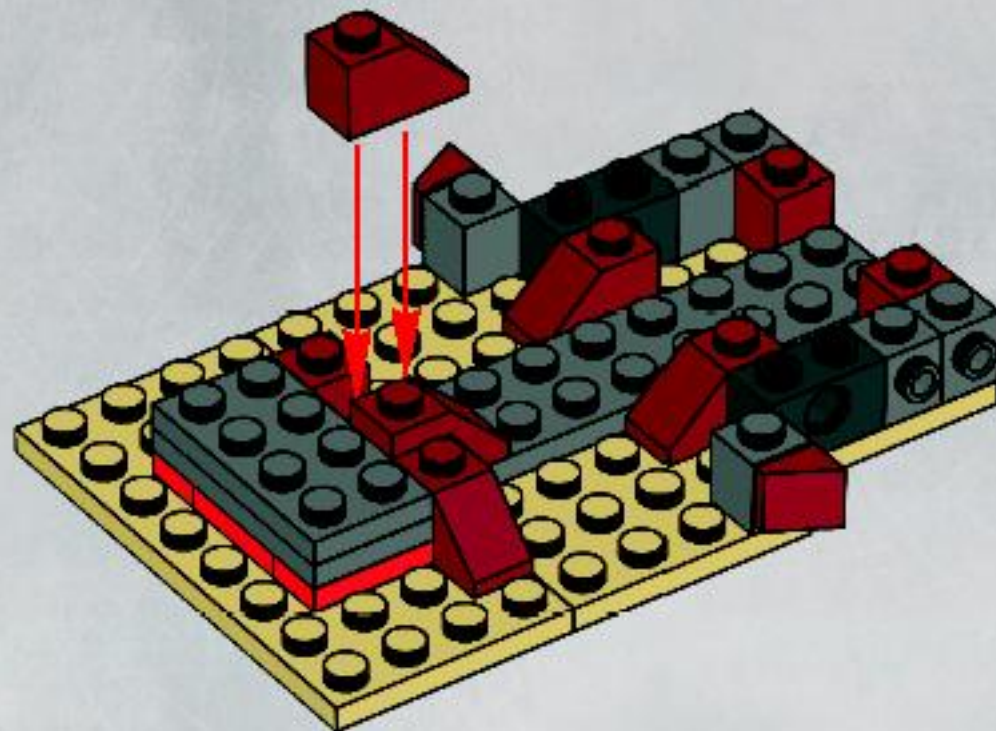



2x



6x

# 13

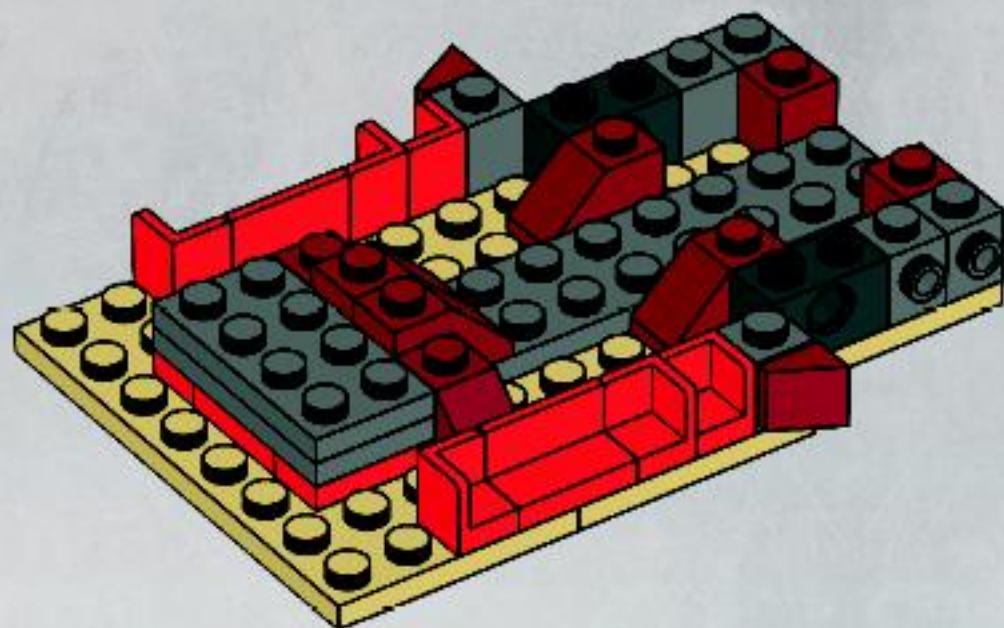



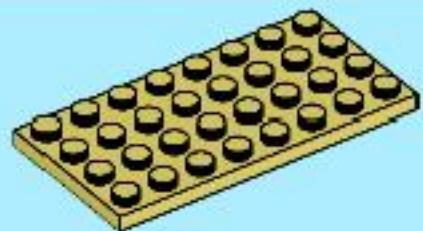

1x

14

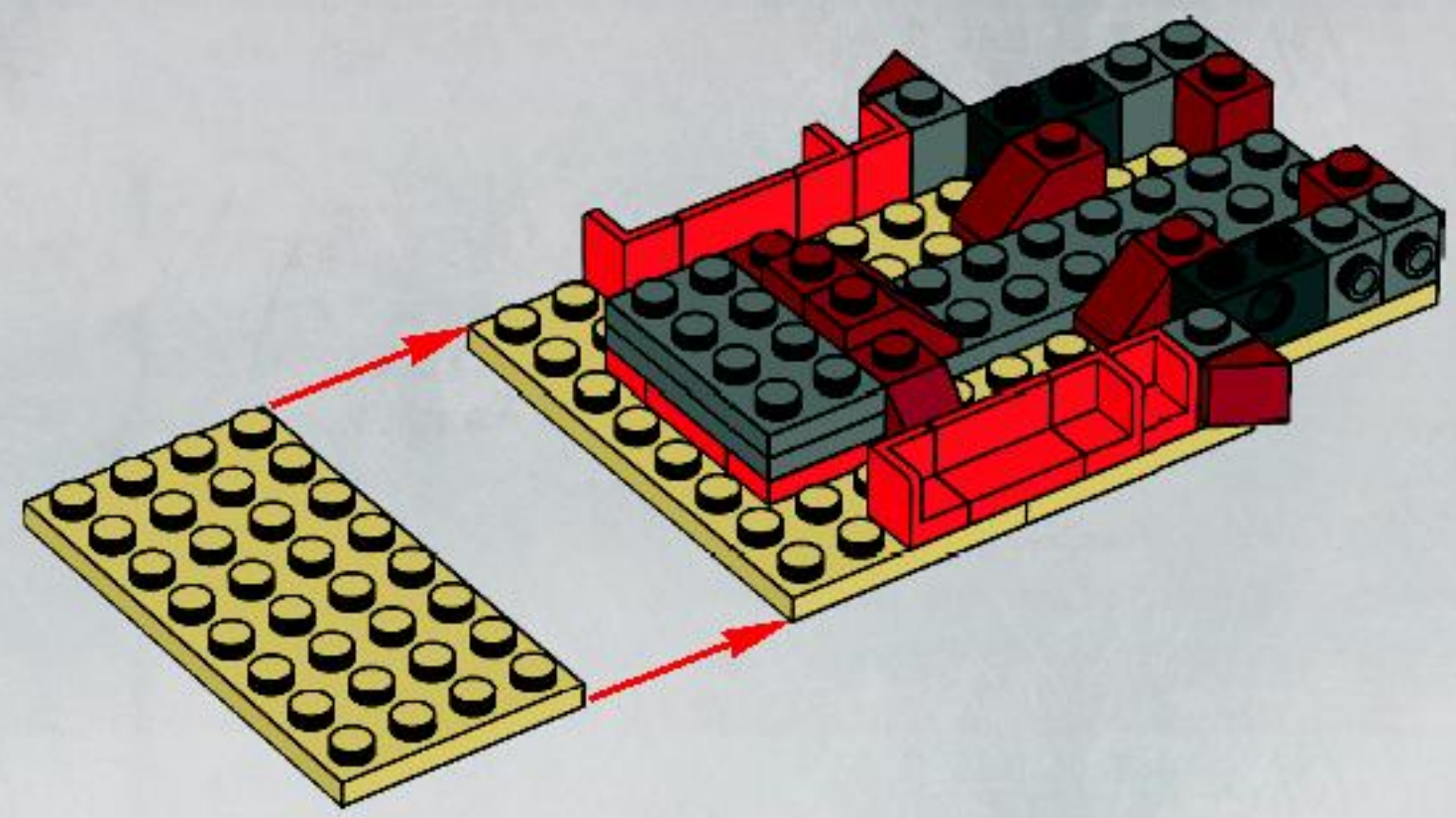



1x



2x

# 15

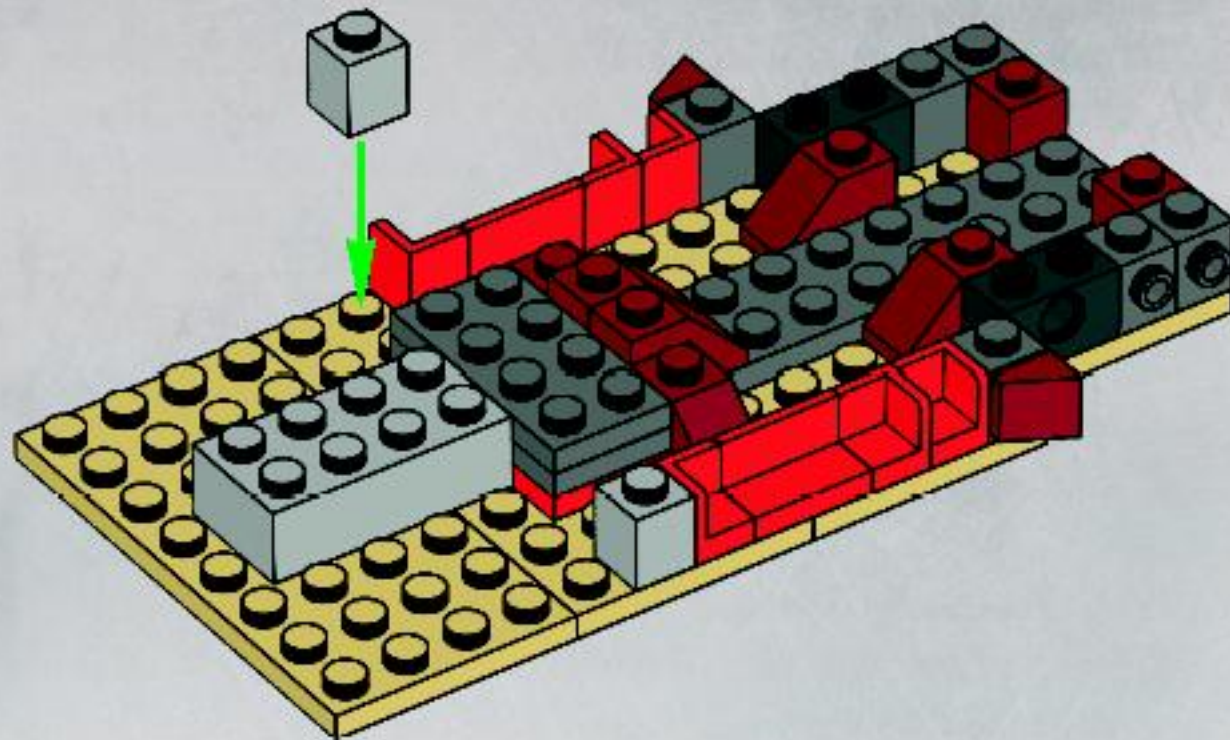





2x

16

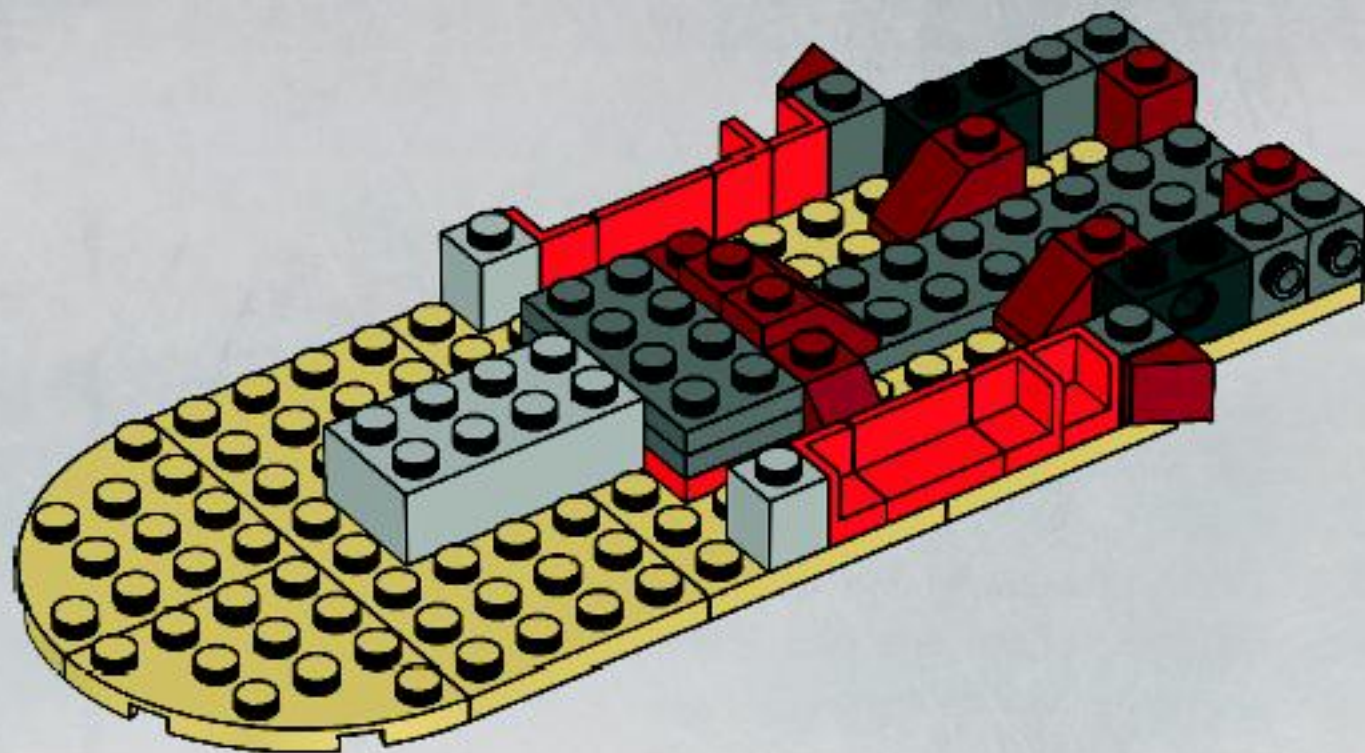

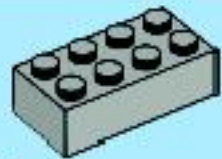

1x

17

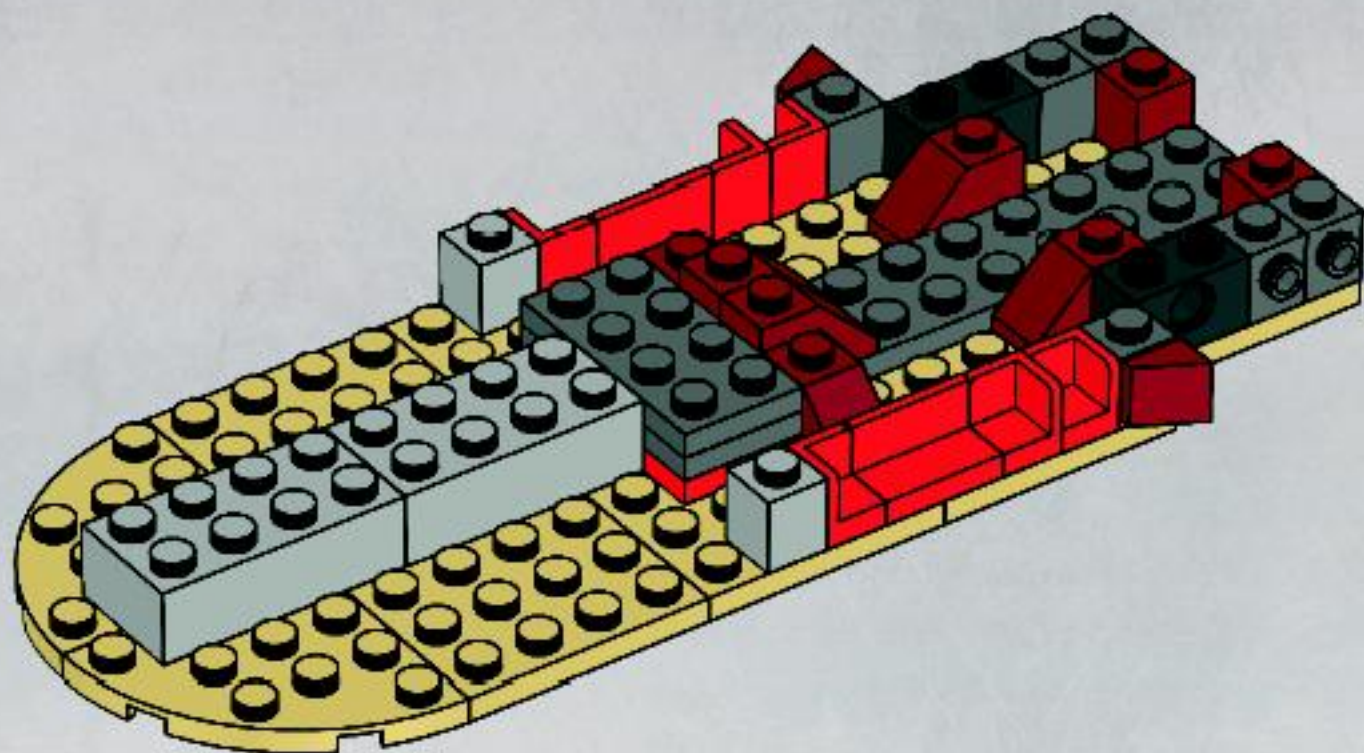





3x

18

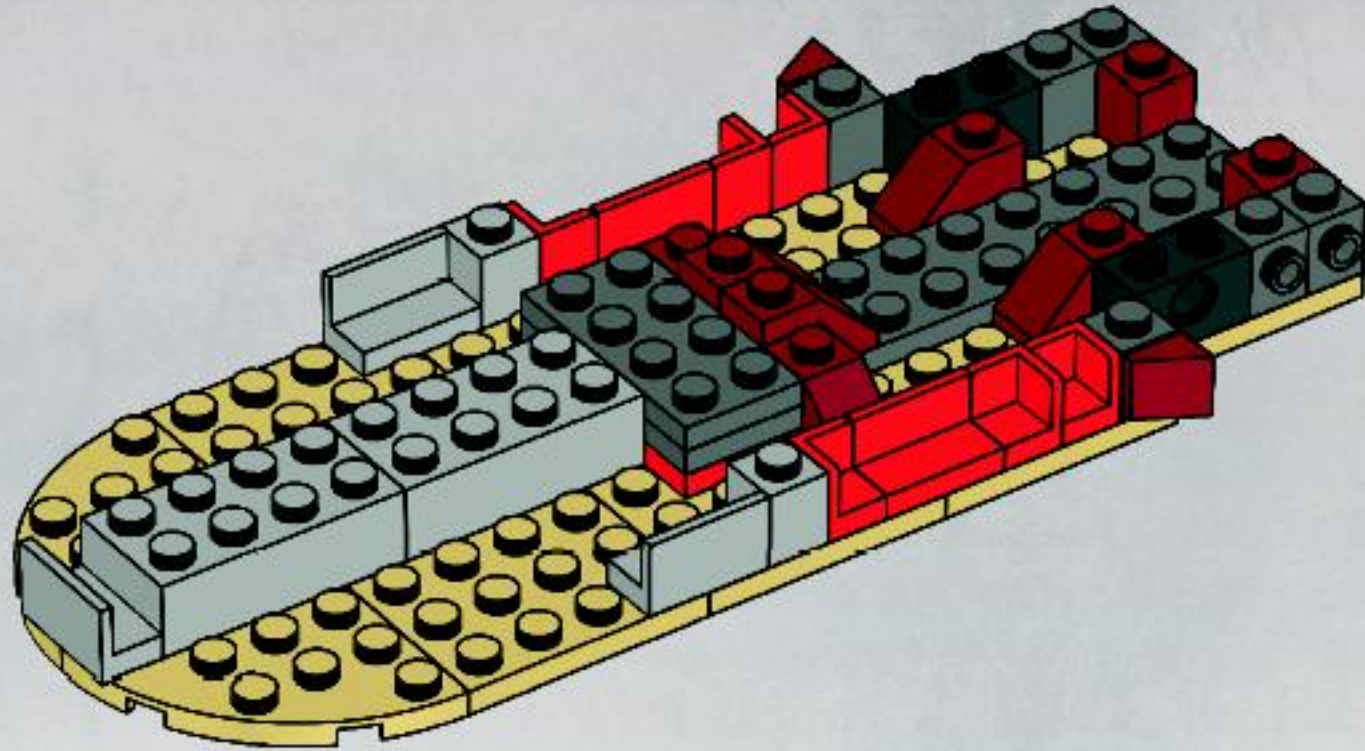



2x



2x

19

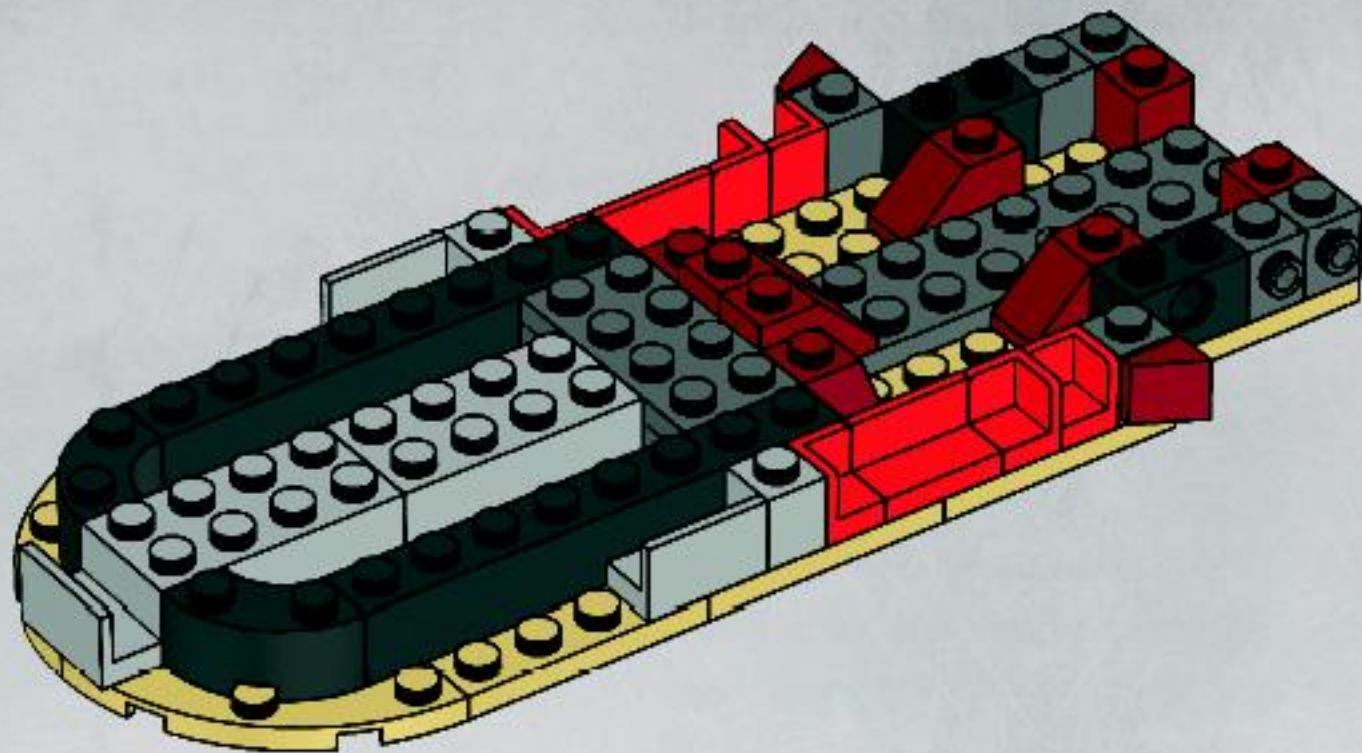





2x



2x

20

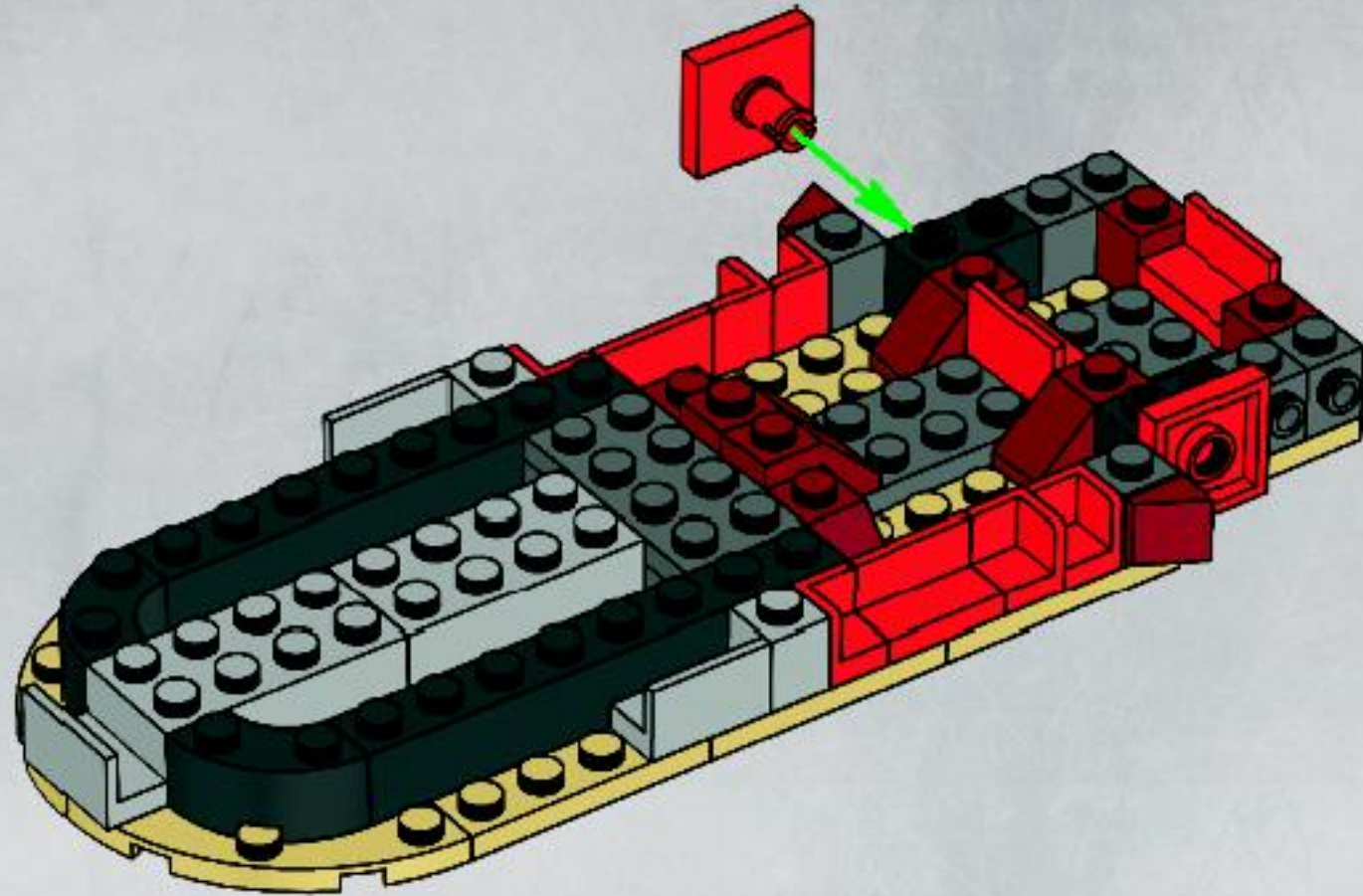



2x



2x

21

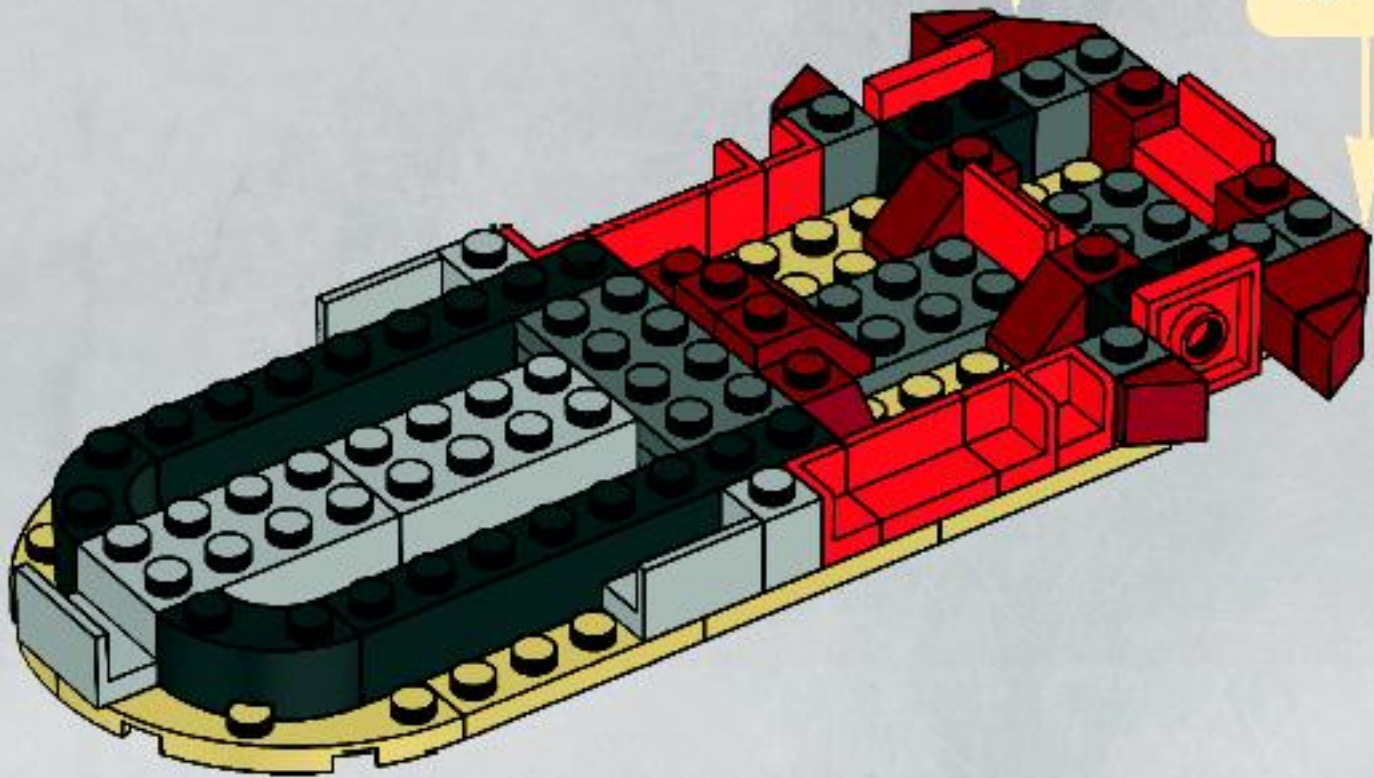
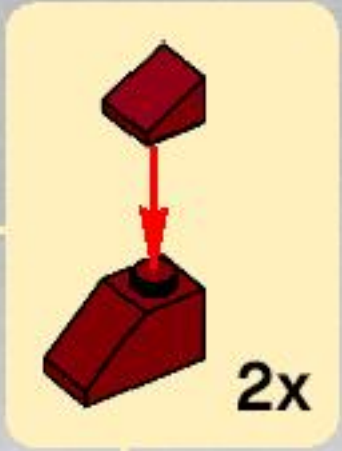





2x



2x

# 22

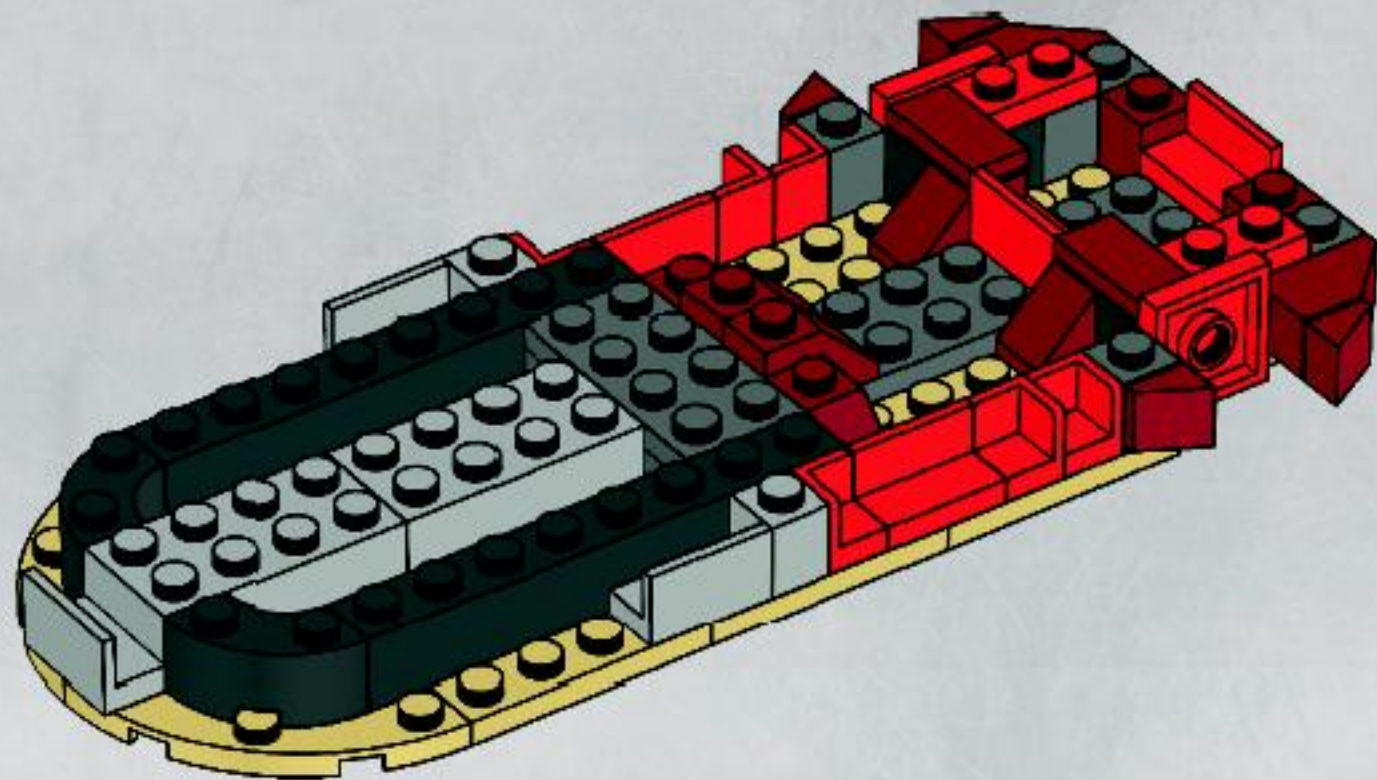



2x

23

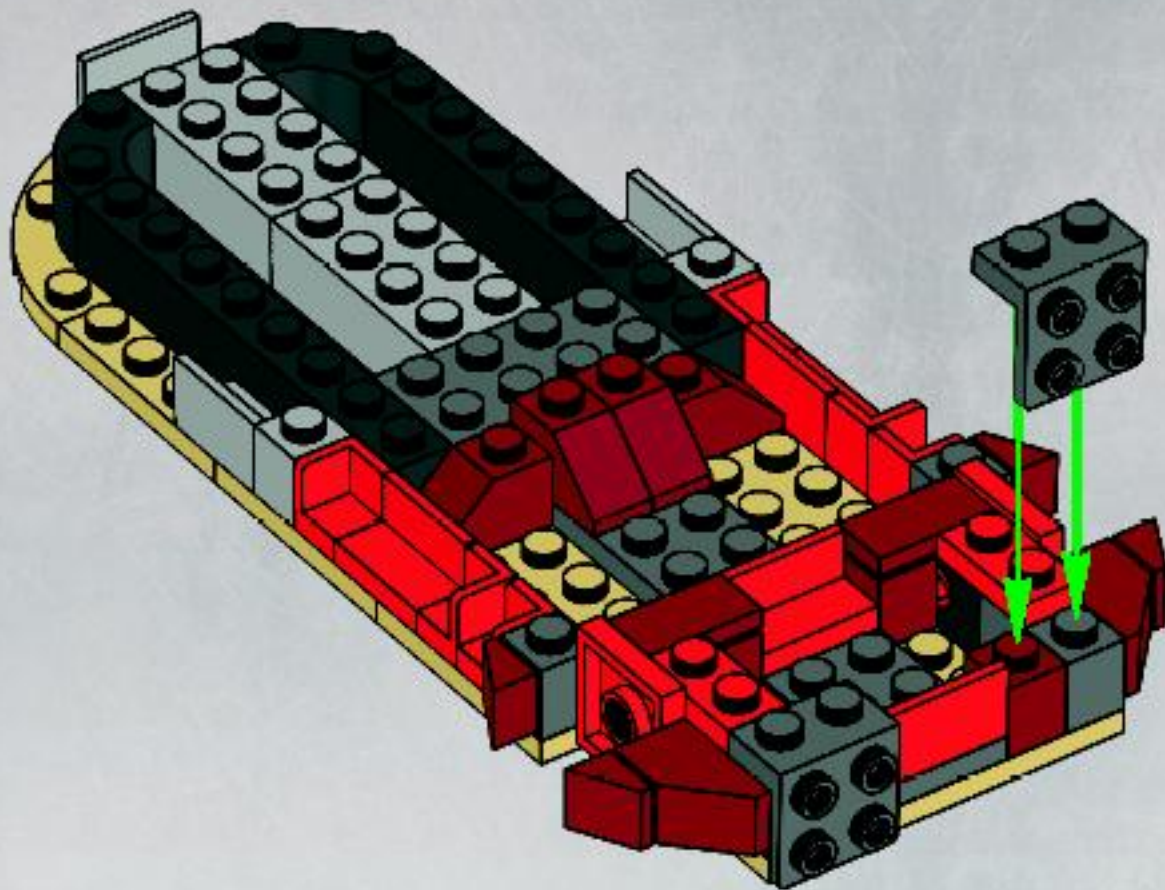





4x

24

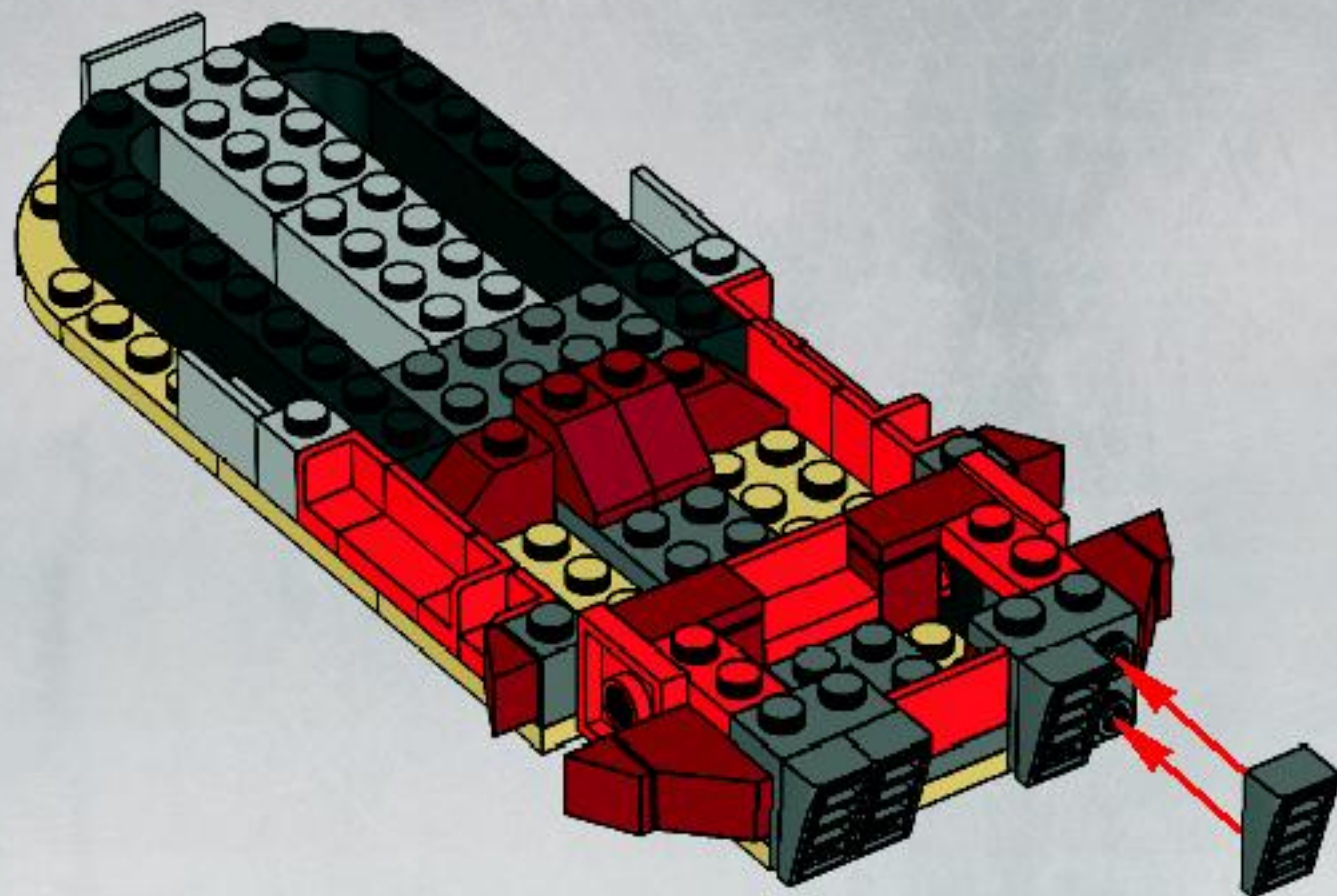

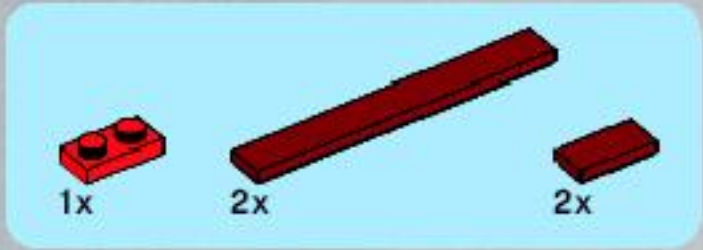

25

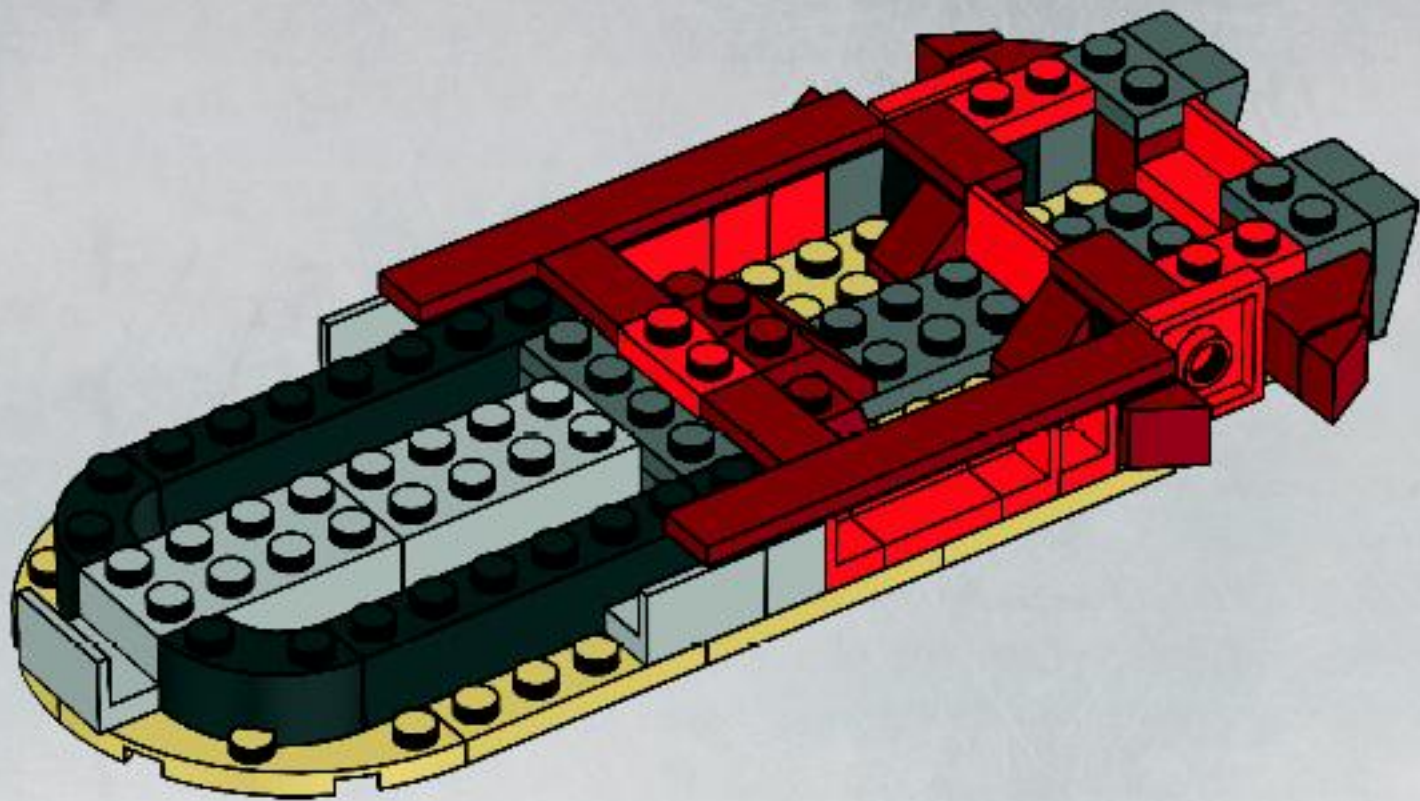





1x



1x



1x

# 26

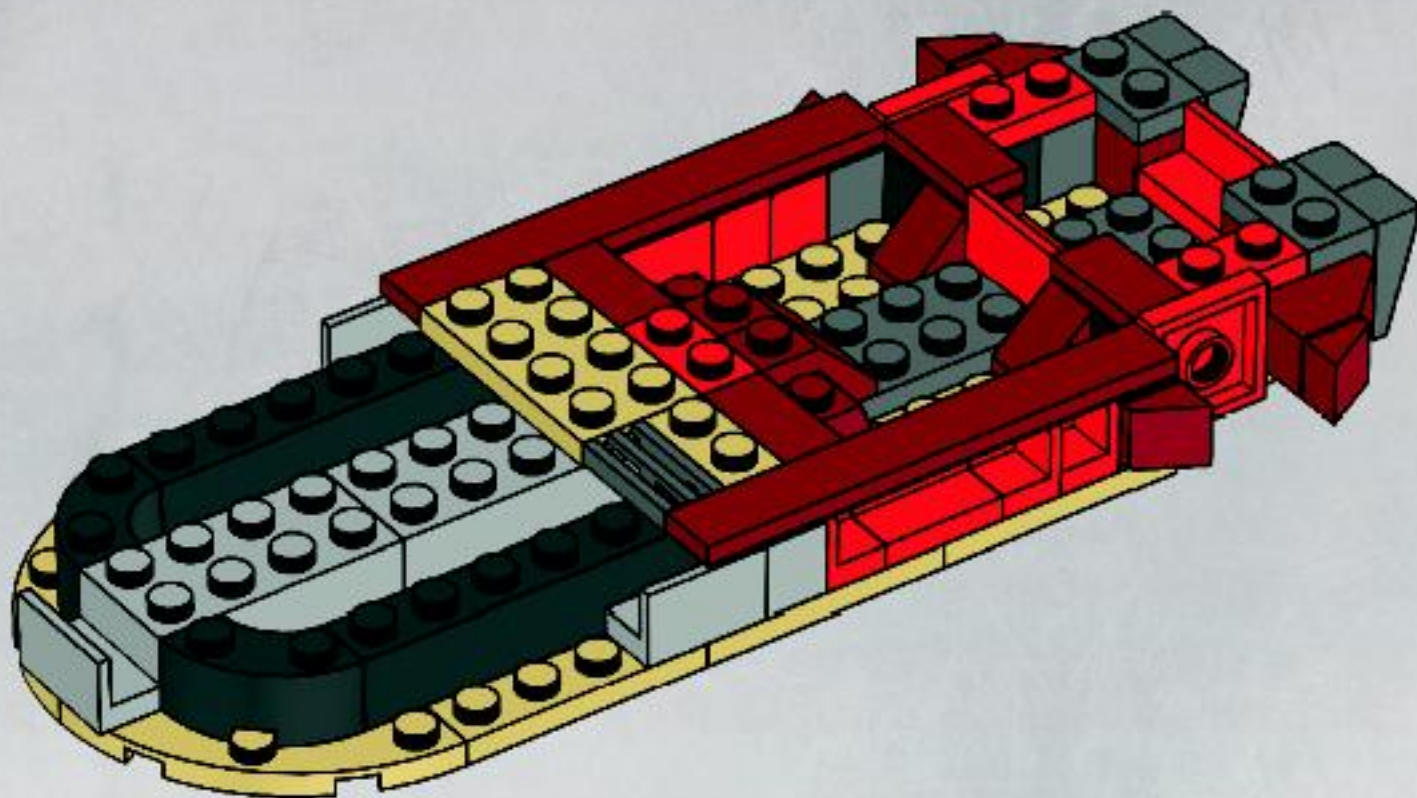



27

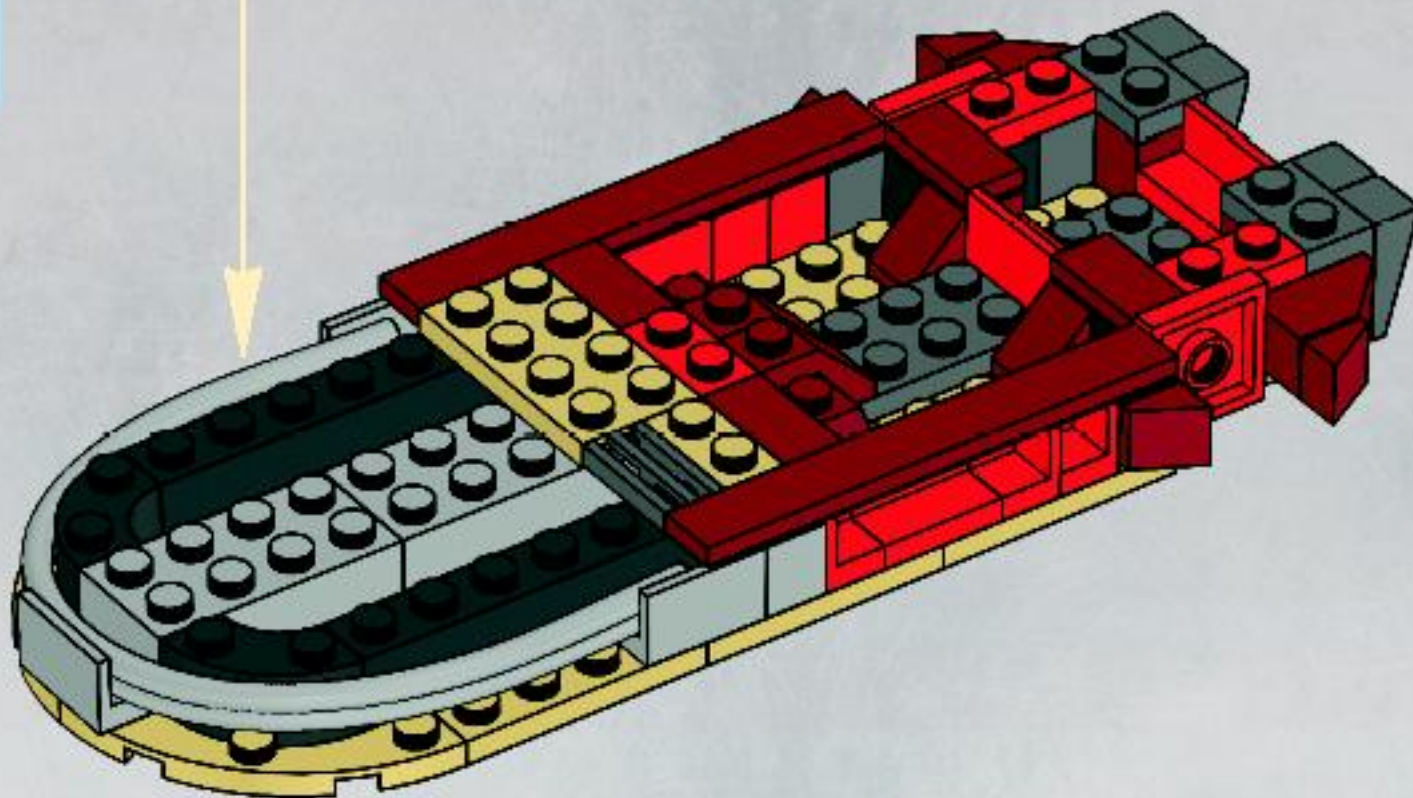
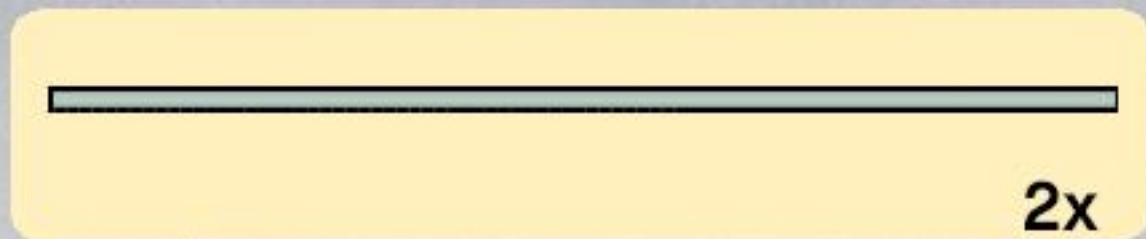



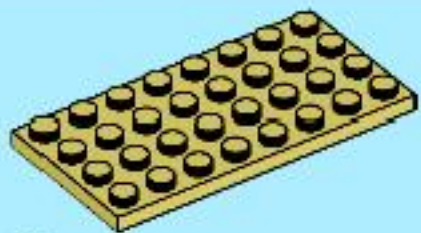

1x

28

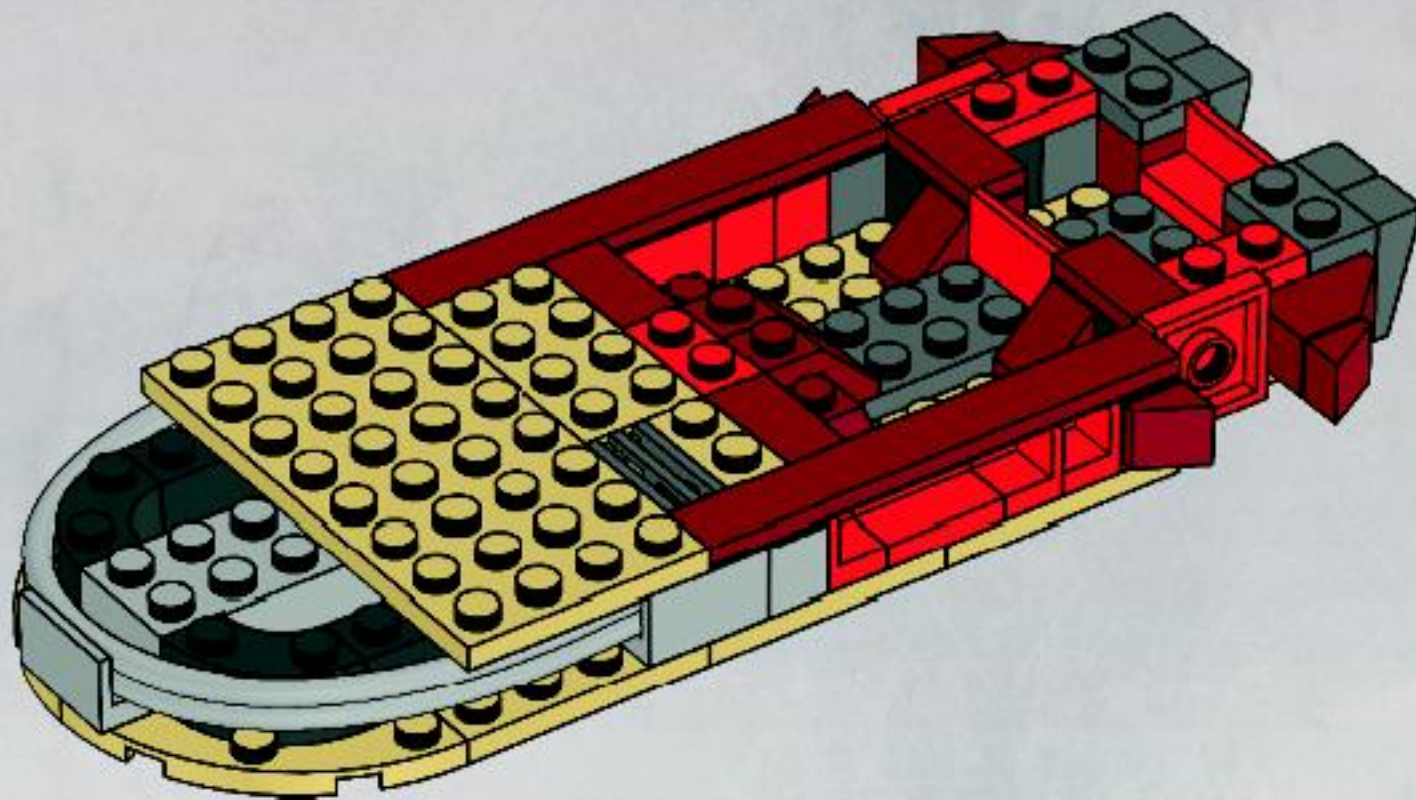



2x

29

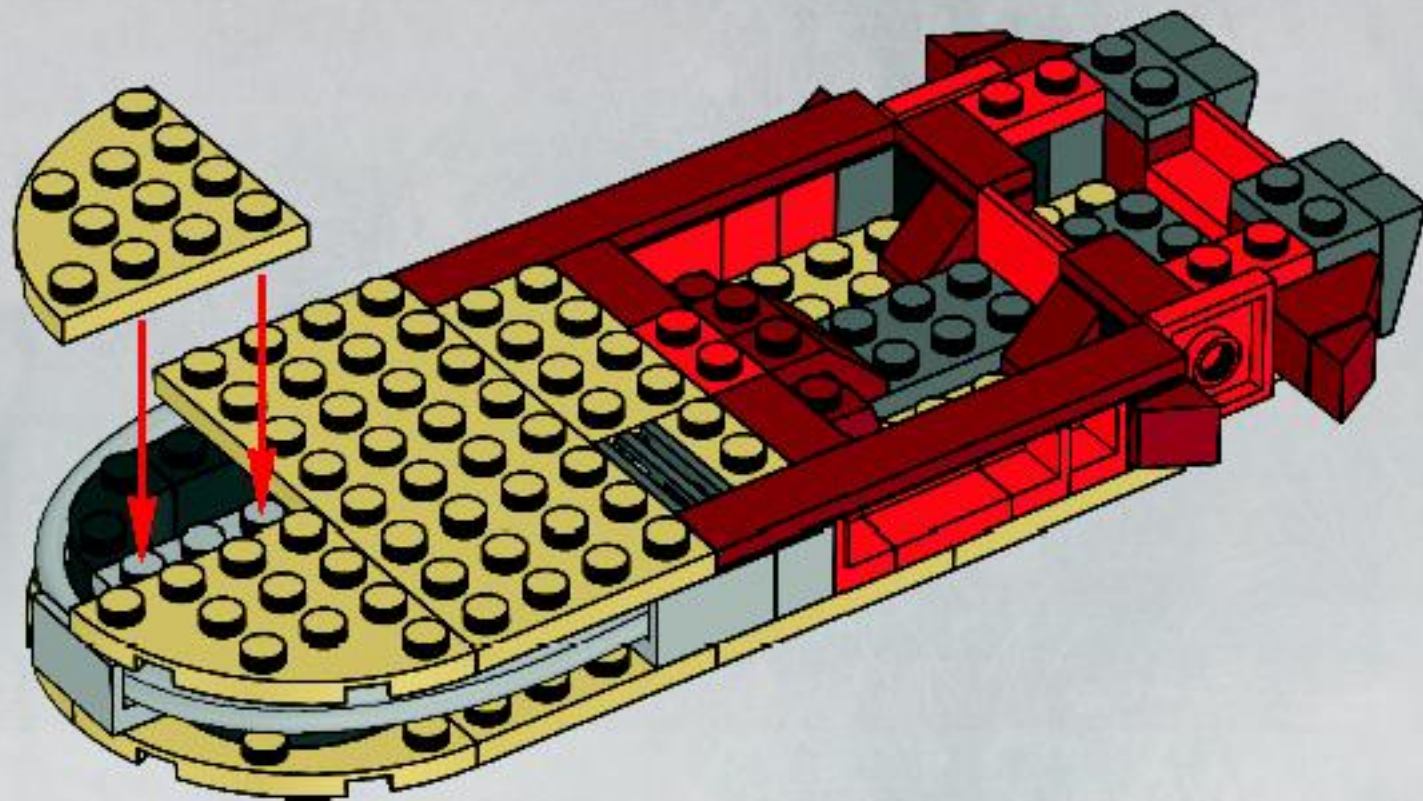





7x

30

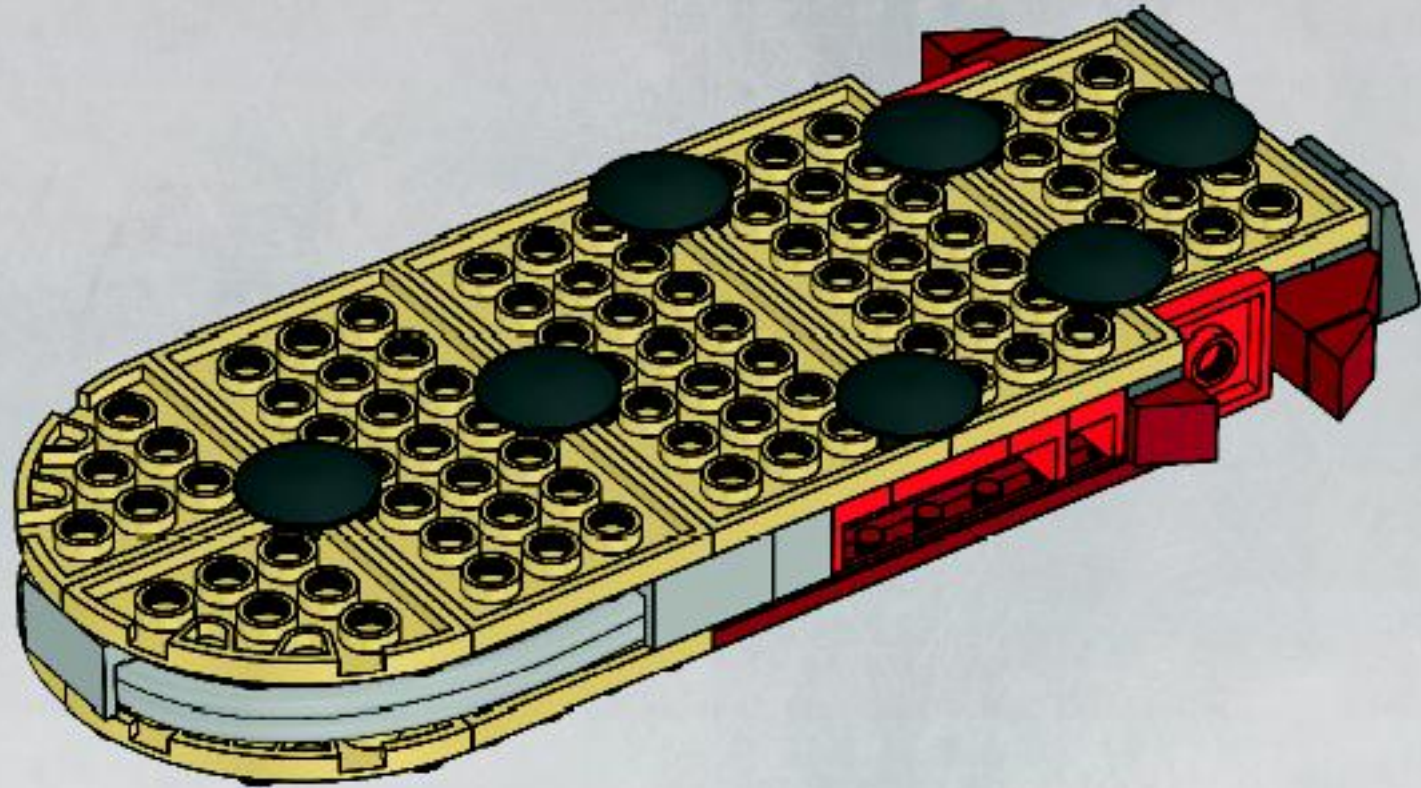



1x



5x

# 31

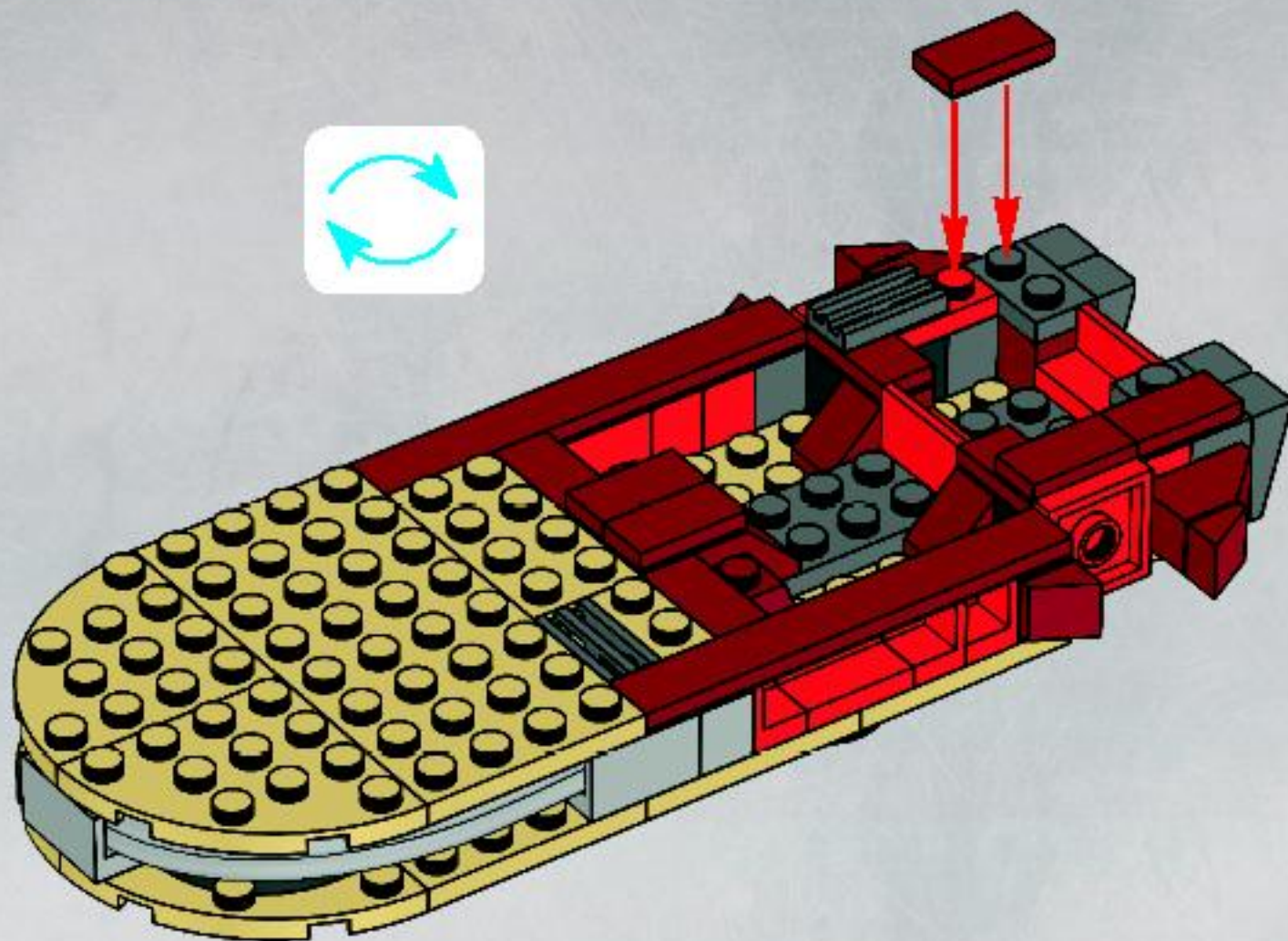





2x

32

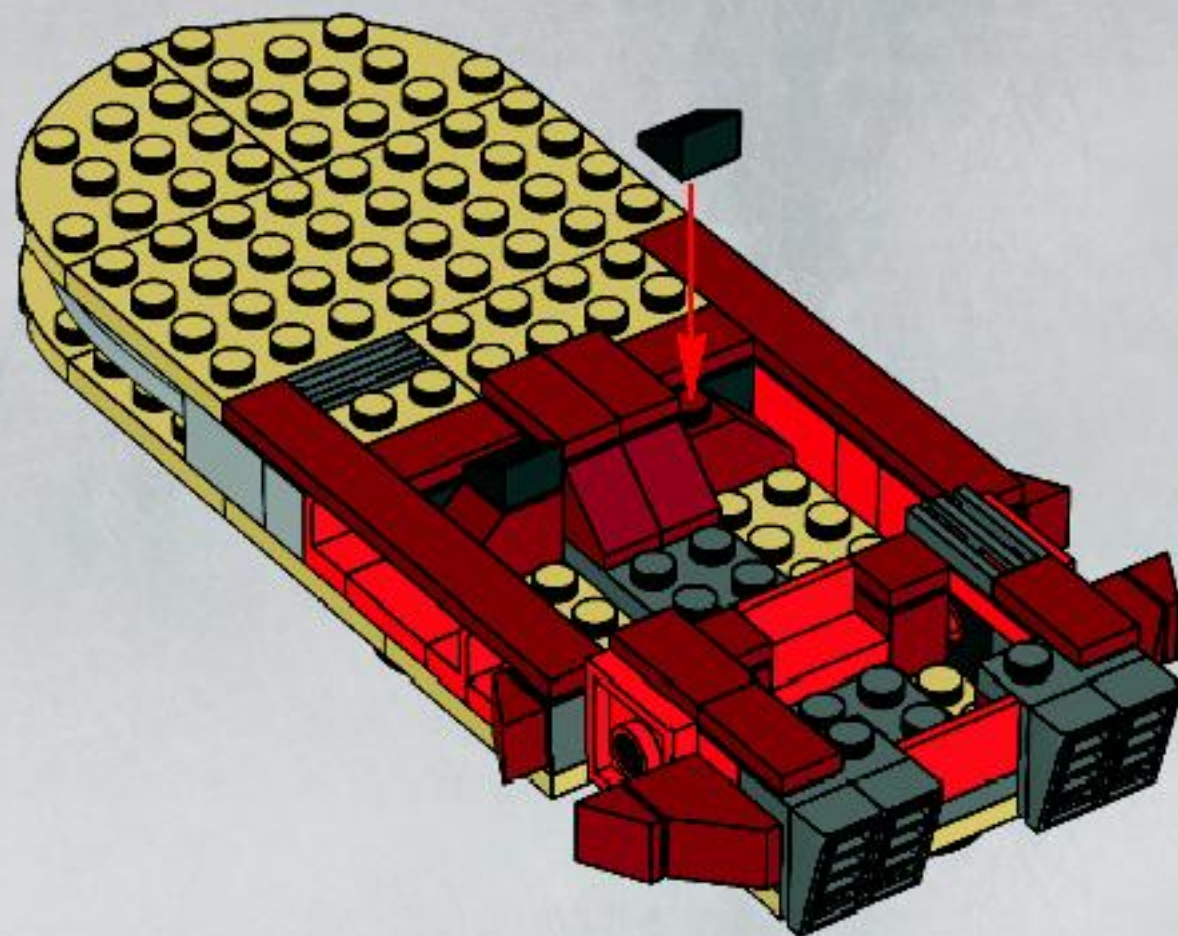



1x

33

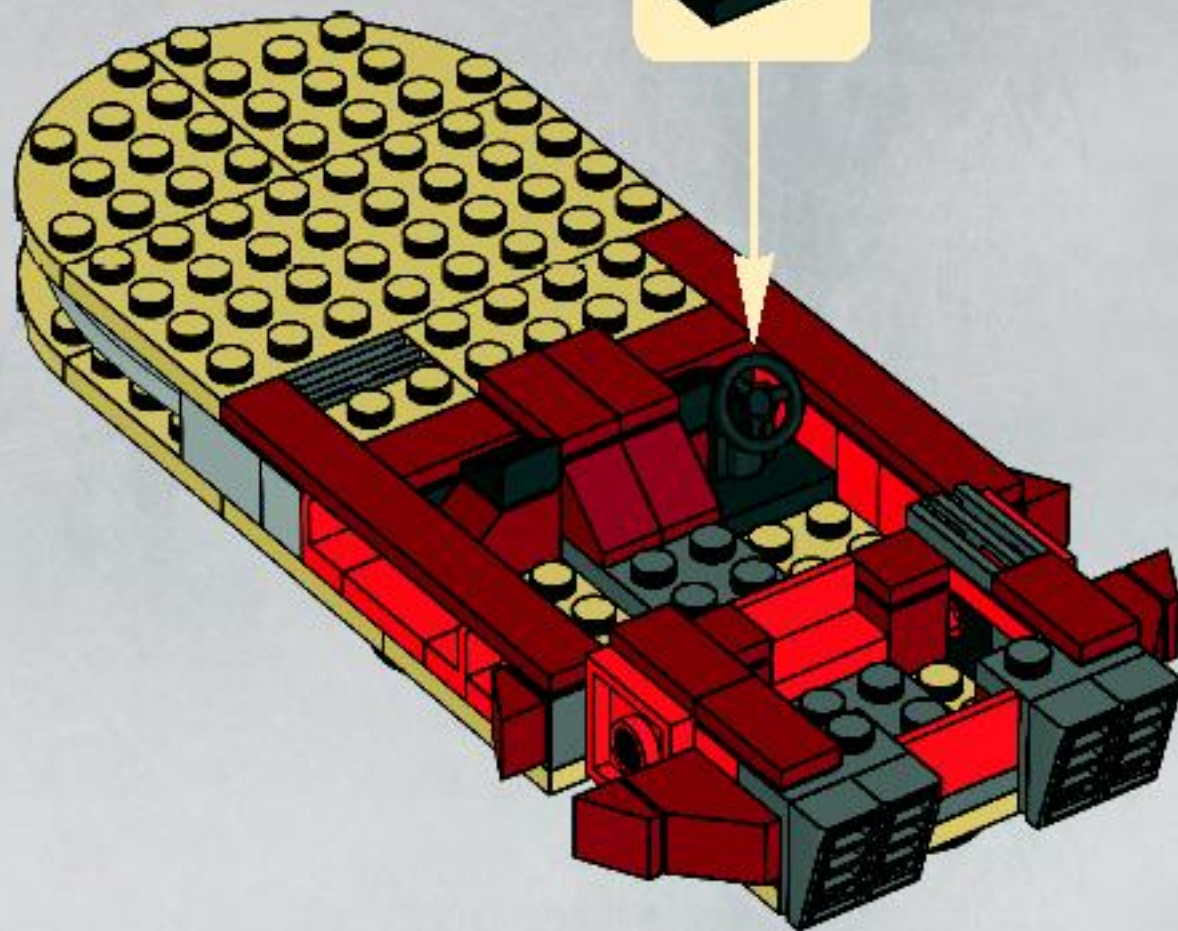





2x

34

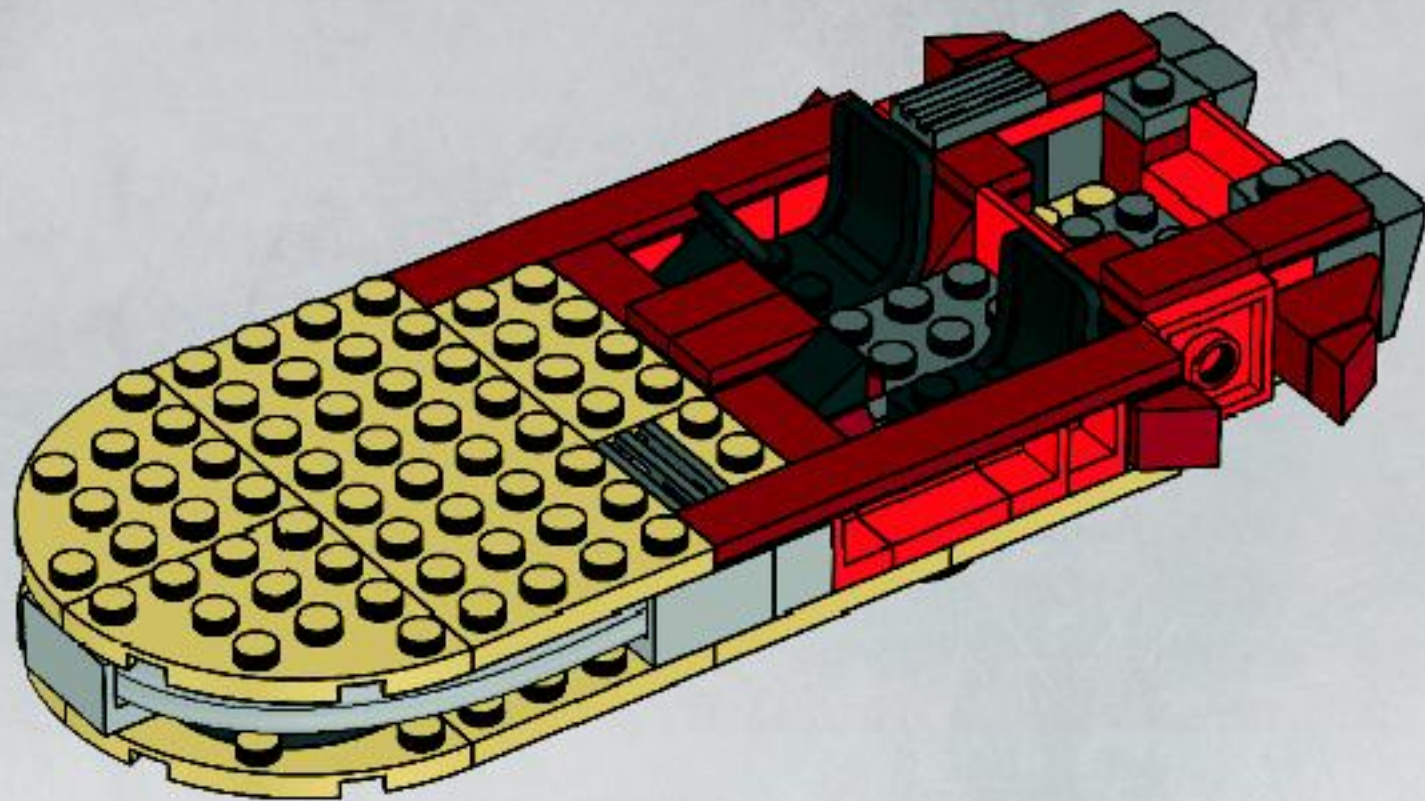



2x



1x

# 35

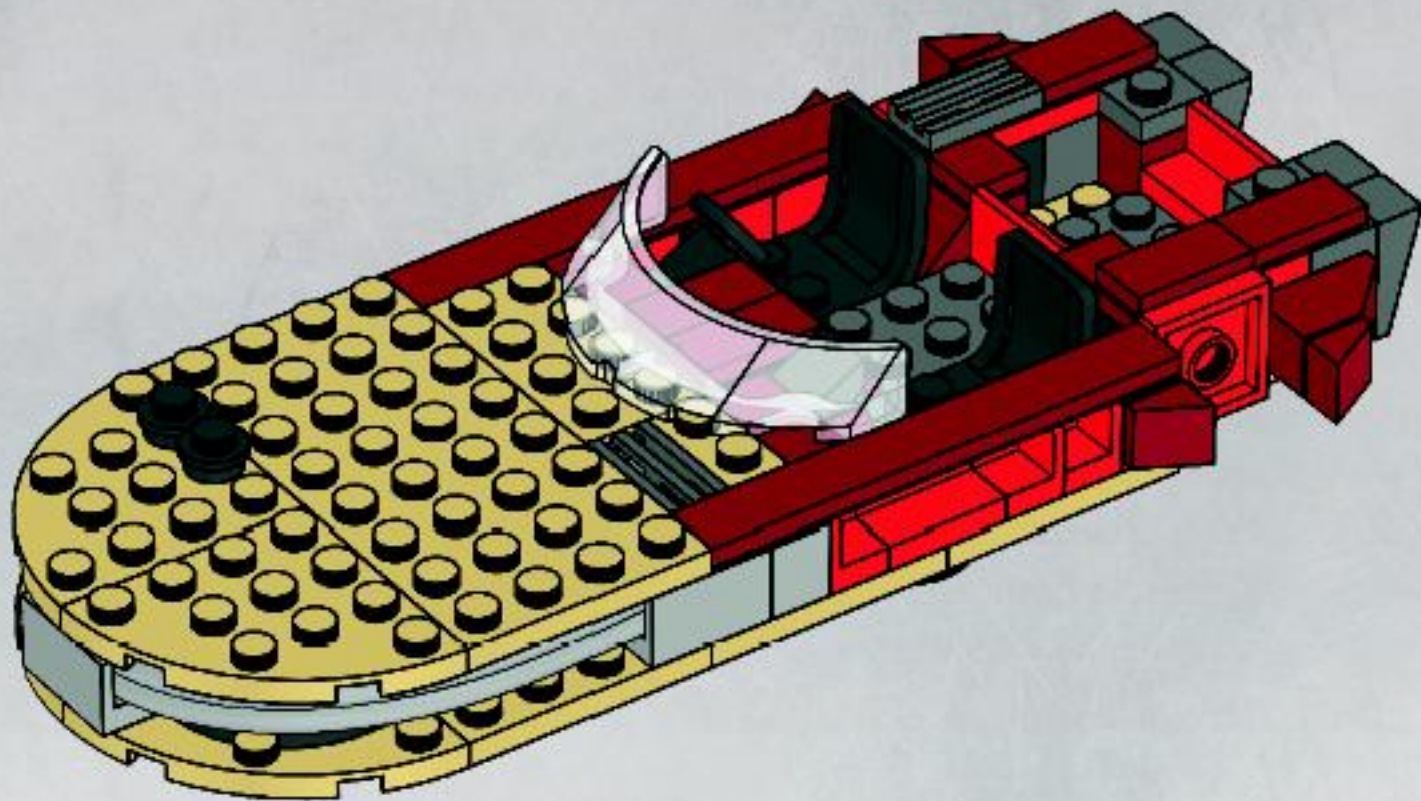





5x

36

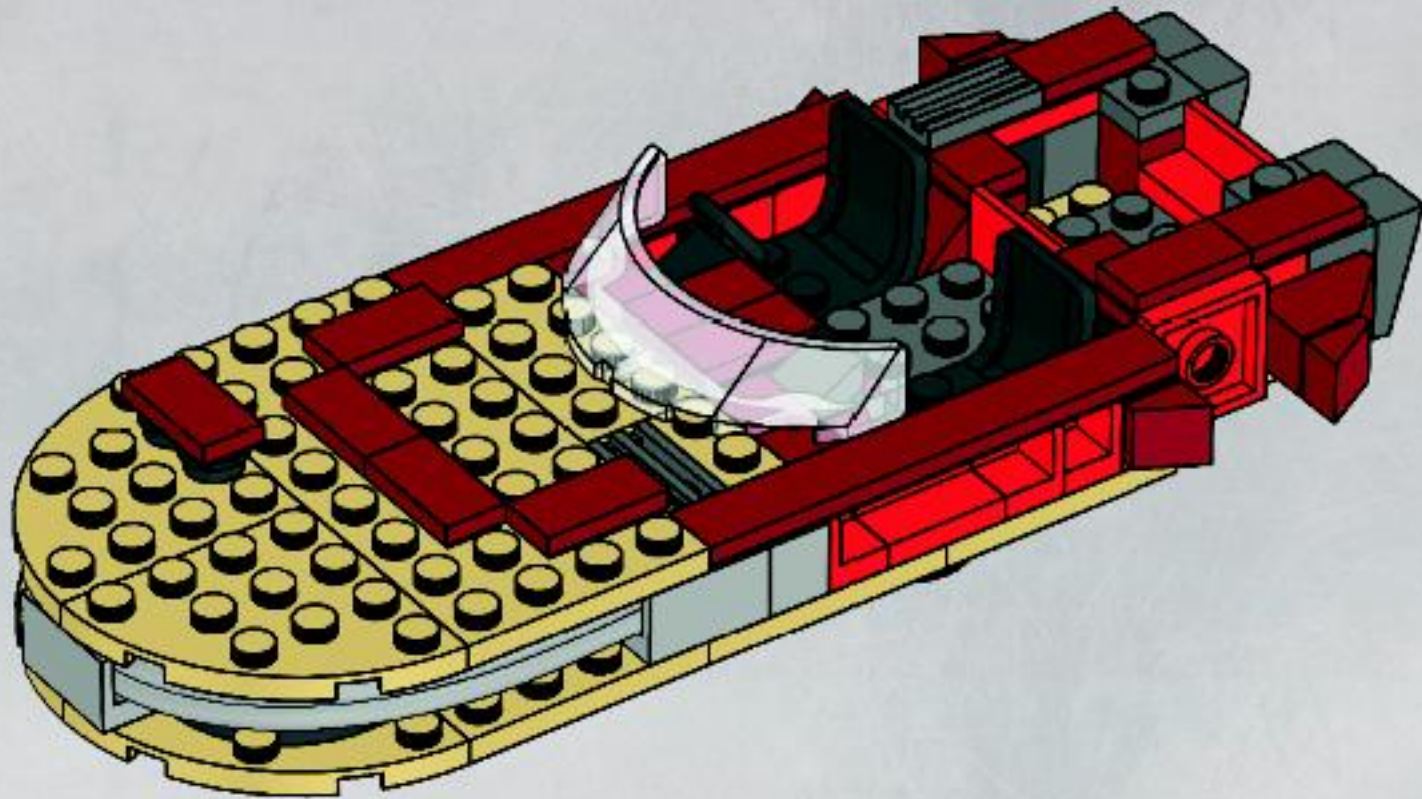



1x



1x

37

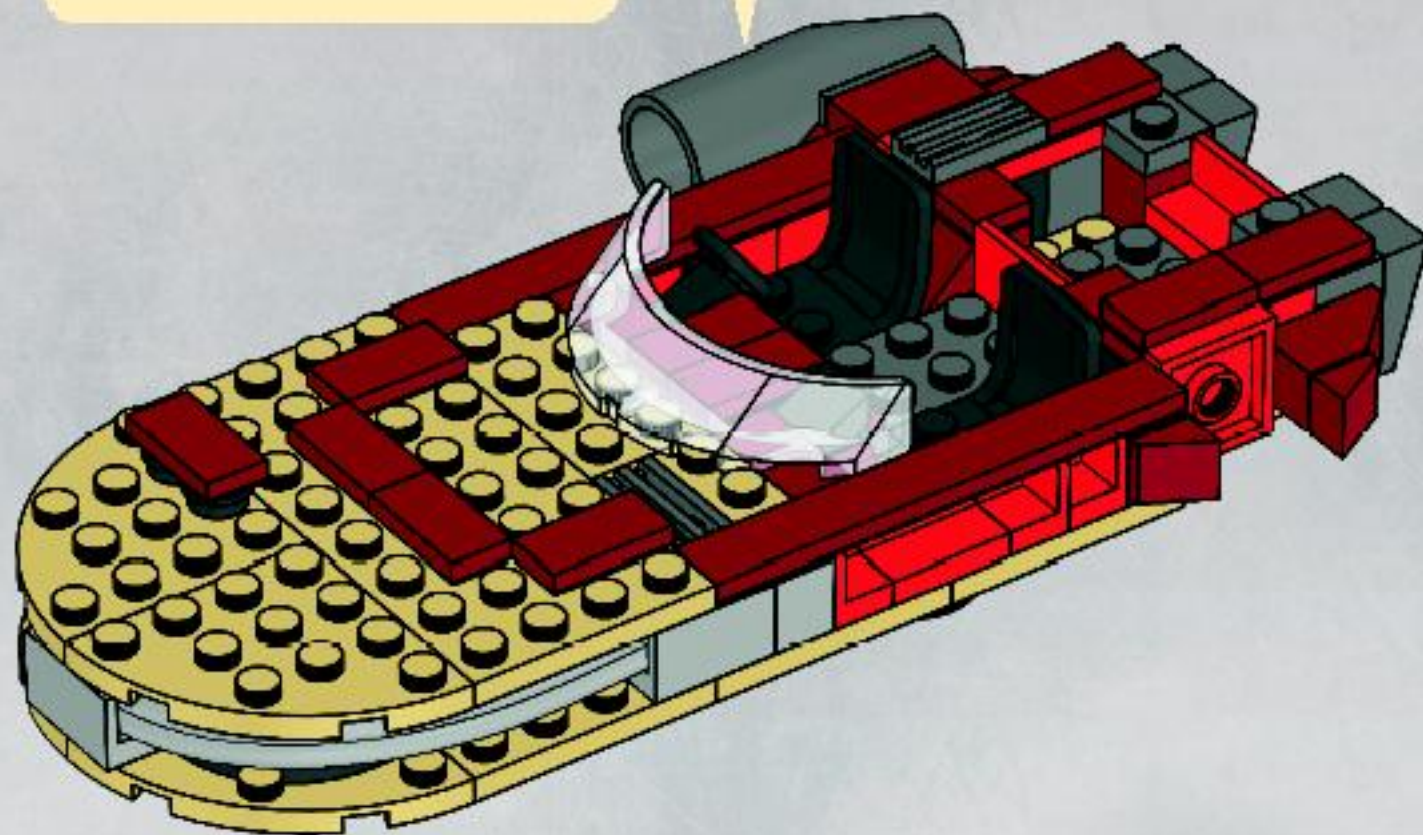
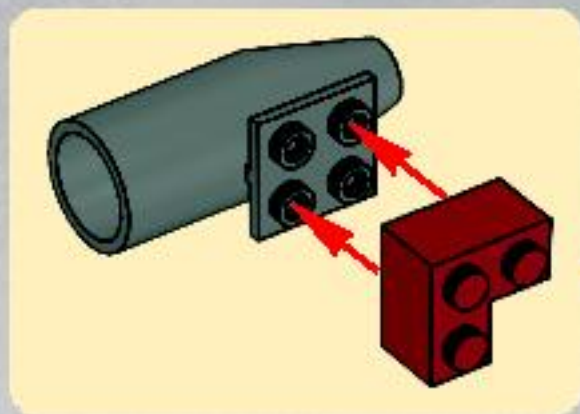





38

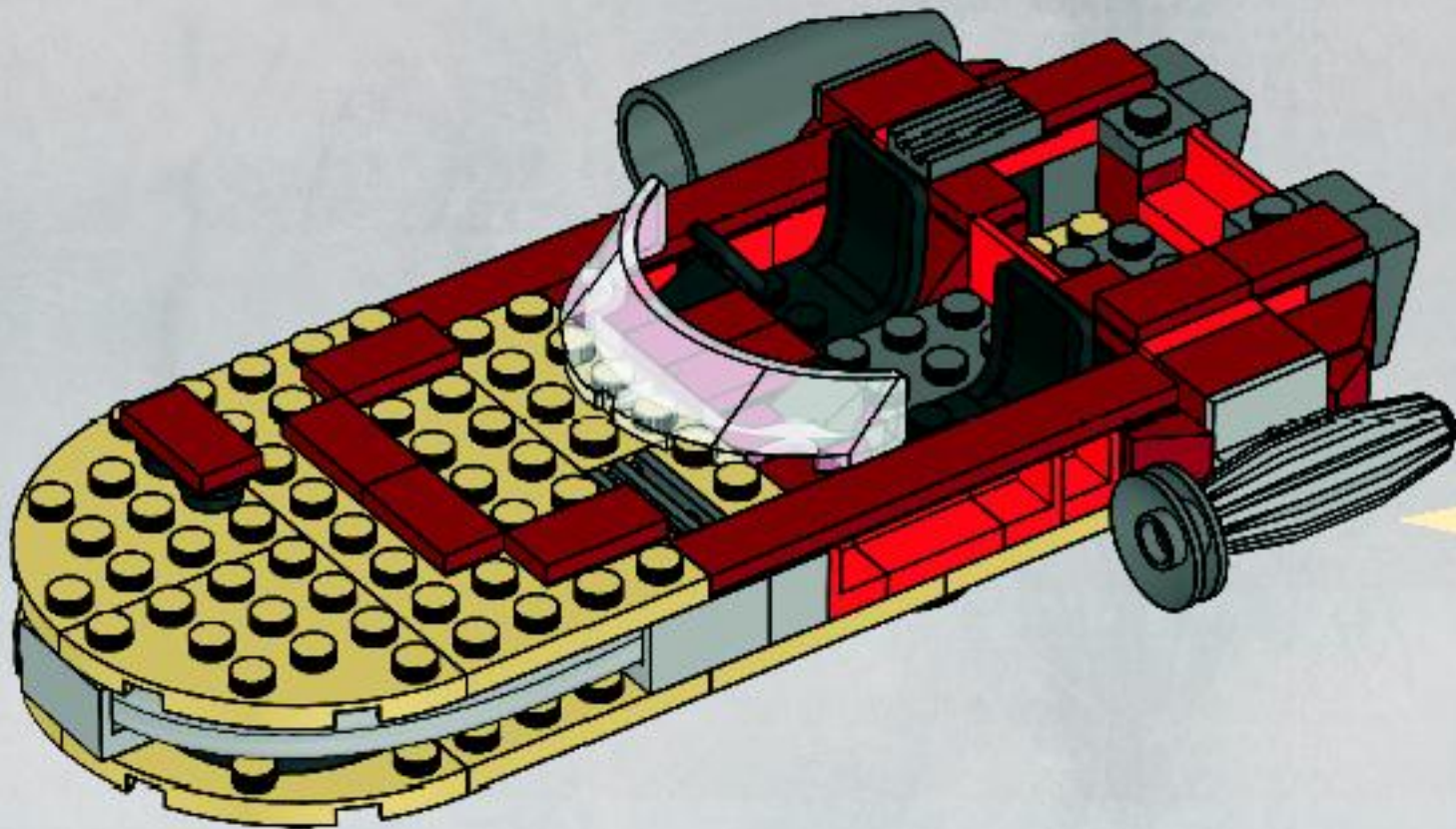
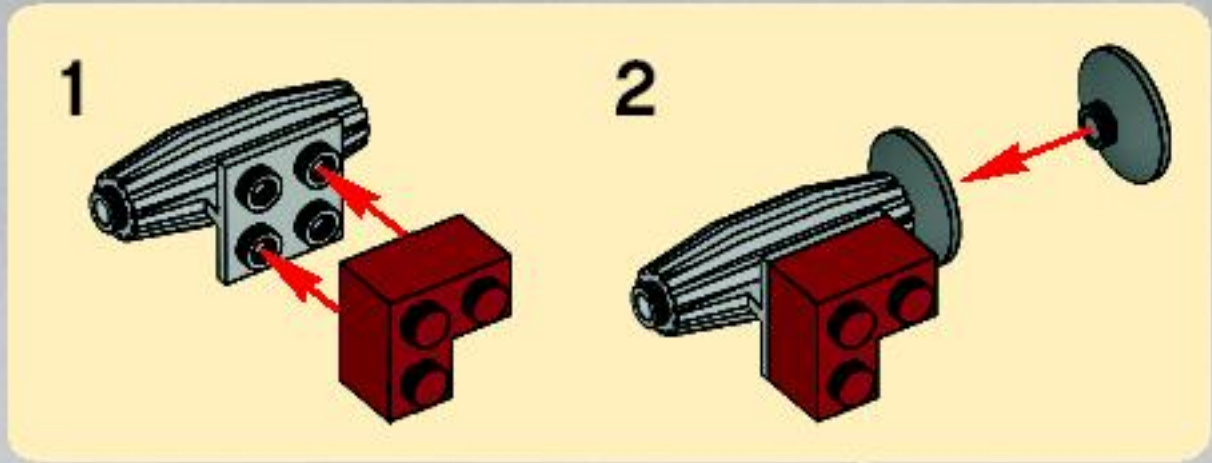

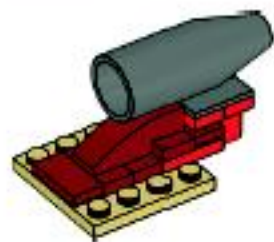

1

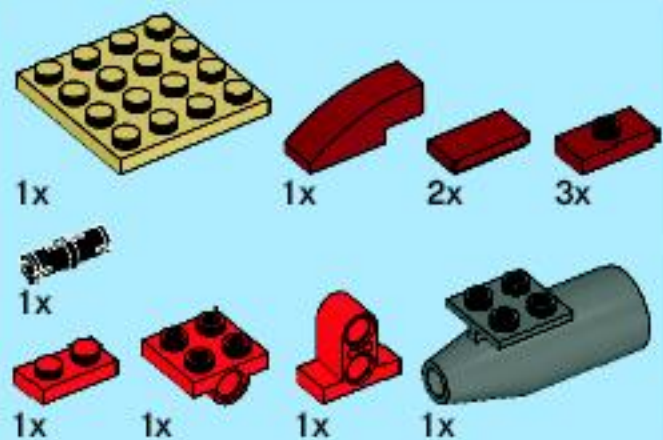
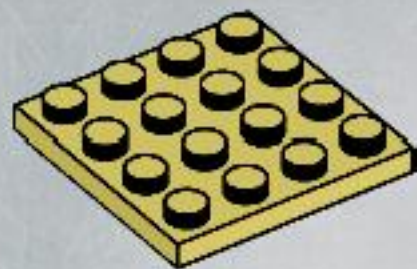

2

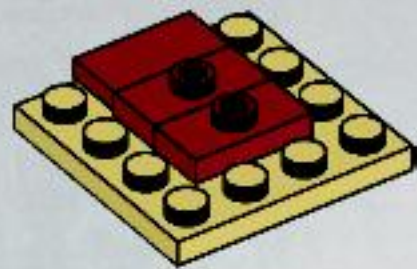



3

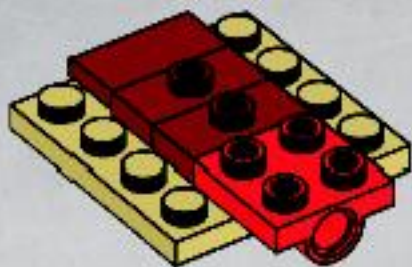

4

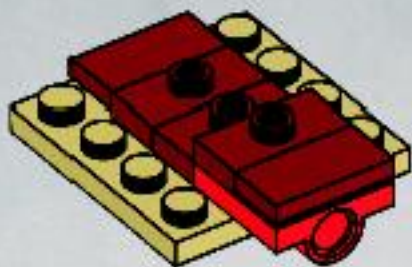

5

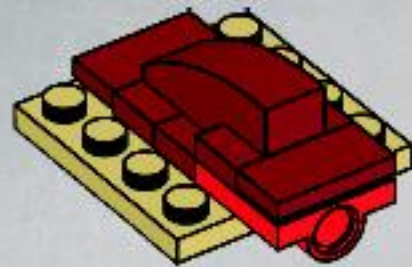

6

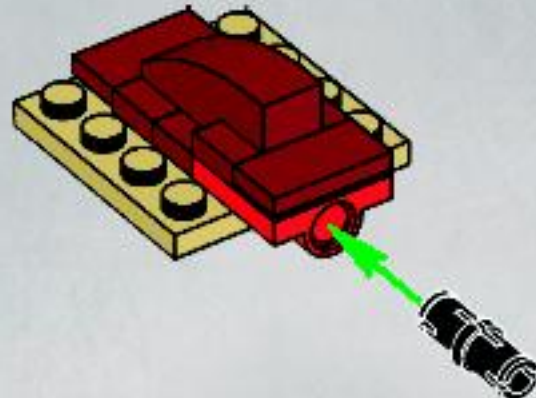

1



2

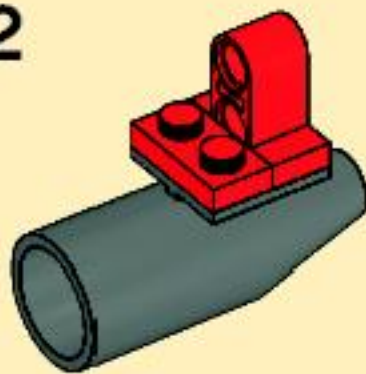

7

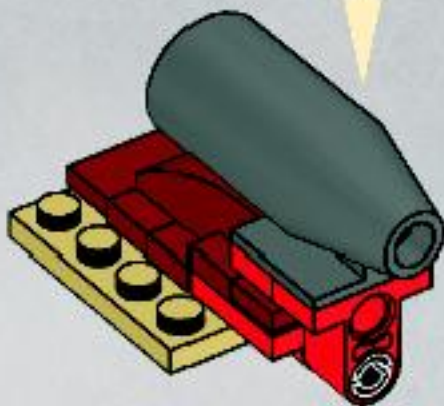



39

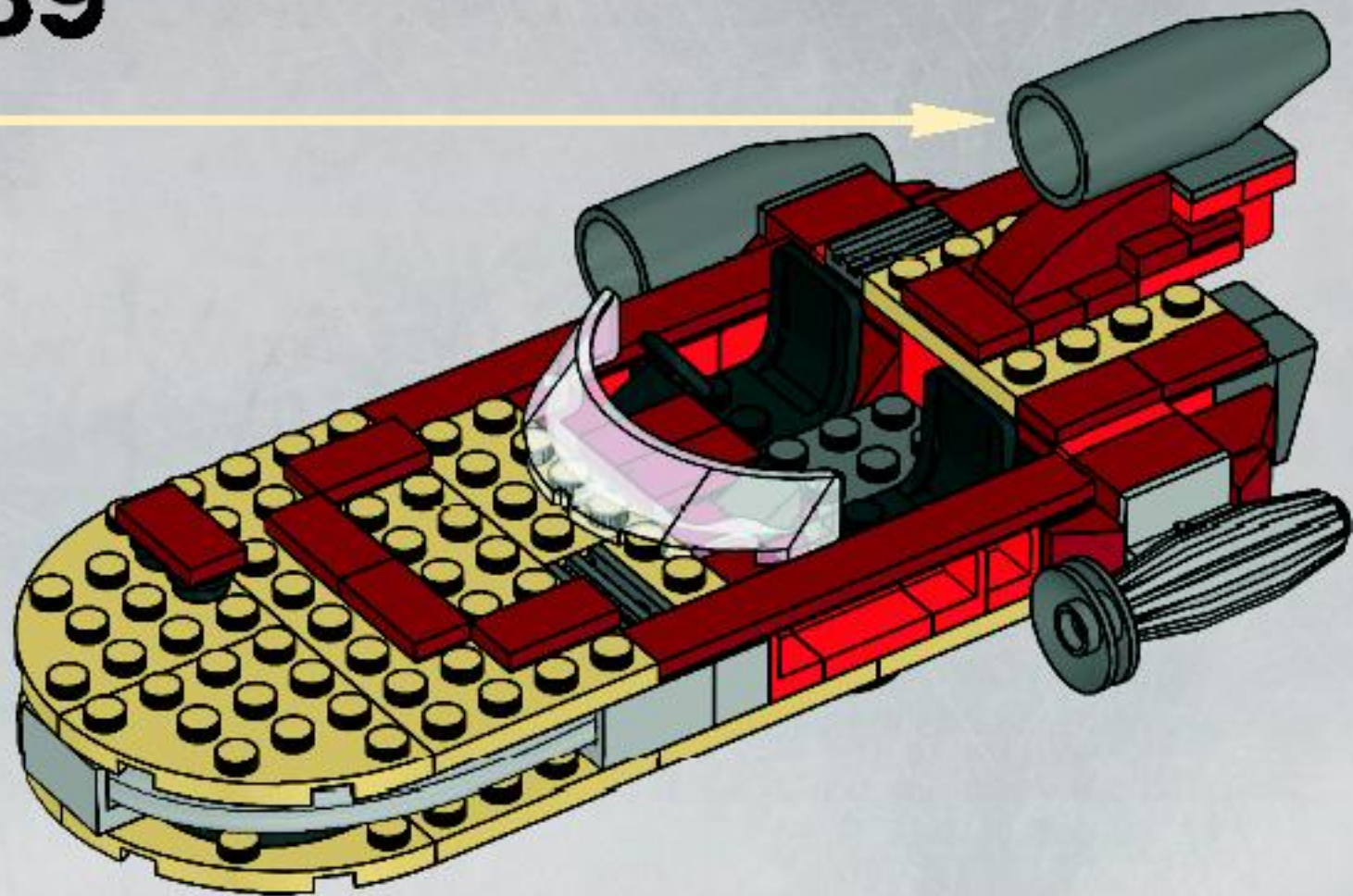



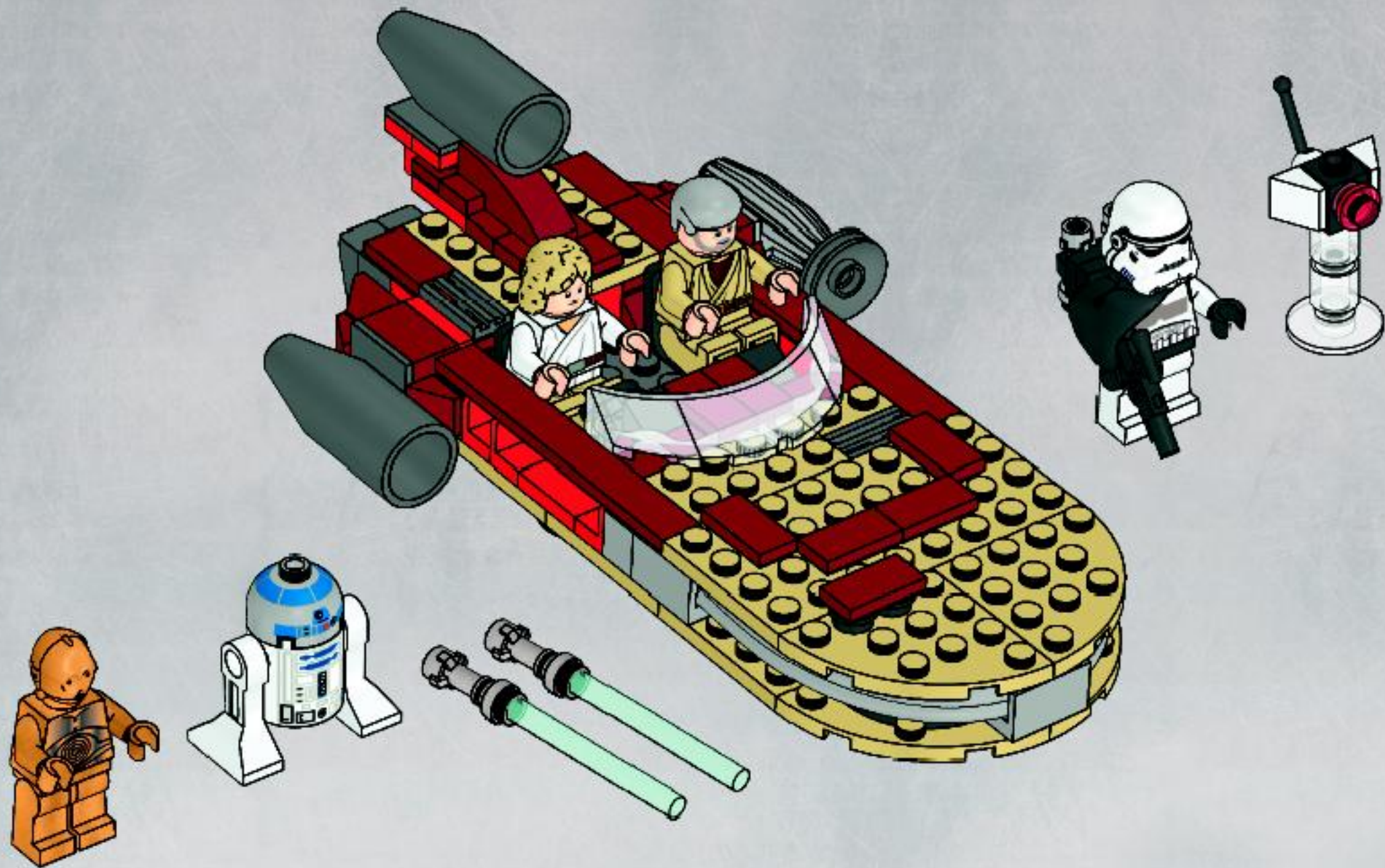





1x  
4510082



1x  
4275255



2x  
4124113



1x  
4194011



2x  
4504369



1x  
73737



1x  
74326



1x  
4142954



2x  
4548731



1x  
4513706



1x  
4243824



1x  
4114001



4x  
4509897



4x  
4570516



1x  
4113917



1x  
4114309



1x  
4510084



1x  
4107623



1x  
4510090



2x  
246021



1x  
244421



7x  
302321



6x  
4190219



4x  
486521



1x  
4207715

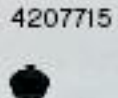

2x  
614126



2x  
300826

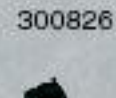

2x  
4567436



2x  
370026



2x  
4504382



2x  
255526



1x  
4140588



7x  
4278359



2x  
407926



1x  
473326



1x  
4570544



1x  
362626



1x  
4498713



1x  
73081



1x  
4121715

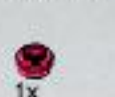

1x  
3005741



2x  
4124073



2x  
3006840

1x  
4187750

1x  
4523573

2x  
4541376

2x  
4541379



Customer Service

Kundenservice

Service Consommateurs

Servicio Al Consumidor

[www.lego.com/service](http://www.lego.com/service) or dial



00800 5346 5555 :



1-800-422-5346 :



4x  
4531415

8x  
4541526

1x  
4541546

16x  
4539090

2x  
4539083

3x  
4539063

2x  
4211389

2x  
4211385

1x  
4533122

1x  
4211740

3x  
4211515

2x  
4539481

1x  
4579635



2x  
4567861

1x  
4569754

1x  
4569715

1x  
4512015

1x  
4512021

1x  
4512225

6x  
4558955

4x  
4540386

2x  
4210631

2x  
4277928

2x  
4211010

1x  
4210469

2x  
4579639

2x  
4211065

1x  
4210678



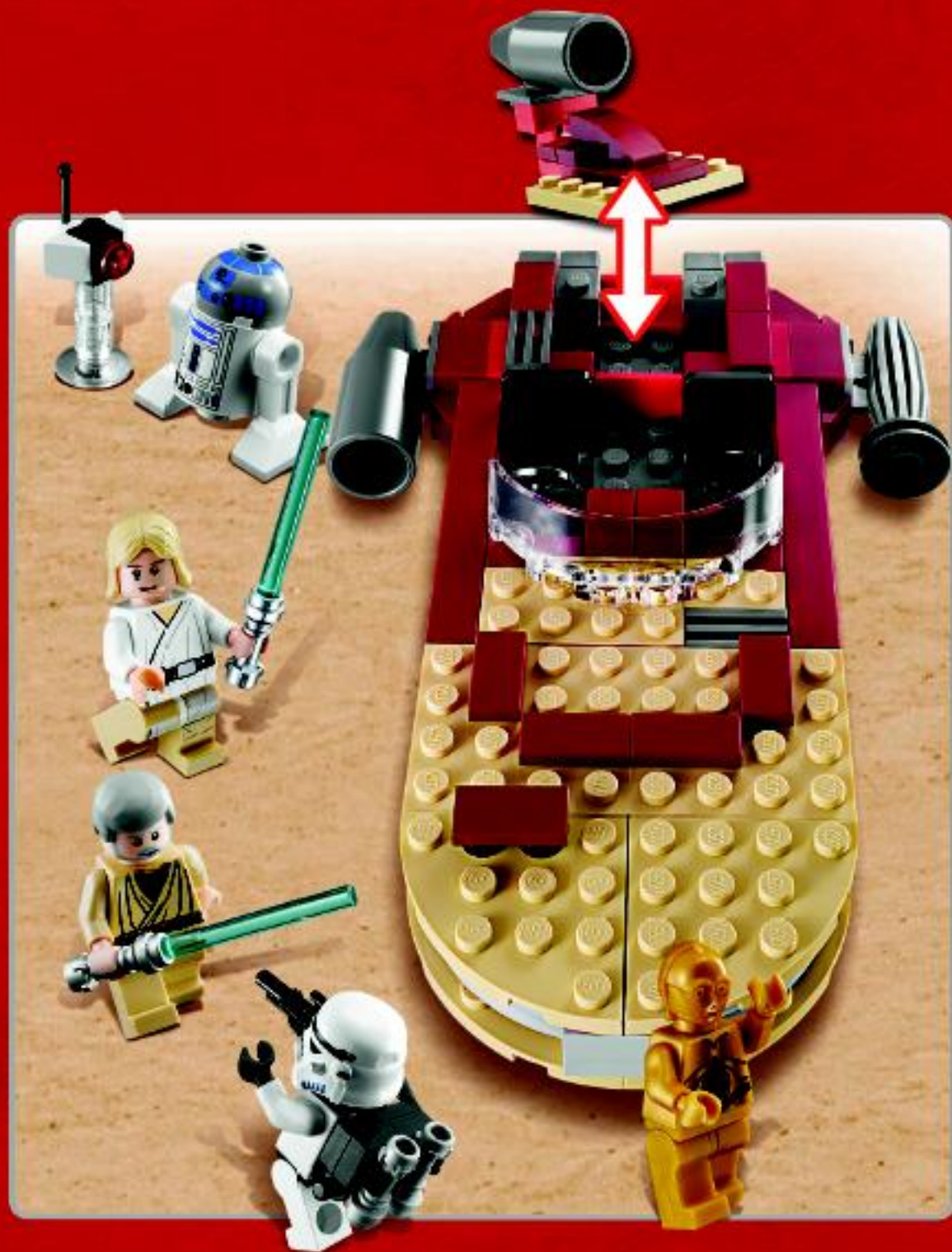





8083



8084



8085



8086



8087



8088



**FREE! GRATIS! GRATUIT!**

**LEGO club**  
MAGAZINE™

**www.LEGOclub.com**



**00800 5346 5555\*** 

 **1-866-534-6258 • 1-877-518-5346**

US & Canada only

Canada seulement

\* Free phone. Mobile charges may apply. \* Numéro sans frais. Les frais peuvent s'appliquer avec les téléphones cellulaires. \* Gebührenfrei. Kosten für Anrufe aus Mobilfunknetzen können anfallen. \* Gratis telefonnummer vanaf vaste lijn. \* Debet ett gratis nummer när du ringer från fasttelefon. \* Det är gratis, när du ringer från en fast telefon.



VISIT THE WORLD'S  
BIGGEST LEGO® SHOP!

**www.LEGOshop.com**





# WIN!

Go to [www.nielsen.com/LEGO](http://www.nielsen.com/LEGO)  
to fill out a survey for a chance  
to win a cool LEGO® Product.

No purchase necessary.

Open to all residents where not prohibited.



## [www.nielsen.com/LEGO](http://www.nielsen.com/LEGO)

### GEWINNE!

Nimm an der Umfrage auf  
[www.nielsen.com/](http://www.nielsen.com/)  
LEGO teil und hab die Chance ein cooles  
LEGO® Produkt zu gewinnen!

Die Teilnahme am Gewinnspiel führt zu keinerlei  
Kaufverpflichtungen. Teilnahme in allen nicht  
ausgeschlossenen Ländern möglich.

### WIN!

Ga naar [www.nielsen.com/LEGO](http://www.nielsen.com/LEGO),  
vul een enquêteformulier in en  
maak kans op een  
cool LEGO® product.

Geen aankoopverplichting.  
Iedereen mag deelnemen, uitgezonderd  
ingezetenden  
van landen waar een enquêteverbod geldt.

### GAGNE!

Visite [www.nielsen.com/LEGO](http://www.nielsen.com/LEGO)  
pour répondre à un questionnaire  
et avoir une chance de gagner  
un produit LEGO® très cool!

Aucune obligation d'achat.  
Ouvert à tous les résidents des pays  
autorisés.

### 当てよう!

[www.nielsen.com/LEGO](http://www.nielsen.com/LEGO)  
にアクセスして、  
アンケートにご記入ください。  
当選者にはレゴ製品を  
差し上げます。

お買い上げの必要はありません。  
中止されていない限り、すべての皆様にご利用いただけます。