



# MONKIE KID 悟空小侠

80049



1

Booklet available in English on  
Livret disponible en français sur  
Folleto disponible en español en

[LEGO.com/service/buildinginstructions](https://www.lego.com/service/buildinginstructions)



**Get excited about our new packaging!**

We're switching from plastic to paper-based packaging. That's why you might find a mix of paper and plastic in our boxes!

**Nos nouveaux emballages vous emballeront !**

Nous passons des emballages en plastique aux emballages à base de papier. C'est pourquoi vous pourriez trouver un mélange de papier et de plastique dans nos boîtes !

**¡Te presentamos nuestros nuevos empaques!**

Estamos sustituyendo las bolsas de plástico por bolsas con base de papel. ¡Por eso, puedes encontrar una mezcla de papel y de plástico en nuestras cajas!

[LEGO.com/sustainable-packaging](https://www.lego.com/sustainable-packaging)



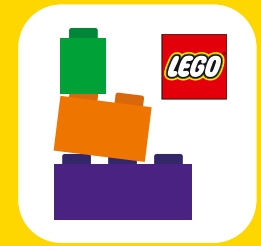

# BUILDER



Apple and the Apple logo are trademarks of Apple Inc., registered in the U.S. and other countries and regions. App Store is a service mark of Apple Inc. Google Play and the Google Play logo are trademarks of Google LLC. Tencent and the Tencent logo are trademarks of Tencent Inc.

Q [LEGO.com/devicecheck](https://www.lego.com/devicecheck)

EN Ask parents' permission before going online | DE Eltern um Erlaubnis bitten, bevor du online gehst | FR Demande l'autorisation d'un parent avant d'aller en ligne | IT Chiedi il permesso ai tuoi genitori prima di andare online | ES Pídeles permiso a tus papás antes de conectarte a Internet | PT Peça autorização aos pais antes de acederes online | ZH 上网前应先征得父母的同意 | PL Poproś rodziców o zgodę, zanim wejdiesz do Internetu | CS Než půjdeš na internet, požádej rodiče o svolení | SK Skôr než pôjdeš na internet, vypýtaj si povolenie od rodičov | HU Kérj szülői engedélyt, mielőtt online csatlakoznál! | RO Cere permisiunea părinților înainte de a te conecta online | BG Поискайте разрешение от родител, преди да влезете онлайн | LV Pirms došanās tiešsaistē palūdz atļauju vecākiem | ET Enne Interneti kasutamist küsi vanematelt luba | LT Prieš prisijungdami prie interneto, atsiklauskite tėvų



## IN THE PALACE OF THE DRAGON OF THE EAST

Inspired by the classic novel *Journey to the West*, this LEGO® Monkie Kid™ set explores the origins of the timeless legend and how the Monkey King got his staff from the Dragon of the East.

## DANS LE PALAIS DU DRAGON DE L'EST

Inspiré du roman classique *La Pérégrination vers l'Ouest*, cet ensemble LEGO® Monkie Kid™ explore les origines de la légende intemporelle et la façon dont Monkey King a obtenu son bâton du dragon de l'Est.

## EN EL PALACIO DEL DRAGÓN DEL ESTE

Inspirado en la clásica novela *Journey to the West*, este set LEGO® Monkie Kid™ explora los orígenes de la intemporal leyenda y cómo Monkey King logró que el Dragón del Este le facilitara su Bastón.

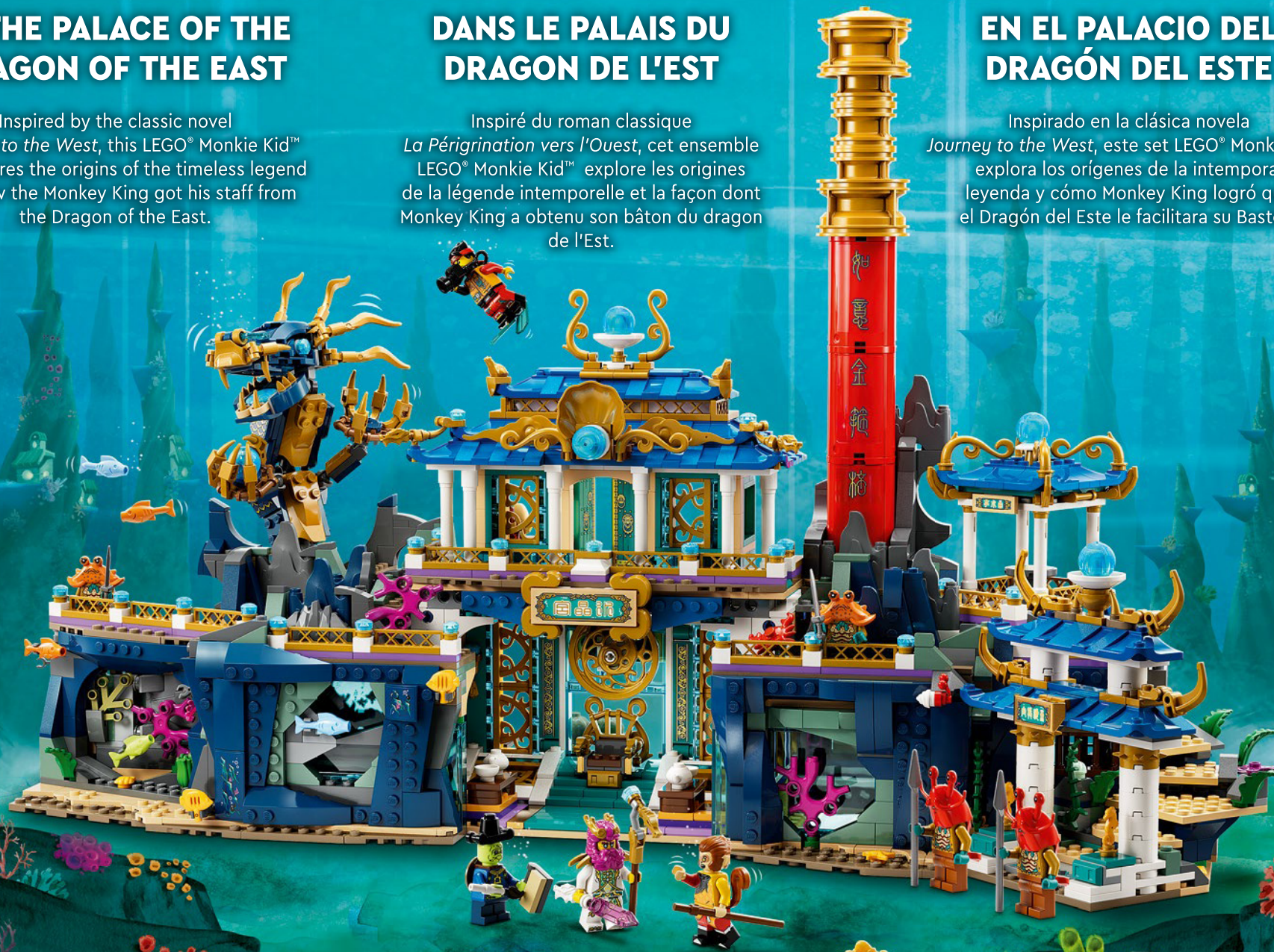





### THE ARMORY

The Dragon King of the East guards an armory of the most powerful weapons in the realm. The Monkey King seeks him out to ask permission to use one of the weapons.

### L'ARMURERIE

Le roi dragon de l'Est garde une armurerie renfermant les armes les plus puissantes du royaume. Monkey King va le voir pour lui demander la permission d'utiliser une des armes.

### EL ALMACÉN DE ARMAS

El Rey Dragón del Este mantiene un almacén bien abastecido con las armas más poderosas del reino. Monkey King lo busca porque necesita su permiso para usar una de sus armas.

### THE STAFF

After passing on several weapons – in his opinion, they are too light – the Monkey King selects the most supreme weapon of them all: the pillar of the ocean – the staff.

### LE BÂTON

Après avoir écarté plusieurs armes qui sont, selon lui, trop légères, Monkey King choisit l'arme la plus redoutable de toutes : le pilier de l'océan – le bâton.

### EL BASTÓN

Luego de probar varias armas (todas ellas demasiado ligeras, en su opinión), Monkey King selecciona una que es superior a todas: el Pilar del Océano (es decir, el Bastón).



### THE FABLE OF THE WISE MAN

The Monkey King and the Dragon King meet to discuss the ancient fable of a wise old man who gave his books of wisdom to a humble young man and mentored him to become a great leader.

### LA FABLE DU SAGE

Monkey King et le roi dragon se rencontrent pour discuter de l'ancienne fable d'un vieil homme sage qui a donné ses livres de sagesse à un humble jeune homme et l'a aidé à devenir un grand meneur.

### LA FÁBULA DEL SABIO

Monkey King y el Rey Dragón se reúnen para hablar sobre la antigua fábula de un sabio que regaló sus libros a un joven humilde y lo guio hasta hacer de él un gran líder.



John Ho



## TRADITIONNEL, ROYAL – ET AMUSANT !

« Pour recréer le palais légendaire sous forme LEGO®, nous avons fusionné la conception traditionnelle chinoise avec un décor sous-marin enchanteur. Pour montrer l'ampleur du palais, dont les tours dominent les montagnes à l'arrière-plan, nous avons créé une perspective forcée pour faire évoluer le modèle de l'échelle d'une figurine en bas à celle d'un palais complet à plus petite échelle en haut. Du dragon mobile aux nouvelles créatures marines amusantes, en passant par les parchemins cachés, les décorations et l'échiquier chinois, chaque détail et chaque fonction sont inspirés des histoires de la légende, avec l'élément clé de l'histoire, le bâton, au cœur du spectacle. »

*John Ho,  
concepteur principal LEGO® Monkie Kid™*

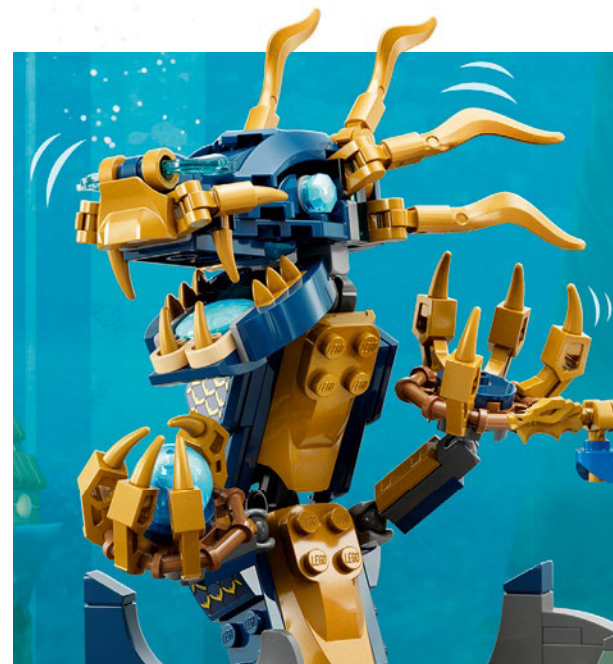

## TRADICIONAL, MAJESTUOSO, ¡Y DIVERTIDO!

"Para recrear el legendario lugar en formato LEGO®, fusionamos el diseño chino tradicional con un divertido entorno subacuático. Para reflejar el descomunal tamaño del palacio, que se eleva sobre las montañas del fondo, creamos una perspectiva forzada en el modelo para pasar de la escala de minifigura de abajo a una escala más pequeña, la del palacio completo, en la parte superior. Desde el dragón articulado y los nuevos y divertidos personajes acuáticos hasta los pergaminos ocultos y un tablero de ajedrez chino, todos los detalles y funciones están inspirados en la trama de la leyenda, con el Bastón como centro de atención principal".

*John Ho,  
diseñador sénior de LEGO® Monkie Kid™*



## TRADITIONAL, REGAL – AND FUN!

"To recreate the legendary palace in LEGO® form, we fused traditional Chinese design with a playful underwater setting. To show the sheer scale of the palace, which towers above the mountains in the background, we created a forced perspective to transition the model from a minifigure-scale below to a smaller-scale, full palace above. From the posable dragon and fun new sea creature characters to hidden scrolls, decorations and the Chinese chessboard – every detail and function is inspired by storylines in the legend, with the key element of the story, the staff, as the main focal point."

*John Ho,  
LEGO® Monkie Kid™ Senior Designer*

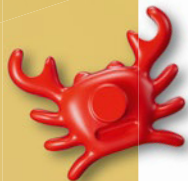





## FROM CONCEPT TO MODEL

"A pivotal moment in *Journey to the West* is when the Monkey King gets his staff from the Dragon of the East. We hadn't seen the dragon's magnificent underwater palace in its entirety before, so our design teams in Denmark and Shanghai worked closely together to develop an imaginative and playful model that stays true to the original legend and adds our distinct LEGO® twist to the story. Now Monkie Kid gets to open it up and discover all its secrets!"

Xiaodong Wen,  
LEGO® Monkie Kid™ Senior Designer

## DU CONCEPT AU MODÈLE

« Un moment charnière dans *La Pérégrination vers l'Ouest* est celui où Monkey King obtient son bâton du dragon de l'Est. Nous n'avions encore jamais vu le magnifique palais sous-marin du dragon dans son intégralité. Nos équipes de conception au Danemark et à Shanghai ont donc travaillé en étroite collaboration pour développer un modèle imaginaire et fantaisiste qui reste fidèle à la légende originale et ajoute notre touche LEGO® distinctive à l'histoire. Maintenant, Monkie Kid va pouvoir l'ouvrir et découvrir tous ses secrets ! »

Xiaodong Wen,  
concepteur principal LEGO® Monkie Kid™

## DEL CONCEPTO AL MODELO

"Un momento decisivo de *Journey to the West* es cuando Monkey King convence al Dragón del Este de permitirle usar su Bastón. Nunca habíamos visto el palacio submarino del dragón en toda su magnificencia, así que nuestros equipos de diseño de Dinamarca y Shanghai colaboraron estrechamente para desarrollar un modelo imaginativo y divertido que se mantuviera fiel a la leyenda original y añadiera nuestro distintivo toque LEGO® a la historia. ¡Ahora es el turno de Monkie Kid de abrirlo y descubrir todos sus secretos!".

Xiaodong Wen,  
diseñador sénior de LEGO® Monkie Kid™

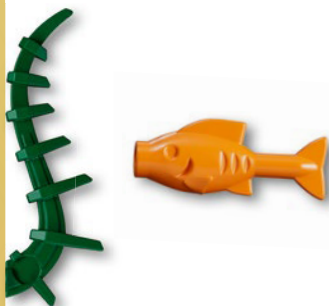

Early concept artwork for the model



Premières images conceptuelles du modèle  
Primeras ilustraciones conceptuales del modelo



Paul Constantin Turcanu



## DIVE INTO THE STORY

"From curvy lines in the palace paintings and cracks in the rocks to dark blue outlines, shiny bubbles and swirly, vibrant plants – we played with every element and graphic detail to complete the illusion of a rich and immersive underwater environment. We wanted to include as many references as possible to the story, so every room in the palace has fun design elements and hidden Easter eggs for an avid Monkey King fan like Monkie Kid to discover."

Paul Constantin Turcanu,  
LEGO® Monkie Kid™ Design Master,  
Graphic Design

## PLONGER DANS L'HISTOIRE

« Des lignes courbes des peintures du palais et des fissures dans les rochers aux contours bleu foncé, en passant par les bulles brillantes et les plantes tourbillonnantes et éclatantes, nous avons joué avec chaque élément et détail graphique pour compléter l'illusion d'un environnement sous-marin riche et immersif. Nous voulions inclure autant de références à l'histoire que possible. C'est pourquoi chaque pièce du palais comporte des éléments amusants et des œufs de Pâques cachés qu'un grand amateur de Monkey King comme Monkie Kid pourra découvrir. »

Paul Constantin Turcanu,  
maître de la conception LEGO® Monkie Kid™,  
graphisme

## SUMÉRGETE EN EL RELATO

"Desde las líneas curvas de las pinturas del palacio y las grietas de las rocas hasta los contornos en azul oscuro, las brillantes burbujas y las arremolinadas y vibrantes plantas, jugamos con cada uno de los elementos y detalles gráficos para completar la ilusión de un entorno rico y envolvente bajo el agua. Queríamos incluir todas las referencias posibles a la historia, por lo que cada habitación del palacio tiene divertidos elementos de diseño y huevos de Pascua ocultos para que los ávidos fans del Monkey King, como Monkie Kid, los descubran".

Paul Constantin Turcanu,  
maestro de diseño de LEGO® Monkie Kid™  
a cargo del diseño gráfico



Early sketches of the fable of the wise man, and Monkie Kid in scuba gear  
Premières esquisses de la fable du sage et de Monkie Kid en tenue de plongée  
Primeros trazos de la fábula del sabio y Monkie Kid con equipo de buceo





HOW TO CARRY  
THE MODEL

COMMENT DÉPLACER  
LE MODÈLE  
CÓMO TRANSPORTAR  
EL MODELO

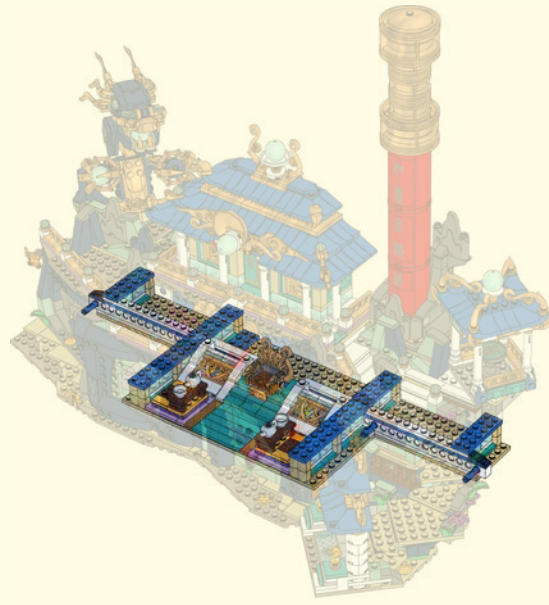



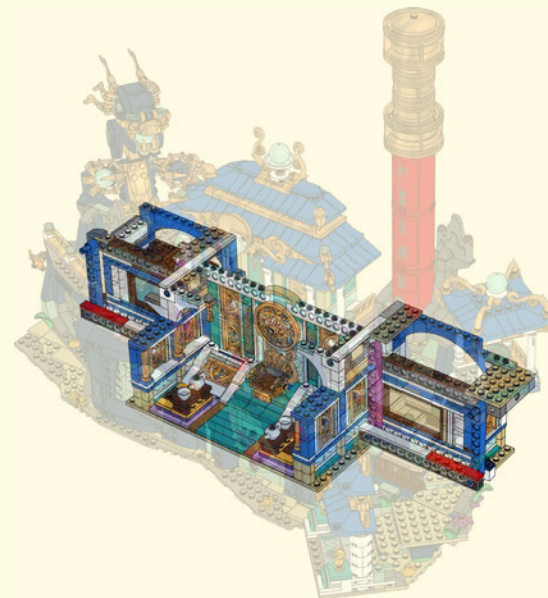

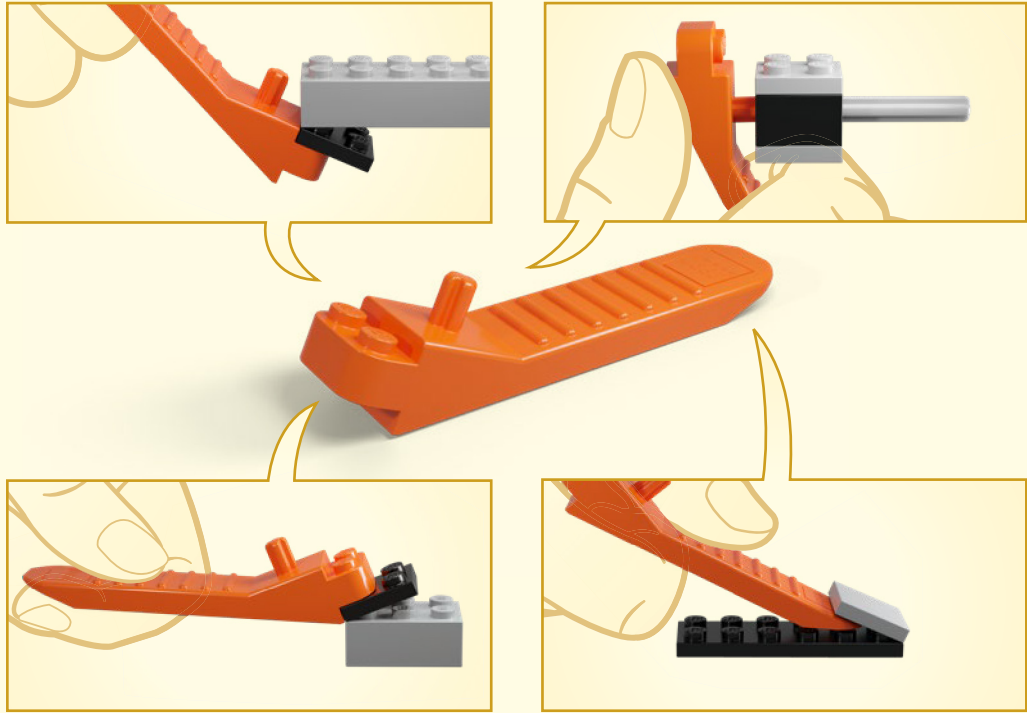





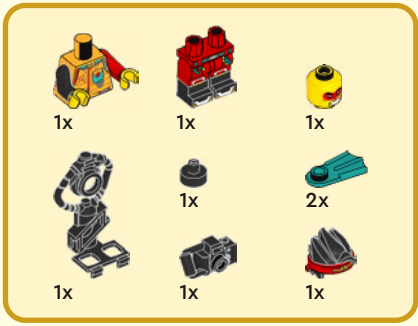

1

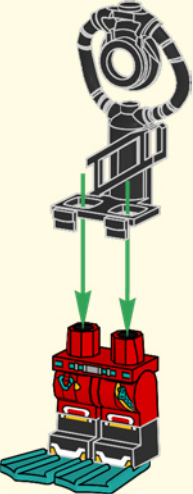

2

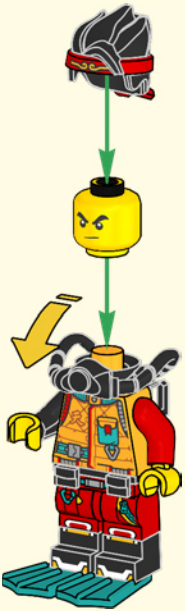

3





# MONKIE KID





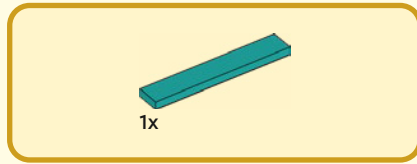
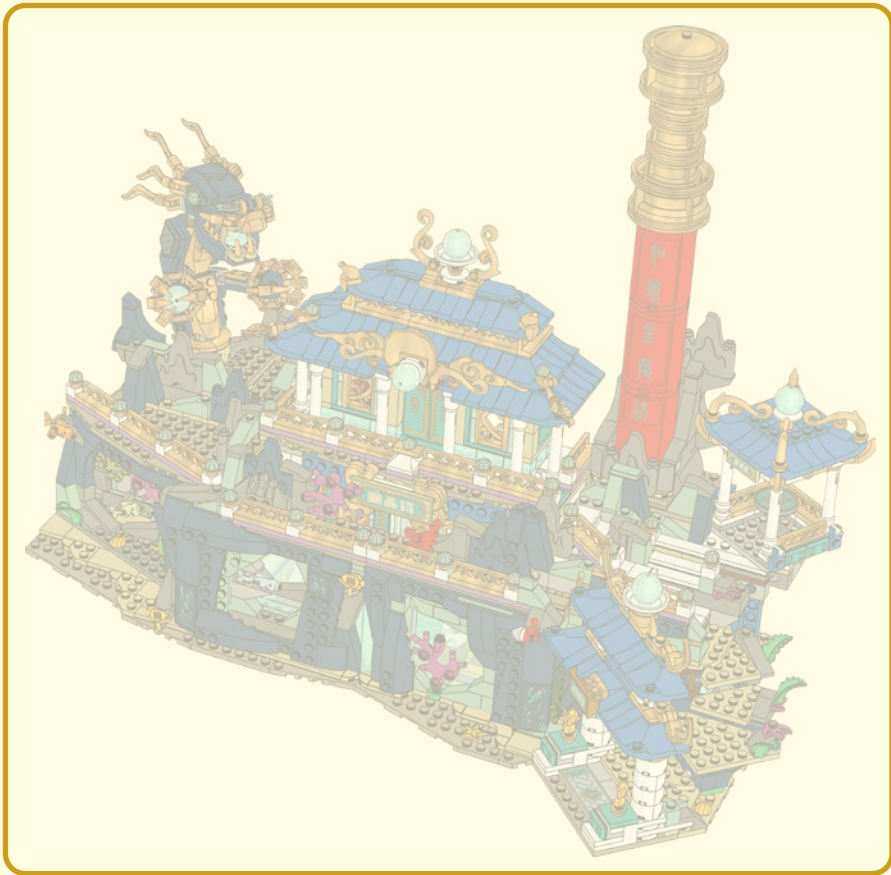

1

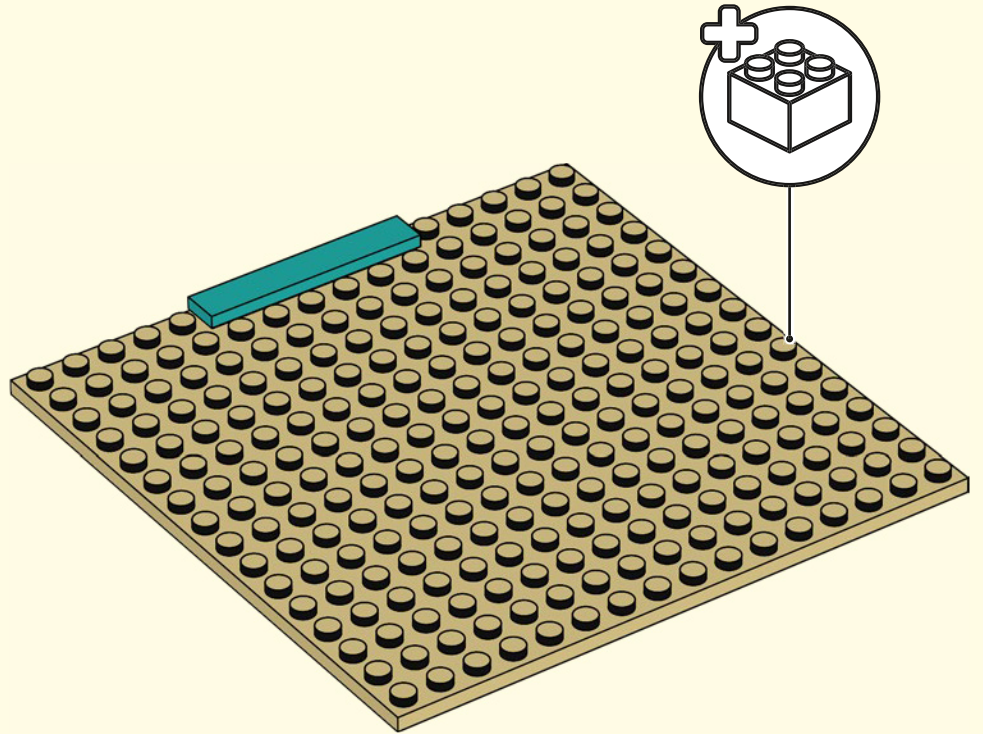



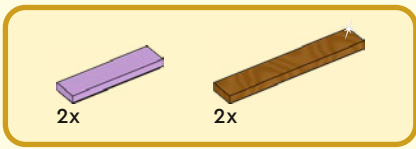

2

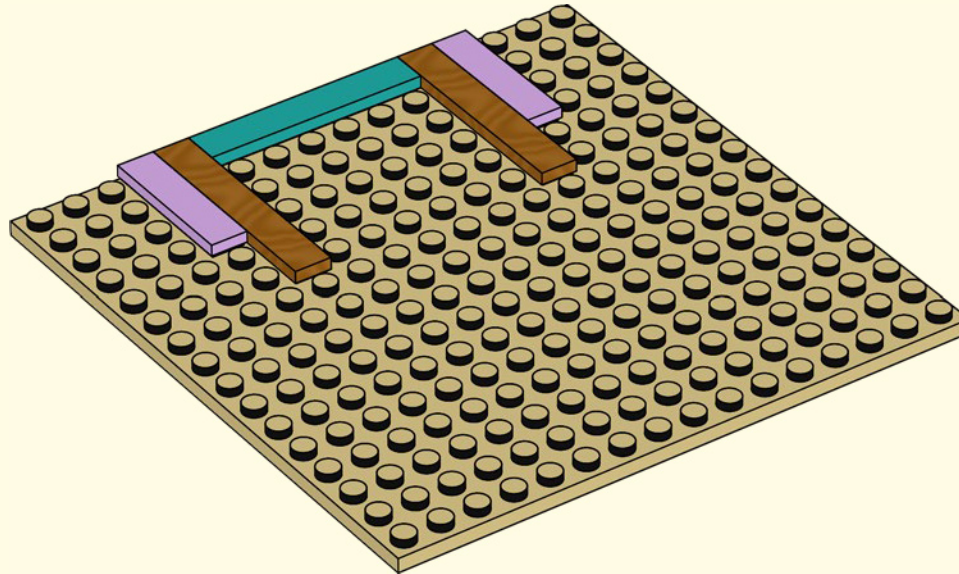



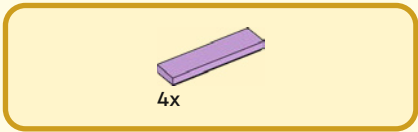

3

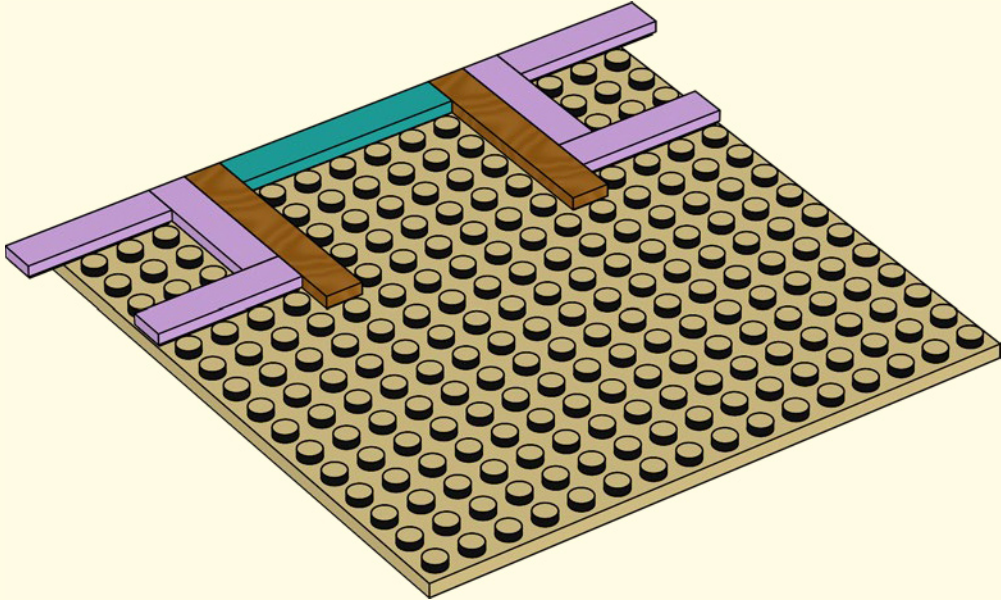

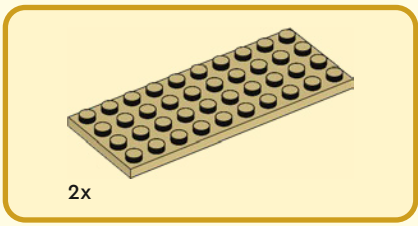

4

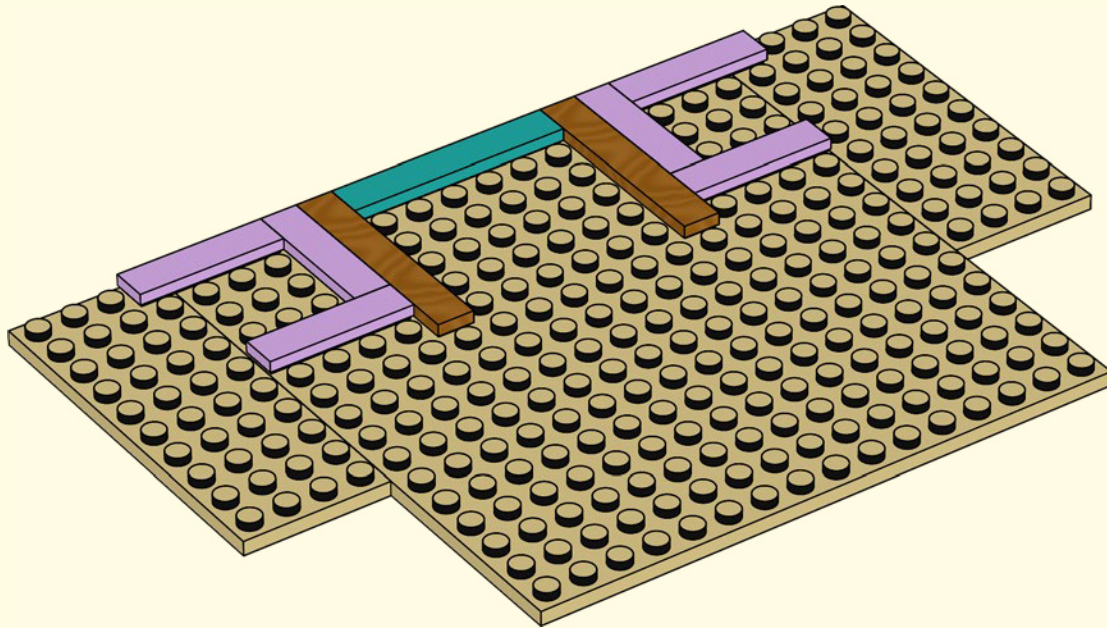





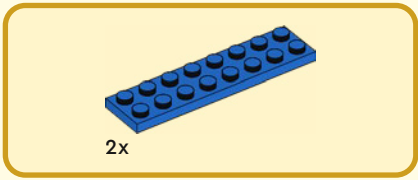

6

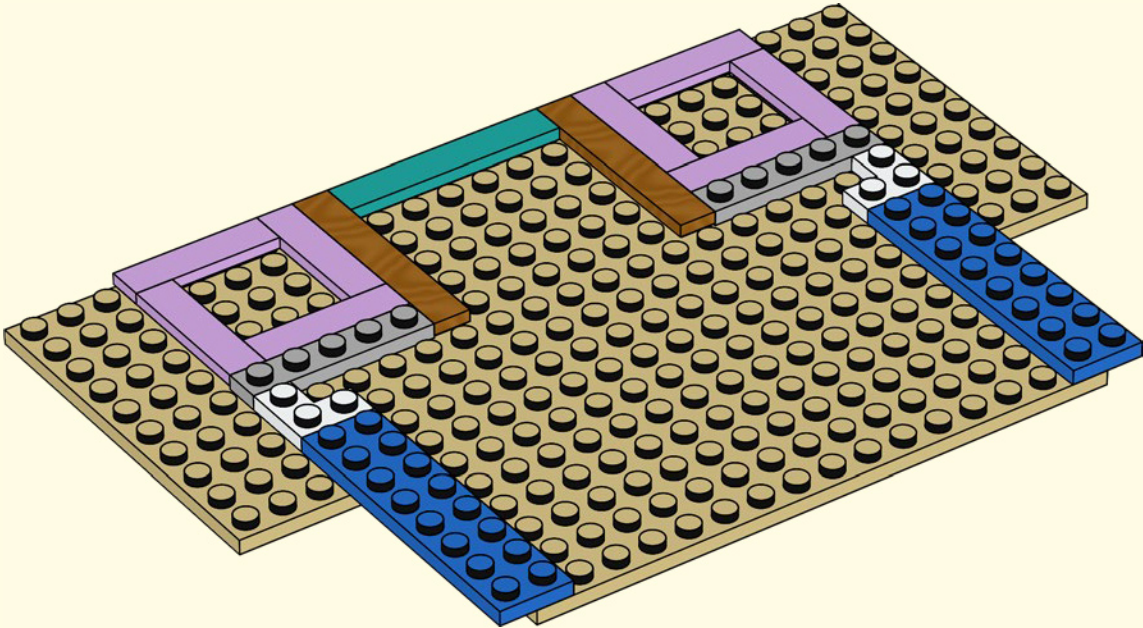



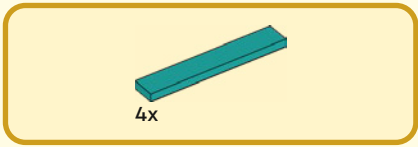

7

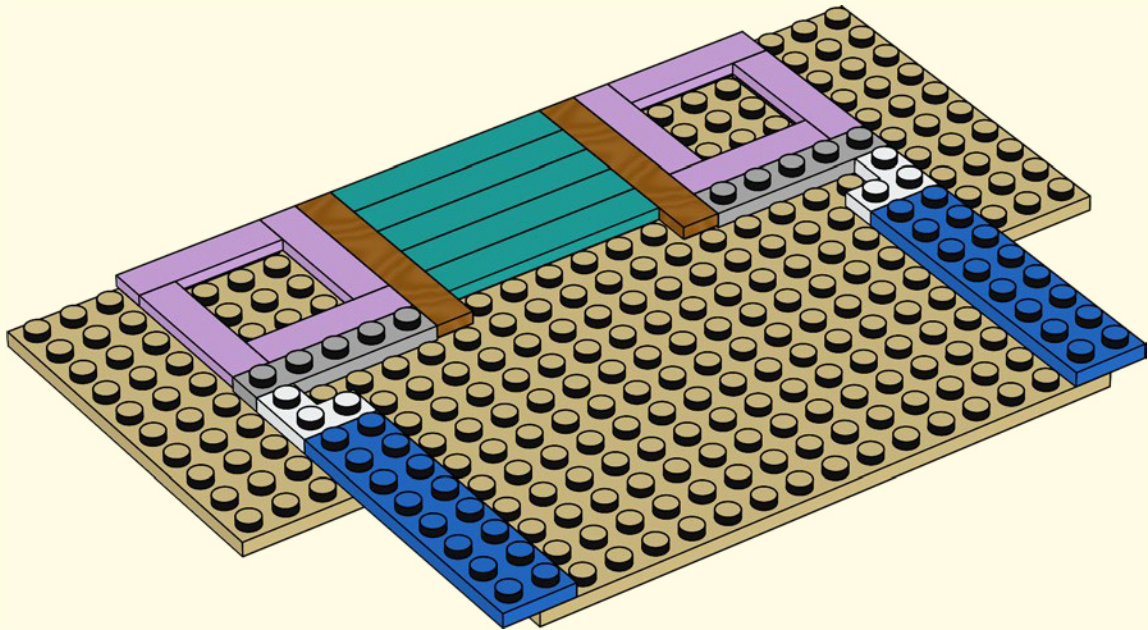

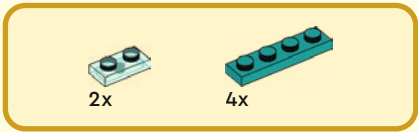

8

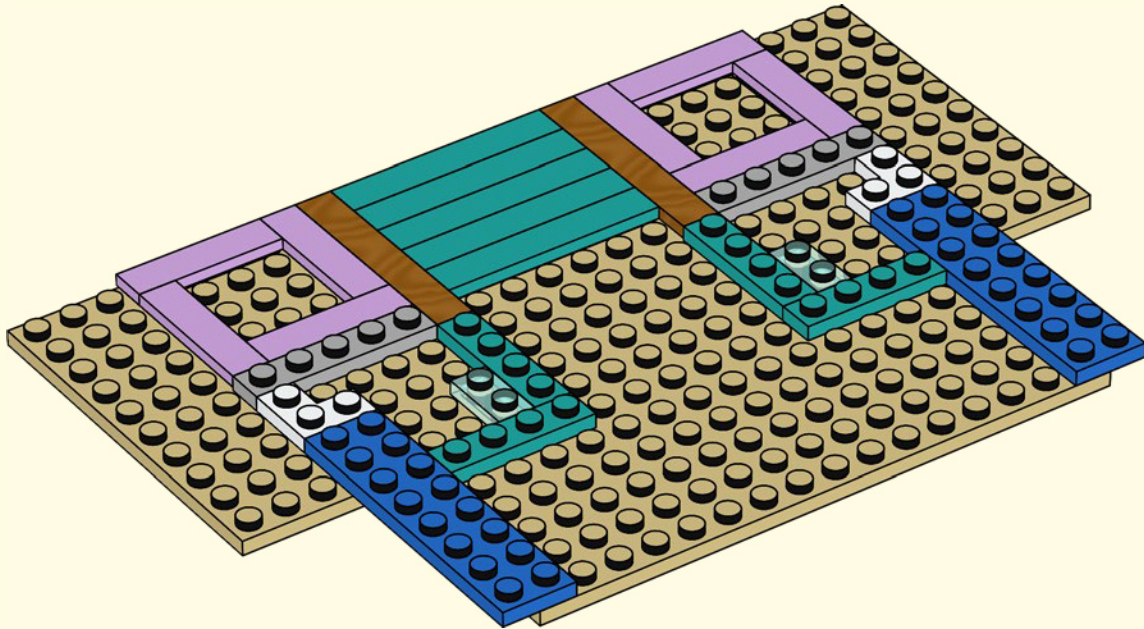



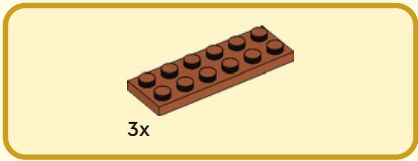

9

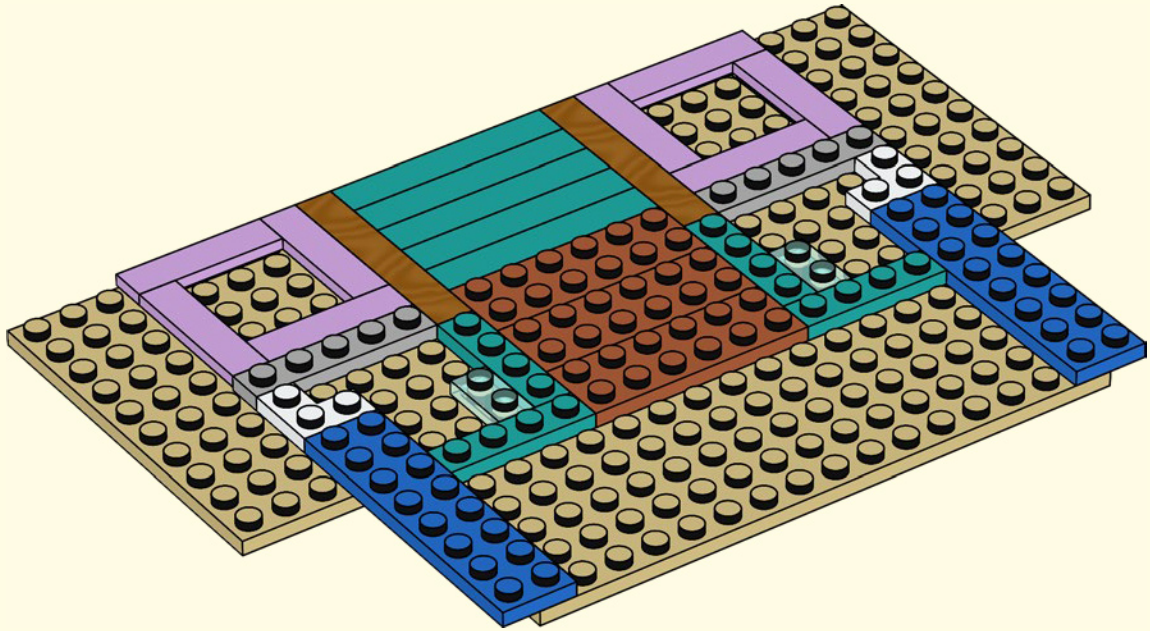

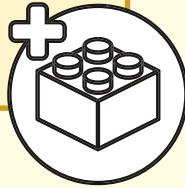
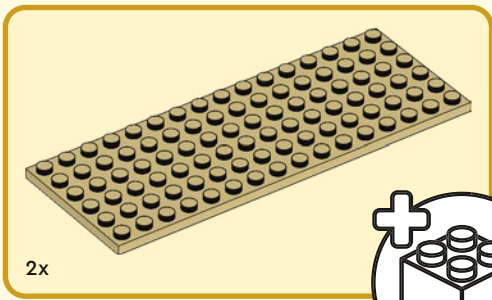

10

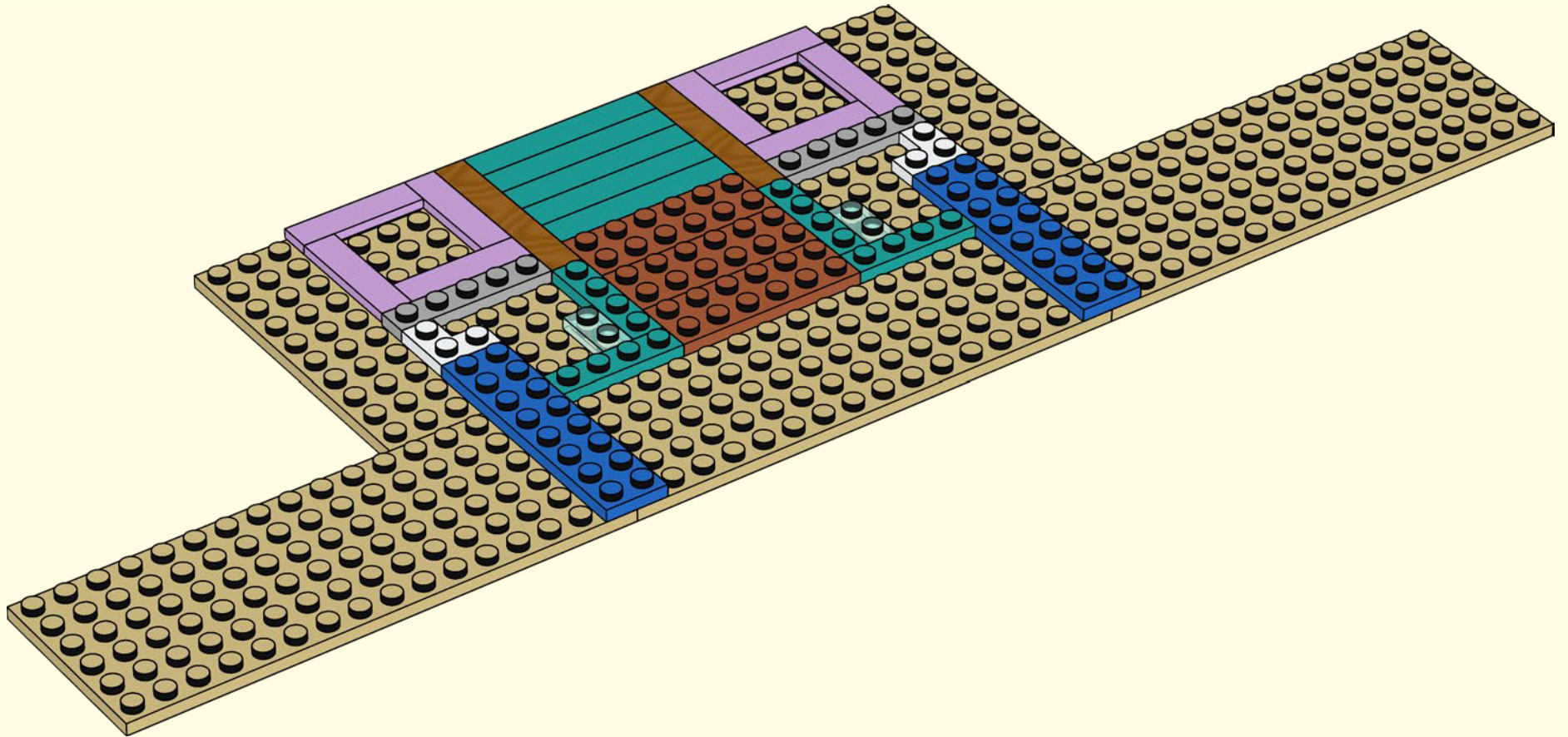





2x



2x



2x

11

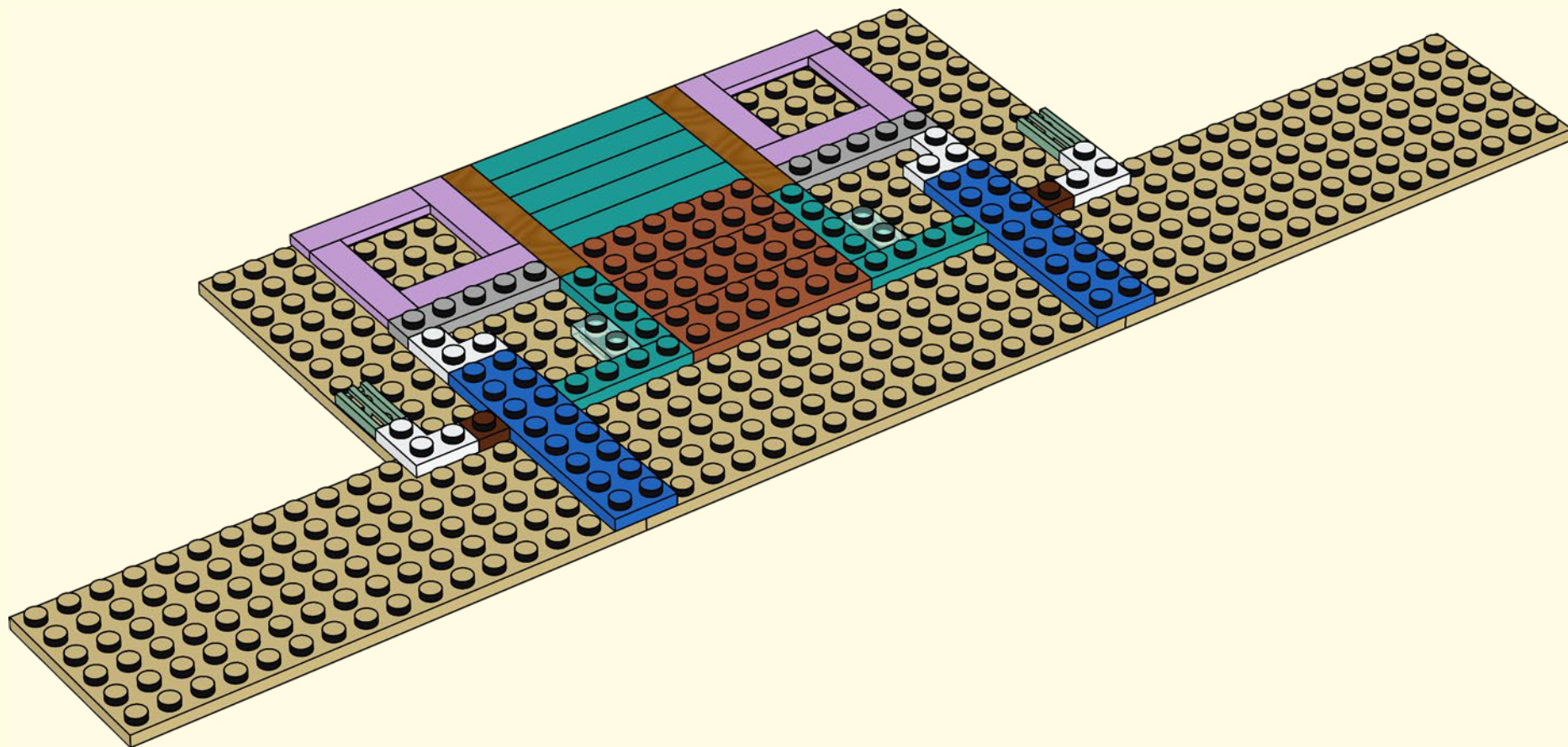

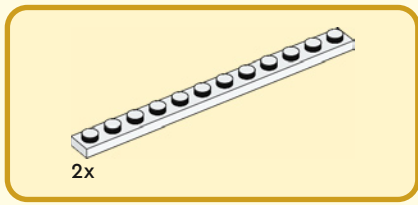

12

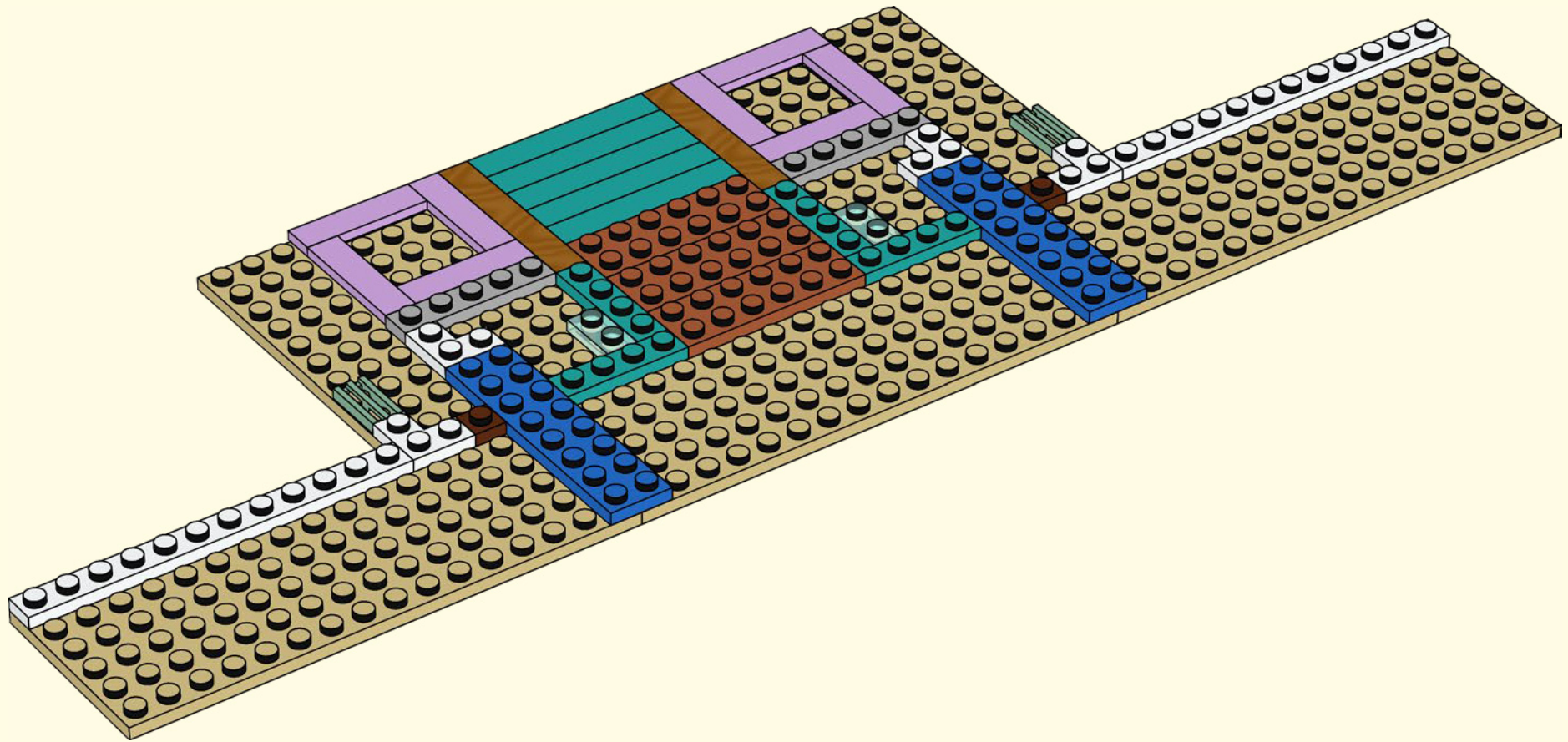



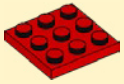

2x



3x

13

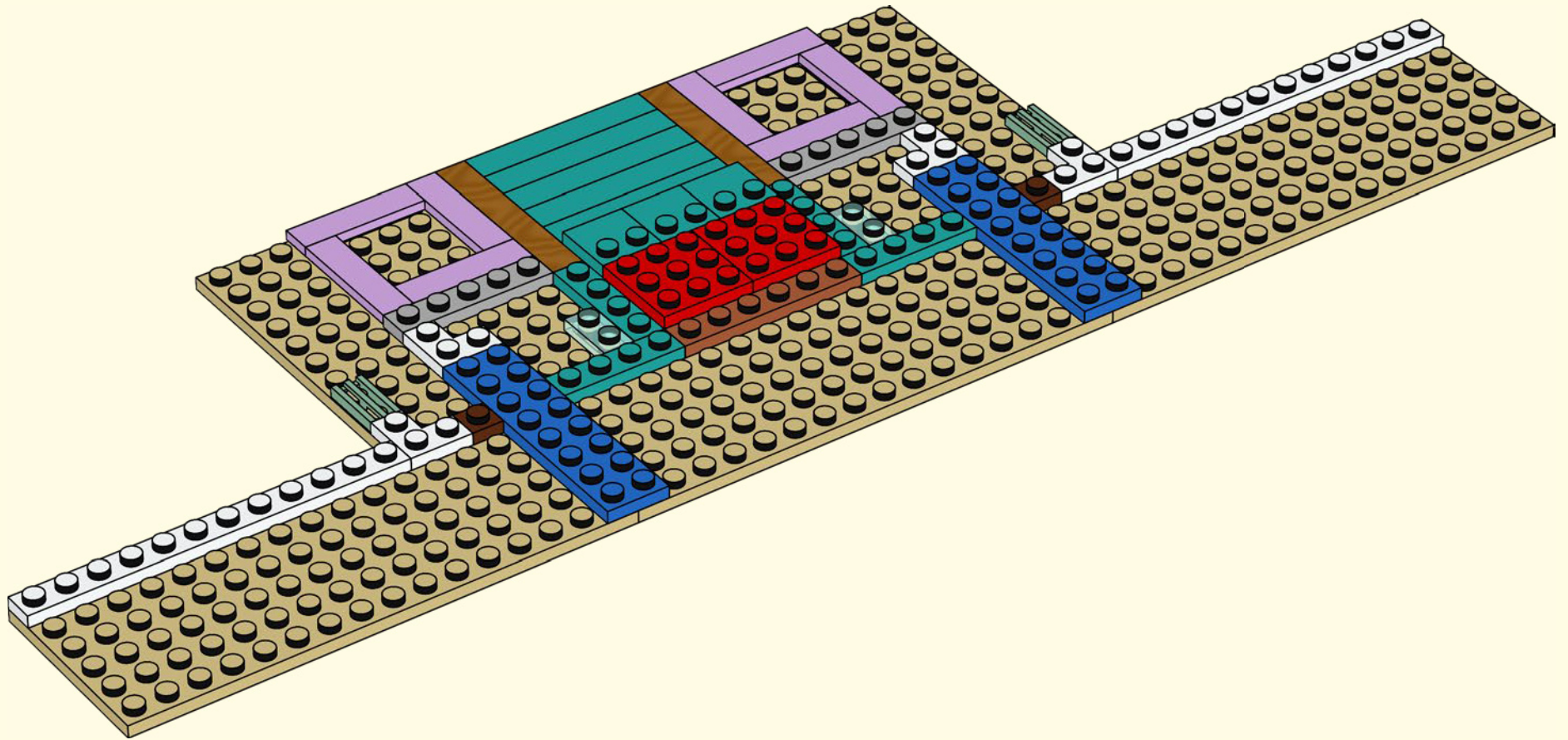

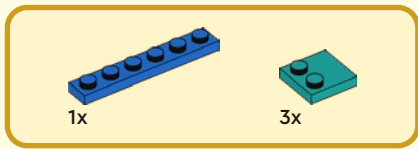

14

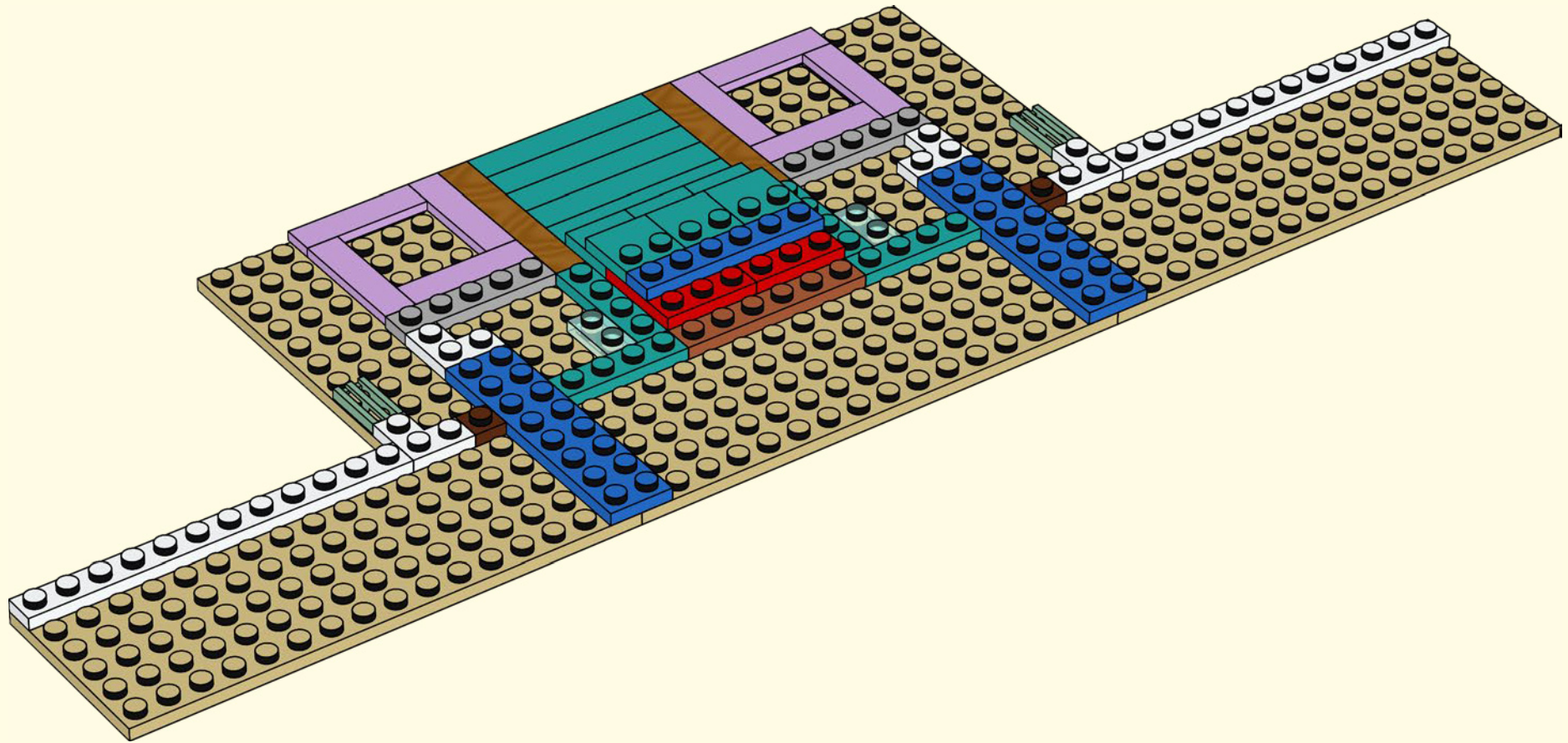



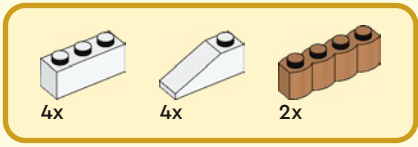

15

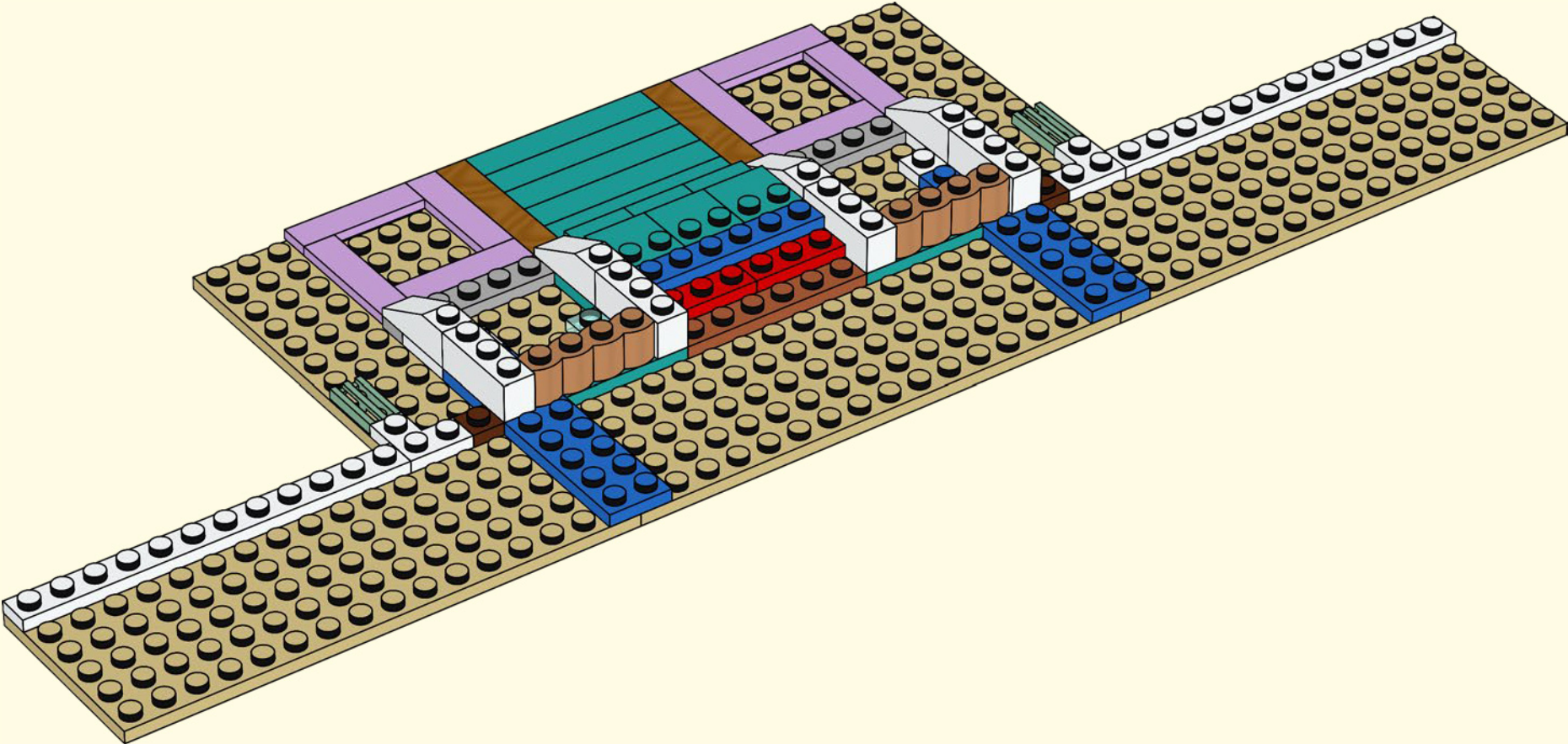



2x

16

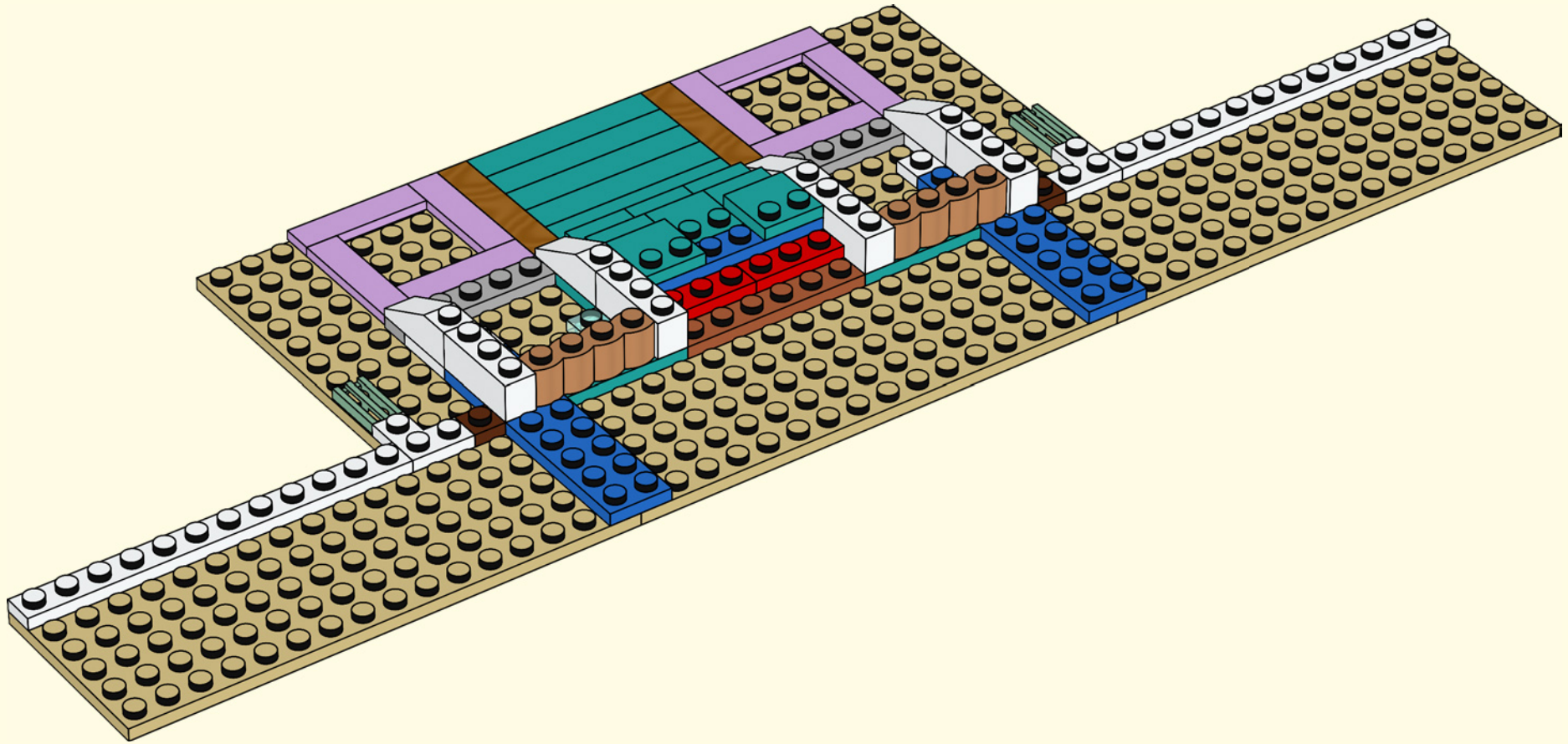





17

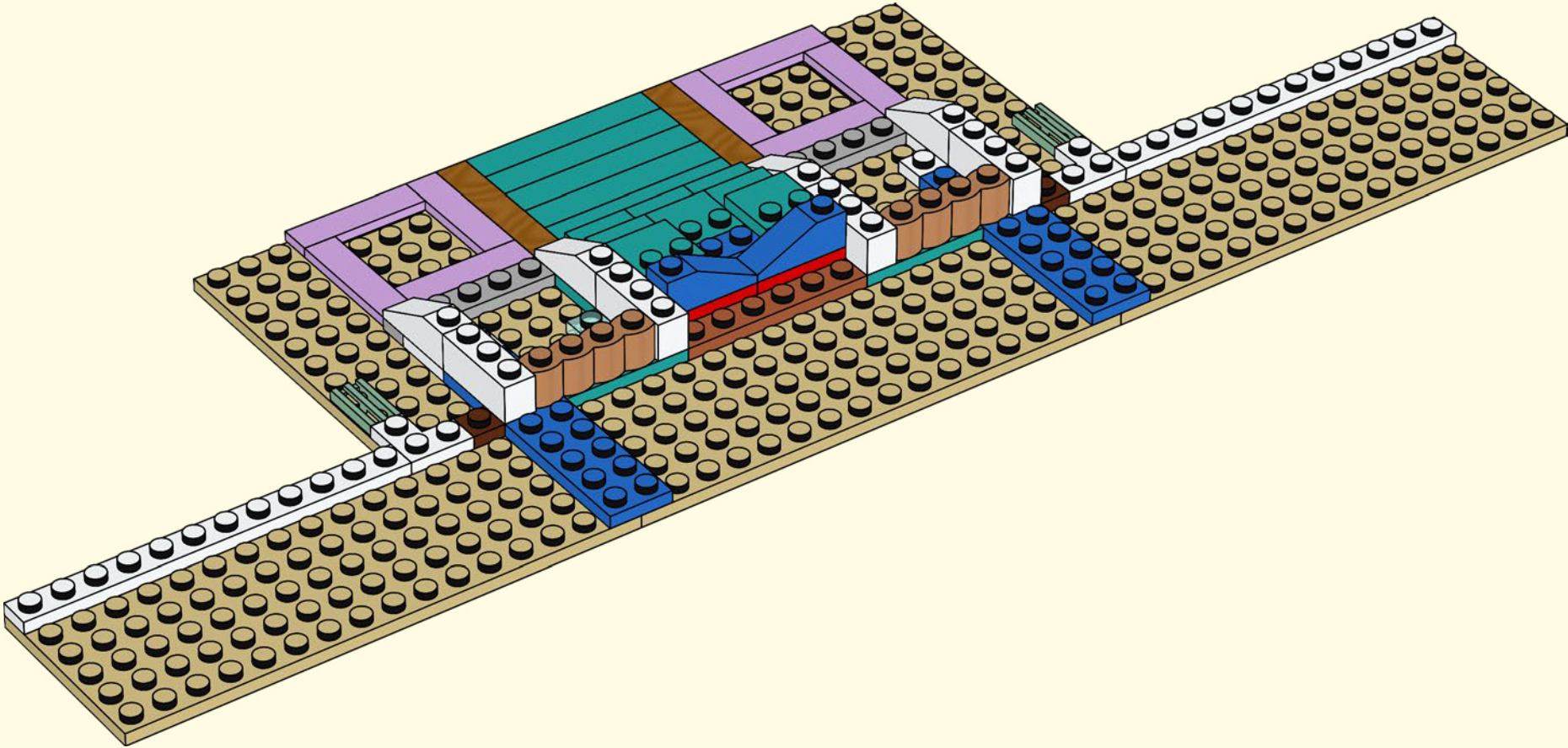

2x 2x

2x

18

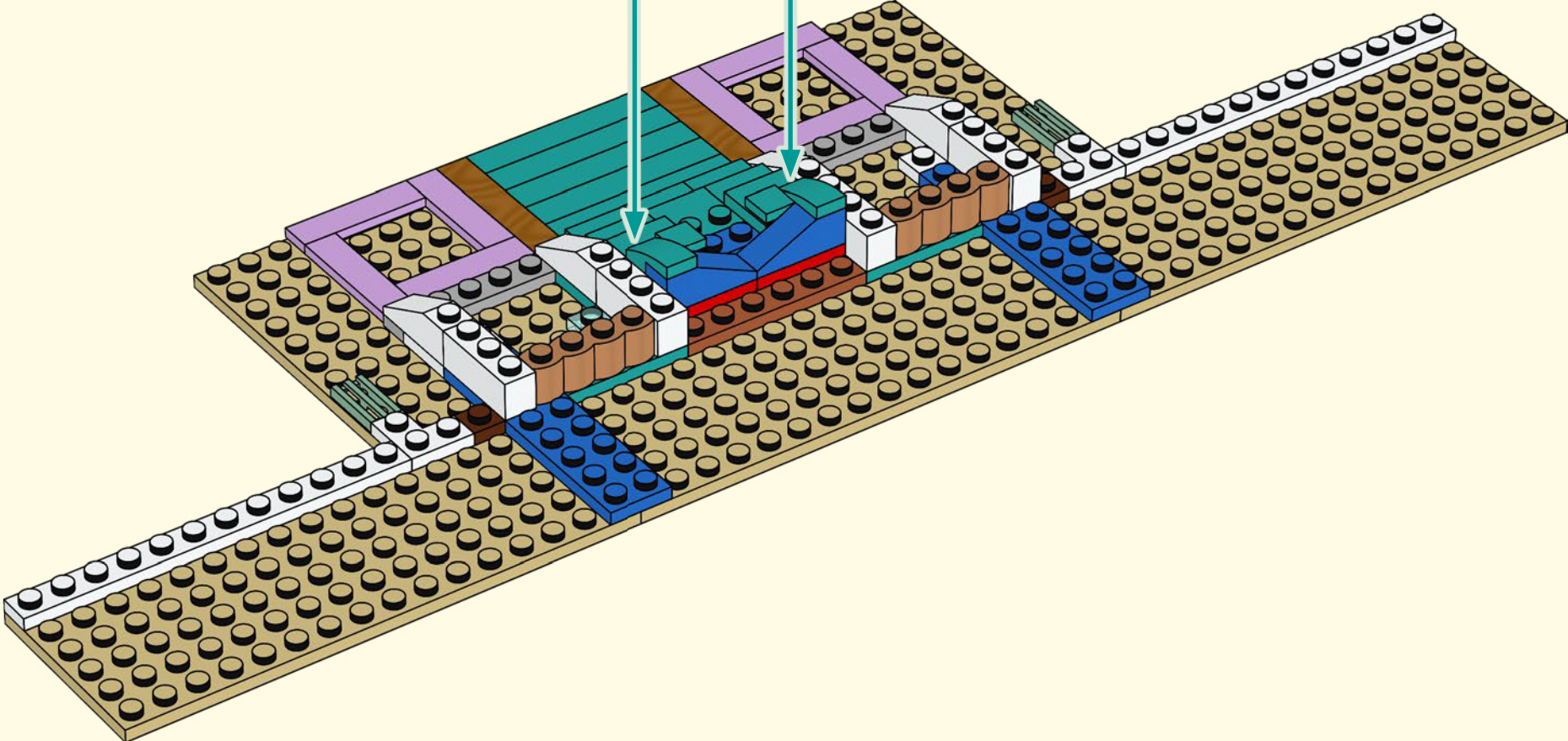





19

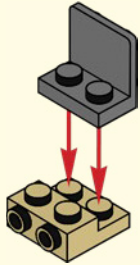

20

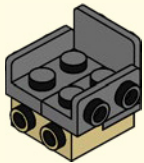

21

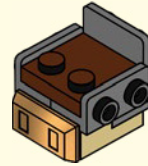

22

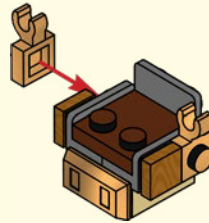

23

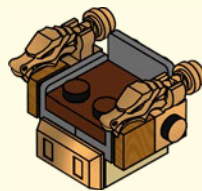

24

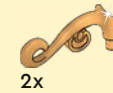
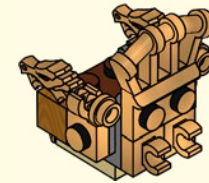
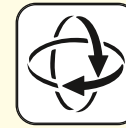

25



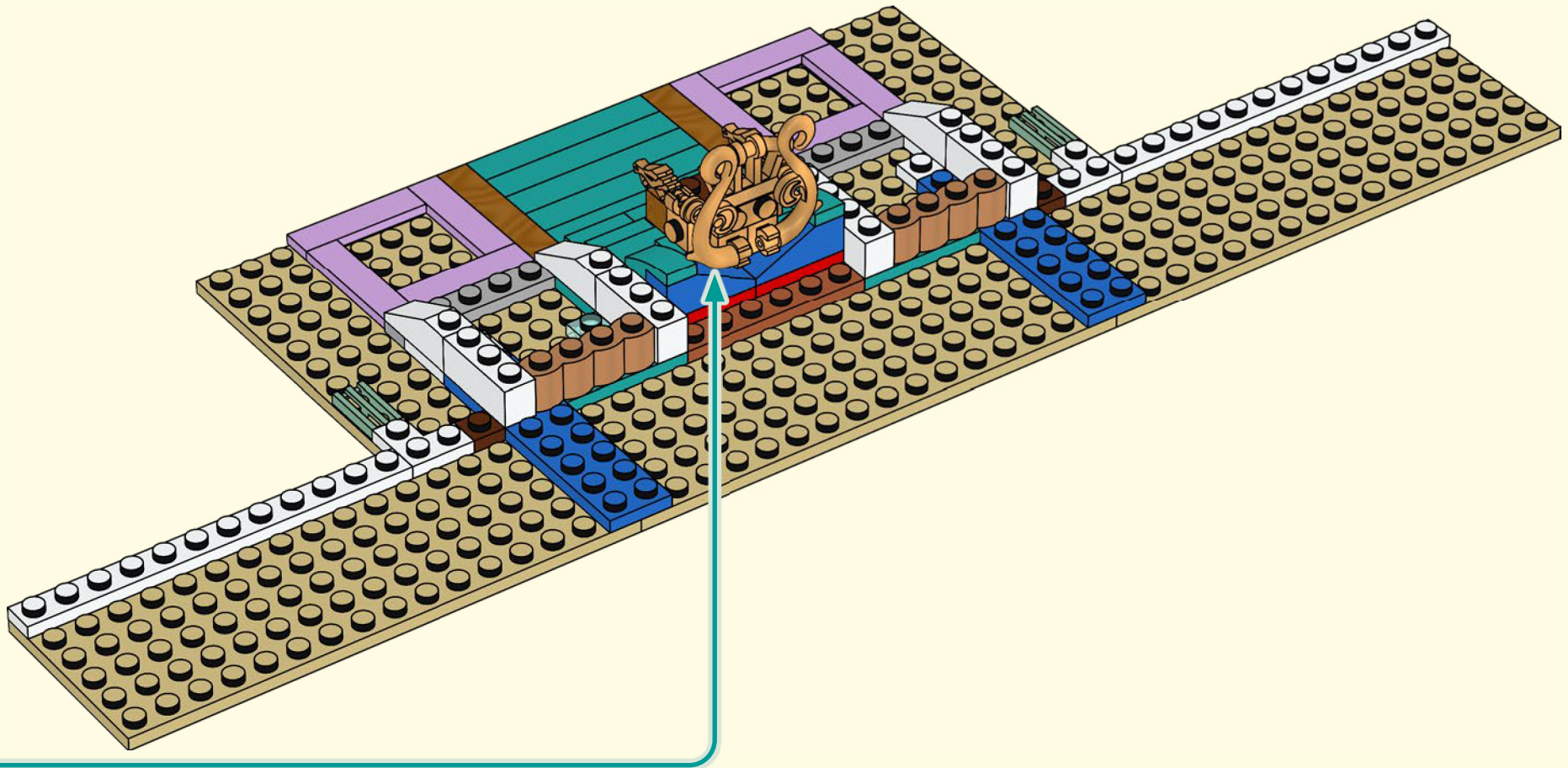





4x

27



4x

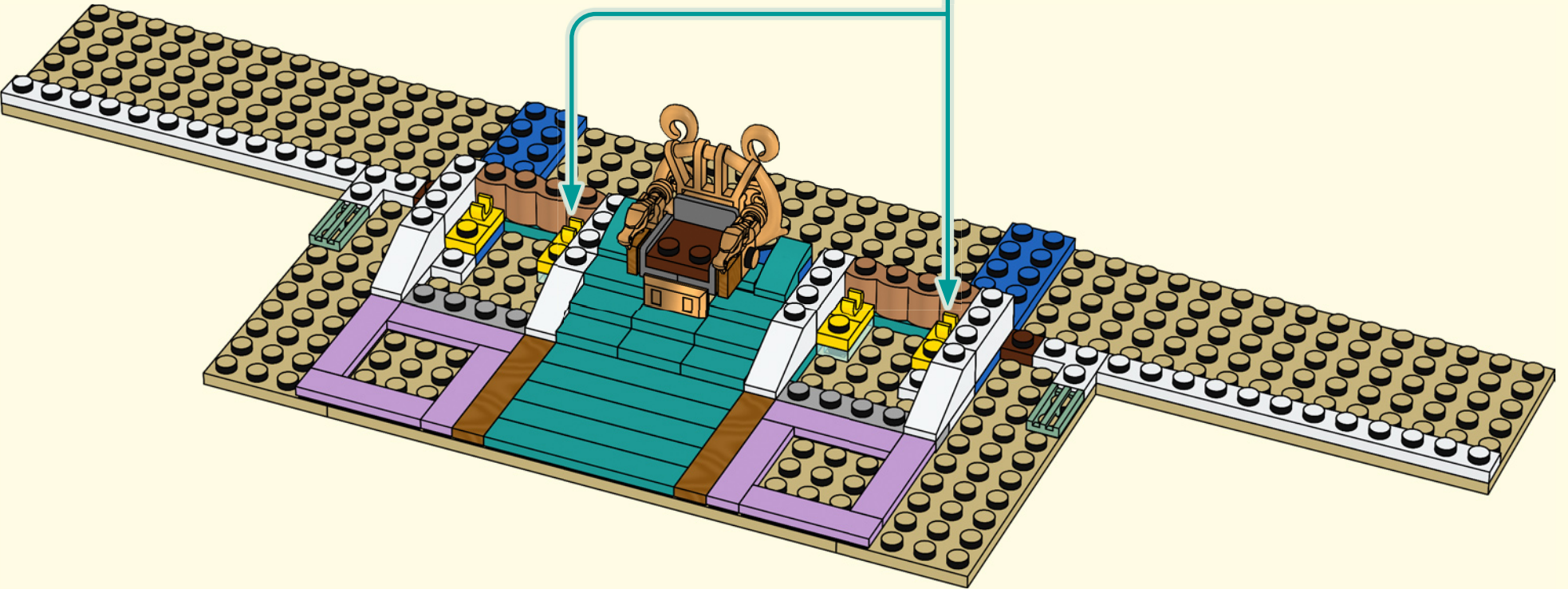

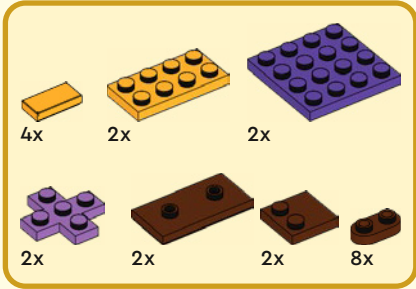
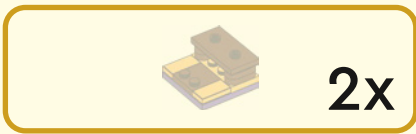

28

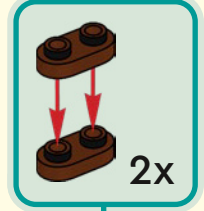
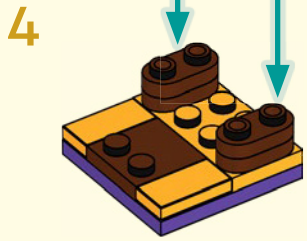
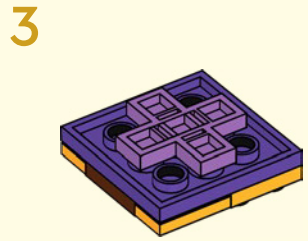
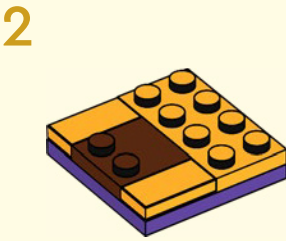
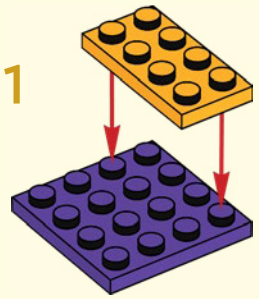



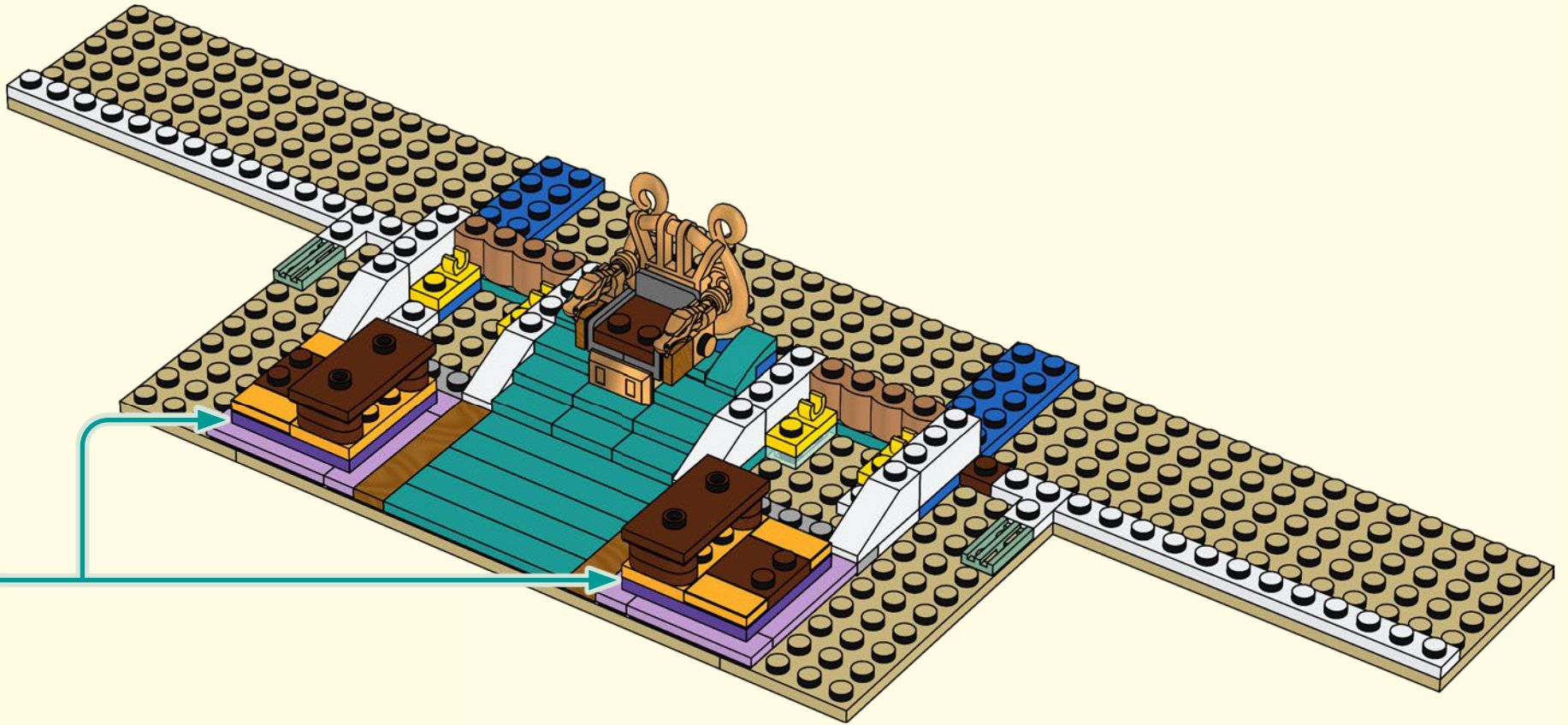



2x



2x

29









4x

30

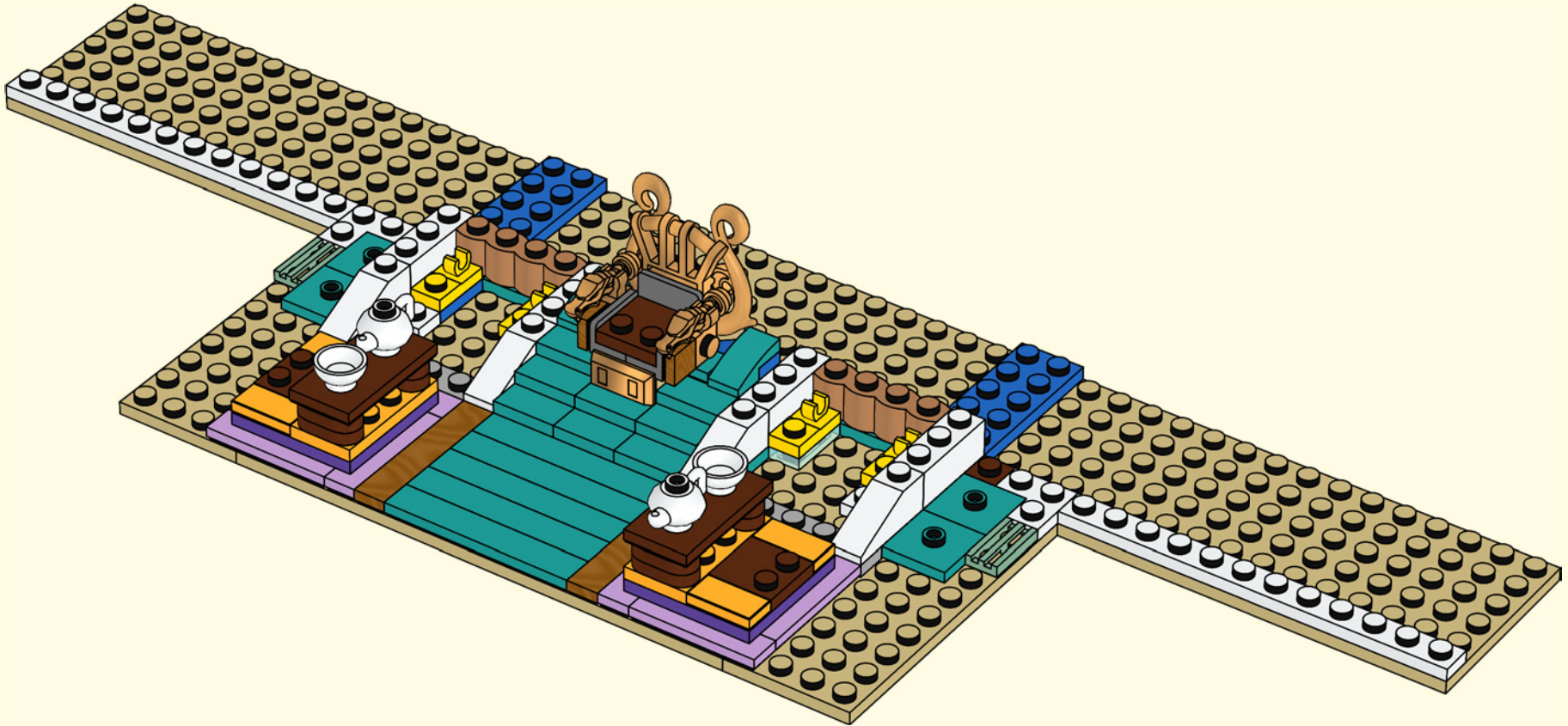



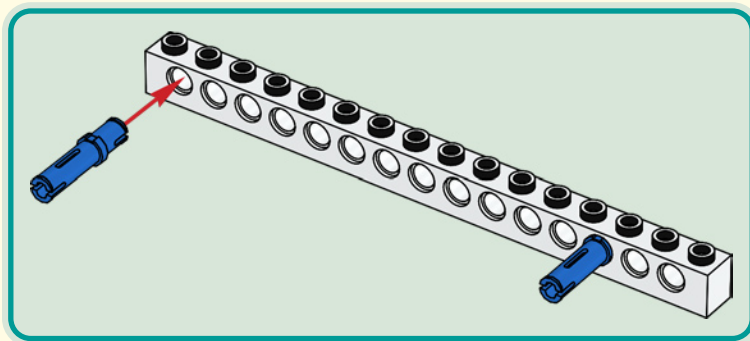
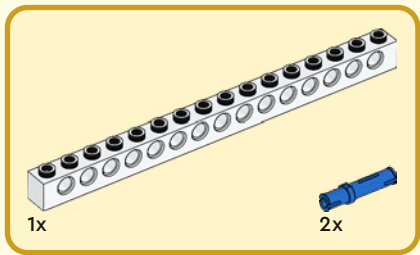

31



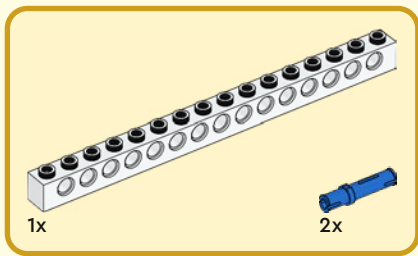

32





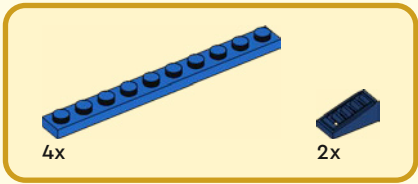

33

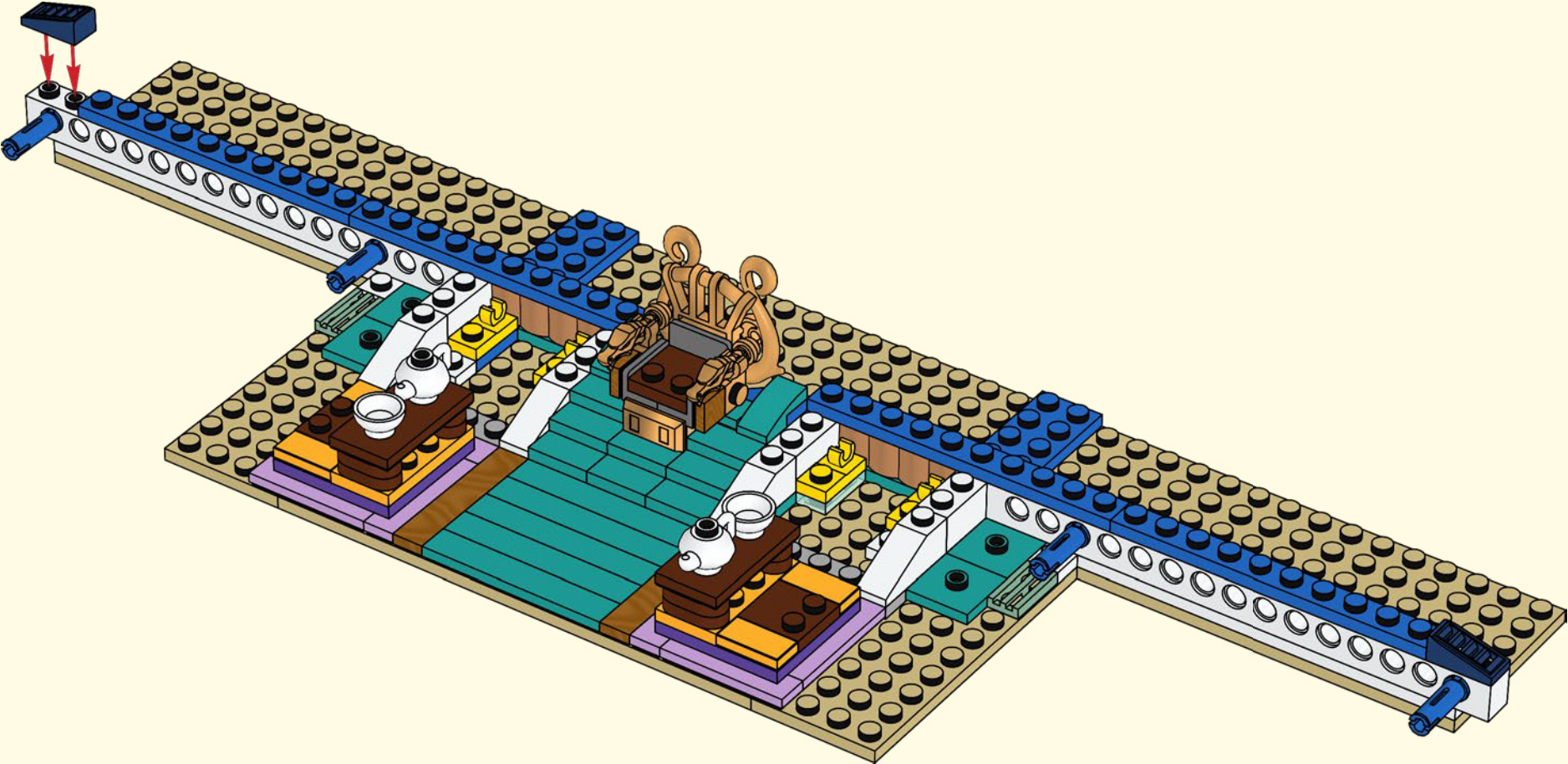



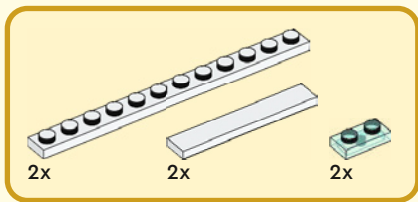

34



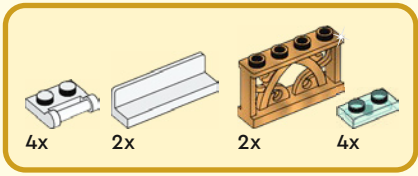

35

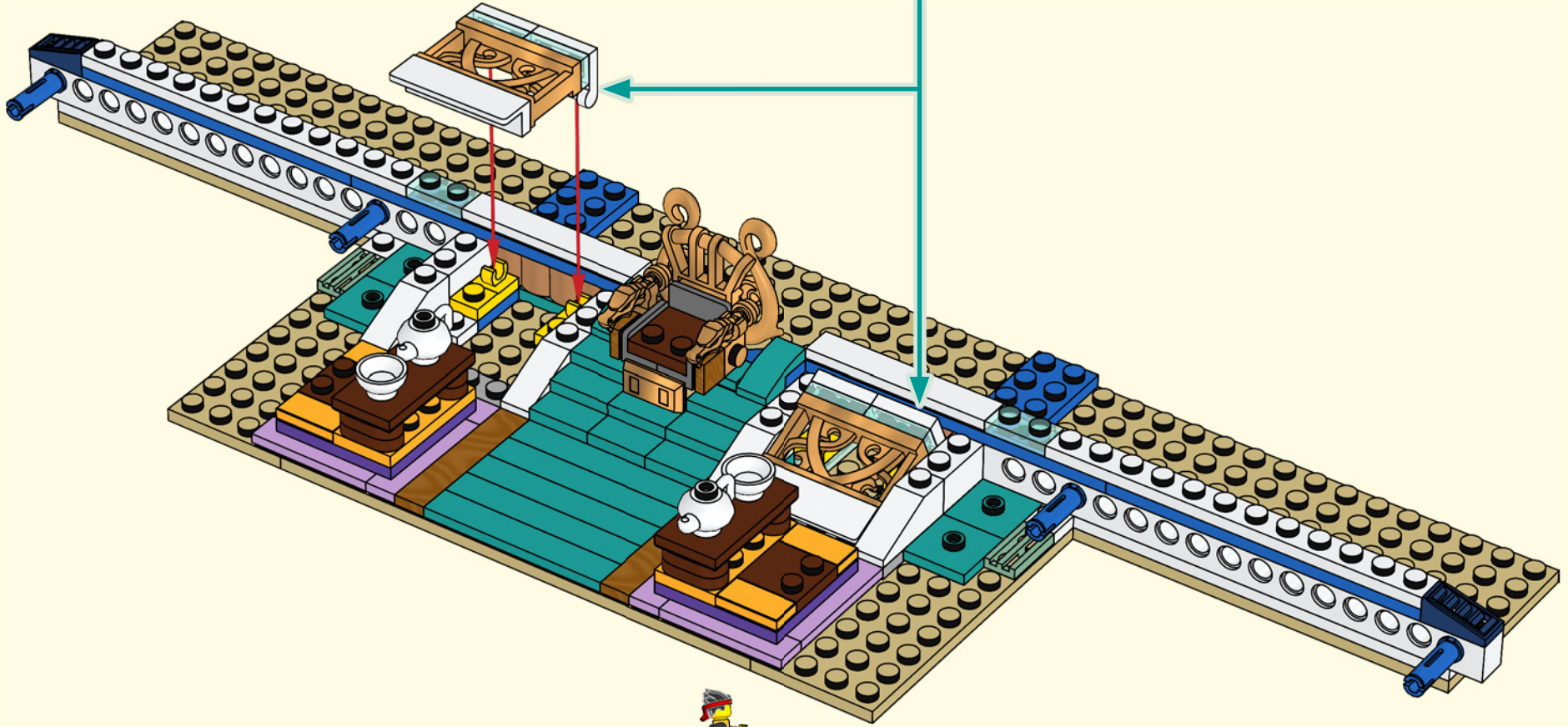
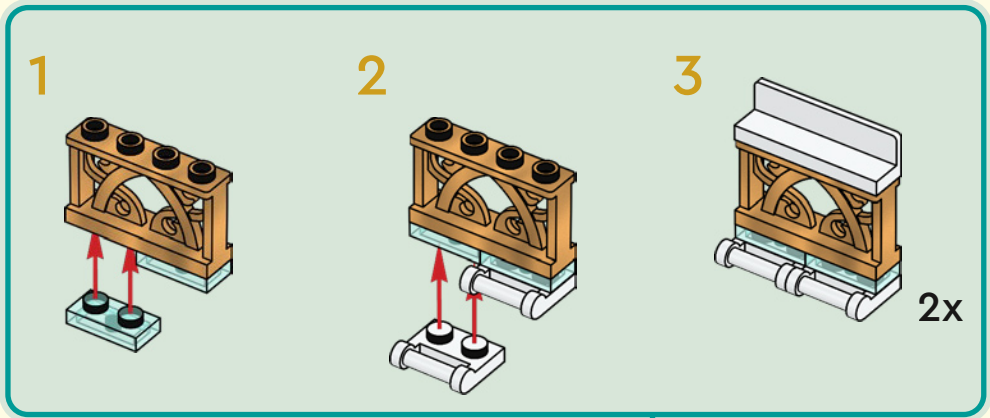



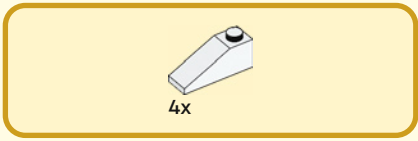

36



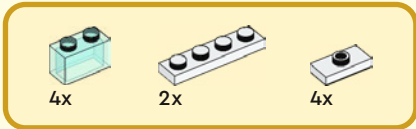

37

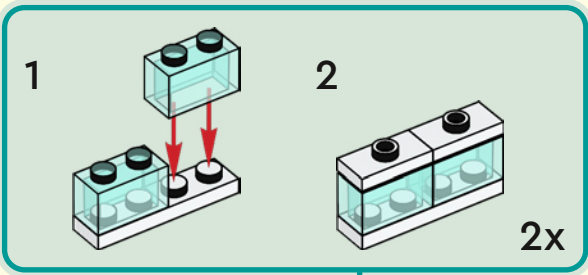





38

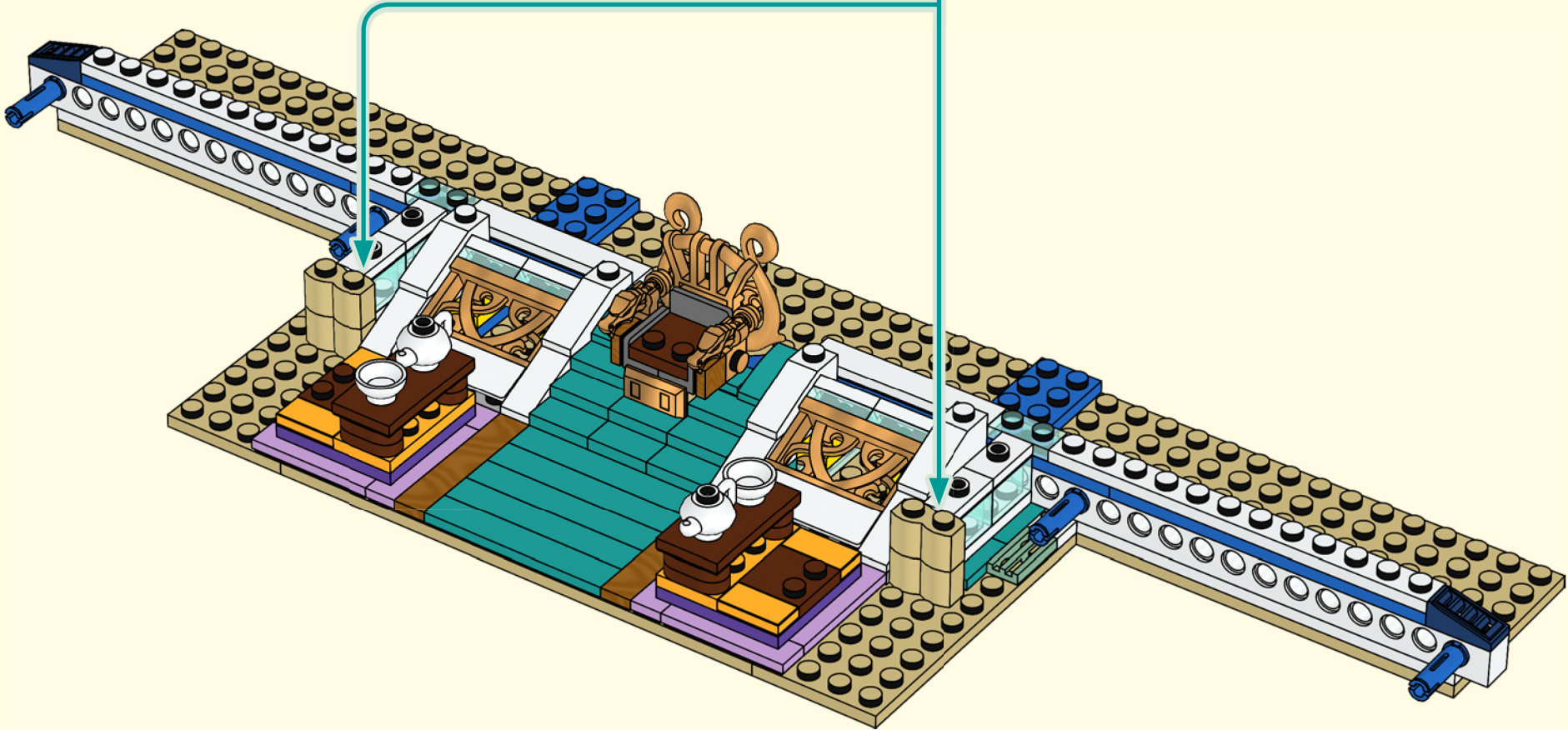
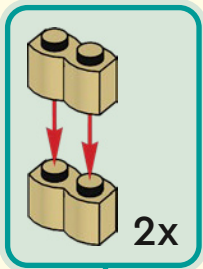



4x

39





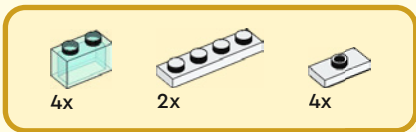

40

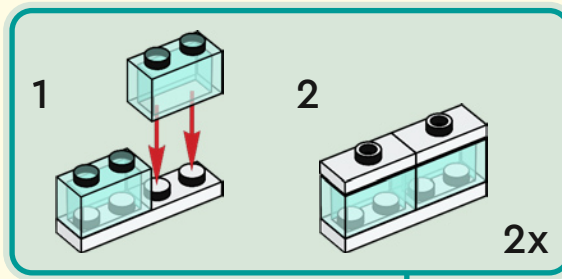



4x

41

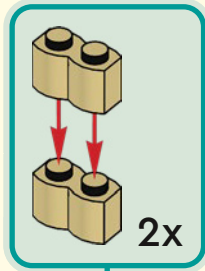

2x





42

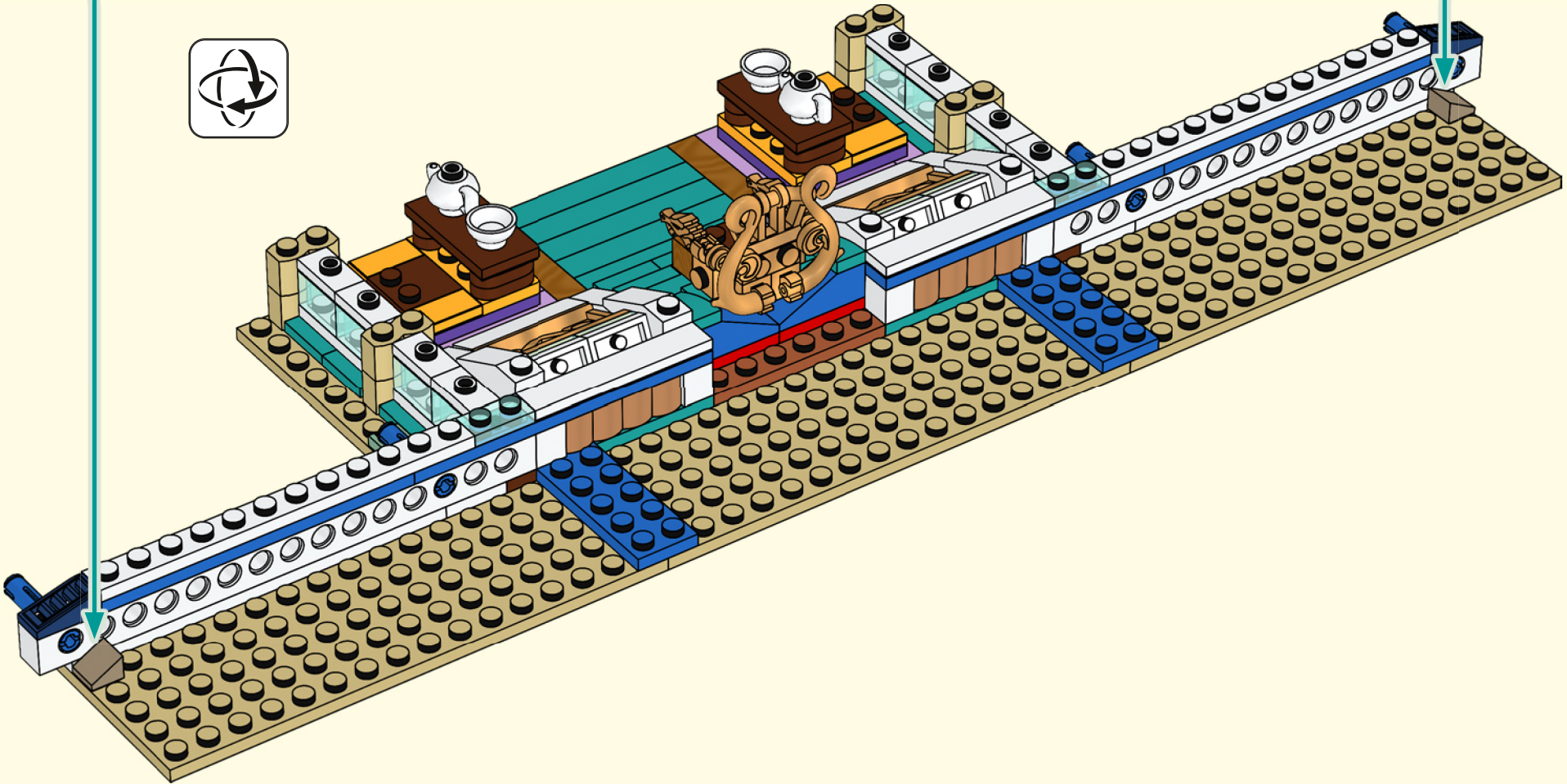





8x

43

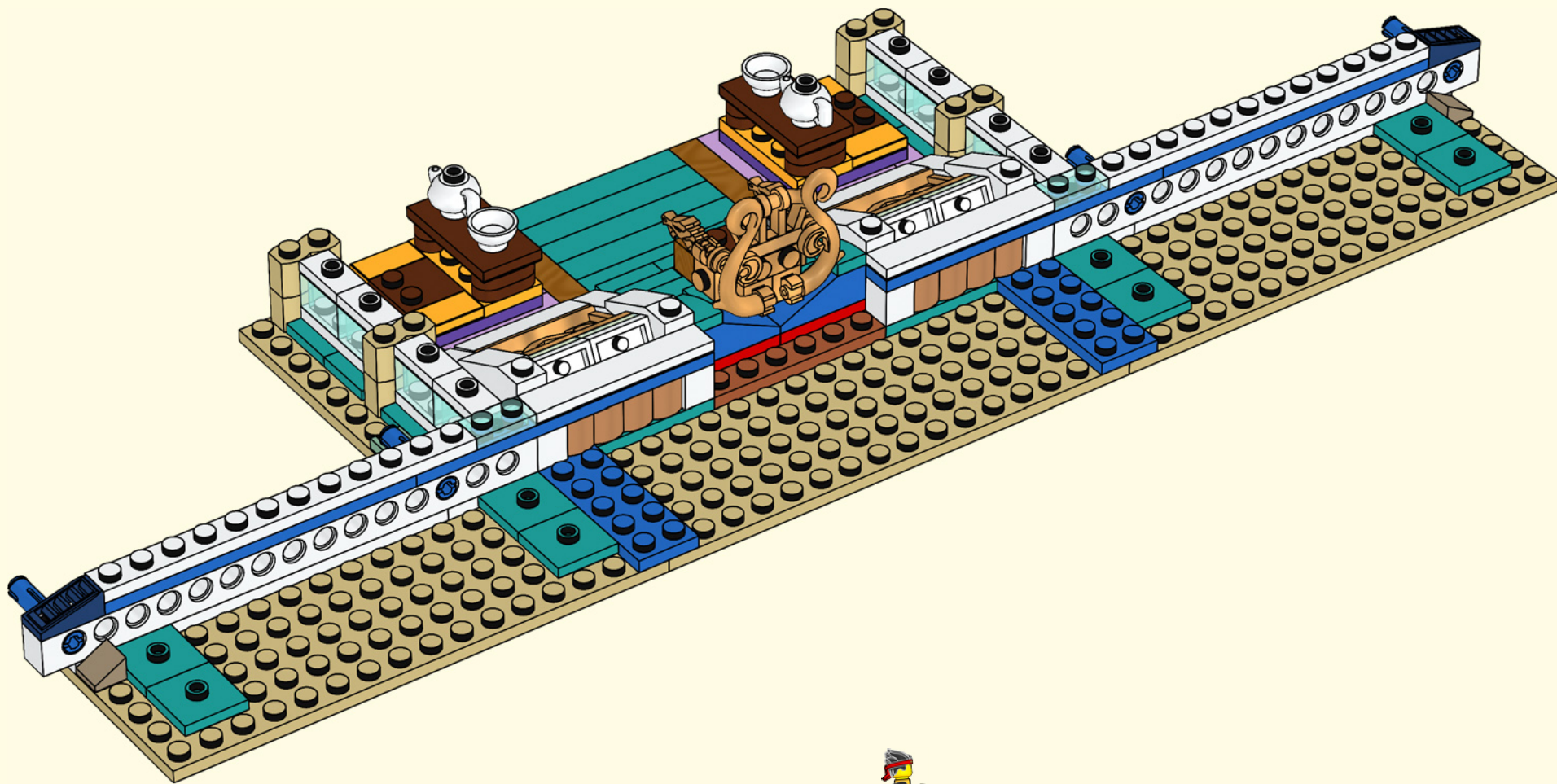

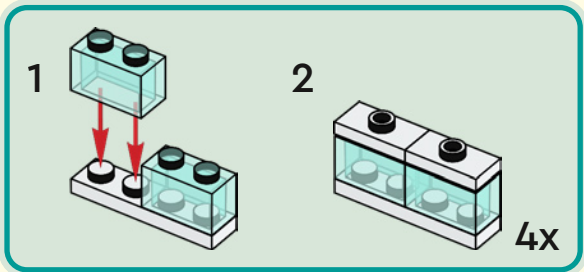
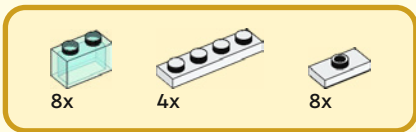

44

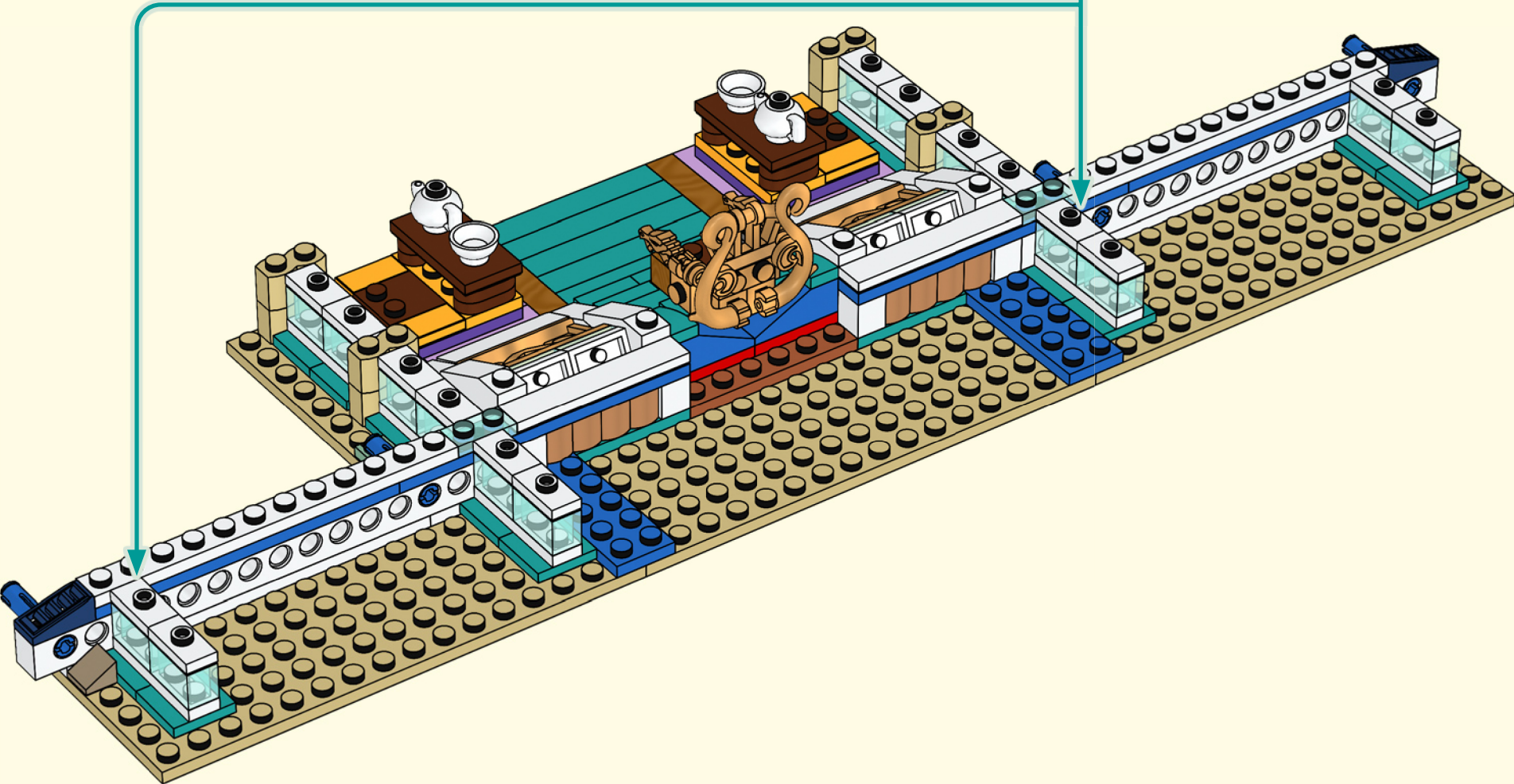





8x

45

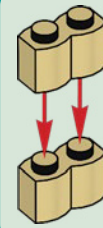

4x

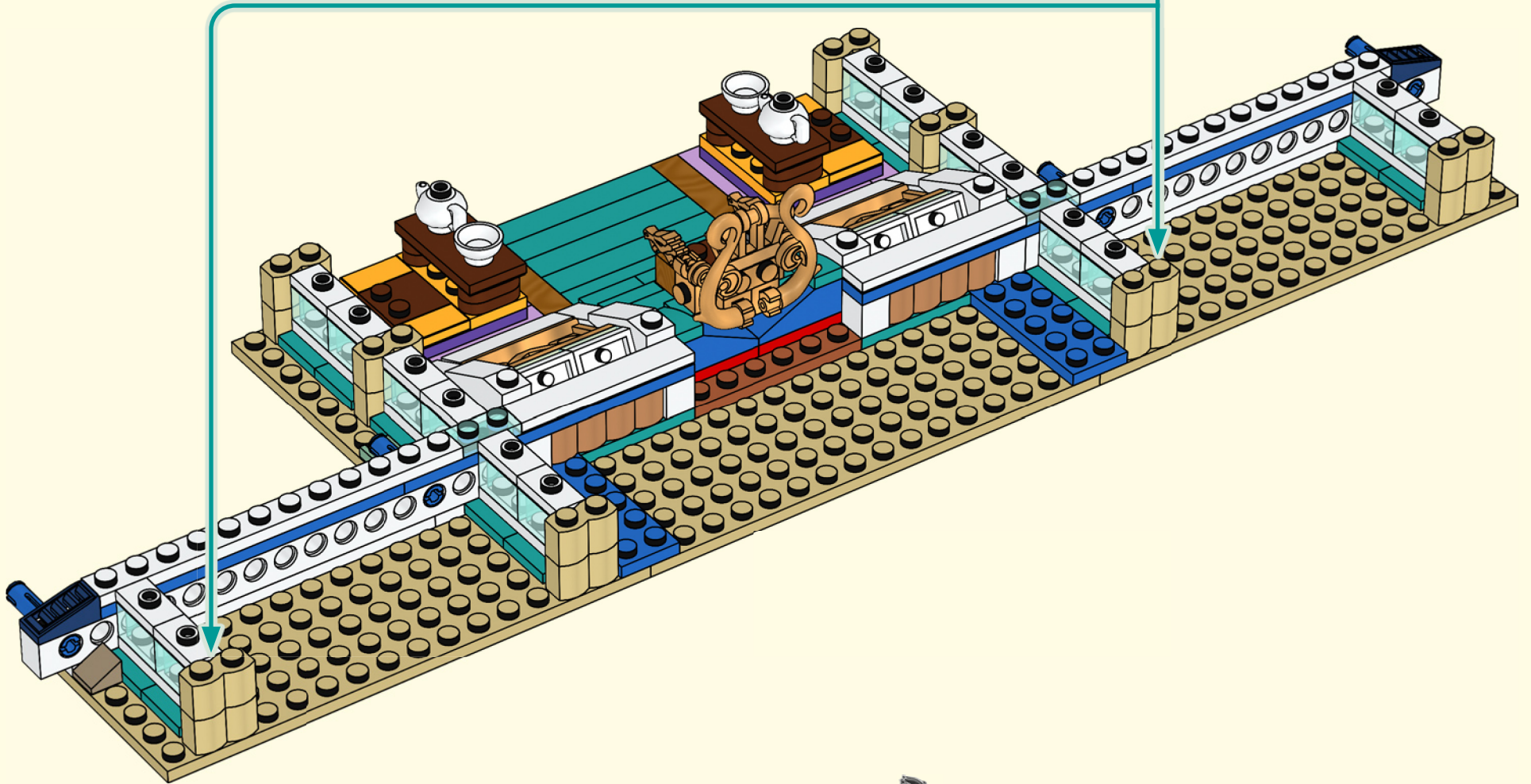



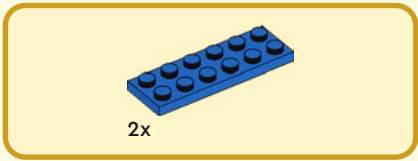

46

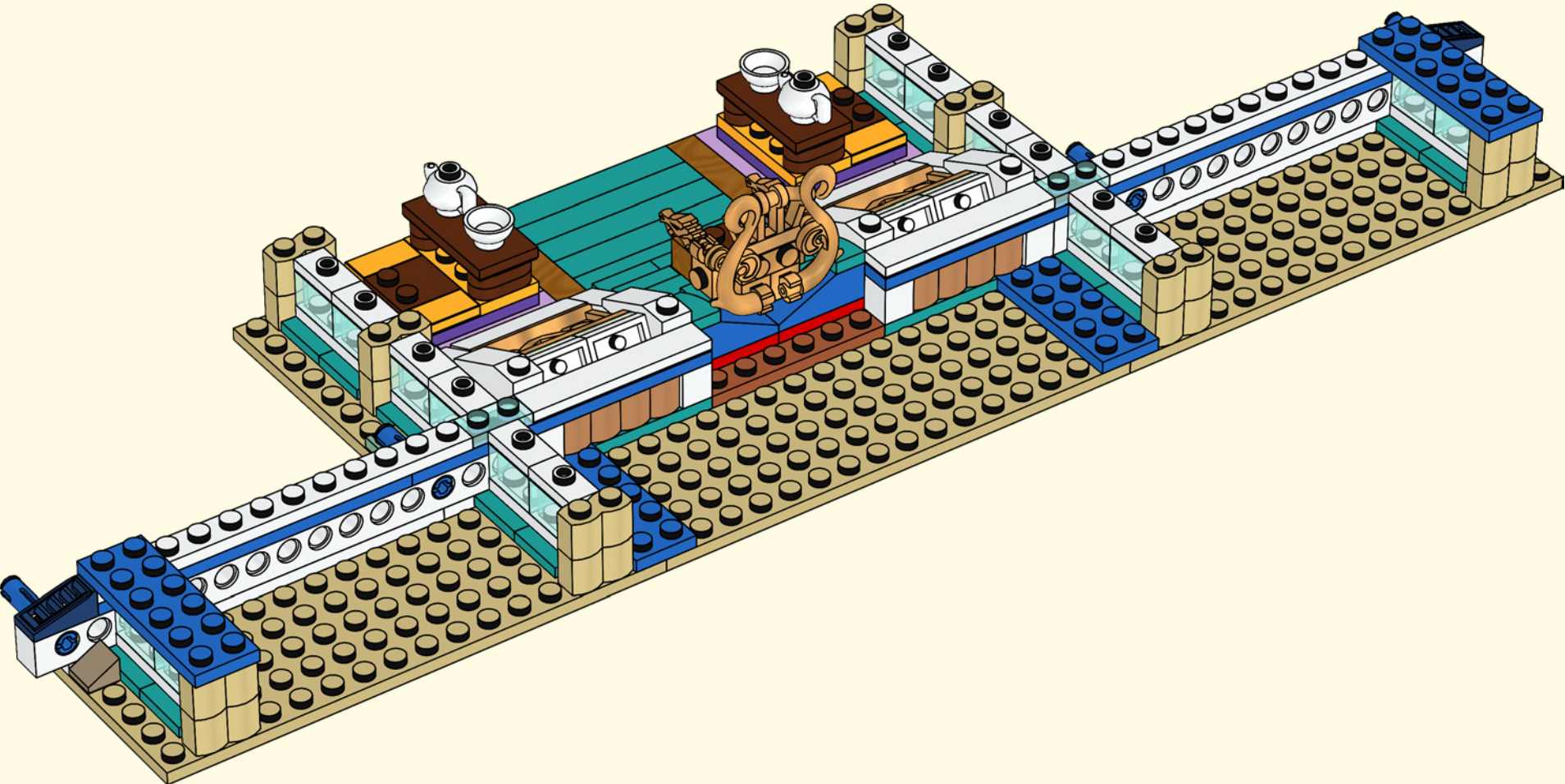

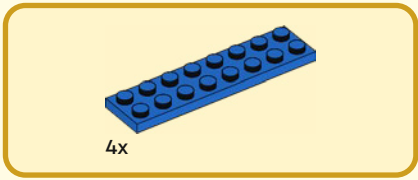

47

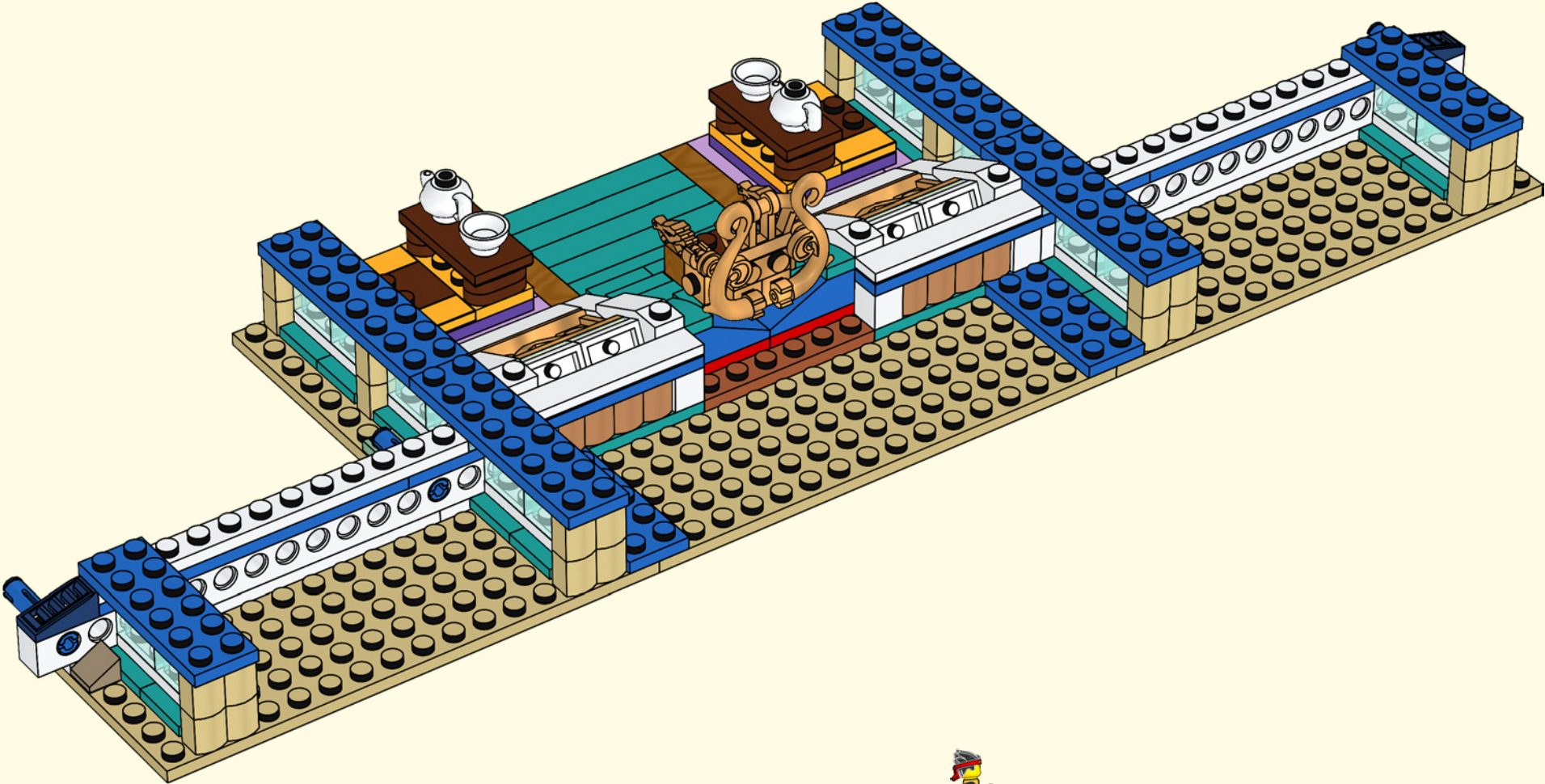





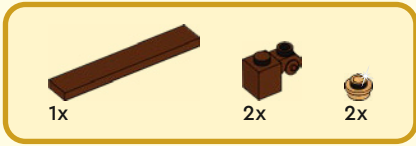

48

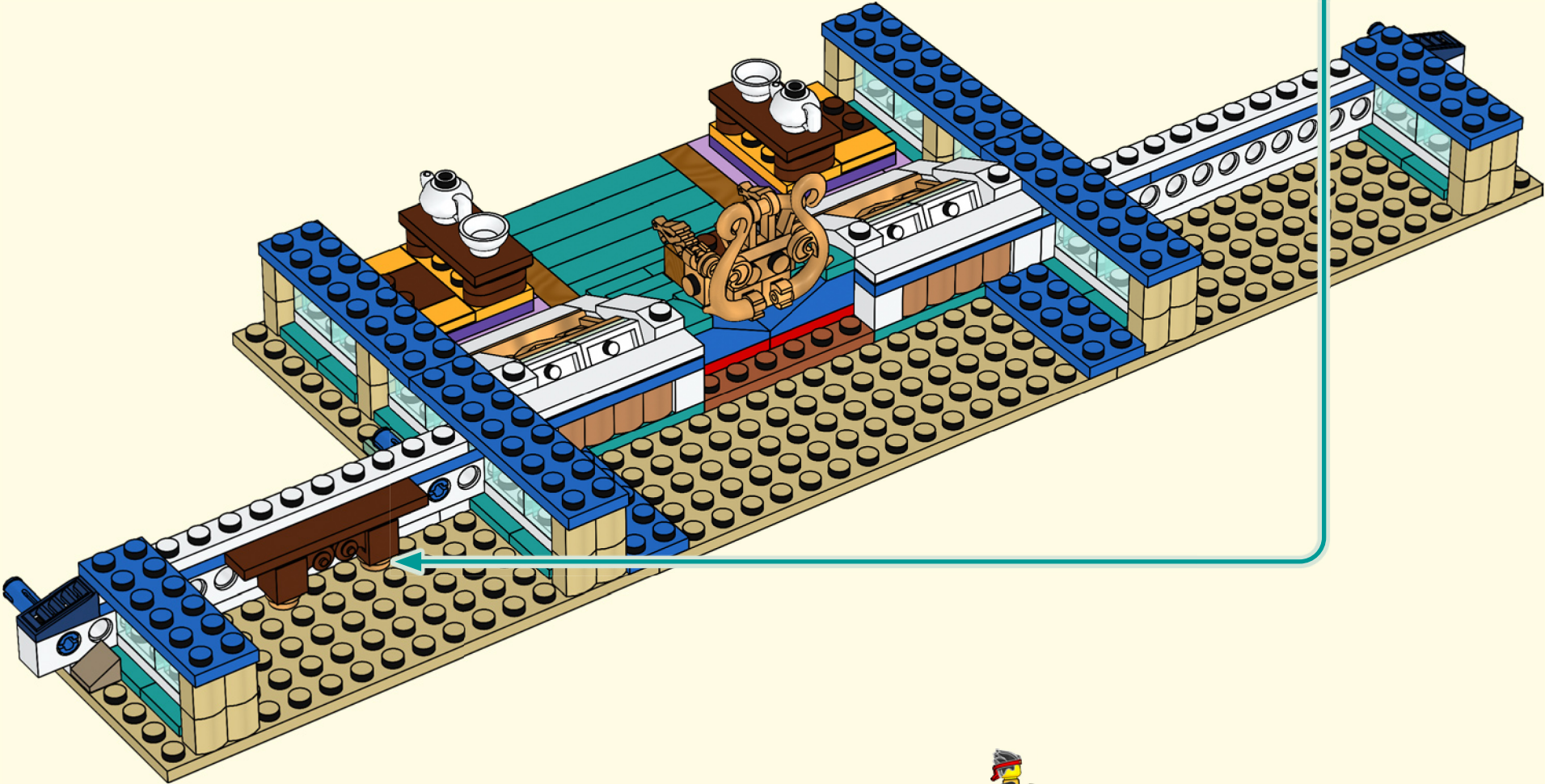
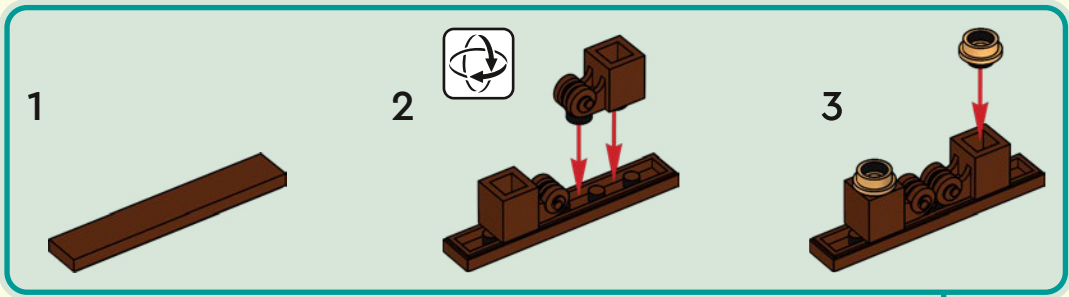





4x

49

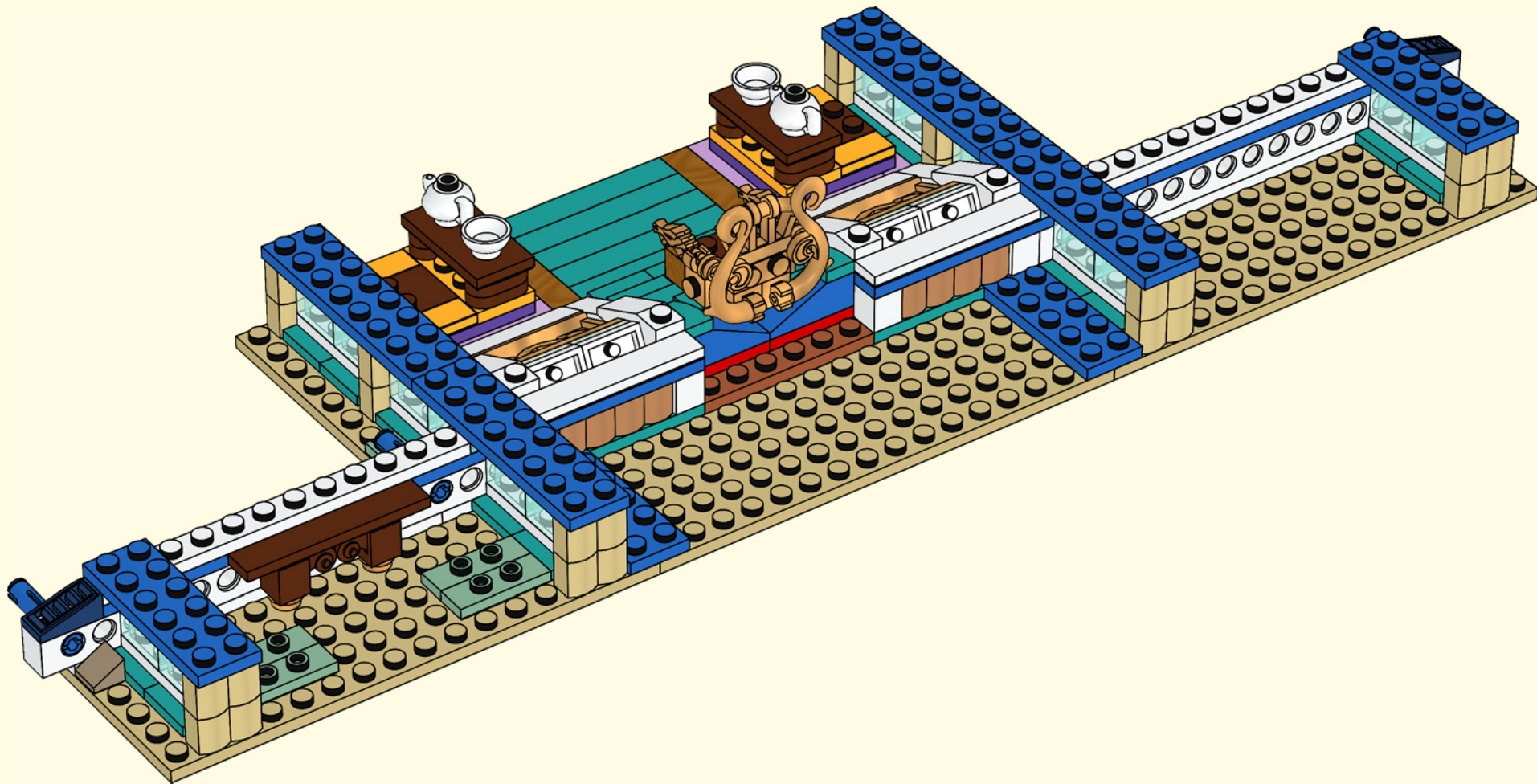

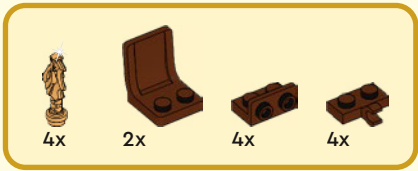

50

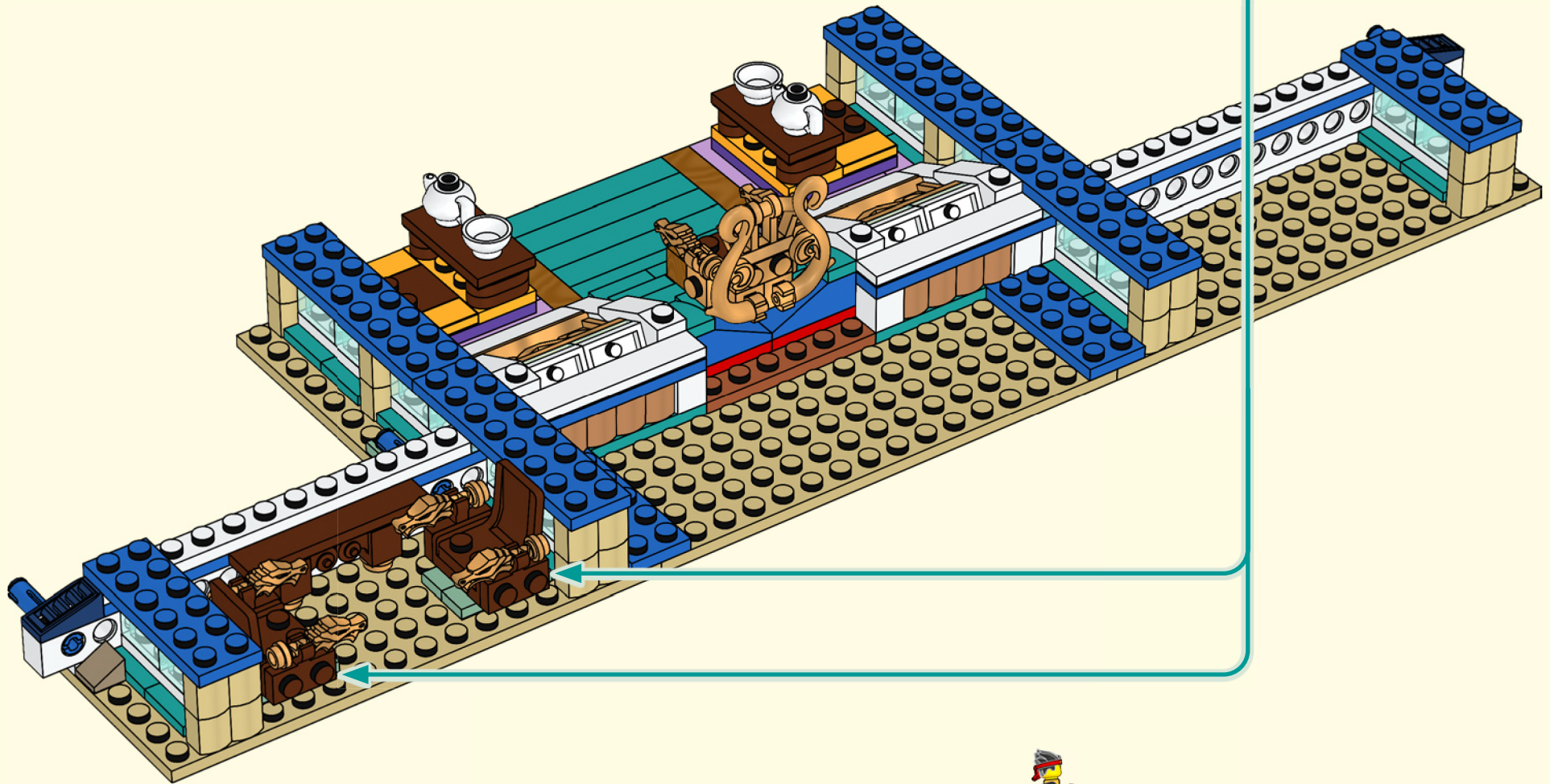
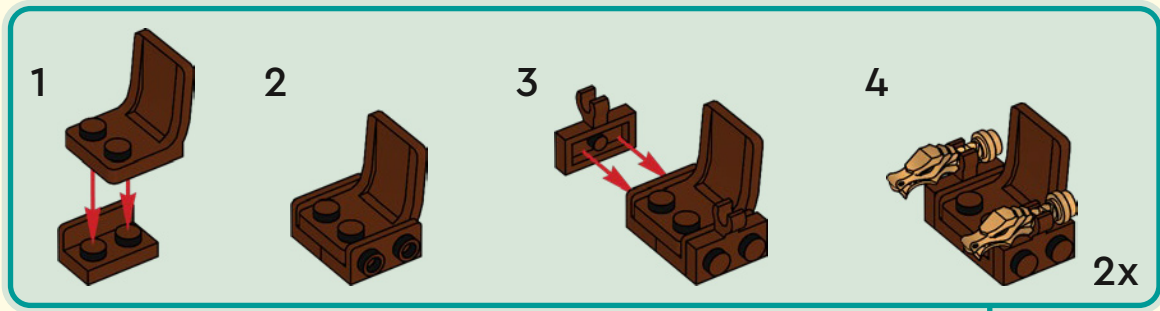



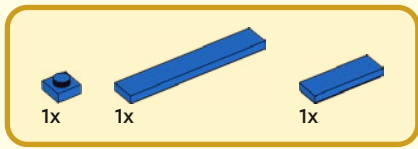

51

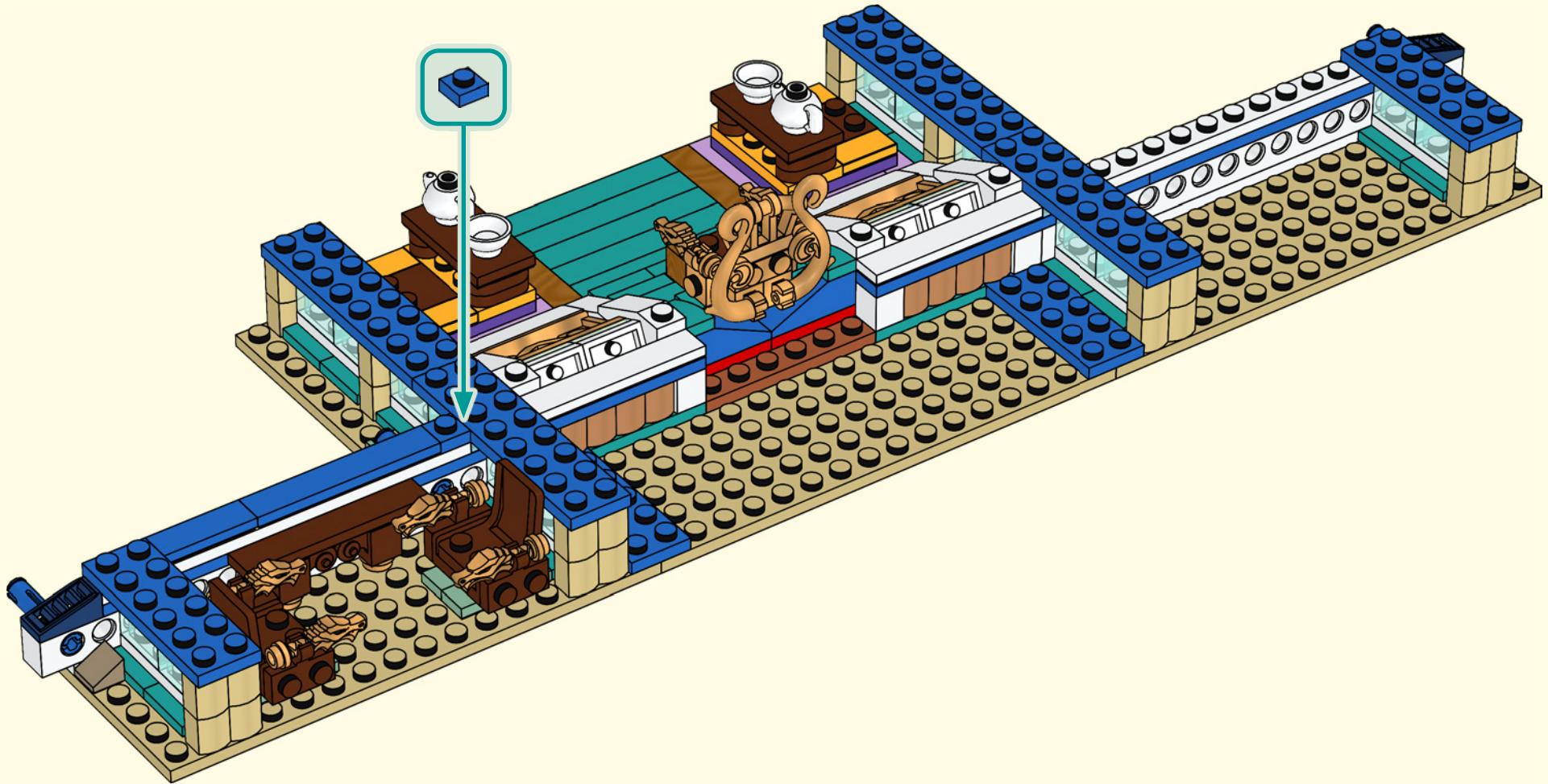



4x

52

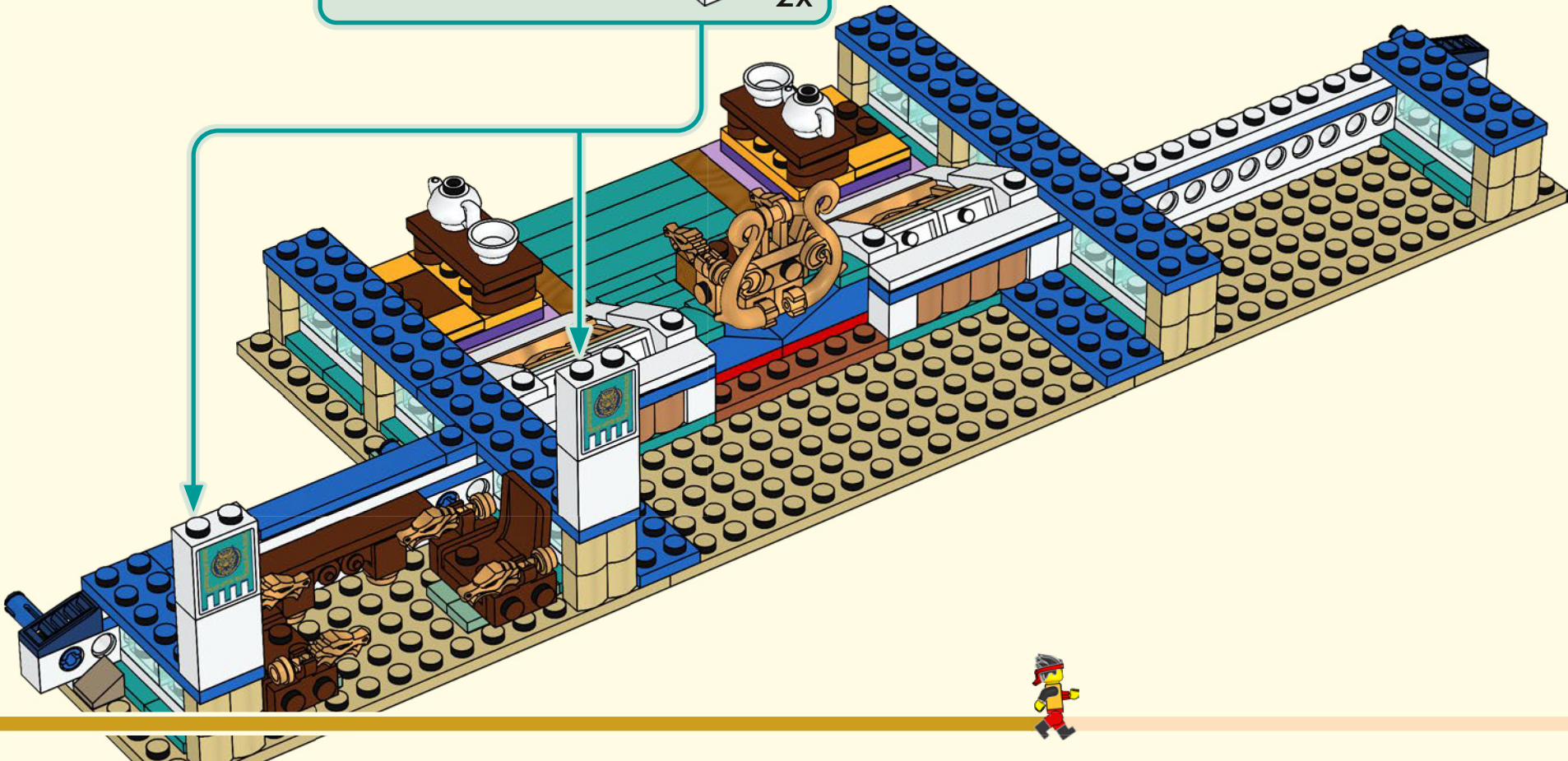
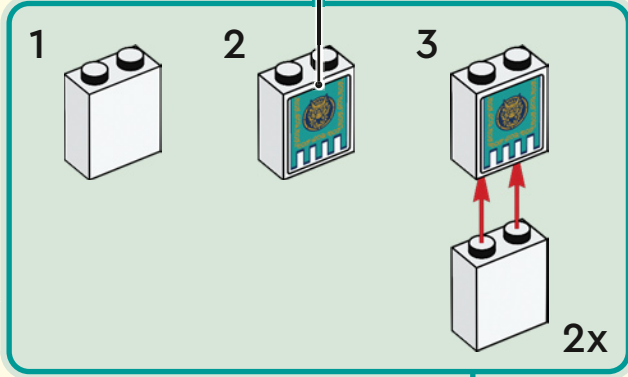



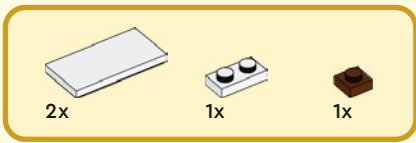

53

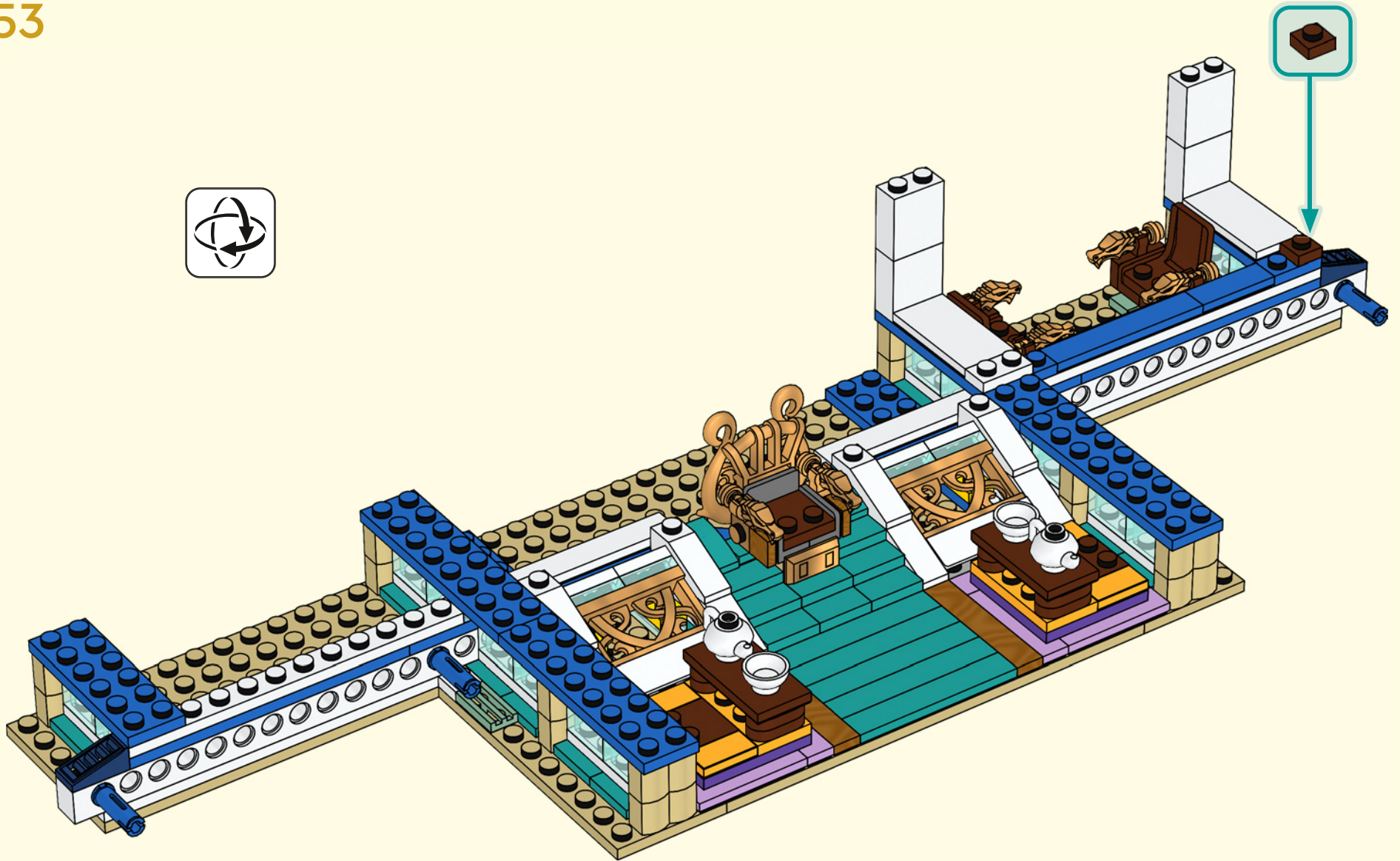



2x

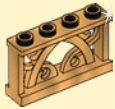

2x



2x



4x



2x



8x

54

1

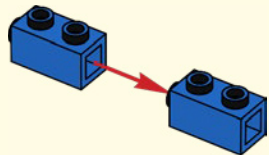

2

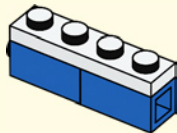

3

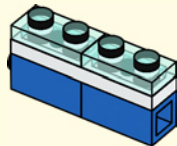

4

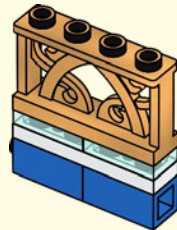

5

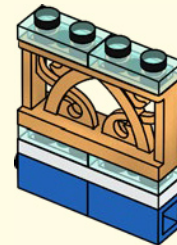

6



2x





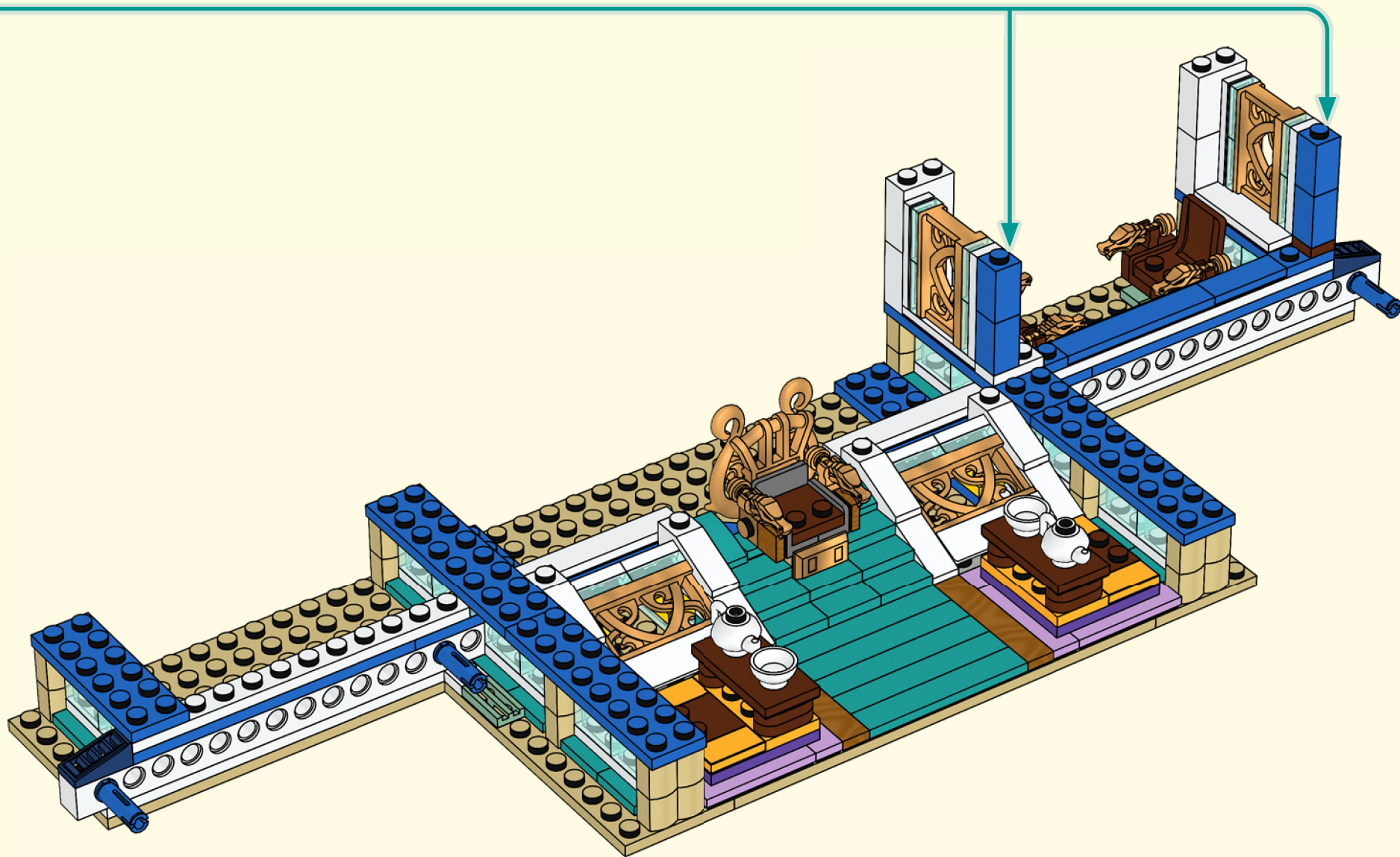

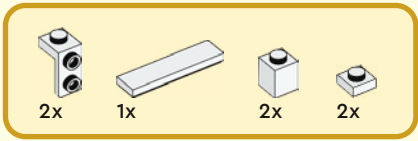

55

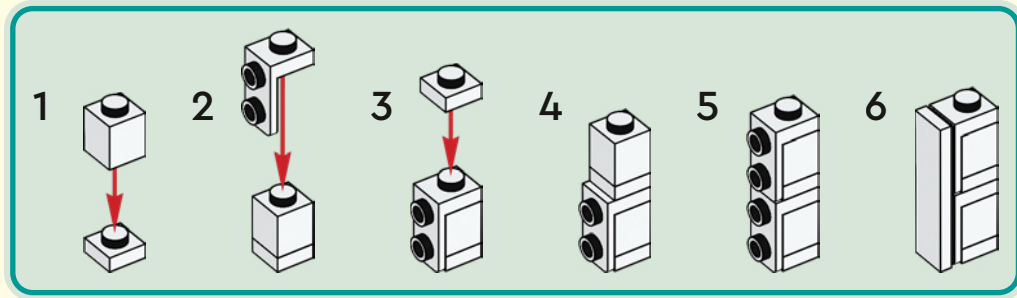





1x

56



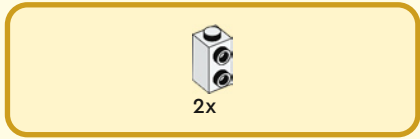

57

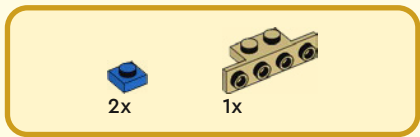
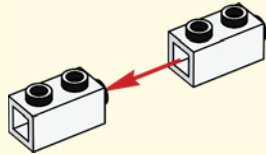

58

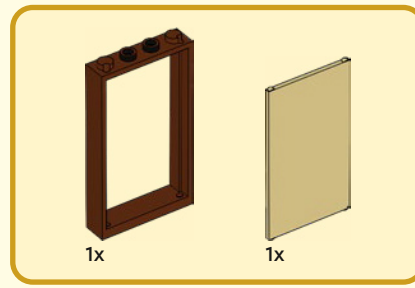
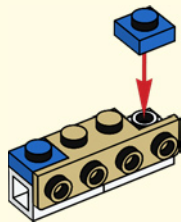

59

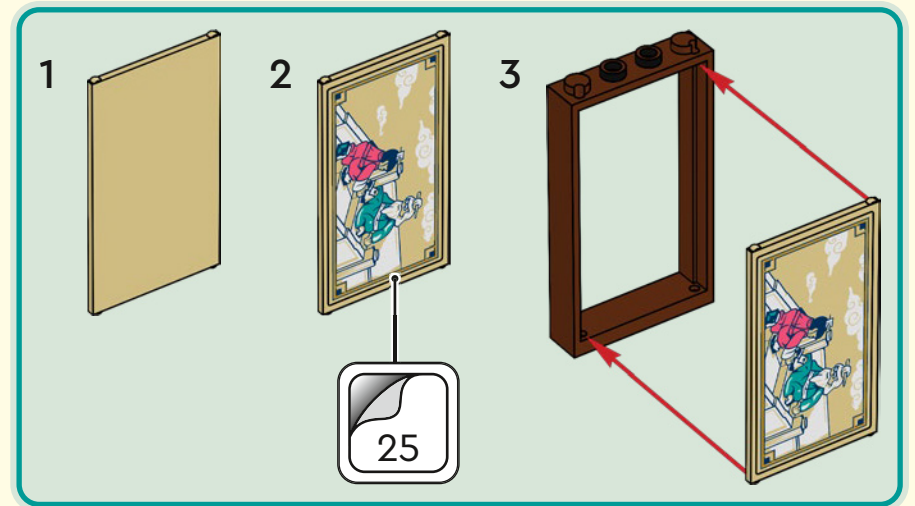



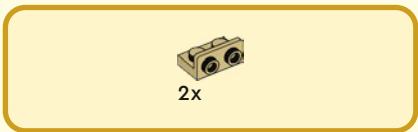

60

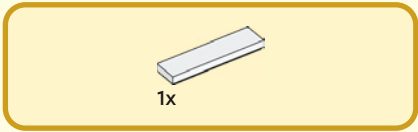

61



62

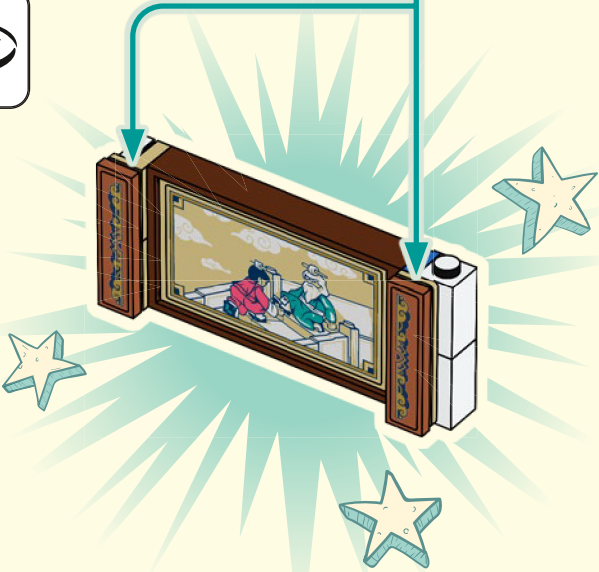
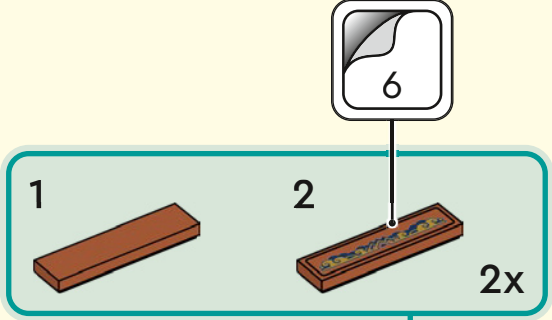





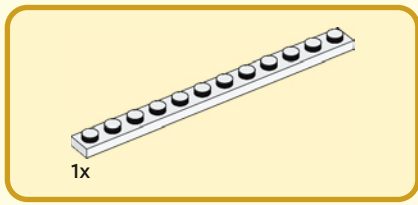

64



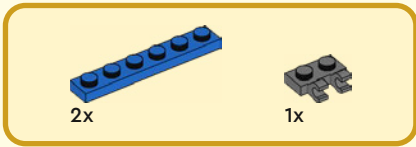

65

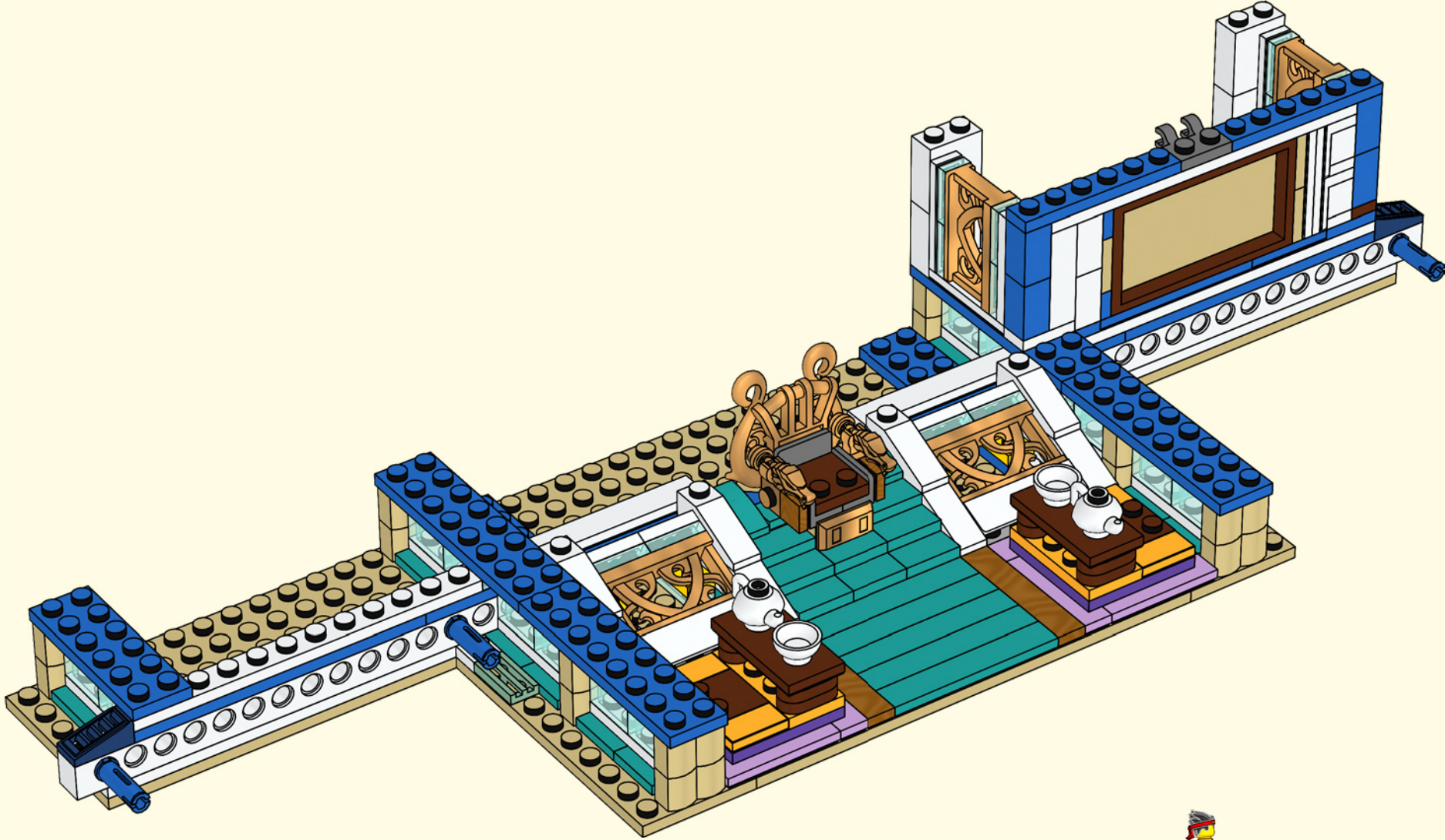



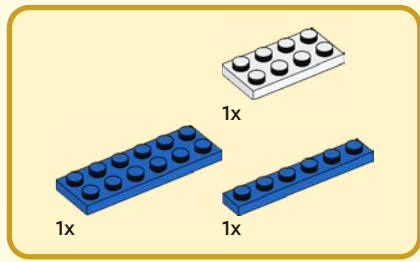

66

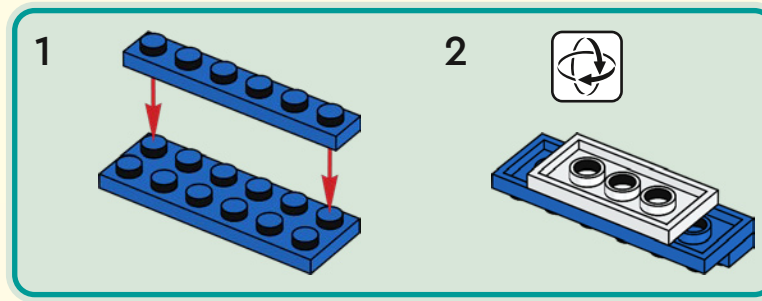



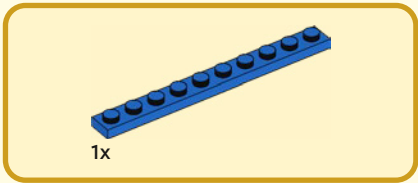

67





68

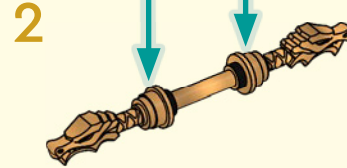
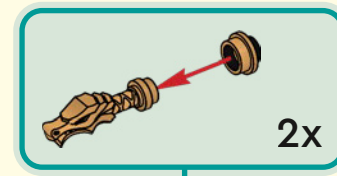





2x



2x

69



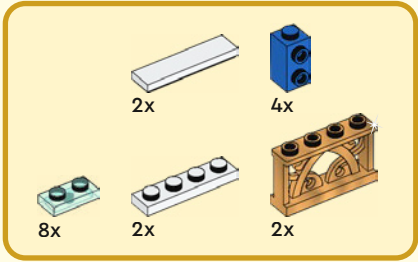

70

1

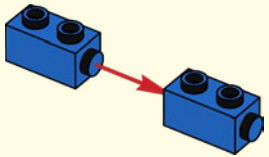

2

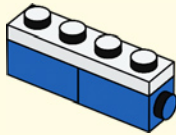

3

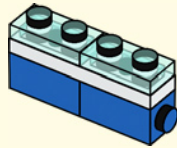

4

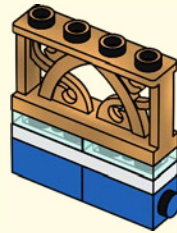

5

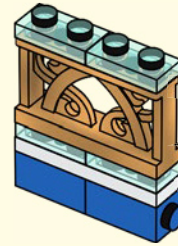

6





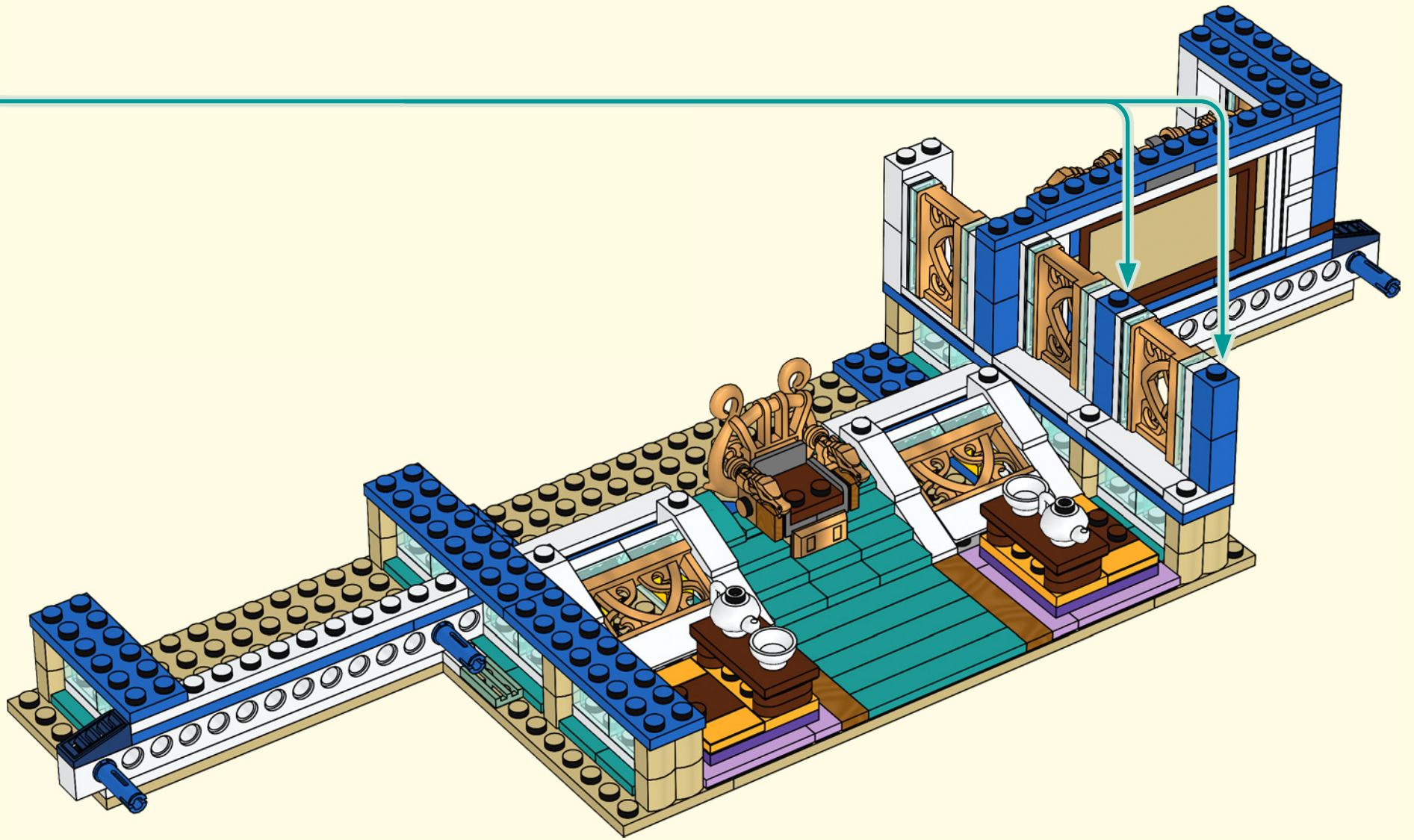

2x 2x 4x

71

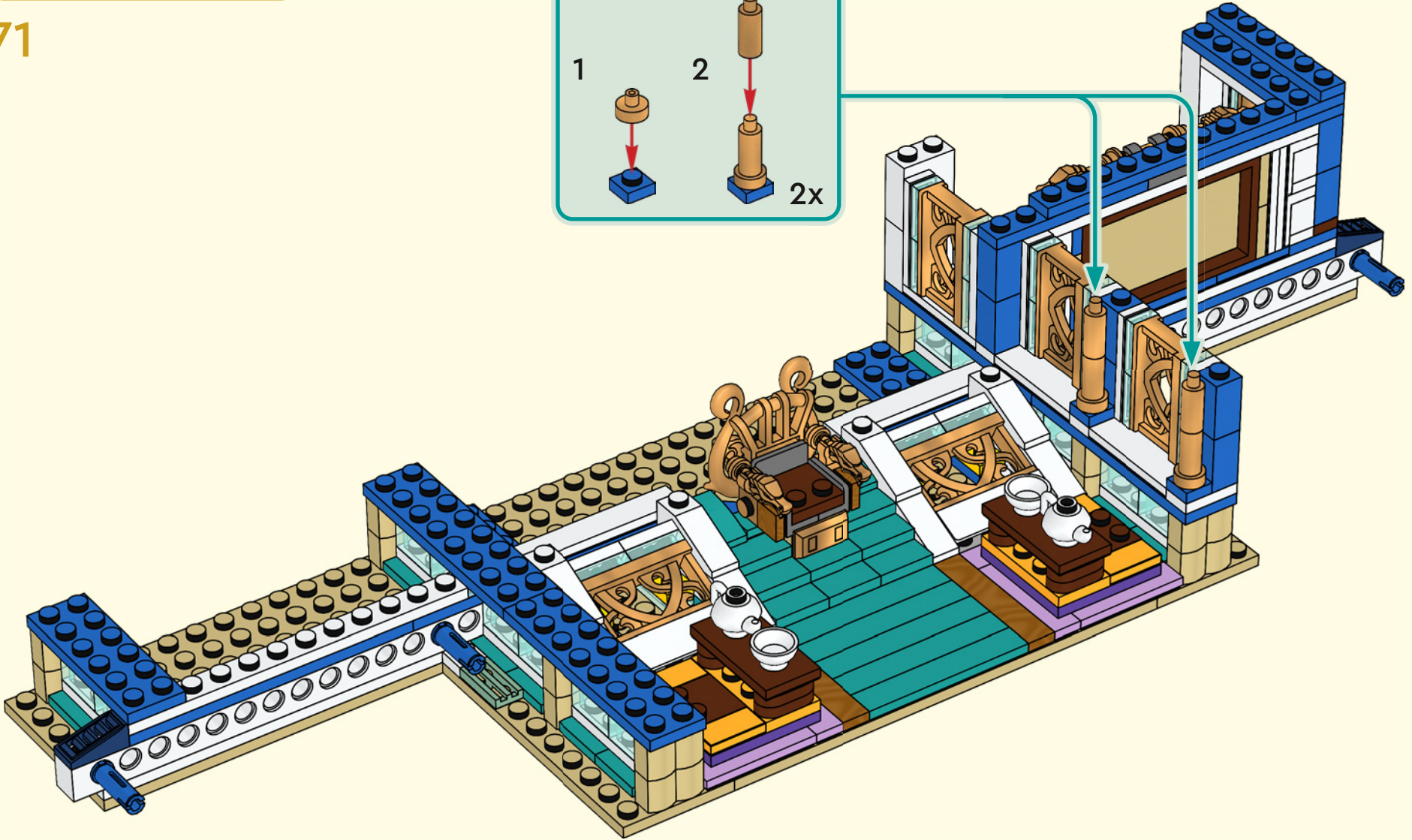
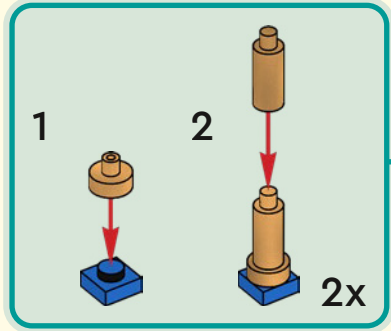





2x

72

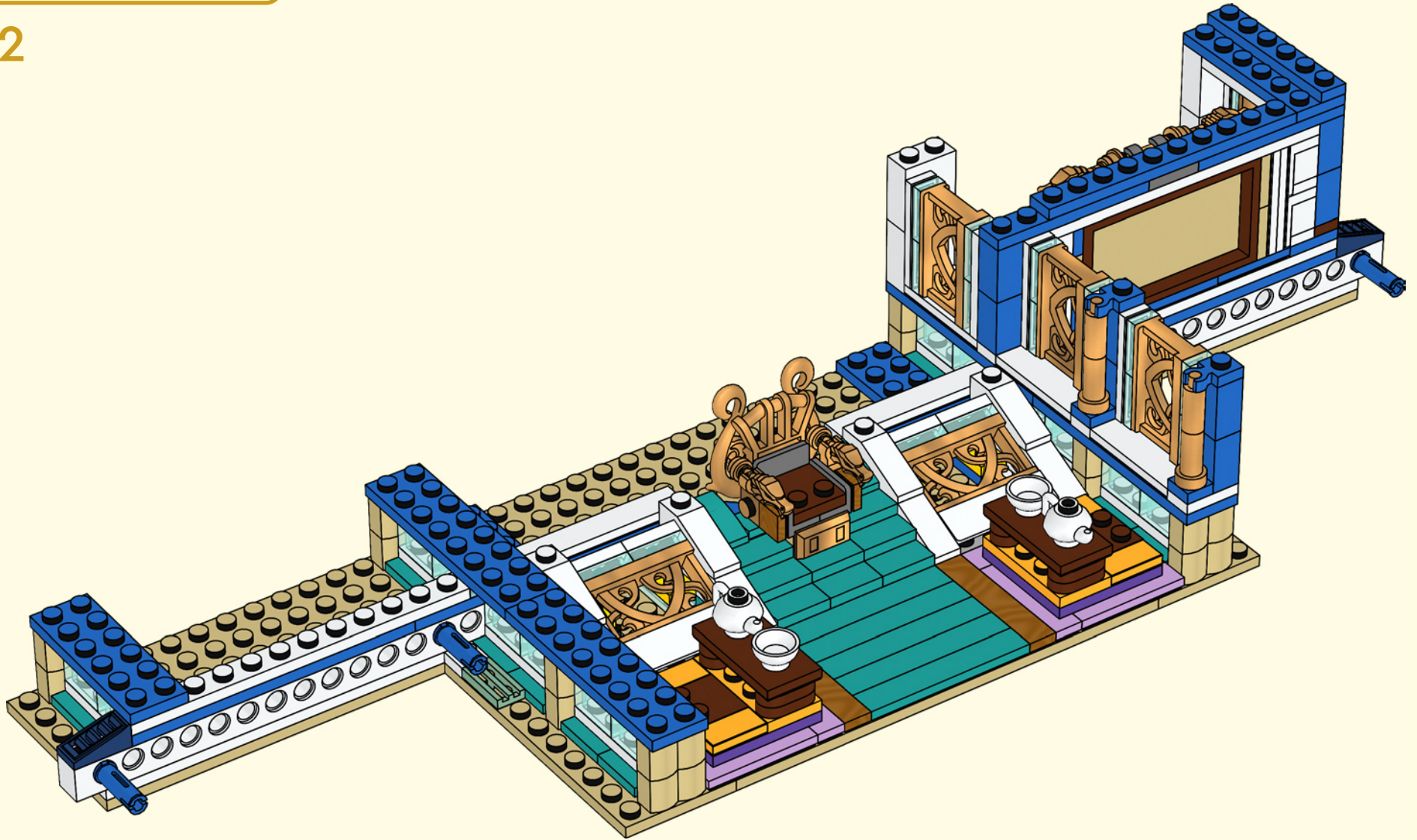



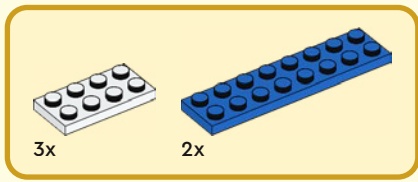

73

1

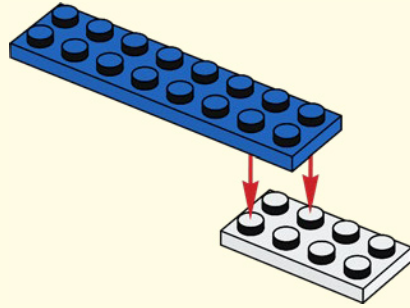

2

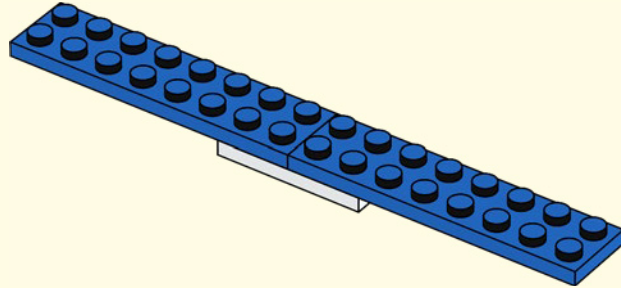

3

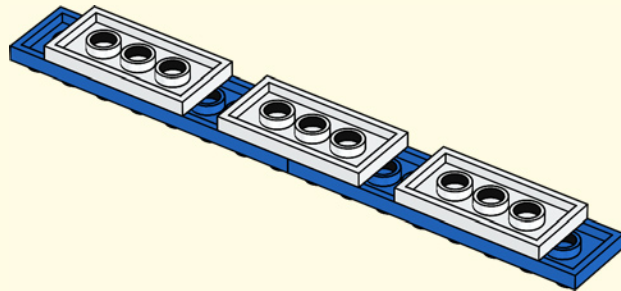

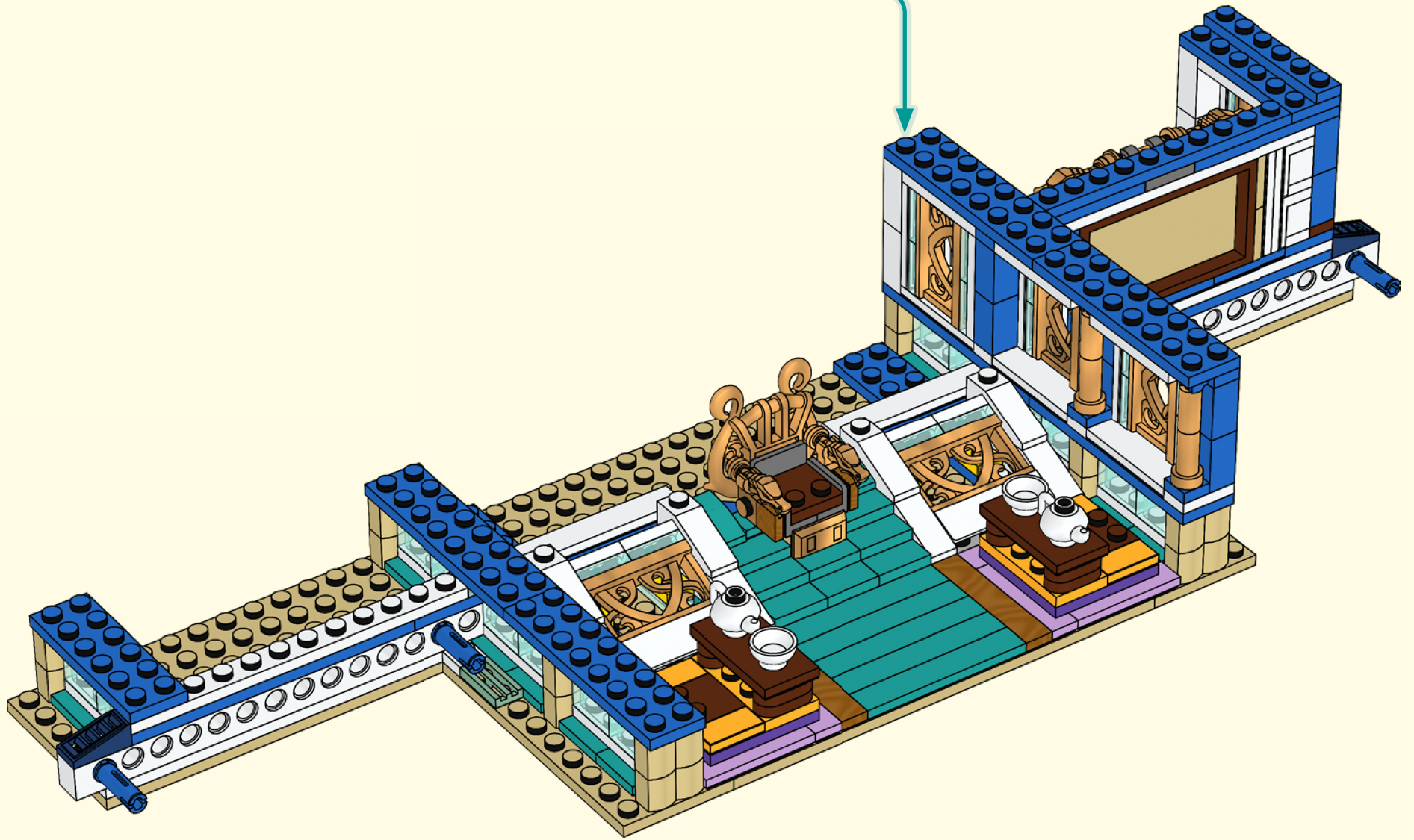

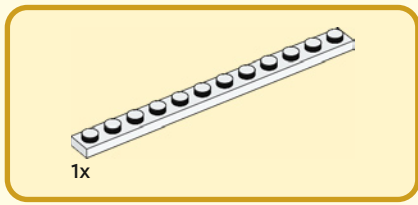

74







75





76

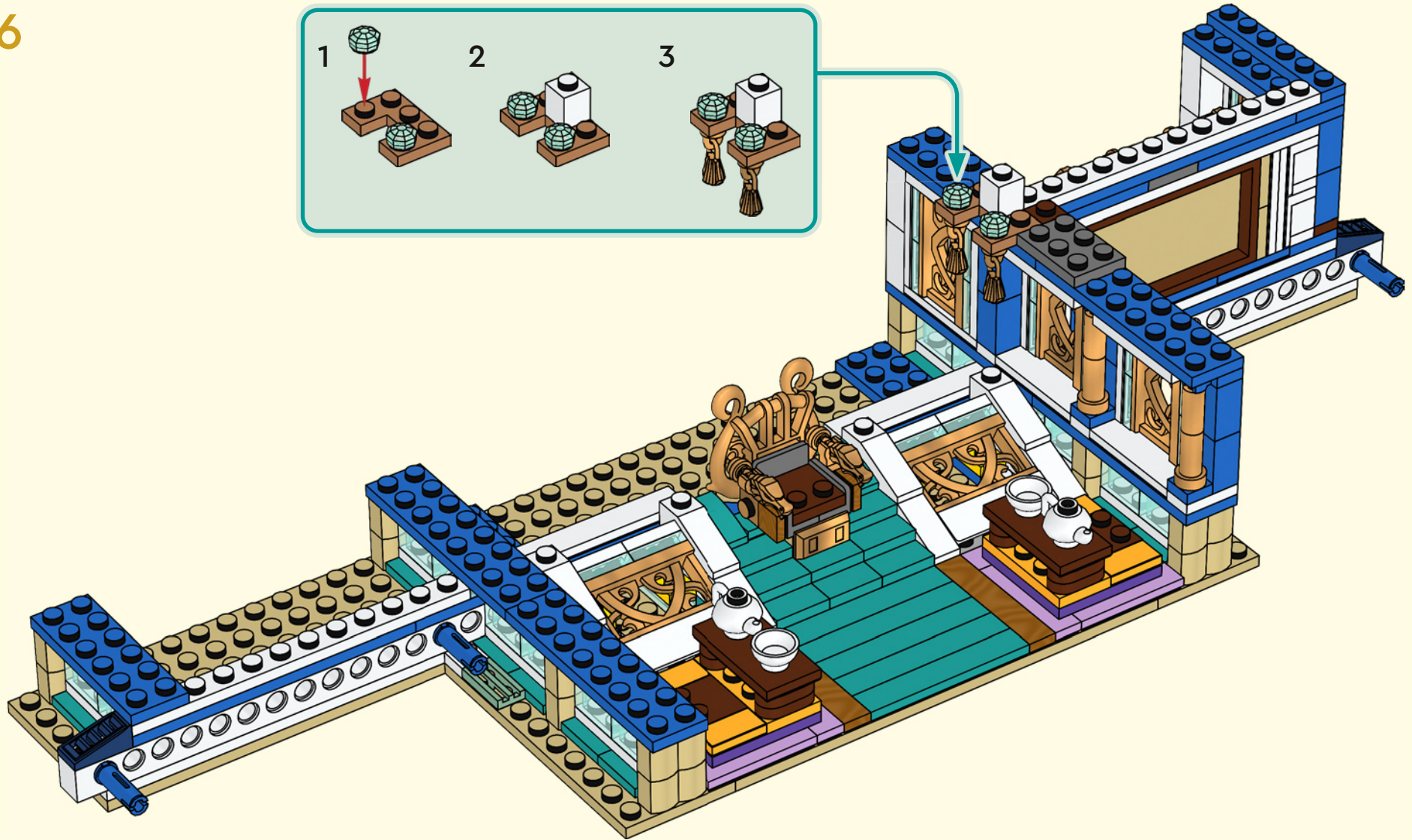
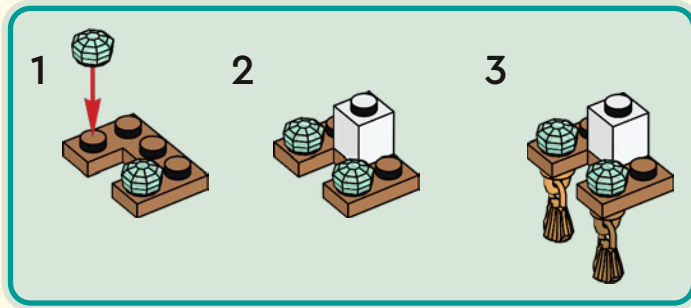

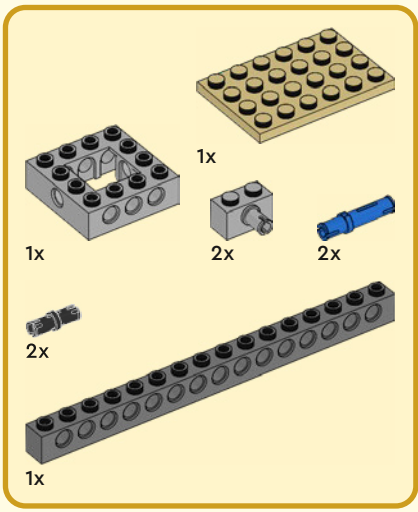

77

1

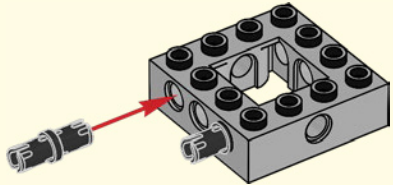

2

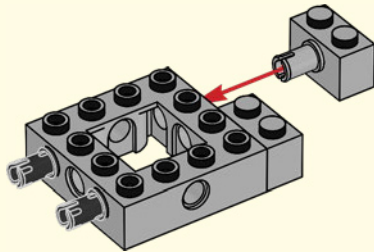

3

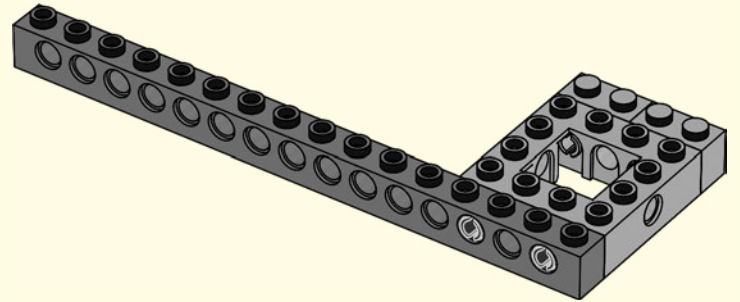



4

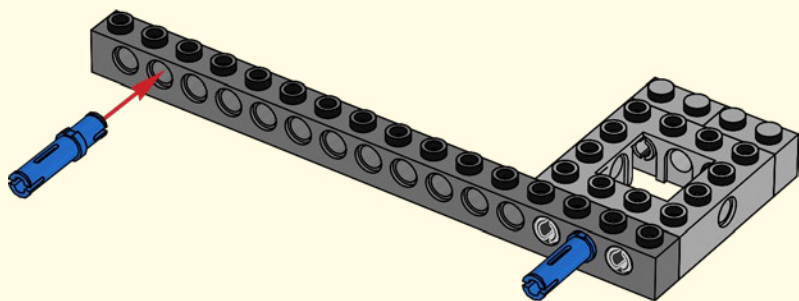

5

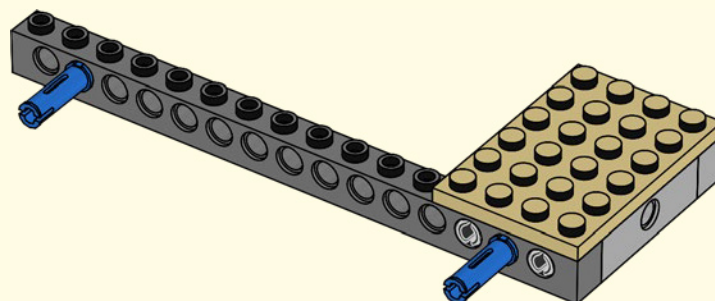

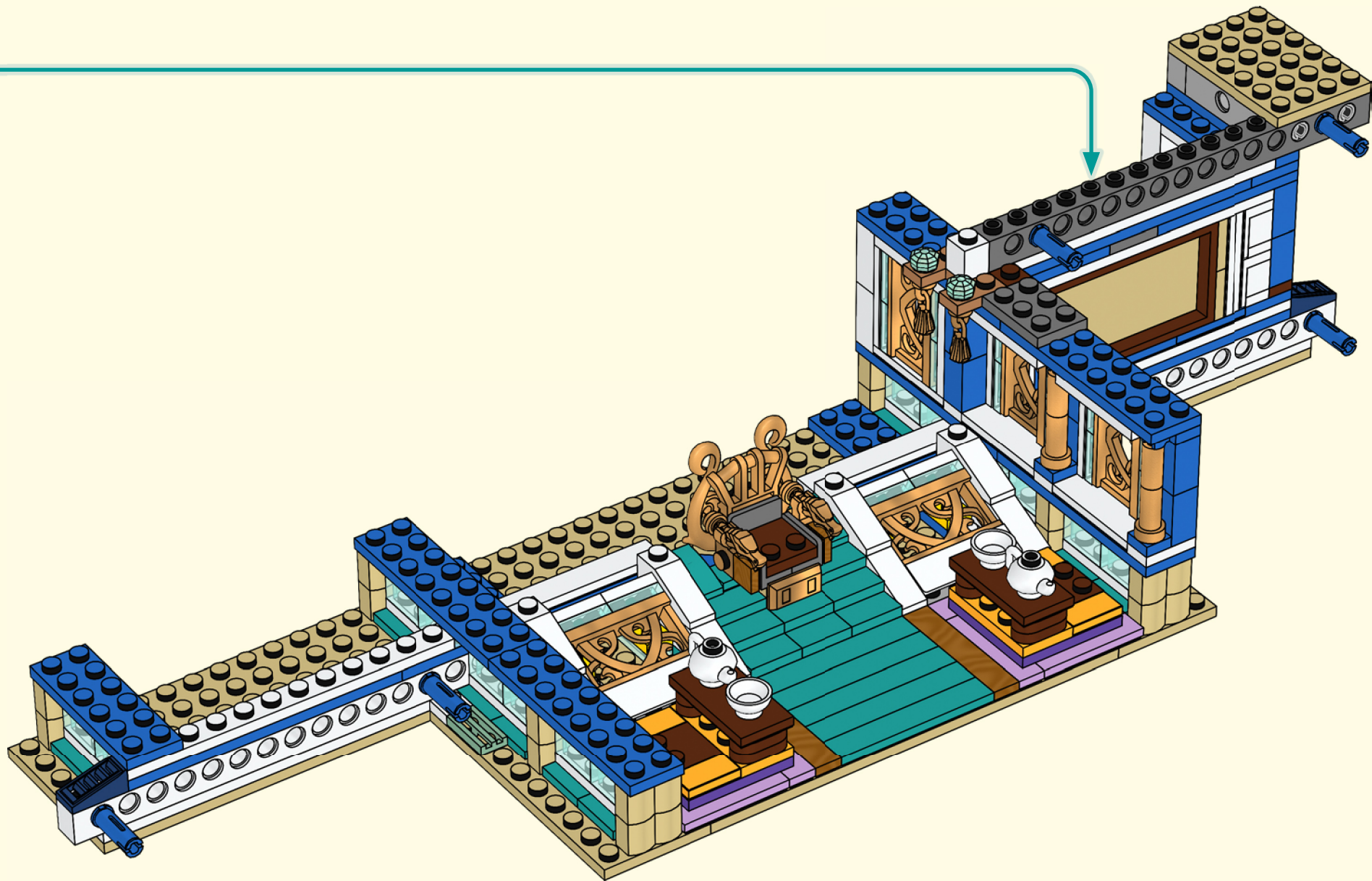

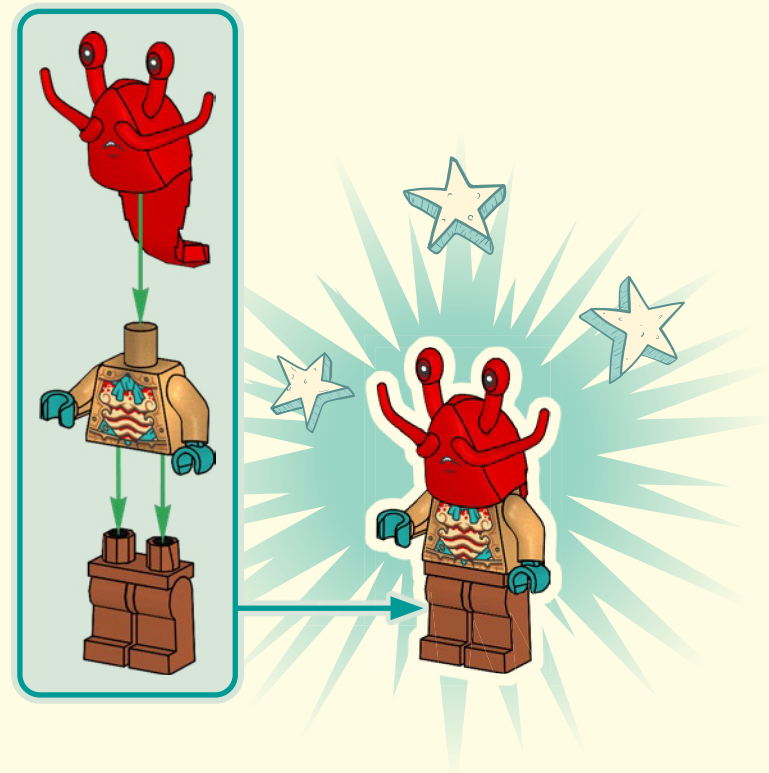
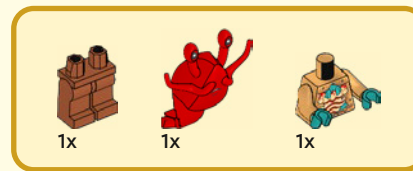



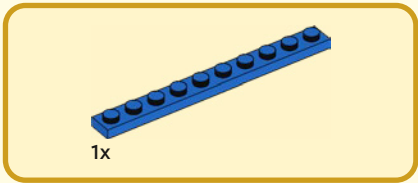

78



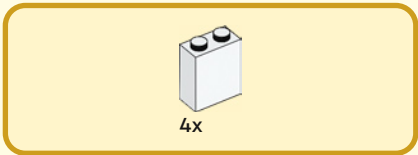

79

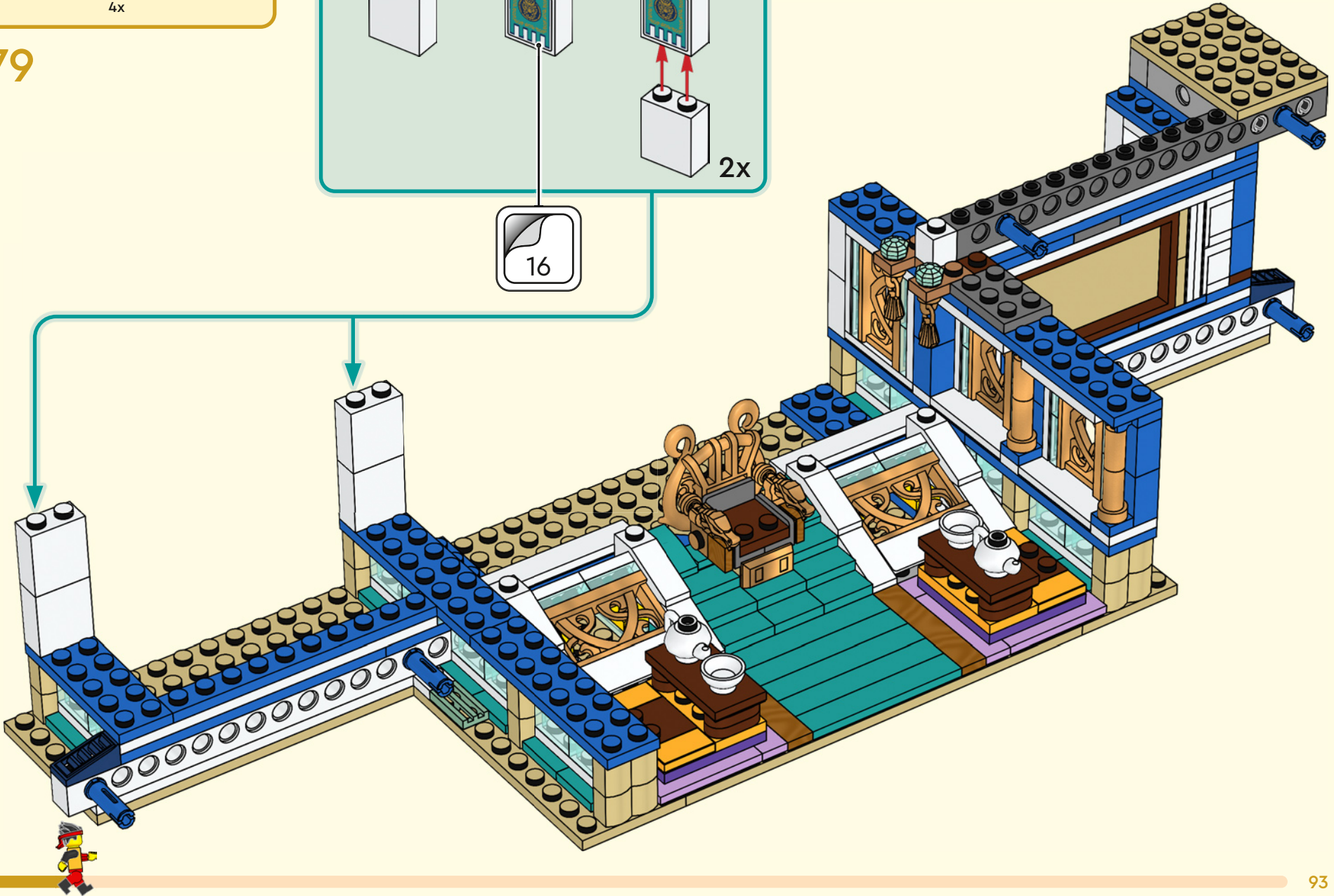
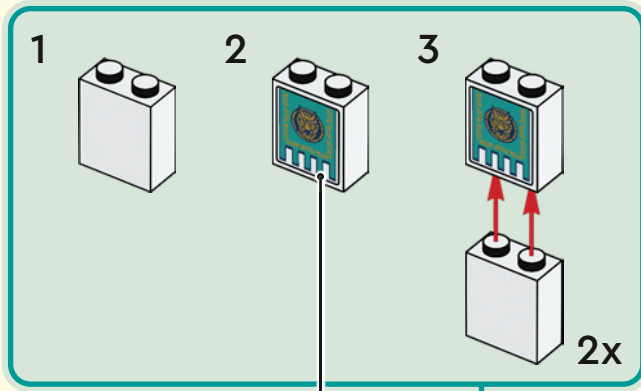





4x



4x

80





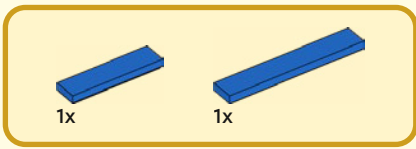

81





2x



4x



8x



2x



2x

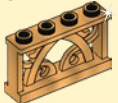

2x

82

1

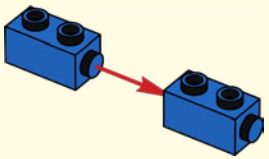

2

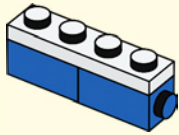

3

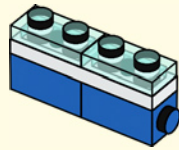

4

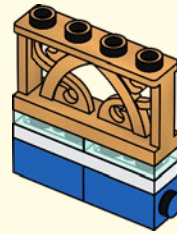

5

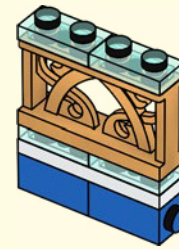

6



2x

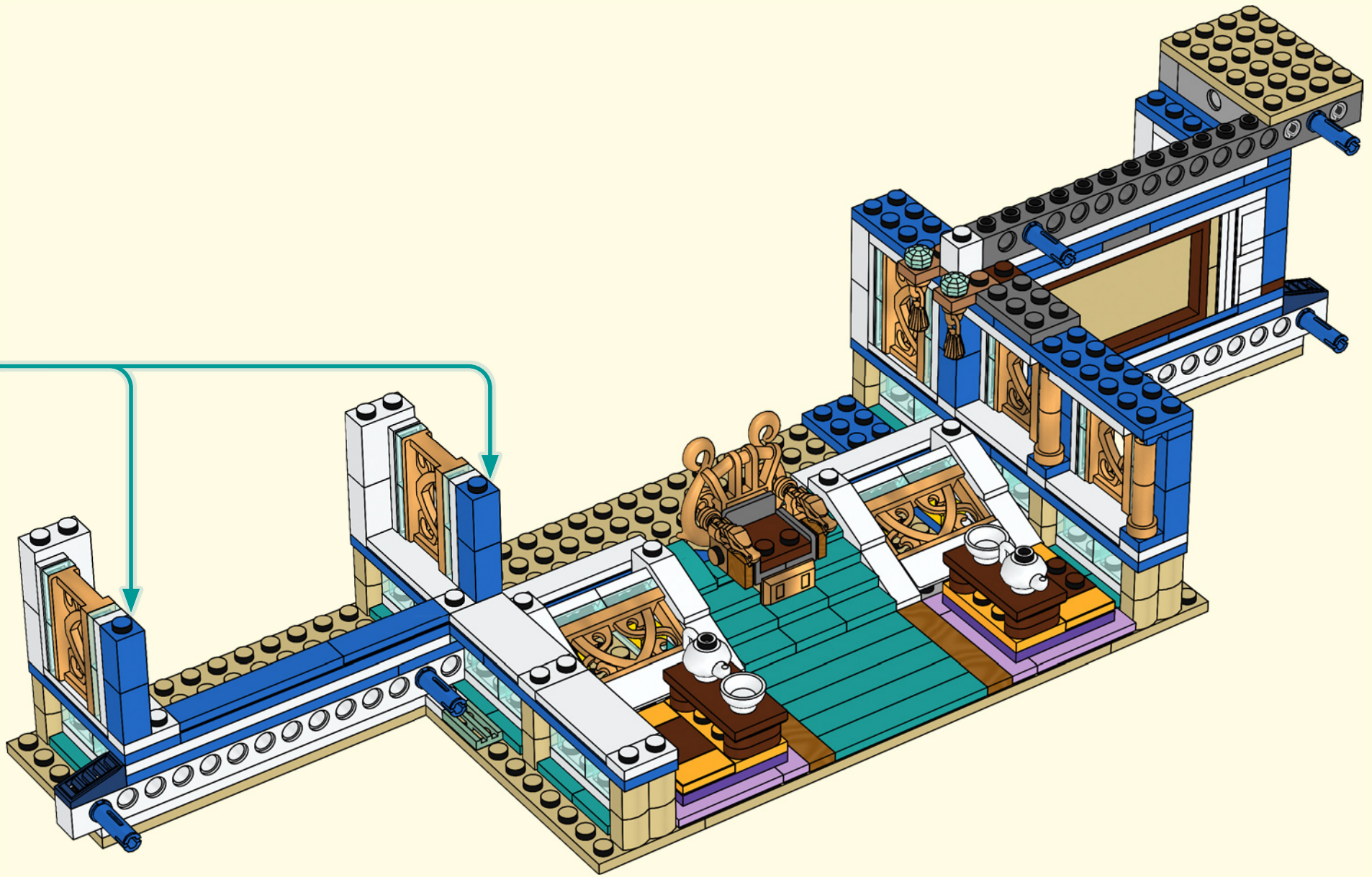



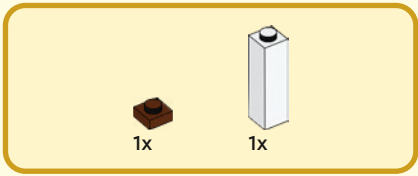

83



2x 2x 4x

84

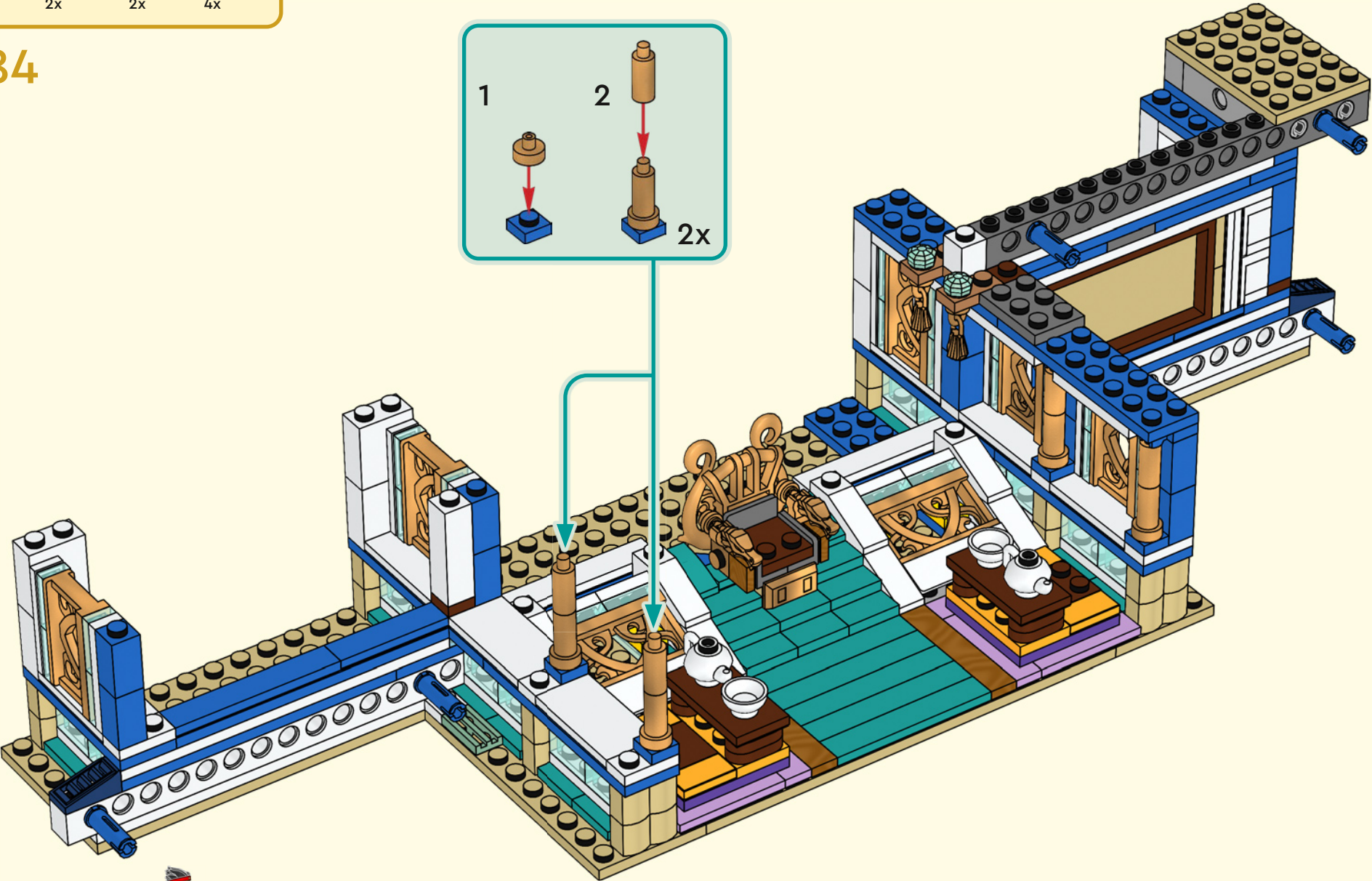
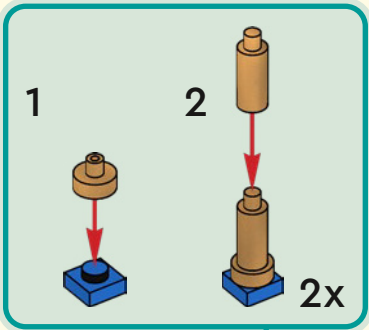

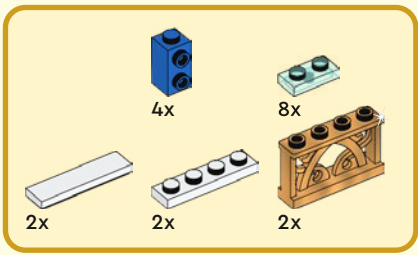

85

1

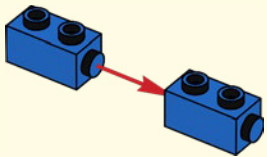

2

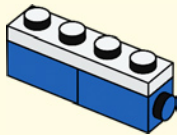

3

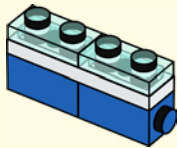

4



5



6





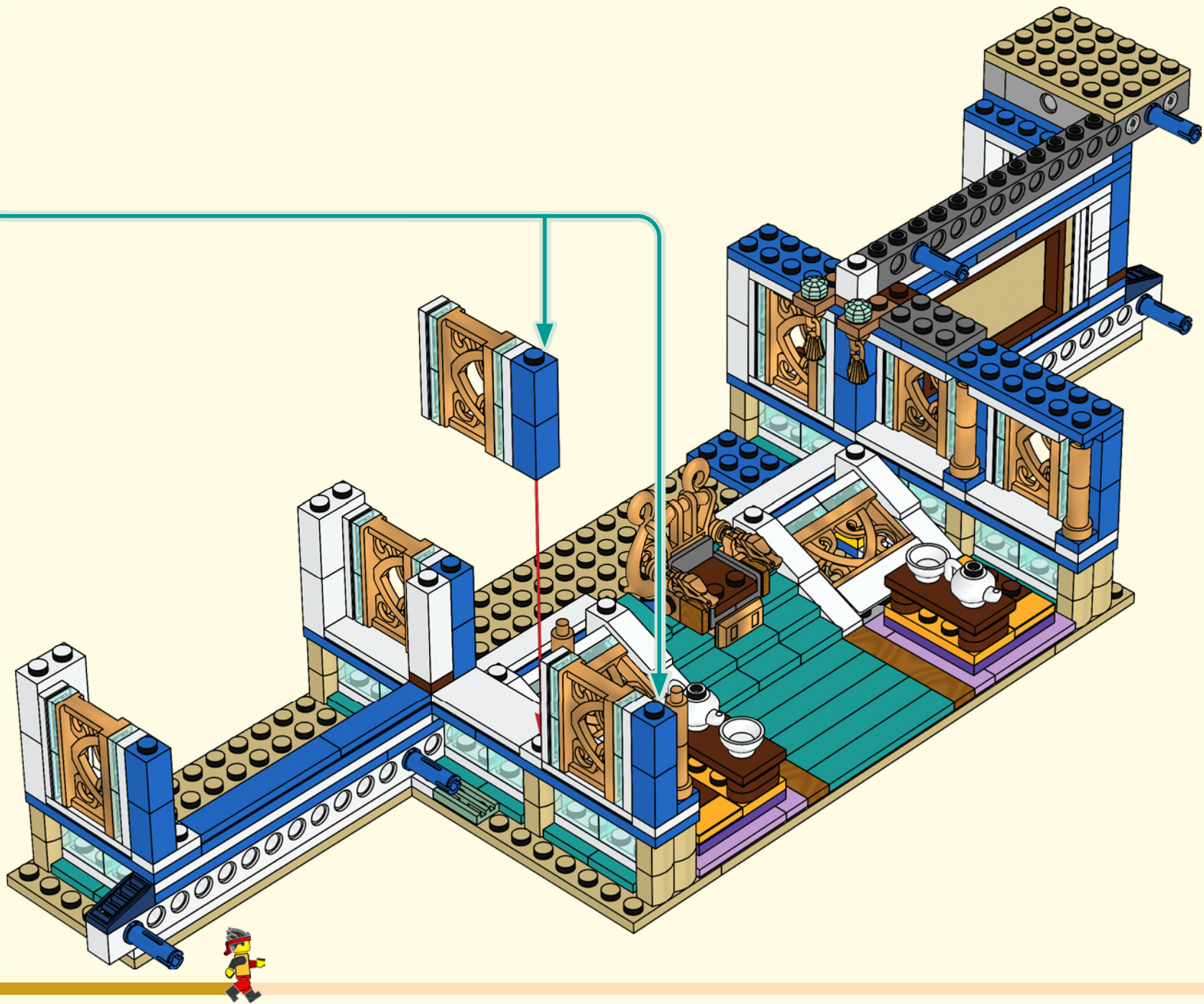



2x

86



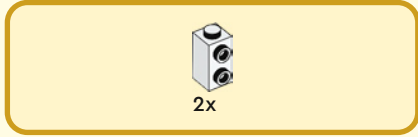
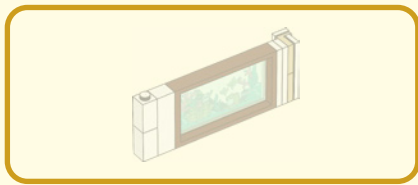

2x

87

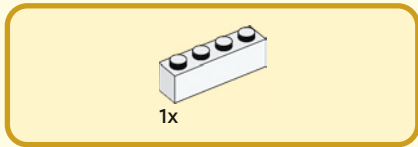
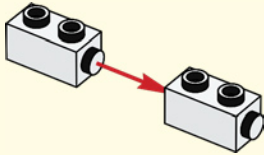

1x

88

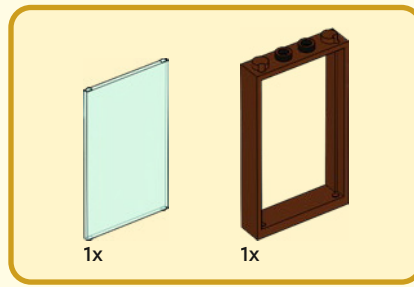
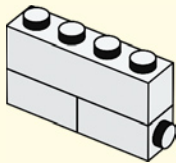

1x

1x

89

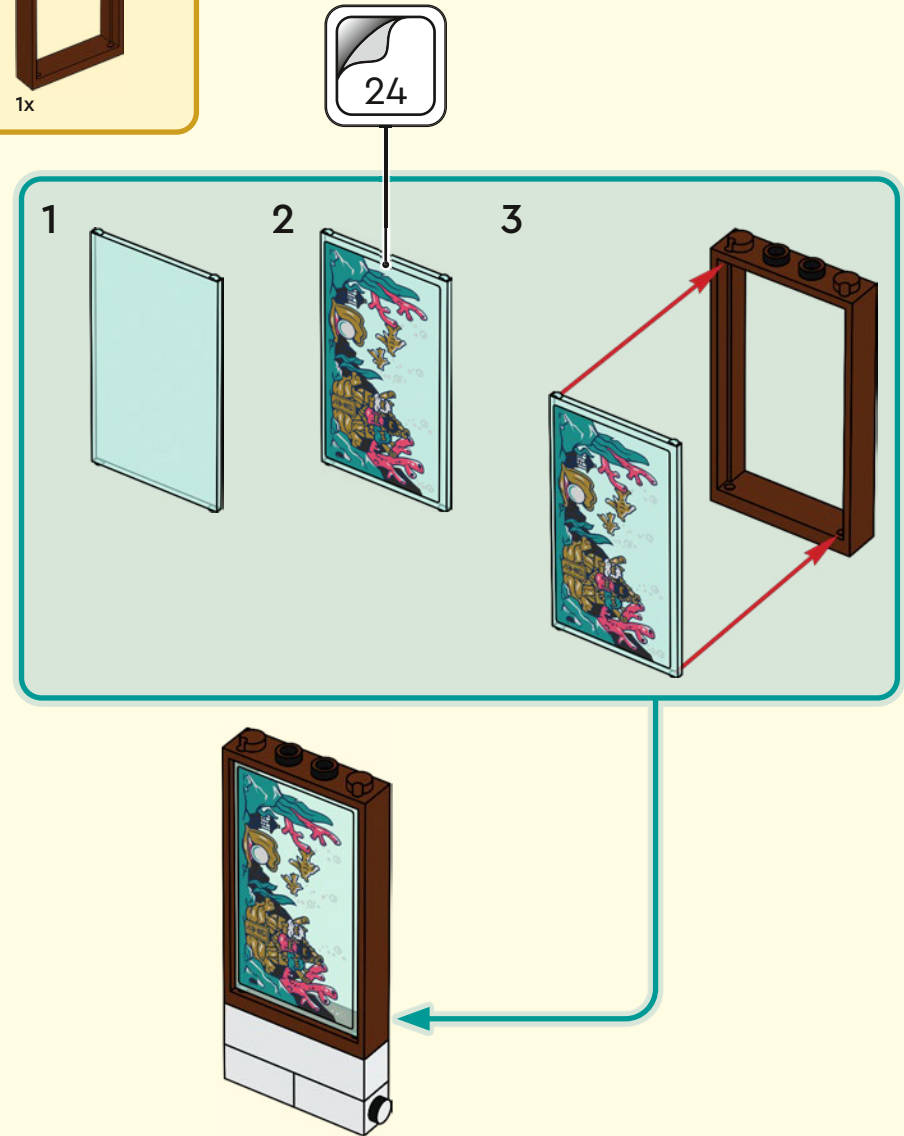

24

1

2

3



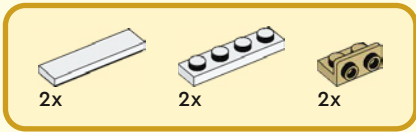

90

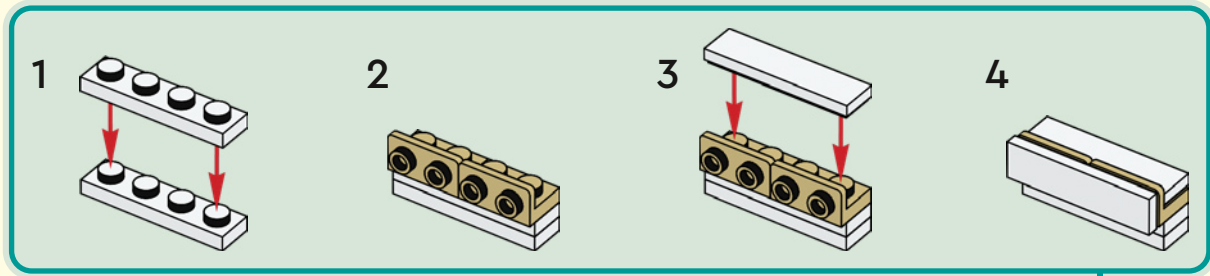

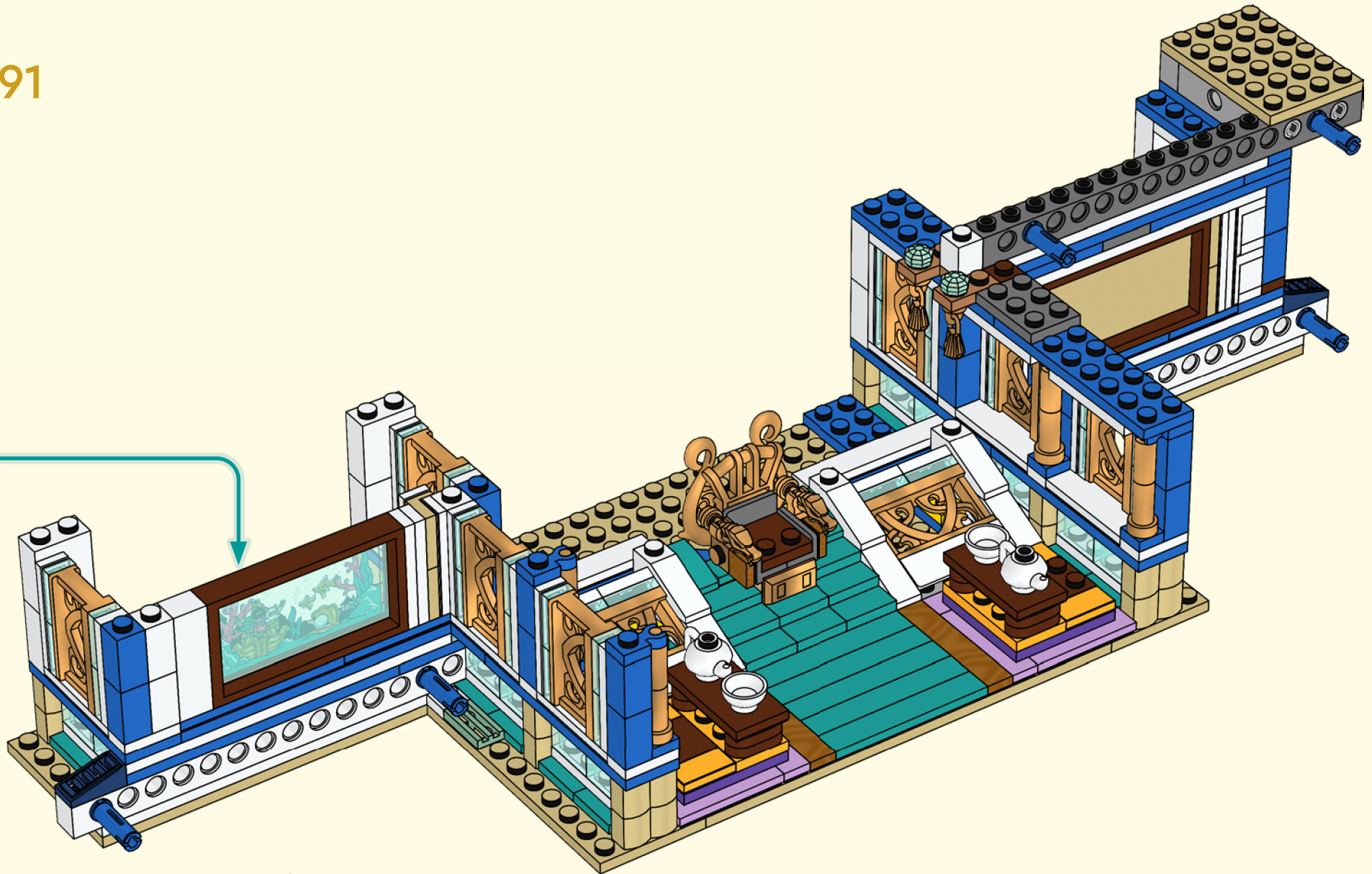

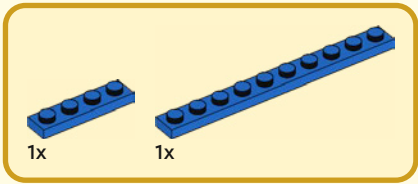

92





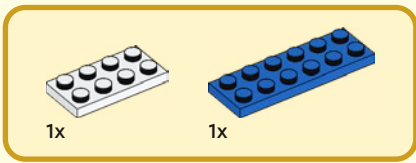

93

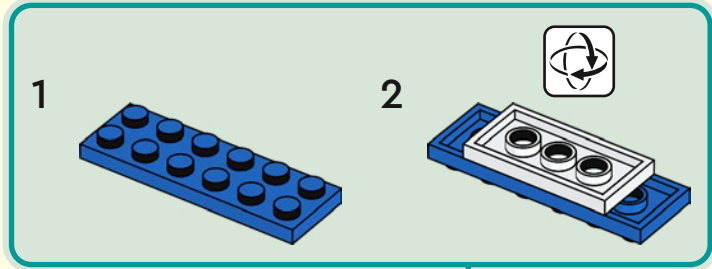

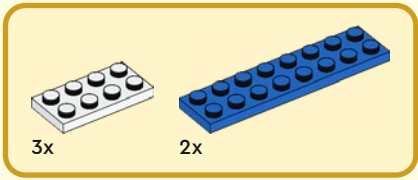

94

1

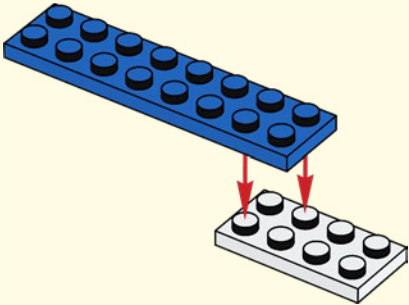

2

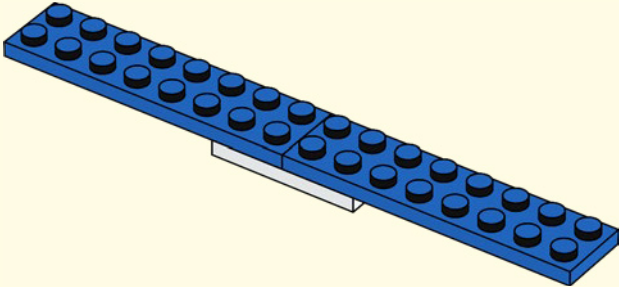

3

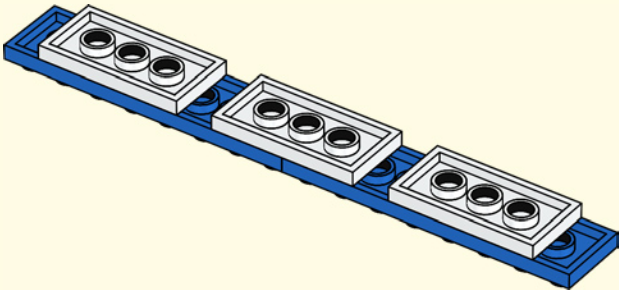







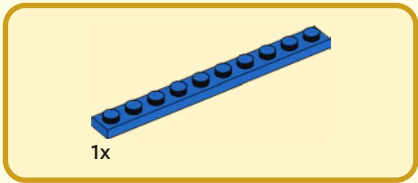

95



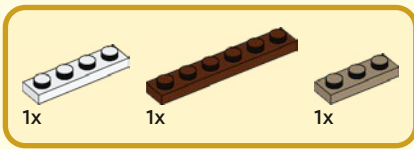

96







1x



1x

97





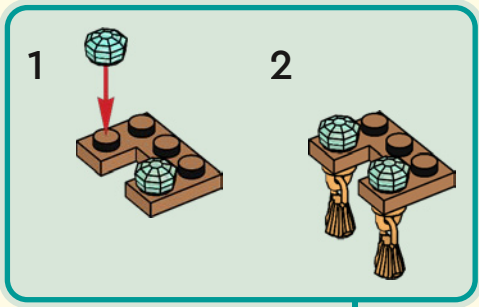
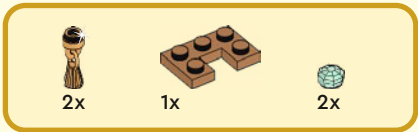

98

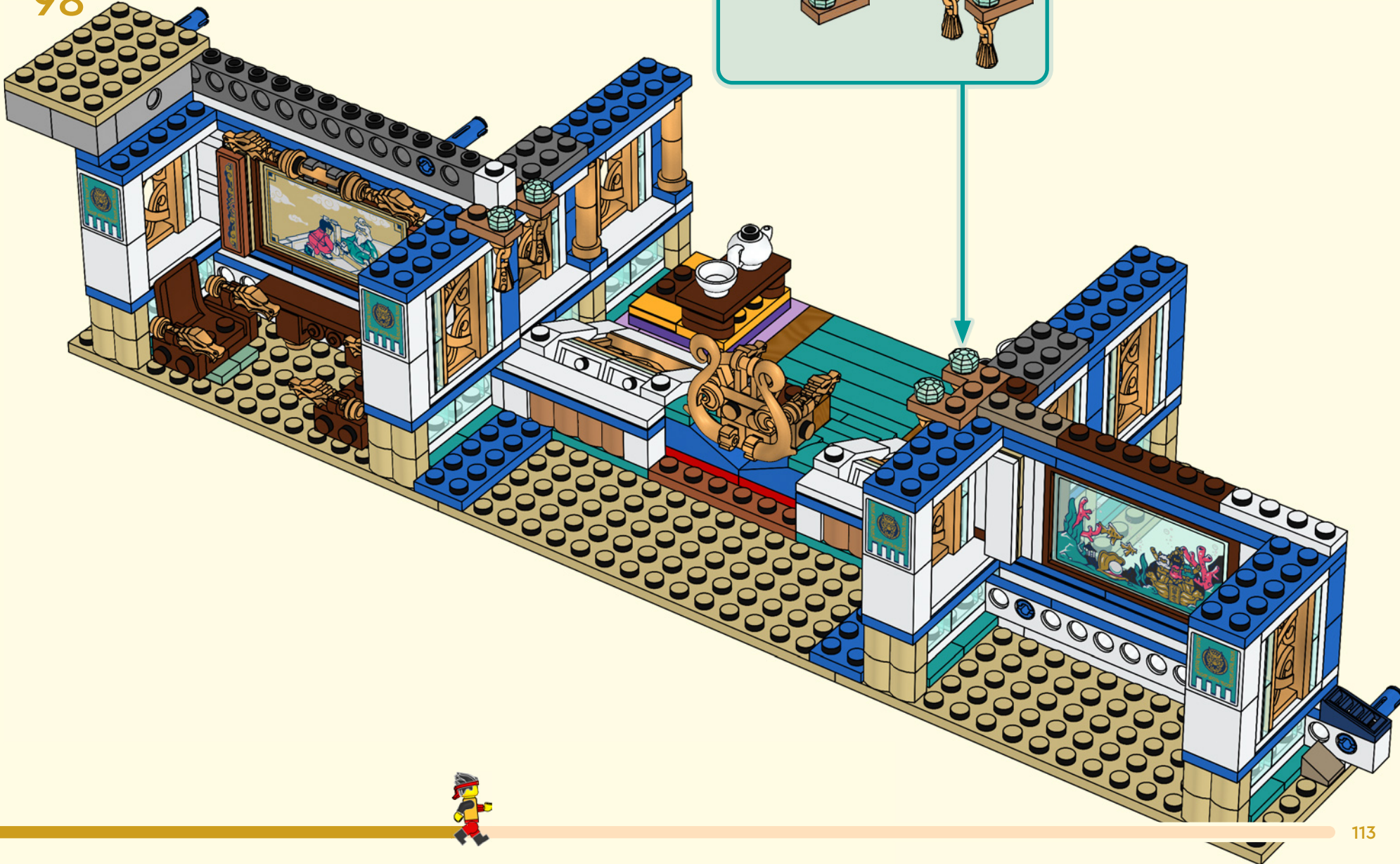



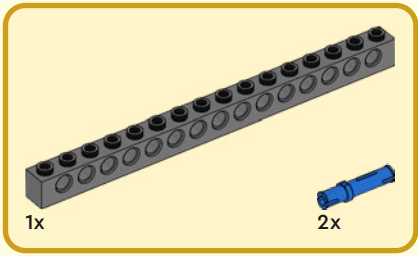

99

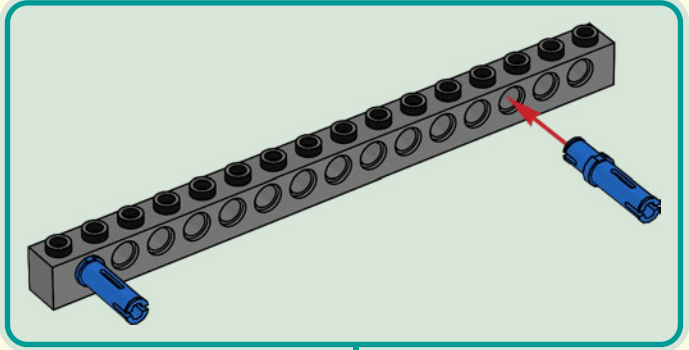



2x

100

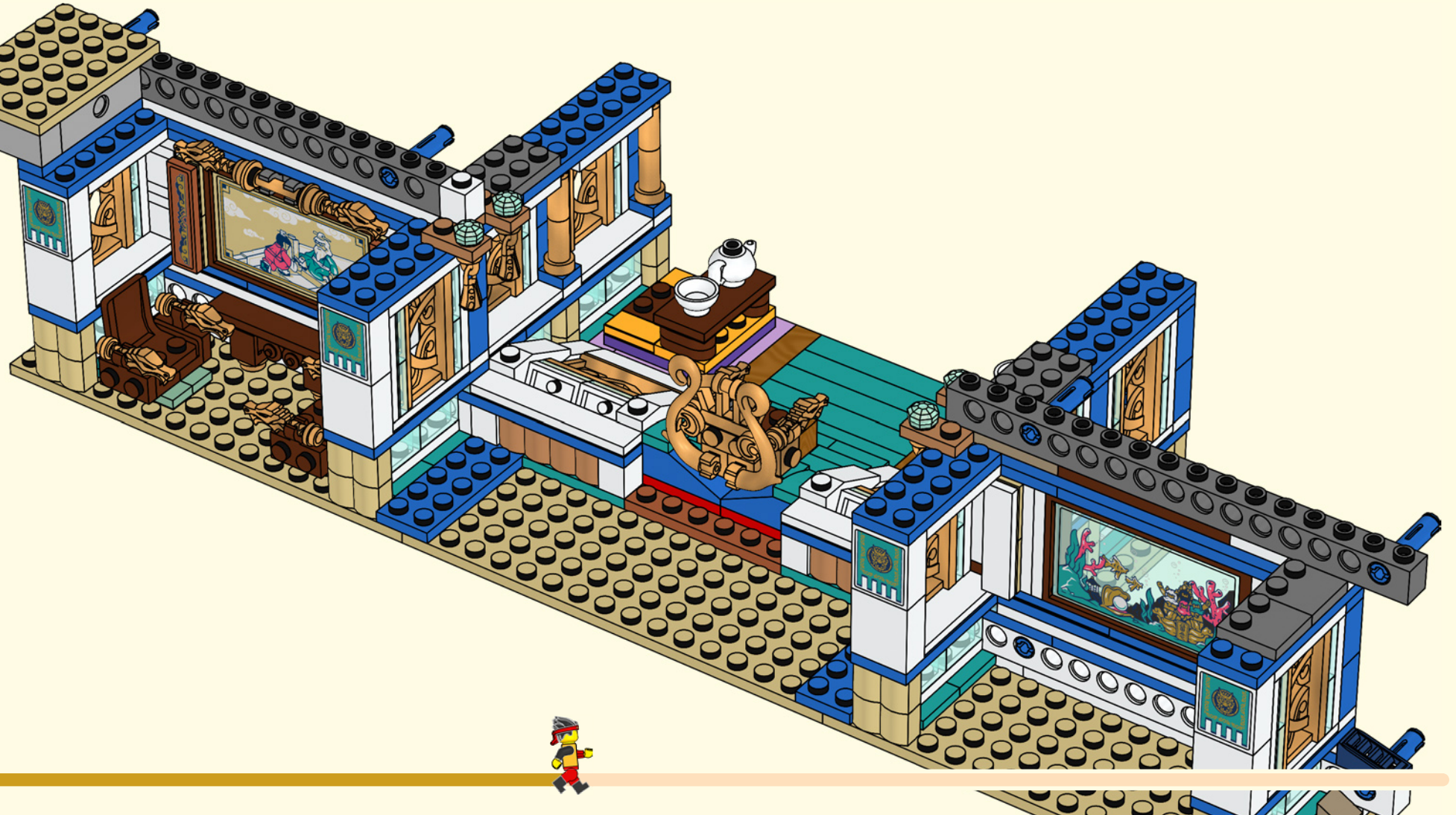



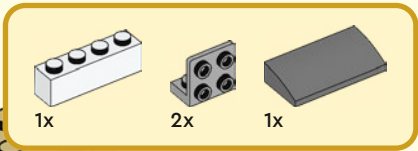

101

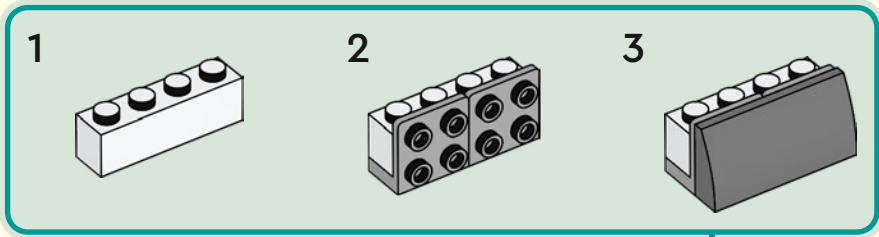



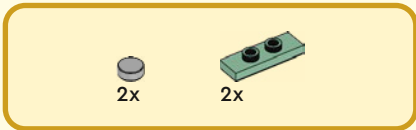

102

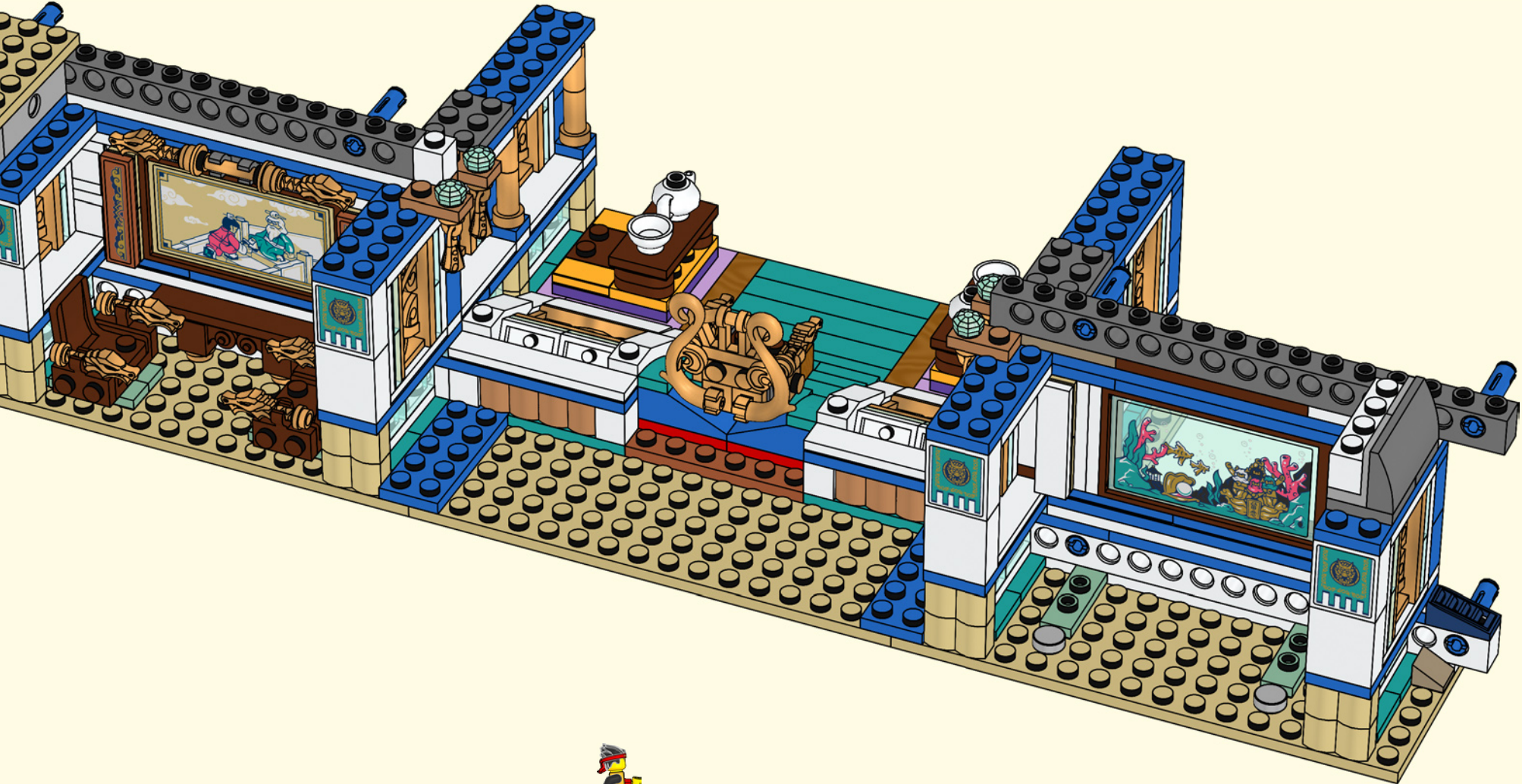





2x

103

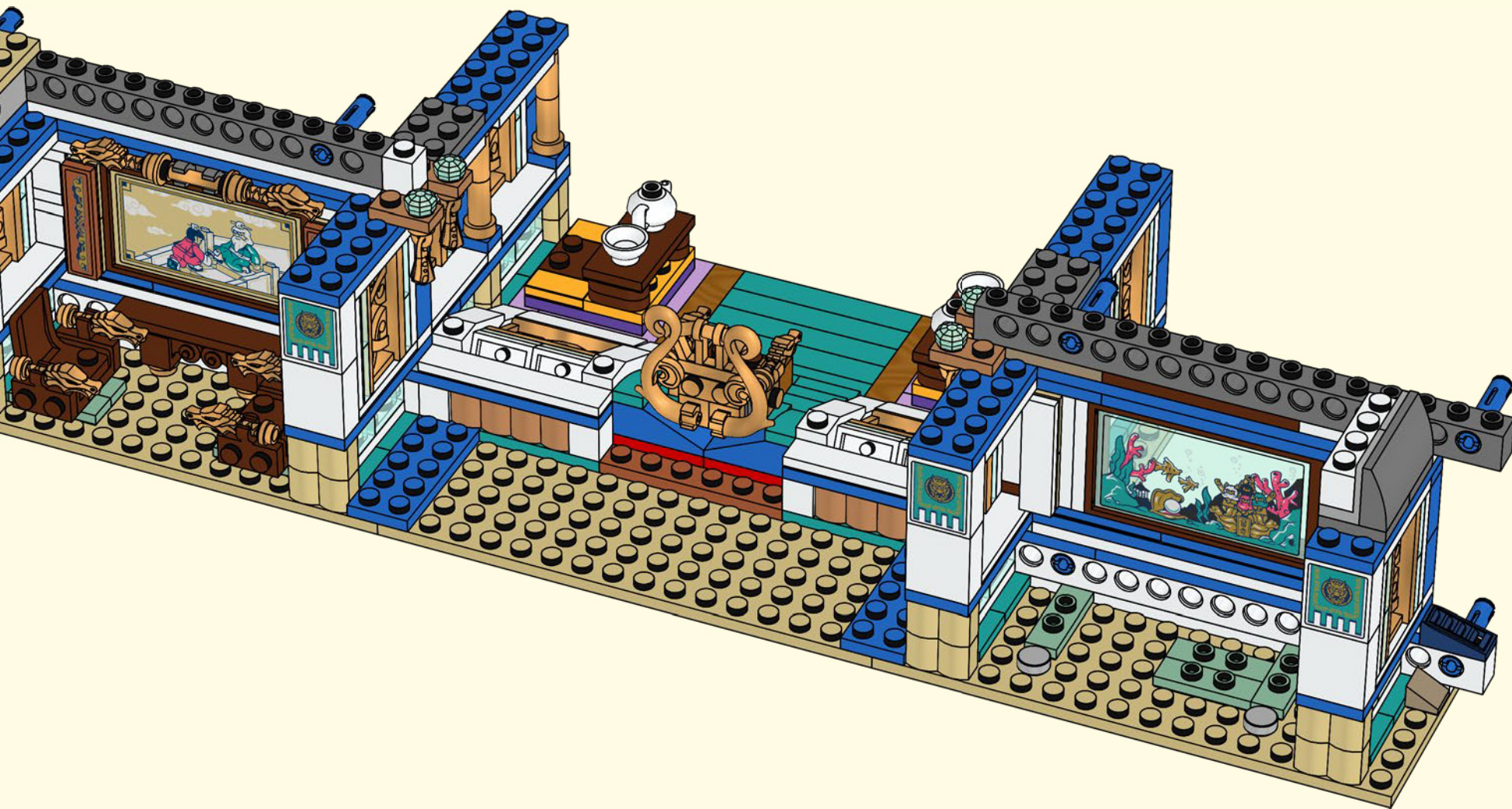





104







105

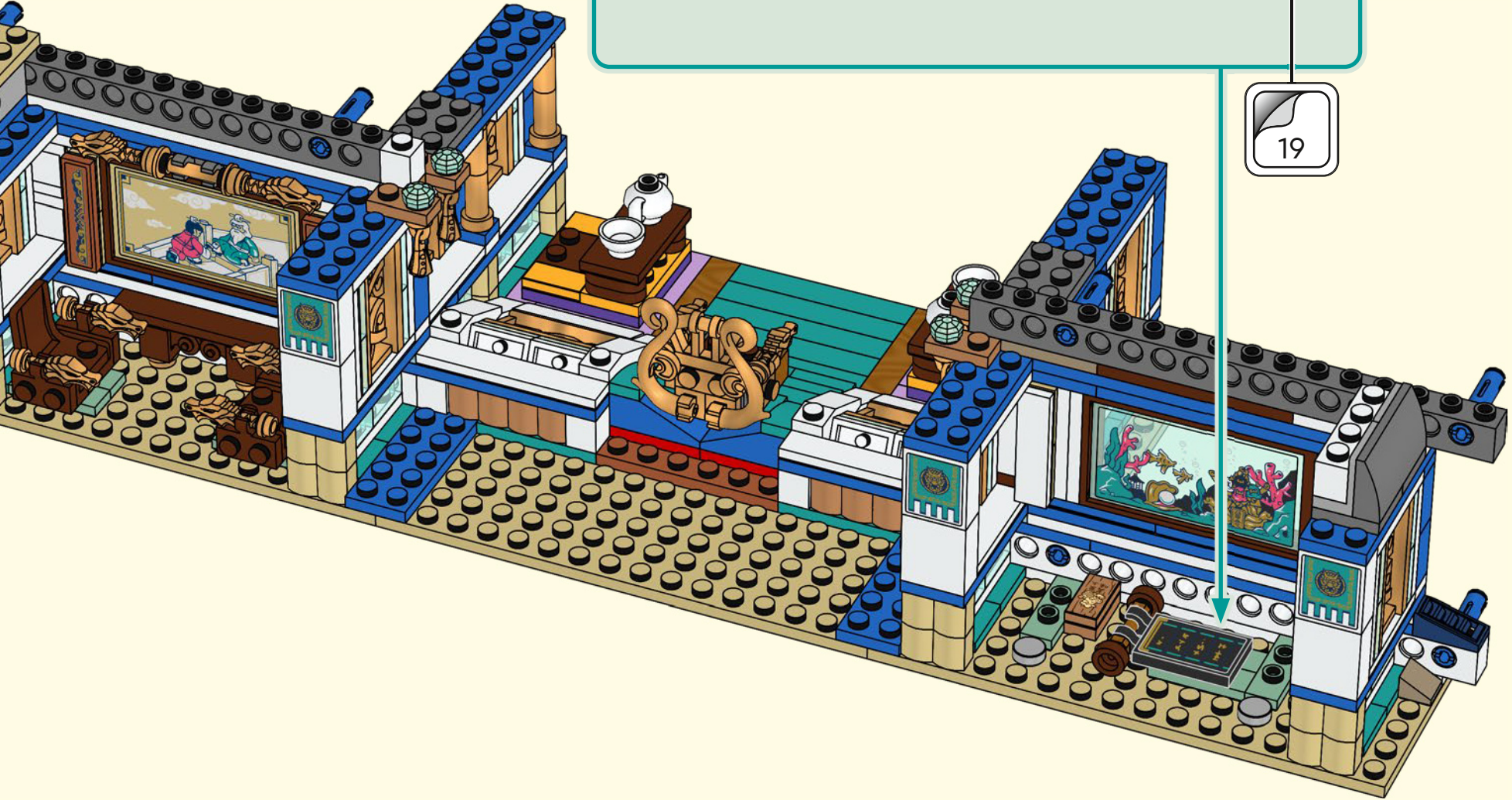
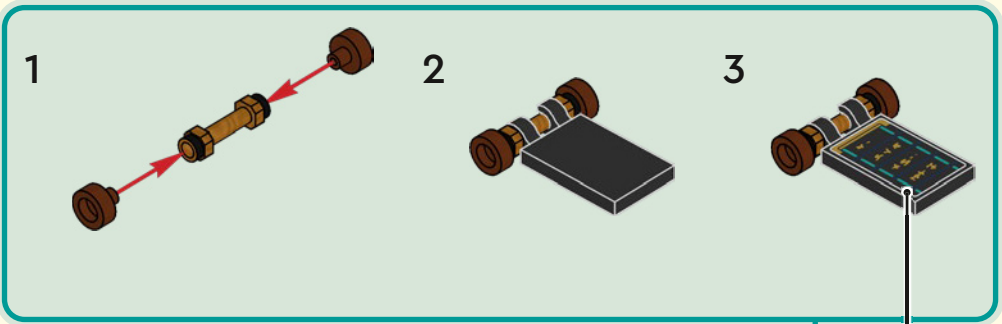

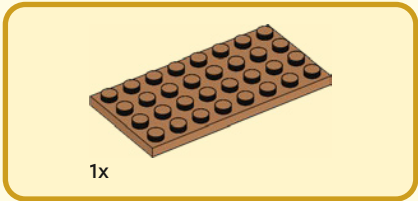
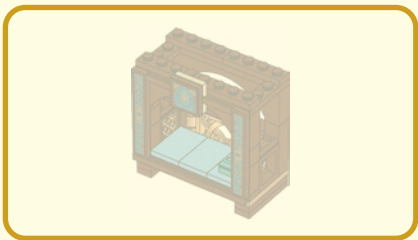

1x

106

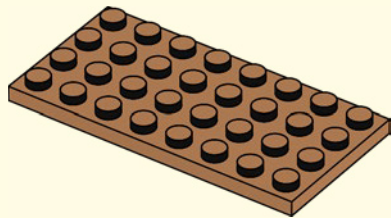

4x

107

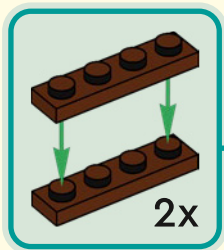

2x

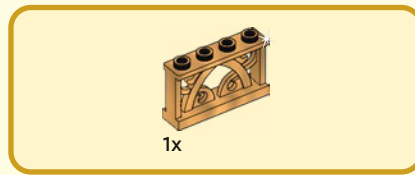

1x

108

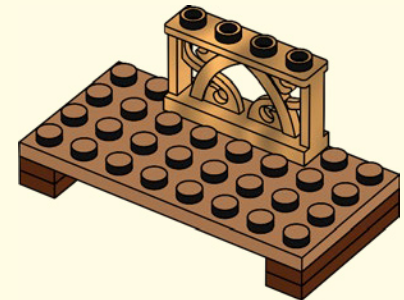

2x

2x

109

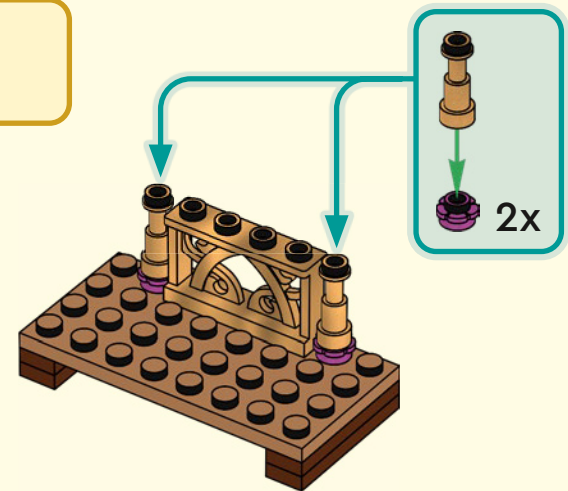

2x



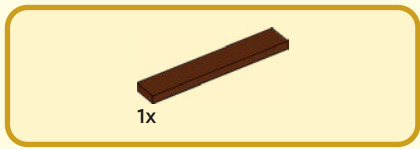

110

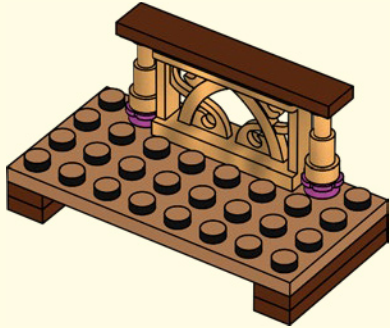

111

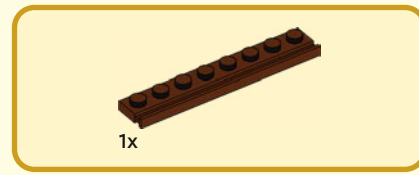
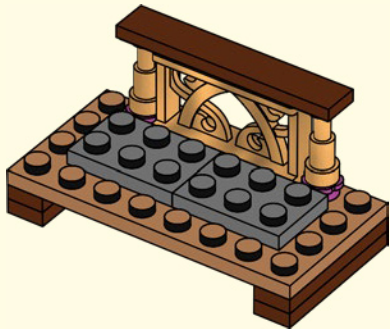

112

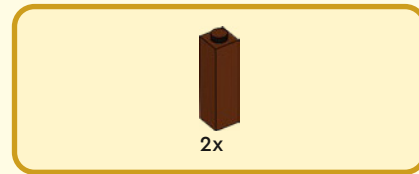

113

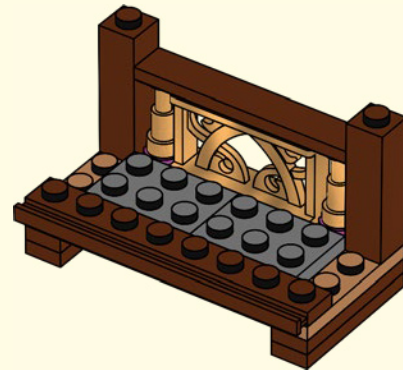

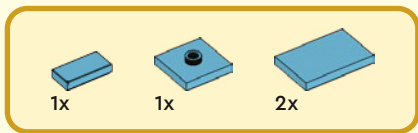

114

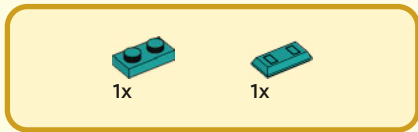
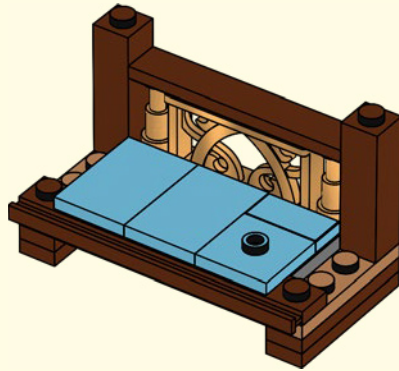

115

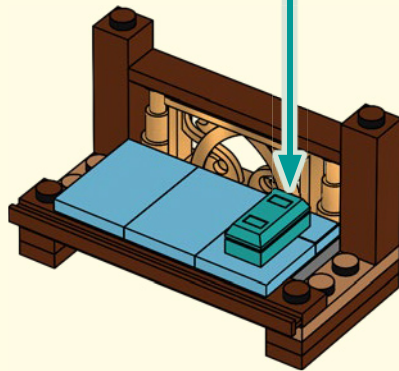
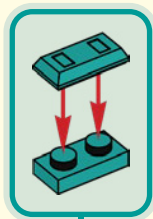

116

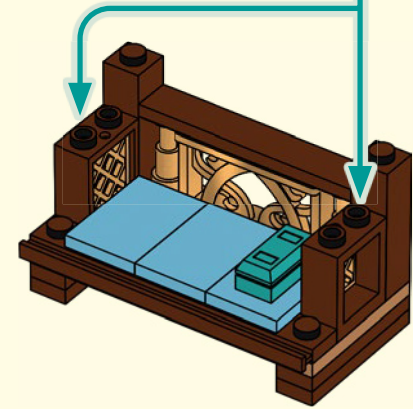
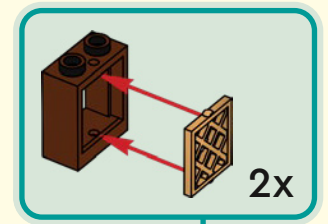

117

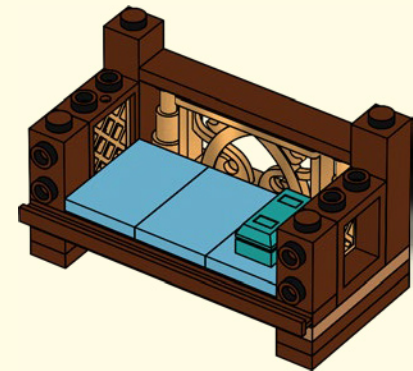



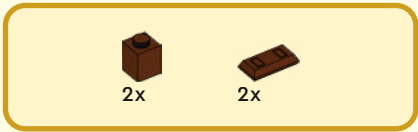

118

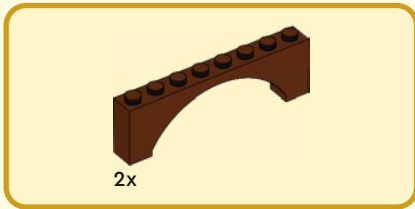
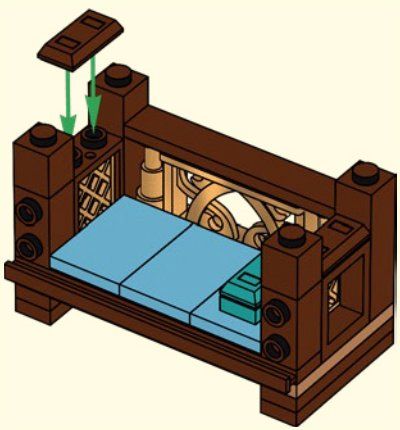

119

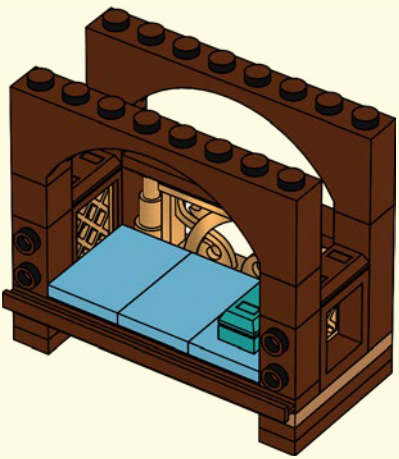

120

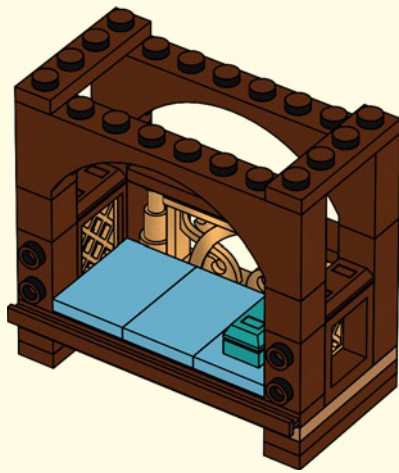

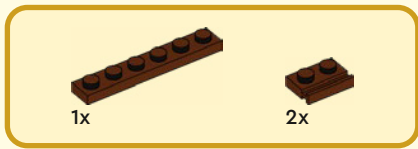

121

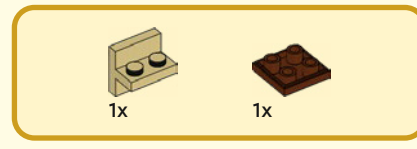
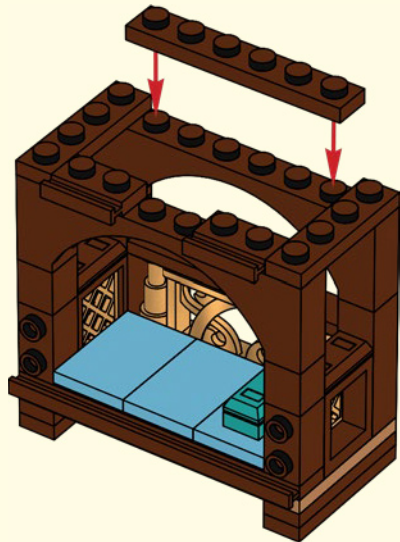

122

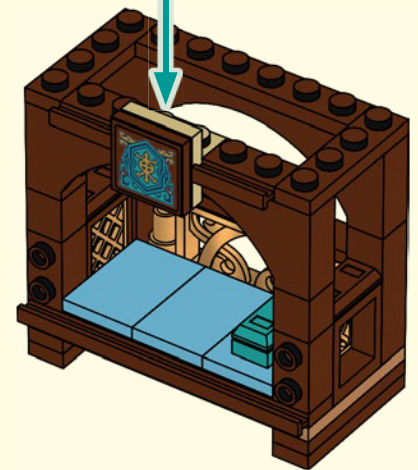
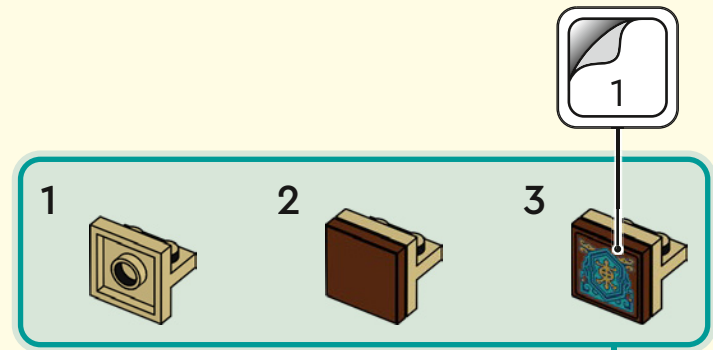





123

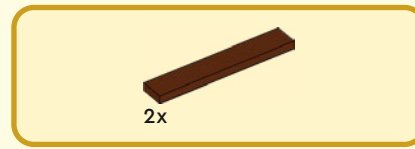
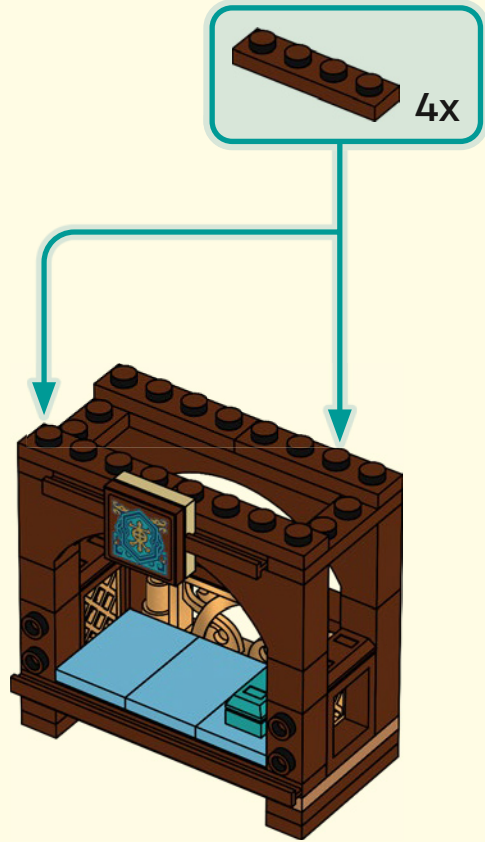

124

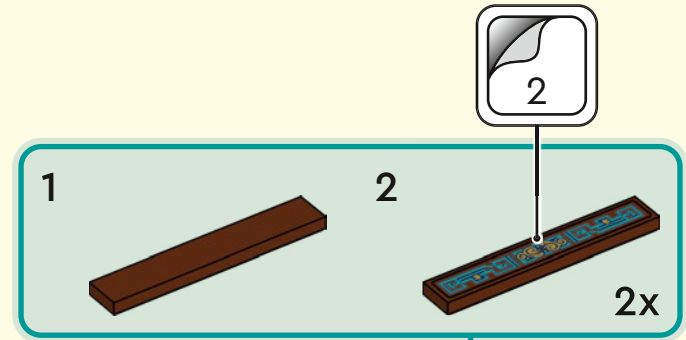







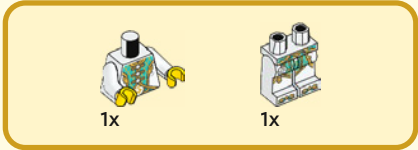

1

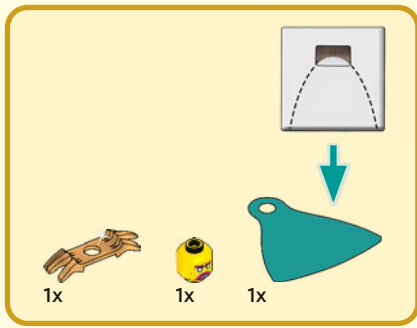
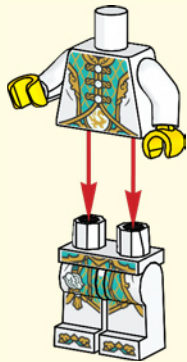

2

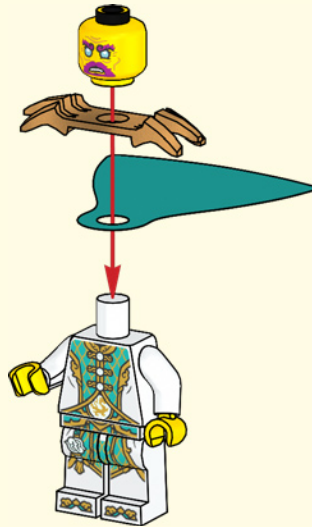

3





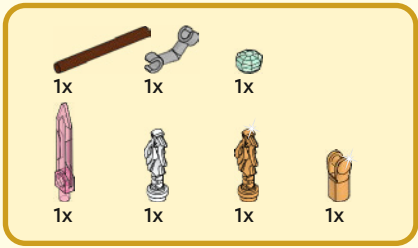

4

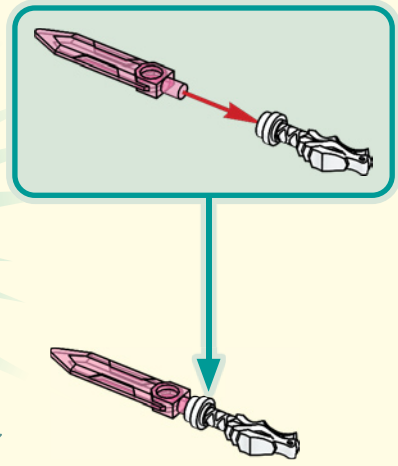
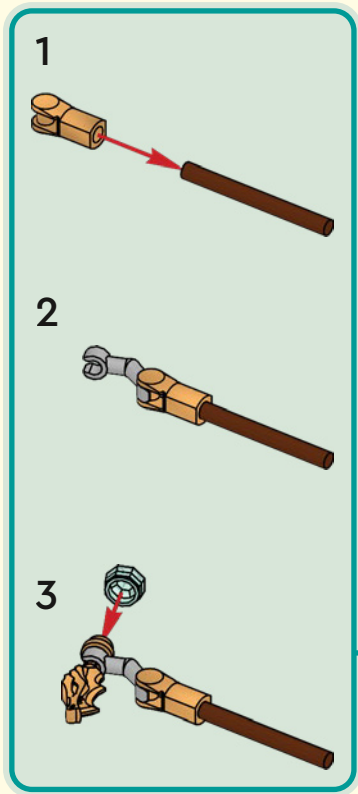

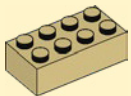

2x

126





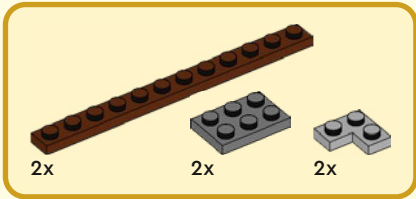

127

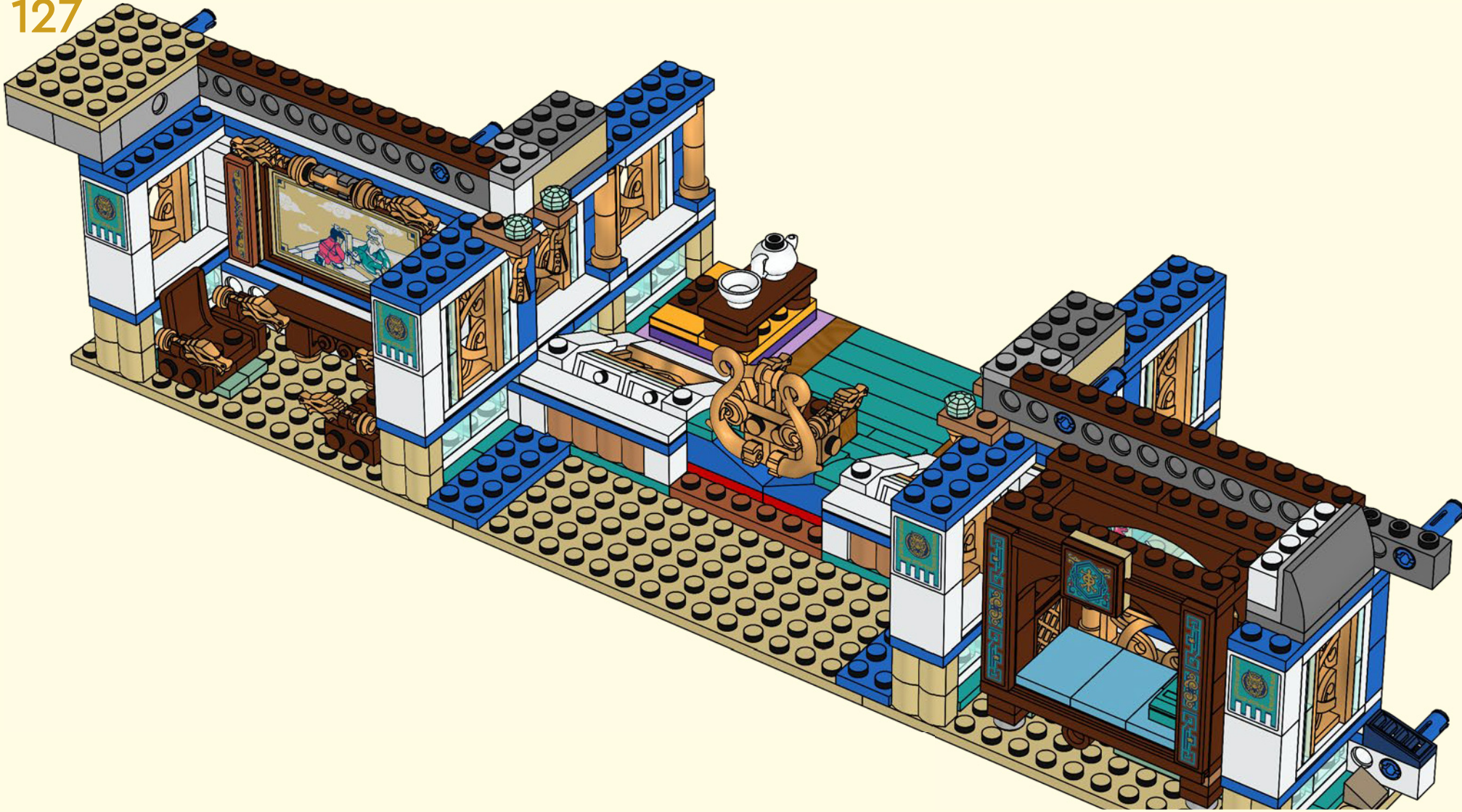



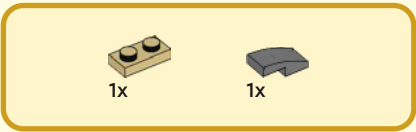

128

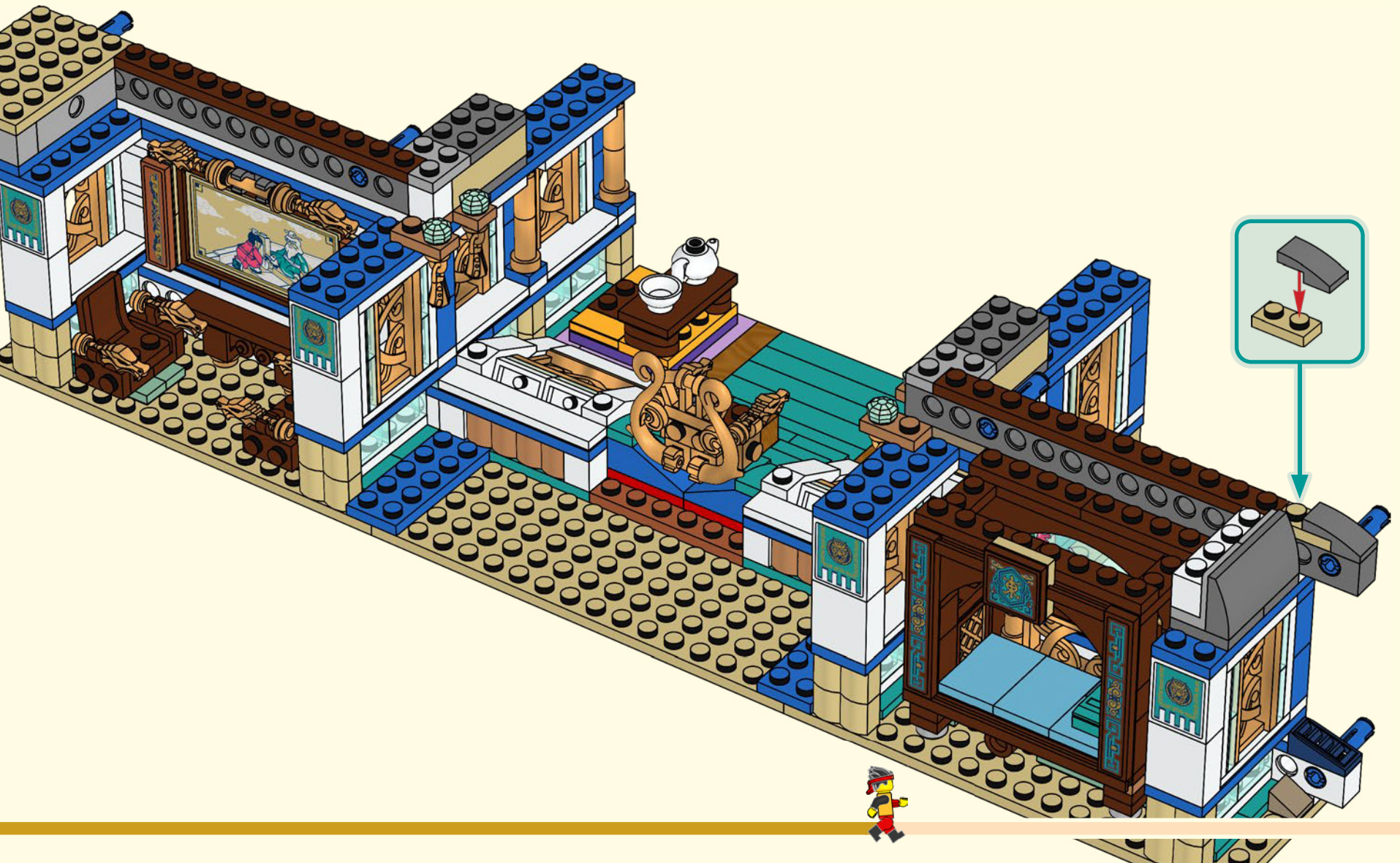





2x

129

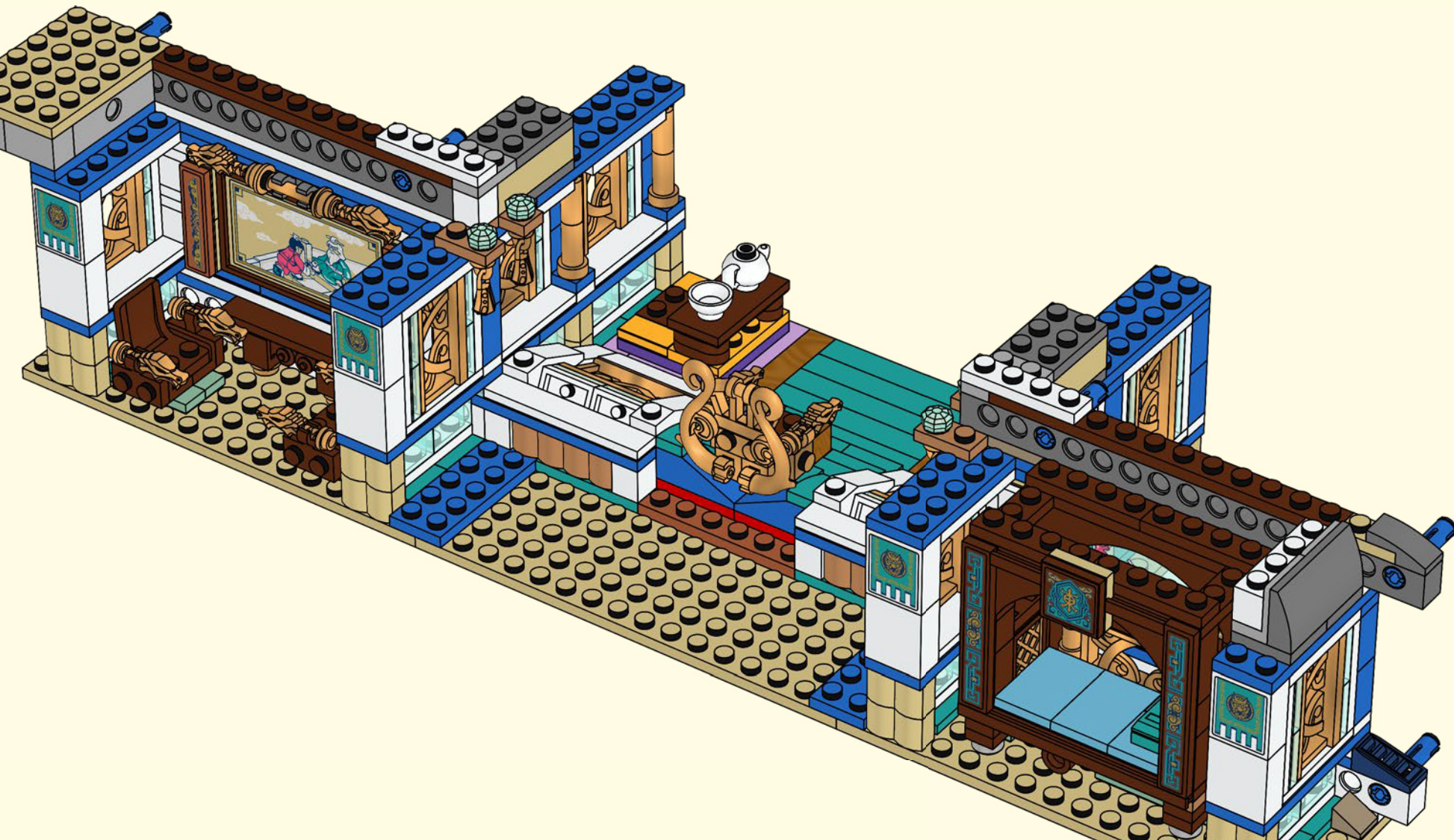

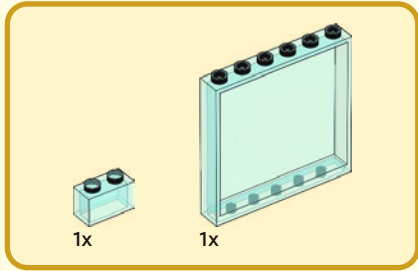
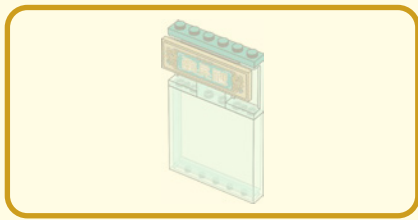

130

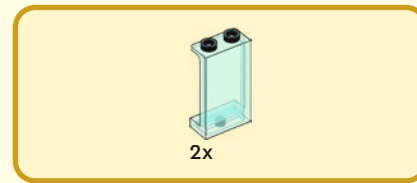
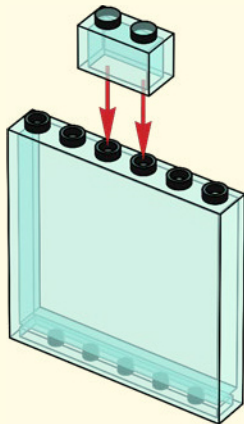

131

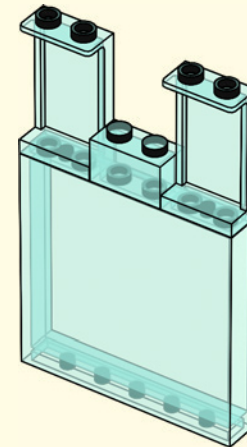



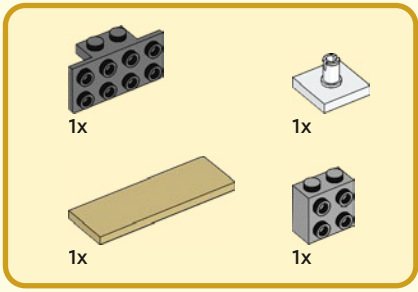

132

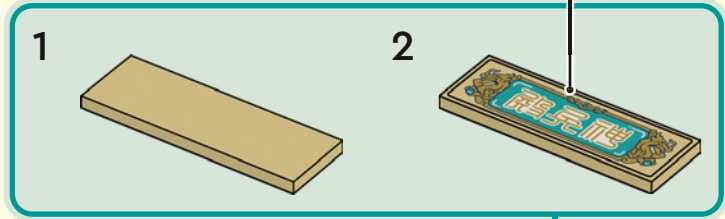
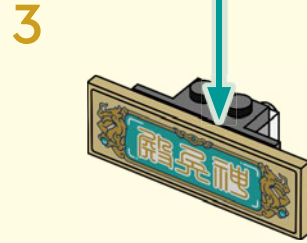
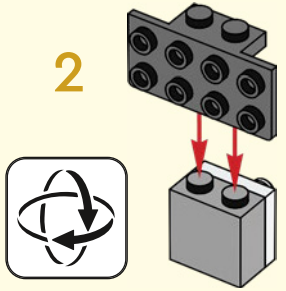
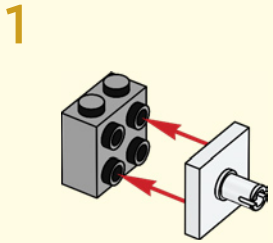

13

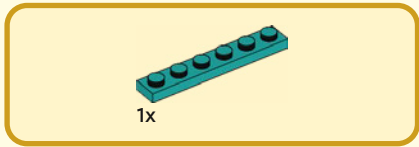

133

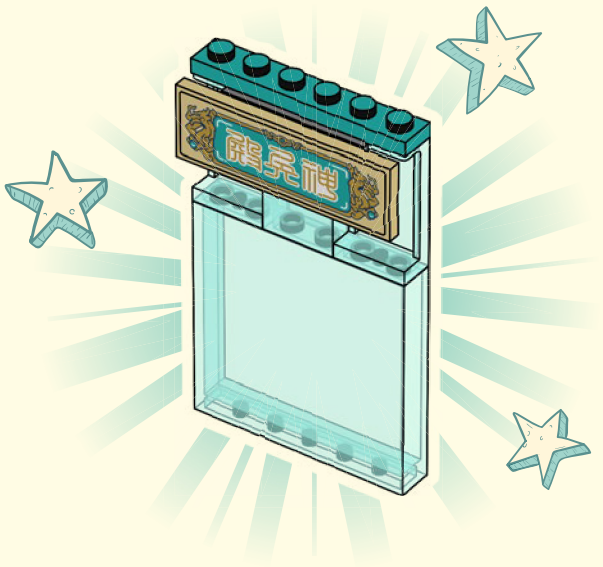

134

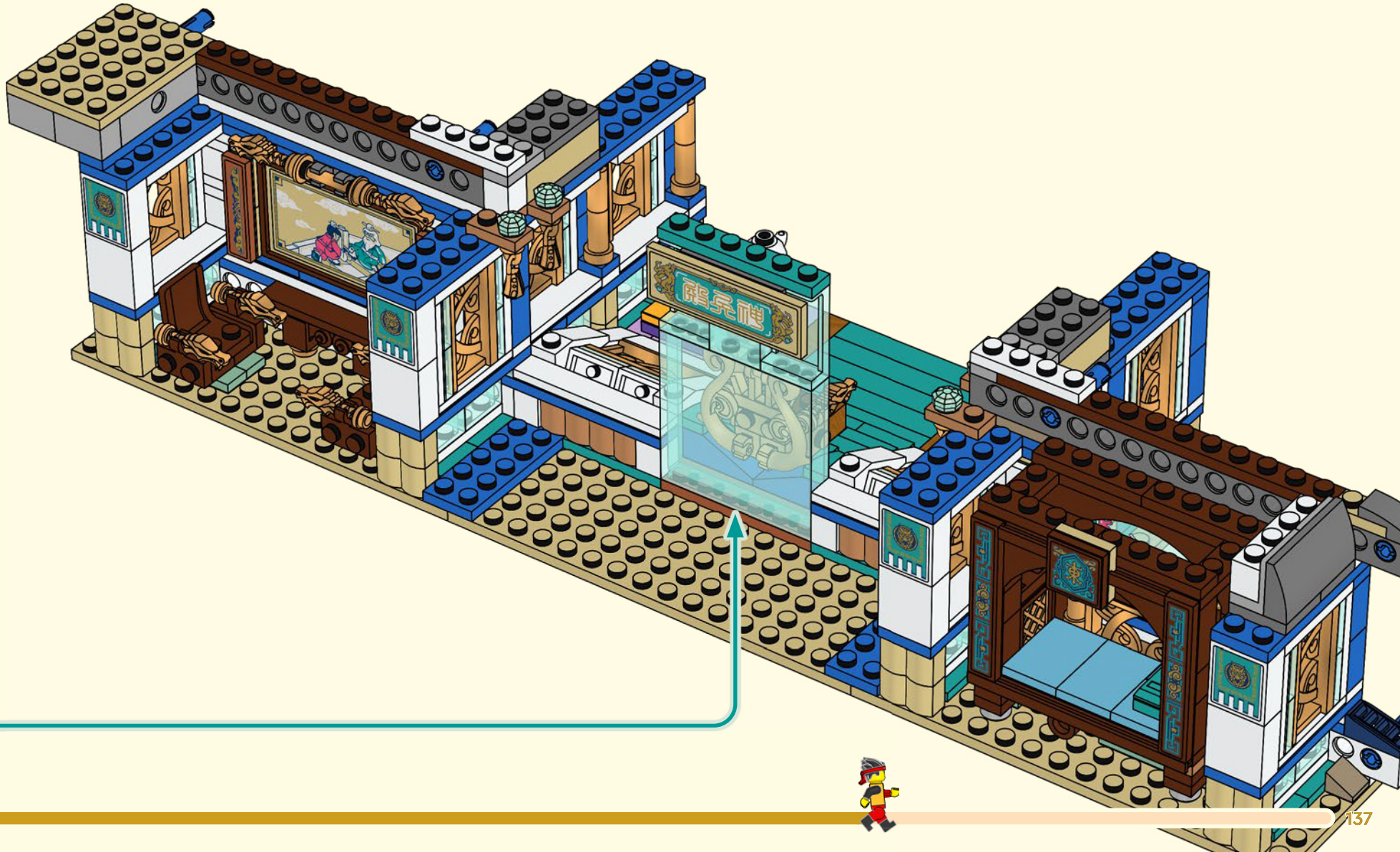



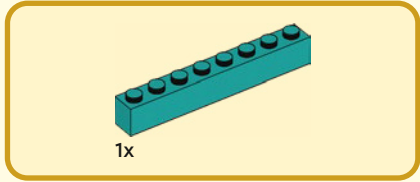

135

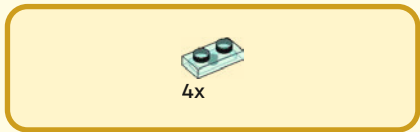
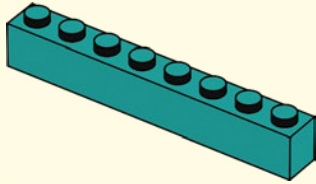

136

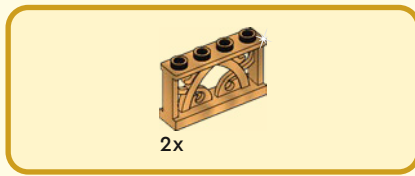
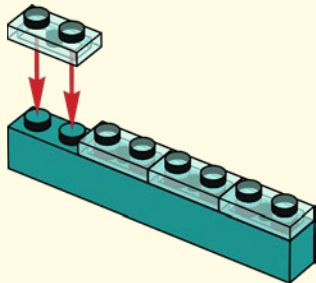

137

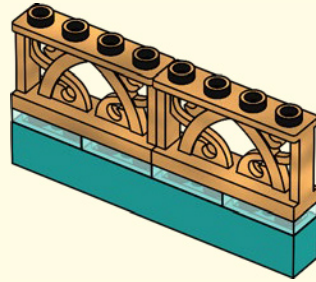

138

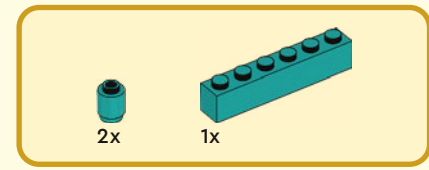
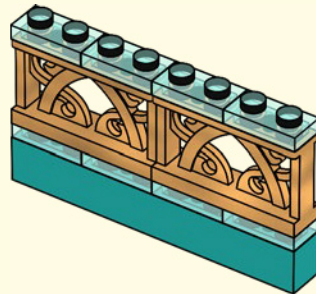

139

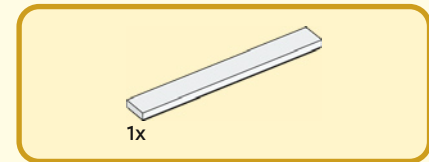
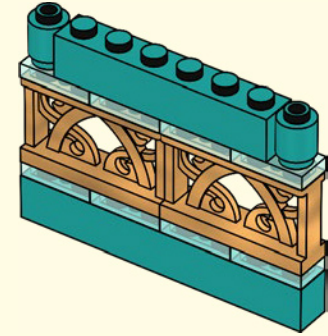

140

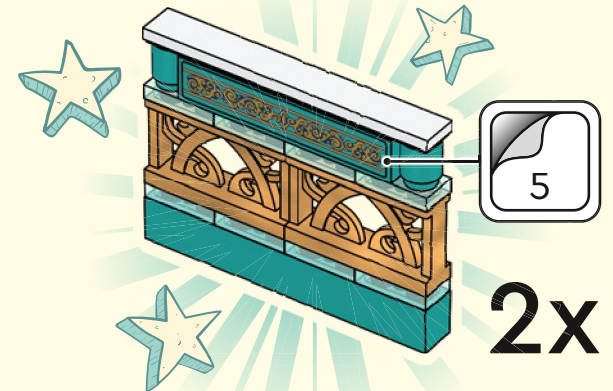

141

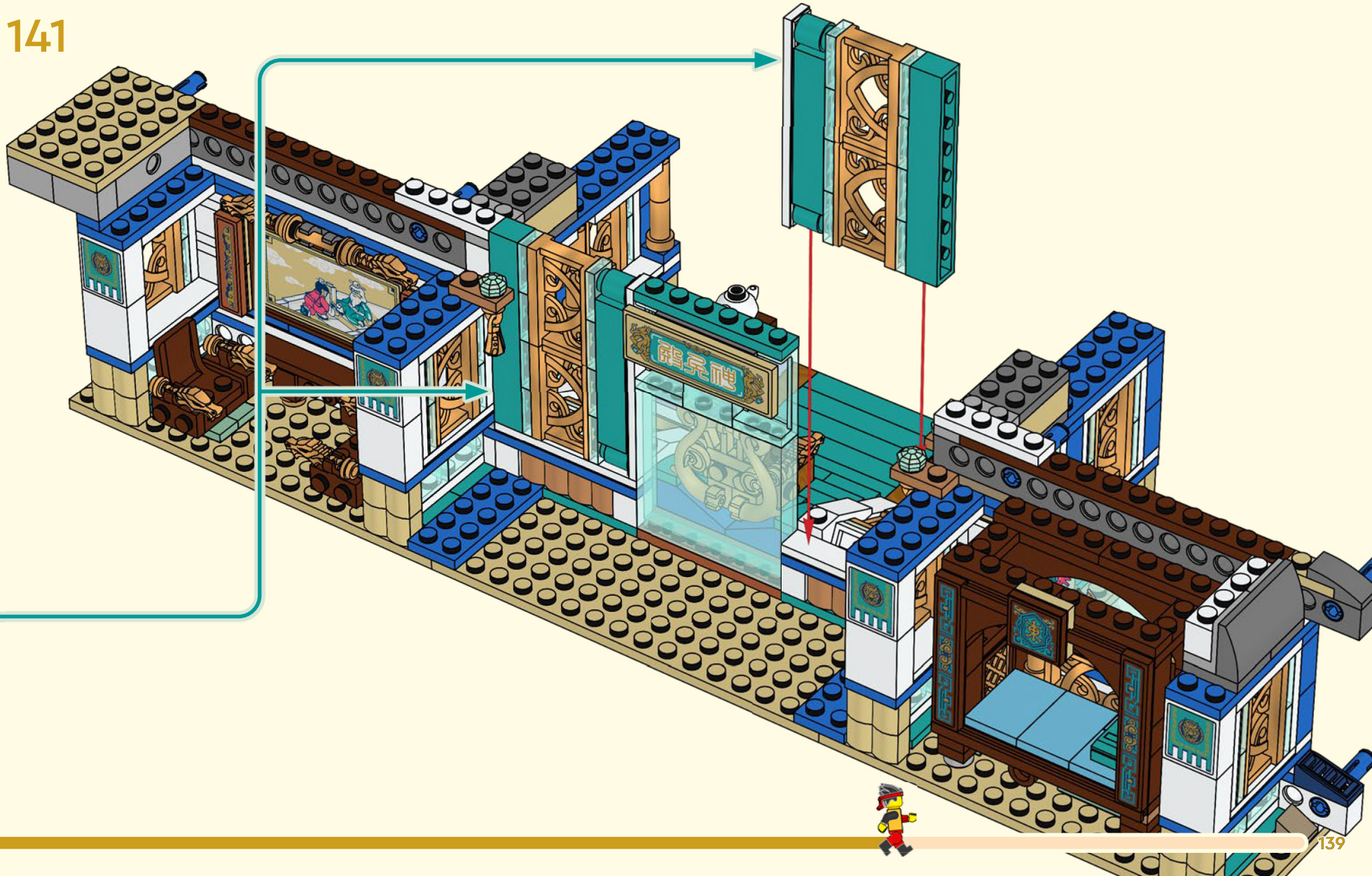





3x



3x

142

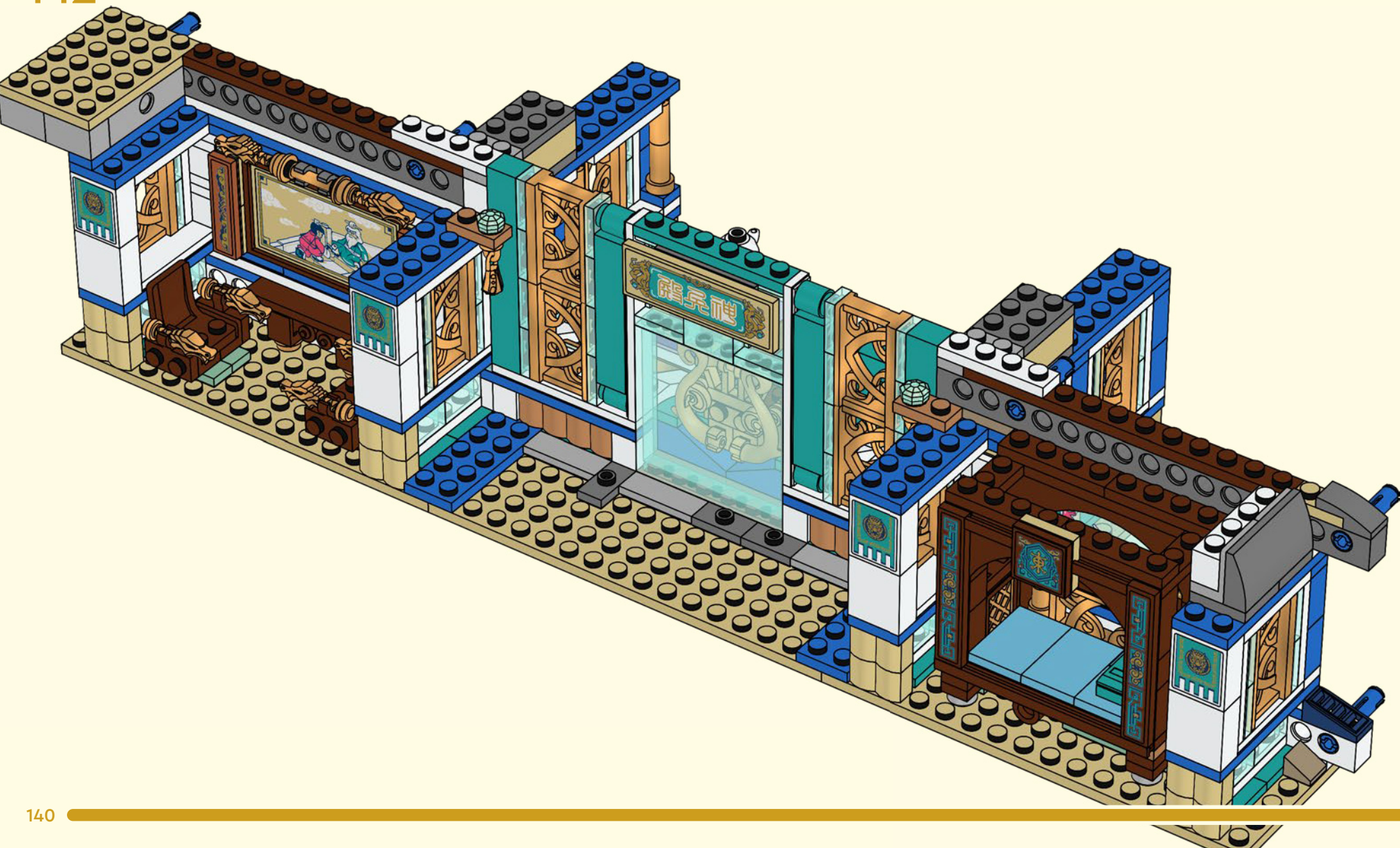





4x

143

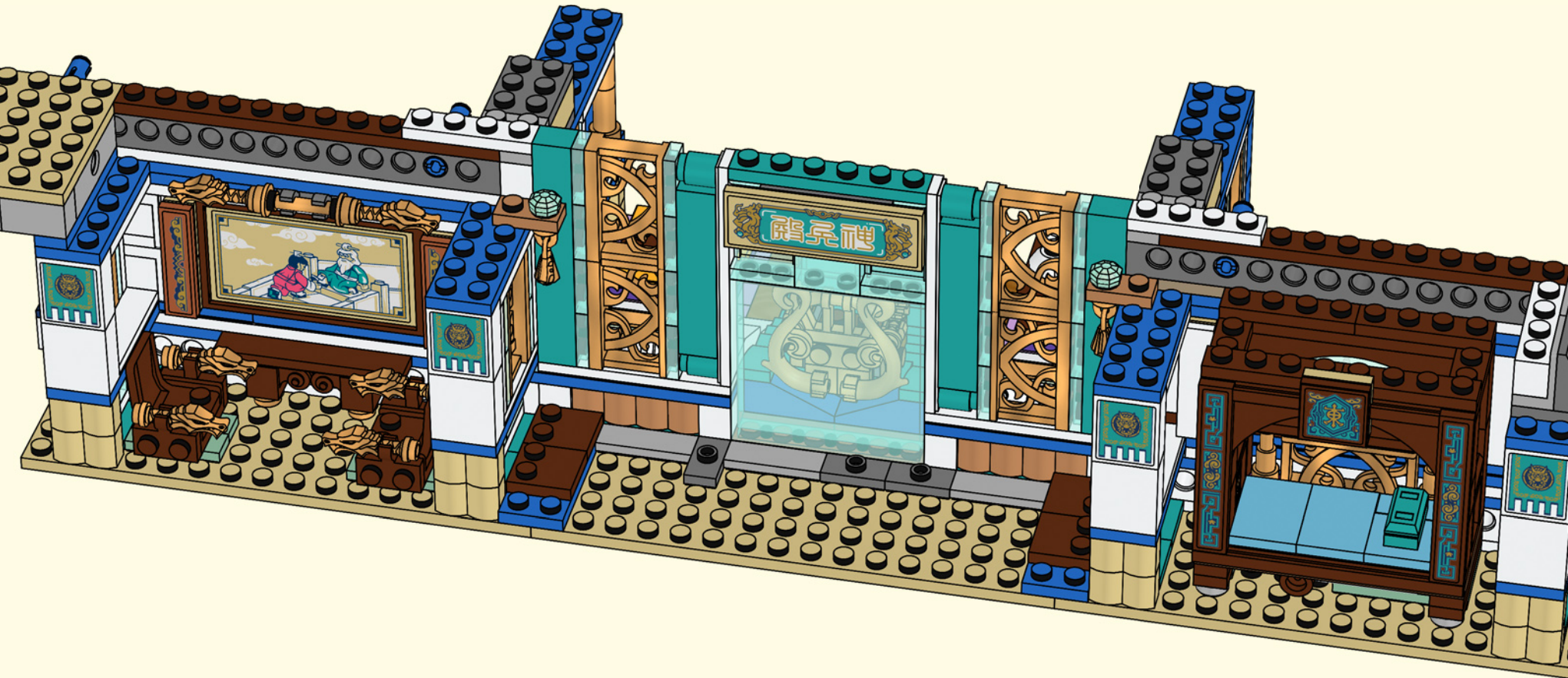



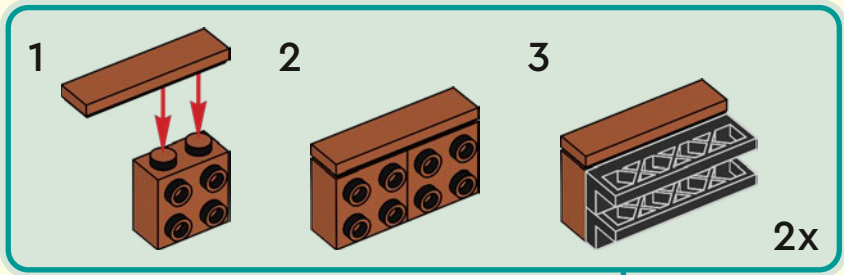
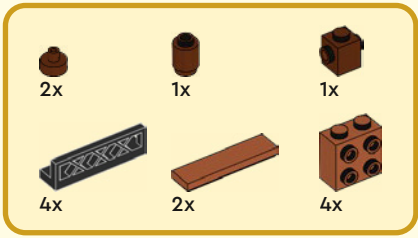

144

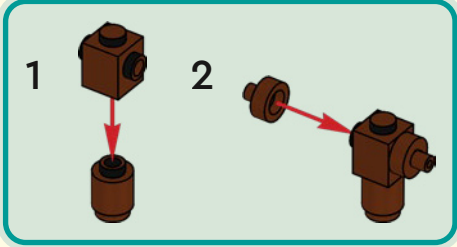
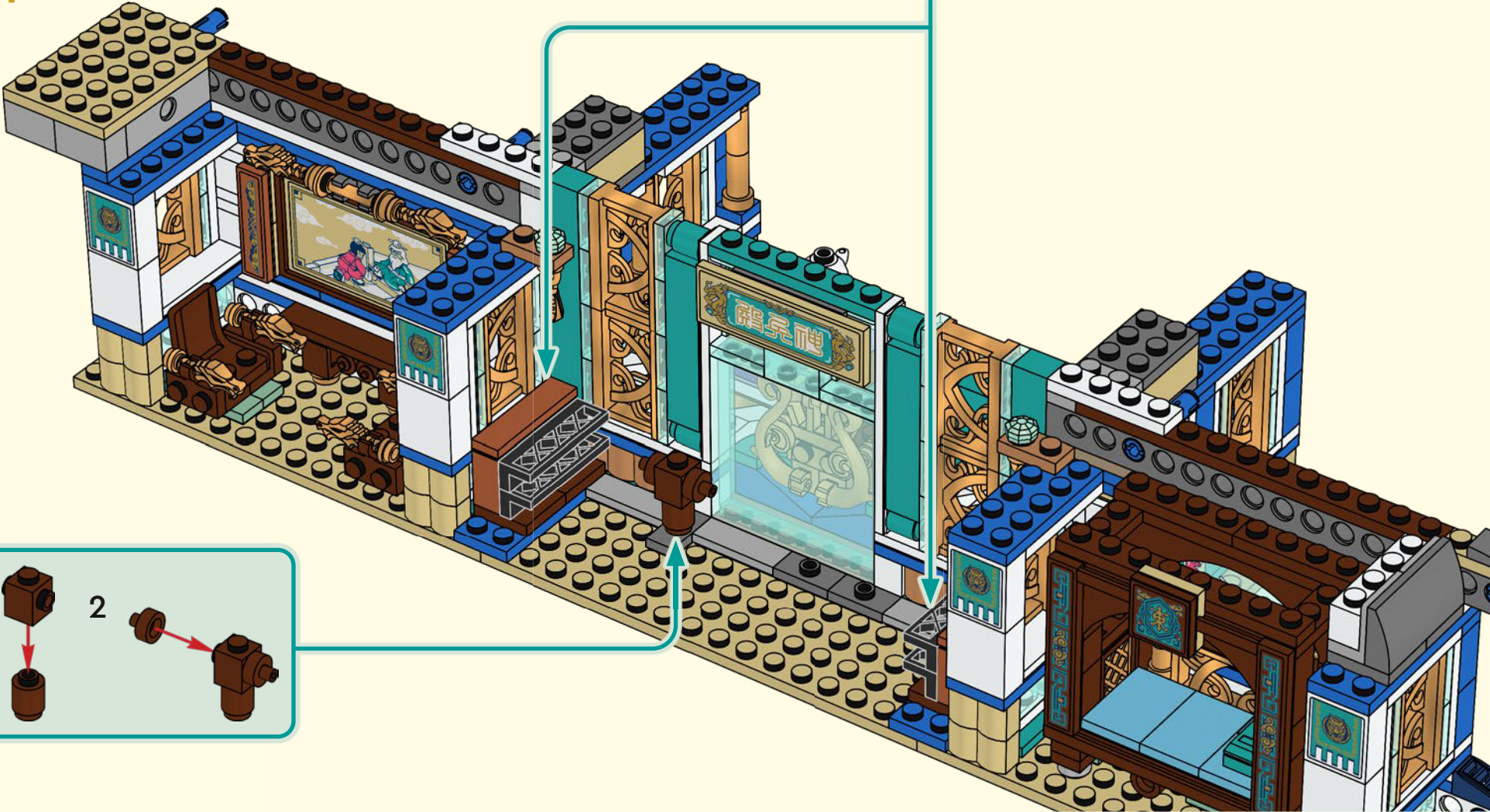



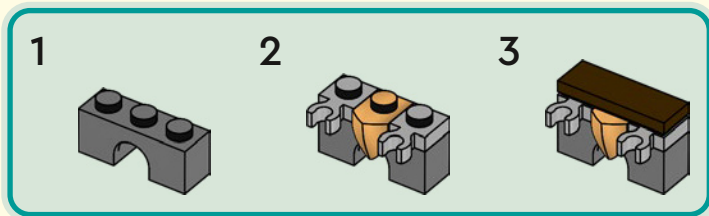
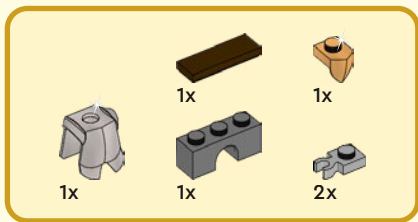

145

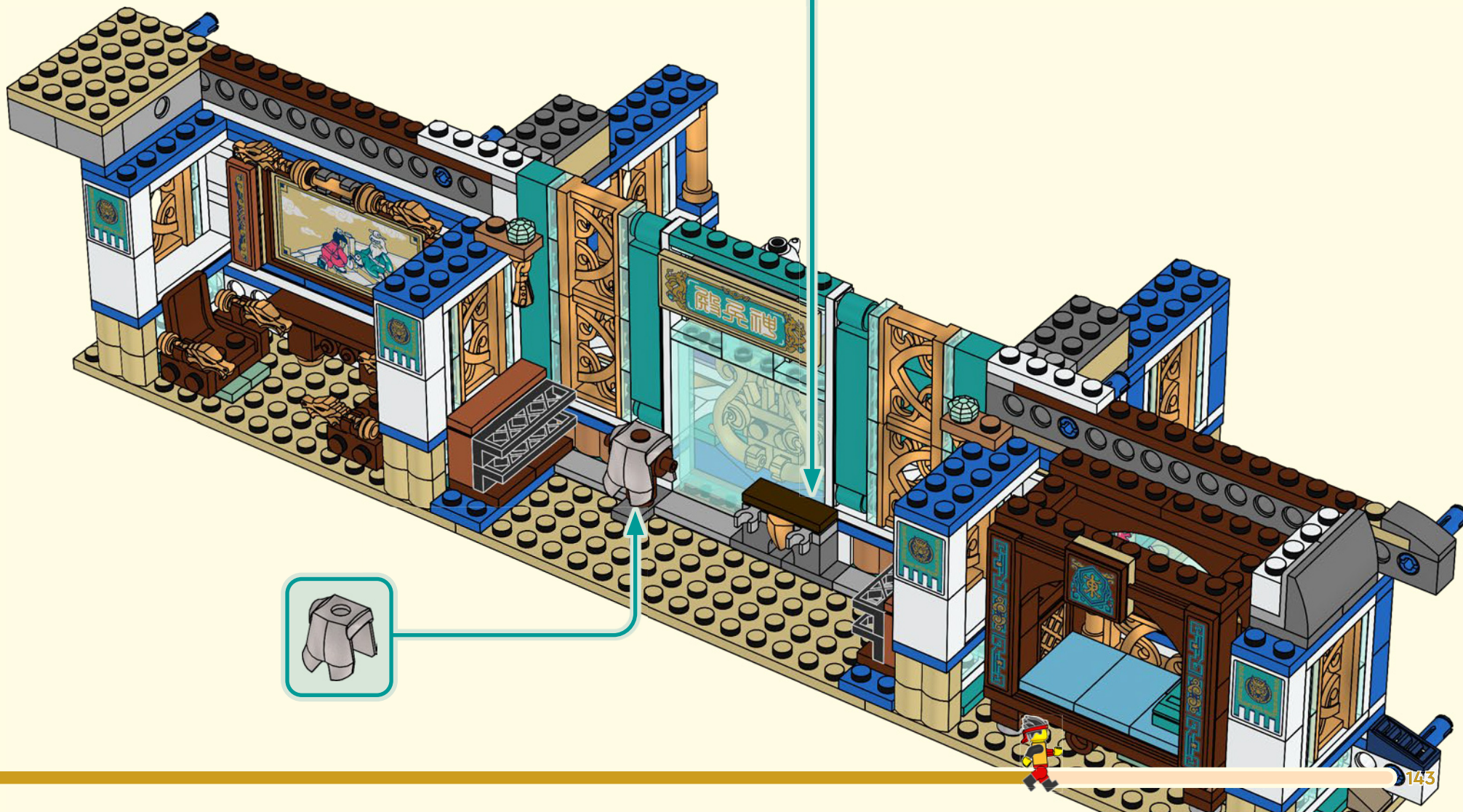



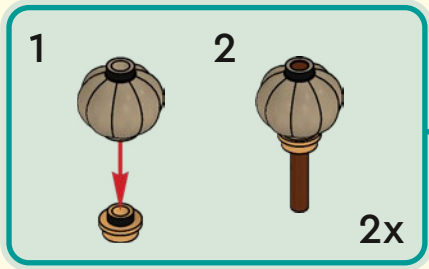

146





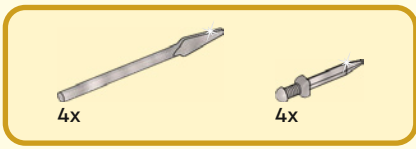

147

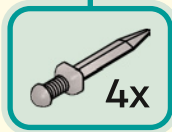
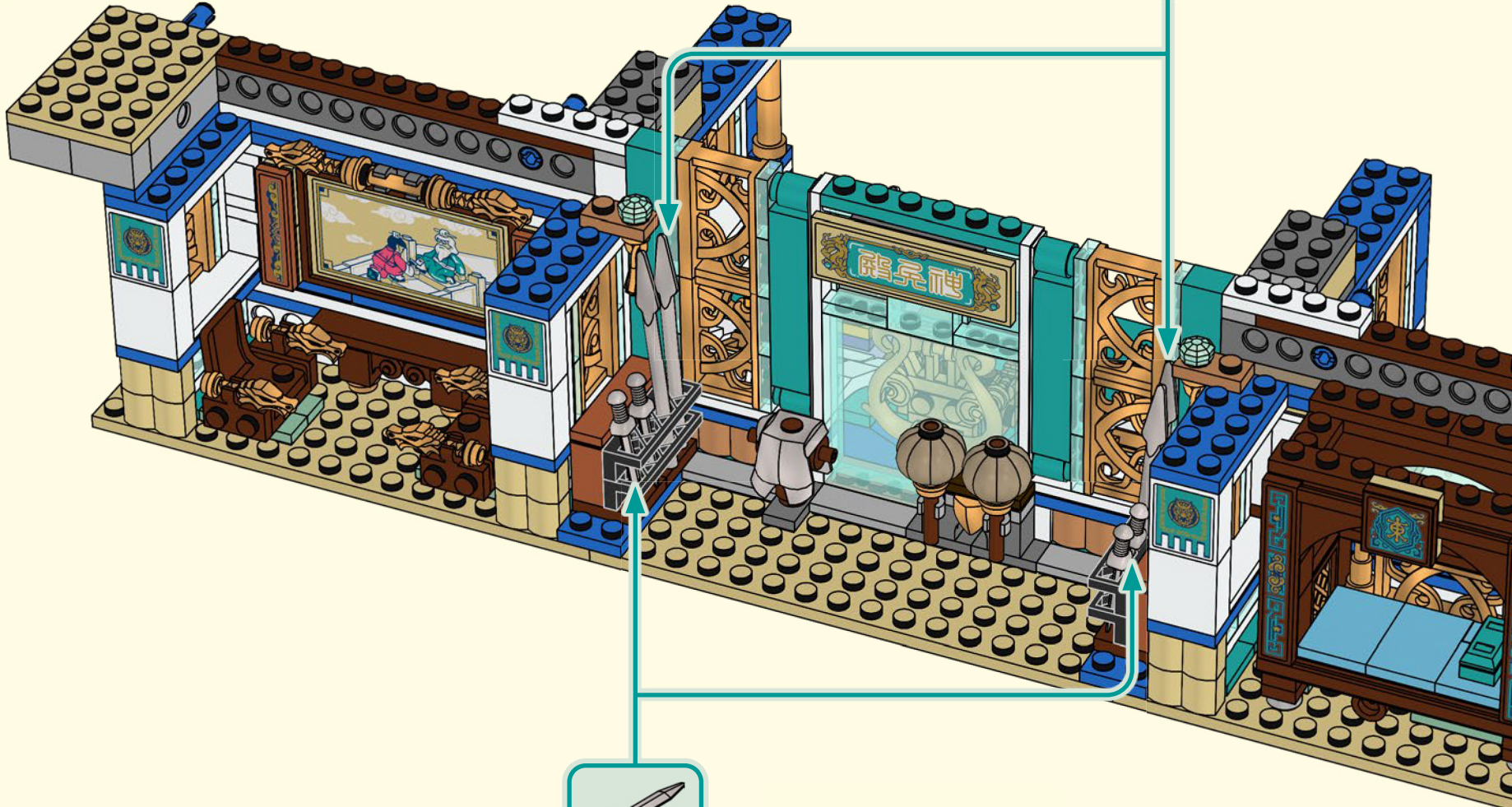
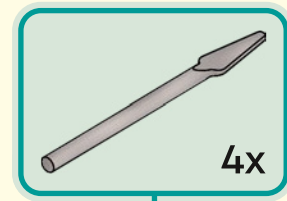



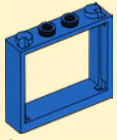

2x

148

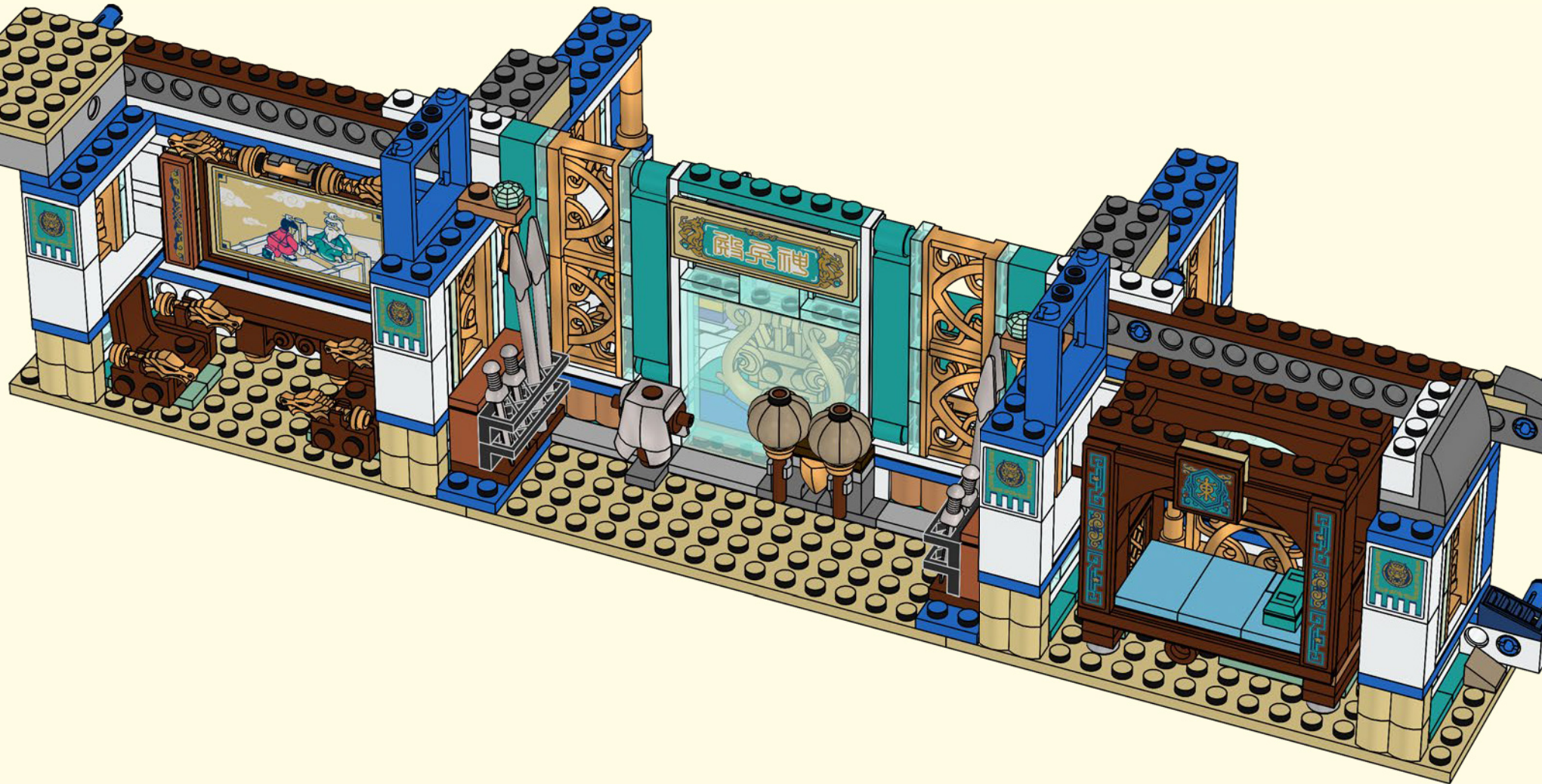

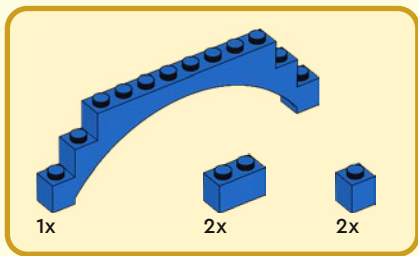

149

1

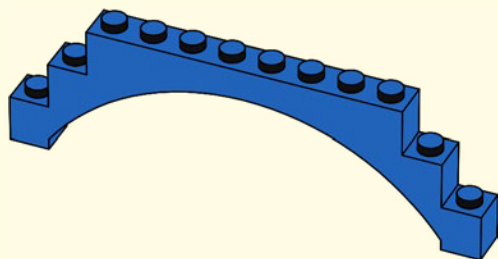

2

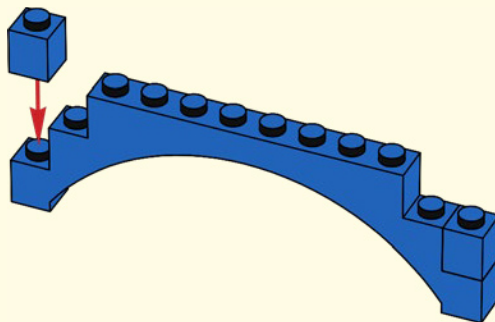

3

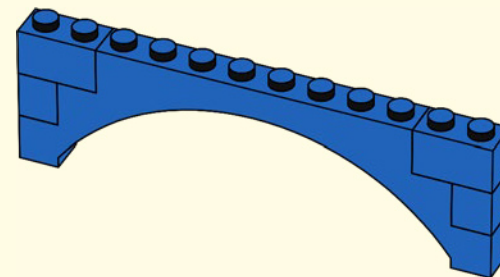



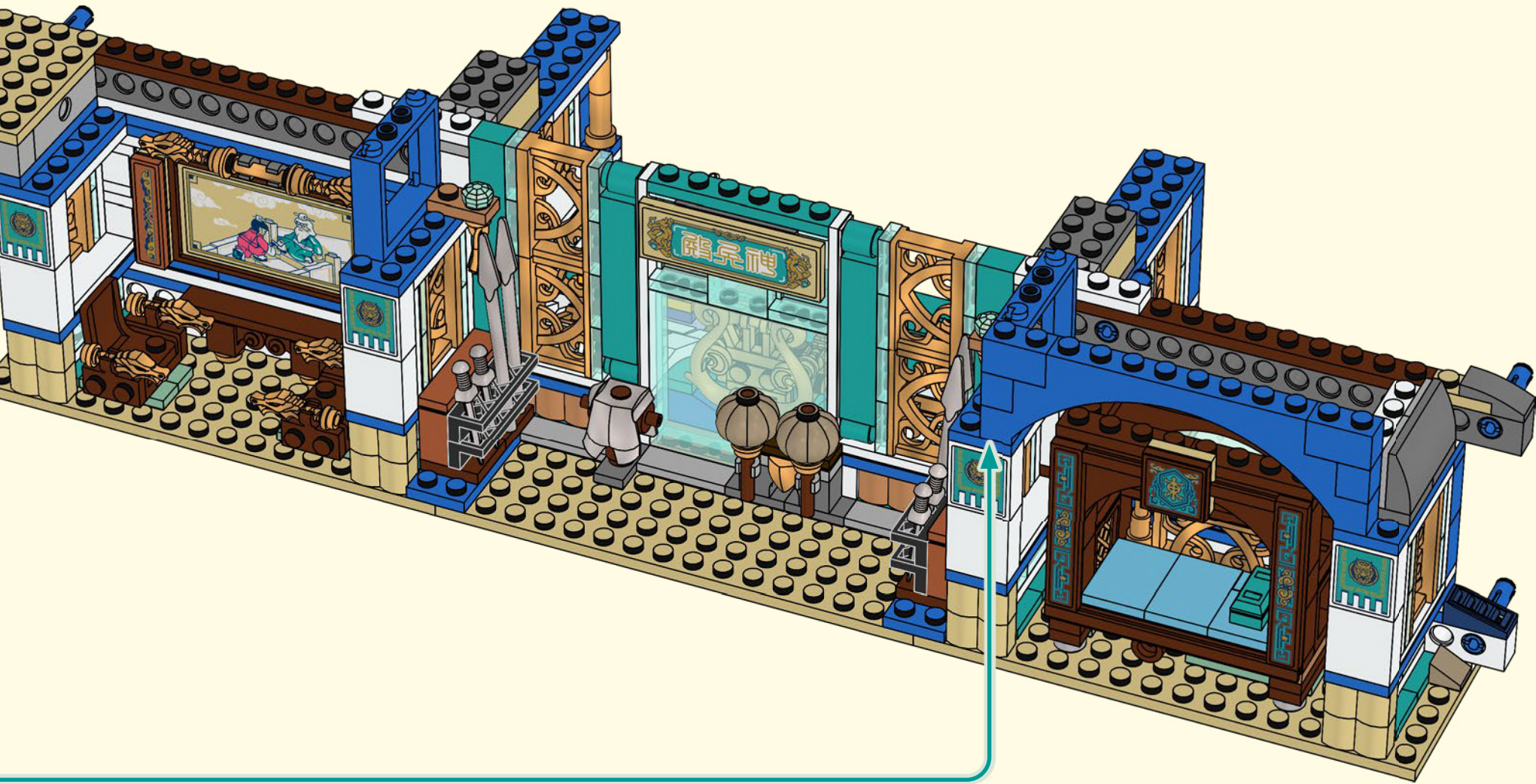

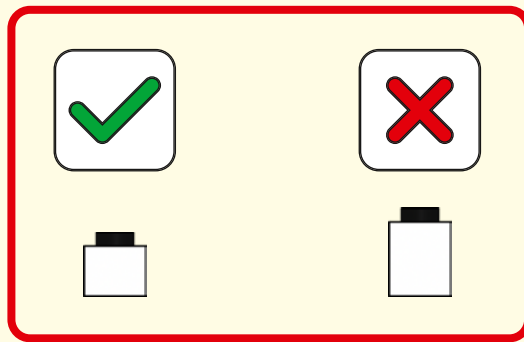
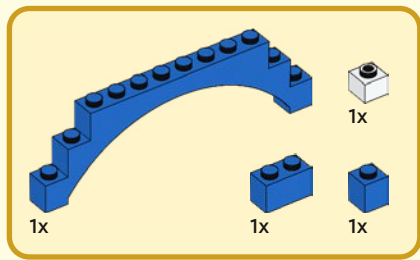

150

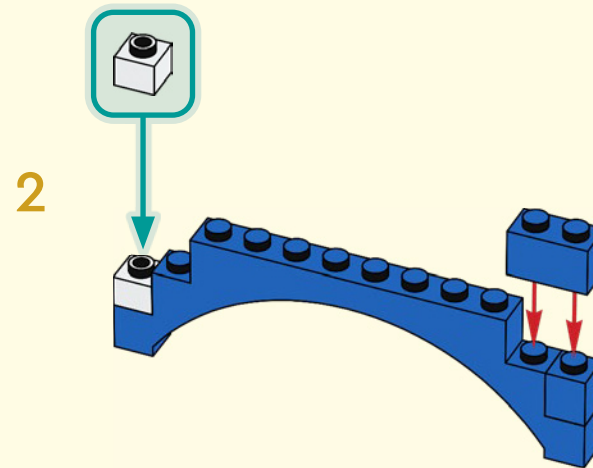
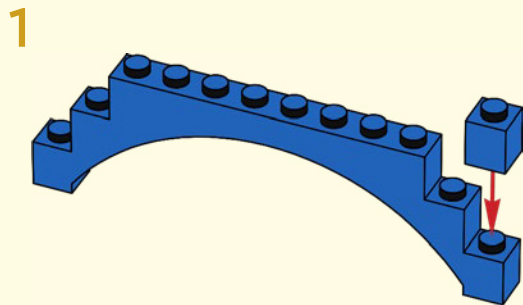



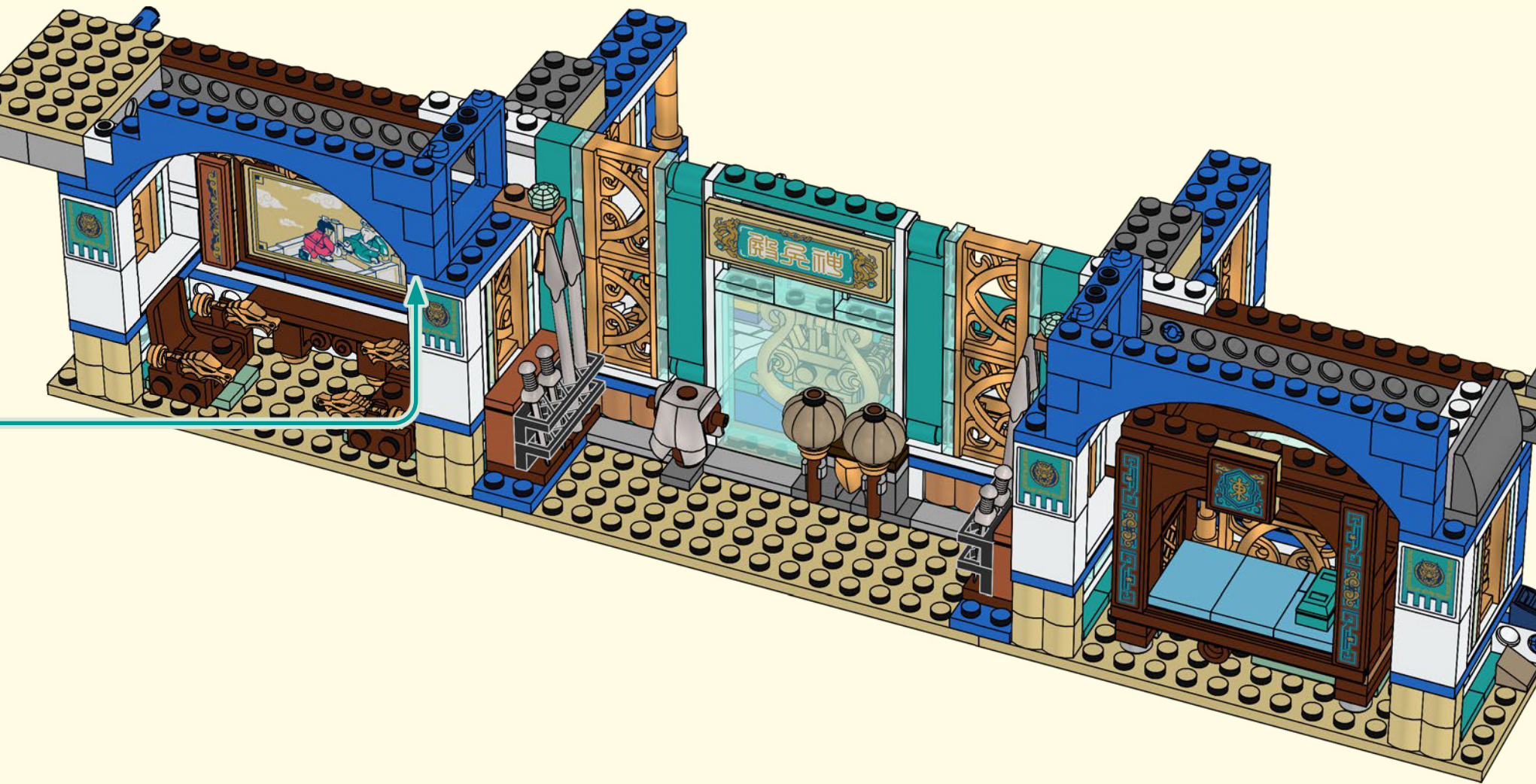



1x  2x 

151

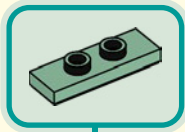
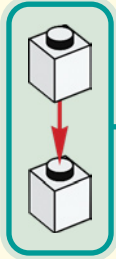



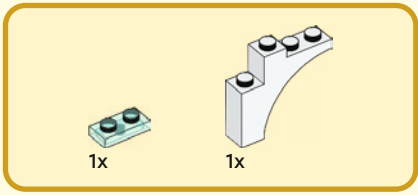

152

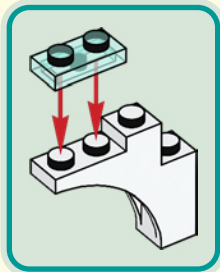

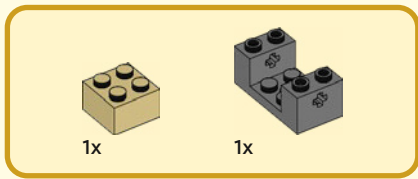

153

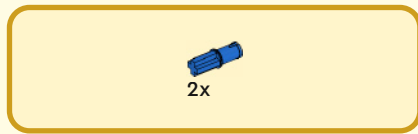
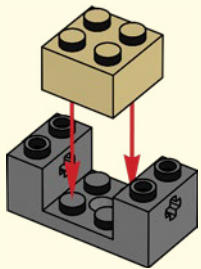

154

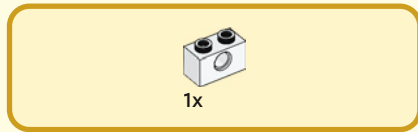
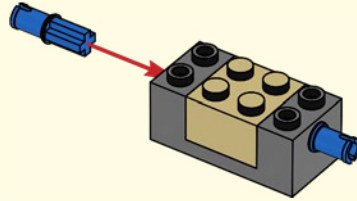

155

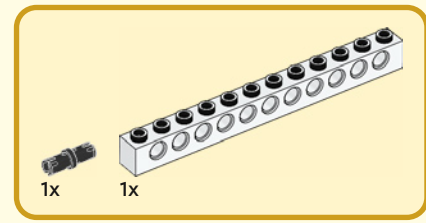
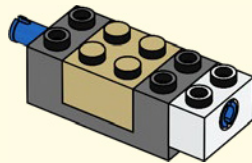

156

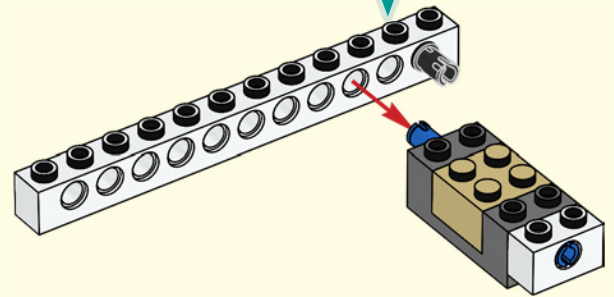
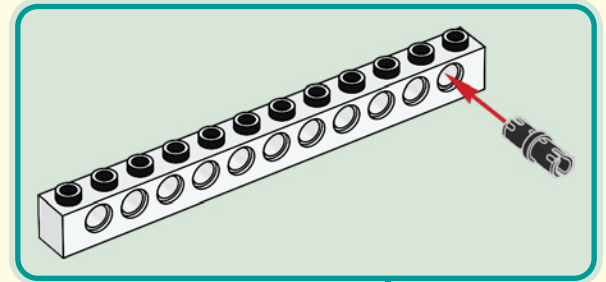



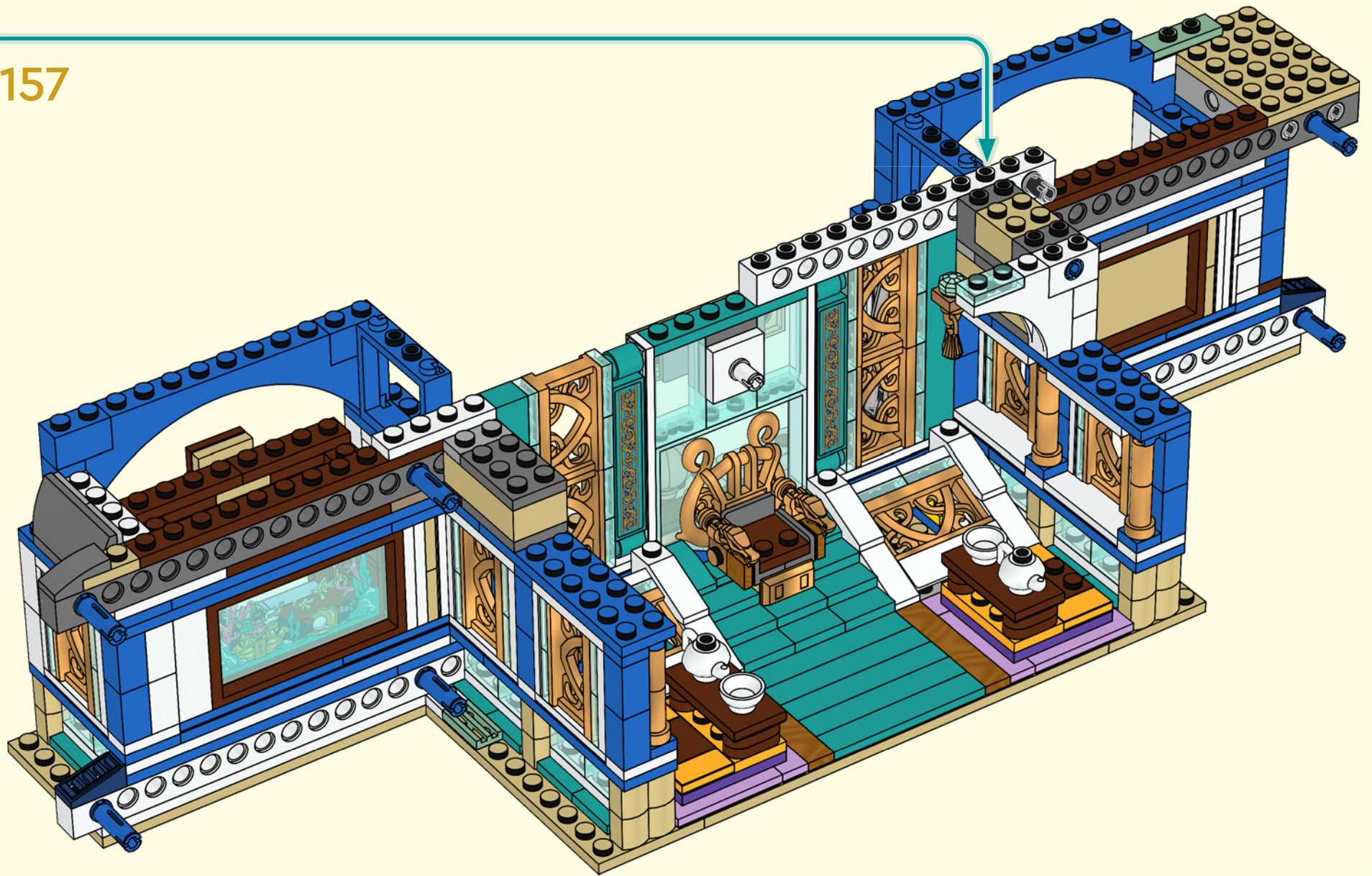



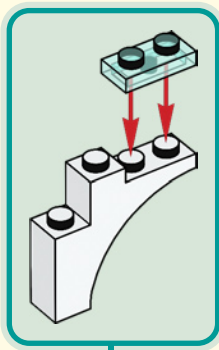
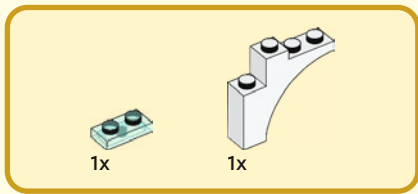

158





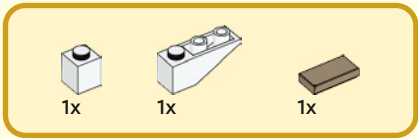

159

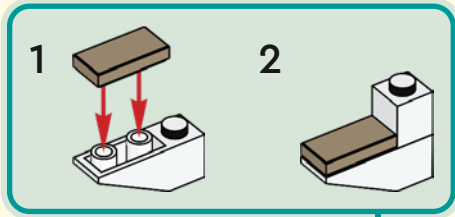

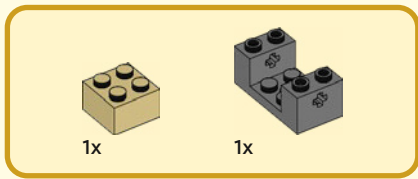

160

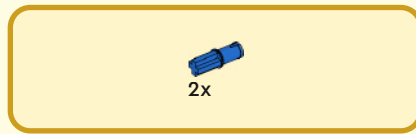
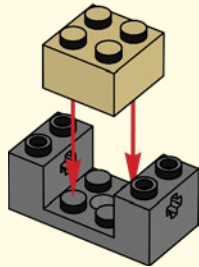

161

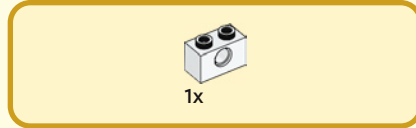
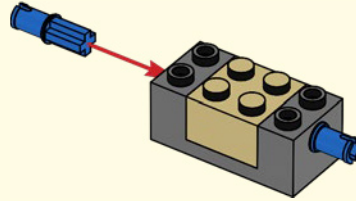

162

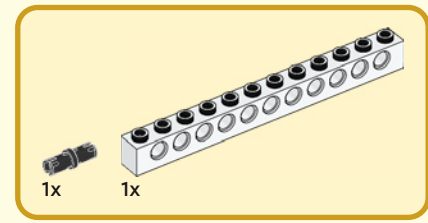
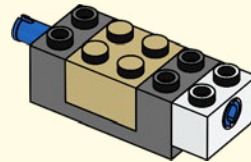

163

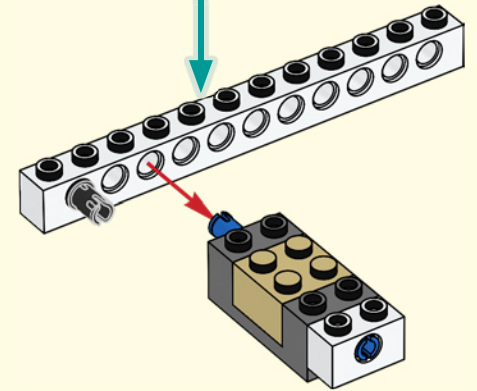
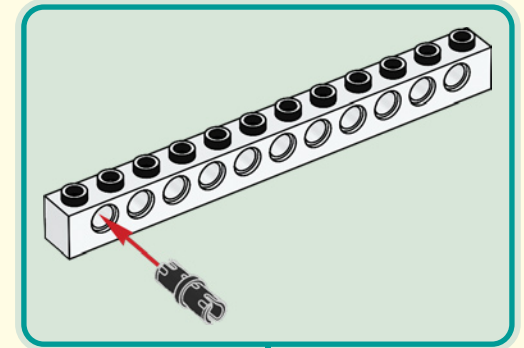



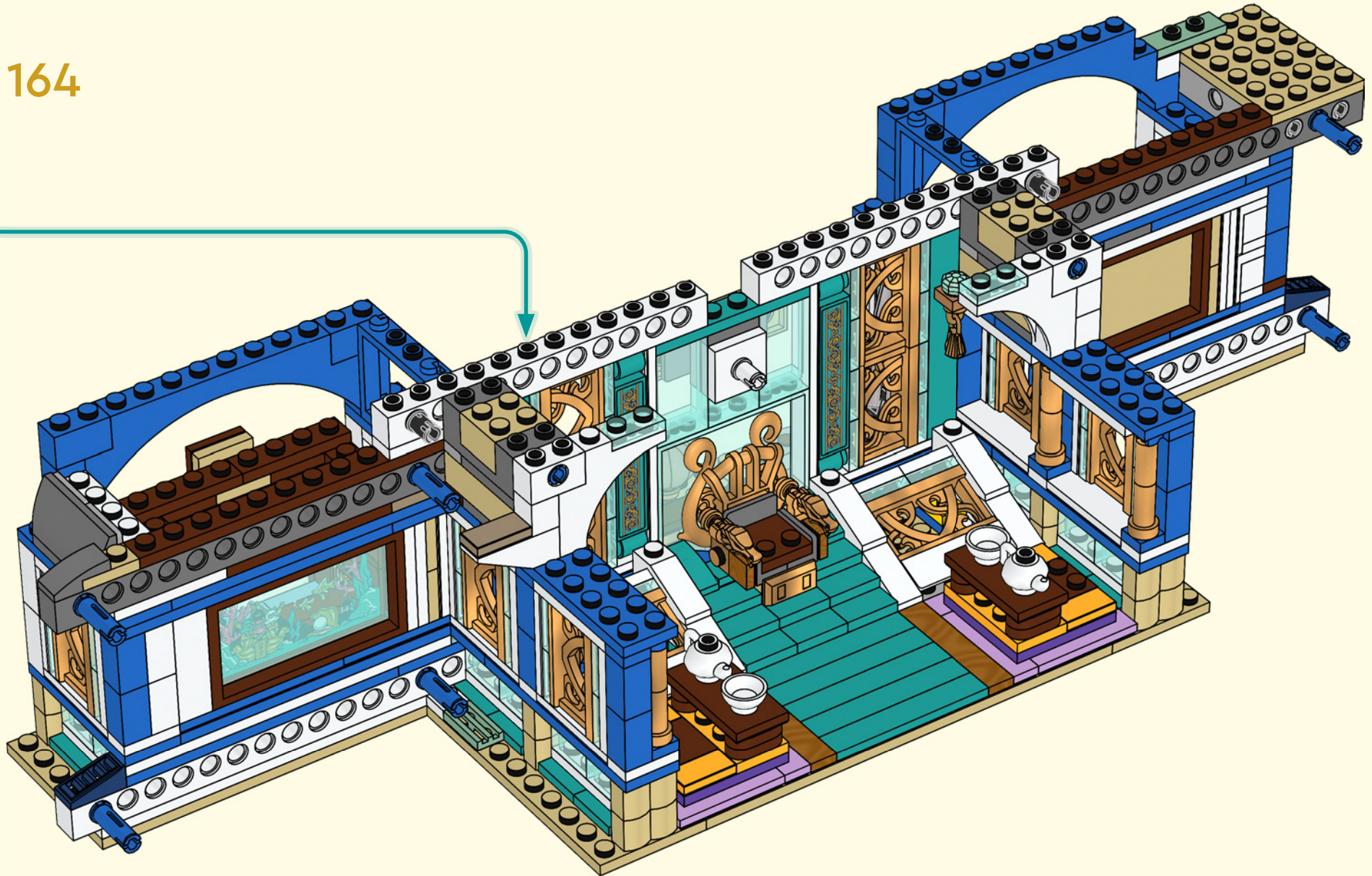



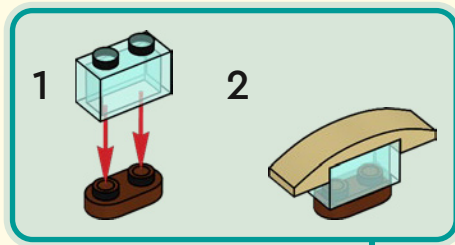
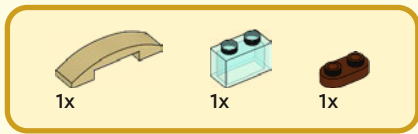

165





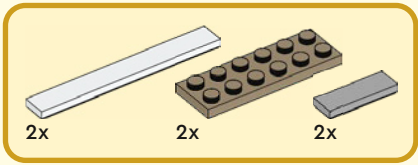

166

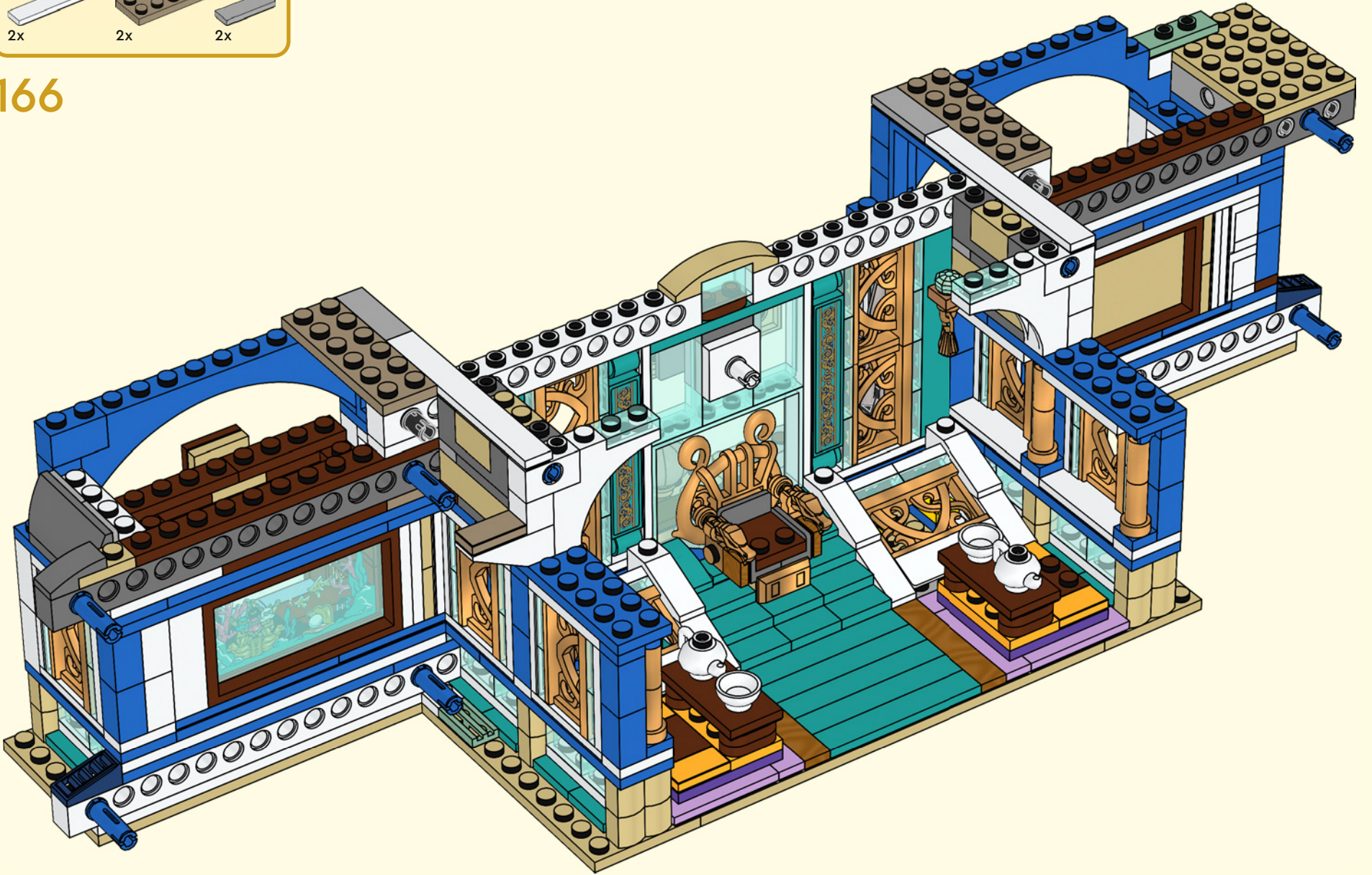



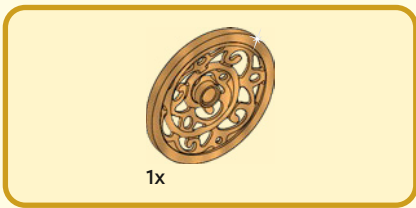

167

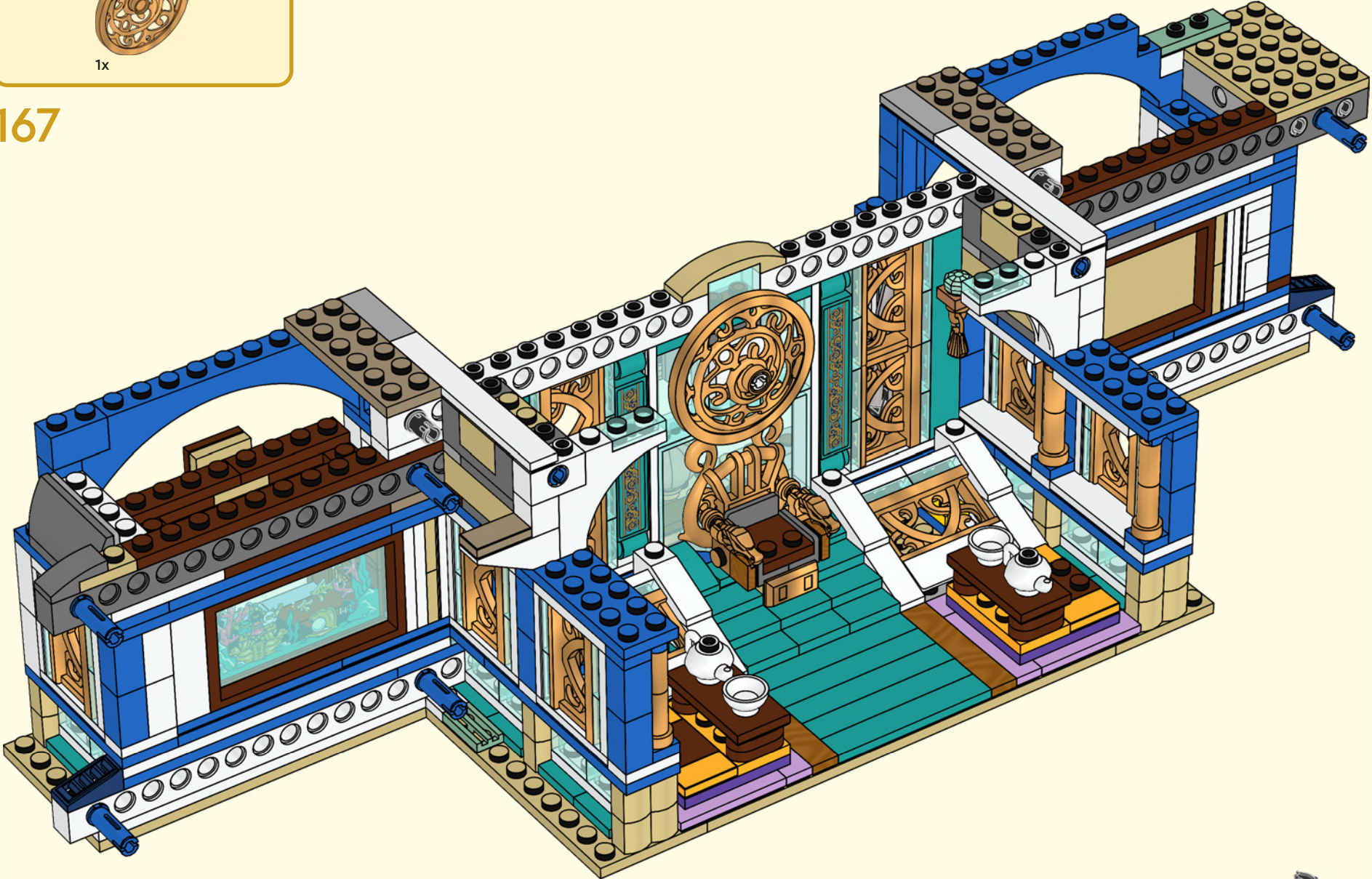



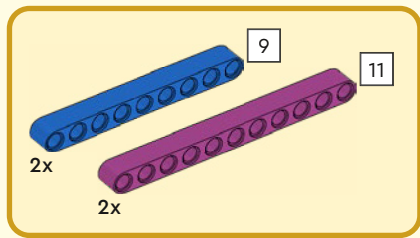

168

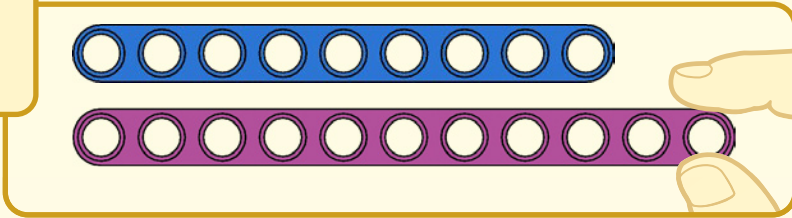



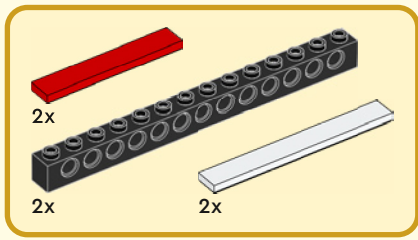

169

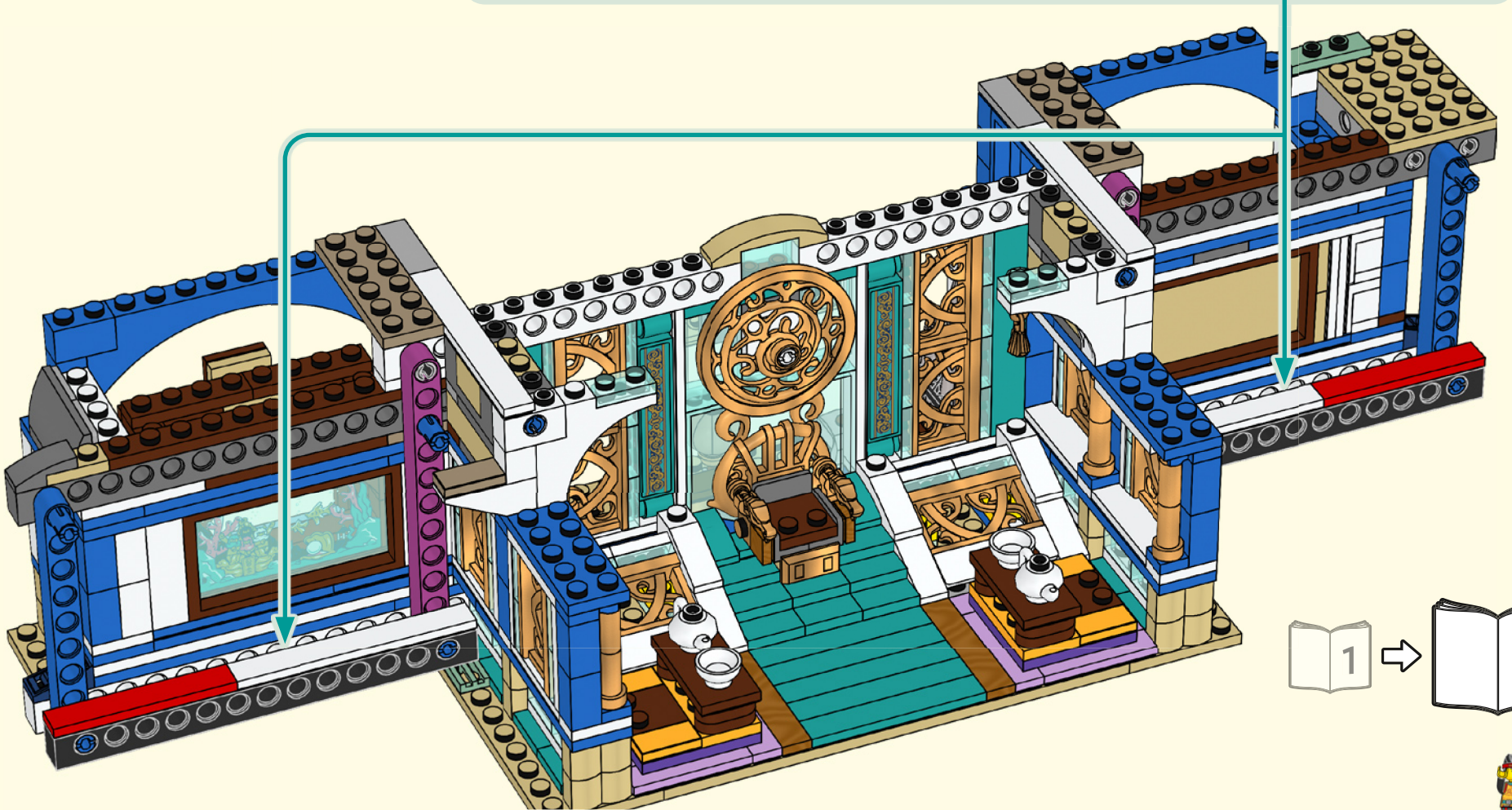
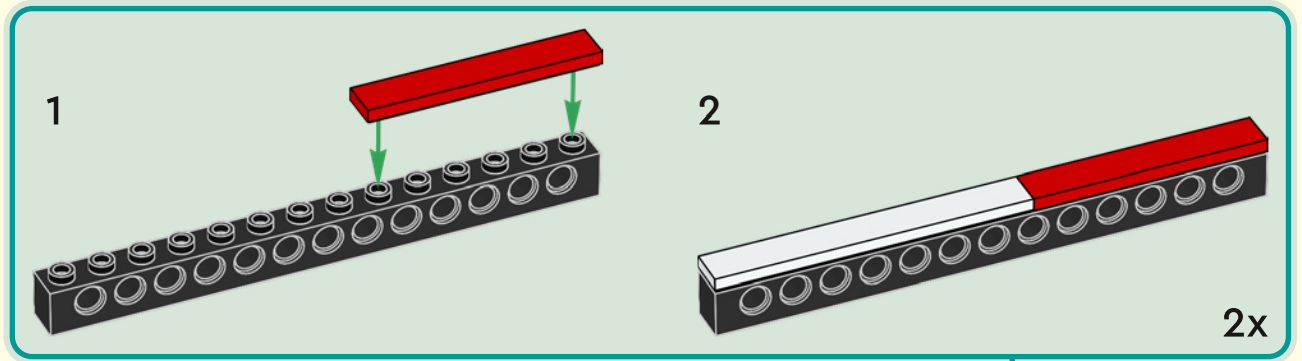



**YOU COULD WIN**



Scan this QR code or go to **LEGO.COM/PRODUCTFEEDBACK** and give us your short feedback about this LEGO® set for a chance to win a cool LEGO prize.

Terms and Conditions apply\*

**EN: YOU COULD WIN.** Terms and Conditions apply\* **DE: Du könntest GEWINNEN.** Es gelten die Teilnahmebedingungen\* **FR: Tu pourrais GAGNER.** Des conditions s'appliquent\* **IT: Potresti VINCERE tu.** Termini e condizioni sono applicabili\* **ES: Puedes GANAR.** Aplican términos y condiciones\* **PT: Poderá GANHAR.** Aplicam-se termos e condições\* **ZH: 轻松获奖. 条款和条件适用\*** **PL: Szansa na WYGRANĄ.** Obowiązują warunki korzystania\* **CS: Máte šanci VYHRÁT.** Platí všeobecné smluvní podmínky\* **SK: Máte šancu VYHRAŤ.** Platia všeobecné zmluvné podmienky\* **HU: TE IS NYERHETSZ.** Felhasználási feltételek érvényesek\* **RO: Ai putea CÂȘTIGA.** Se aplică termenii și condițiile\* **BG: Можете да СПЕЧЕЛИТЕ.** Има определени правила и условия\* **LV: Tu vari LAIMĒT.** Ir spēkā noteikumi un nosacījumi.\* **ET: Sul on võimalus VÕITA.** Kehtivad tingimused\* **LT: Jūs galite LAIMĖTI.** Taikomos sąlygos\*

\*[LEGO.com/productfeedback-terms](https://www.lego.com/productfeedback-terms)

LEGO and the LEGO logo are trademarks of the/son des marques de commerce du/son marcas registradas de LEGO Group. ©2023 The LEGO Group.