



Disney · PIXAR  
**TOY**  
STORY



7590



1

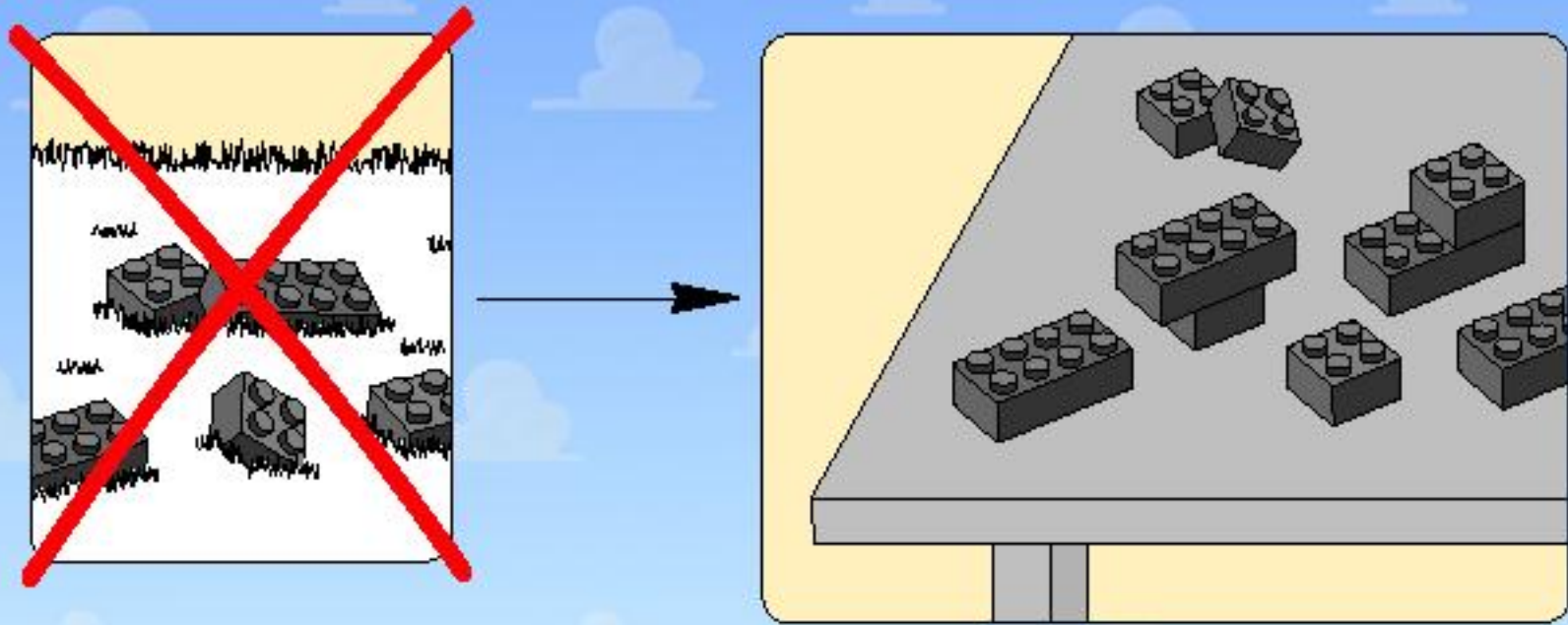

2

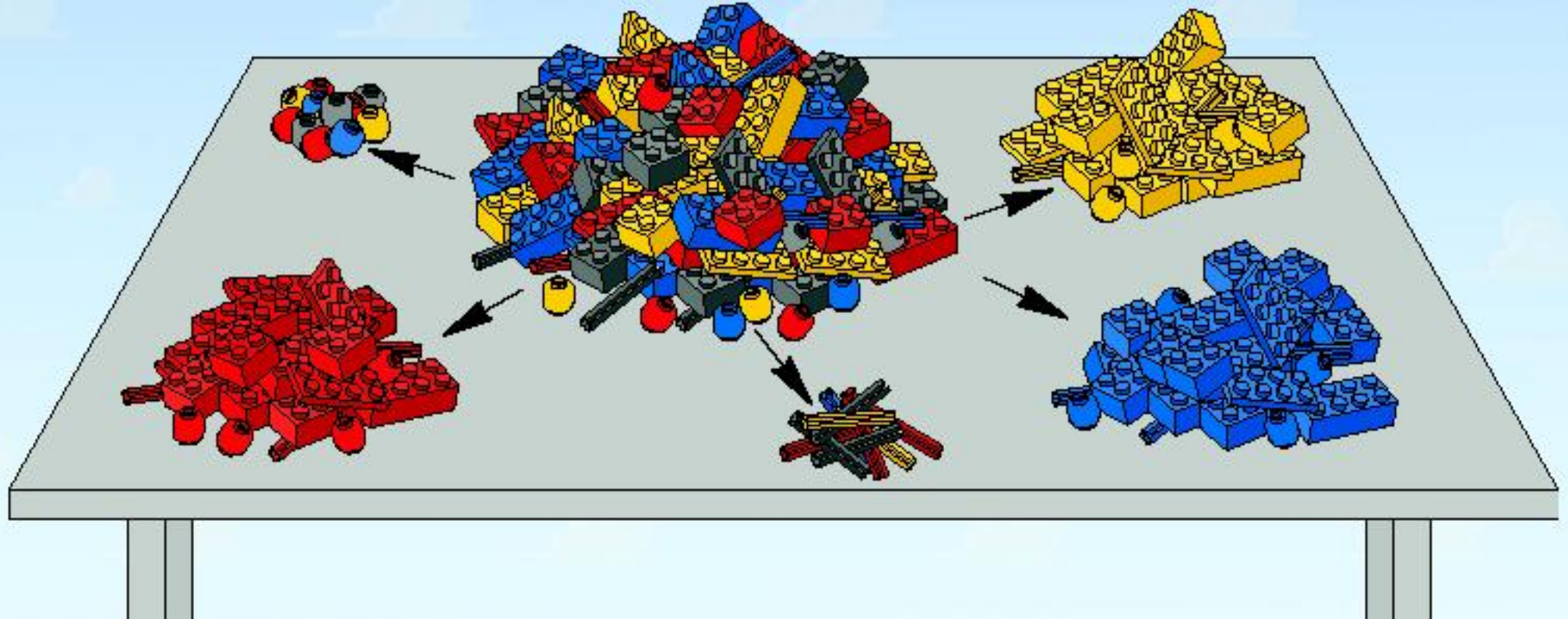

3

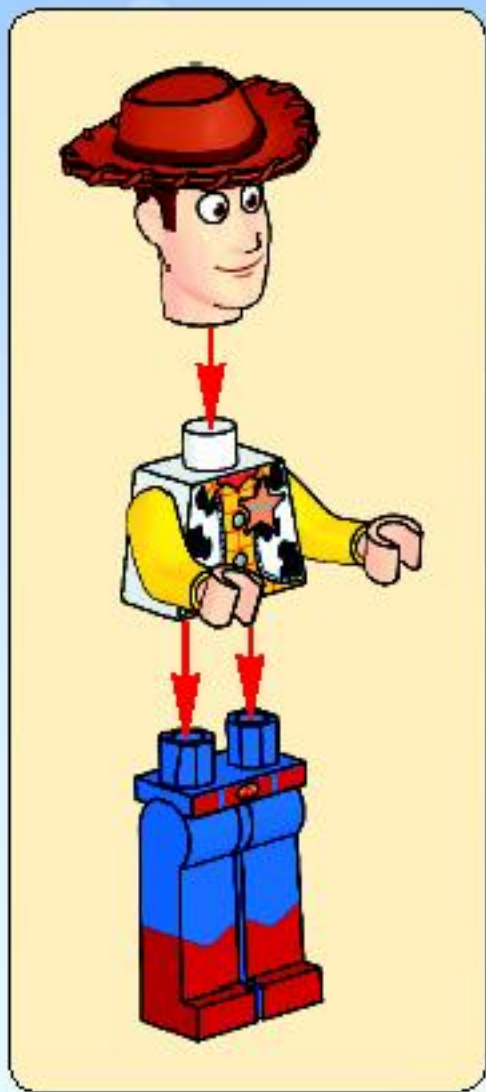

1

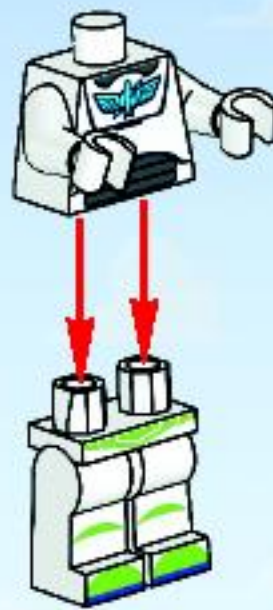

2

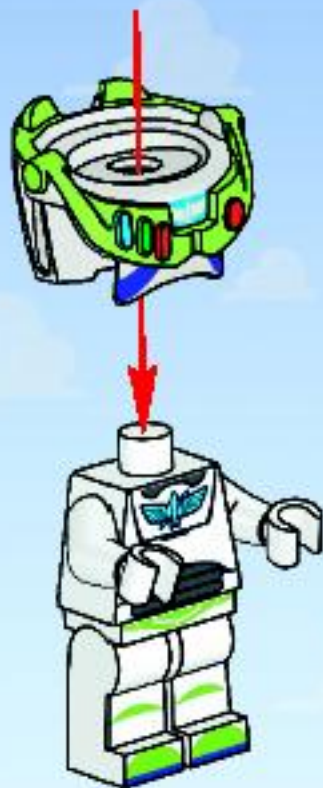

3

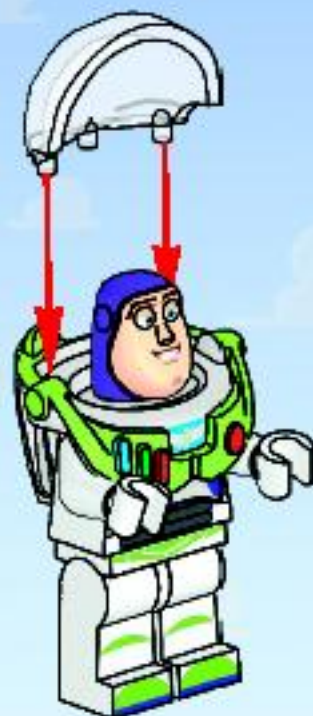

4

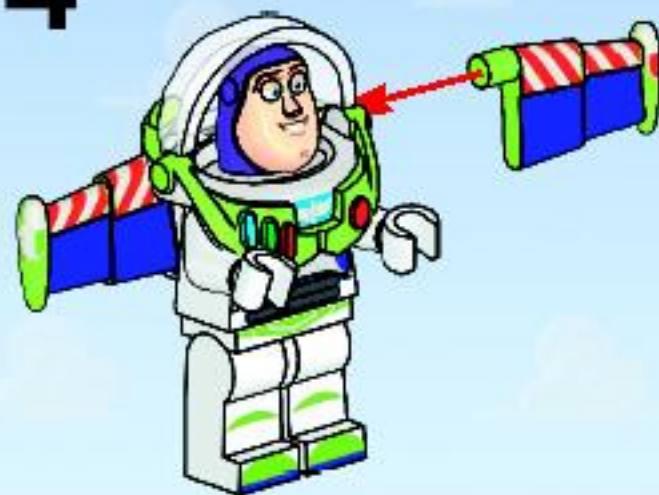



1



2



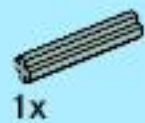

3

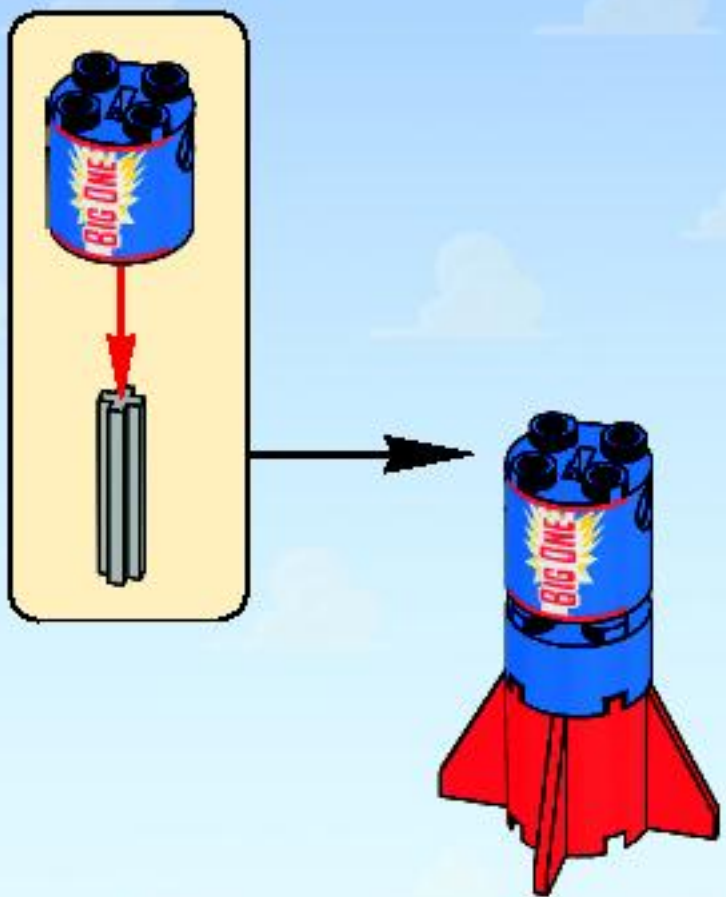

1x

4





5



6

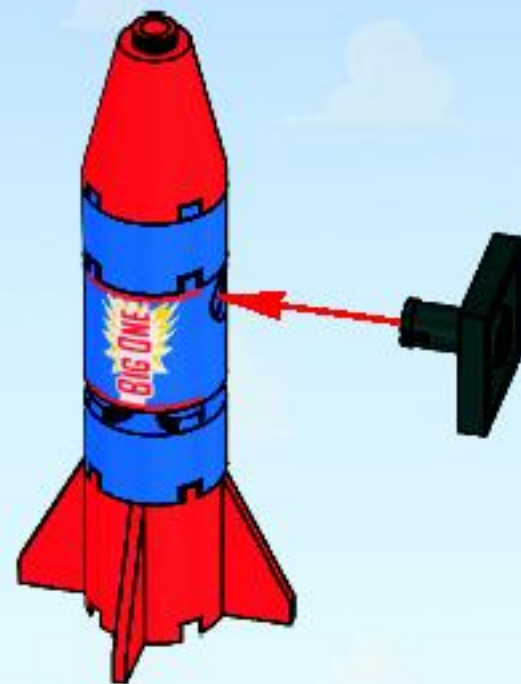

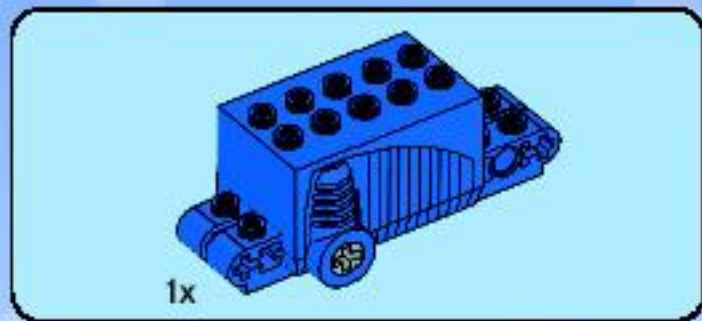

1

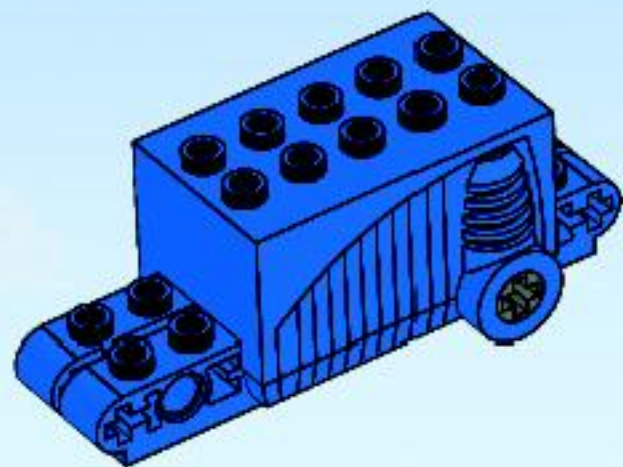





2

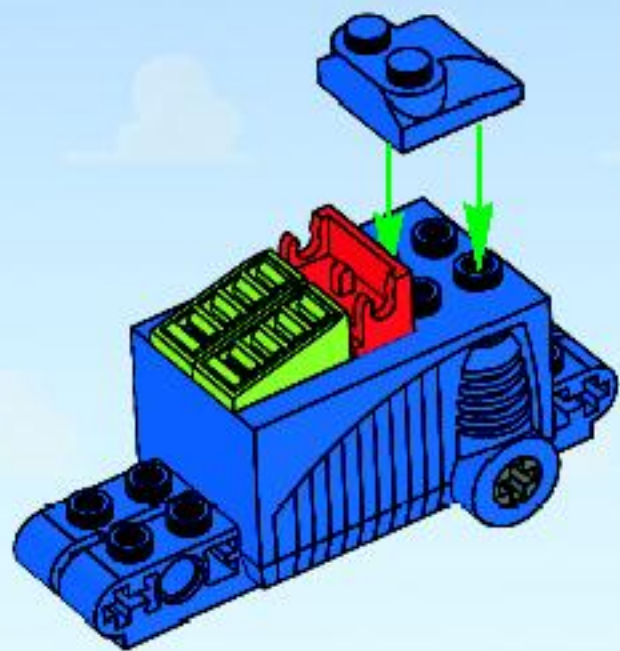

3

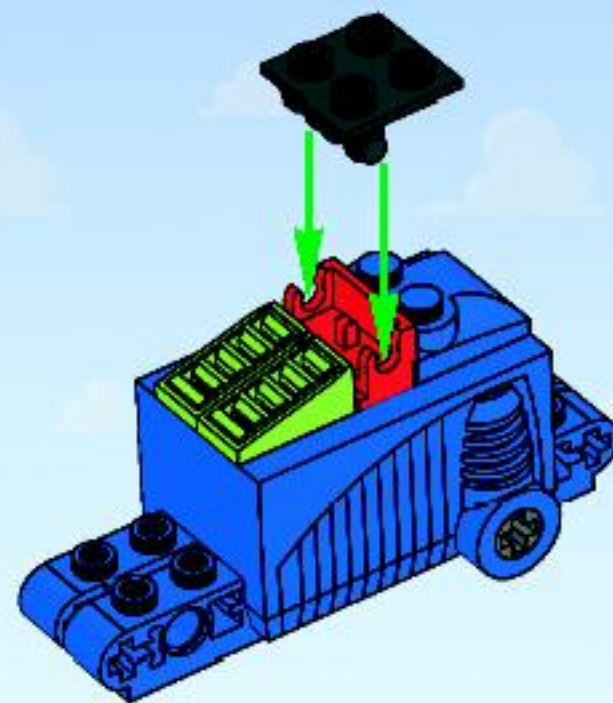



4

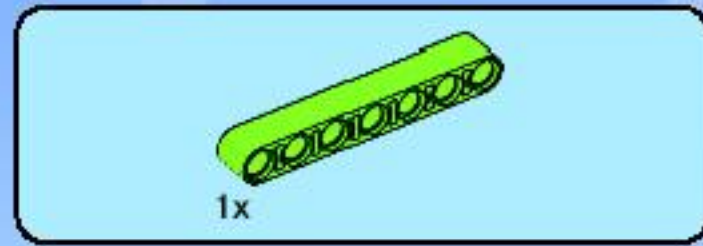
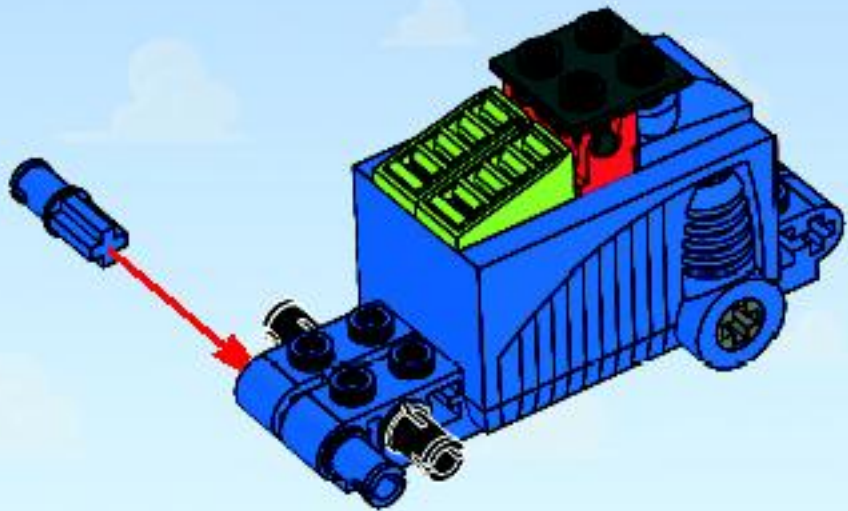

5

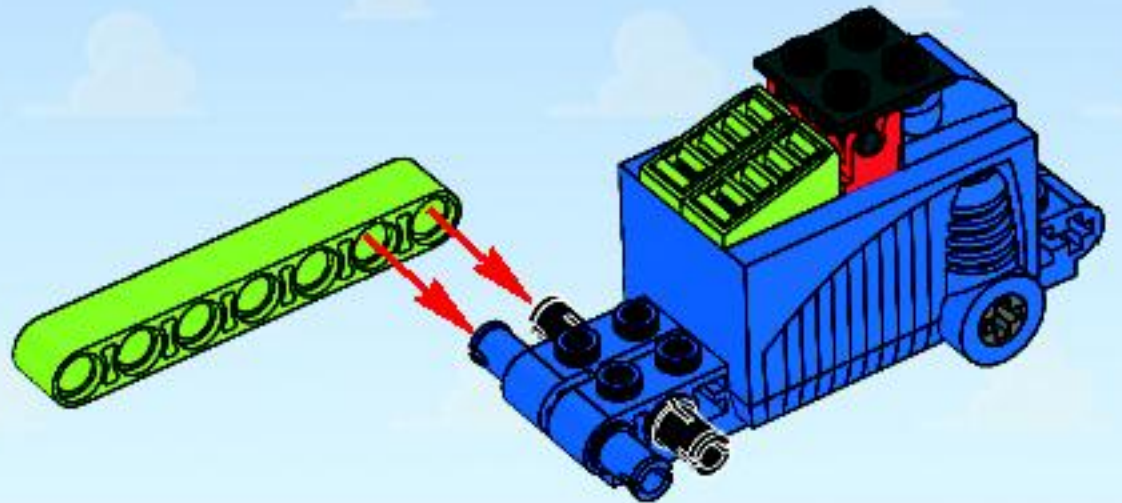



6

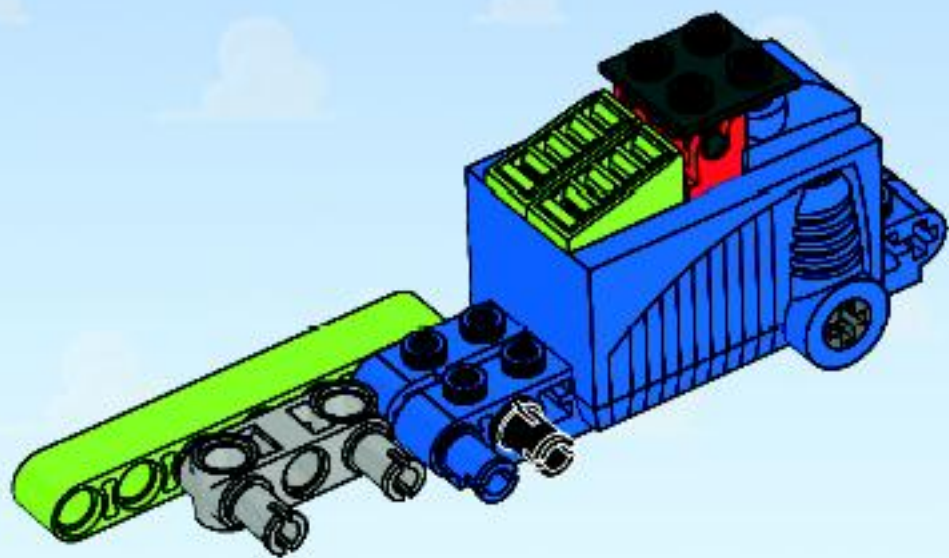

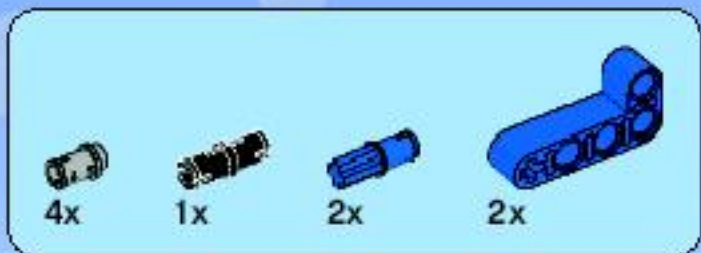

7

1

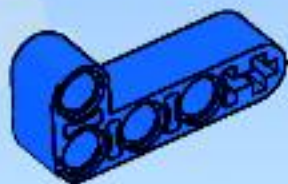

2

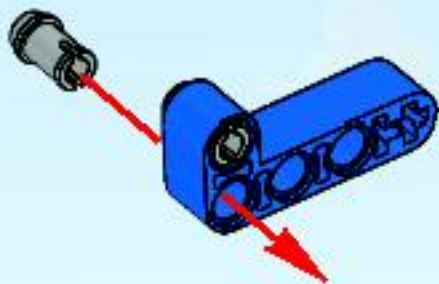

3



4

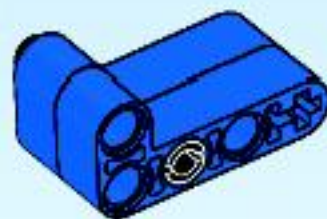

5

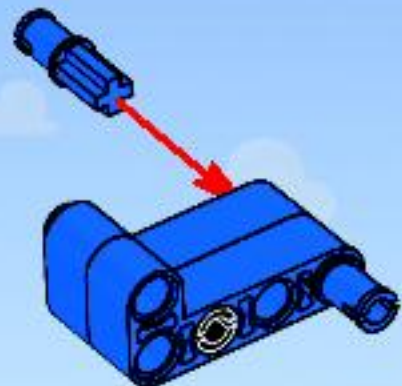

6

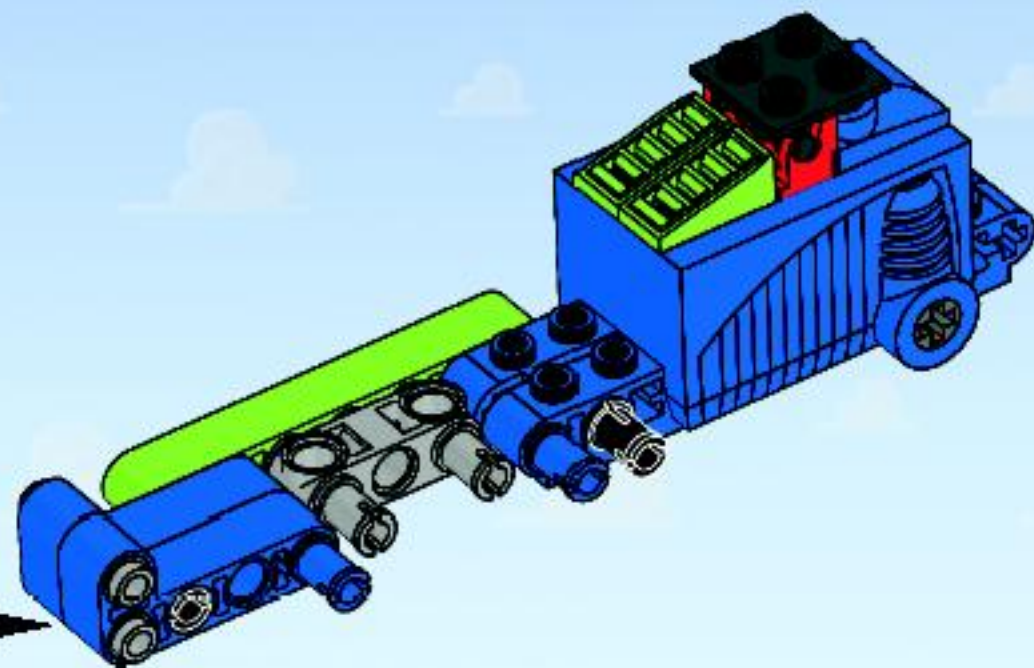
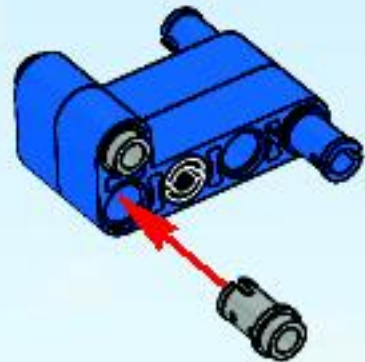

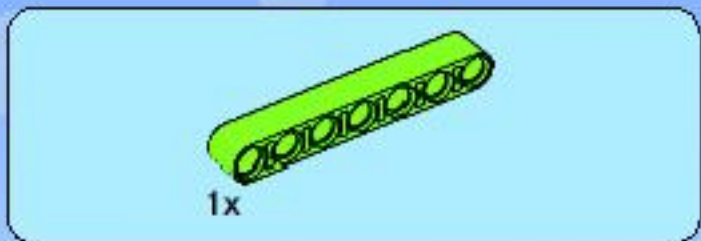

8

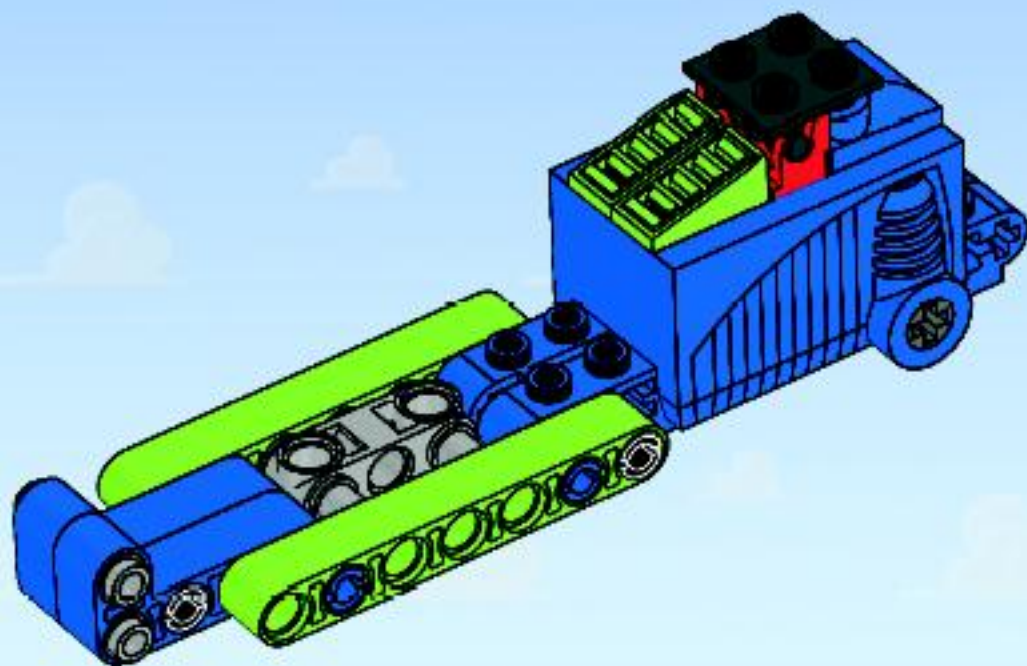

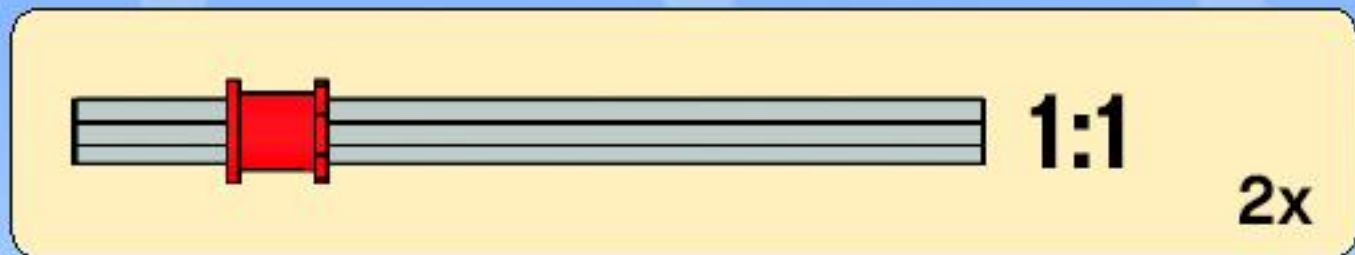
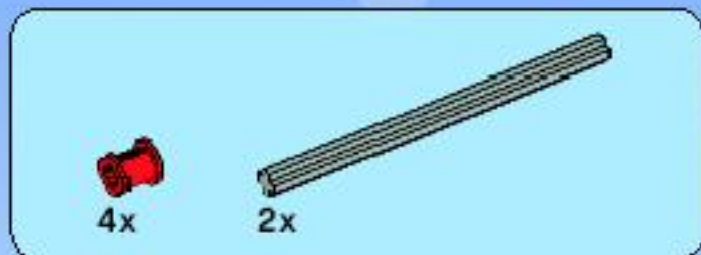

9

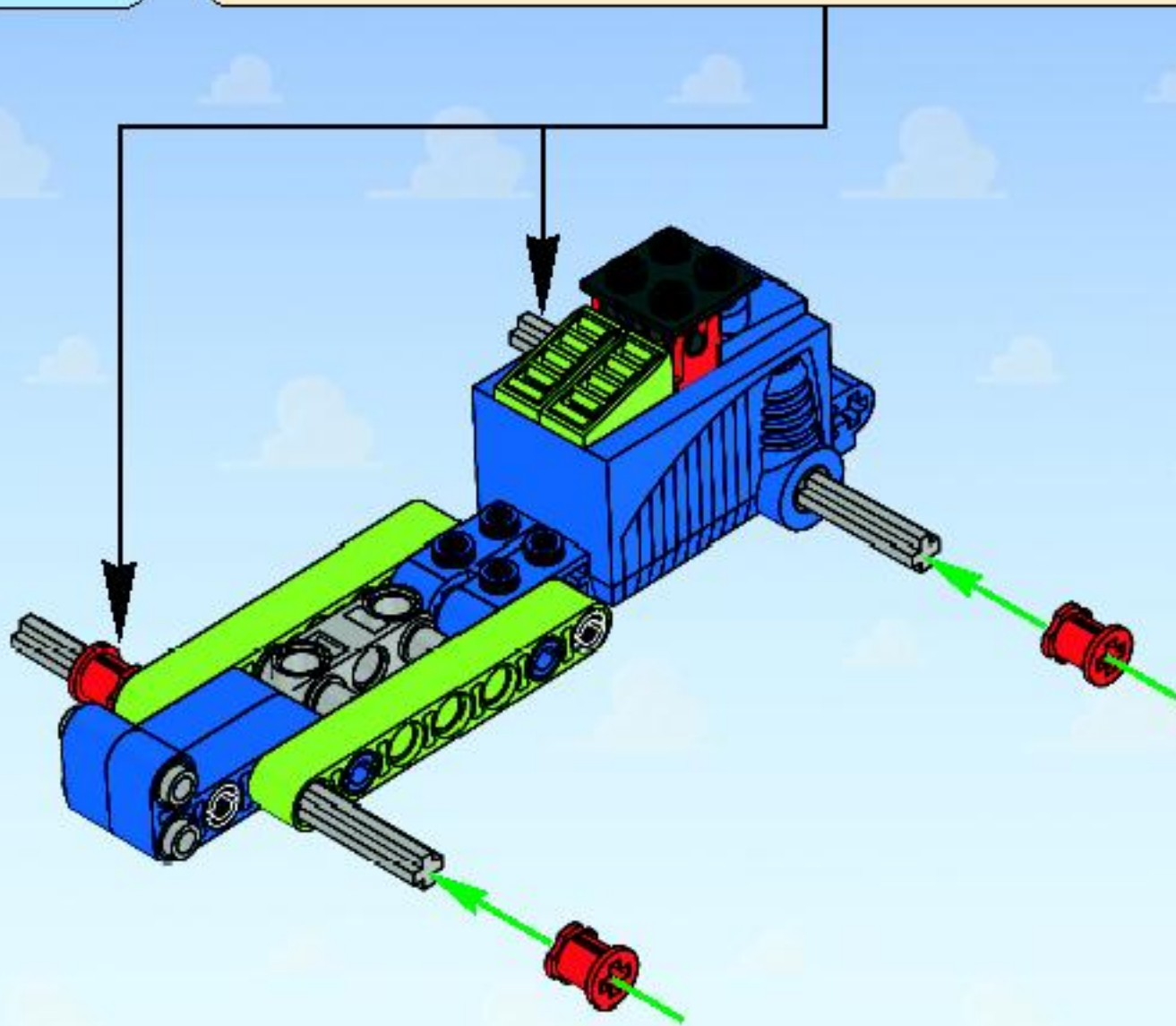

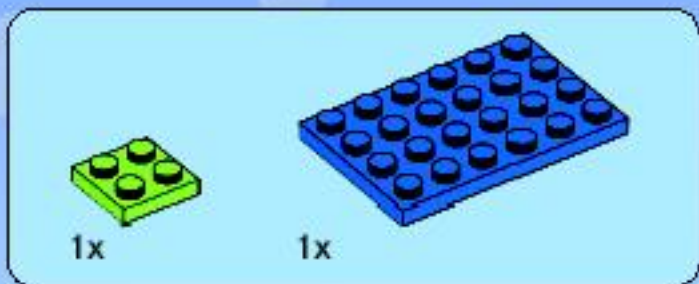

10

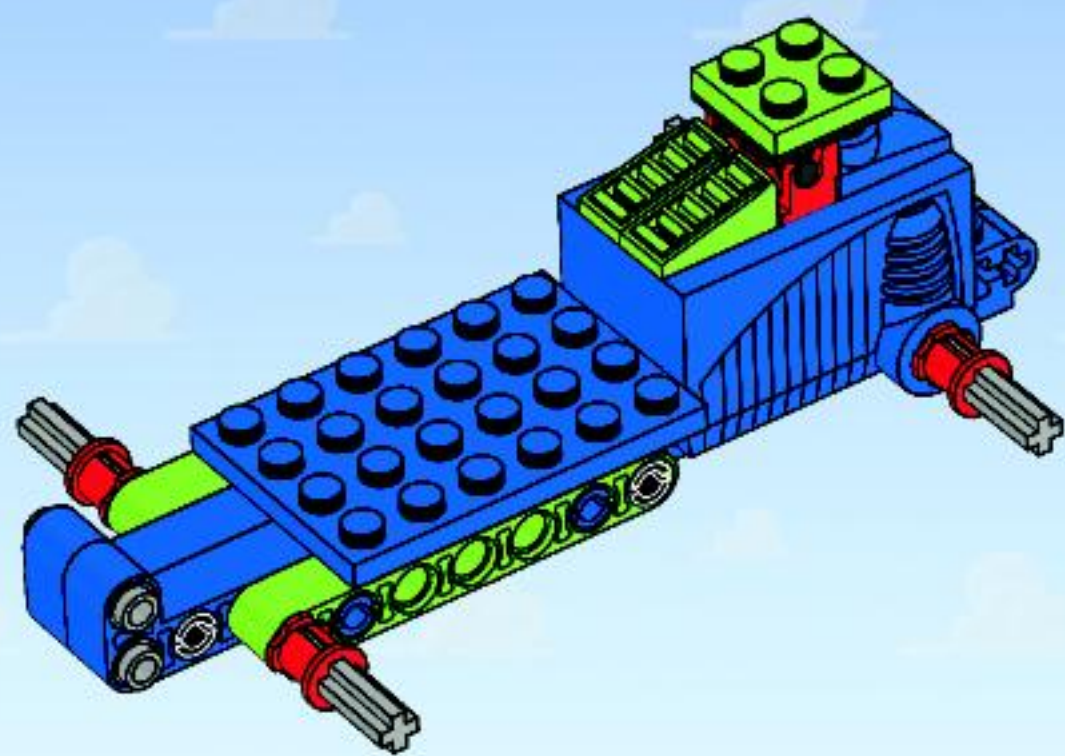



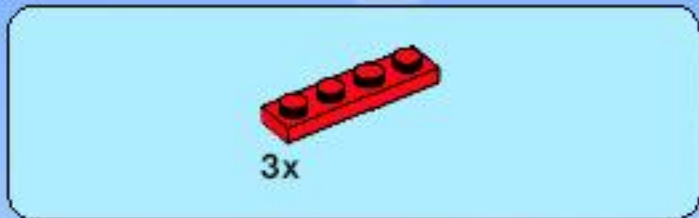

11

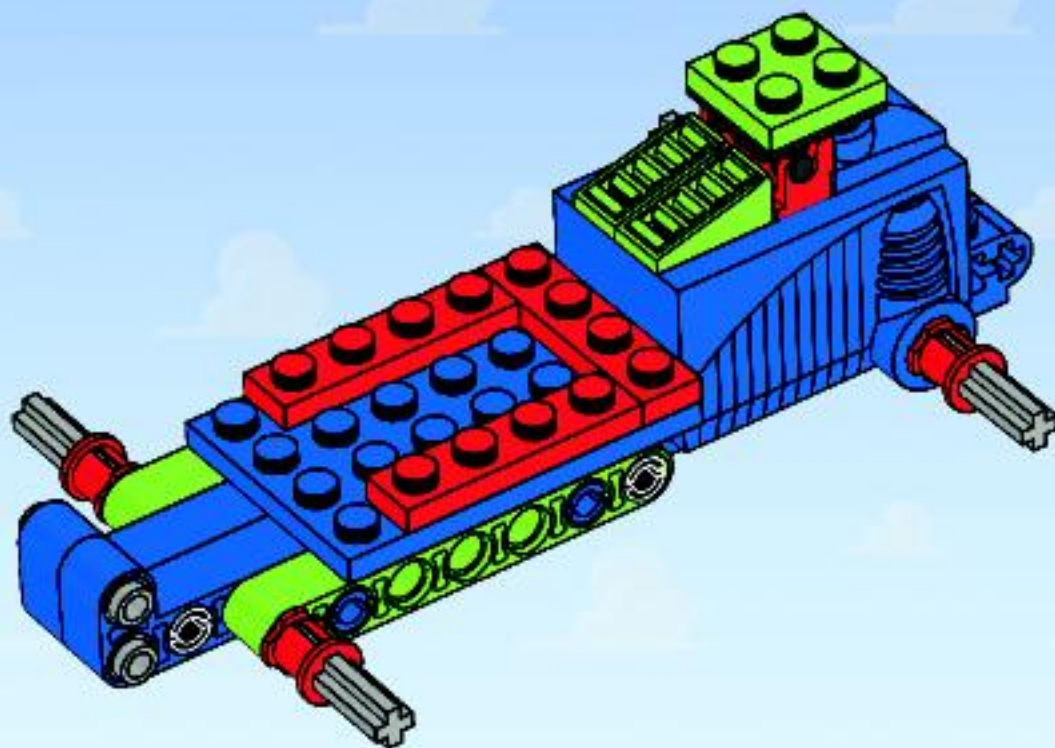



1x



2x

# 12

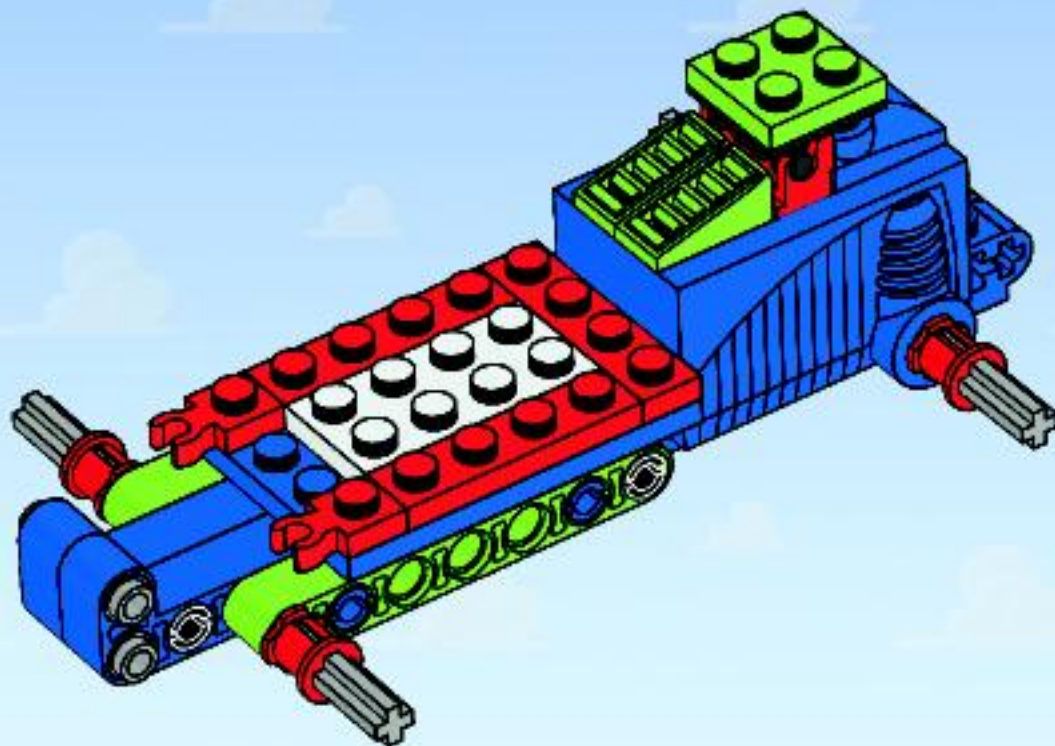



13

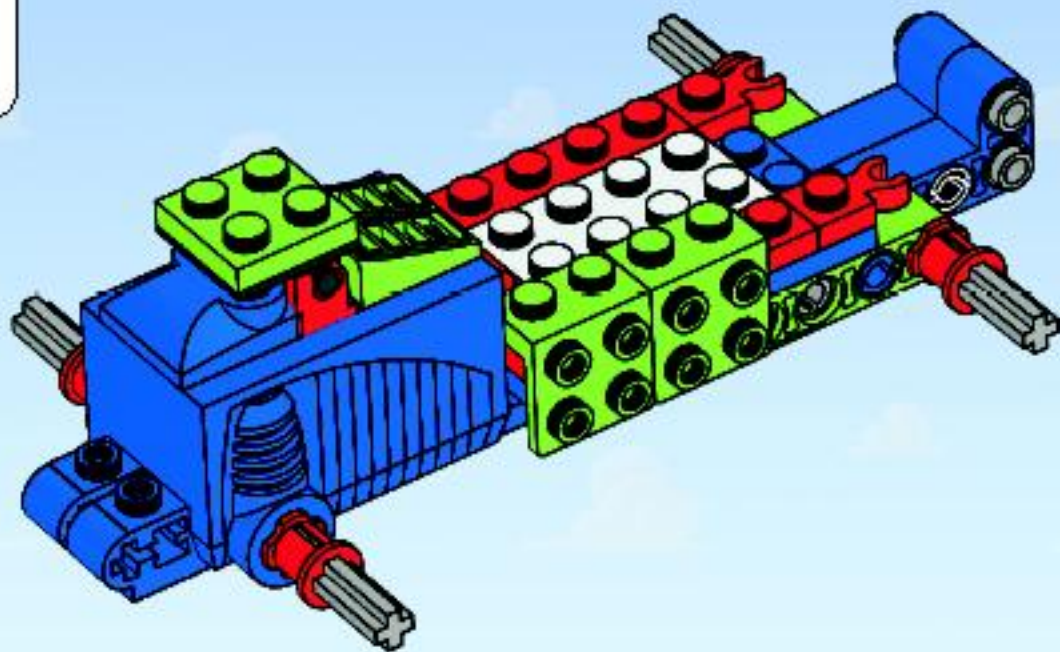

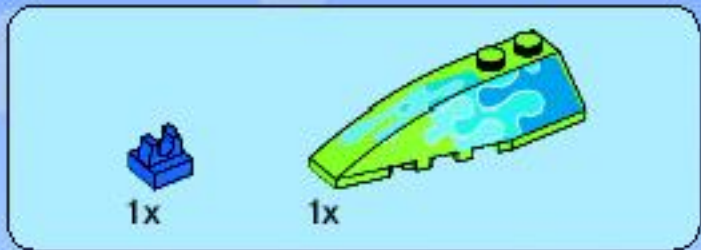

14

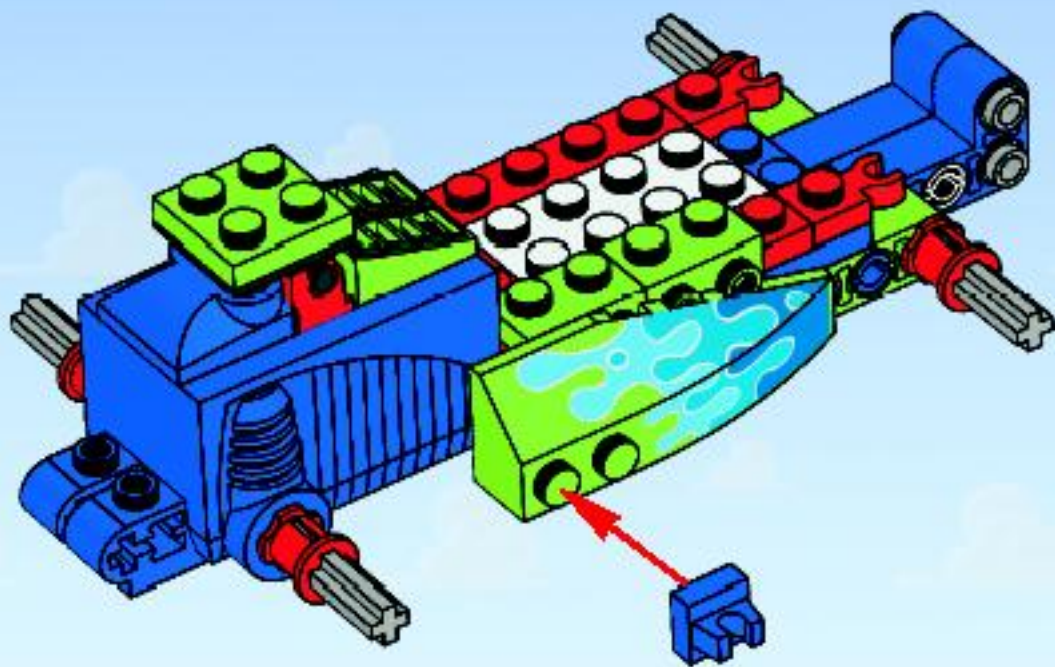

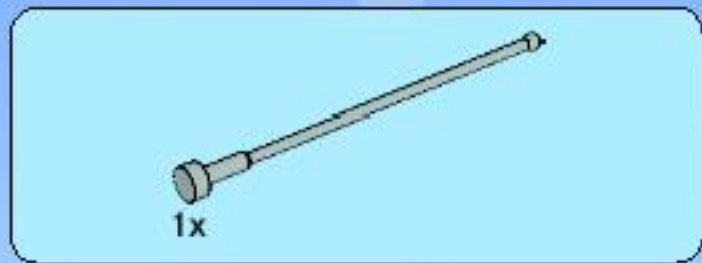

15

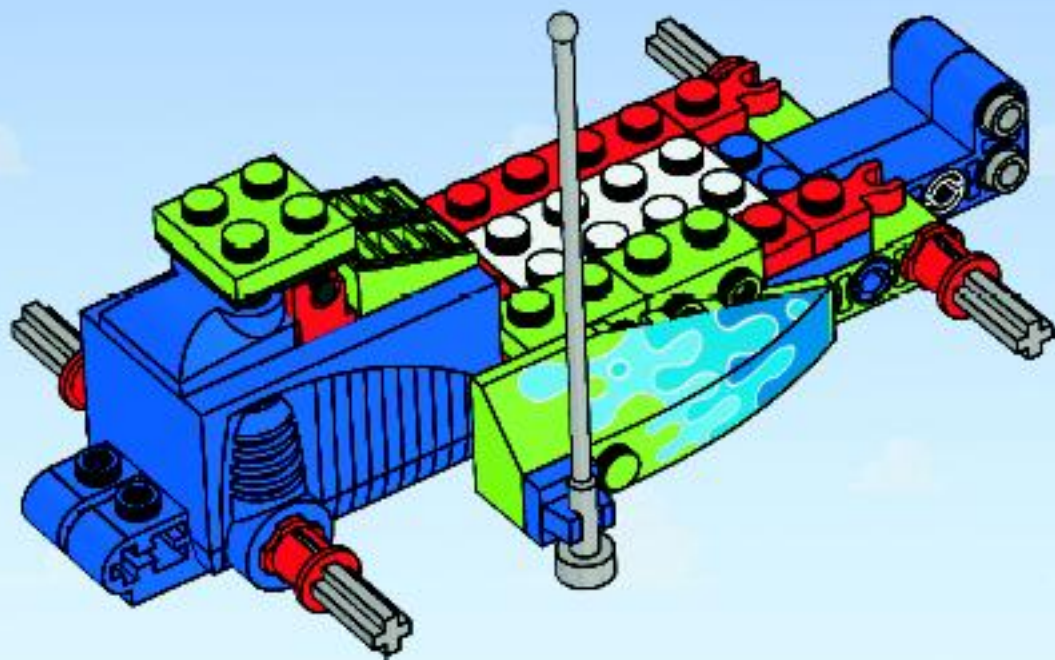







1x

18

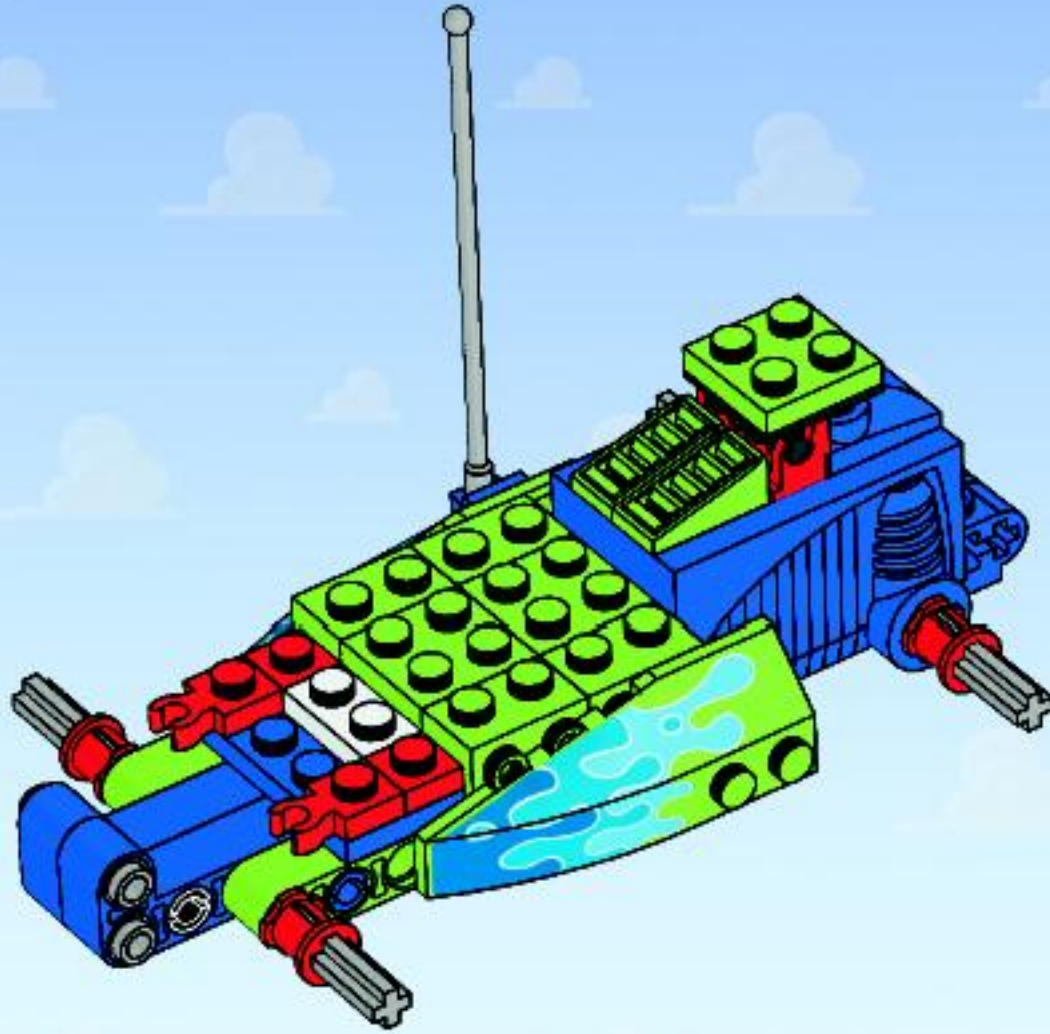



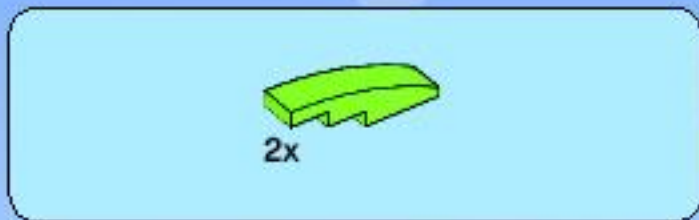

19

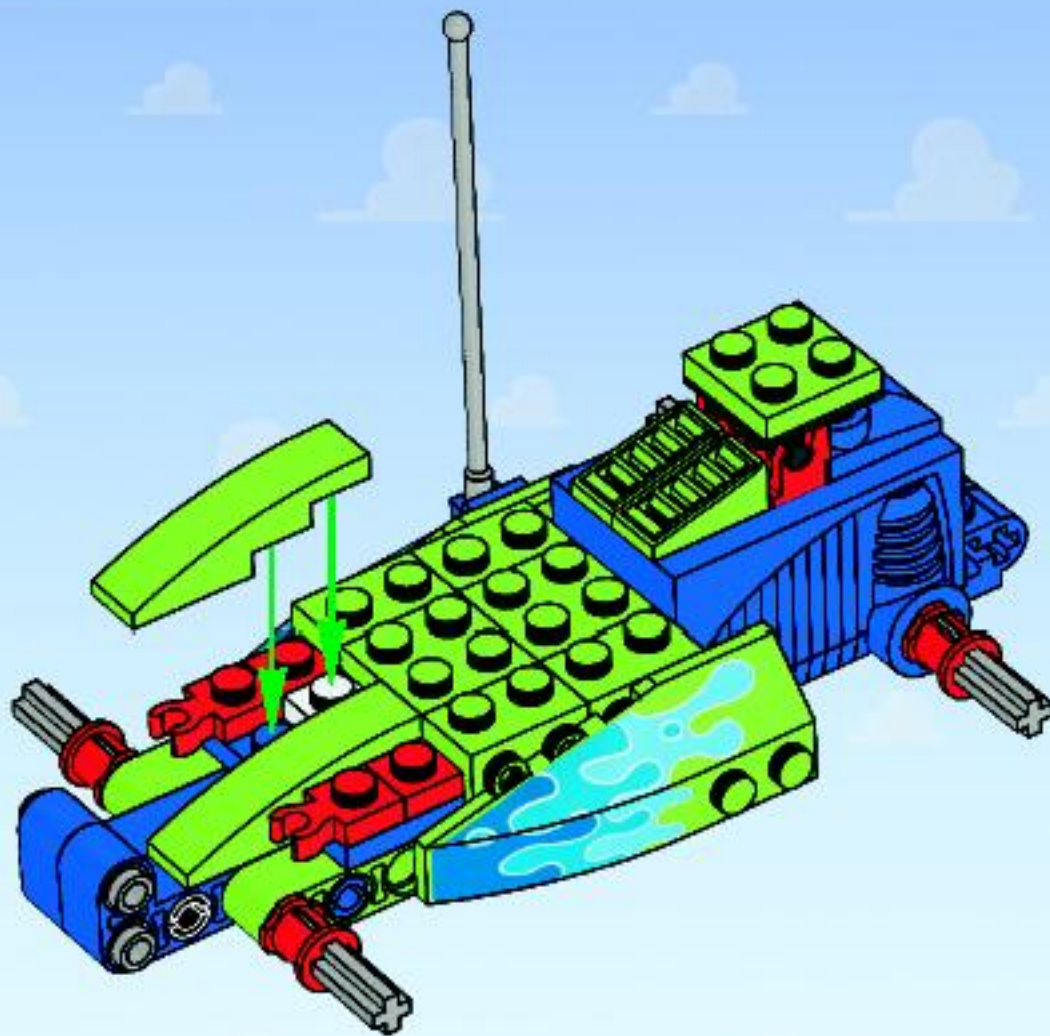



2x

20

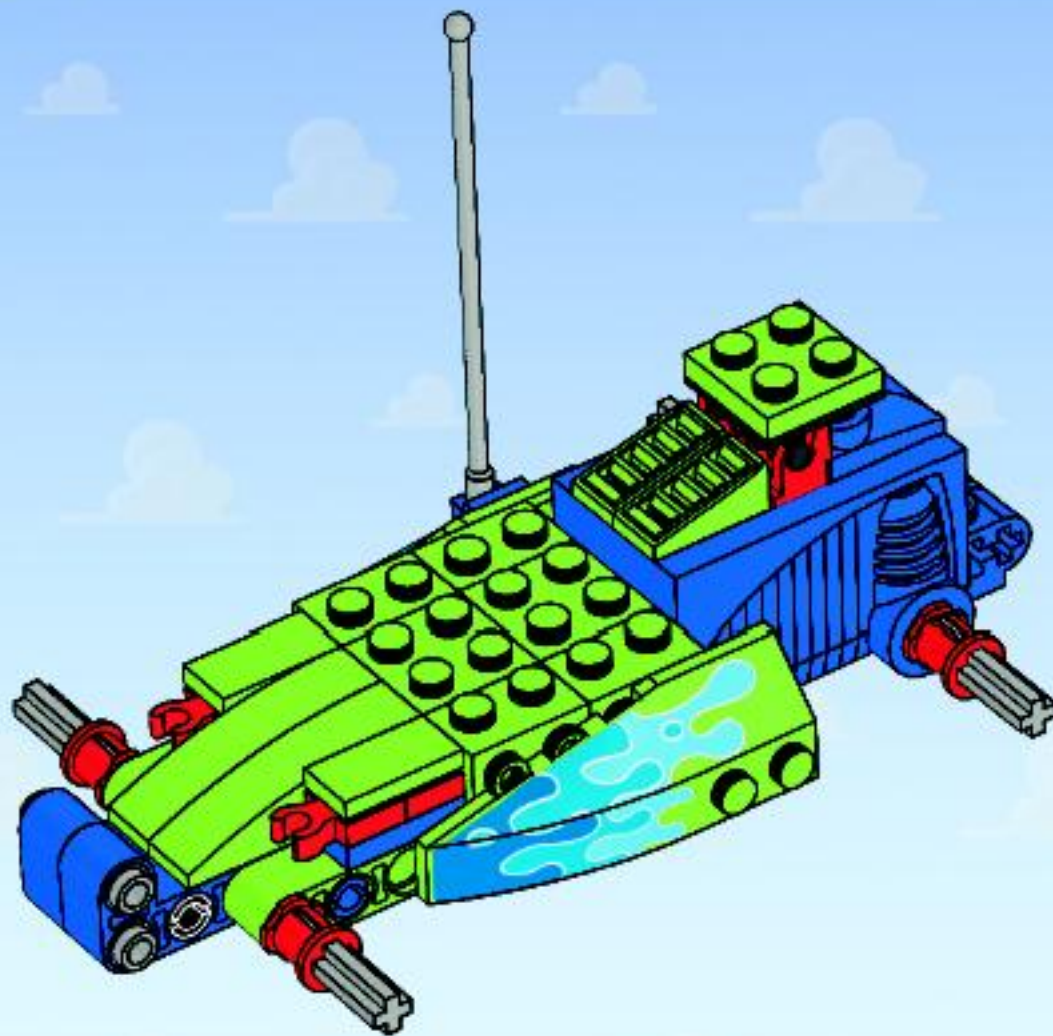

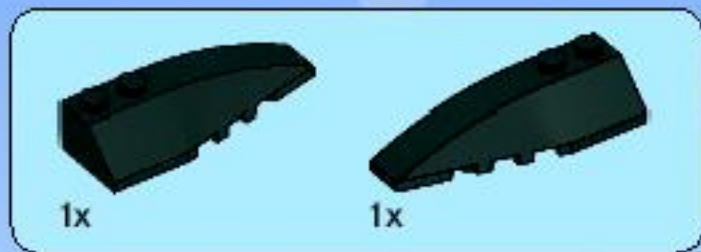

21

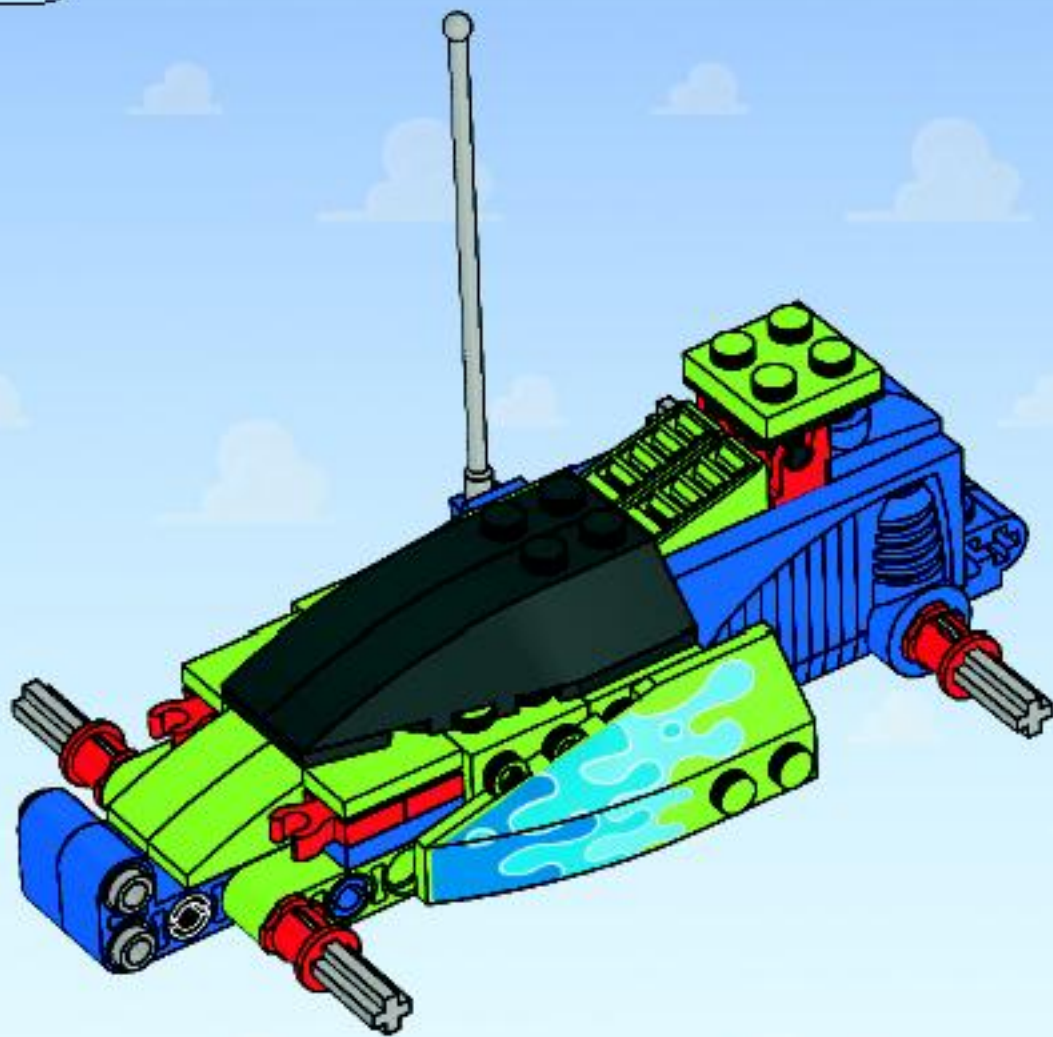



2x

22

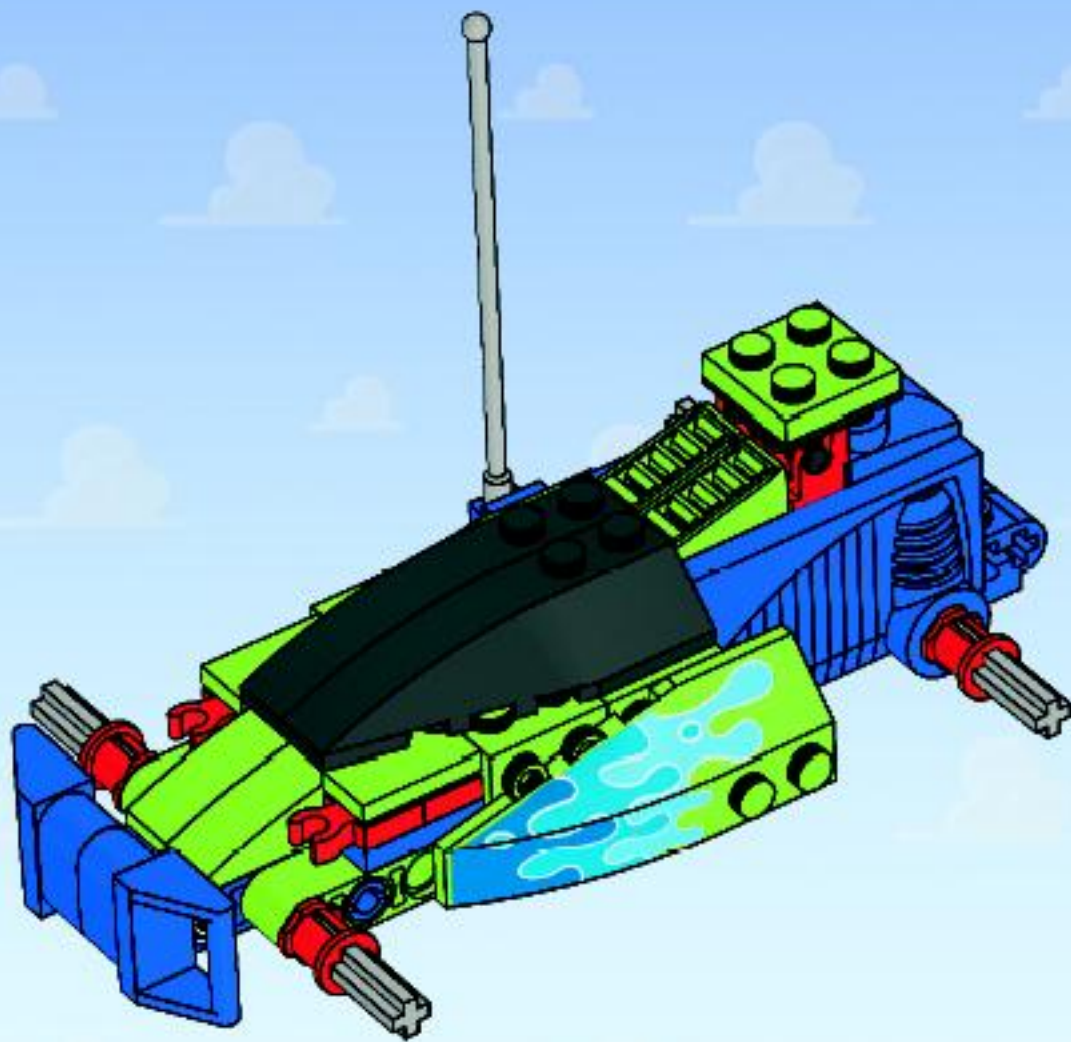



23

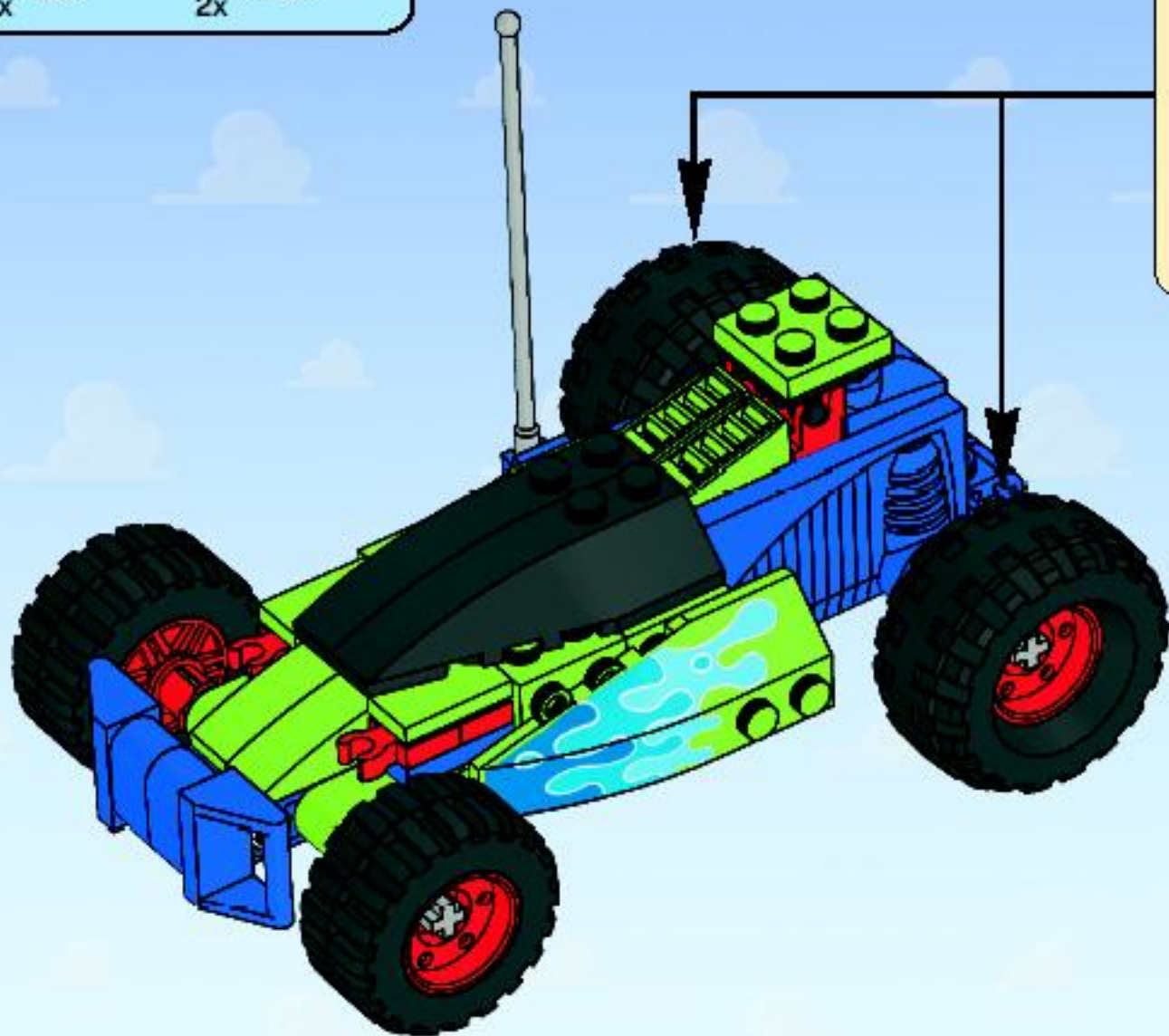



2x



2x



2x



2x

# 24

1



2



3

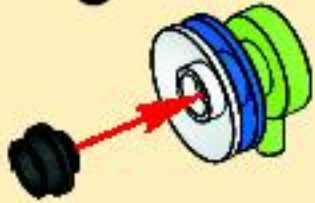

2x

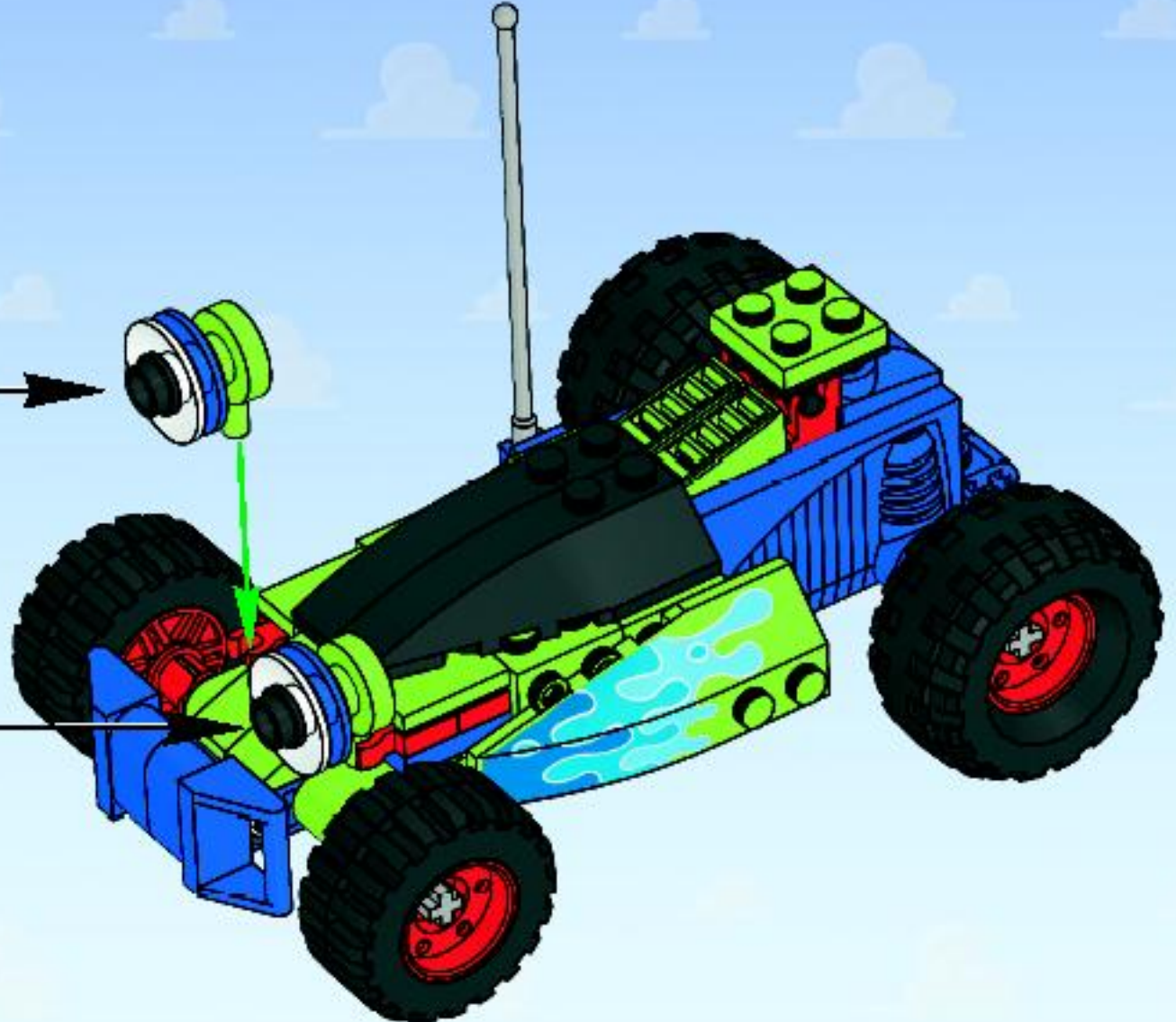

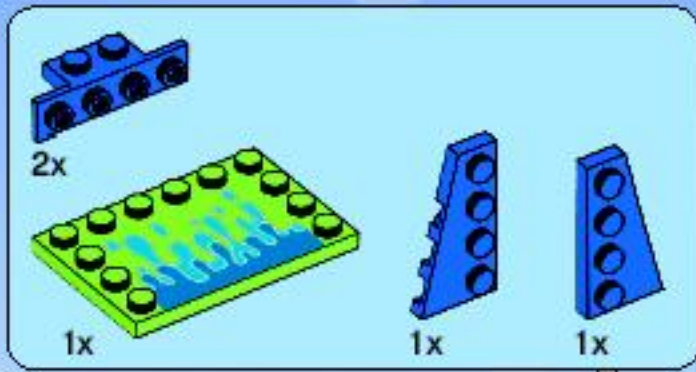

25

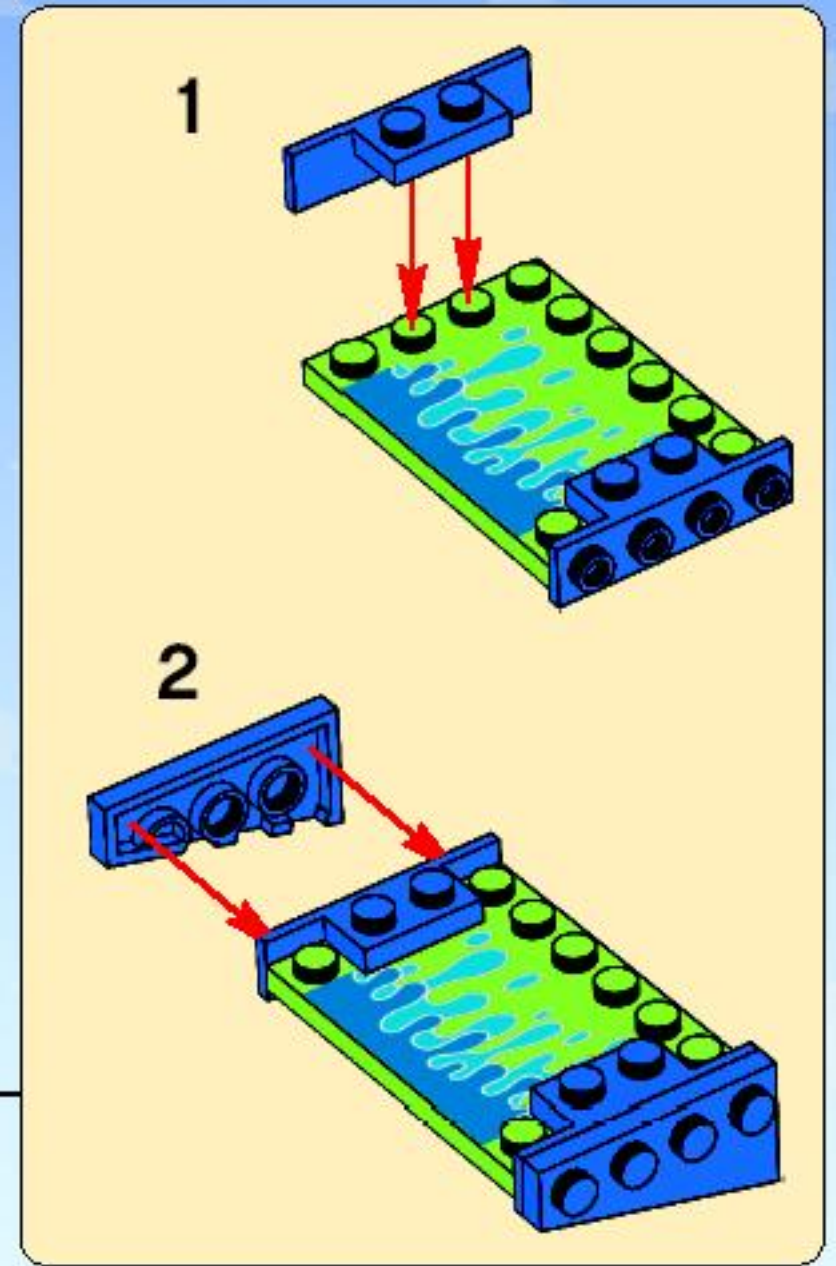

26

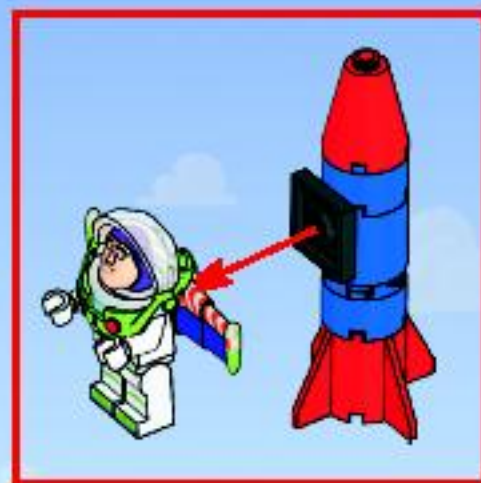





**7591**

**7592**



**7595**



**7593**



**7594**



1x  
302001



2x  
474001



1x  
4578907



1x  
4578800



1x  
4569506



1x  
4565857



1x  
4565852



1x  
4562523



3x  
371021



2x  
4588003



4x  
4570807



1x  
4570282



1x  
393721



4x  
4227155



1x  
4528786



1x  
4566144



1x  
4569543



1x  
4578592



4x  
4206482



2x  
4570283



1x  
4496366



2x  
4168114



2x  
243223



1x  
303223



1x  
4570553



2x  
4282744



1x  
4160867



1x  
4161330



2x  
614323



1x  
4500613



1x  
4225033



2x  
4535768



1x  
4251564



1x  
4211815



4x  
4211483



3x  
4121715



1x  
4160108



1x  
4160130



1x  
4258354



2x  
614126



2x  
4140670



2x  
4506553



1x  
4124096



2x  
4540385



2x  
4537927



1x  
4566135



1x  
4566139



2x  
4500125



3x  
4537937



2x  
4569073



2x  
4569507



2x  
4495928

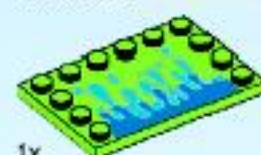

1x  
4578645



4x  
4569452



Customer Service

Kundenservice

Service Consommateurs

Servicio Al Consumidor

[www.lego.com/service](http://www.lego.com/service) or dial



00800 5346 5555 :



1-800-422-5346 :



**FREE! GRATIS! GRATUIT!**



**club**  
MAGAZINE™

**www.LEGOclub.com**



**00800 5346 5555\***        



**1-866-534-6258 • 1-877-518-5346**

US & Canada only

Canada seulement

\* Free phone. Mobile charges may apply. \*\* Numéro sans frais. Des frais peuvent s'appliquer avec les téléphones cellulaires. \*\*\* Gebührenfrei, Kosten für Anrufe aus Mobilfunknetzen können anfallen. \*\*\*\* Gratis telefonnummer van vaste lijn. \* Debet ett gratis nummer, när du ringer från Postbeta. \*\* Det är gratis, när du ringer från en Post beta. \*\*\*



VISIT THE WORLD'S  
BIGGEST LEGO® SHOP!

**www.LEGOshop.com**



# WIN!

Go to [www.nielsen.com/LEGO](http://www.nielsen.com/LEGO) to fill out a survey for a chance to win a cool LEGO® Product.

No purchase necessary.

Open to all residents where not prohibited.



## [www.nielsen.com/LEGO](http://www.nielsen.com/LEGO)

### GEWINNE!

Nimm an der Umfrage auf [www.nielsen.com/LEGO](http://www.nielsen.com/LEGO) teil und hab die Chance ein cooles LEGO® Produkt zu gewinnen!

Die Teilnahme am Gewinnspiel führt zu keinerlei Kaufverpflichtungen. Teilnahme in allen nicht ausgeschlossenen Ländern möglich.

### WIN!

Ga naar [www.nielsen.com/LEGO](http://www.nielsen.com/LEGO), vul een enquêteformulier in en maak kans op een cool LEGO® product.

Geen aankoopverplichting. Iedereen mag deelnemen, uitgezonderd ingezetenden van landen waar een enquêteverbod geldt.

### GAGNE!

Visite [www.nielsen.com/LEGO](http://www.nielsen.com/LEGO) pour répondre à un questionnaire et avoir une chance de gagner un produit LEGO® très cool!

Aucune obligation d'achat. Ouvert à tous les résidents des pays autorisés.

### 当てよう!

[www.nielsen.com/LEGO](http://www.nielsen.com/LEGO) にアクセスして、アンケートにご記入ください。当選者にはレゴ製品を差し上げます。

お買い上げの必要はありません。禁止されていない限り、すべての皆様にご利用いただけます。