

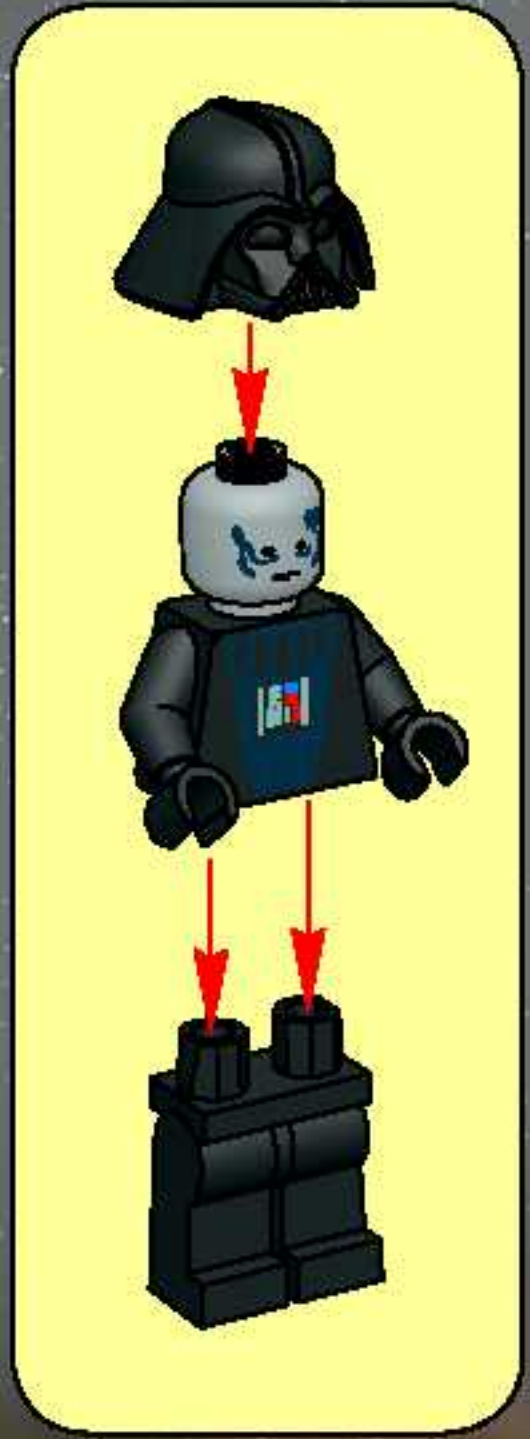

STAR WARS

7251







1



2

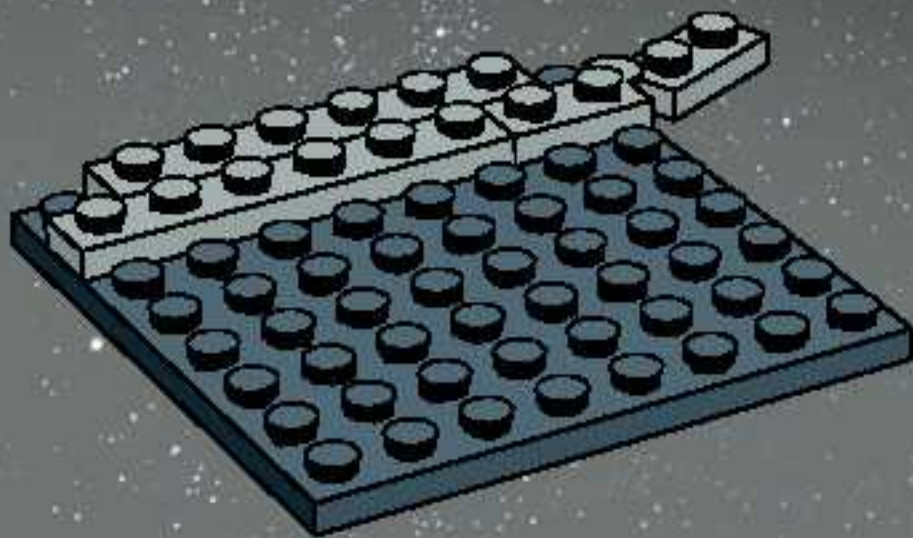

3



4



5



6

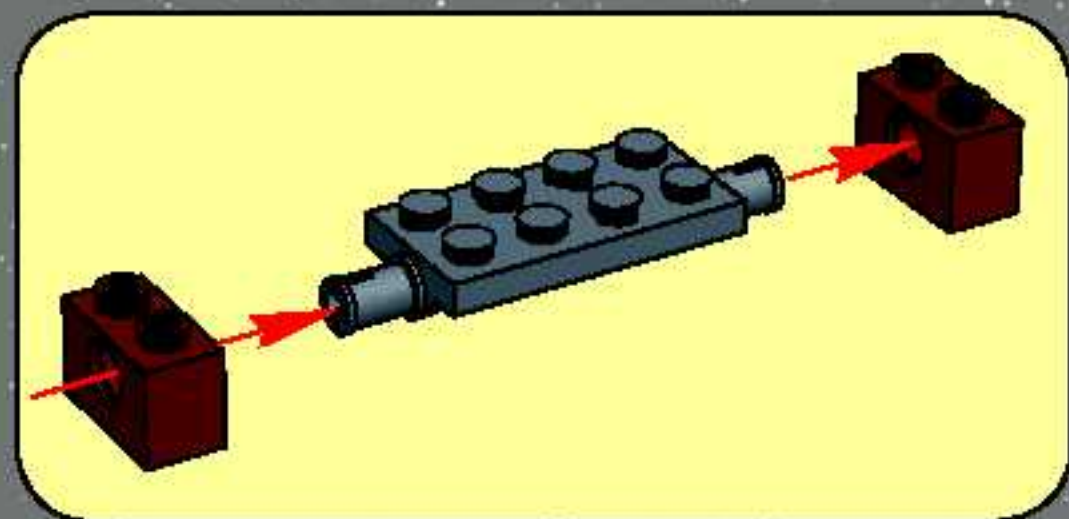
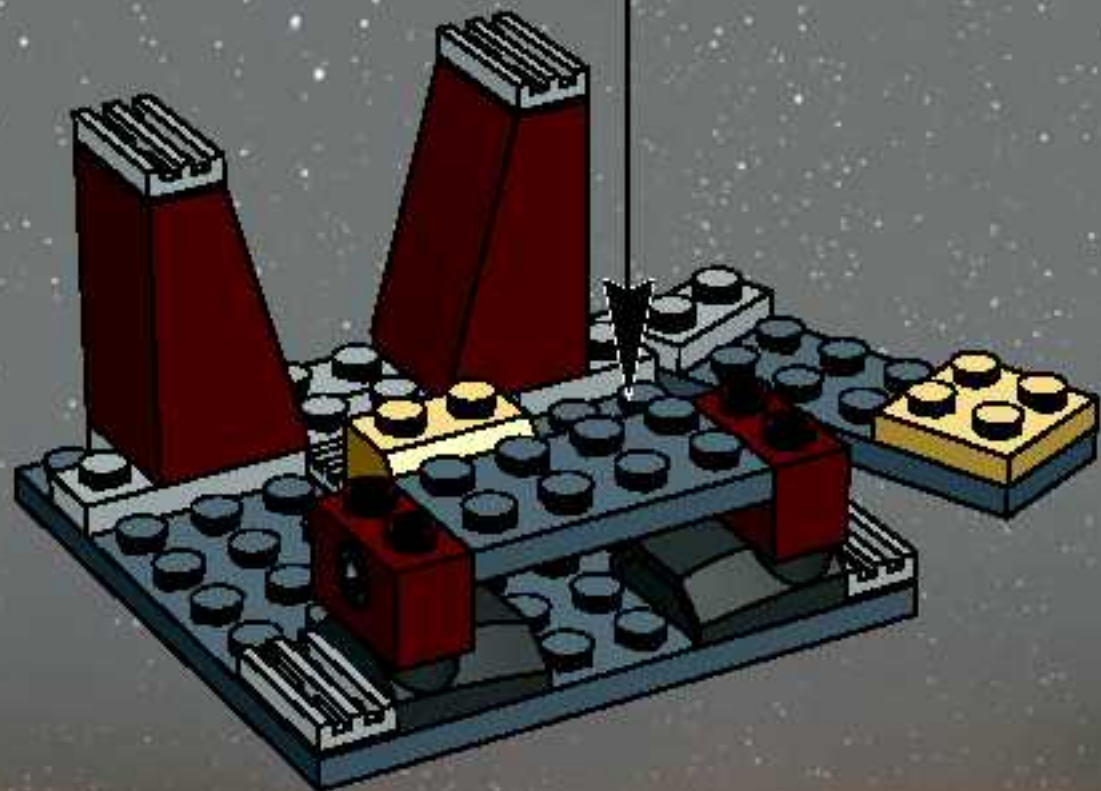

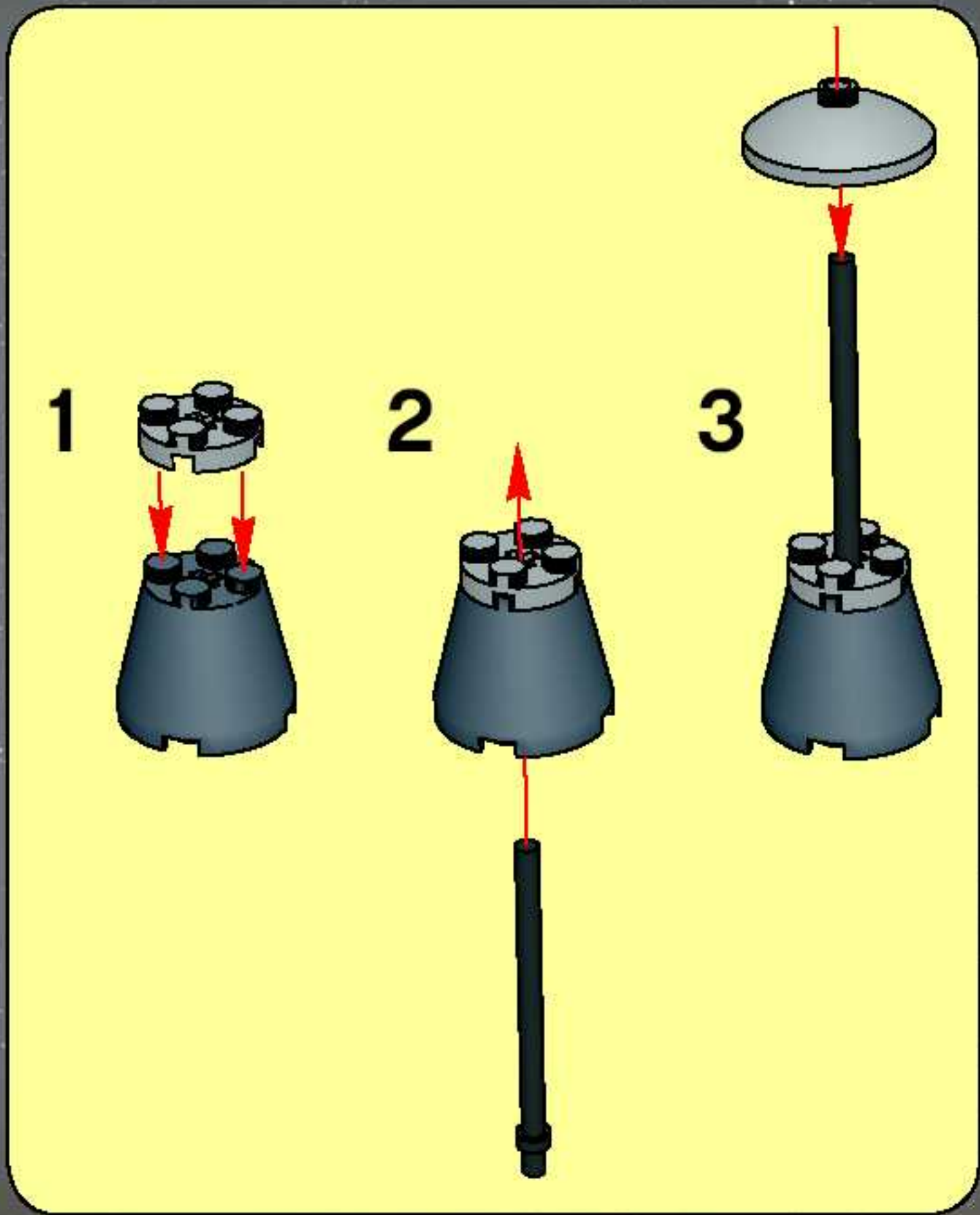

7



1



3



5



2



4



6



7



8



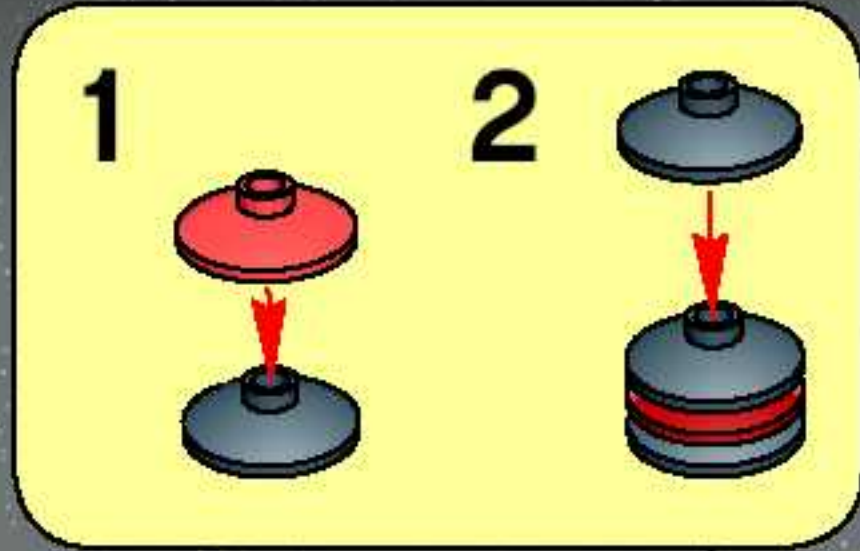
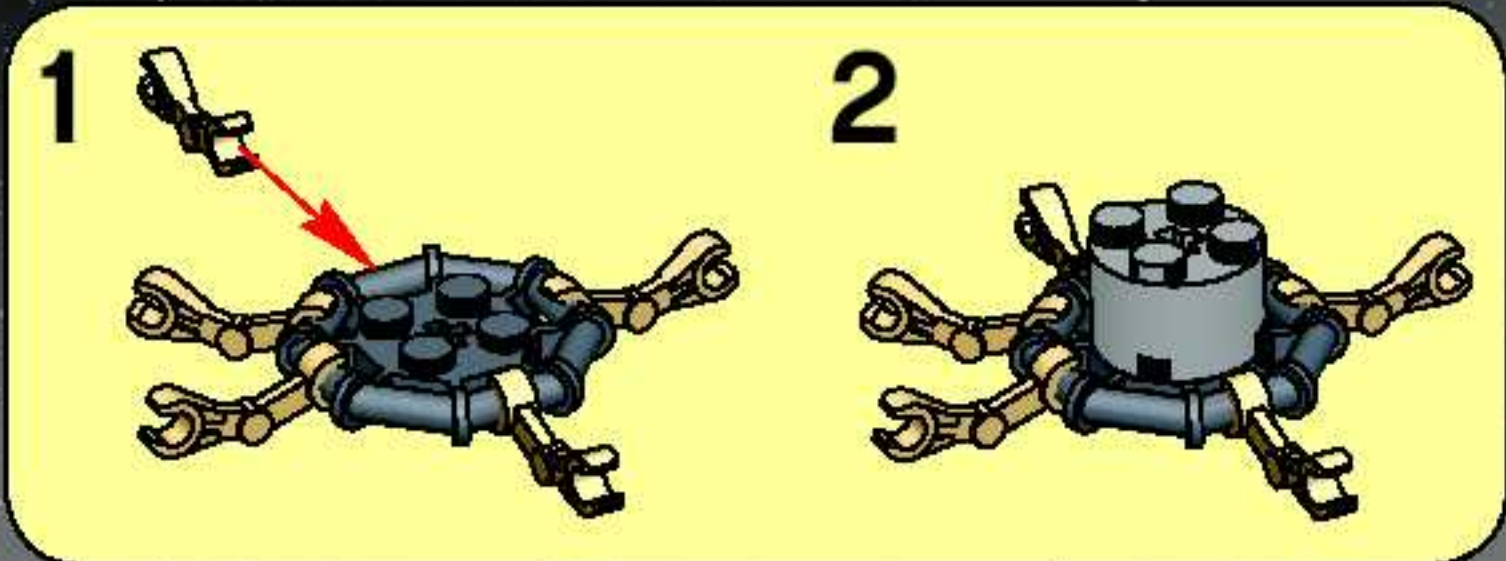

11



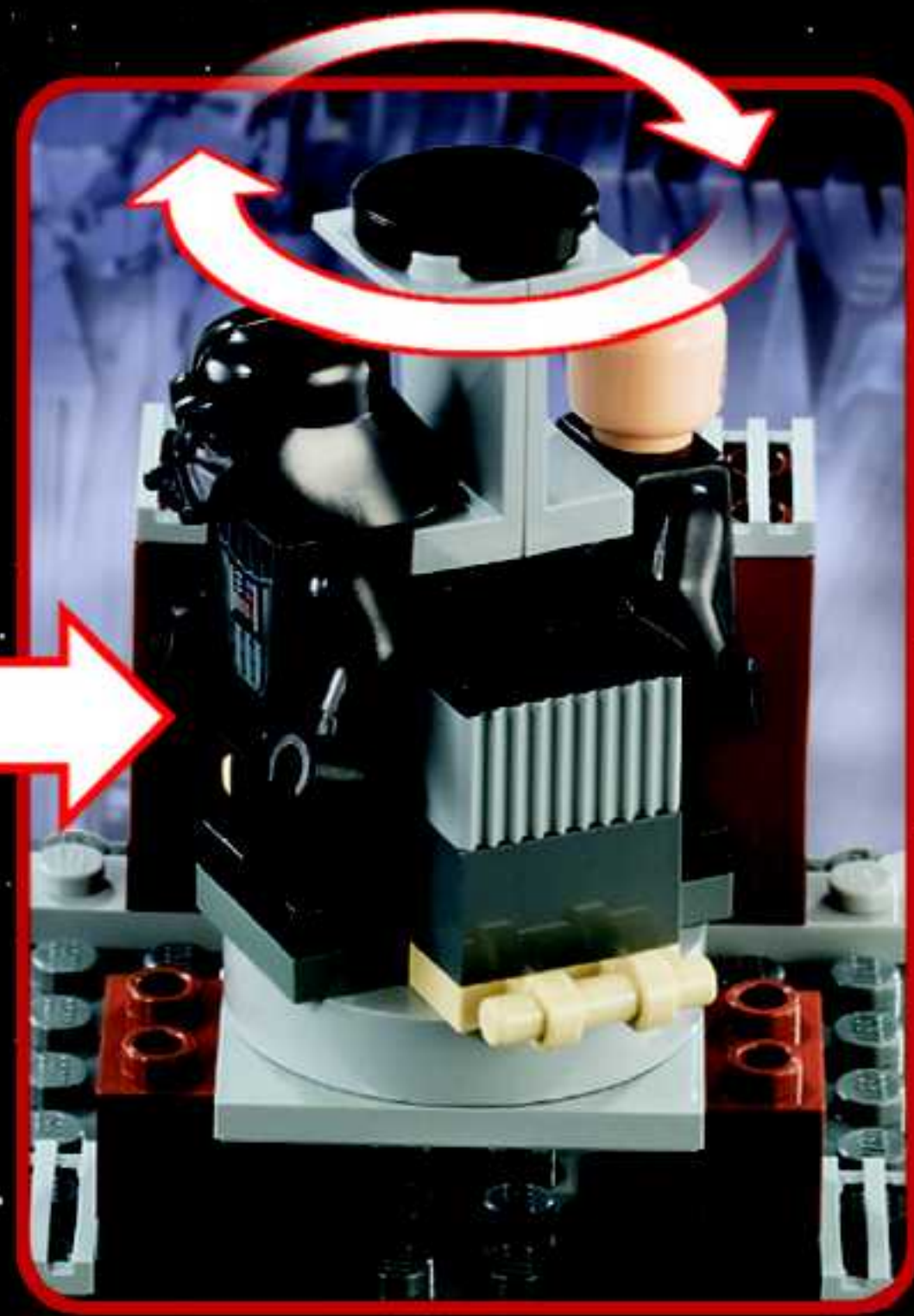





7251
Darth Vader™
Transformation



7256
Jedi Starfighter™
and Vulture Droid™



7259
Arc-170 Starfighter™



7261 Clone Turbo Tank™



7250
Clone
Scout
Walker™



7257 Ultimate Lightsaber™ Duel



7252 Droid Tri-fighter™



7255 General Grievous™ Chase



7260 Wookiee Catamaran™



7258 Wookiee™ Attack



Discover the LEGO UNIVERSE!



www.lego.com/starwars

LEGO SHOP at HOME

LEGO club

The
World's
Biggest
LEGO
Shop!

English Deutsch Français



SHOP at HOME

Welcome to
The World's Biggest LEGO Shop!

FREE LEGO Truck!

Shop Our
NEW Fall
Catalog
Online!



club

LEGO Club Sets

LEGO Club Figures

LEGO Club Accessories

LEGO magazine

LEGO Magazine

LEGO Magazine

Win! Gagne! Gewinne! 当たります



WIN LEGO® PRODUCTS

We would like to know what you think about our new LEGO® product. If you could help us by answering a few questions you are in with a chance of winning an exciting LEGO prize. It will only take you about 3 minutes! Log on to the web address below for further instructions.

We would really like to hear what you think about your new LEGO product. If you'd like to help us, go to the web address below for further instructions.



Estimado usuario LEGO®

Al contactar algunas preguntas en Inglés, francés, alemán o japonés, en el sitio www.acnielsen.aim.dk/lego, podrá participar en el sorteo de algunos valiosos premios LEGO®.



皆さんでレゴ®製品が当たります

私たちは、皆さんが面白いと思われるレゴ®製品についてどんな感想をお持ちか、知りたく思っています。質問に答えて、楽しいレゴ®製品の抽選に当たれば、ほんのわずかな時間でお楽しみいただけます。アンケートの回答には、ほんのわずかな時間がかかります。詳しくは、以下のウェブアドレスまでアクセスしてください。



GAGNE DES PRODUITS LEGO®

Nous aimerions savoir ce que tu penses de ton nouveau produit LEGO®. Si tu veux bien nous aider en répondant à quelques questions, tu recevras peut-être bientôt un fantastique prix LEGO. Et cela ne te prendra que 3 minutes environ ! Tu obtiendras davantage d'informations en visitant le site Internet indiqué ci-dessous.

Nous aimerions savoir ce que tu penses de ton nouveau produit LEGO. Si tu souhaites nous aider, rends-toi à l'adresse Internet ci-dessous où tu trouveras des instructions supplémentaires.



Caro Consumidor de LEGO®

Ao responder a algumas perguntas em Inglês, Francês, Alemão ou Japonês no endereço www.acnielsen.aim.dk/lego irá participar num concurso para ganhar valiosos prémios de LEGO®.



GEWINNE LEGO® PRODUKTE

Wir sind sehr an deiner Meinung über dein neues LEGO® Produkt interessiert. Wenn du uns den Gefallen tust und ein paar Fragen beantwortest, kannst du einen tollen LEGO Preis gewinnen. Das Ganze dauert nur etwa 3 Minuten! Gehe einfach zu der unten angegebenen Webadresse - dort findest du weitere Informationen.

Wir möchten gerne wissen, was Sie von Ihrem neuen LEGO Produkt halten. Wenn Sie uns helfen möchten, besuchen Sie bitte die u.a. Website, auf der Sie alles Weitere erfahren.



Köszönjük LEGO® Vásárló!

Ha elküldted az www.acnielsen.aim.dk/lego honlapra és ott angol, francia, német vagy japán nyelven megválaszolod néhány kérdést, akkor részt vehetsz egy versenyben, amelyben értékes LEGO® díjakat nyerhetsz.

www.acnielsen.aim.dk/LEGO



LEGO STAR WARS™

THE VIDEO GAME



4272226

©2005 The LEGO Group.



LEGO, the LEGO logo and the Minifigure are trademarks of The LEGO Group. © 2004 The LEGO Group. © 2004 Lucasfilm Entertainment Company Ltd. or Lucasfilm Ltd. & ® or TM as indicated. All rights reserved. Microsoft, Xbox and the Xbox logos are either registered trademarks or trademarks of Microsoft Corporation in the U.S. and/or in other countries and are used under license from Microsoft. All rights reserved. "PS" and "PlayStation" are registered trademarks of Sony Computer Entertainment Inc. All rights reserved. GAME BOY ADVANCE IS A TRADEMARK OF NINTENDO. The NVIDIA logo and "The way it's meant to be played" logo are registered trademarks or trademarks of NVIDIA Corporation.