

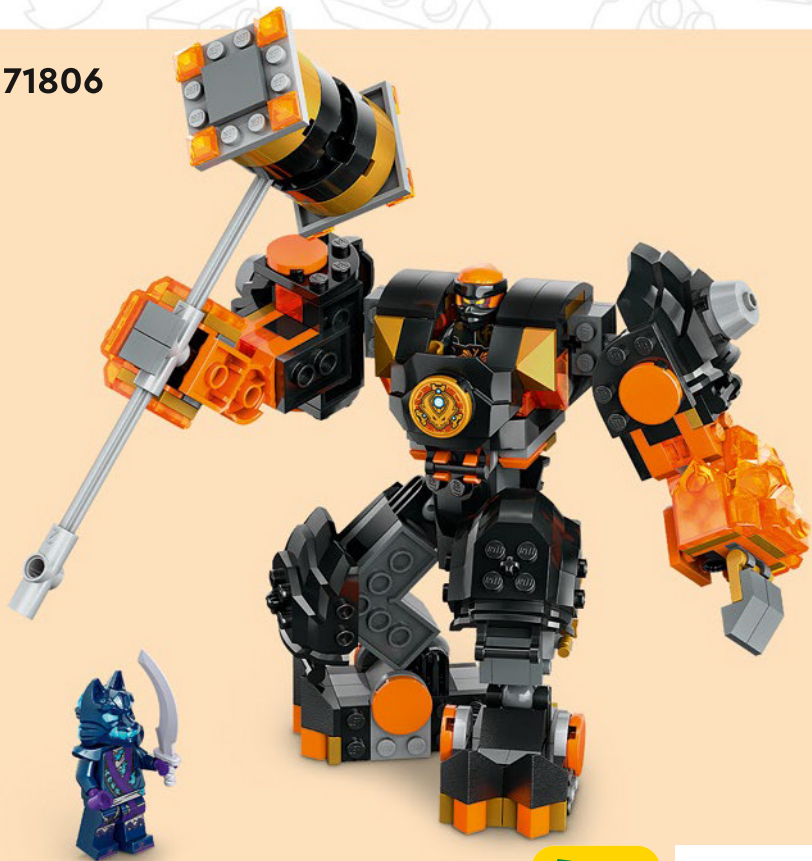

# NINJAGO

DRAGONS RISING

71806



Q LEGO® Builder



### **Get excited about our new packaging!**

We're switching from plastic to paper-based packaging. That's why you might find a mix of paper and plastic in our boxes!

### **Nos nouveaux emballages vous emballeront !**

Nous passons des emballages en plastique aux emballages à base de papier. C'est pourquoi vous pourriez trouver un mélange de papier et de plastique dans nos boîtes !

### **¡Te presentamos nuestros nuevos empaques!**

Estamos sustituyendo las bolsas de plástico por bolsas con base de papel. ¡Por eso, puedes encontrar una mezcla de papel y de plástico en nuestras cajas!

**[LEGO.com/sustainable-packaging](https://www.lego.com/sustainable-packaging)**

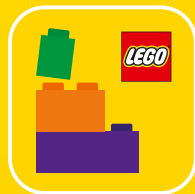

LEGO® Builder

# BUILDER



Apple and the Apple logo are trademarks of Apple Inc., registered in the U.S. and other countries and regions. App Store is a service mark of Apple Inc. Google Play and the Google Play logo are trademarks of Google LLC. Tencent and the Tencent logo are trademarks of Tencent Inc.

LEGO.com/devicecheck

**EN** Ask parents' permission before going online | **DE** Eltern um Erlaubnis bitten, bevor du online gehst | **FR** Demande l'autorisation d'un parent avant d'aller en ligne | **IT** Chiedi il permesso ai tuoi genitori prima di andare online | **ES** Pídeles permiso a tus papás antes de conectarte a Internet | **PT** Peça autorização aos pais antes de acederes online | **ZH** 上网前应先征得父母的同意 | **PL** Poproś rodziców o zgodę, zanim wejdiesz do Internetu | **CS** Než půjdeš na internet, požádej rodiče o svolení | **SK** Skôr než pôjdeš na internet, vypýtaj si povolenie od rodičov | **HU** Kérj szülői engedélyt, mielőtt online csatlakoznál! | **RO** Cere permisiunea părinților înainte de a te conecta online | **BG** Попискайте разрешение от родител, преди да влезете онлайн | **LV** Pirms došanās tiešsaistē palūdz atļauju vecākiem | **ET** Enne Interneti kasutamist küsi vanematelt luba | **LT** Prieš prisijungdami prie interneto, atsiklauskite tėvų



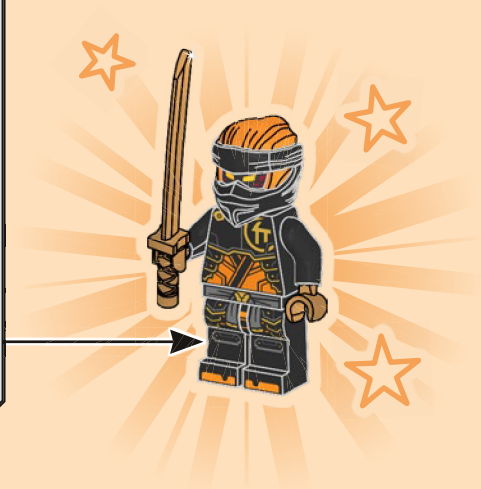
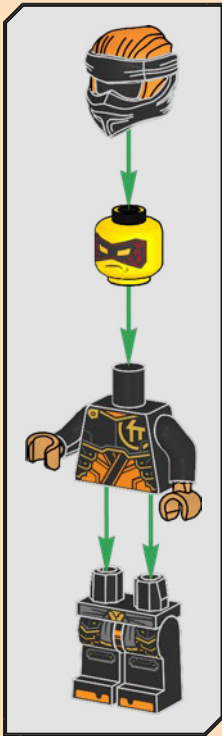

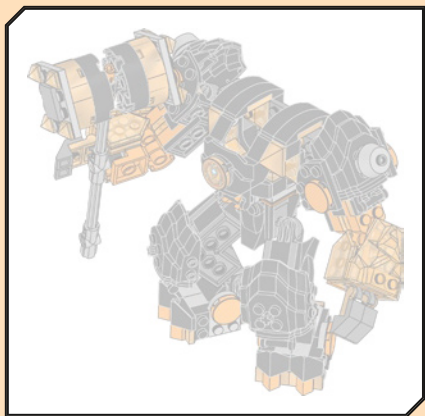

1x

1

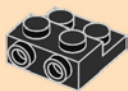

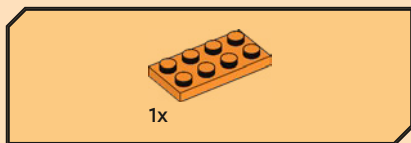

2

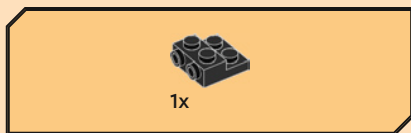
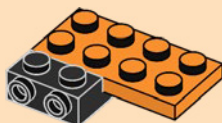

3

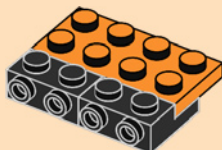

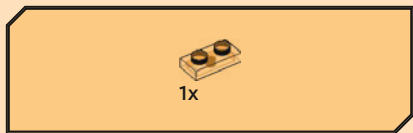

4

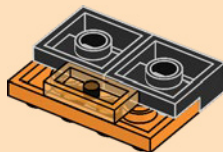

5

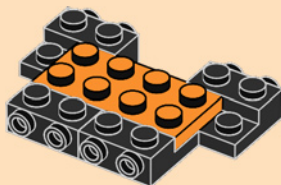



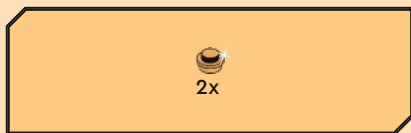

6

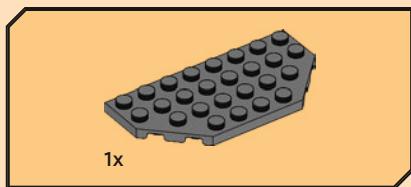
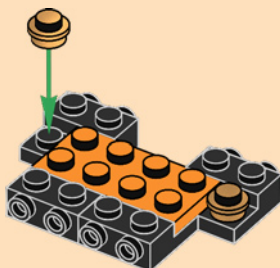

7

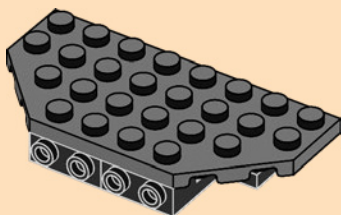



2x

8

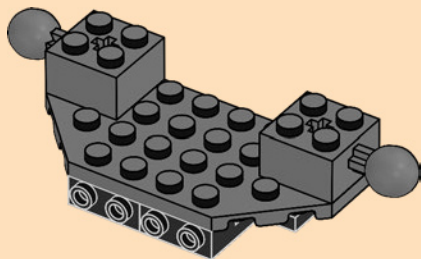

2x

9

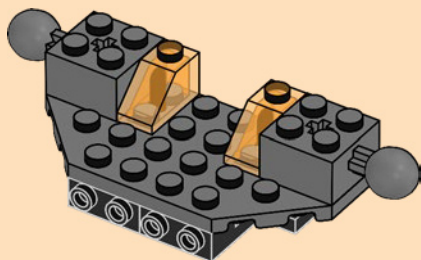

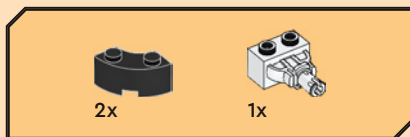

10

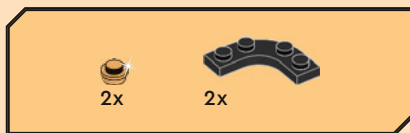
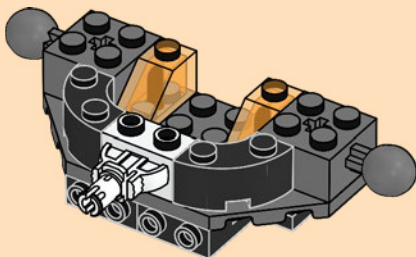

11

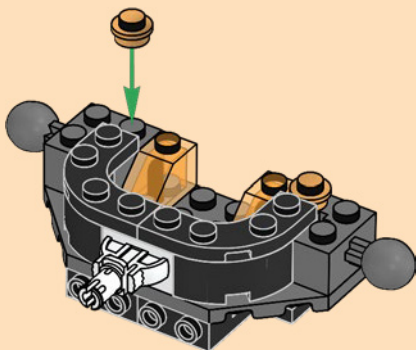



2x

# 12

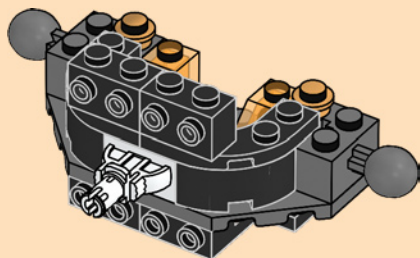

2x



1x

# 13

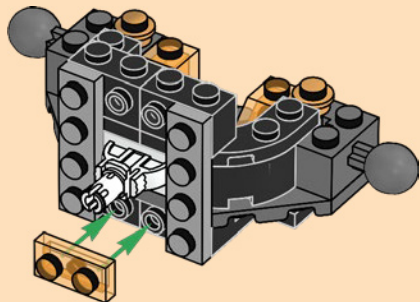



14

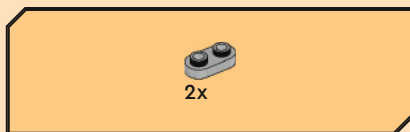
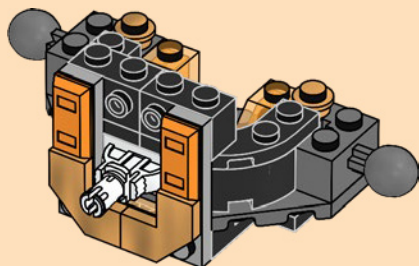

15

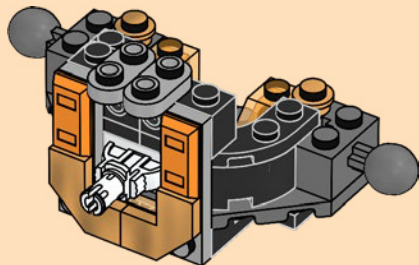



16

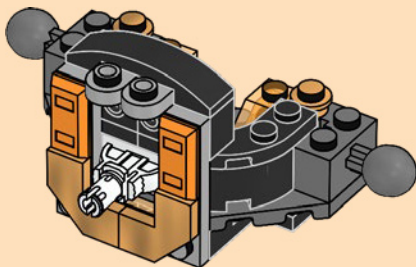

17

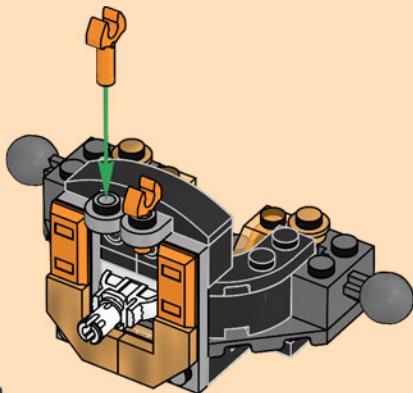



18

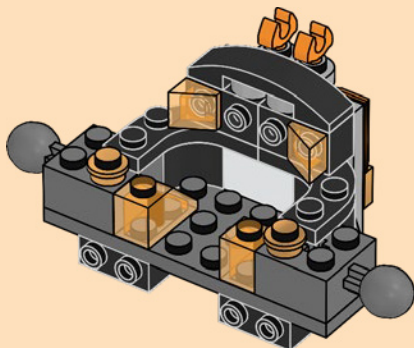

19

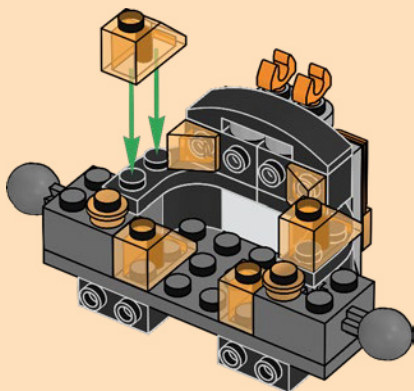



2x

# 20

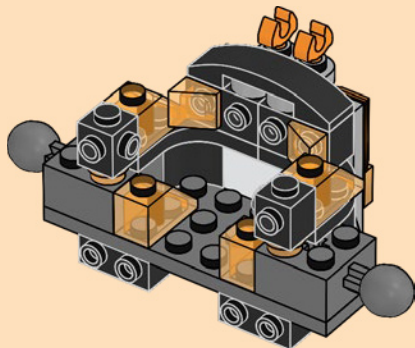

2x

# 21

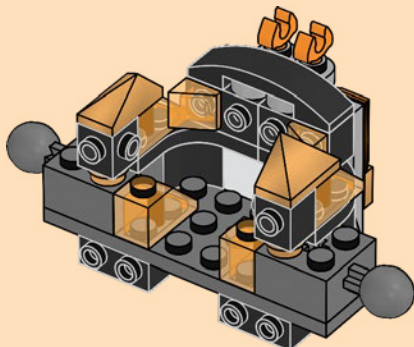



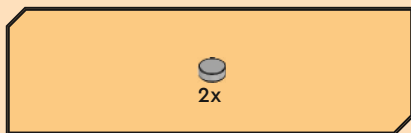

22

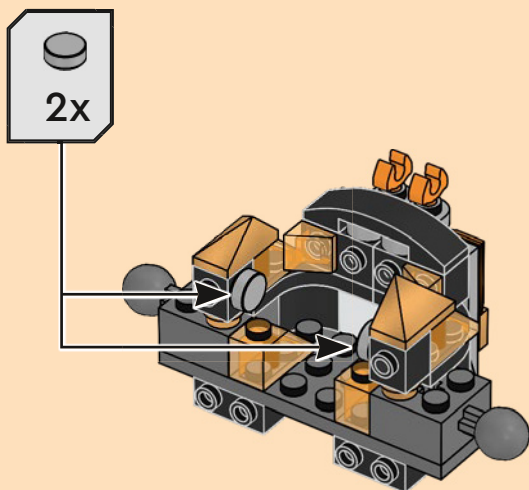



23

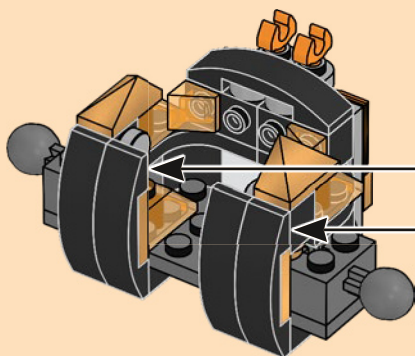
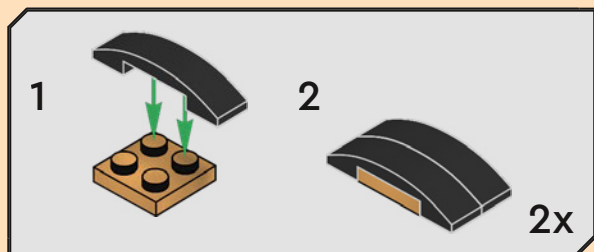



24

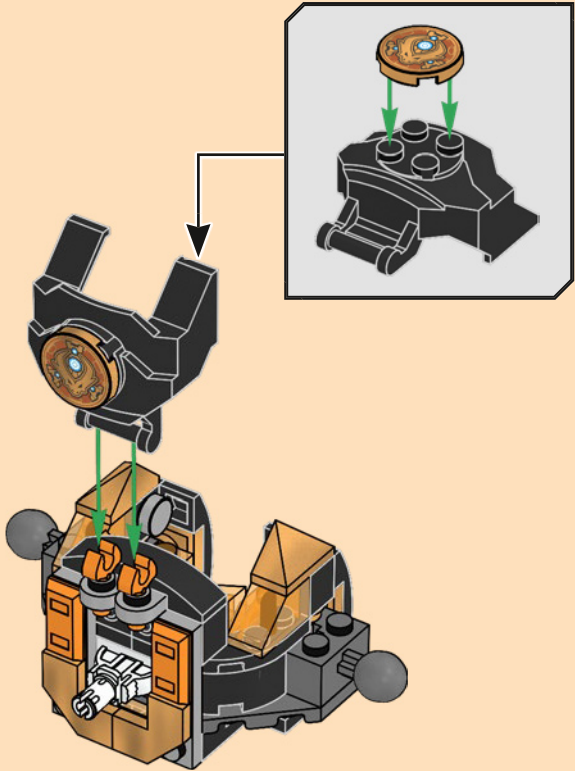

25

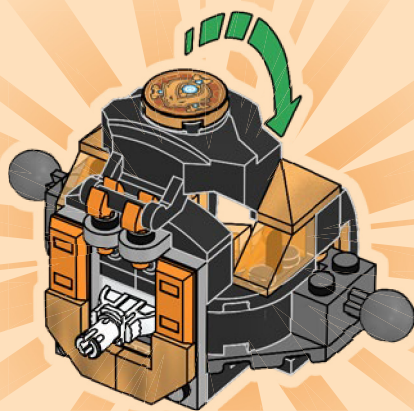

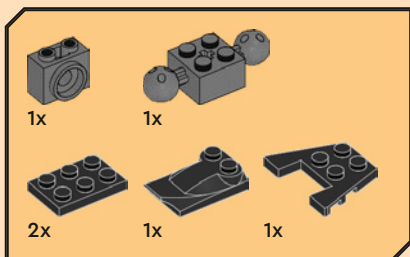

26

1

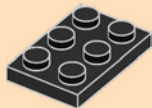

2

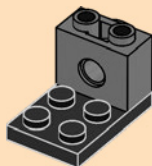

3

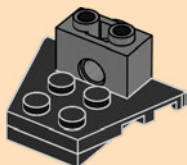

5

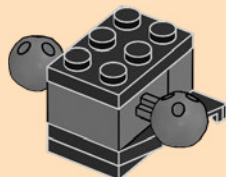

4

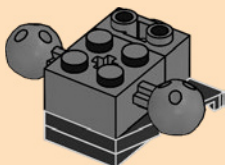

6

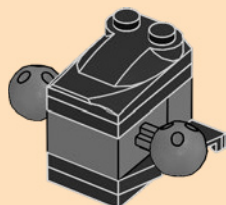

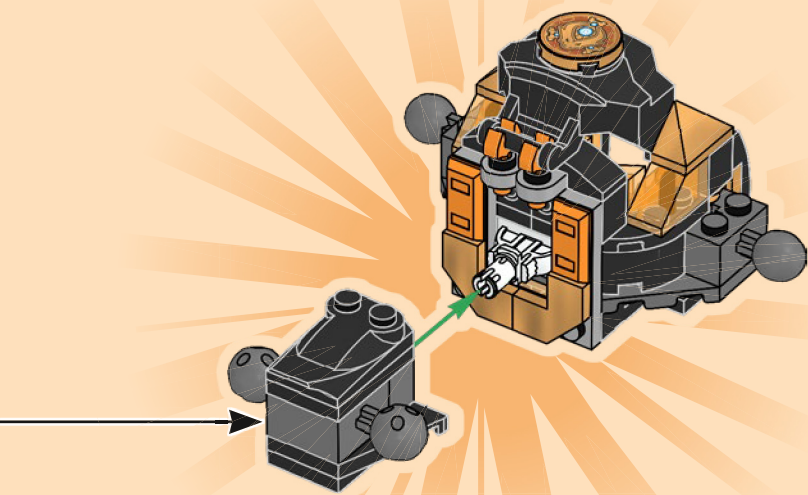



1x

# 27



1x



1x

# 28

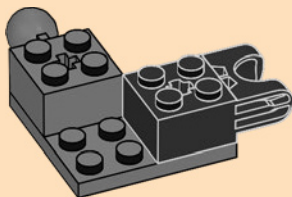





1x

# 29

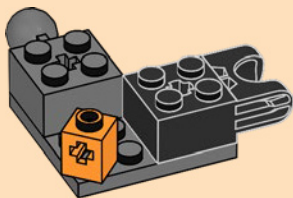

1x

# 30

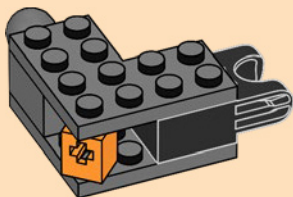

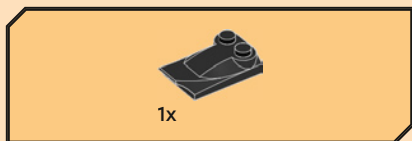

31

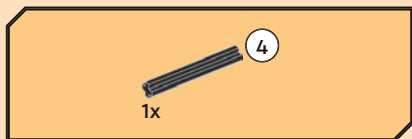
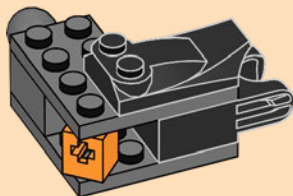

32

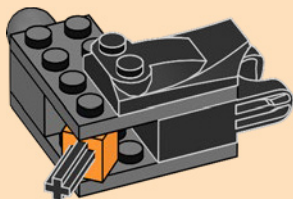

33

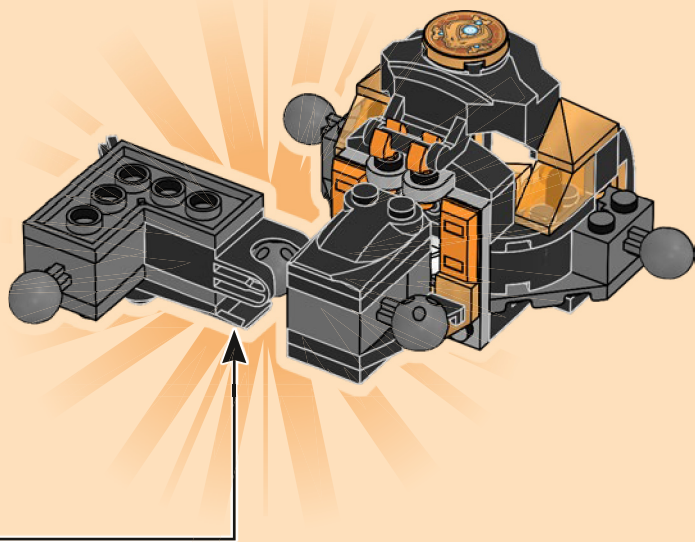

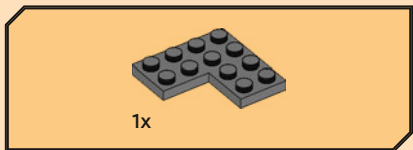

34

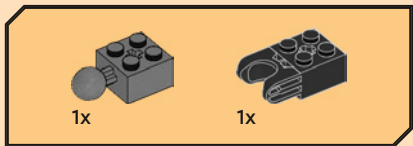

35

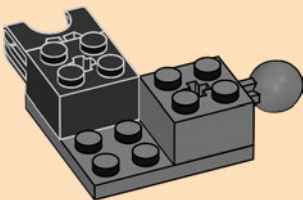



1x

# 36



1x

# 37

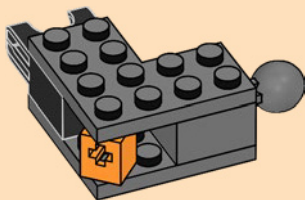

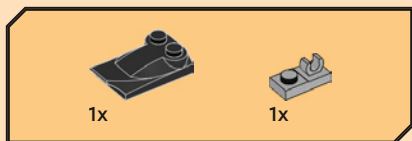

38

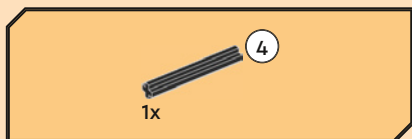
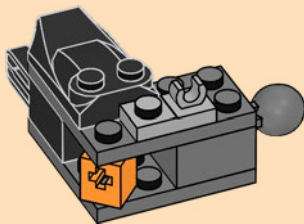

39

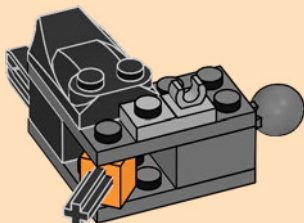

40

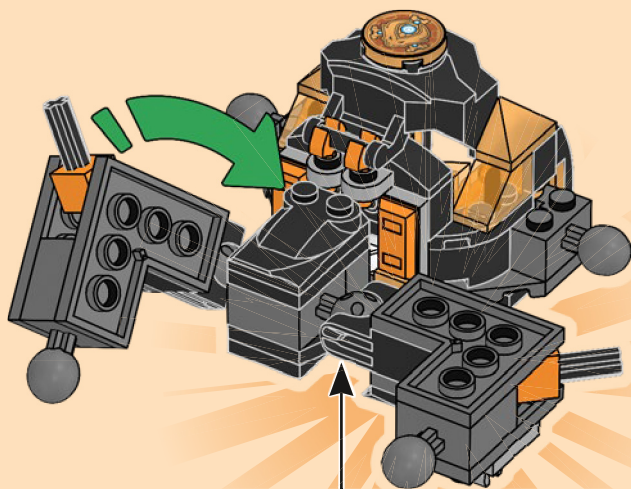

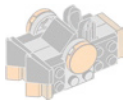

2x



1x

41



2x

42

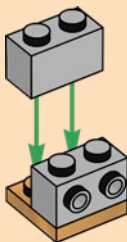



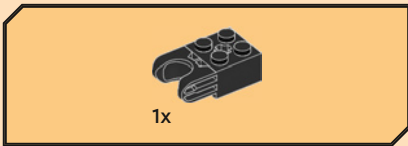

43

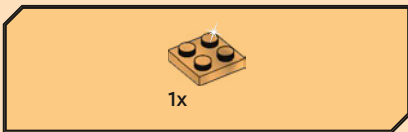
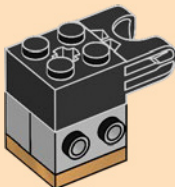

44

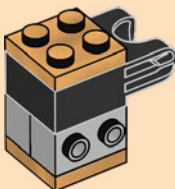

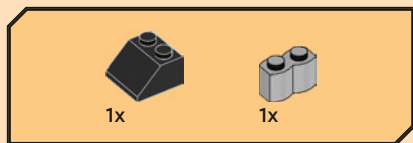

45

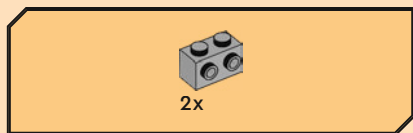
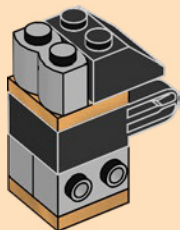

46

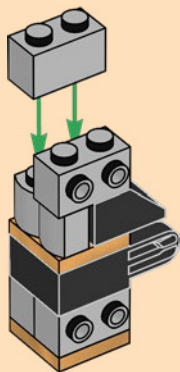

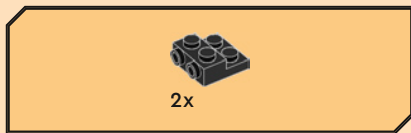

47

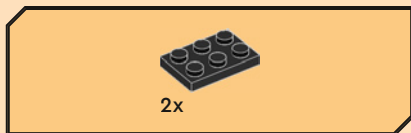
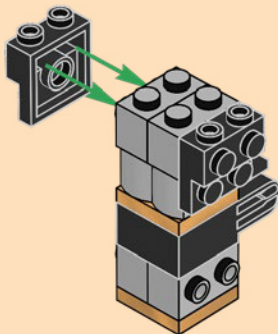

48

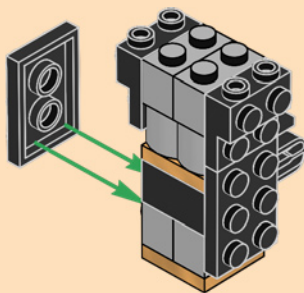



49

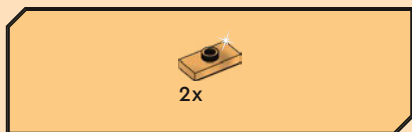
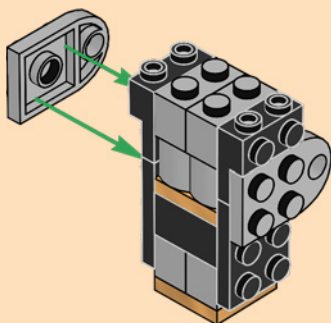

50

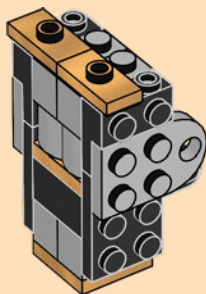



51

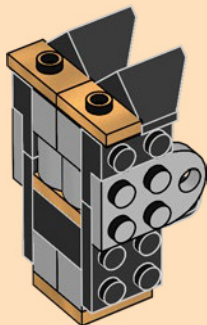

52

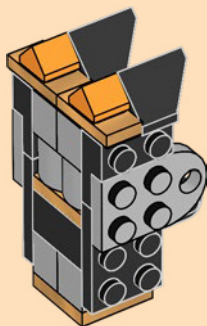



53

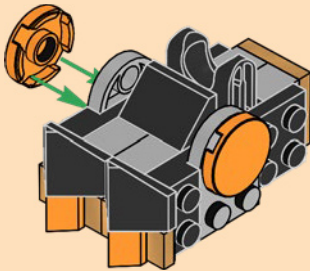

2x



54

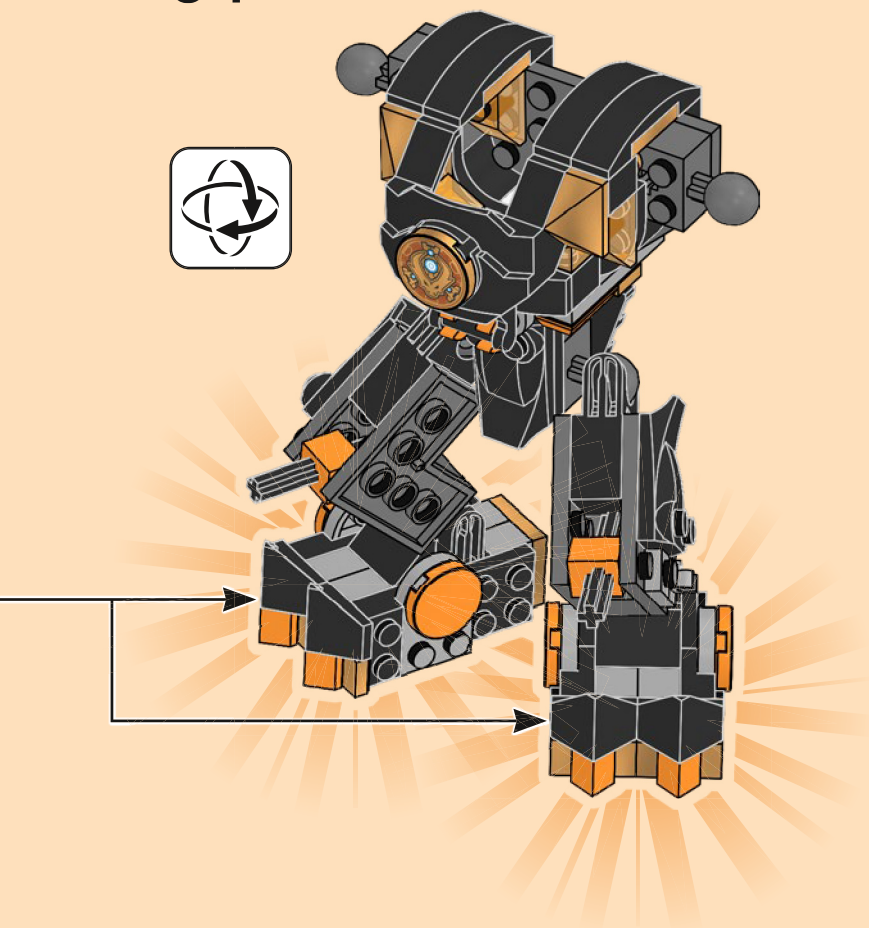



2x

55

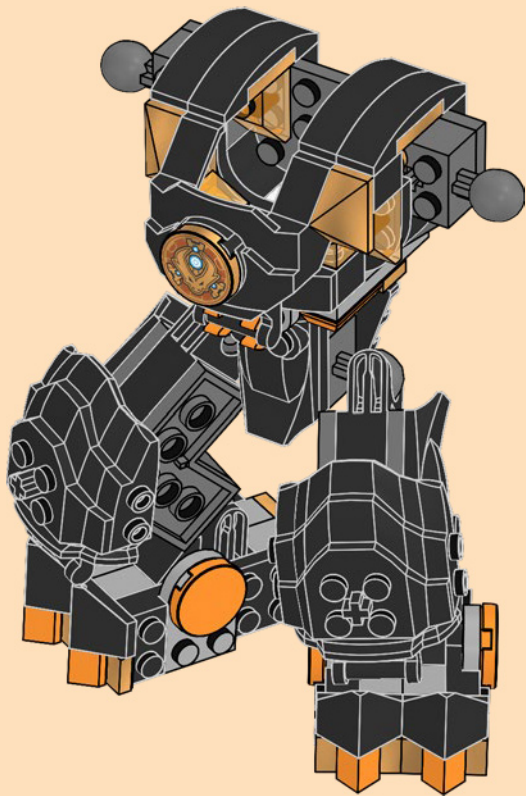





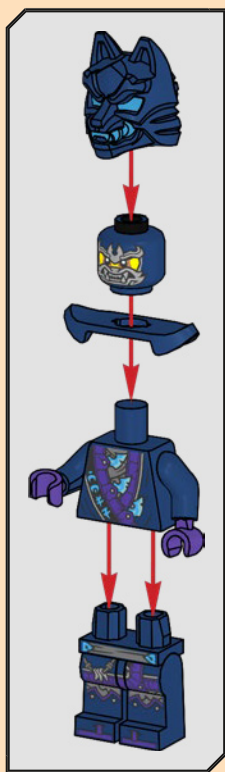

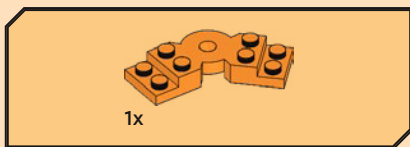
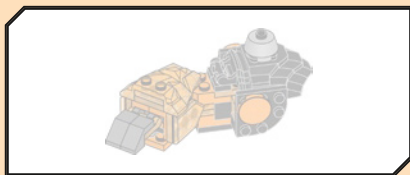

56

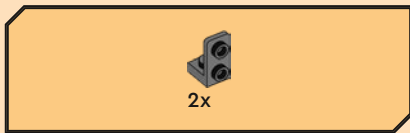
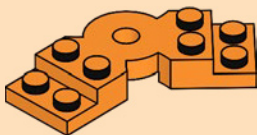

57

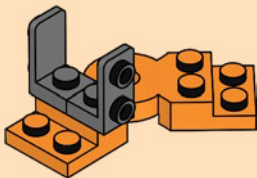

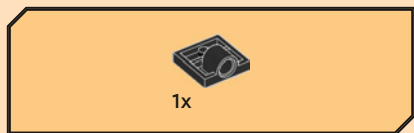

58

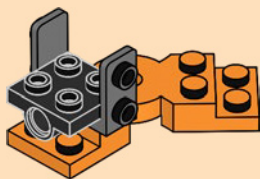

59

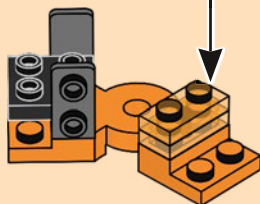
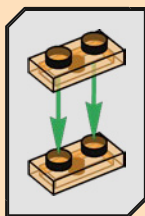



1x

60

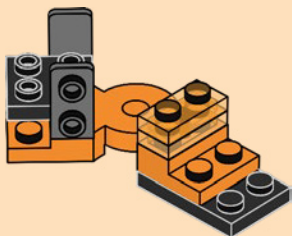

2x

61

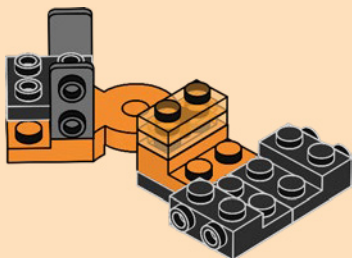

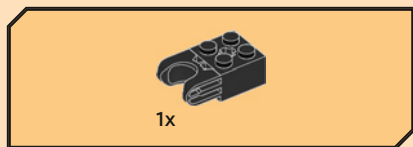

62

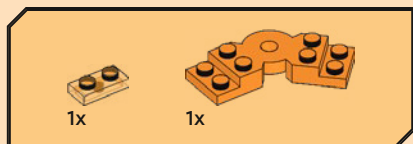
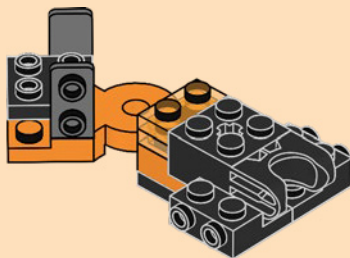

63

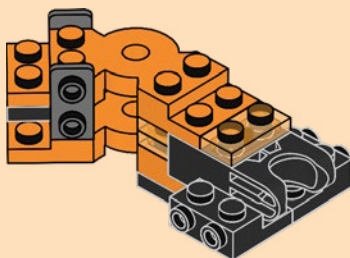

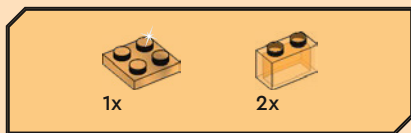

64

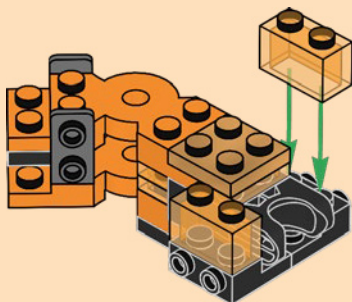

65

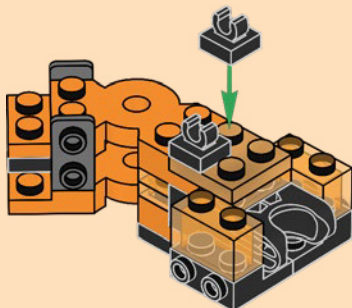

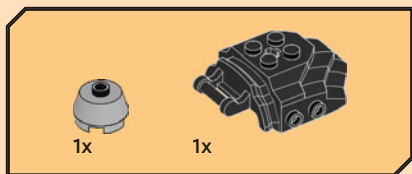

66

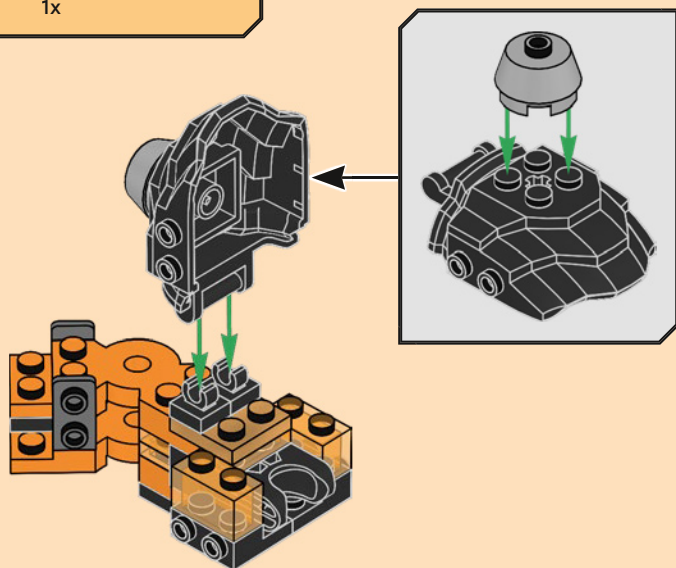

67

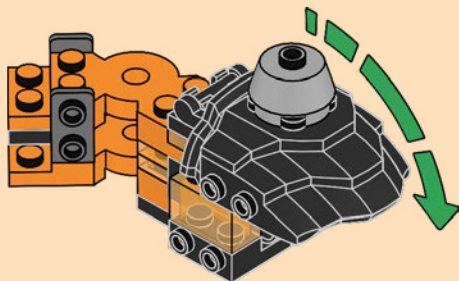



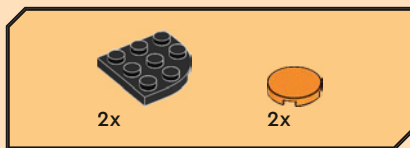

68

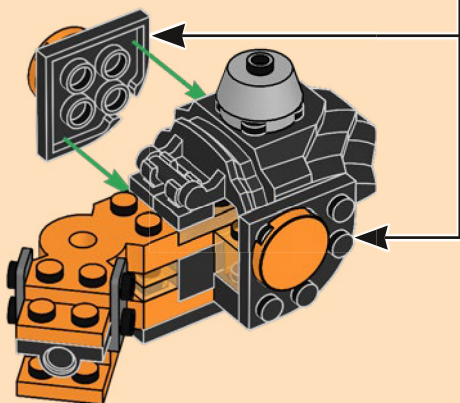
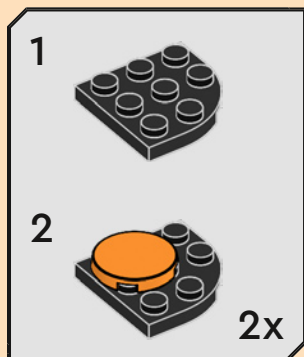



1x

69

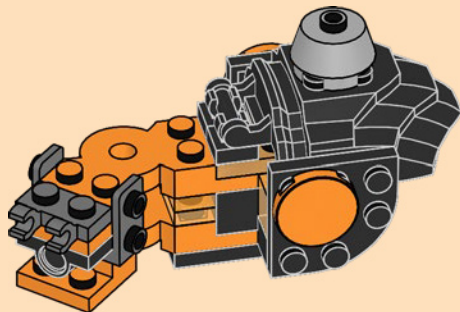

1x



2x

70

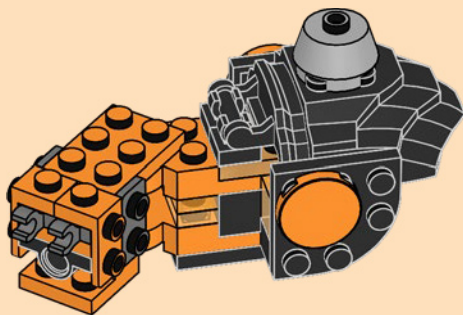

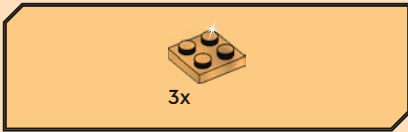

71

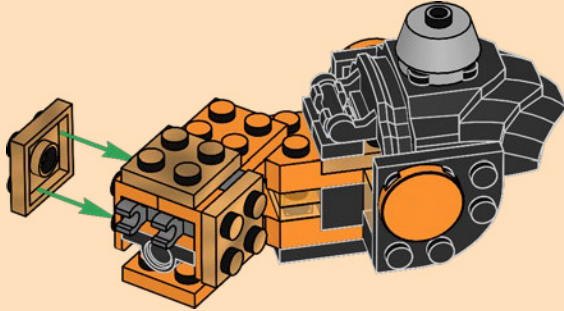

72

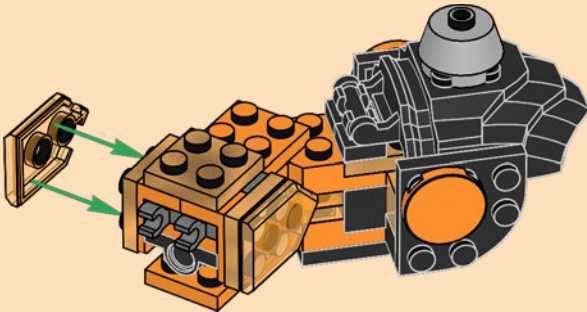



73

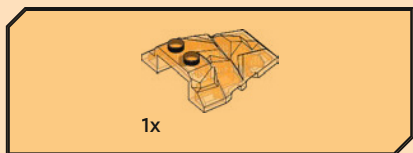
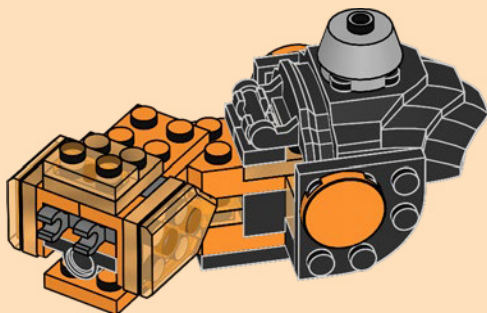

74

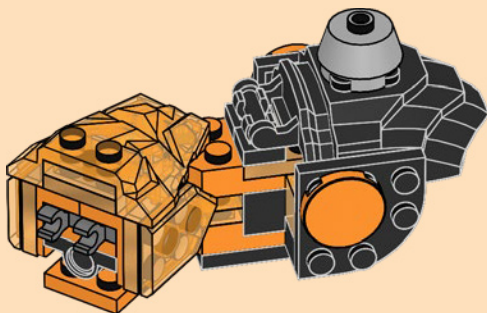

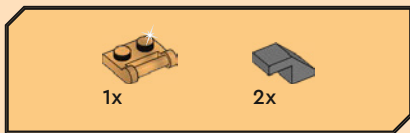

# 75

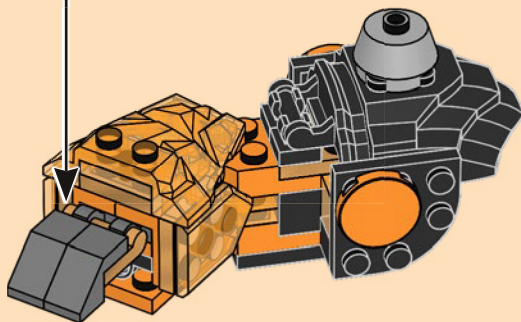
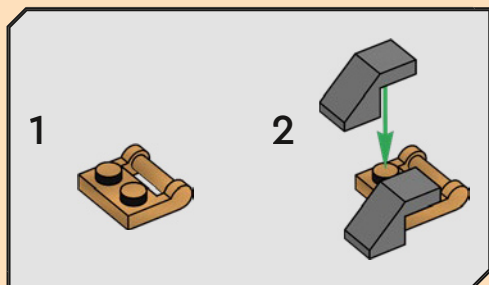

76

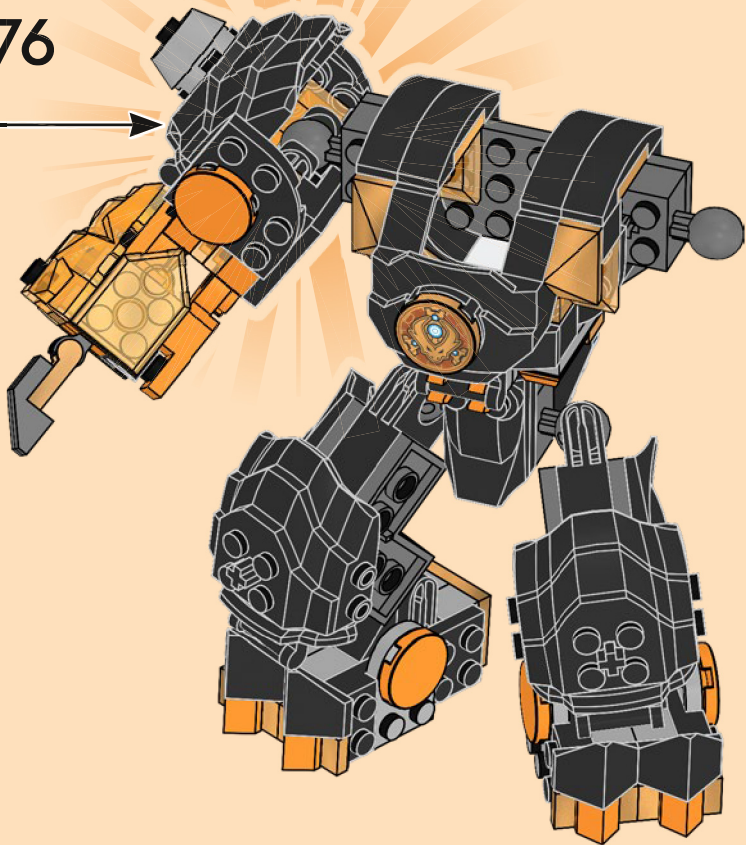

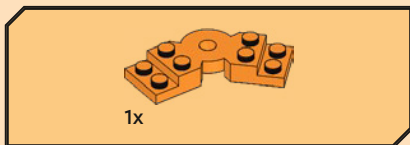
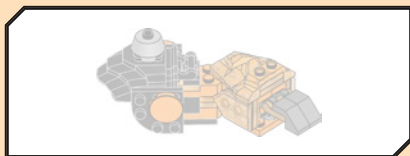

77

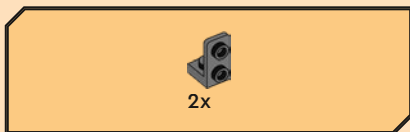
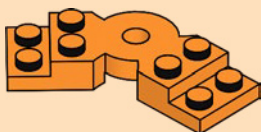

78

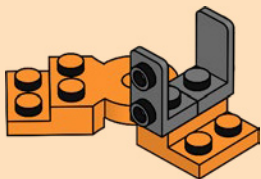



1x

# 79

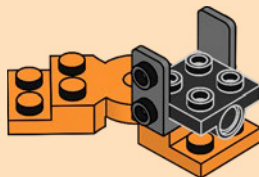

2x

# 80

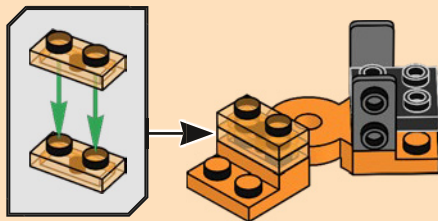



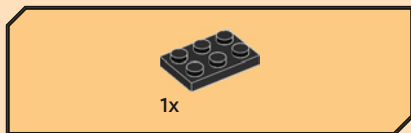

81

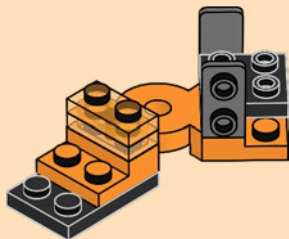

82

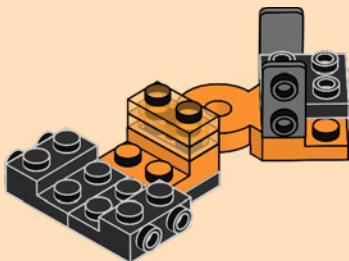

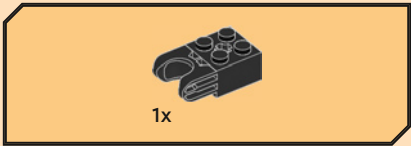

83

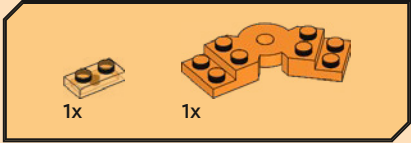
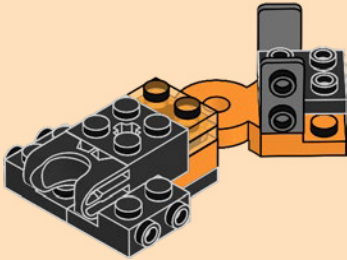

84

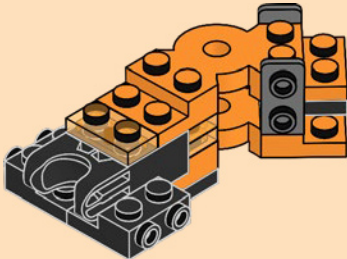

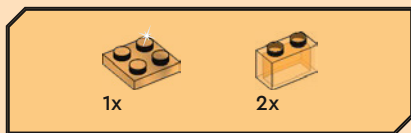

85

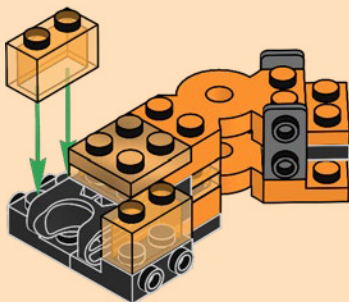

86

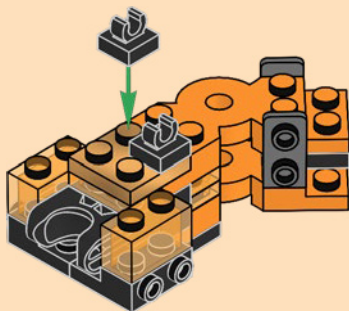

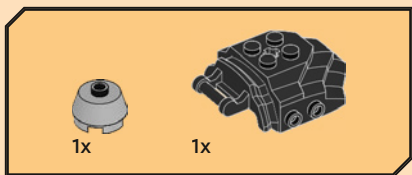

87

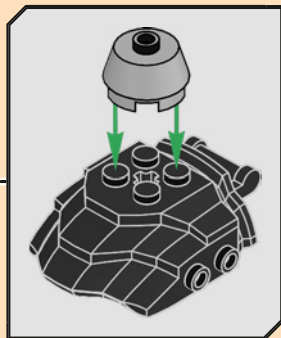
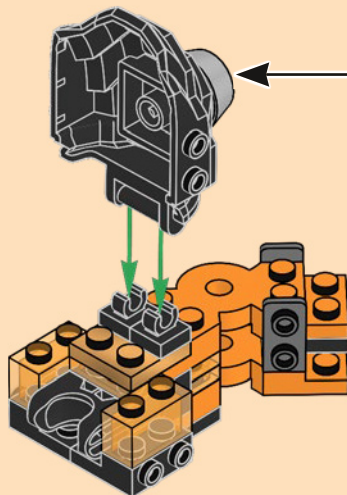

88

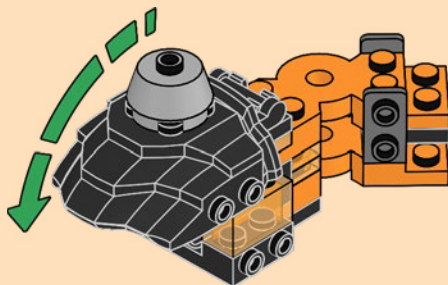

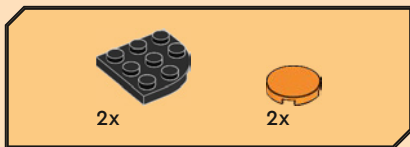

89

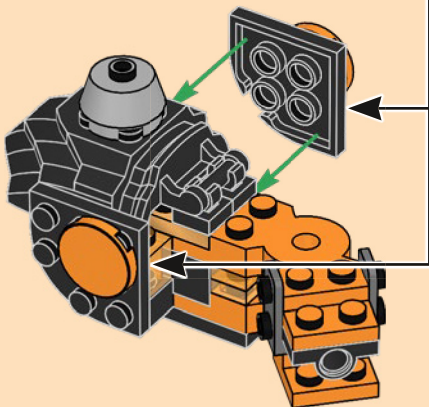
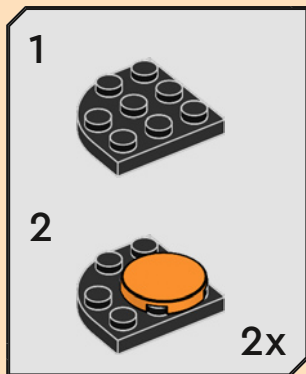



1x

# 90

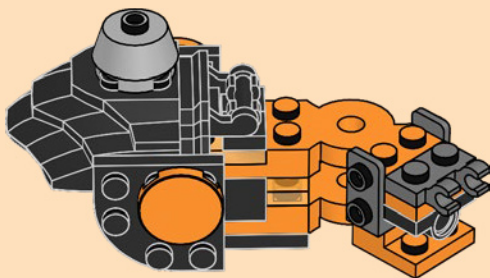

1x



2x

# 91

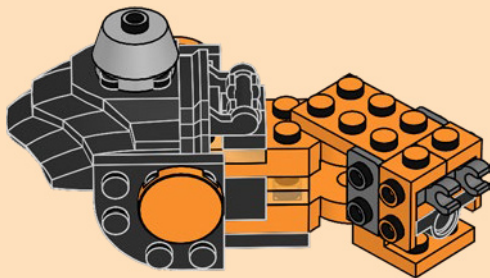



92

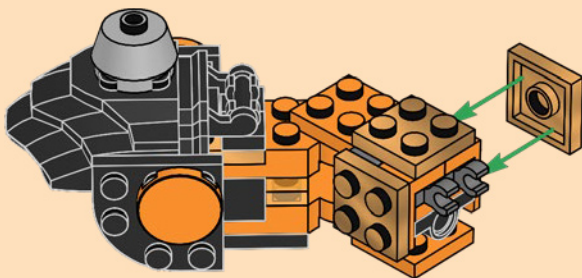

93

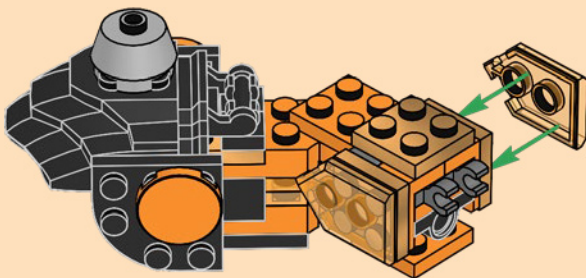

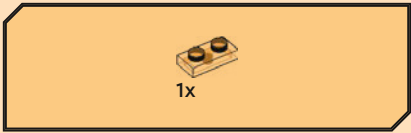

94

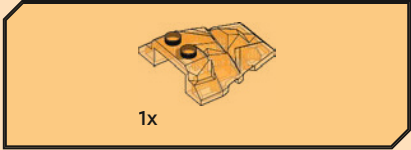
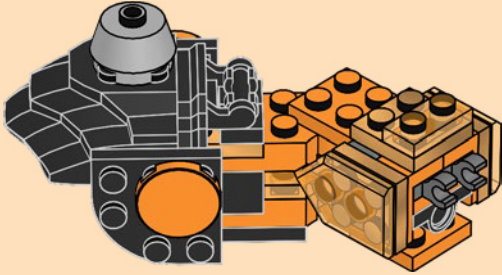

95

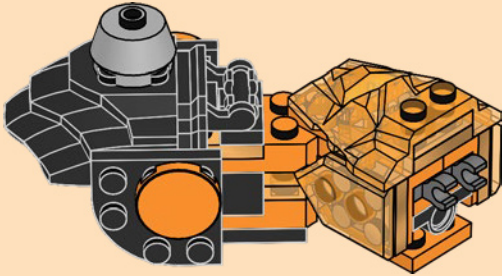



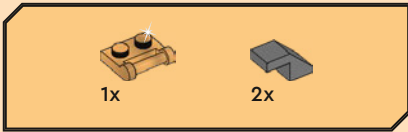

96

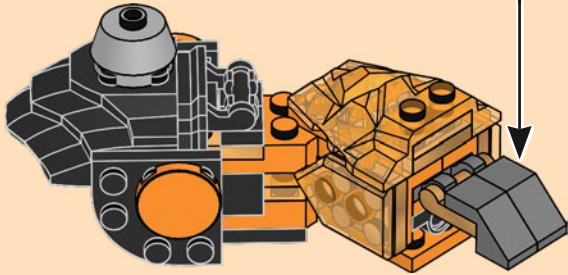
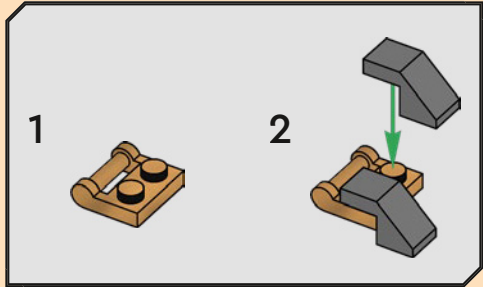

97

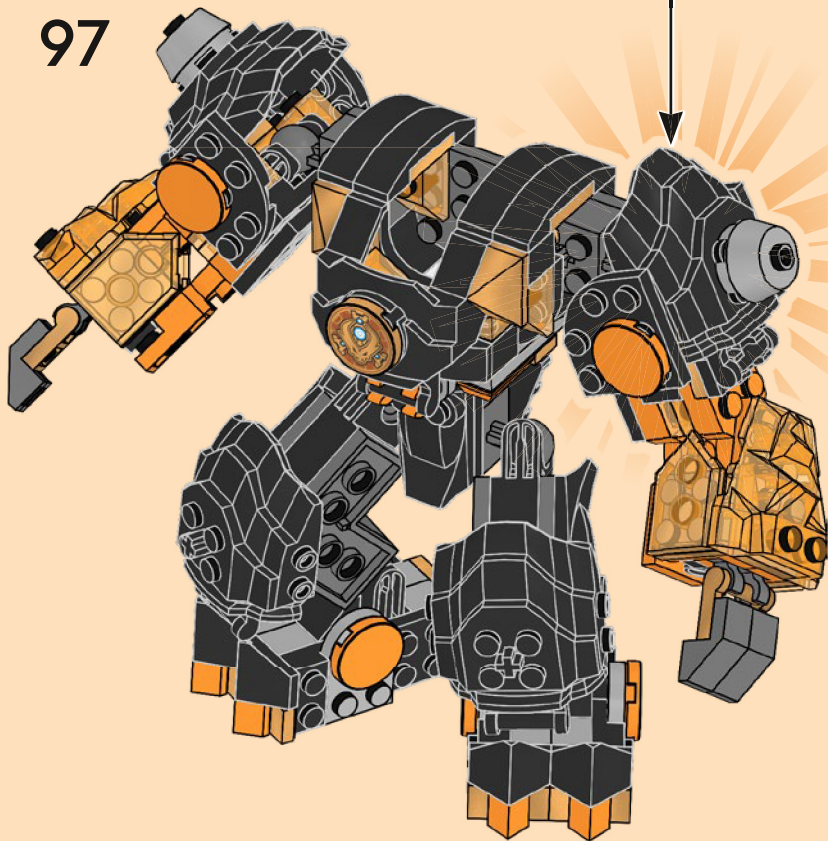

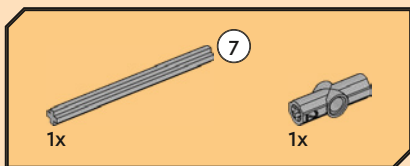
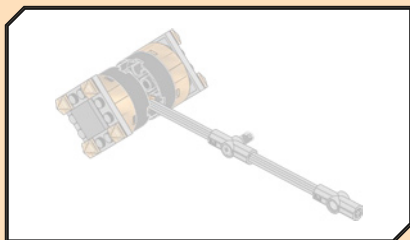

98

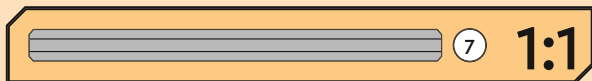
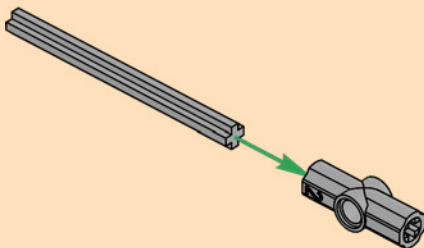

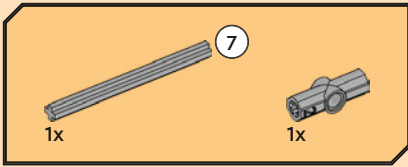

99

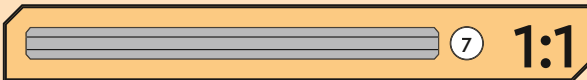
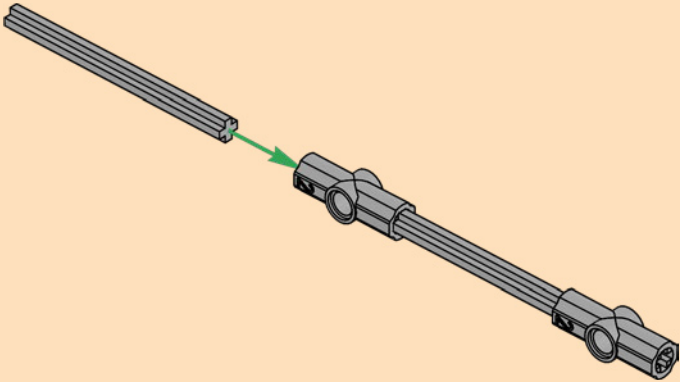

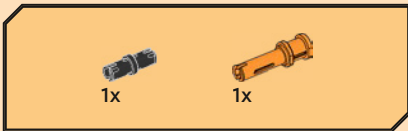

100

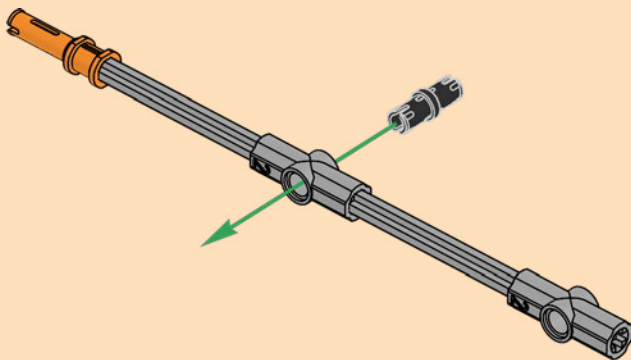



1x

101

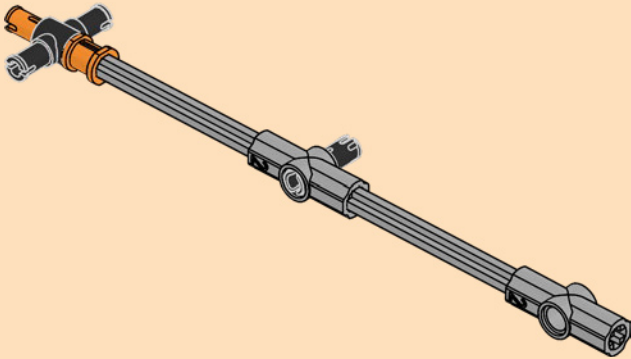

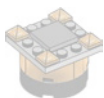

2x



1x

102



4x

103

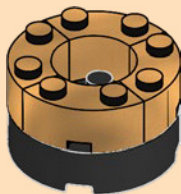

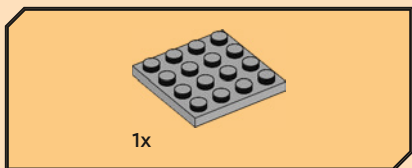

104

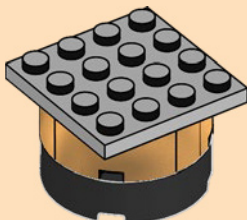

105

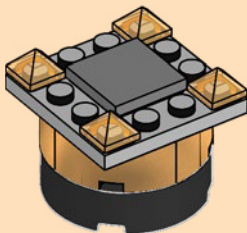

2x



106

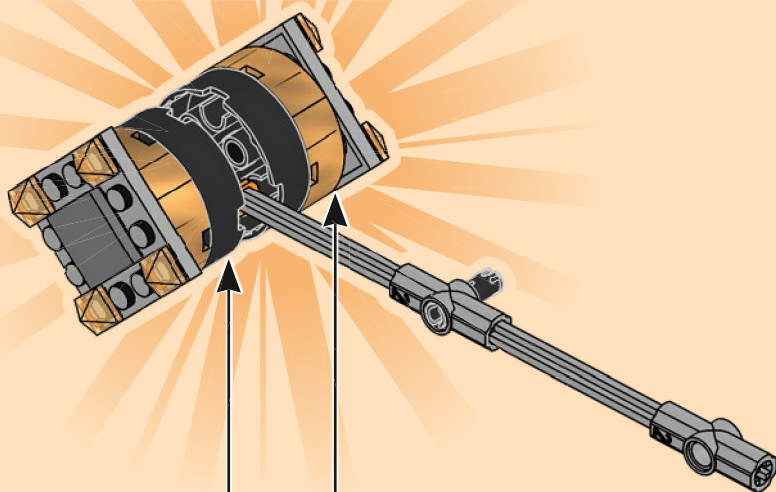

107

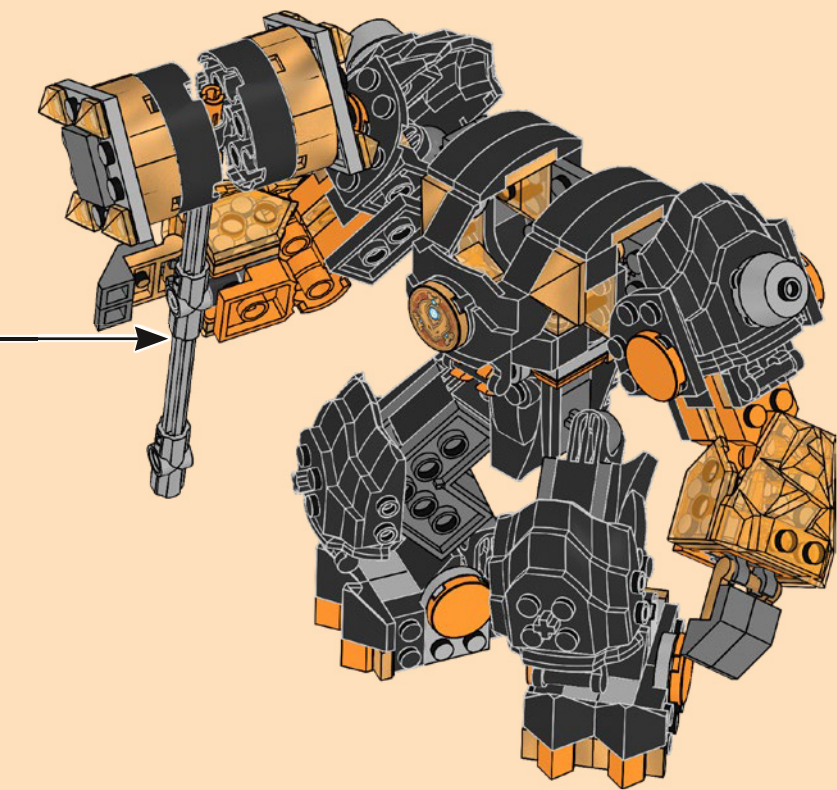

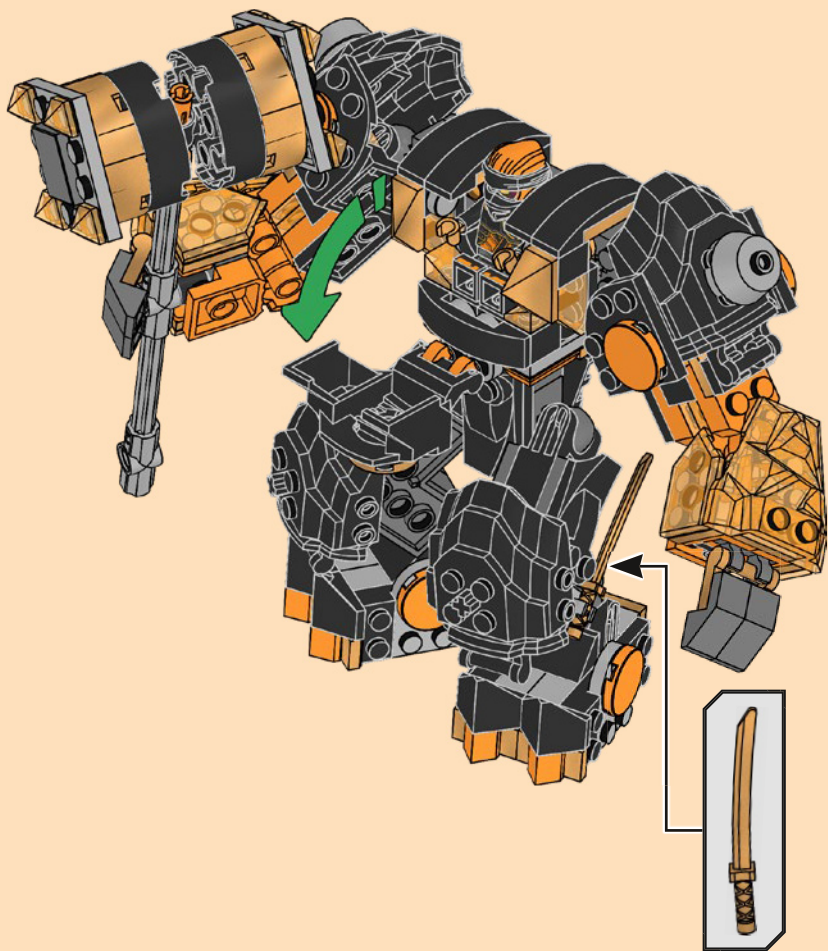



**LEGO**

**CUSTOMIZE YOUR MECH**  
**PERSONNALISEZ VOTRE ROBOT**  
**PERSONALIZA TU MECH**

71806



**A**

71807



71808



**B**



**C**



  
1x  
6366229

  
4x  
6335388

  
2x  
6187572

  
1x  
6279875

  
2x  
4253815

  
1x  
6464356

  
4x  
4220539

  
2x  
6061032

  
2x  
303926

  
2x  
4567436

  
12x  
6469445

  
1x  
6469027

  
4x  
4227392

  
8x  
302126

  
2x  
370526

  
3x  
4285883

  
5x  
4613153

  
6x  
6360825

  
2x  
4558957

  
1x  
6170529

  
2x  
6325190

  
1x  
6466691

  
4x  
6466647

  
2x  
6439042

  
2x  
6339309

  
4x  
6223631

  
4x  
6442363

  
1x  
6468747

  
8x  
6092770

  
2x  
6149656

  
1x  
6347790

  
2x  
4125278

  
1x  
4158355

  
4x  
6372446

  
1x  
6464352

  
1x  
6468746

  
1x  
6464354

  
1x  
6315048

  
1x  
6469272

  
2x  
6245265

  
8x  
6250584

  
4x  
6219825

  
10x  
6240217

  
4x  
6466832

  
4x  
6382017

  
2x  
6466641

4

2x  
6284071

2x  
6248890

2x  
6028324

2x  
4550325

1x  
6326078

8x  
6015344

2x  
6346487

4x  
4211419

2x  
4211445

2x  
4243797

2x  
4211805

4x  
6336390

1x  
6398662

4x  
6168776

2x  
6350292

2x  
4211055

4x  
4497253

1x  
6065816

4x  
4539429

1x  
6311001

4x  
4523159

2x  
6075079

1x  
6467216

4x  
6092594

2x  
4585493

2x  
6388241

8x  
6107743

1x  
6116596

14x  
6347982

1x  
6434450

1x  
6472887

1x  
6461579



LEGO.com/service

YOU COULD

# WIN



Scan this QR code or go to  
**LEGO.COM/PRODUCTFEEDBACK**  
and give us your short feedback  
about this LEGO® set for a chance  
to win a cool LEGO prize.

Terms and Conditions apply\*



**EN: YOU COULD WIN.** Terms and Conditions apply\* **DE: Du könntest GEWINNEN.** Es gelten die Teilnahmebedingungen\* **FR: Tu pourrais GAGNER.** Des conditions s'appliquent\* **IT: Potresti VINCERE tu.** Termini e condizioni sono applicabili\* **ES: Puedes GANAR.** Aplican términos y condiciones\* **PT: Poderá GANHAR.** Aplicam-se termos e condições\* **ZH: 轻松获奖. 条款和条件适用\*** **PL: Szansa na WYGRANĄ.** Obowiązują warunki korzystania\* **CS: Máte šanci VYHRÁT.** Platí všeobecné smluvní podmínky\* **SK: Máte šancu VYHRAŤ.** Platia všeobecné zmluvné podmienky\* **HU: TE IS NYERHETSZ.** Felhasználási feltételek érvényesek\* **RO: Ai putea CÂȘTIGA.** Se aplică termenii și condiții\* **BG: Можете да СПЕЧЕЛИТЕ.** Има определени правила и условия\* **LV: Tu vari LAIMĒT.** Ir spēkā noteikumi un nosacījumi.\* **ET: Sul on võimalus VÕITA.** Kehtivad tingimused\* **LT: Jūs galite LAIMĖTI.** Taikomos sąlygos\*

\*[LEGO.com/productfeedback-terms](https://www.lego.com/productfeedback-terms)

LEGO, the LEGO logo, NINJAGO and the NINJAGO logo are trademarks of the/  
sont des marques de commerce du/son marcas registradas de LEGO Group.  
©2024 The LEGO Group.