

LEGO

BIONICLE®

70792



[LEGO.com/bionicle](https://www.LEGO.com/bionicle)



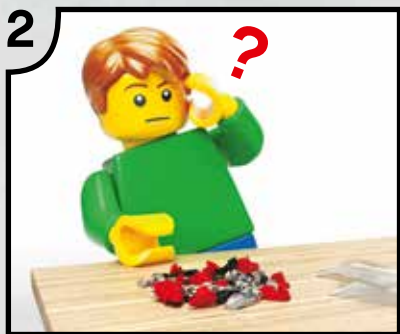

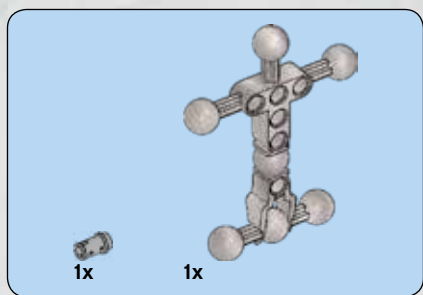

1

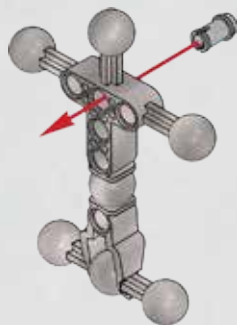



2

1

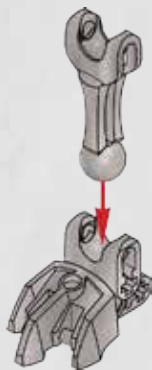

2



2x

3

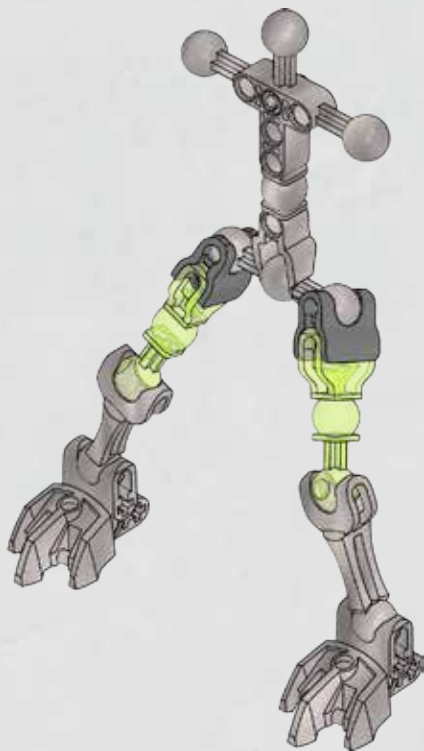

6



2x



2x

4

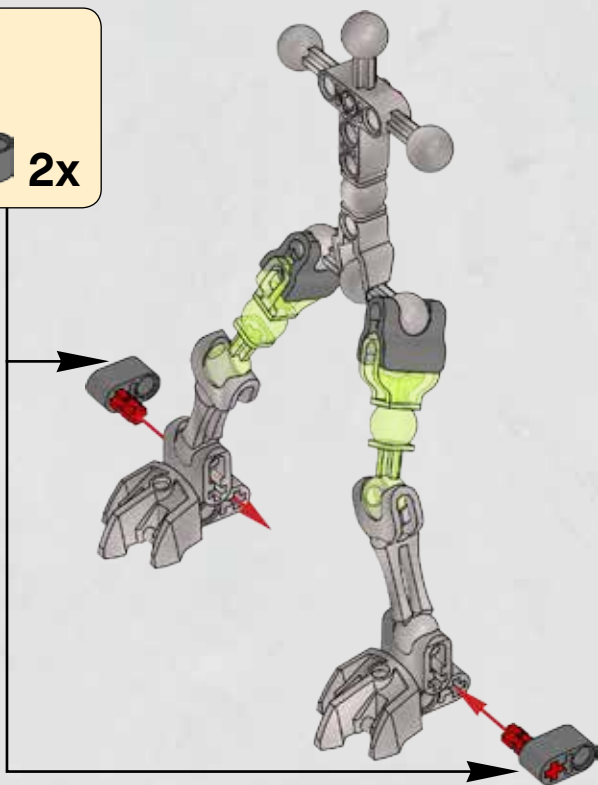
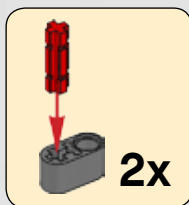

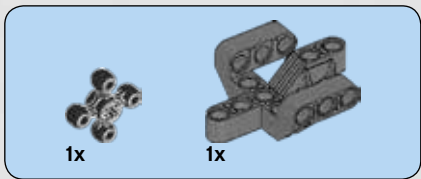

5

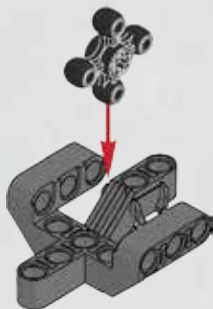

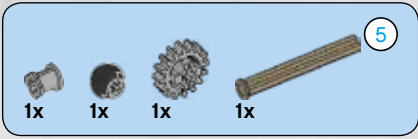

6

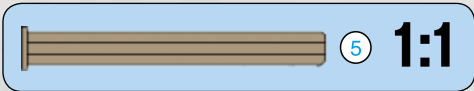
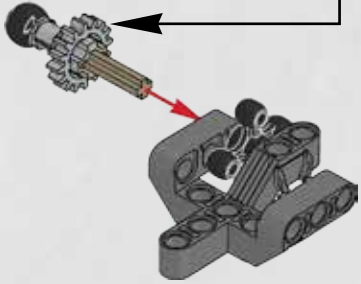
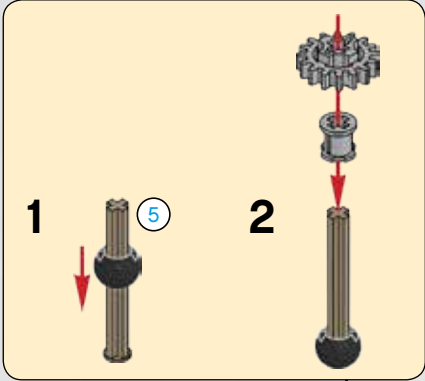

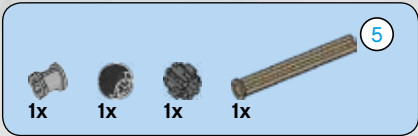

8

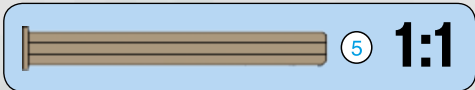
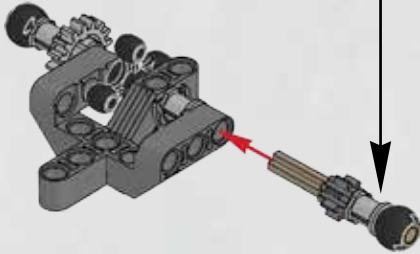
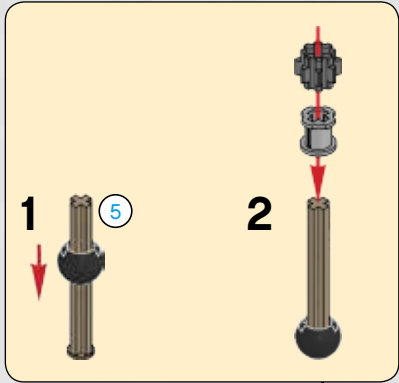



9

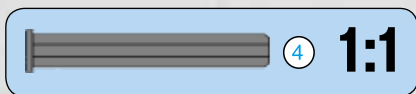
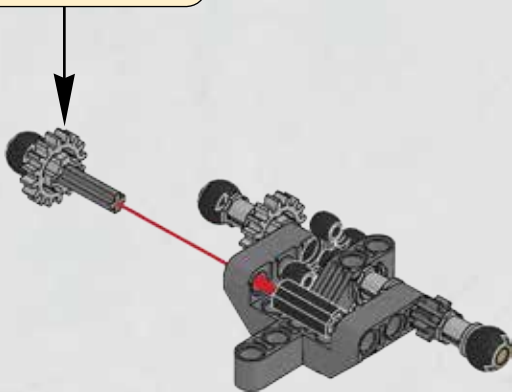
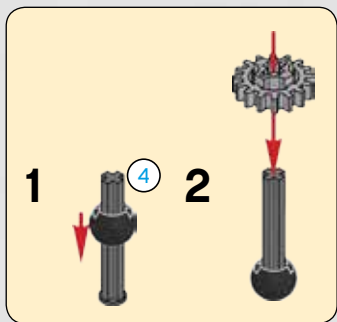



1x



1x

10

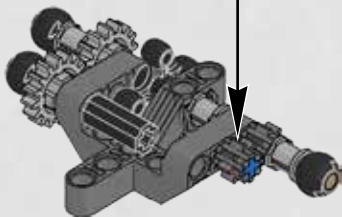
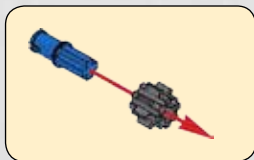

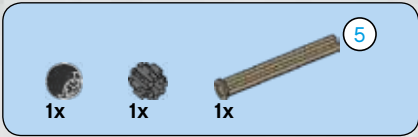

11

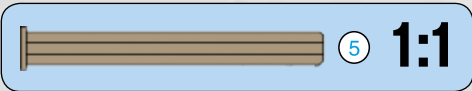
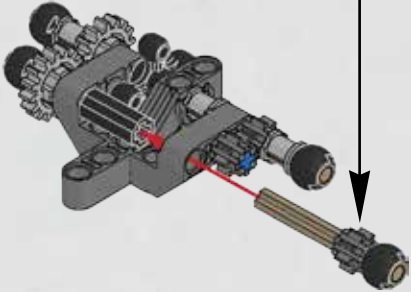
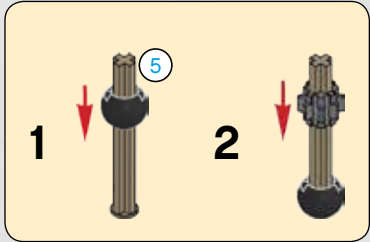



1x

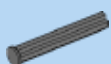

4

1x

12

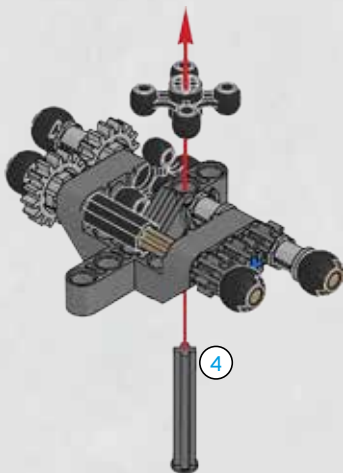

4

1:1



1x



1x

13

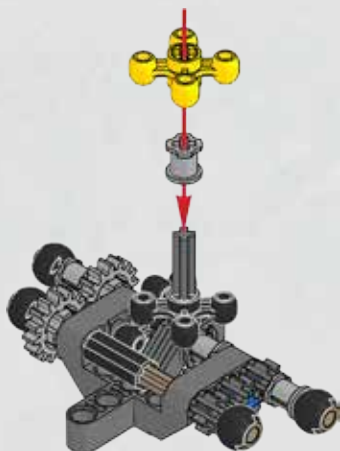



2x

14

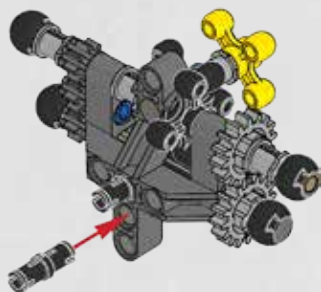

15

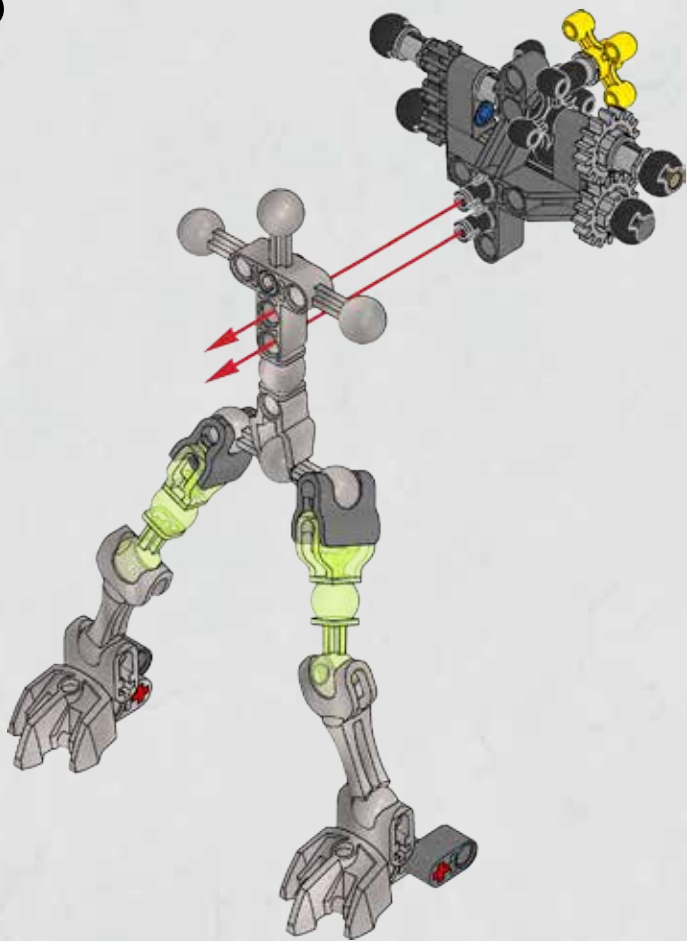

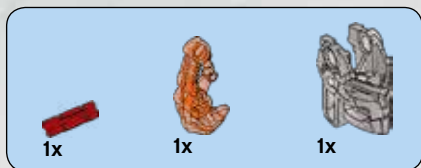

16

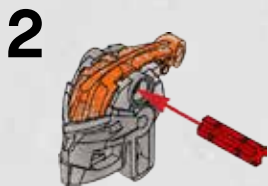
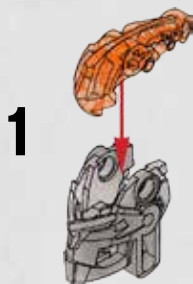

17

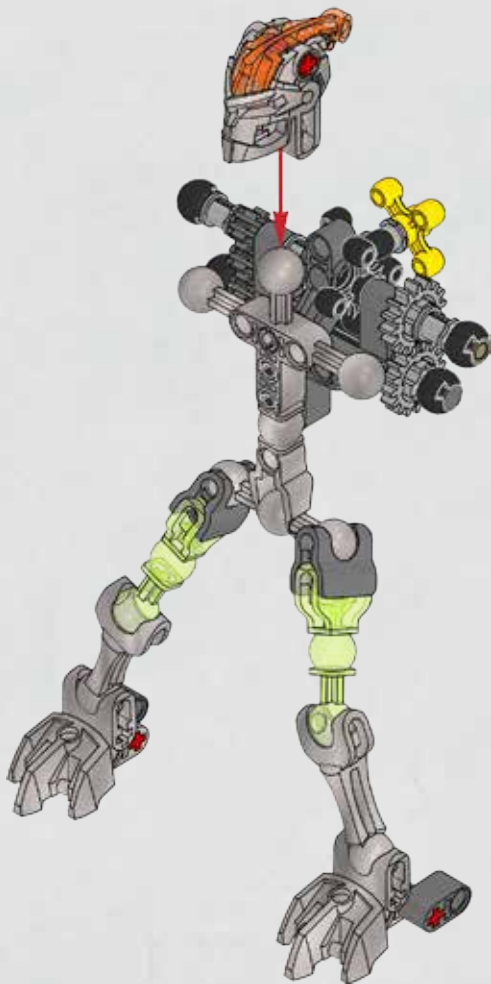



18

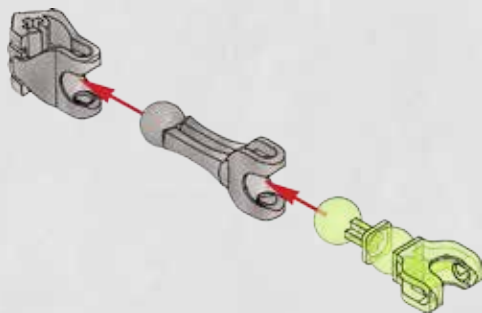

4x

19

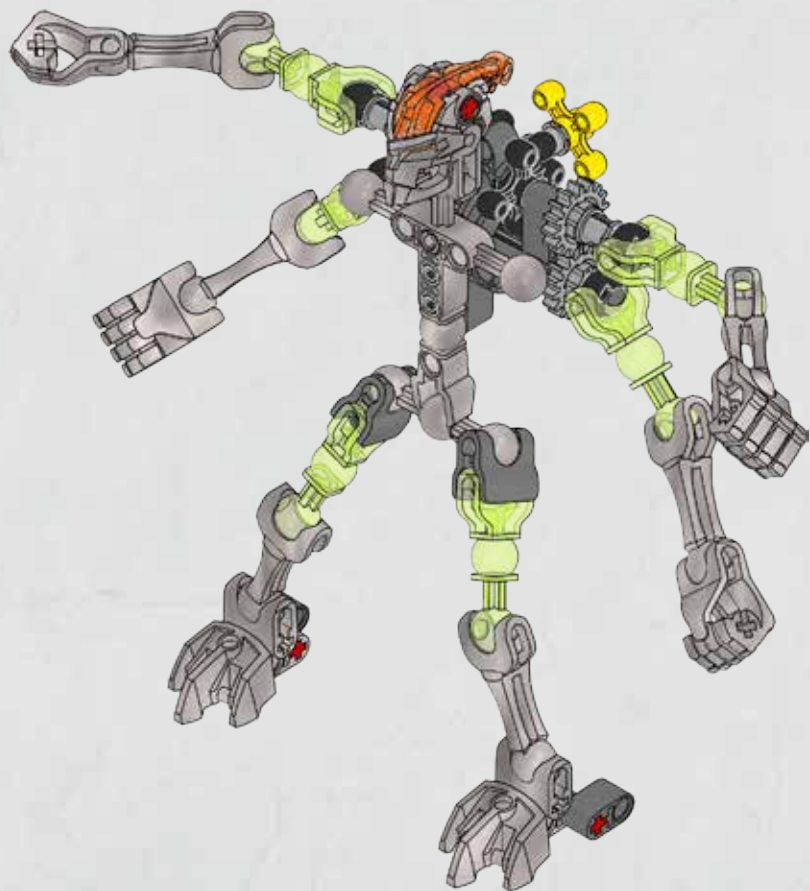

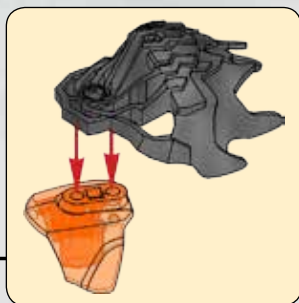
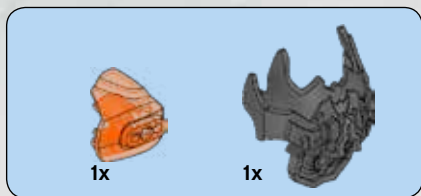

20

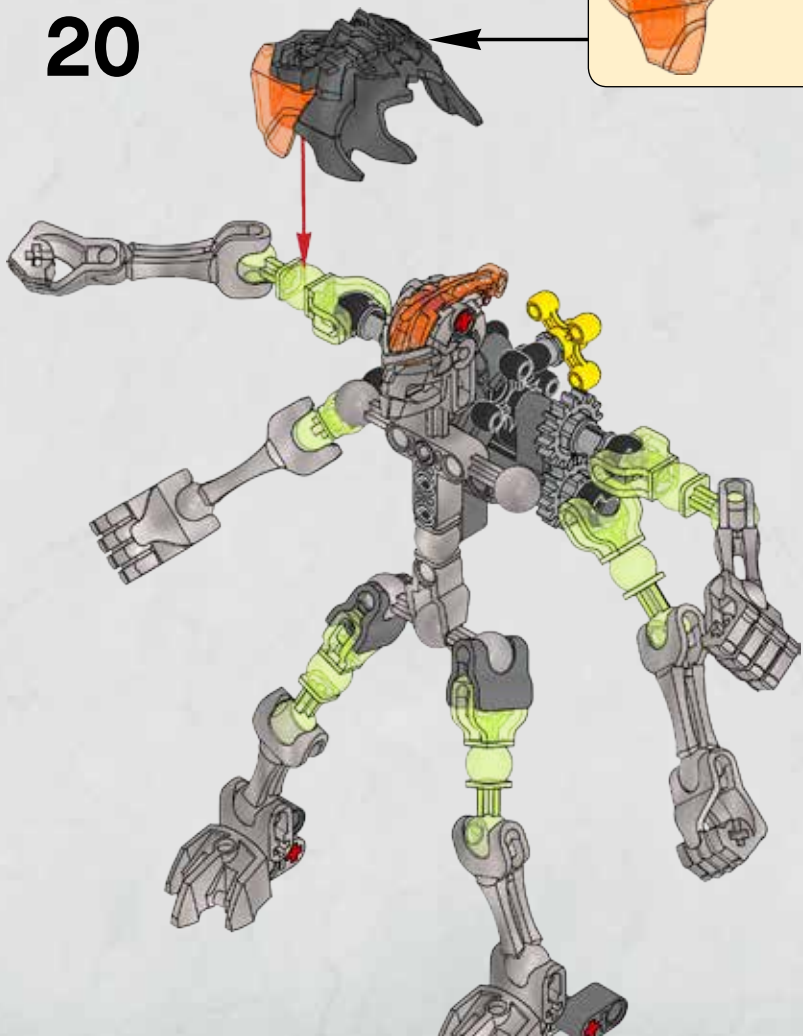



1x



1x

21

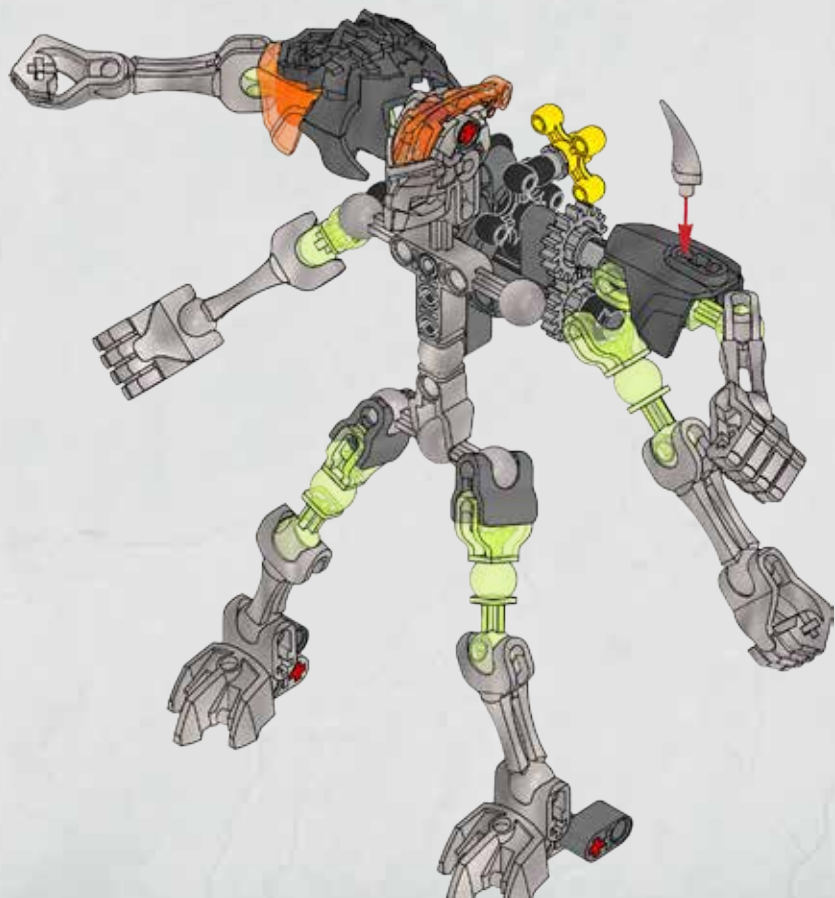



22

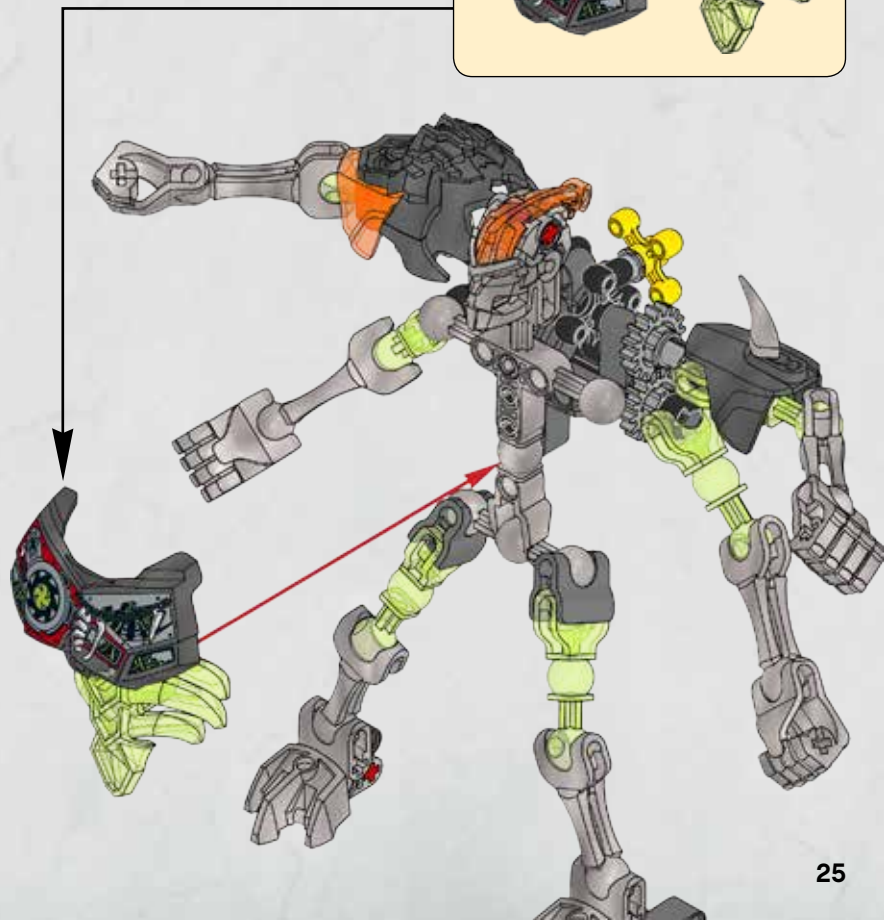
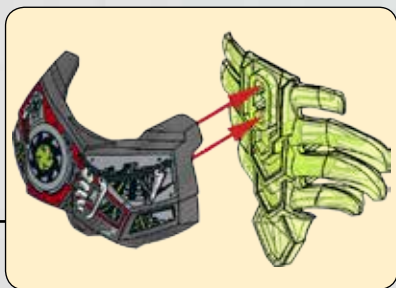

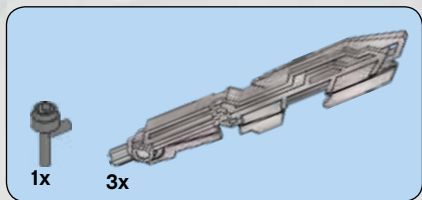

23



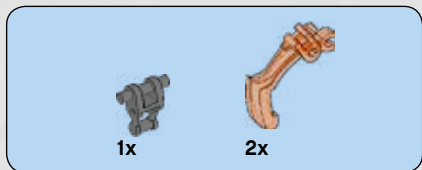
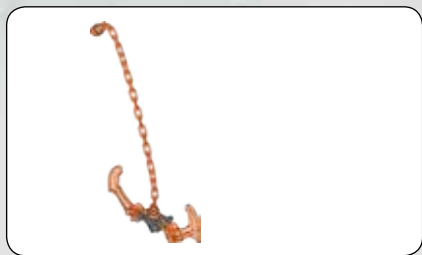

24

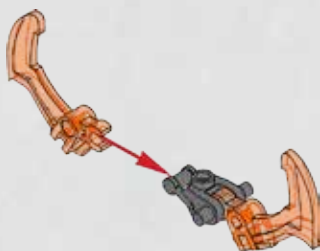

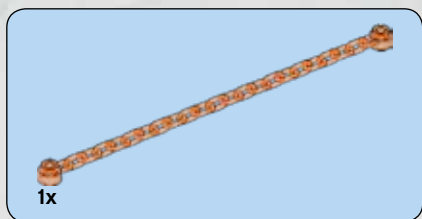

25

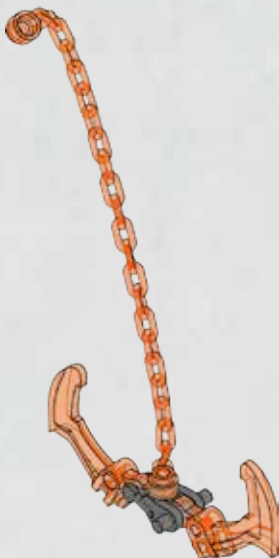

26





27



3x
4142865

1x
4206482

1x
4203493

4x
4286267

2x
4121715

1x
4512363

2x
4248204

1x
6114401

2x
6111272

1x
6102640

1x
6045953

3x
6055631

1x
4211483

4x
4211622

2x
4640536

1x
4521512

1x
4566028



2x
6006141

1x
6102645

2x
6106472

2x
6083620

3x
6012451

6x
6107475

1x
6114322

1x
4617190

6x
6114326

1x
6115891

4x
4619077

2x
6100892

1x
6102606

1x
6106710

3x
6114379

1x
6061054

1x
6114328

1x
6115546

1x
6114250



Customer Service
Kundenservice
Service Consommateurs
Servicio Al Consumidor

LEGO.com/service or dial



: 00800 5346 5555

: 1-800-422-5346



70791



70792



70793



 LEGO.com/bionicle/bi

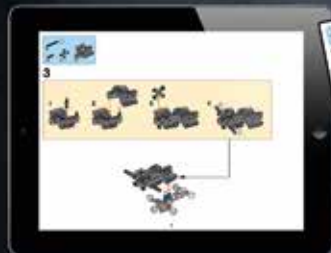

 LEGO.com/bionicle



Download App
下载应用程序



Available on the
 **App Store**

Apple, the Apple logo, iPad, iPhone and iPod touch are trademarks of Apple Inc.

GET IT ON

Google Play is a trademark of Google Inc.





70791

70794



70795



70792



70793