



CITY

60422



7

8

9

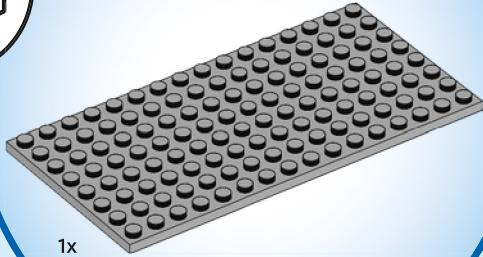
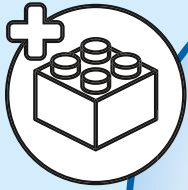

1x

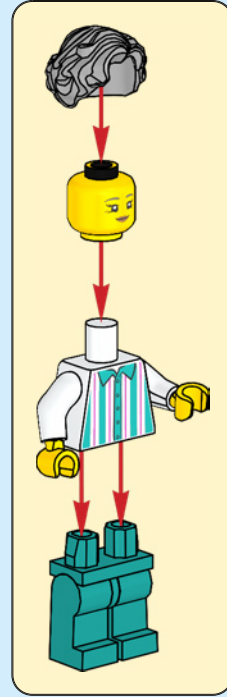

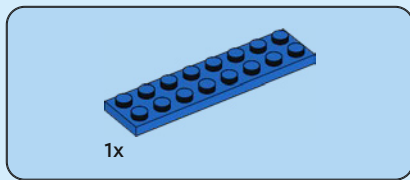

1

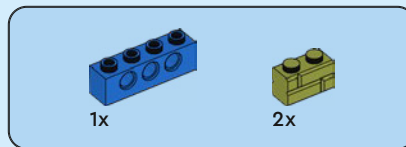
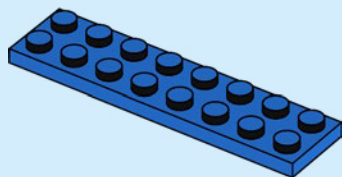

2

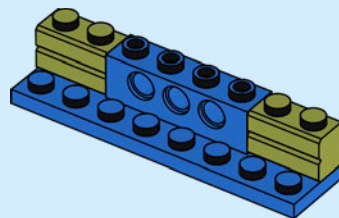

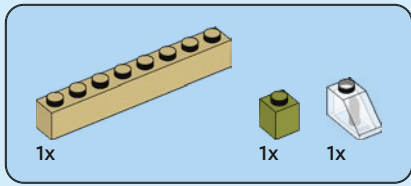

3

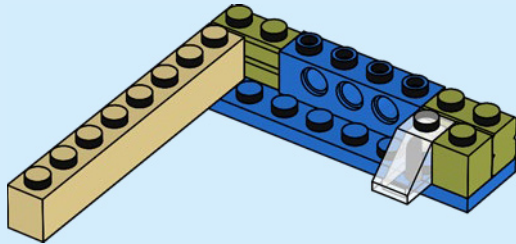

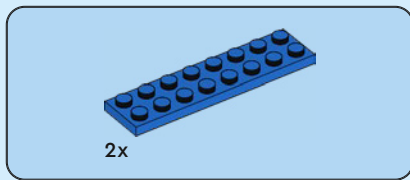

4

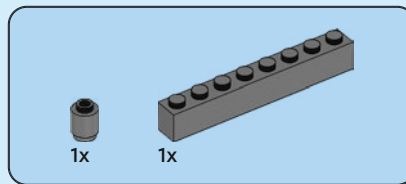
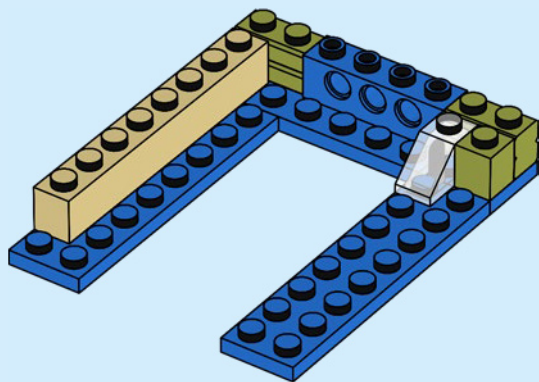

5

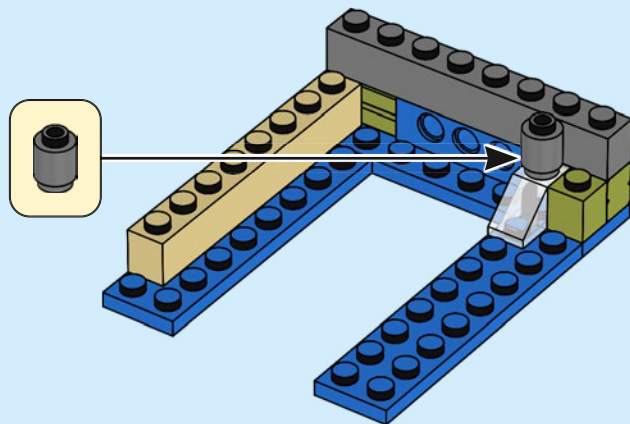

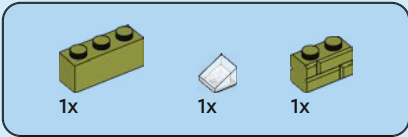

6

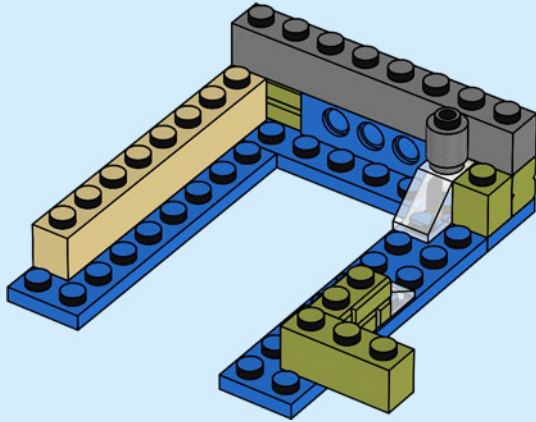

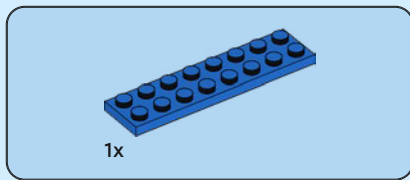

7

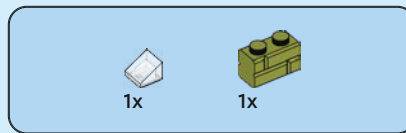
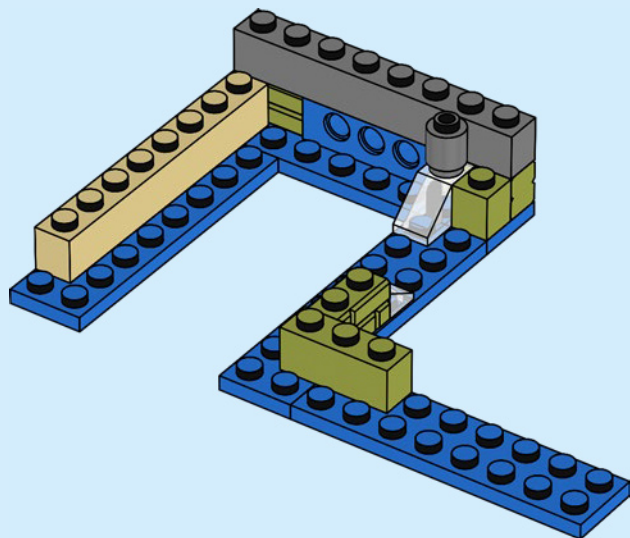

8

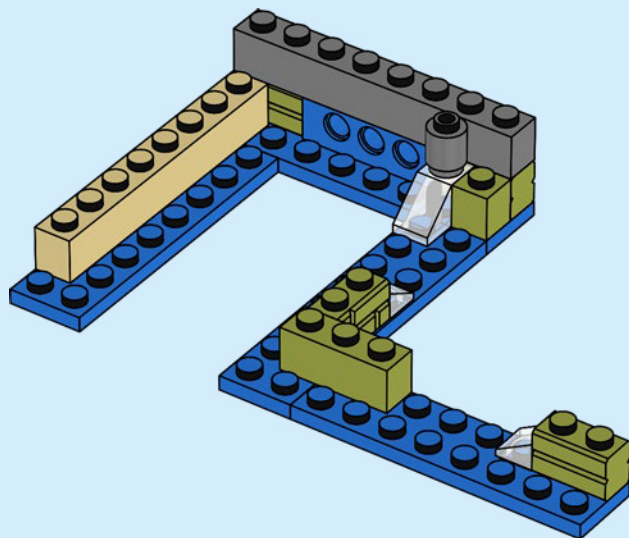

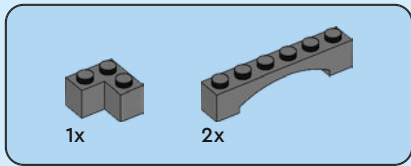

9

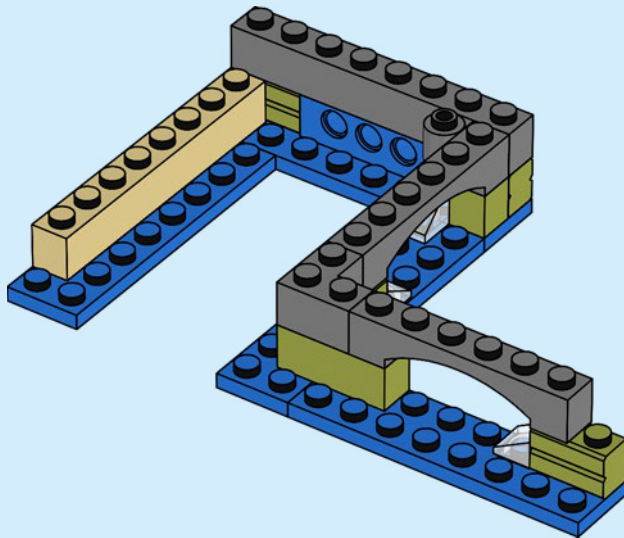

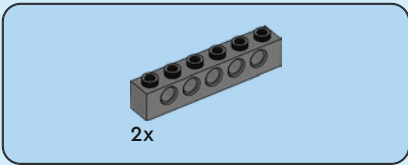

10

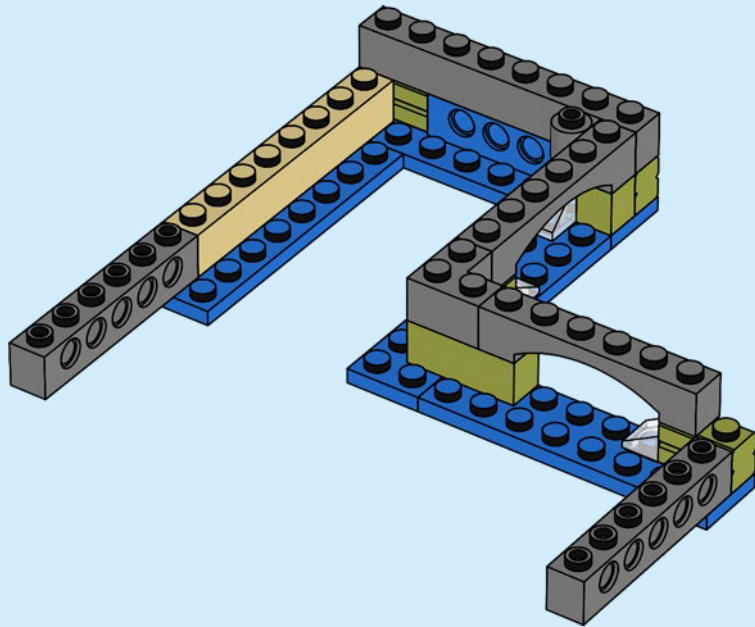

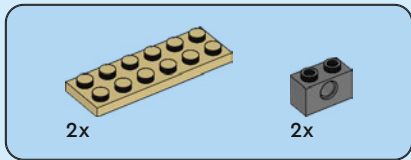

11

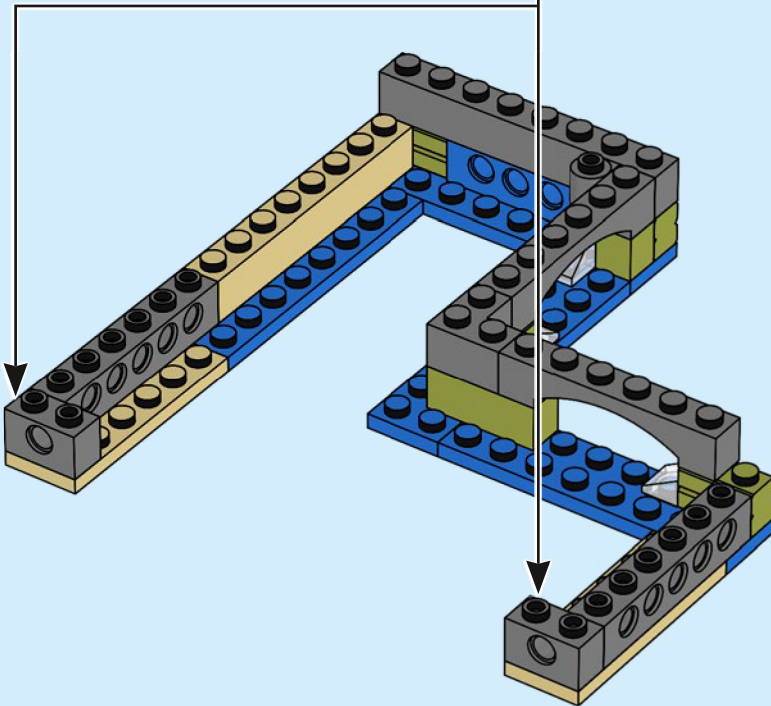
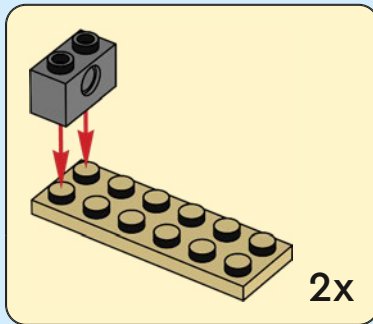

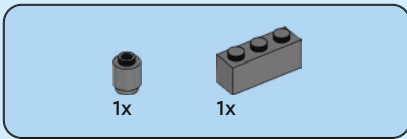

12

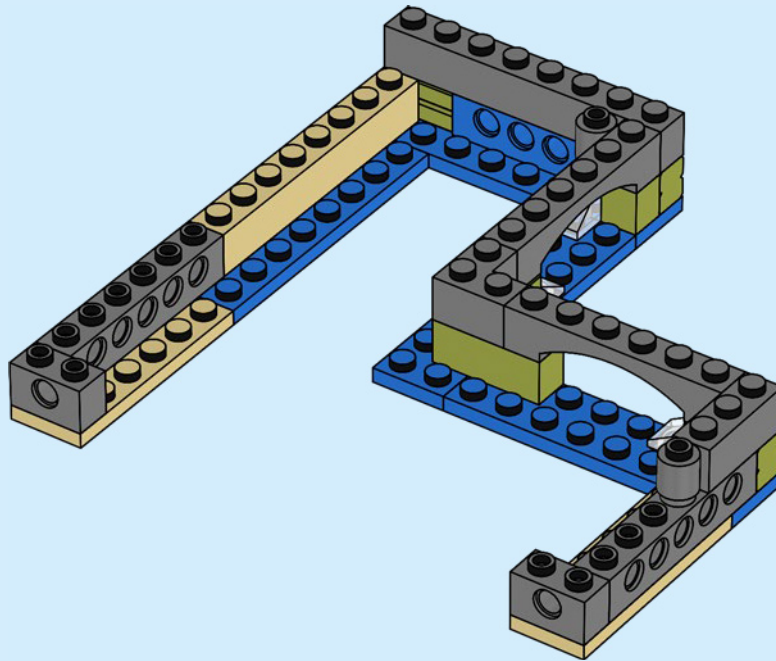

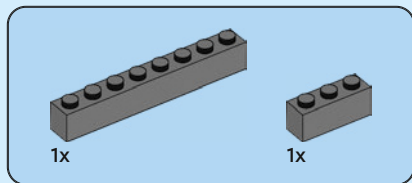

13

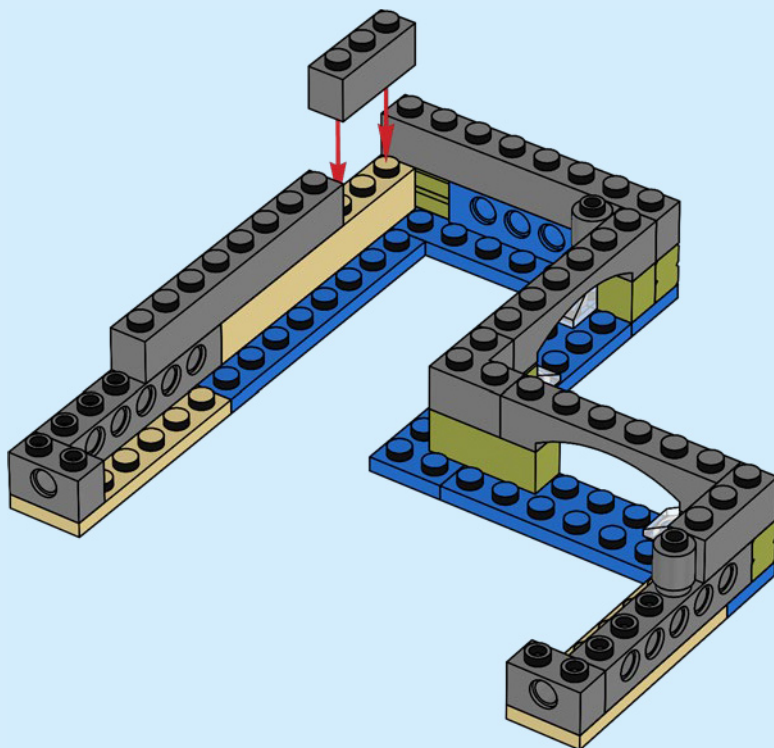

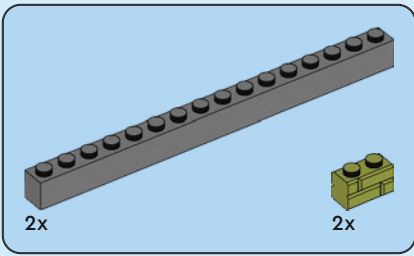

14

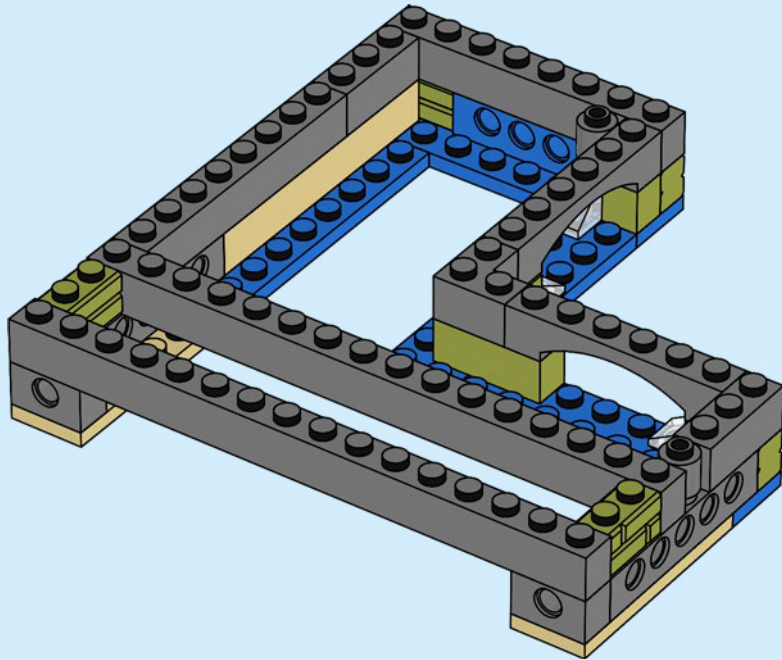

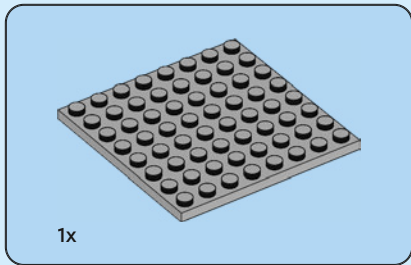

15

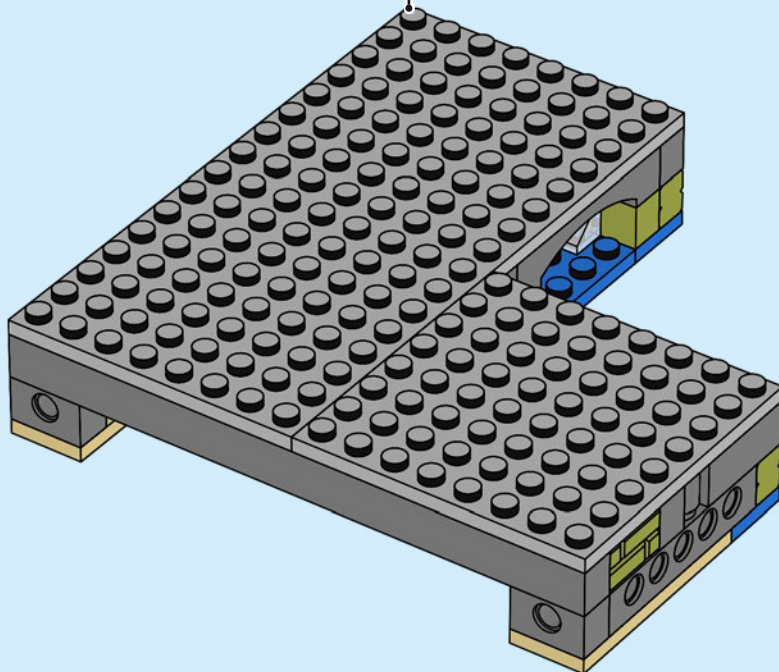
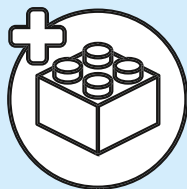



2x

16

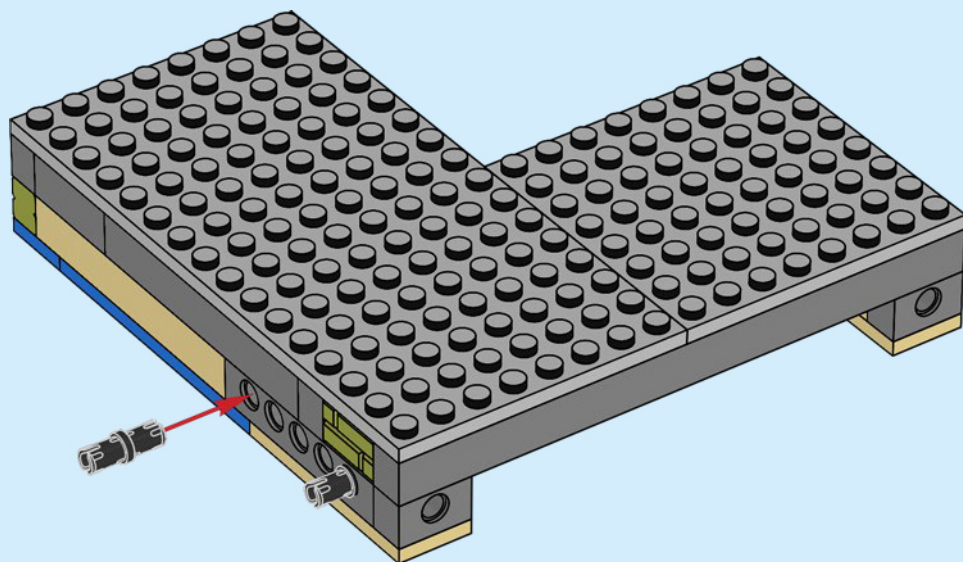

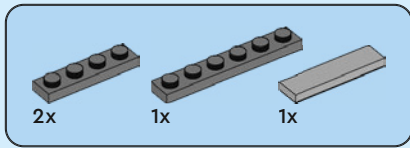

17

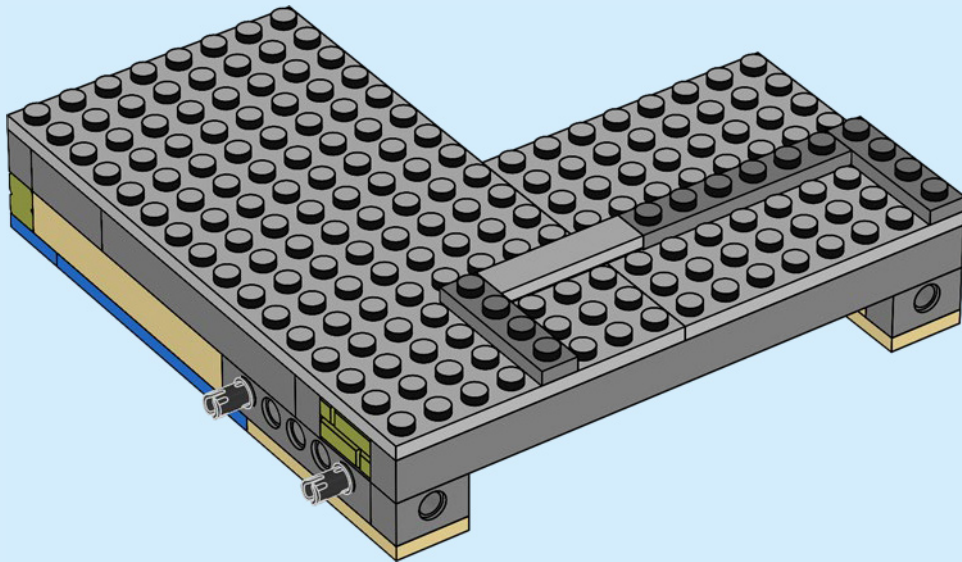

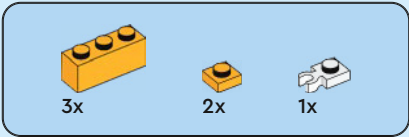

18

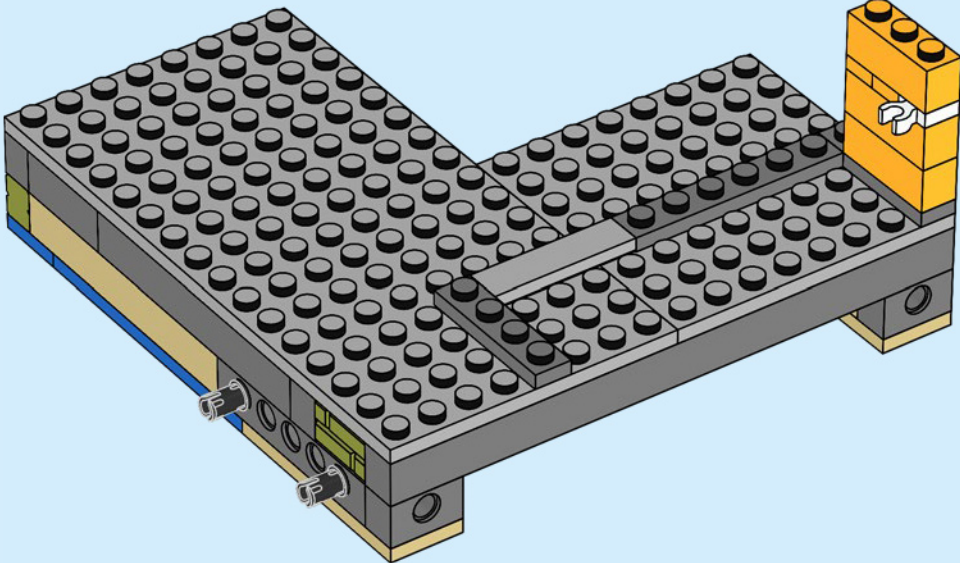
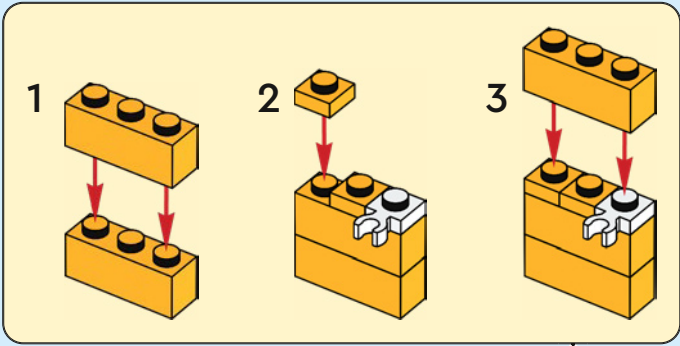

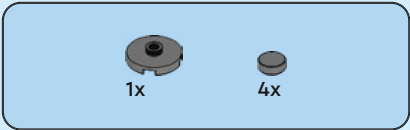

19

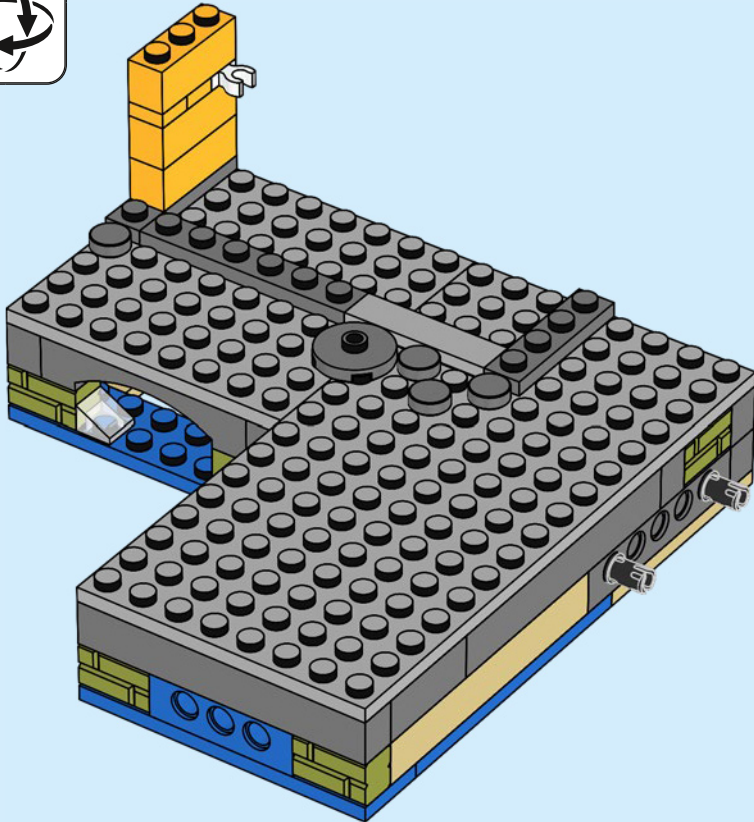
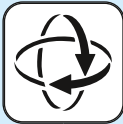

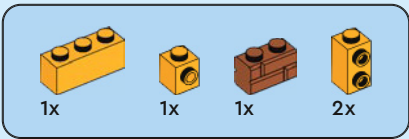

20

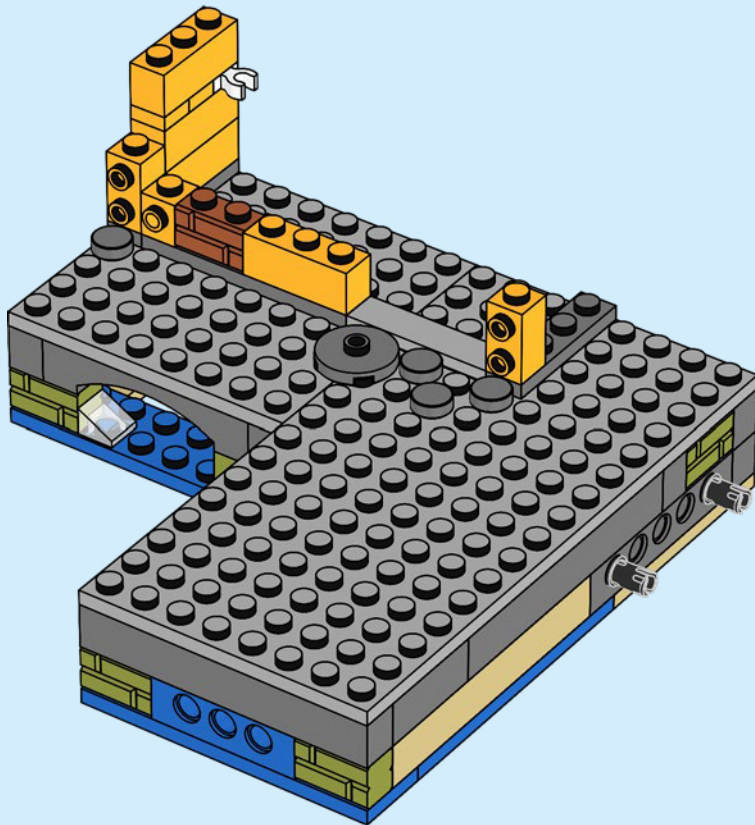

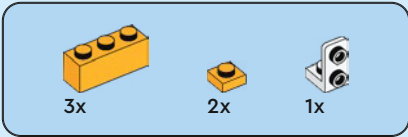

21

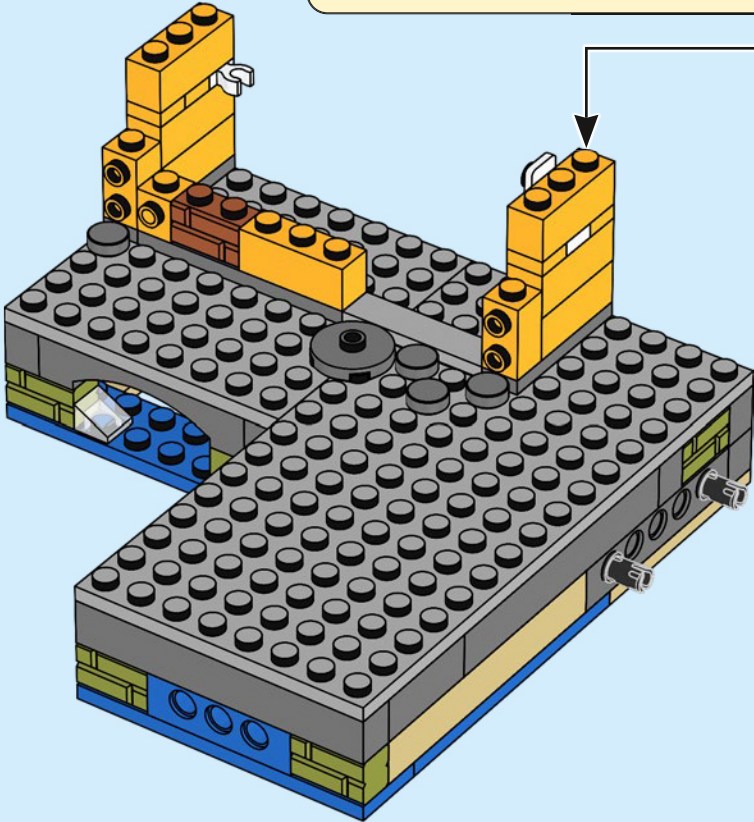
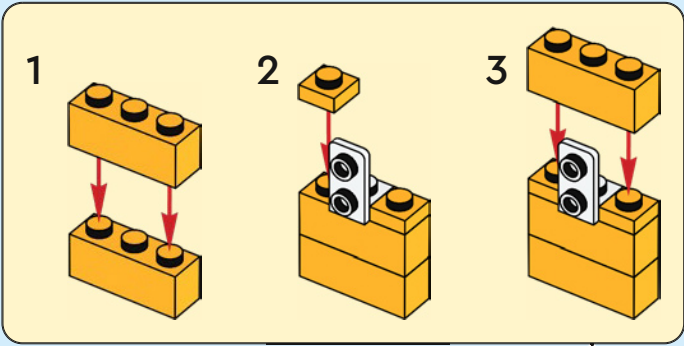

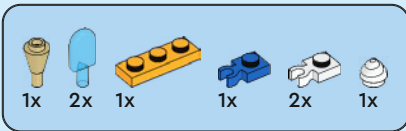

22

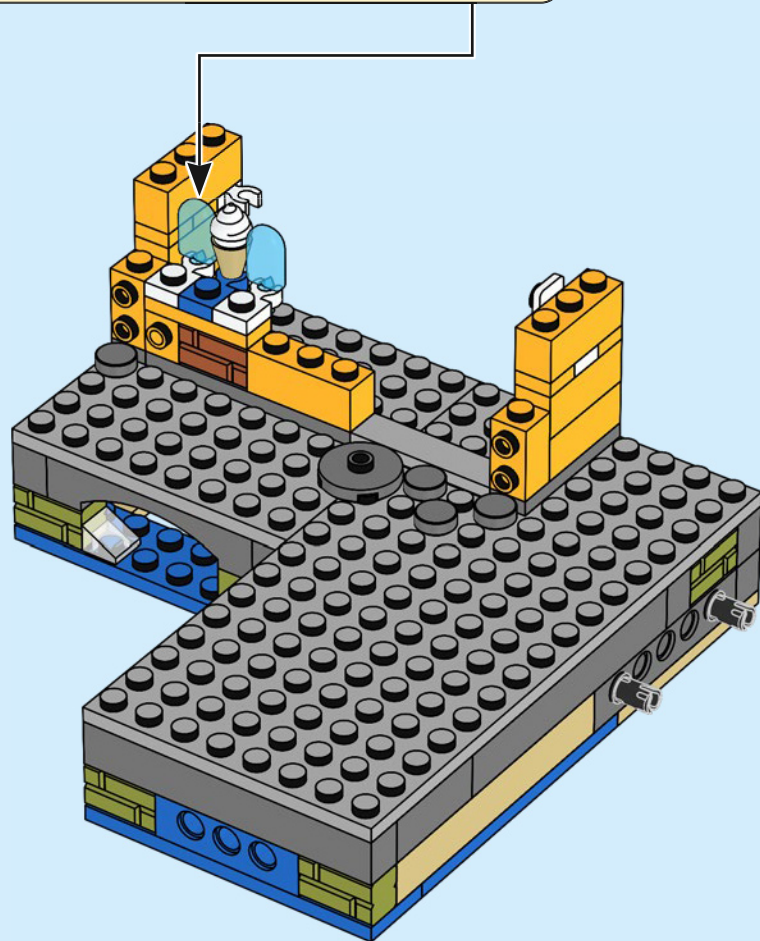

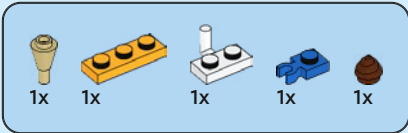

23

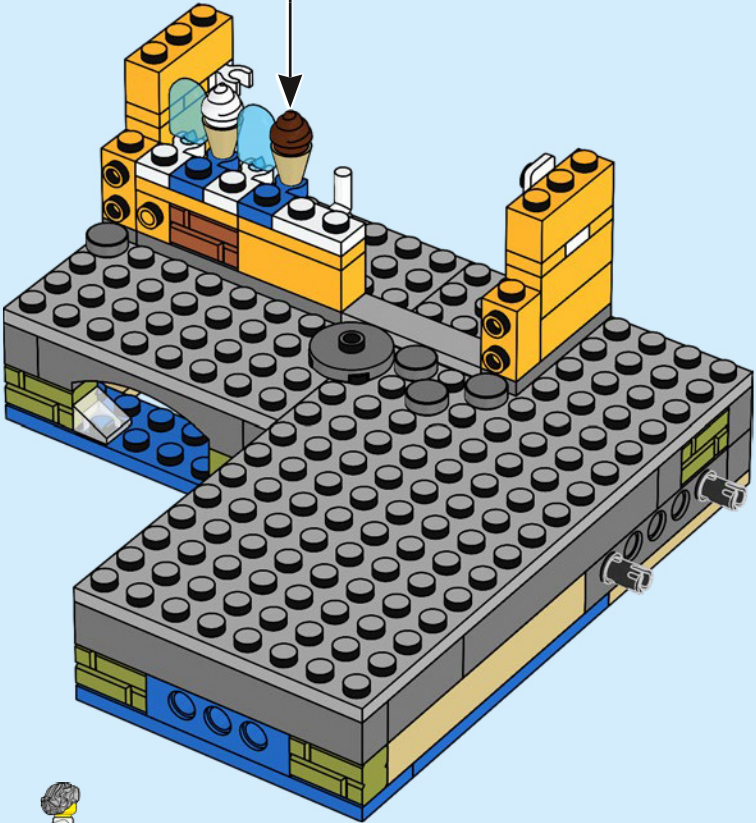
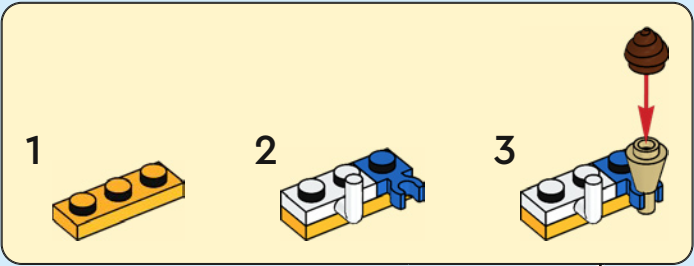



1x



1x

24

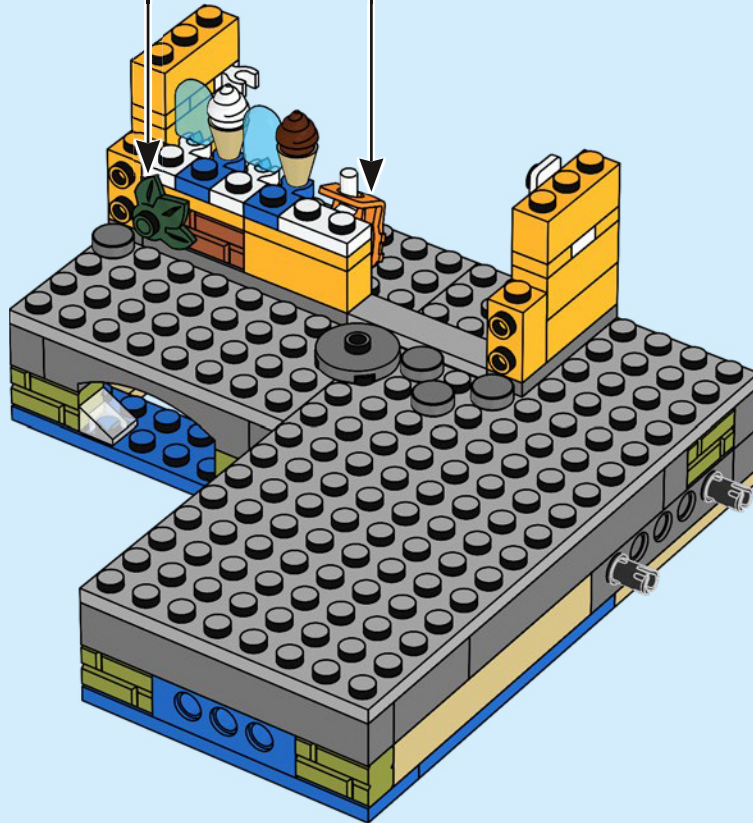



2x



4x

25



4x

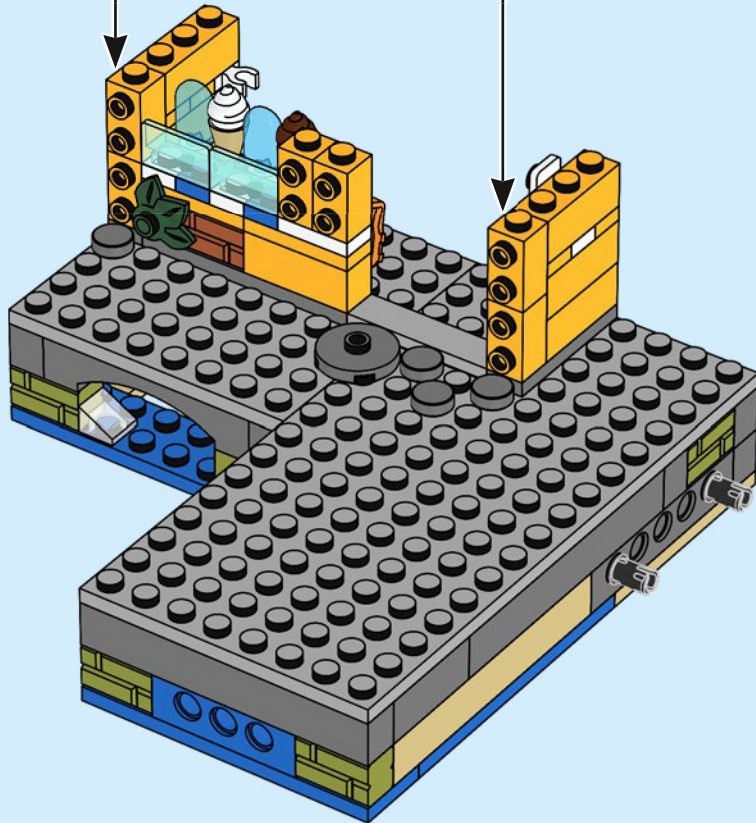

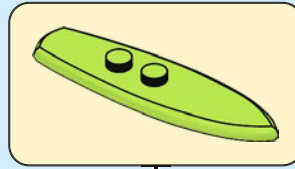
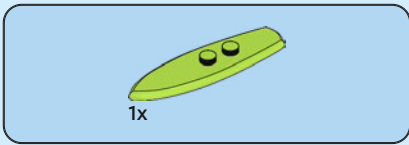

26

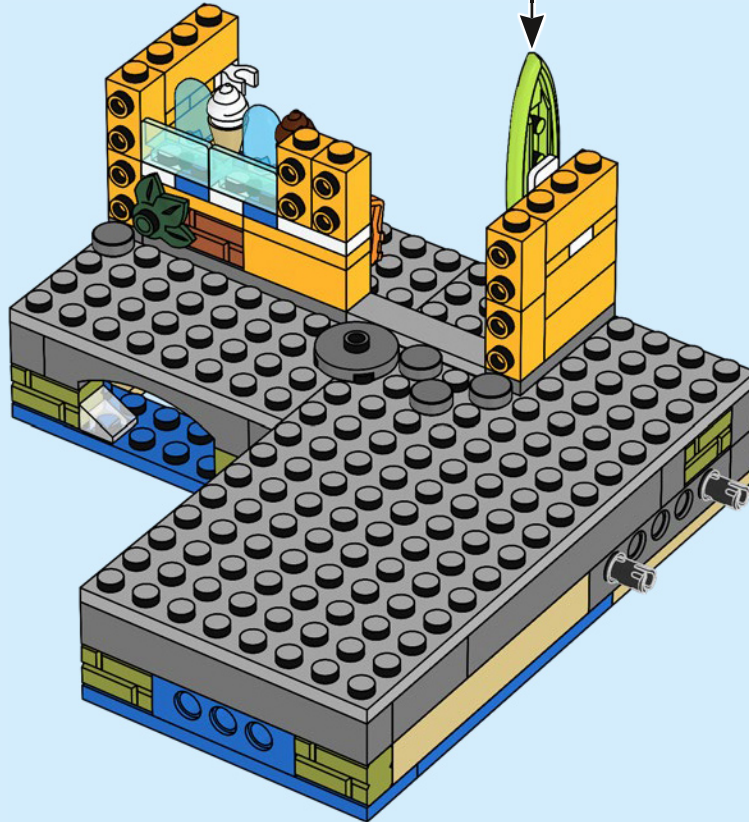

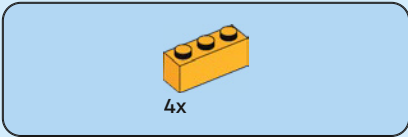

27

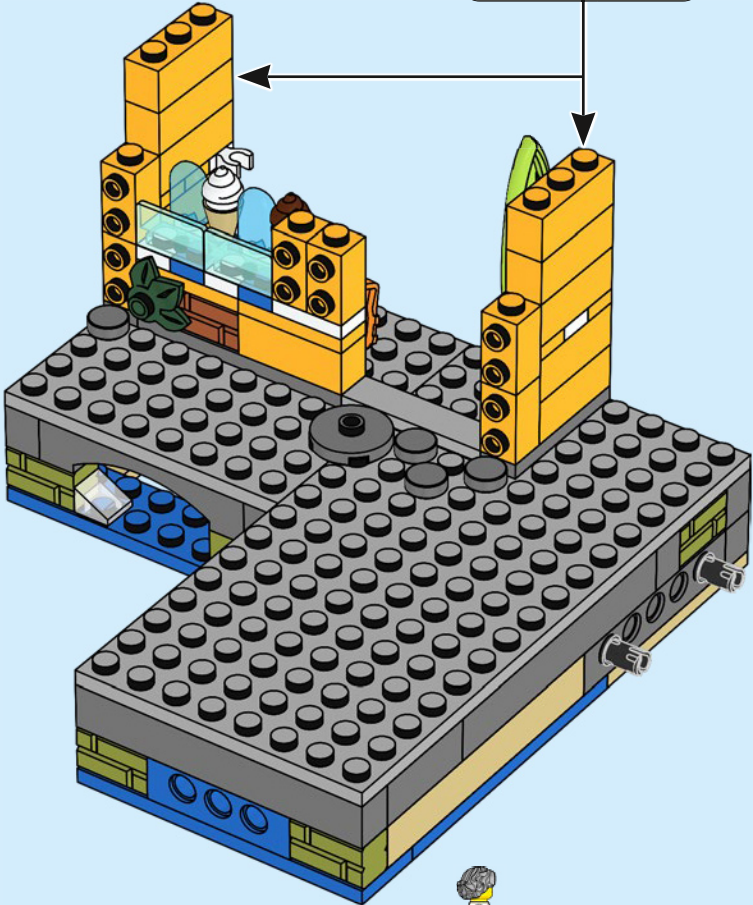
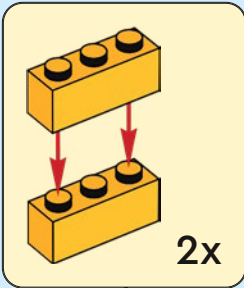

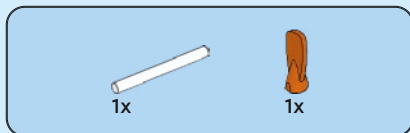

28

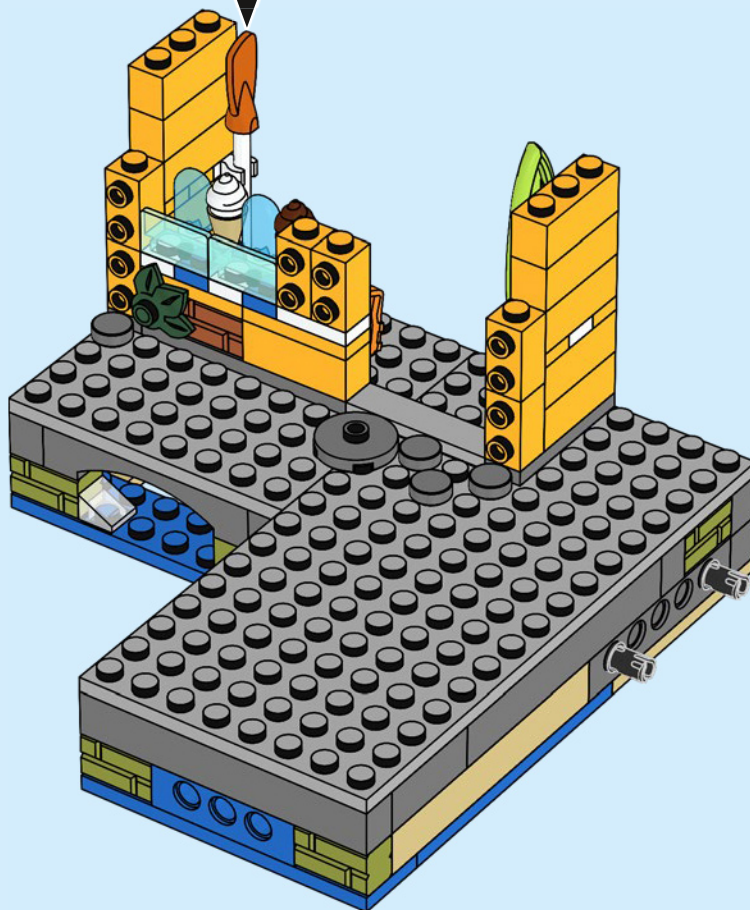
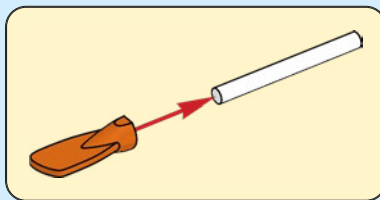

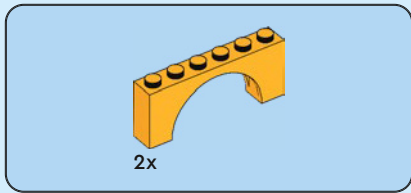

29

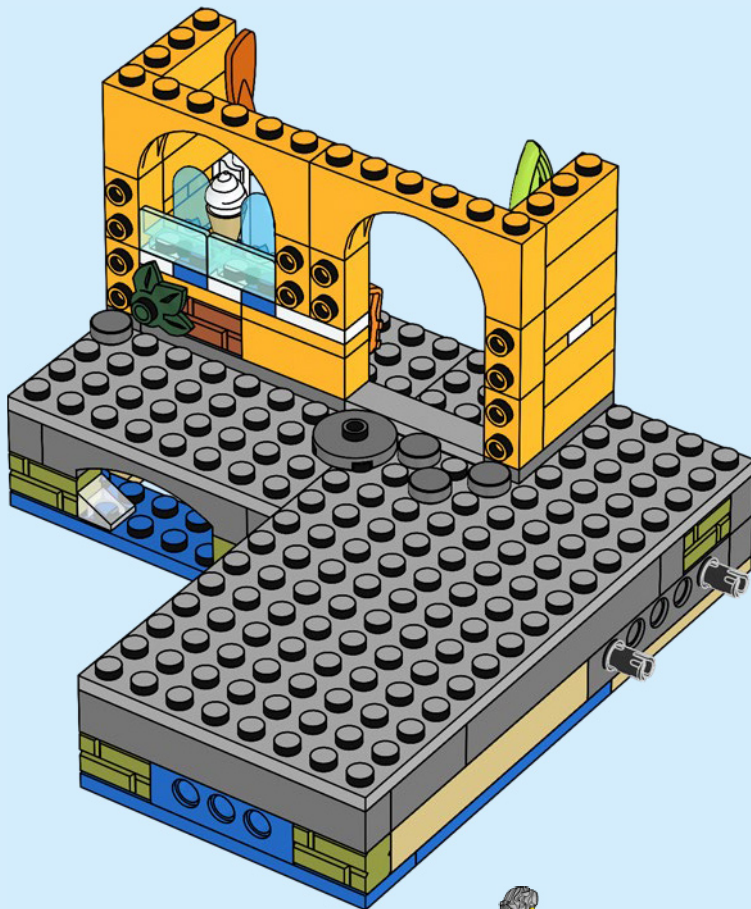

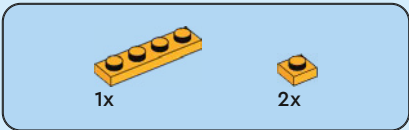

30

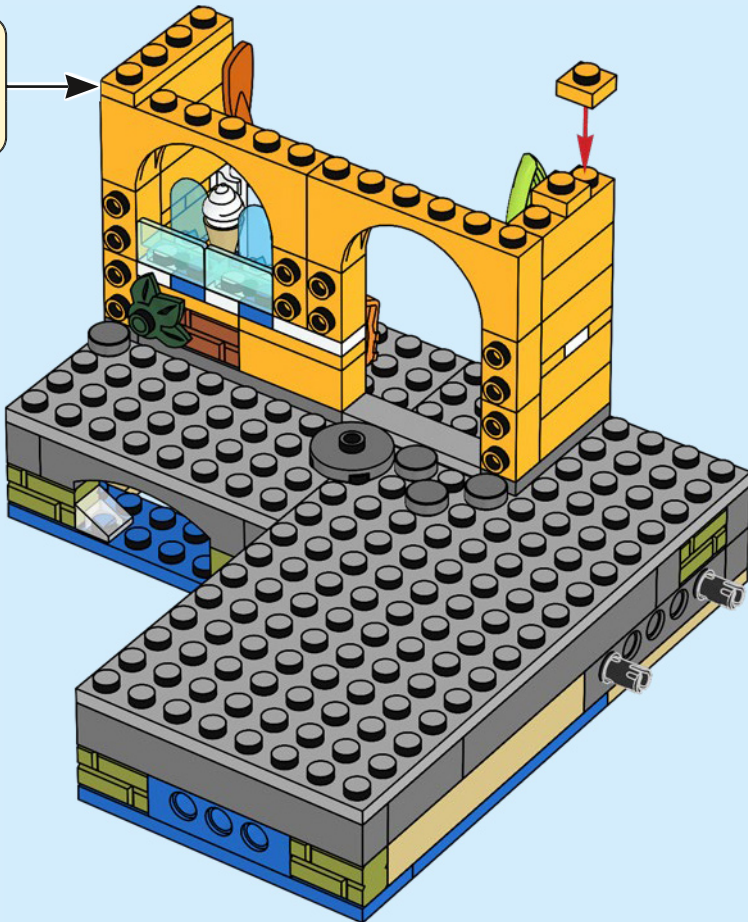
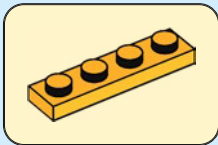

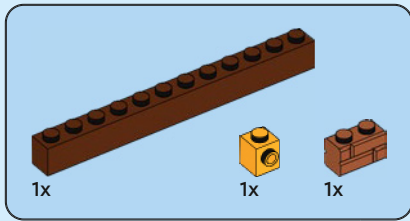

31

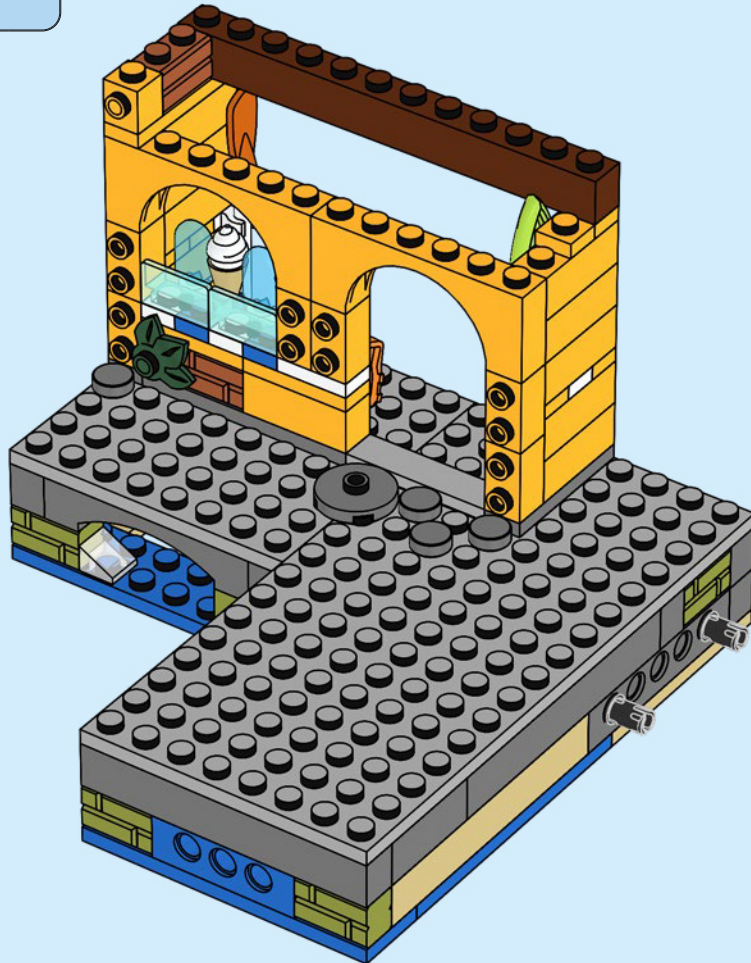

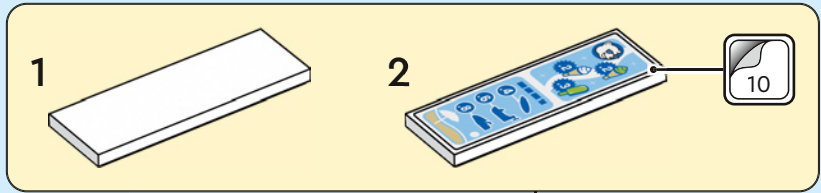
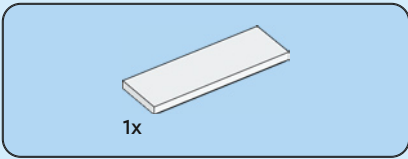

32

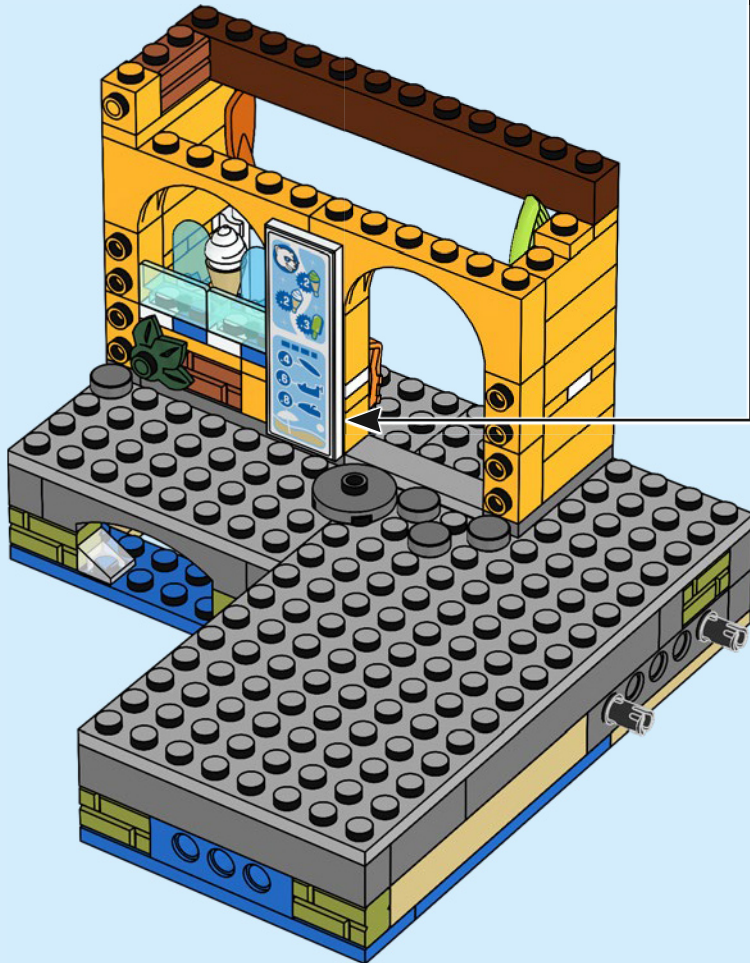

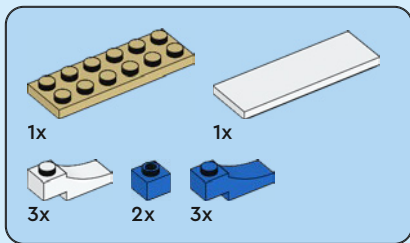

33

1

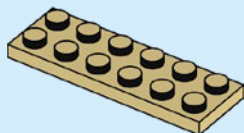

2

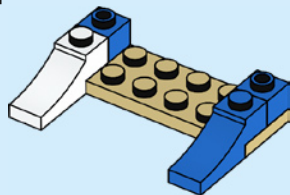

3

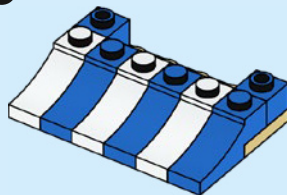

4

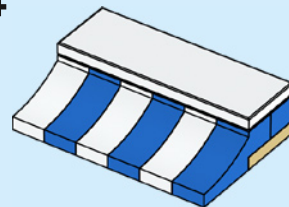

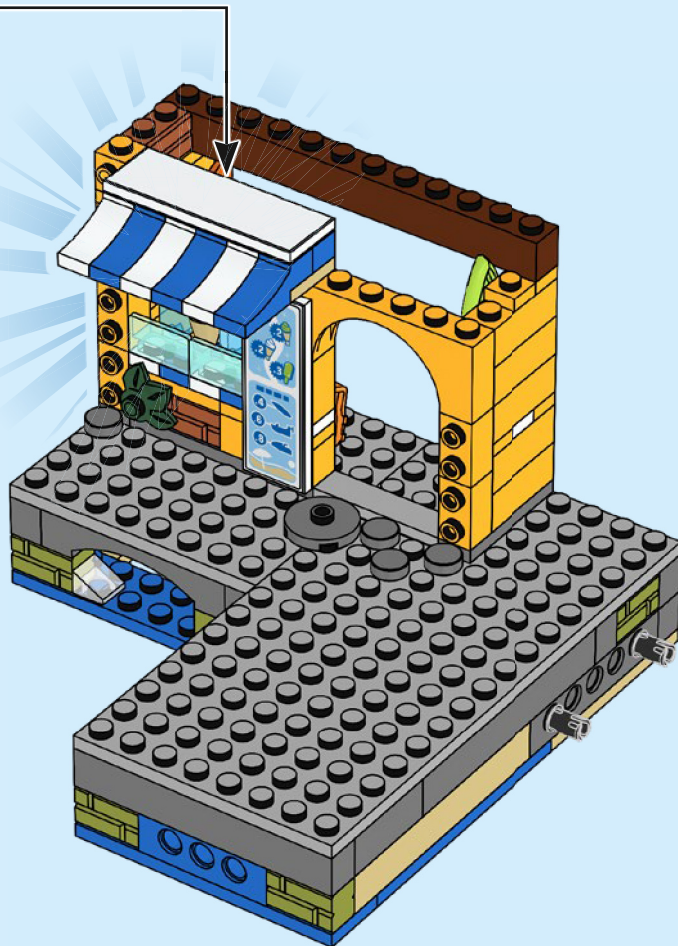

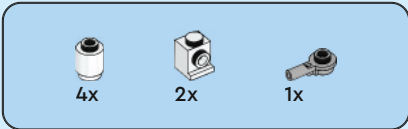

34

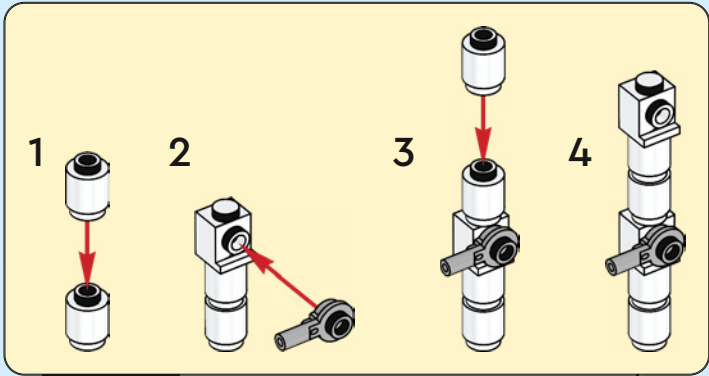

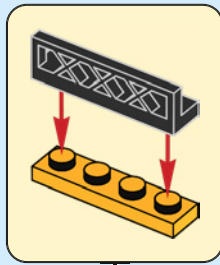
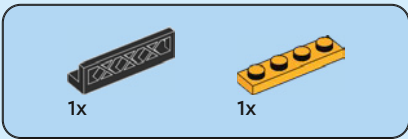

35

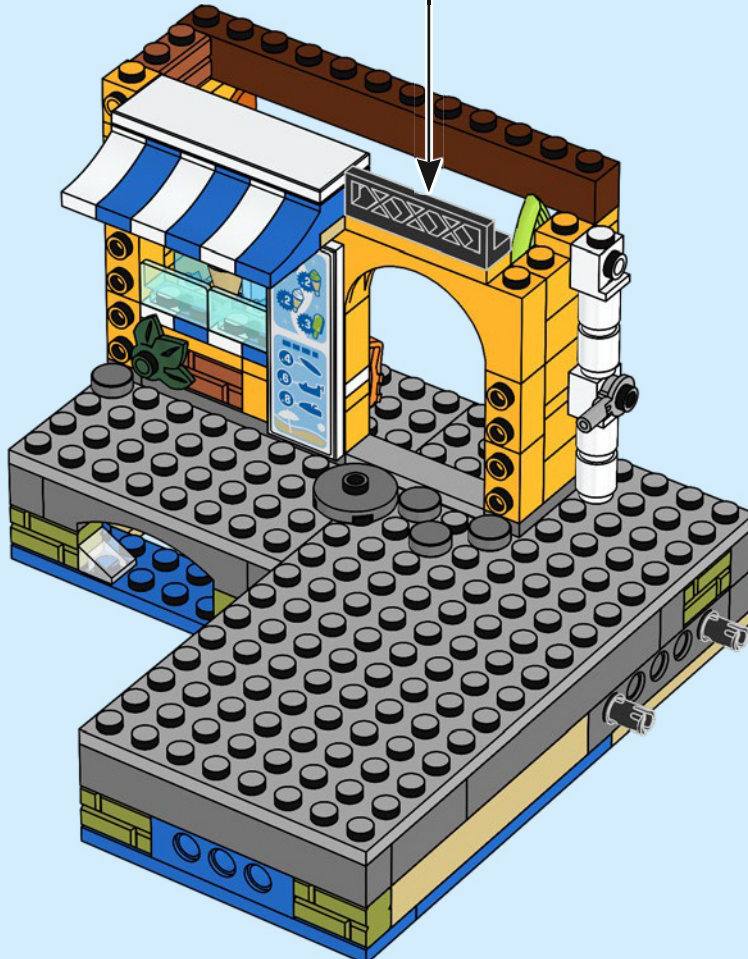

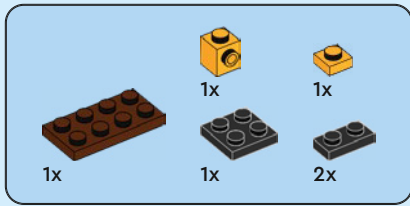

36

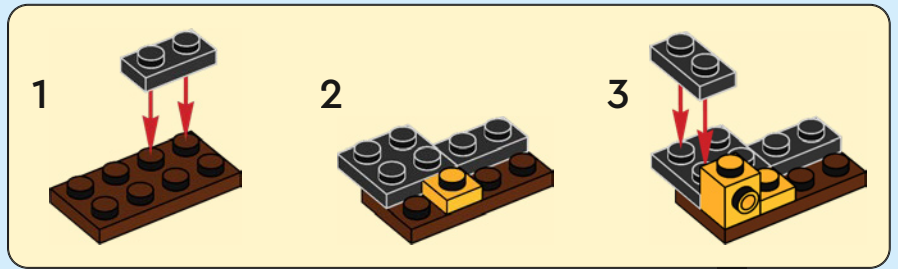



1x



1x



1x

37



1

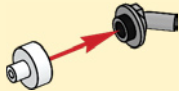

2

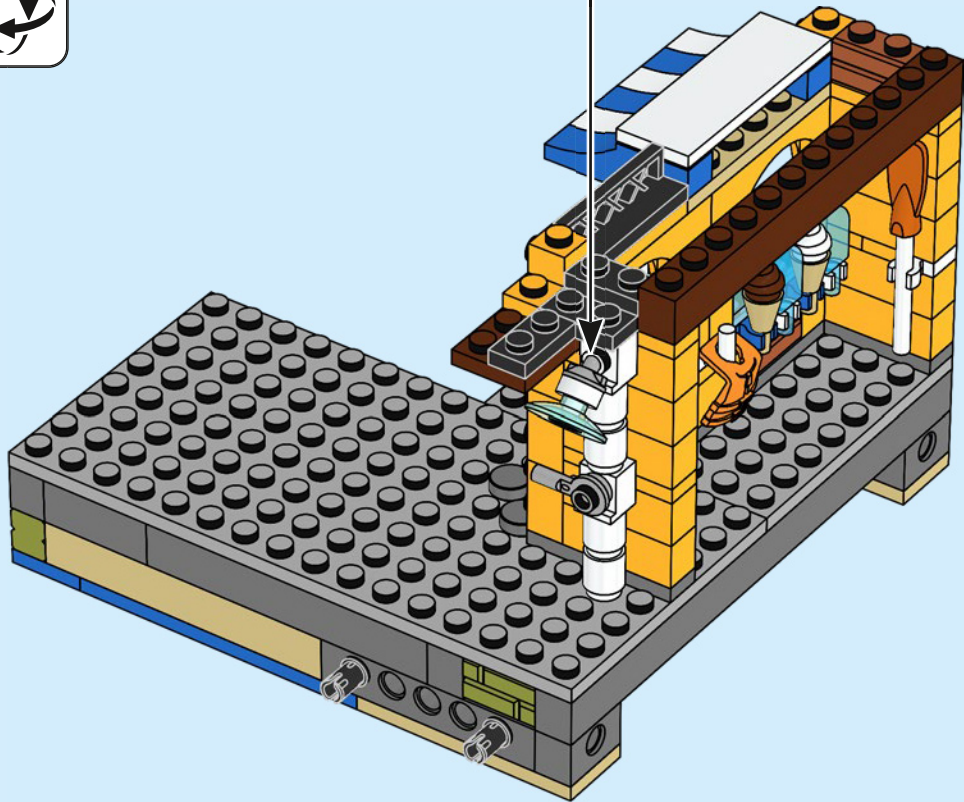



1x

38

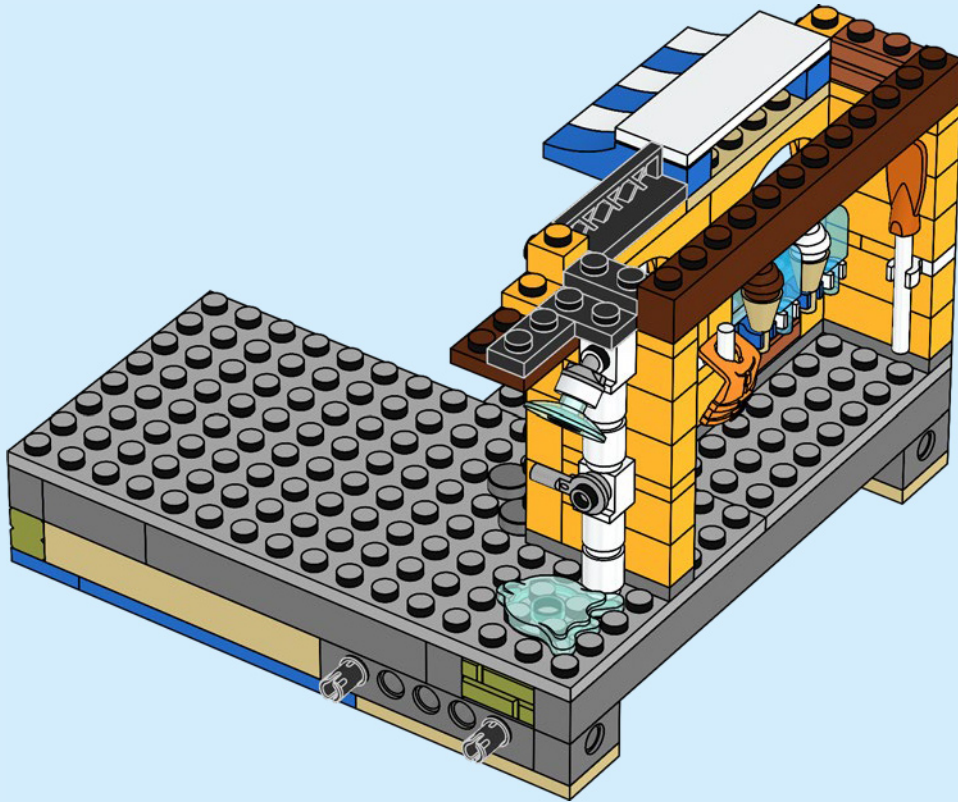

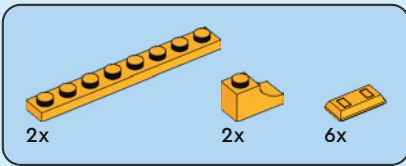

39

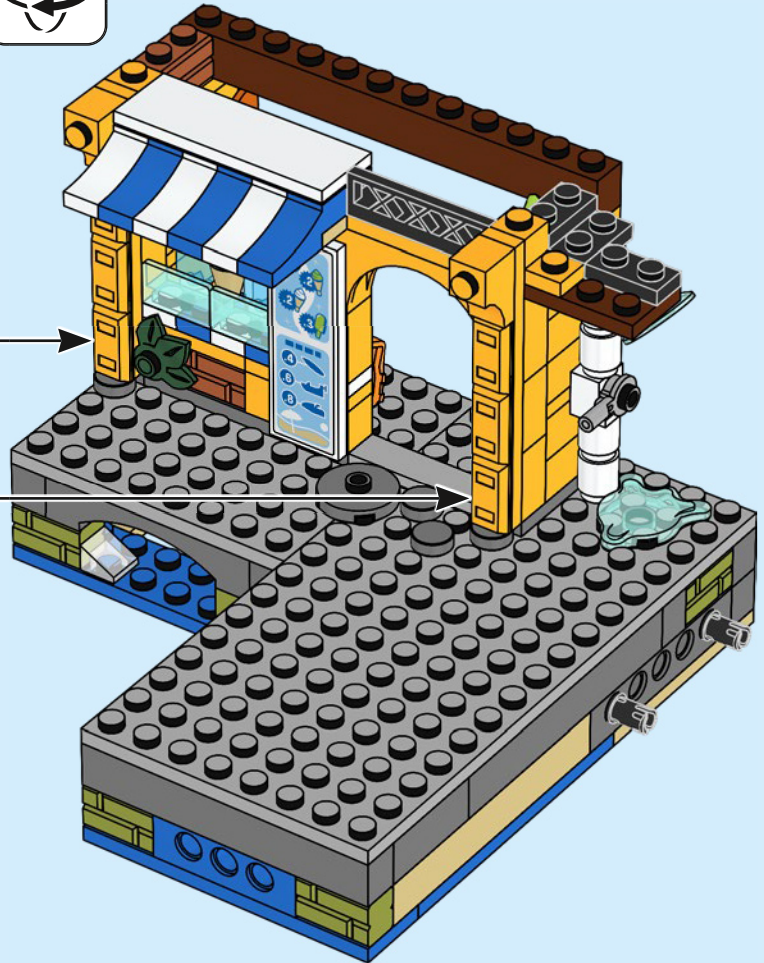
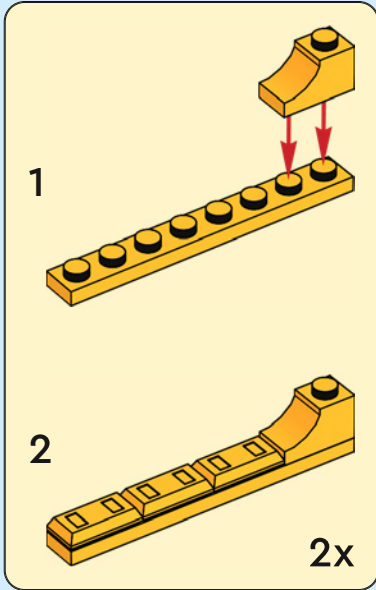

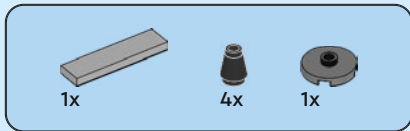

40

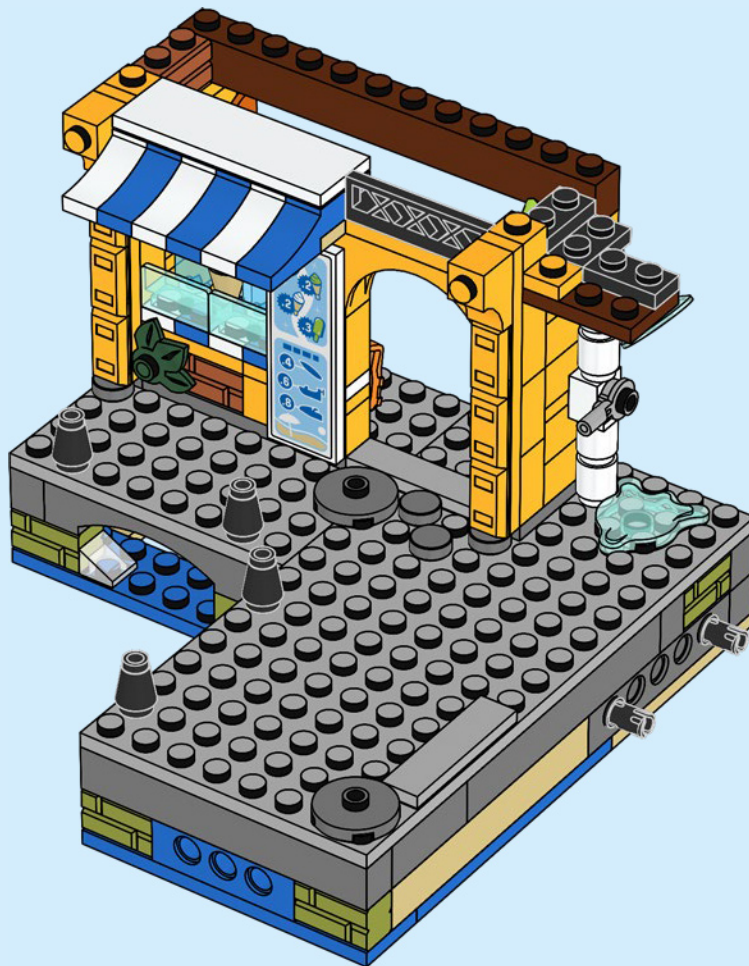



41

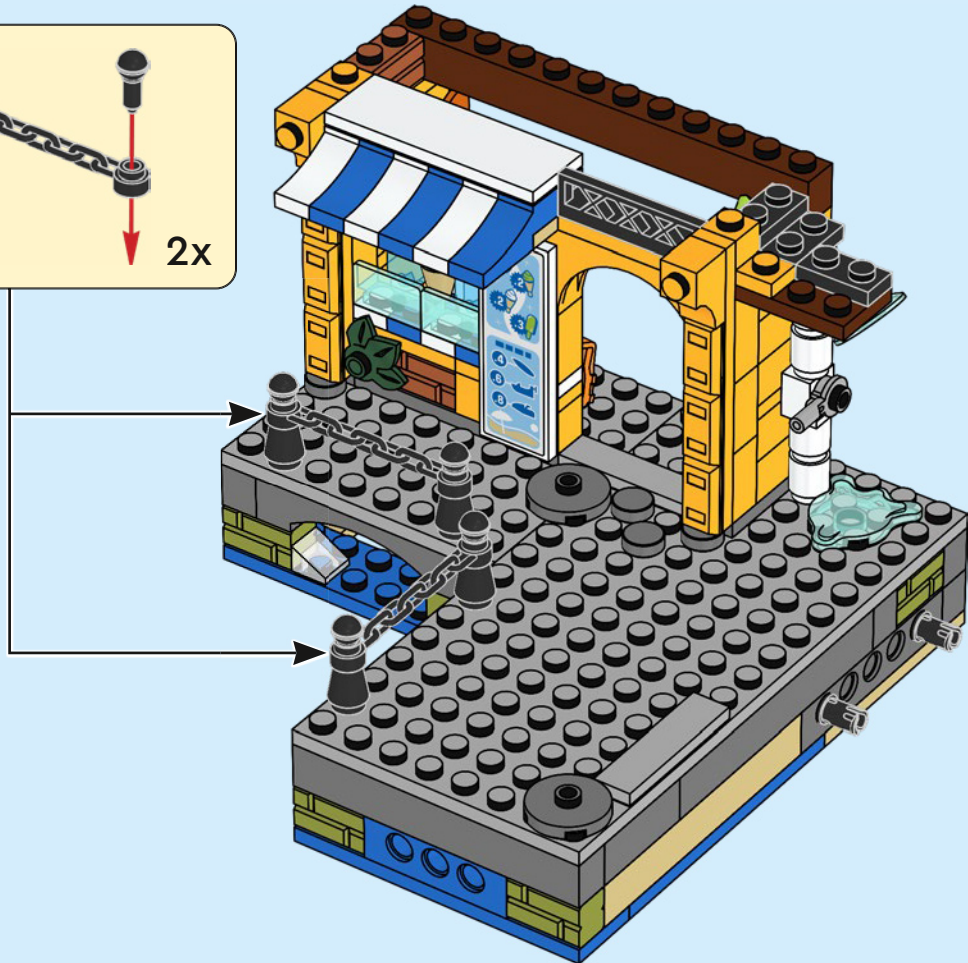
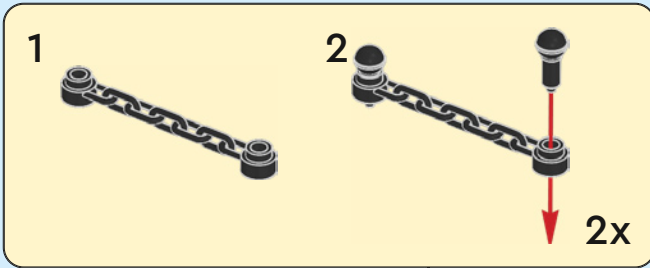

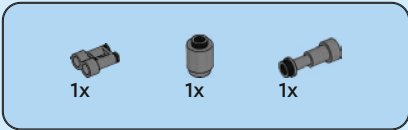

42

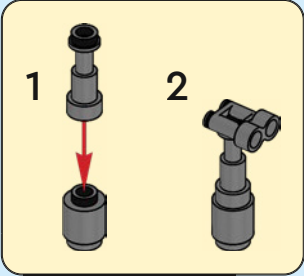
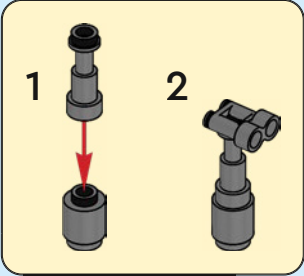
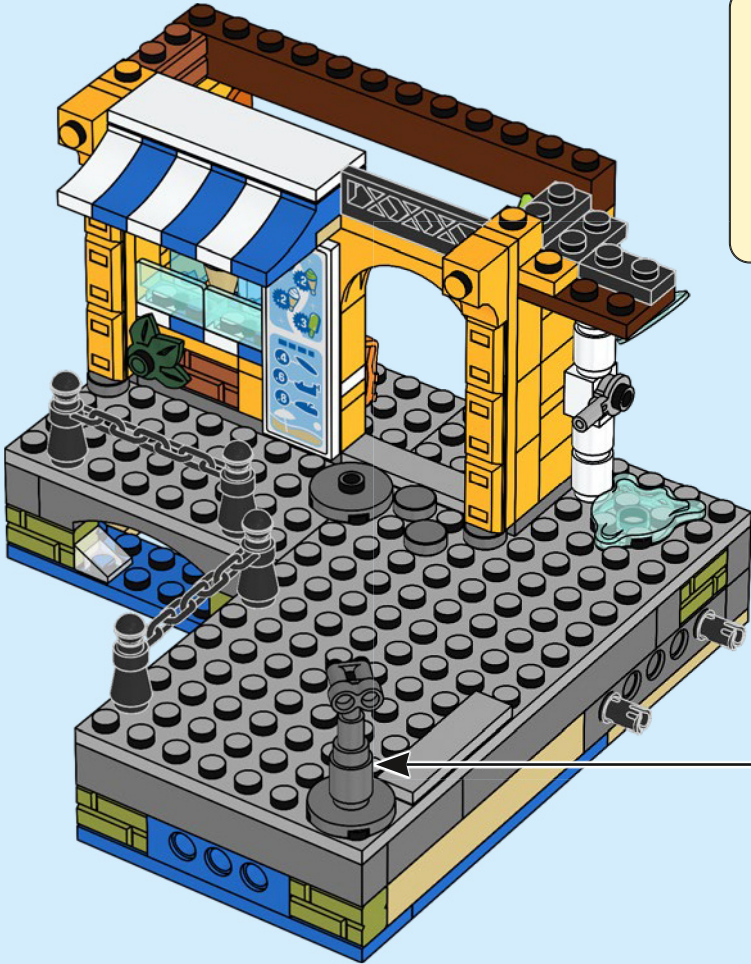

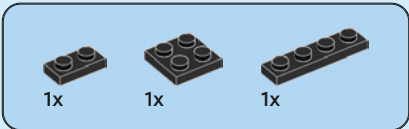

43

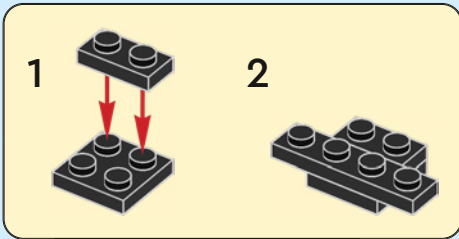
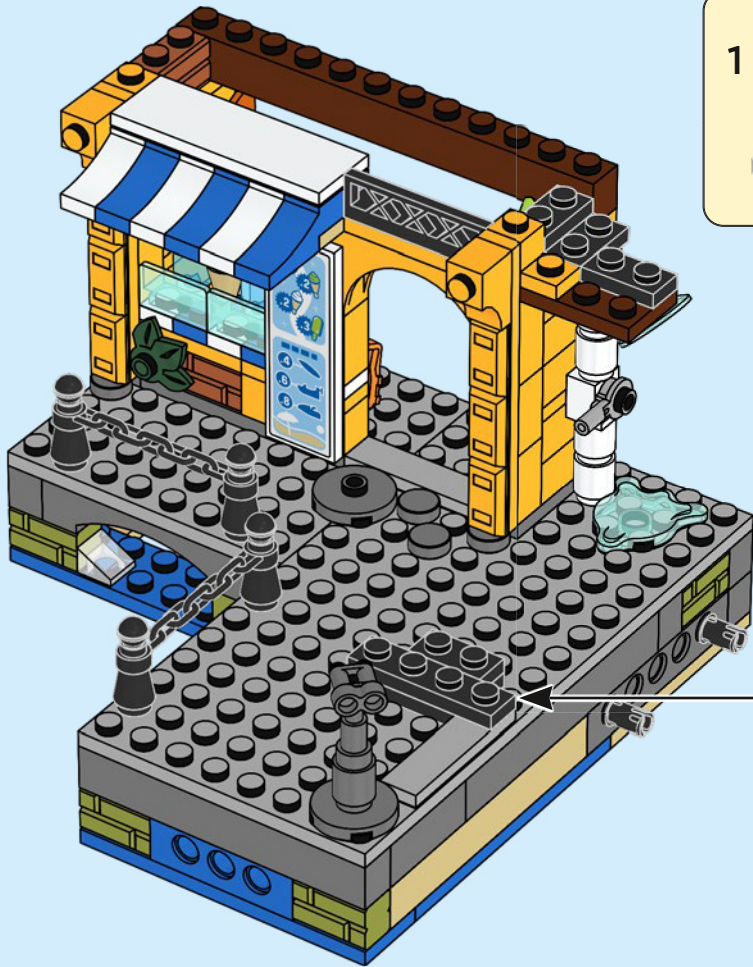

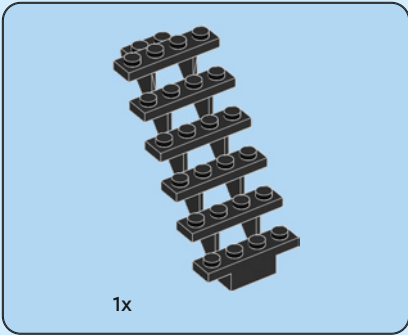

44

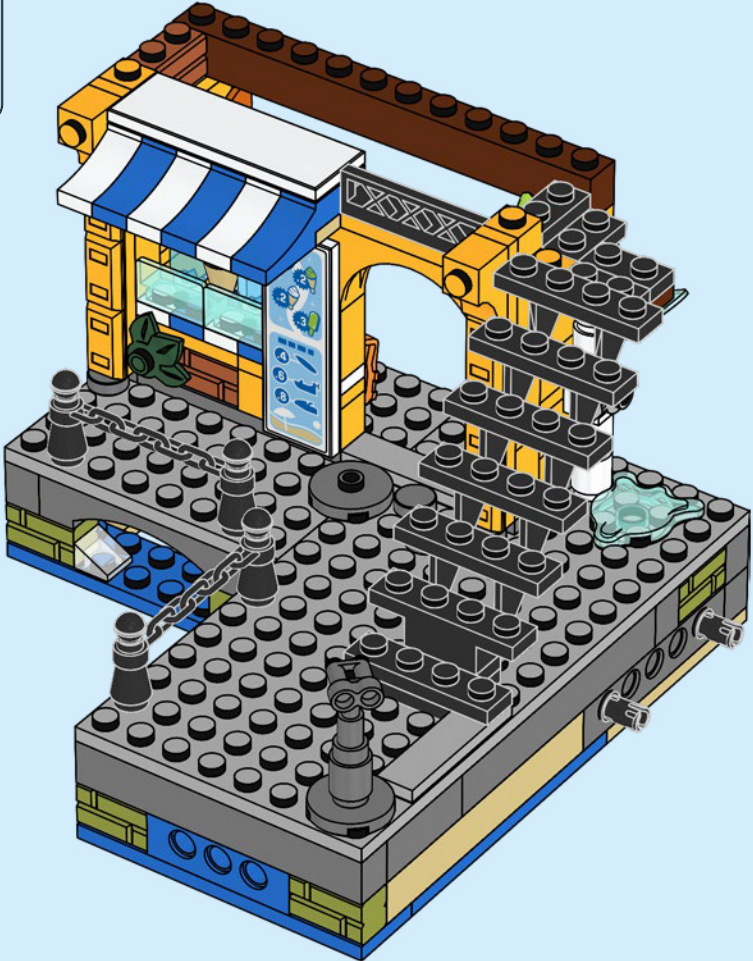



1x

45

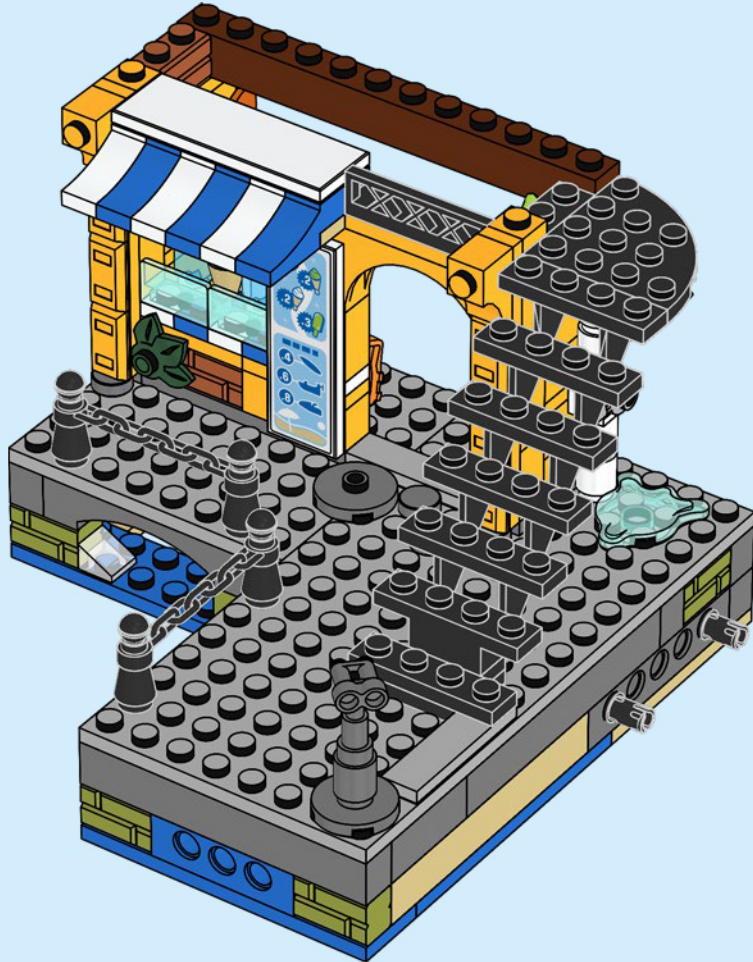



1x



1x

46

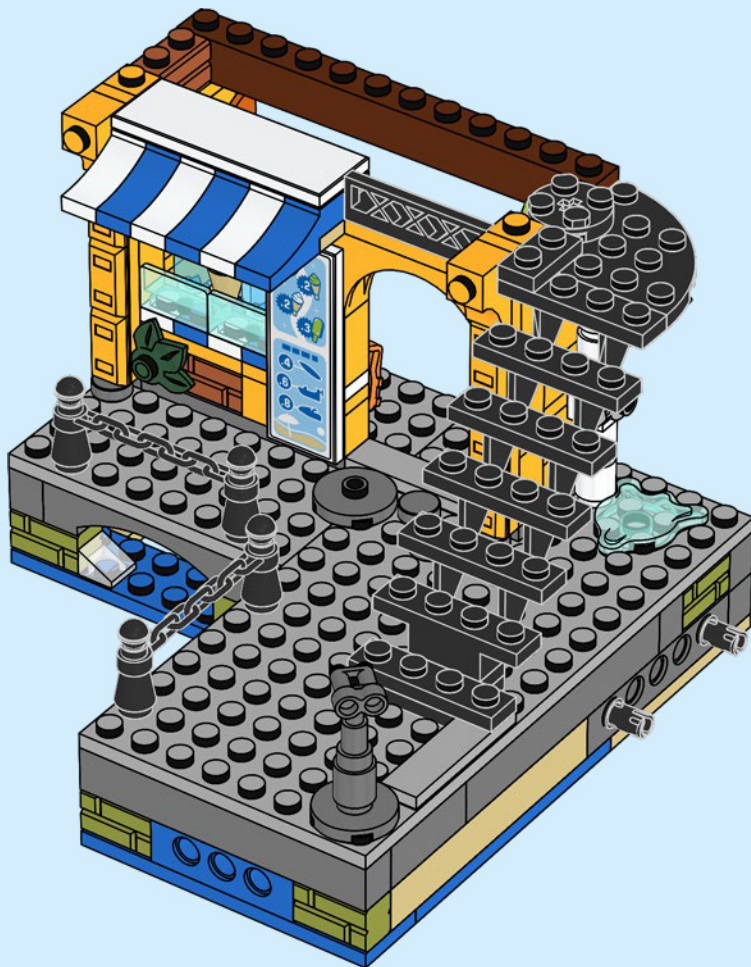

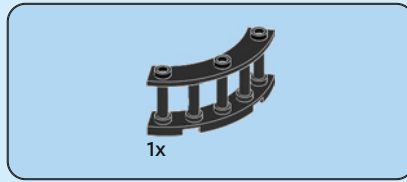

47

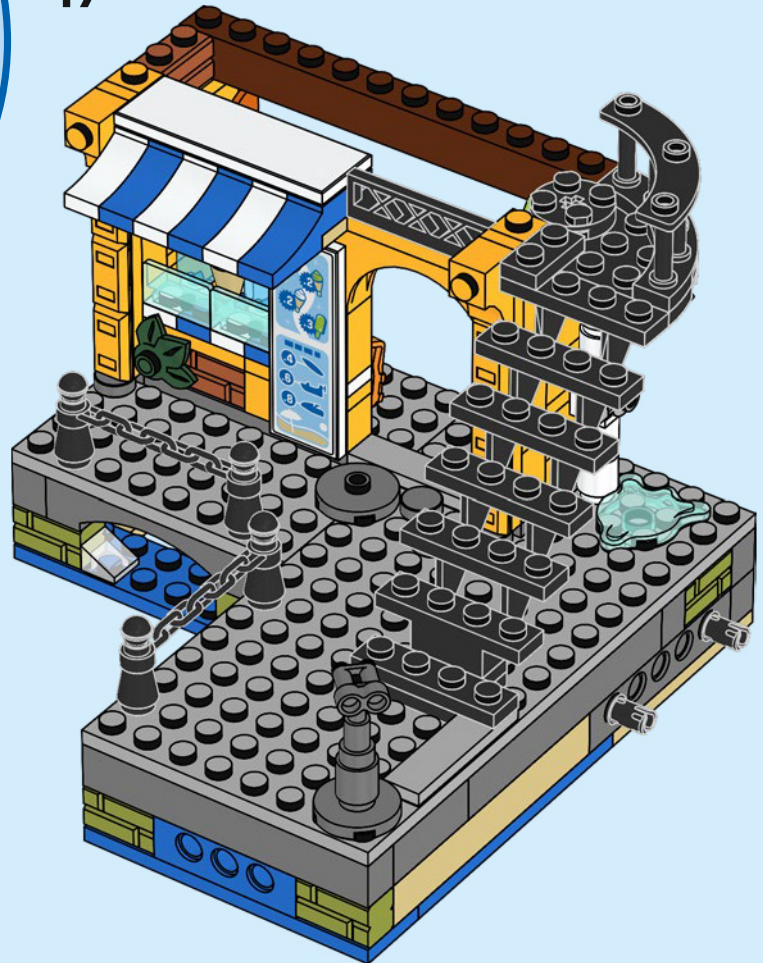



1x

48

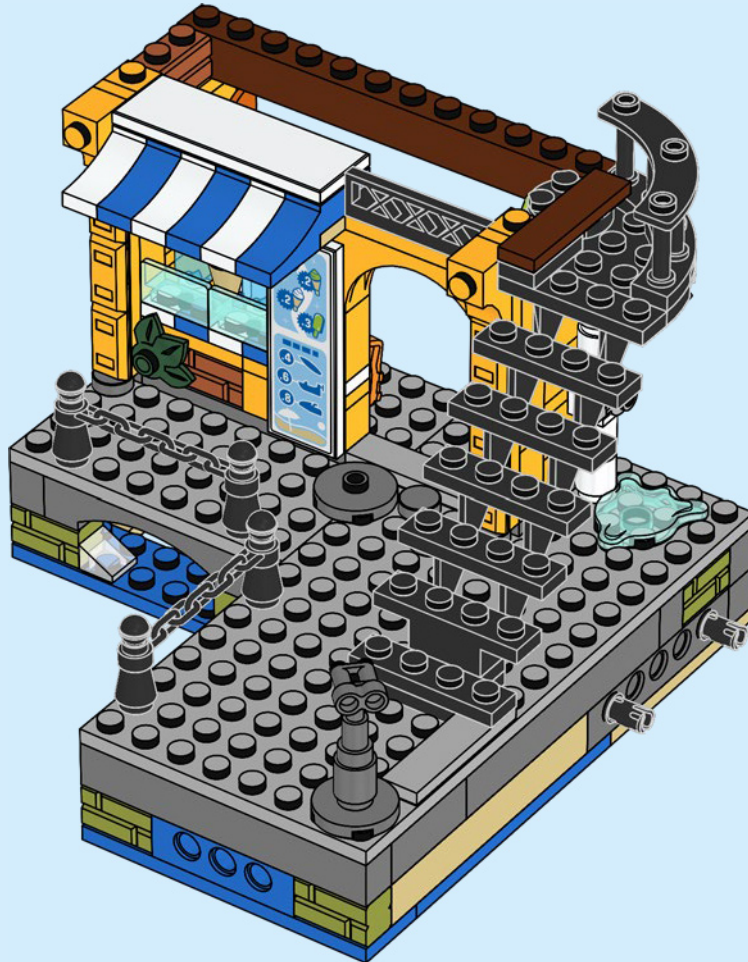

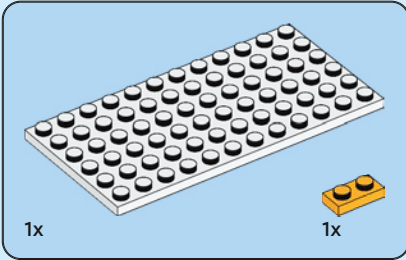
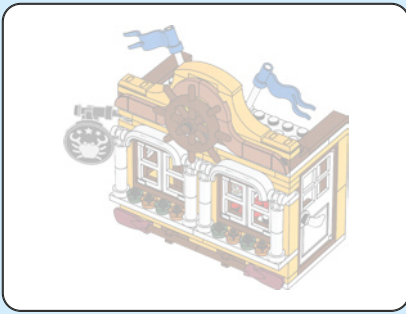

49

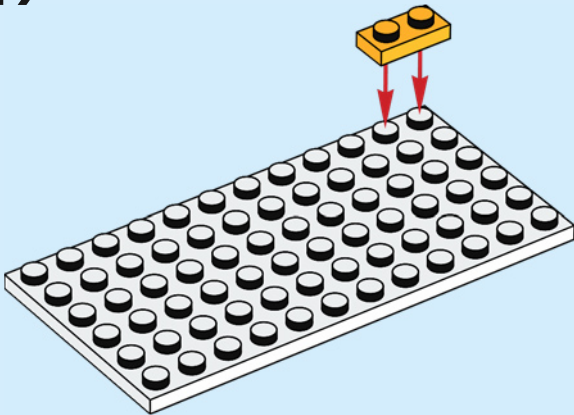

50

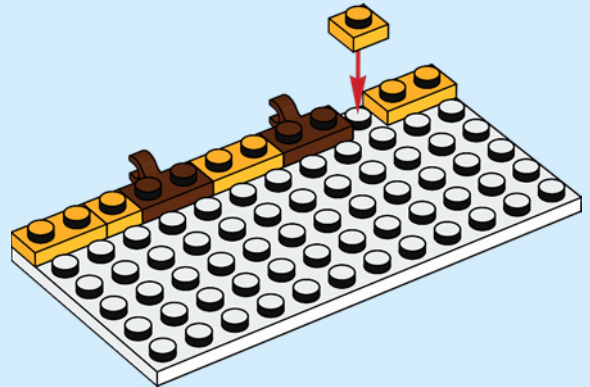

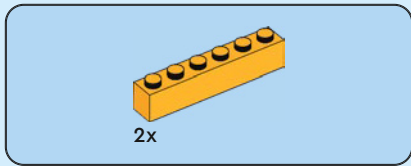

51

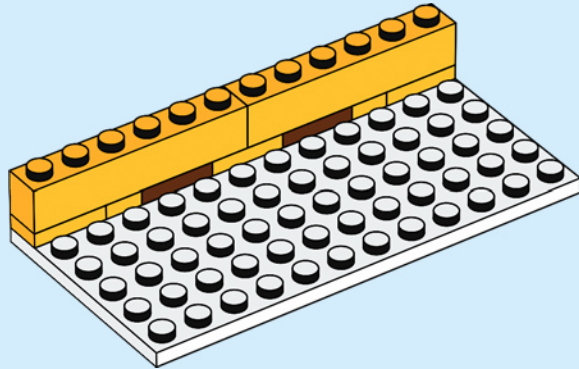

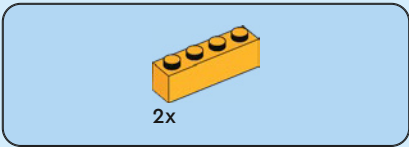

52

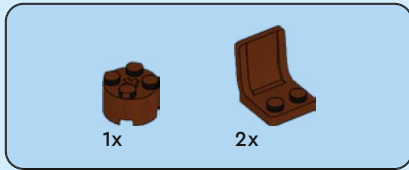
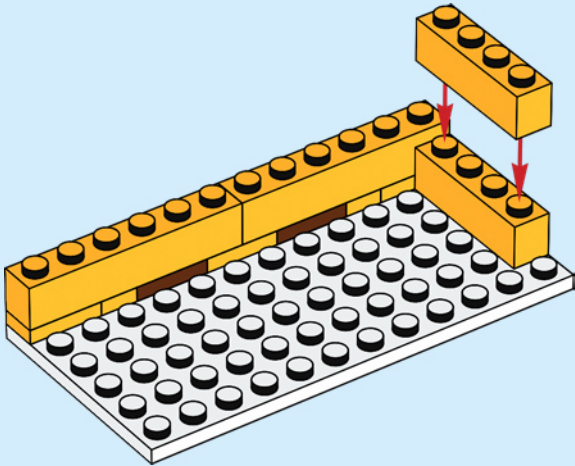

53

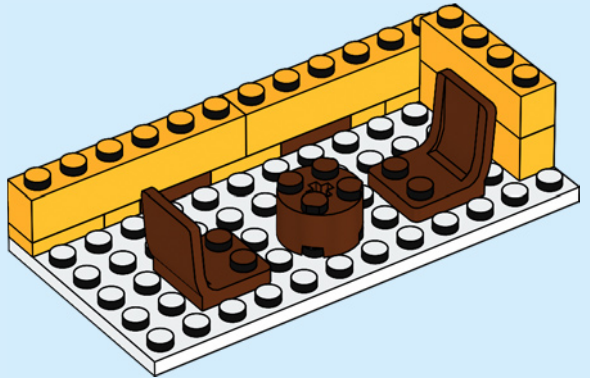

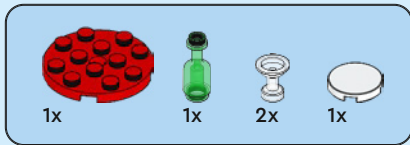

54

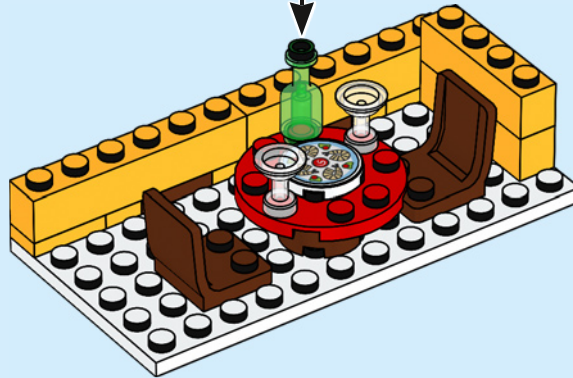
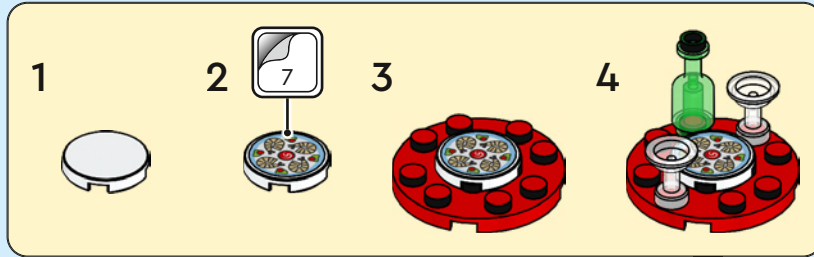



2x



1x



1x

55

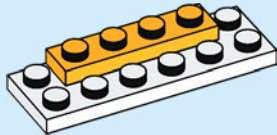

1x



2x

56

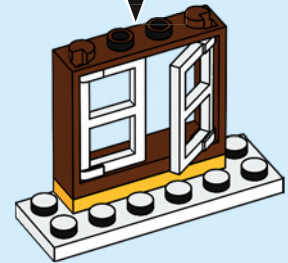
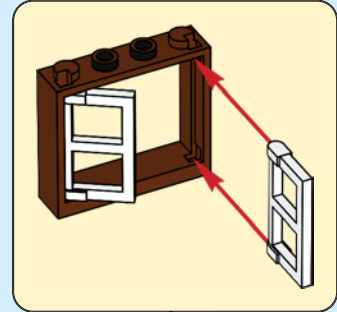

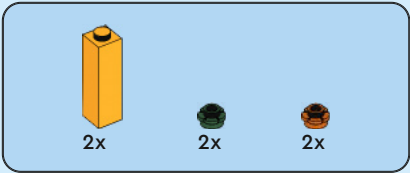

57

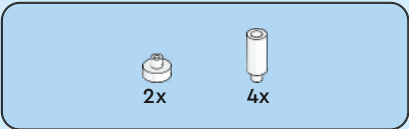
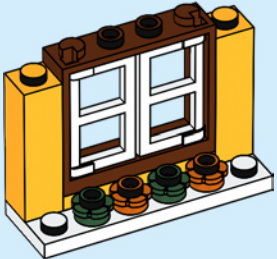

58

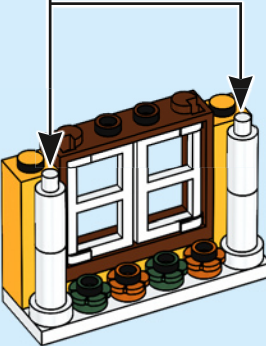
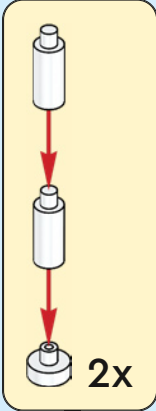



2x

59

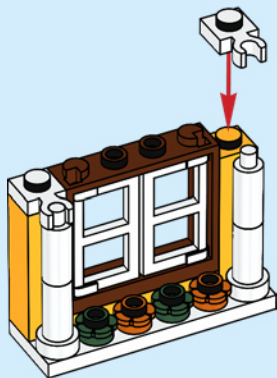

1x



2x

60



2x

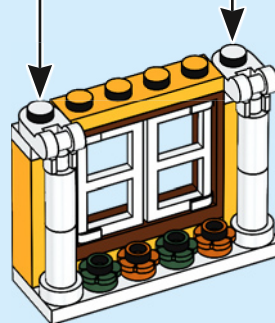

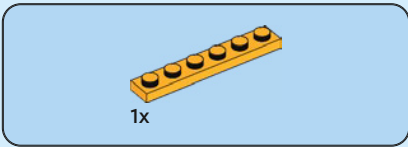

61

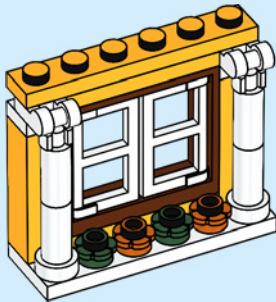

2x

62



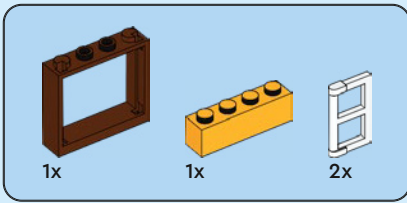

63

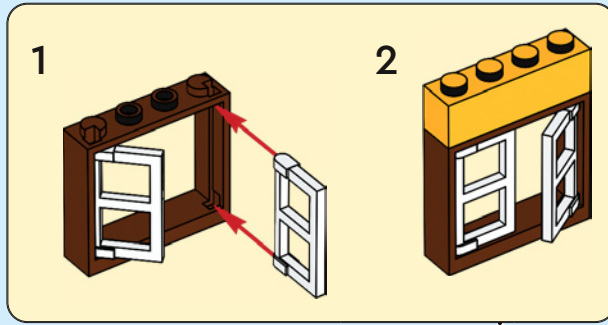

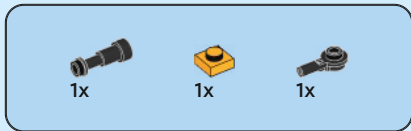

64

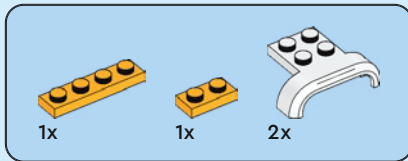
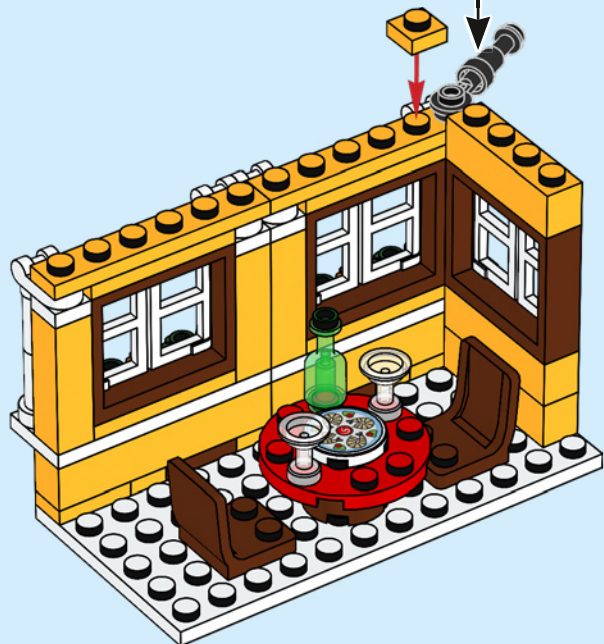
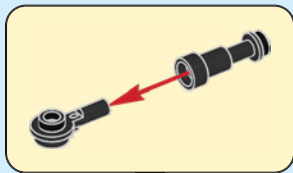

65



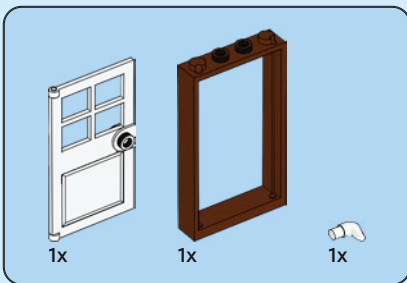

66

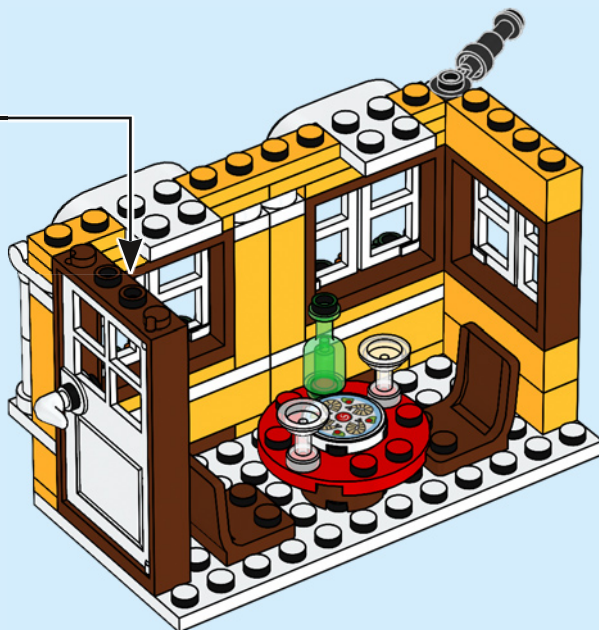
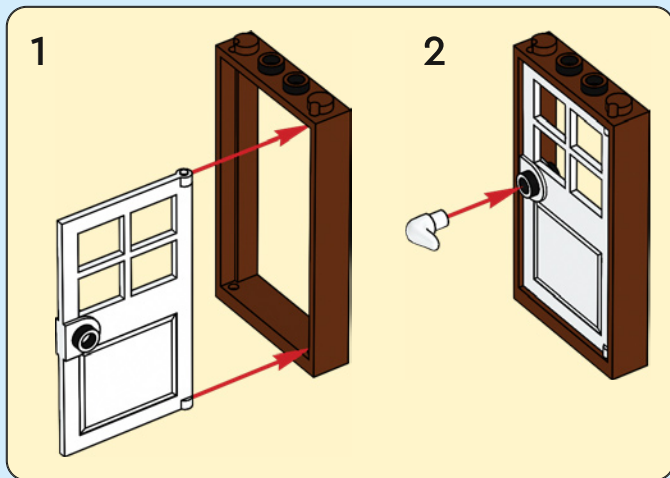

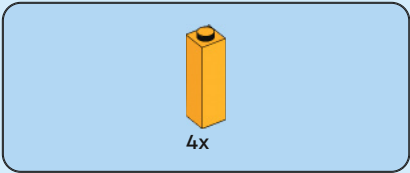

67

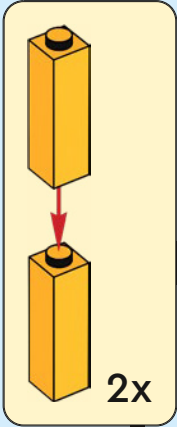

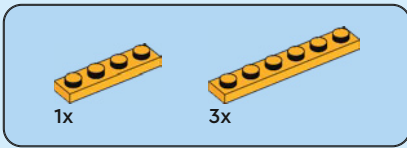

68

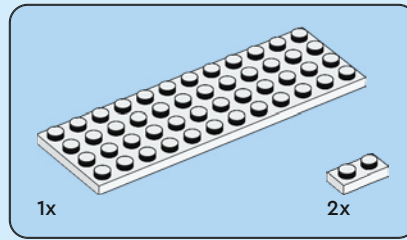

69





2x

70

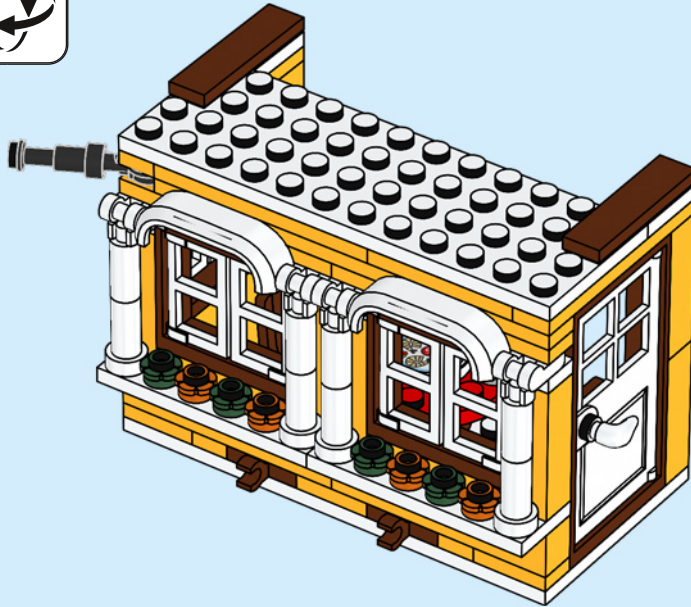



2x



4x

71

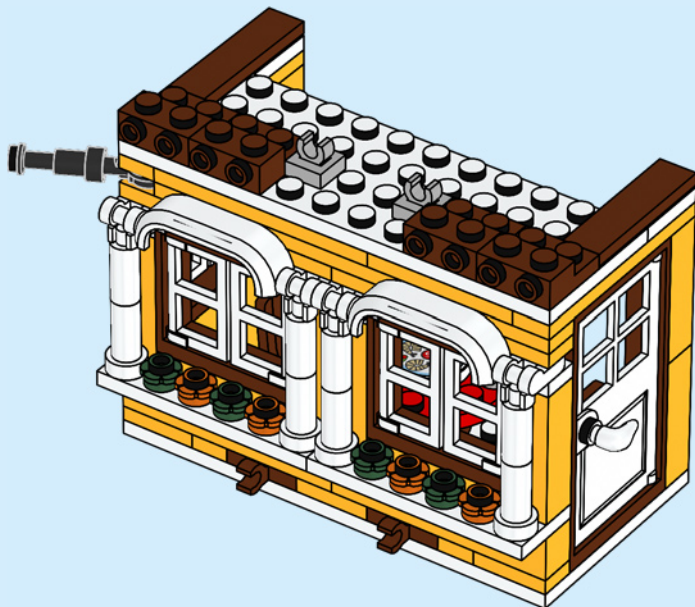



2x



2x

72

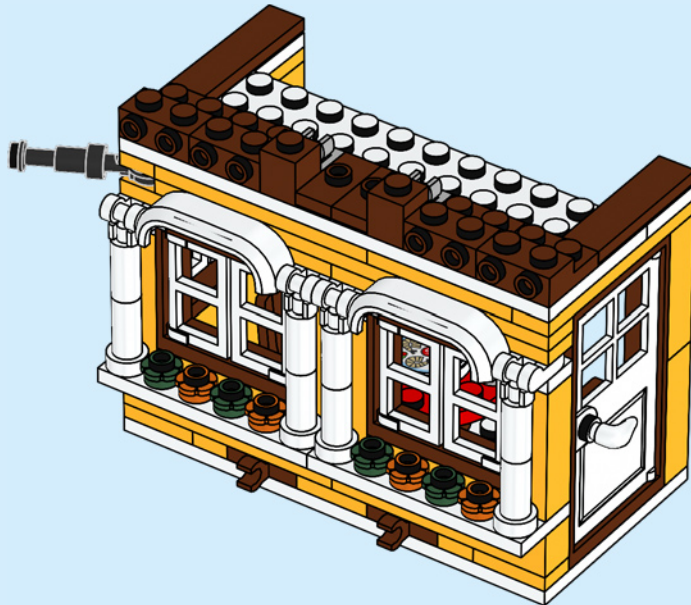

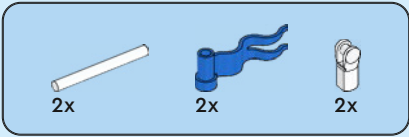

73

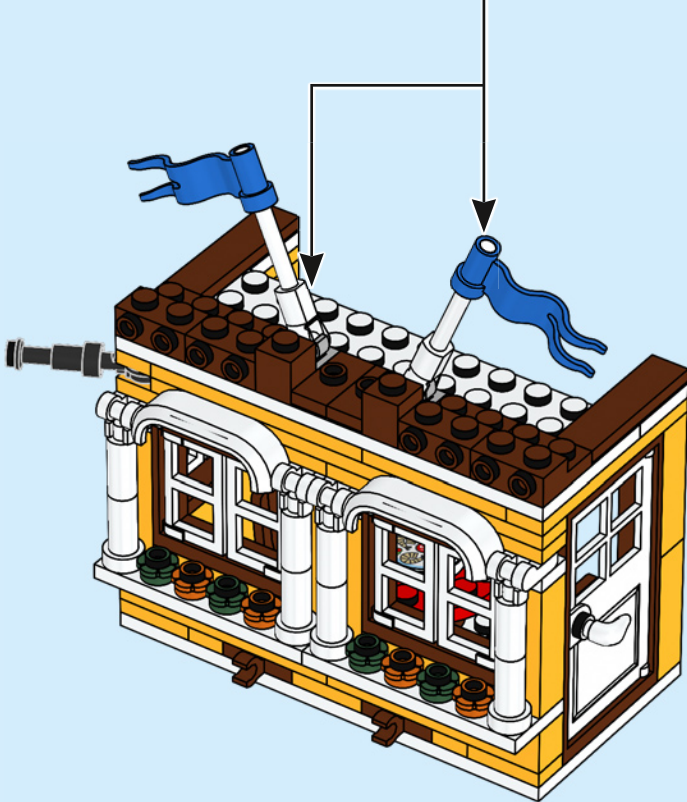
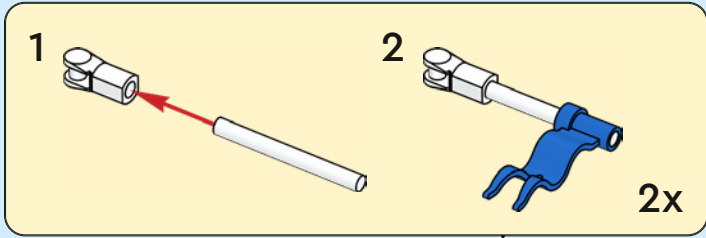



2x

74

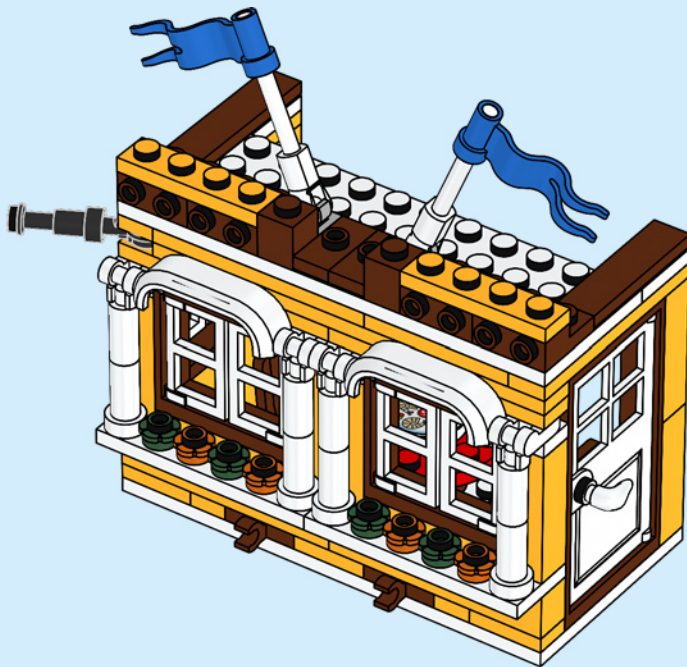

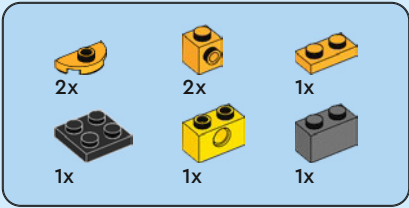

75

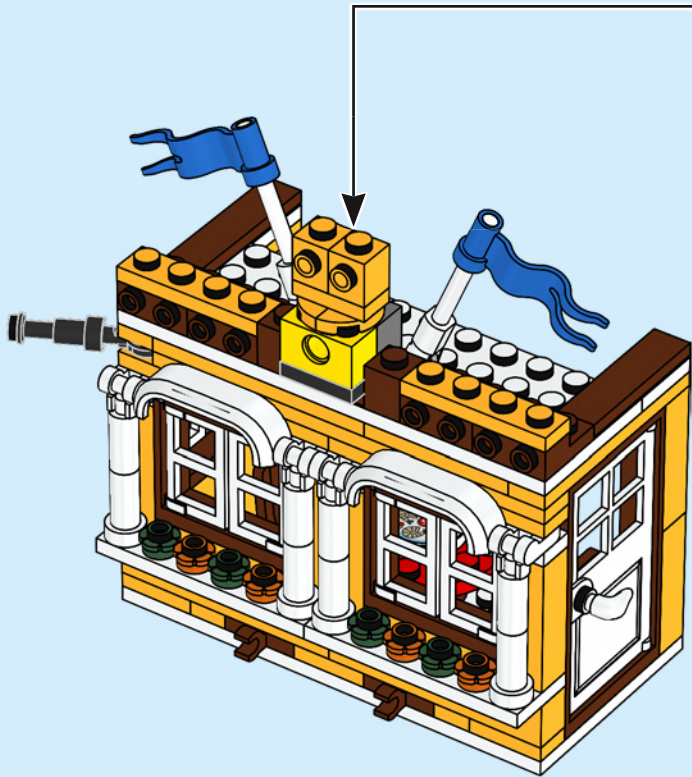
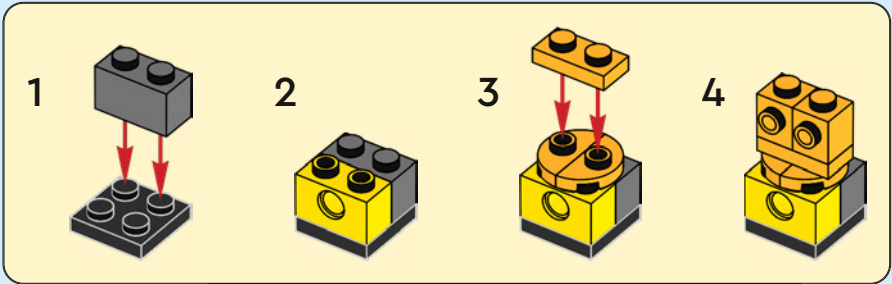

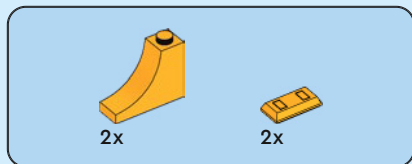

76

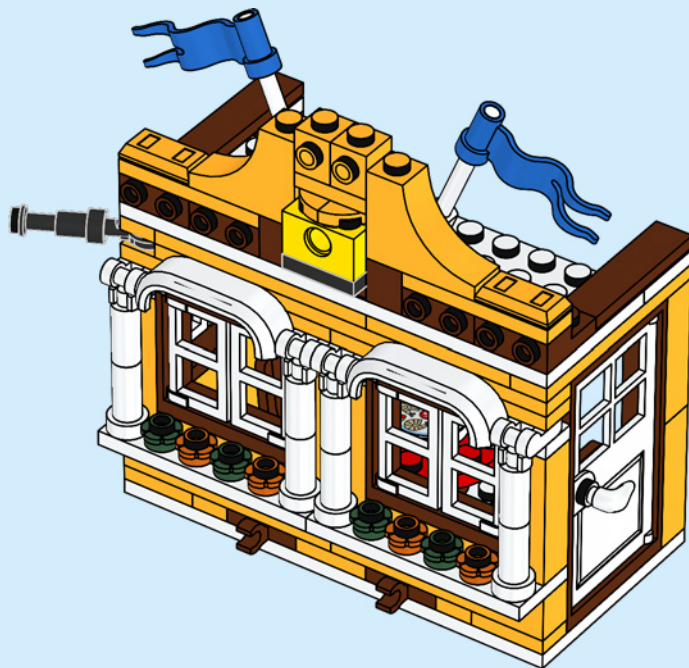



1x

77

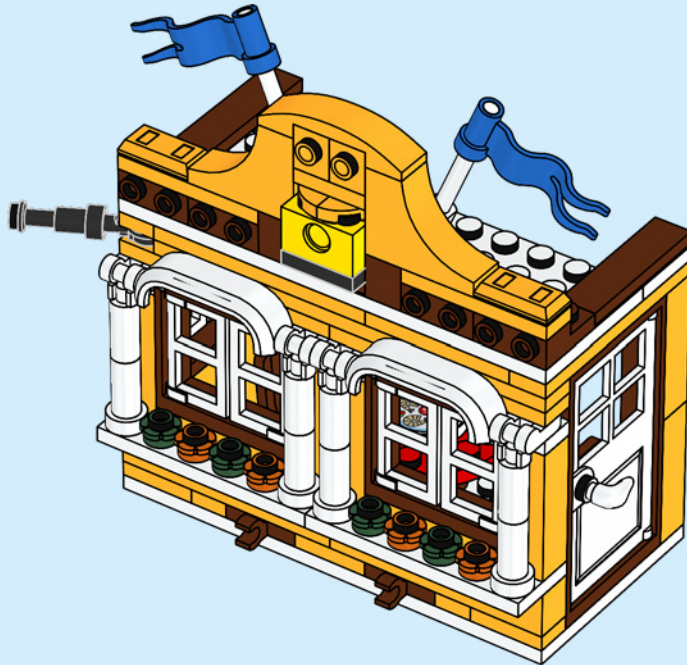



2x



2x



4x

78

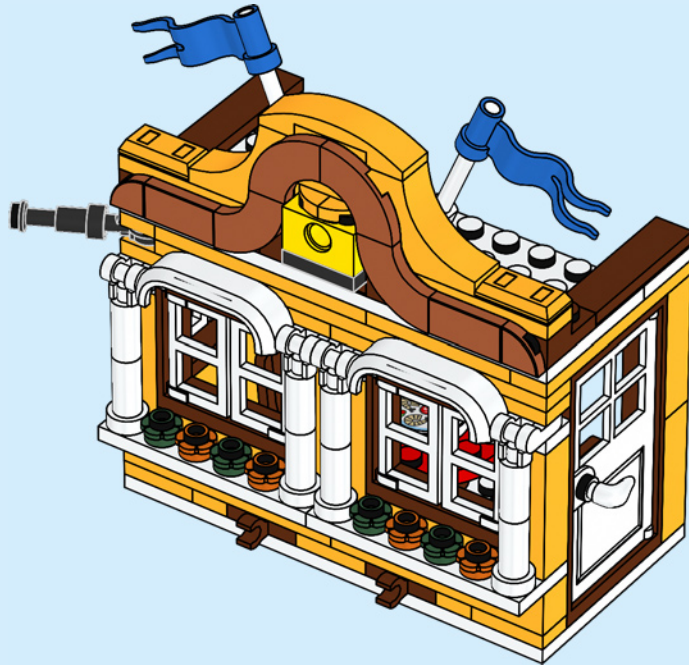



1x

79

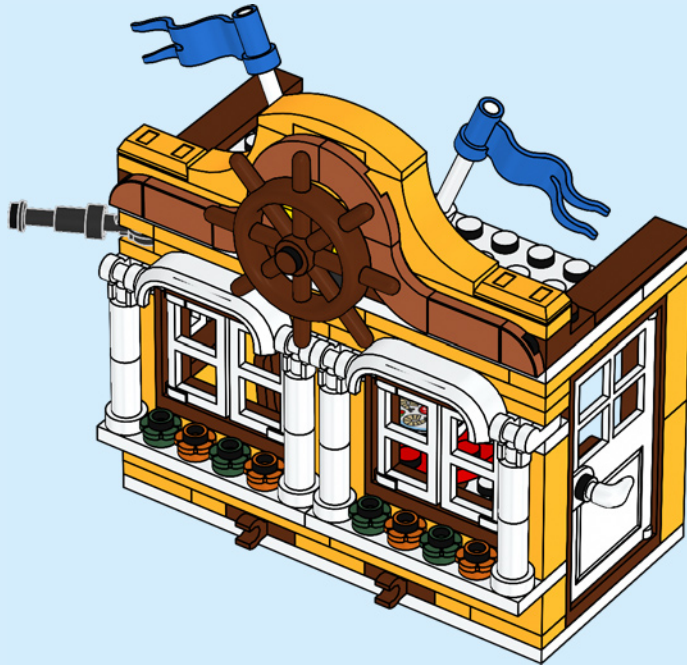

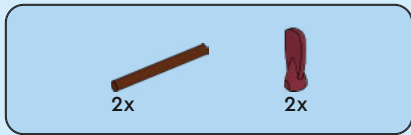

80

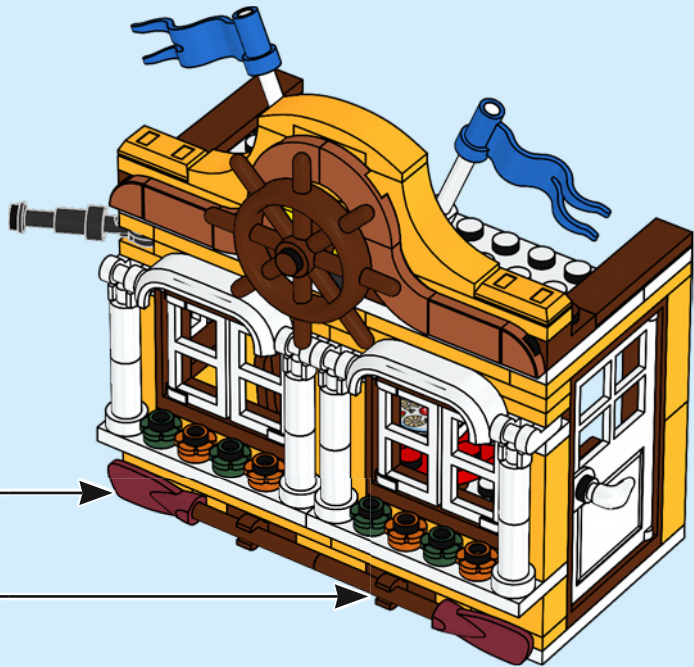
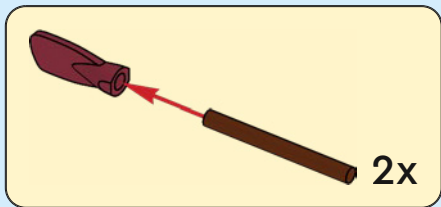

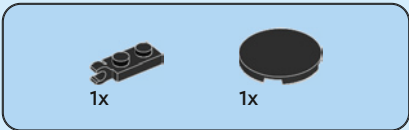

81

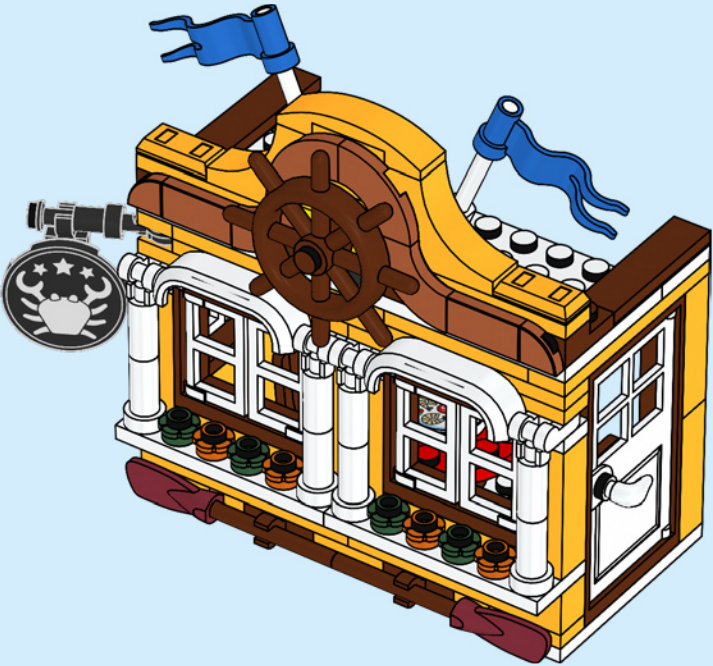
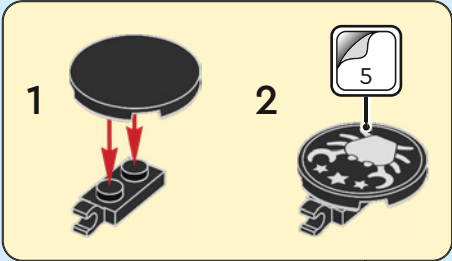

82



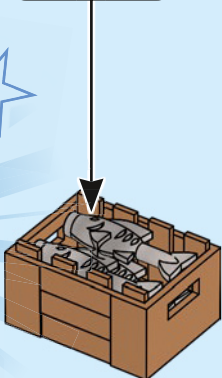
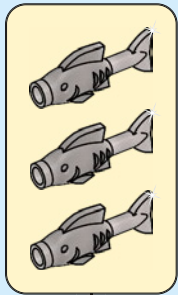
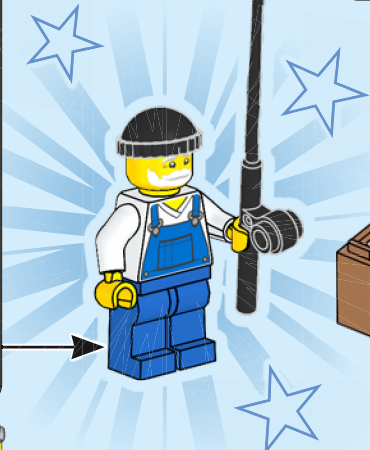
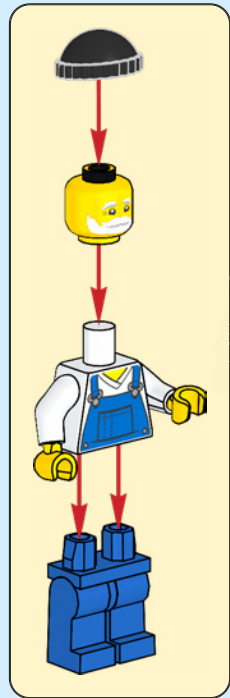
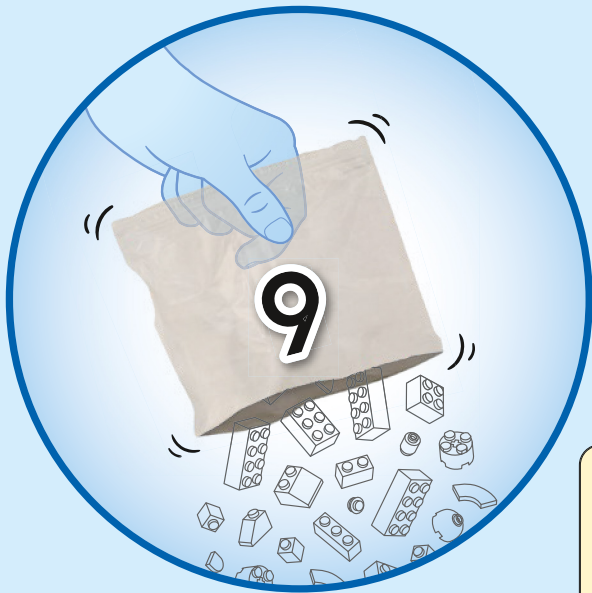

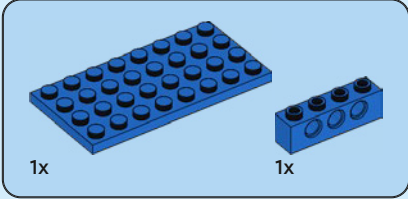
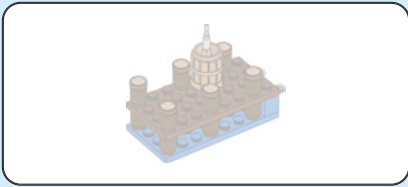

83

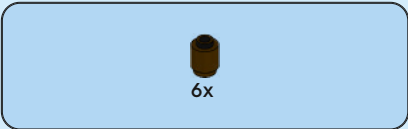
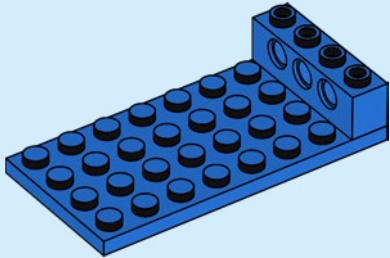

84

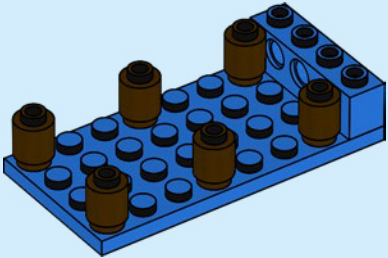

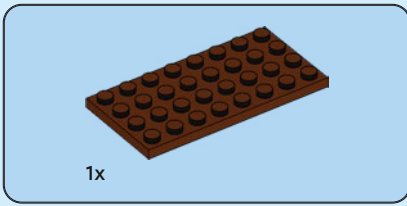

85

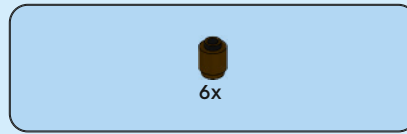
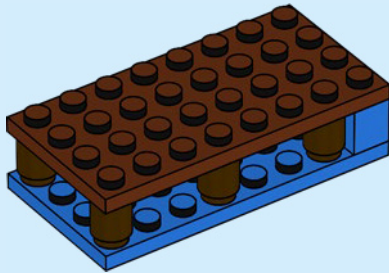

86

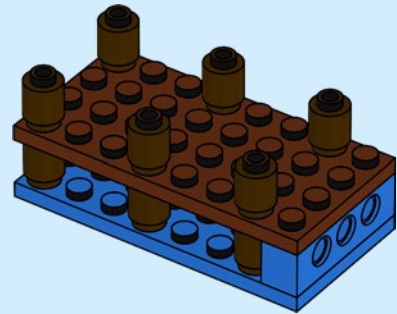



6x

87

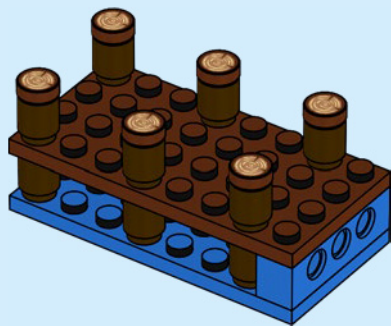

2x

88

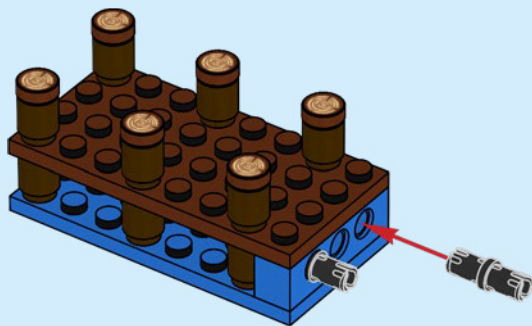

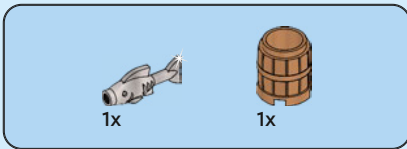

89

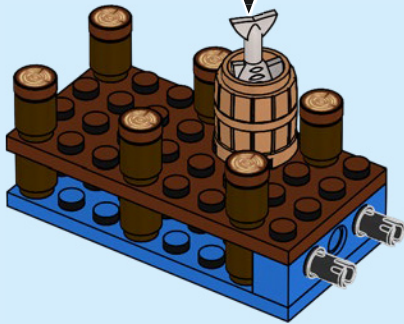
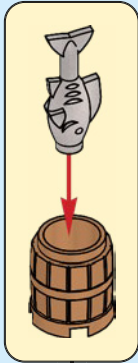

90



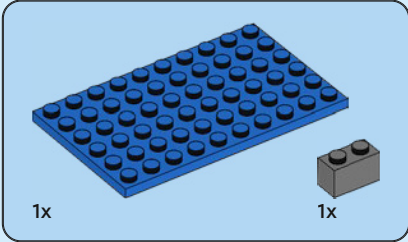
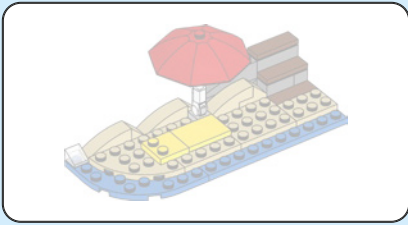

91

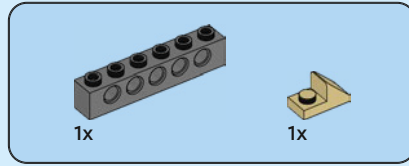
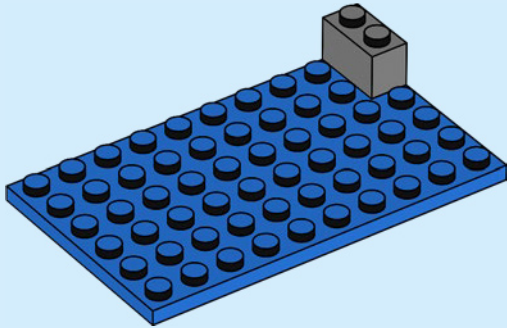

92

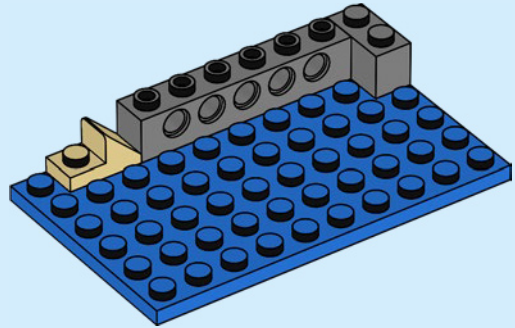

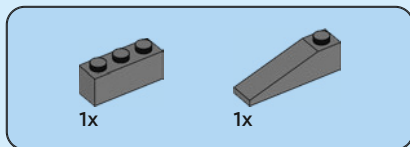

93

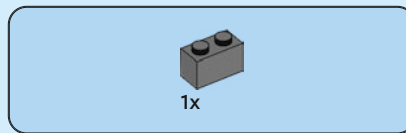
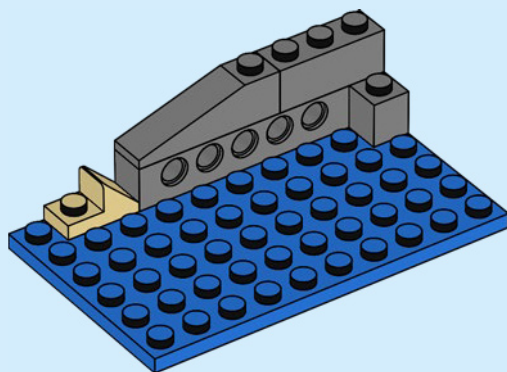

94

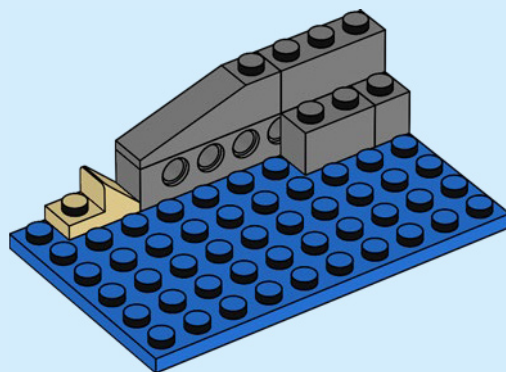

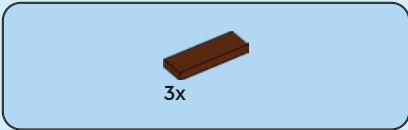

95

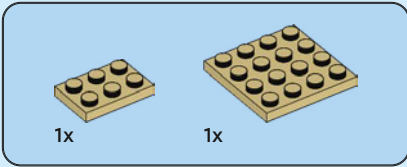
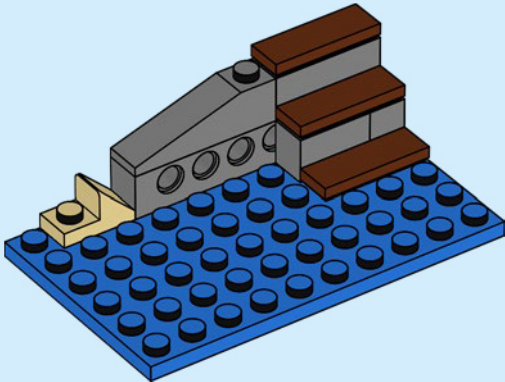

96

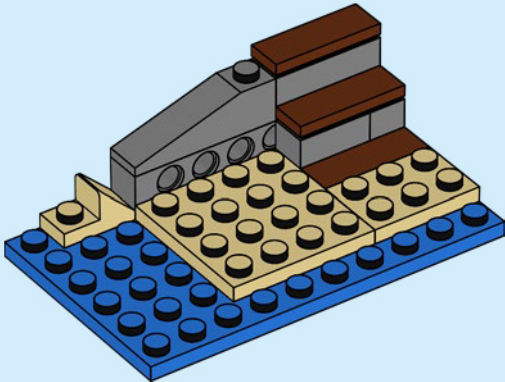



1x

97

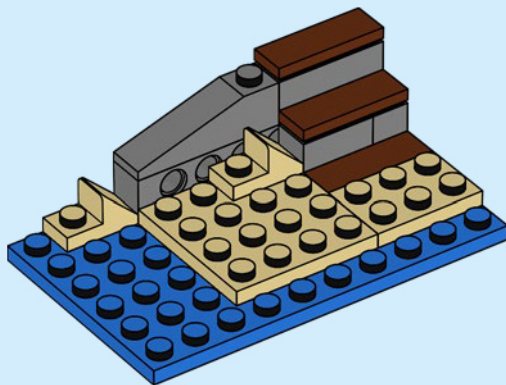

1x

98

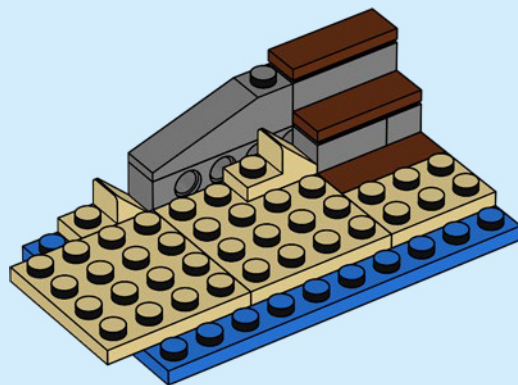

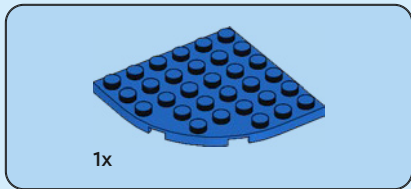

99

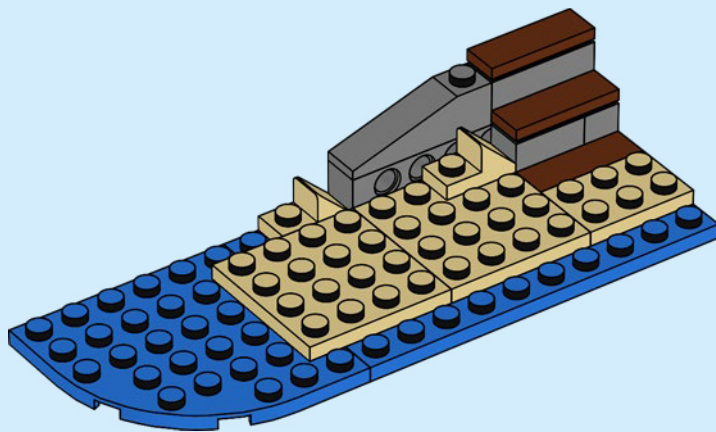



1x



1x

100

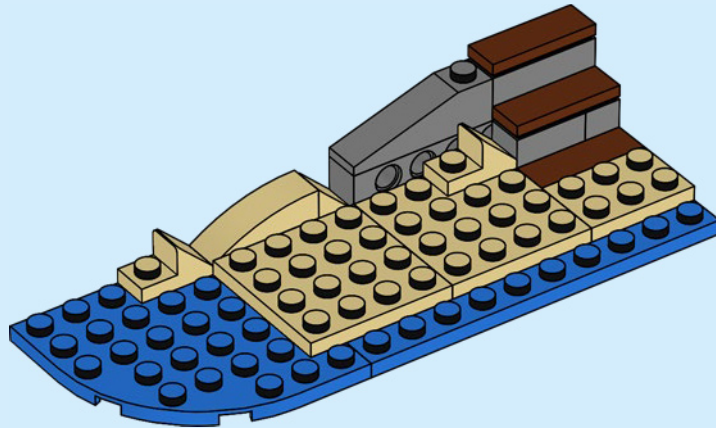

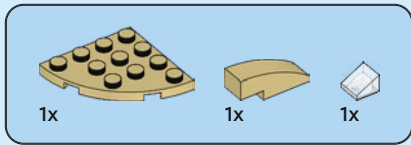

101

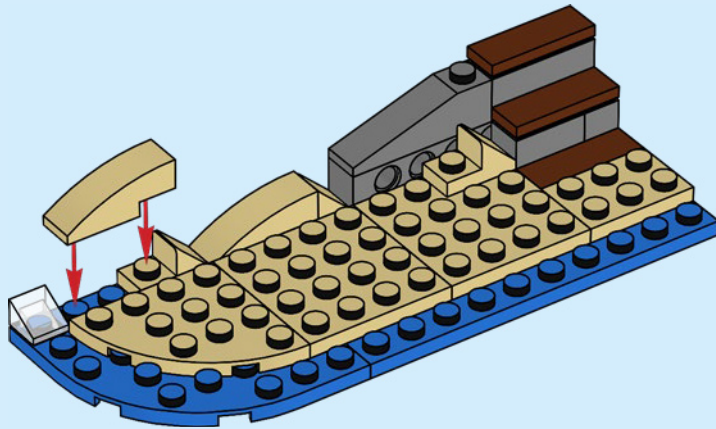



1x



1x

102

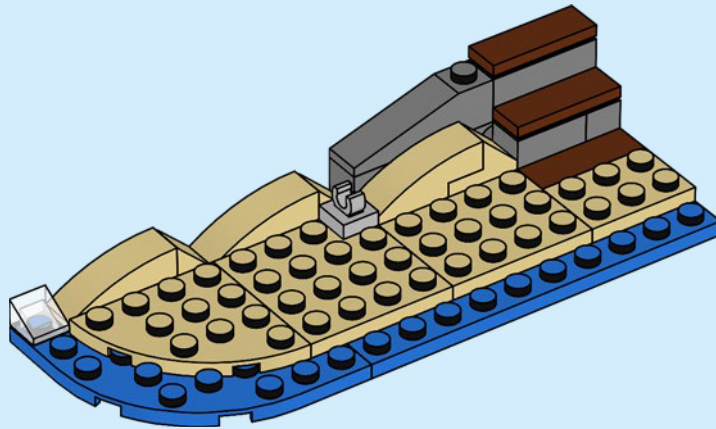

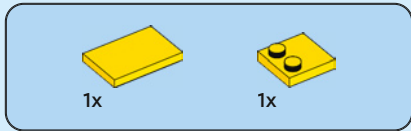

103

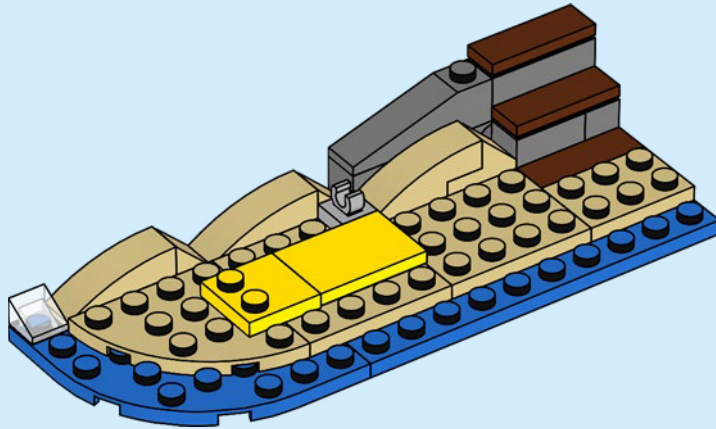

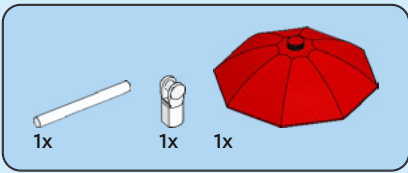

104

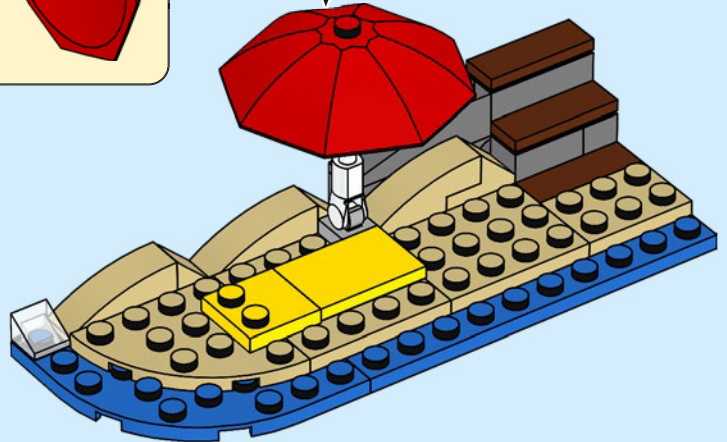
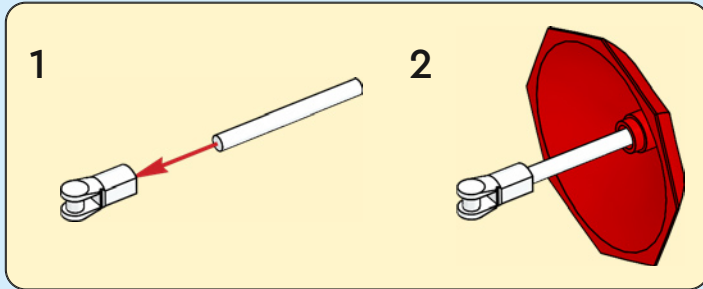

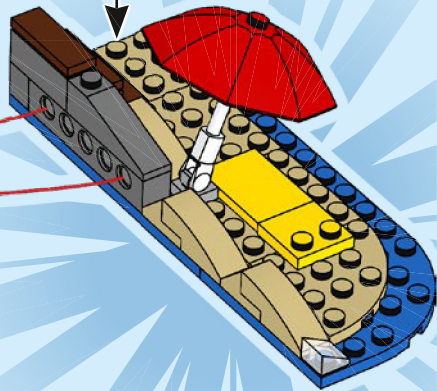
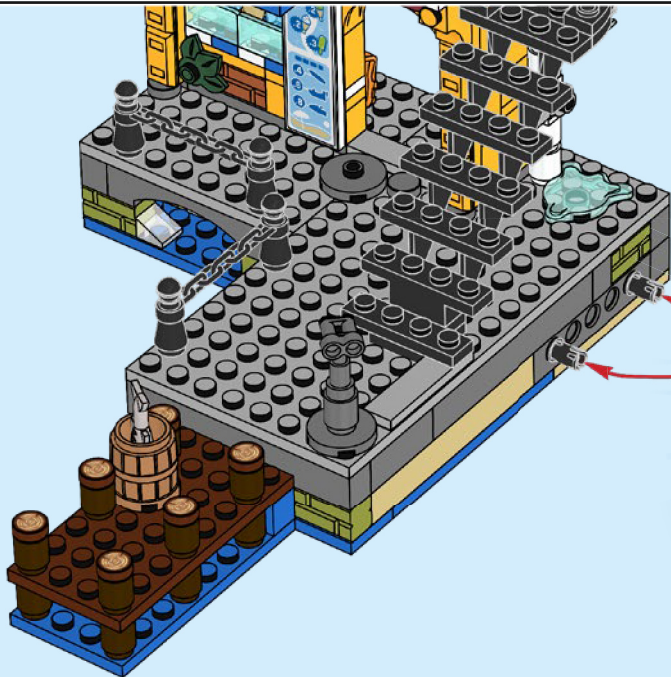
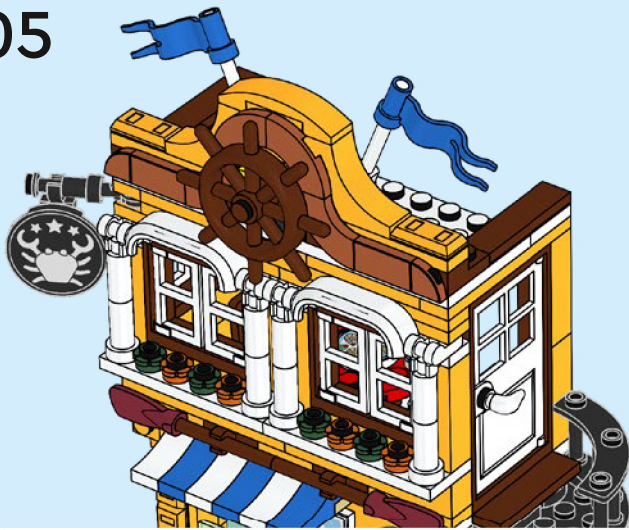



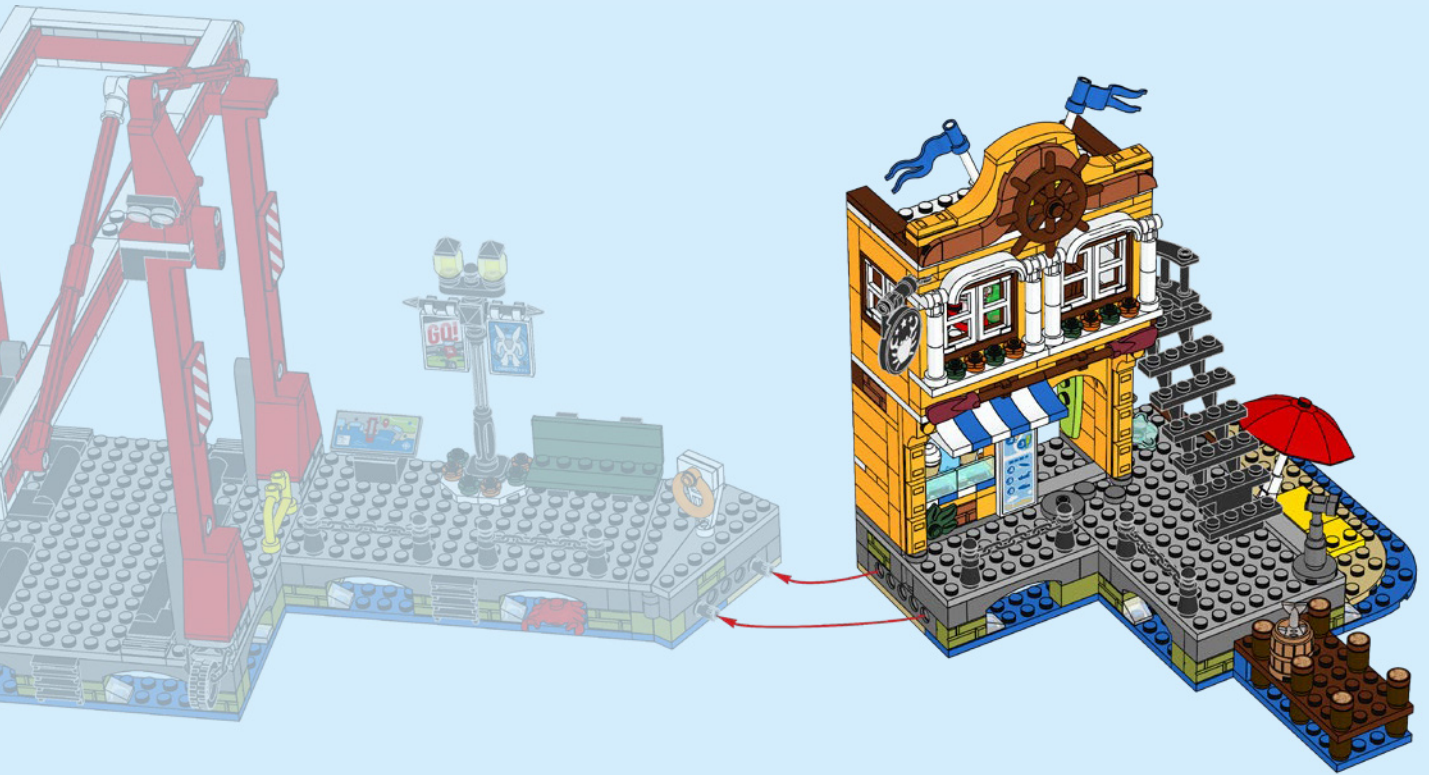

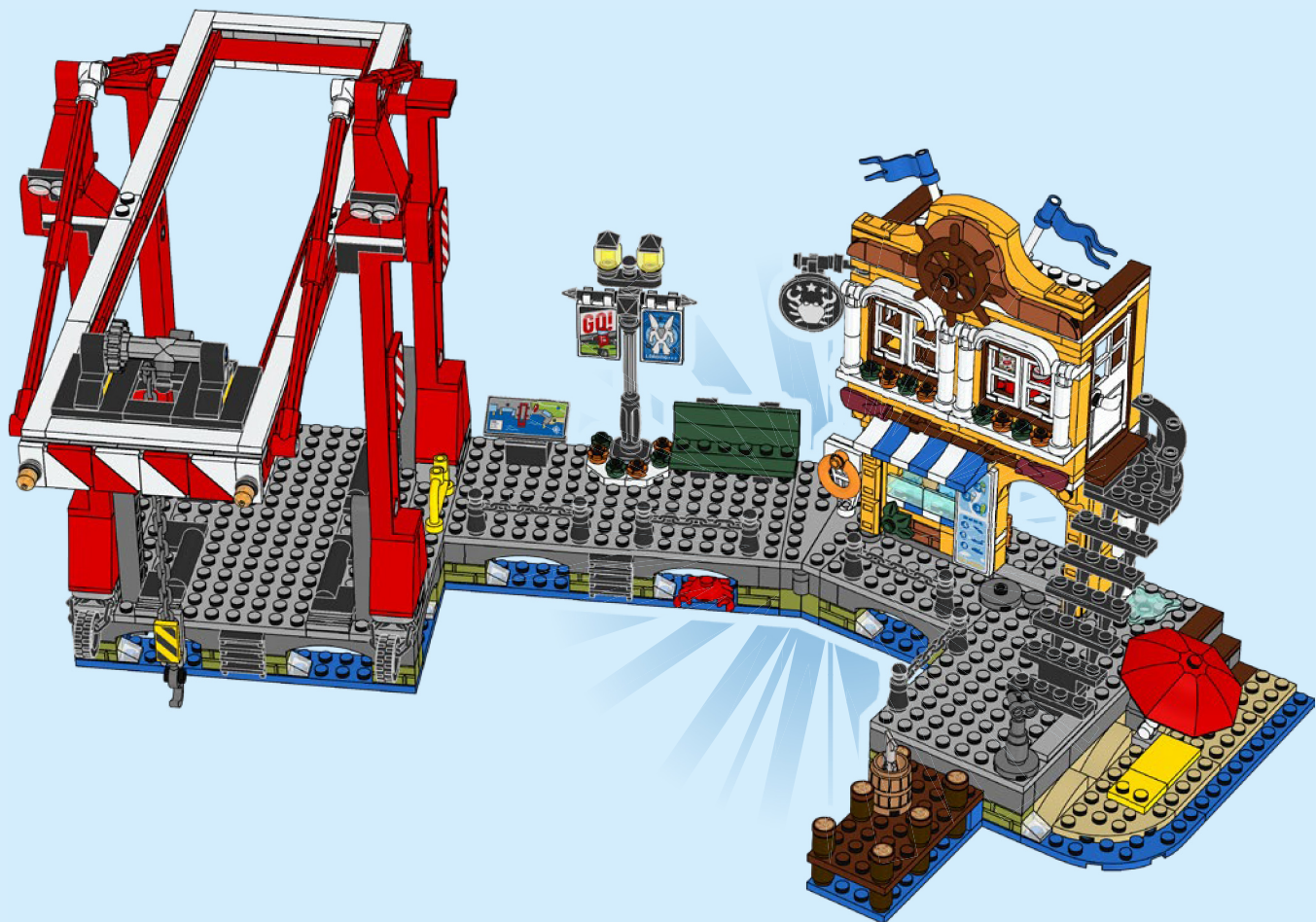

12x
302401

1x
6044691

2x
300401

1x
6108866

1x
6287500

4x
302001

1x
4521943

6x
6171058

1x
6261349

2x
6172927

7x
6357598

4x
6116602

15x
6061047

2x
6435932

1x
6112193

2x
6176240

5x
6051511

2x
362201

3x
302101

1x
4560178

2x
6360131

1x
6132203

1x
6403257

10x
6070698

2x
4558168

6x
371001

1x
4243812

2x
6252931

2x
6055541

1x
6132204

8x
6217875

6x
4568956

2x
6034675

4x
379501

1x
6170524

2x
4504369

2x
6400114

6x
6004491

1x
6425508

2x
6249091

3x
6332042

4x
6058329

4x
300501

2x
6210272

2x
6126046

1x
6219621

3x
4521846

2x
4599044

2x
6366391

4x
6348055

7x
6330191

2x
302201

1x
6268491

2x
365901

10x
416201

6x
306901

2x
407001

4x
6174937

2x
6218822

1x
6270480

1x
6289797

1x
6483097

12x
302301

2x
6058177

2x
6054973

1x
4120020

1x
4168072

1x
6486813

2x
244501

7x
447701



1x
6337079



8x
6234807



2x
614101



4x
306201



2x
6448949



5x
6186681



1x
6438901



1x
6328195



8x
6388018



3x
6322489

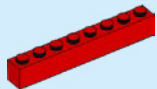

6x
300821



8x
6130004



1x
300321



4x
6480179



10x
6007897



2x
303921



2x
306821



6x
370021



8x
6078594



1x
6483104



4x
6332580



2x
6093950



4x
4513174



1x
6253363



4x
302321



2x
4207715



8x
6351892



4x
4140585



2x
4153718



4x
370121



1x
303523



1x
303221



1x
4515348



4x
4560179



4x
366621



1x
4649773



2x
243123



6x
370123



2x
371023



3x
379523



1x
6093691

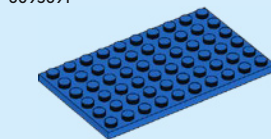

1x
6339304



2x
6432005



2x
6352221



1x
4206482



1x
9341



1x
6290532



3x
306823



2x
6299413



5x
6439891



2x
6268955



4x
303423

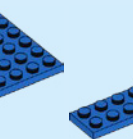

2x
6481432



1x
6429739



1x
4651441



1x
6328351



1x
6352820



1x
6288000



1x
6039464



1x
6369661



1x
6312495



1x
389924



2x
302324



1x
370024



1x
6329649



4x
4140587



4x
242024



4x
393724



1x
300324



1x
6224666



2x
408324

































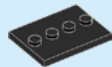





















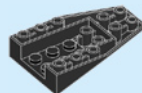

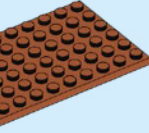

1x
6179184





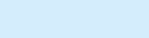

























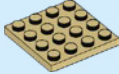

















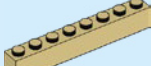



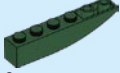





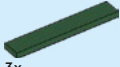

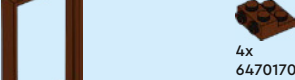

2x
371024

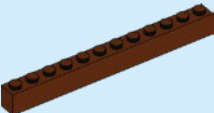

1x
302024

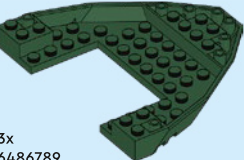
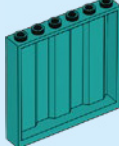
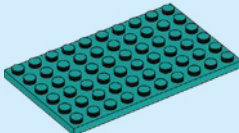
 2x 6170545	 1x 6132809	 2x 4617848	 1x 300226	 2x 302026	 2x 6347310
 3x 6312449	 2x 6285241	 2x 6053077	 1x 6376695	 1x 6115198	 6x 302326
 4x 4504382	 3x 6336989	 3x 300326	 2x 6395375	 6x 6328408	 1x 393726
 1x 473326	 1x 6428168	 3x 302226	 1x 371026	 2x 6076678	 2x 4144024
 1x 6277468	 1x 6170693	 2x 6425507	 1x 4187209	 4x 663626	 2x 306926
 1x 4157108	 8x 242026	 8x 6133722	 4x 6370959	 2x 4620763	 1x 6196548
 2x 6157554	 8x 303926	 5x 6192346	 1x 6438520	 1x 6101857	 1x 4538456
 2x 4548180	 1x 6007896	 1x 9551	 2x 4515368	 1x 6399751	 3x 6020193
 13x 4278359	 1x 4618852	 1x 400626	 1x 4560182	 2x 6263971	 26x 6279875
 1x 403226	 2x 241226	 1x 4279270	 2x 6396288	 1x 6240515	 1x 243226
 2x 6010831					
 2x 4644456					

 2x 6210496	 1x 6400754	 3x 4624088	 1x 6364438	 4x 6340042	 6x 6285623
 10x 6088550	 2x 6484030	 1x 4118790	 1x 6334219	 2x 6228968	 1x 6438899
 2x 6321194	 4x 4245570	 2x 4114309	 2x 6017003	 1x 4211186	 2x 4211242
 10x 6168646	 3x 6013102	 2x 4243824	 3x 6069165	 1x 6278548	 1x 6491486
 8x 4529236	 2x 6391596	 1x 4570516	 6x 6330903	 3x 4211194	 1x 4211166
 1x 6270122	 8x 6486808	 5x 4113993	 1x 6205345	 2x 6116613	 1x 6223059
 7x 6446790	 3x 4245566	 1x 4159774	 1x 6397830	 3x 4595889	 2x 4221886
 4x 4521915	 8x 6486791	 1x 4114001	 2x 6314383	 1x 6262952	 2x 6092590
 2x 6055169	 3x 6216880	 2x 4113988	 2x 4614158	 4x 6470170	 2x 6313124
 2x 6215657	 2x 6215657	 2x 6427403	 1x 4211207	 1x 4222627	 2x 4211206
 3x 6486789	 2x 6337306	 2x 6427403			 3x 6100769

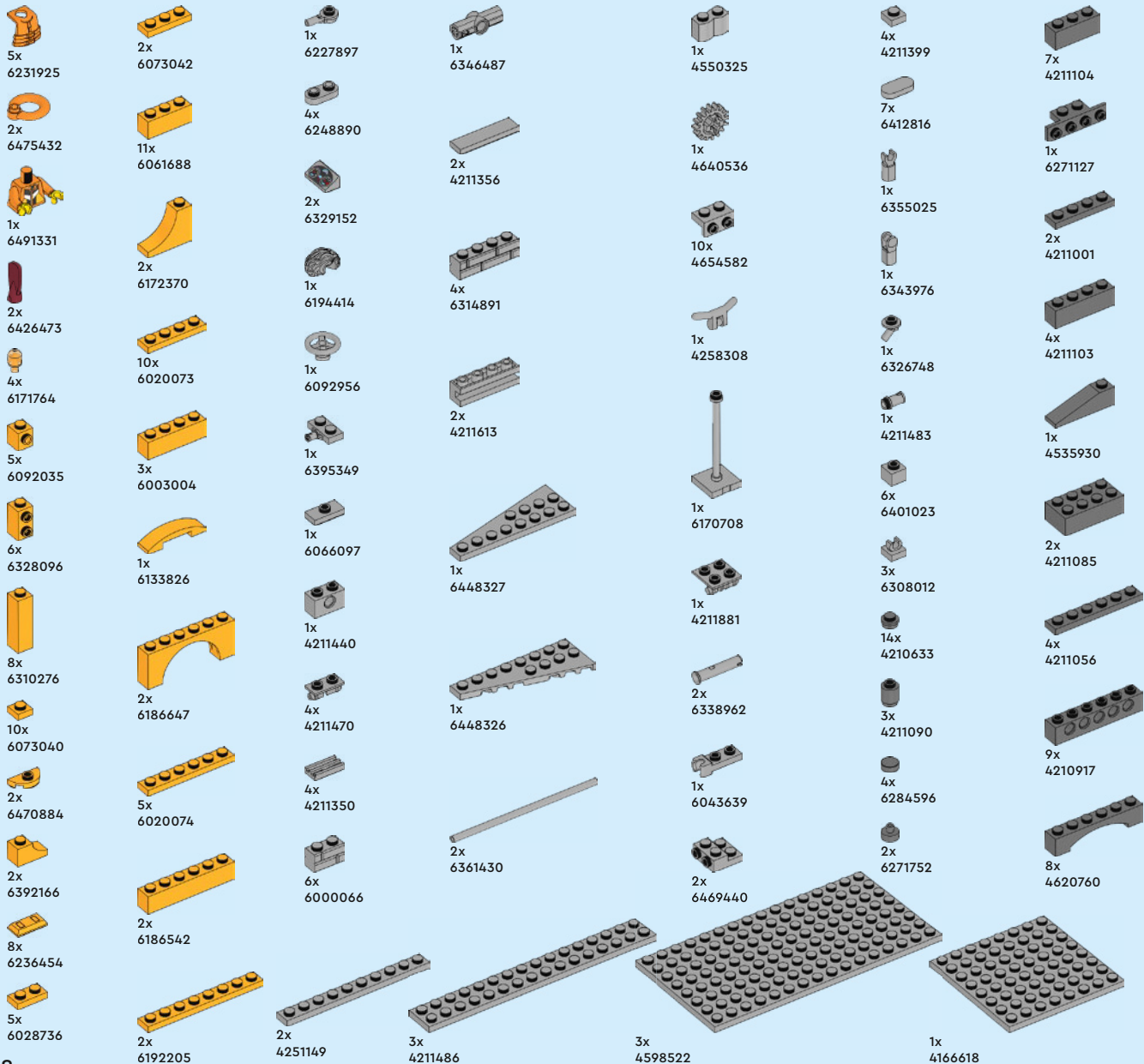



1x
4211039



8x
4211111



2x
6115080



2x
4211098



4x
4211063



2x
6331222



1x
4211051



1x
4210795



1x
6347464



1x
4211109

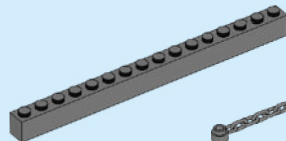

5x
4210783



2x
6360111



1x
6395635



3x
4211088



1x
6327414



1x
6396412



12x
6022105



1x
6333518



1x
6365629



1x
6035734



1x
6035734

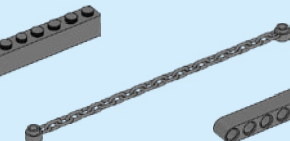

1x
6258887



12x
6274738



2x
6454463



7x
6245250



1x
6277460



6x
6251294



1x
6258607



1x
6252042



2x
6267057



2x
6300208



1x
6274742



1x
6247364



1x
6252046

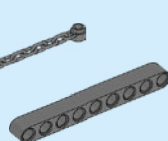

4x
4645730



2x
6246890



1x
6373590



6x
6254563



1x
6245307



2x
4537251



2x
6069006



1x
6023954



1x
6102906



1x
4267425



1x
4162916



2x
4211099



1x
6253187



1x
6329604



8x
6215447



4x
4611885



1x
6031019



1x
6029933



7x
6058242



16x
6469108



3x
6058220



2x
6390087



1x
6471300



4x
6467485



4x
6469085

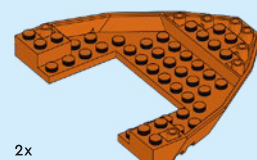

2x
6486814

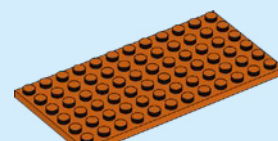

1x
6482851

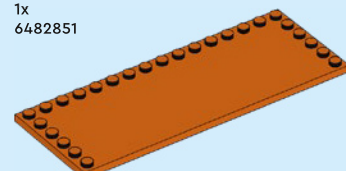

2x
6488728



1x
6470072



7x
6475523



8x
6466720



[LEGO.com/service](https://www.LEGO.com/service)

YOU COULD **WIN**

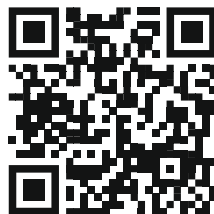

Scan this QR code or go to **LEGO.COM/PRODUCTFEEDBACK** and give us your short feedback about this LEGO® set for a chance to win a cool LEGO prize.

Terms and Conditions apply*

EN: YOU COULD WIN. Terms and Conditions apply* **DE: Du könntest GEWINNEN.** Es gelten die Teilnahmebedingungen* **FR: Tu pourrais GAGNER.** Des conditions s'appliquent* **IT: Potresti VINCERE tu.** Termini e condizioni sono applicabili* **ES: Puedes GANAR.** Aplican términos y condiciones* **PT: Poderá GANHAR.** Aplicam-se termos e condições* **ZH: 轻松获奖. 条款和条件适用*** **PL: Szansa na WYGRANĄ.** Obowiązują warunki korzystania* **CS: Máte šanci VYHRÁT.** Platí všeobecné smluvní podmínky* **SK: Máte šancu VYHRAŤ.** Platia všeobecné zmluvné podmienky* **HU: TE IS NYERHETSZ.** Felhasználási feltételek érvényesek* **RO: Ai putea CÂȘTIGA.** Se aplică termeni și condiții* **BG: Можете да СПЕЧЕЛИТЕ.** Има определени правила и условия* **LV: Tu vari LAIMĒT.** Ir spēkā noteikumi un nosacījumi.* **ET: Sul on võimalus VÕITA.** Kehtivad tingimused* **LT: Jūs galite LAIMĖTI.** Taikomos sąlygos*

*[LEGO.com/productfeedback-terms](https://www.lego.com/productfeedback-terms)