



# CITY

60154



 [LEGO.com/city](http://LEGO.com/city)



1



2



3



4



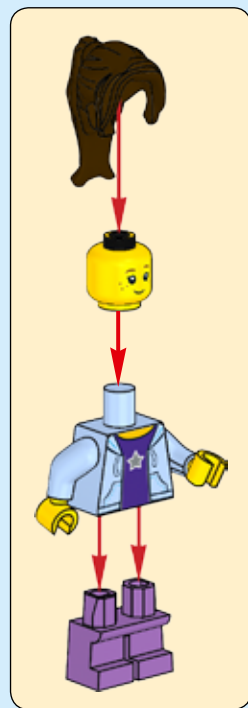
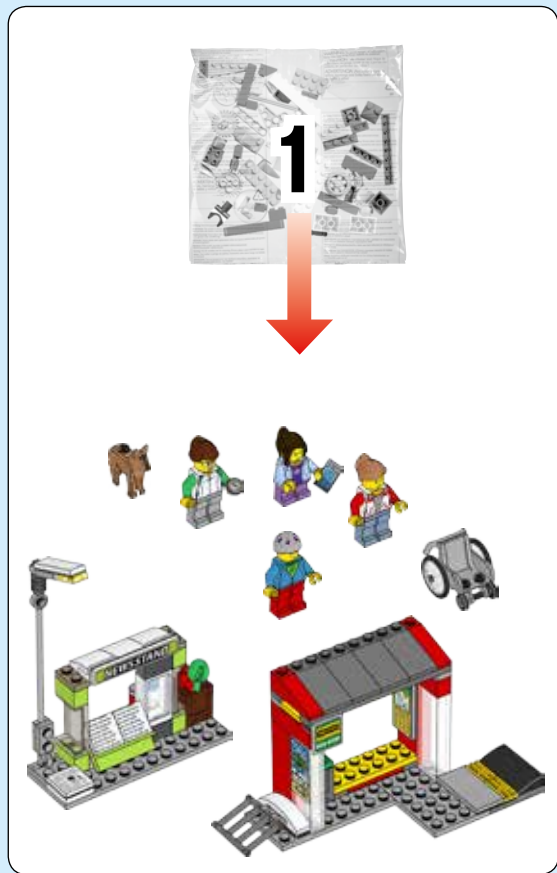

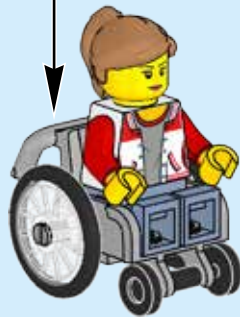
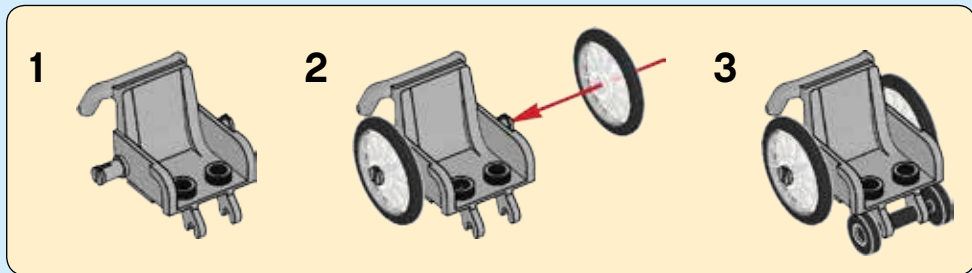
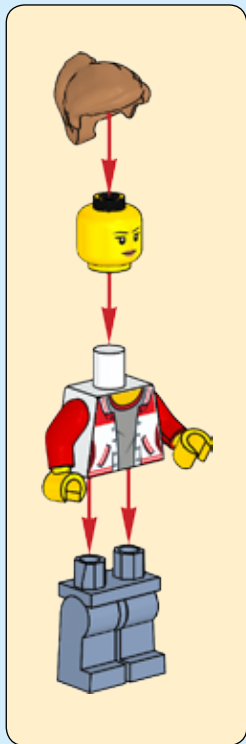

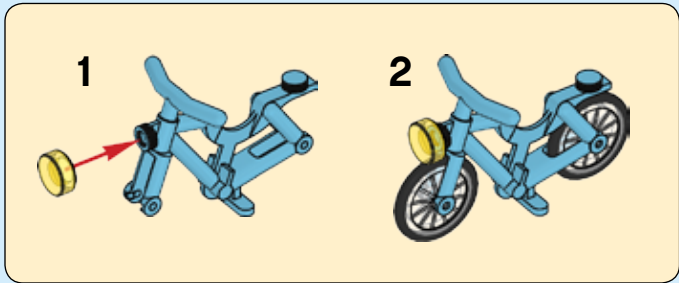

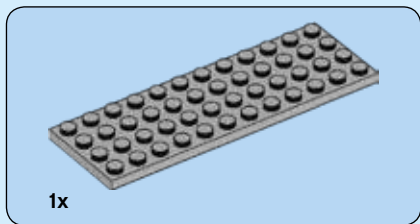

1

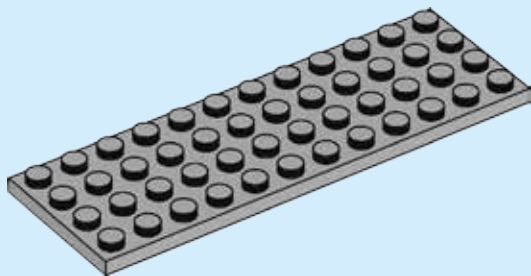

6

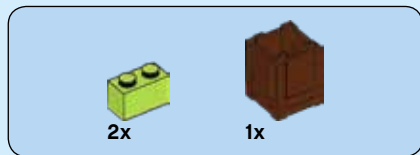

2

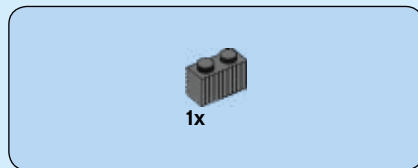
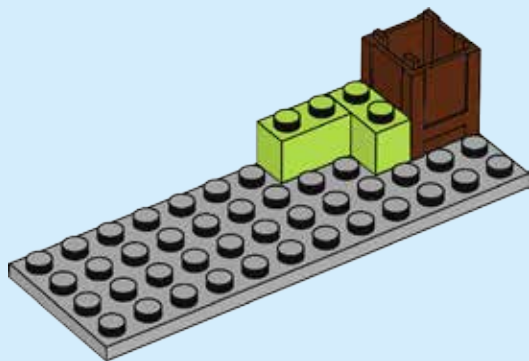

3

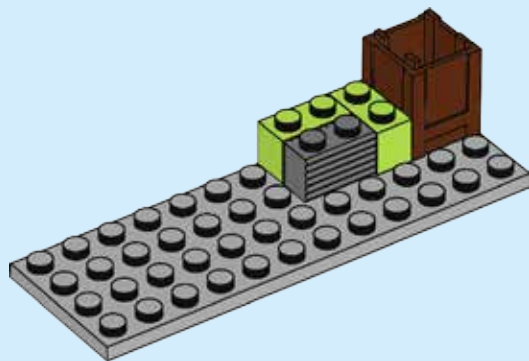



1x

4

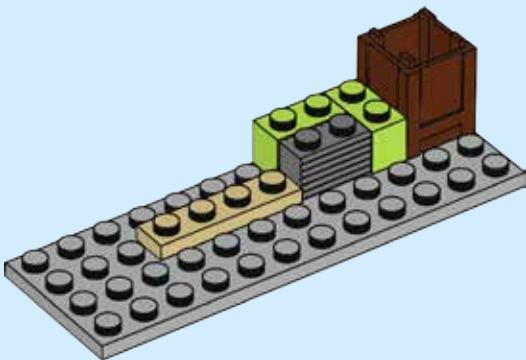

8





2x

5

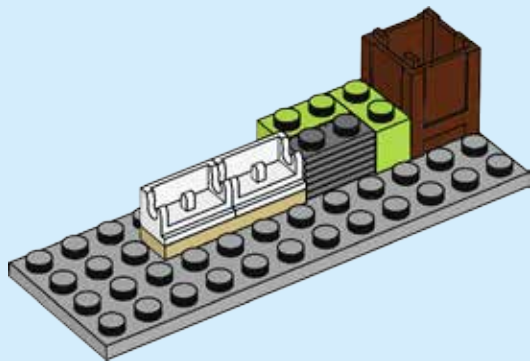

1x



1x

6

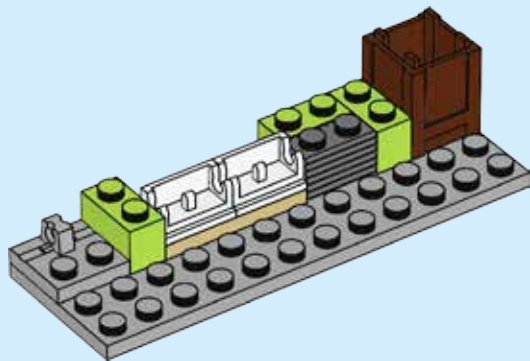



7

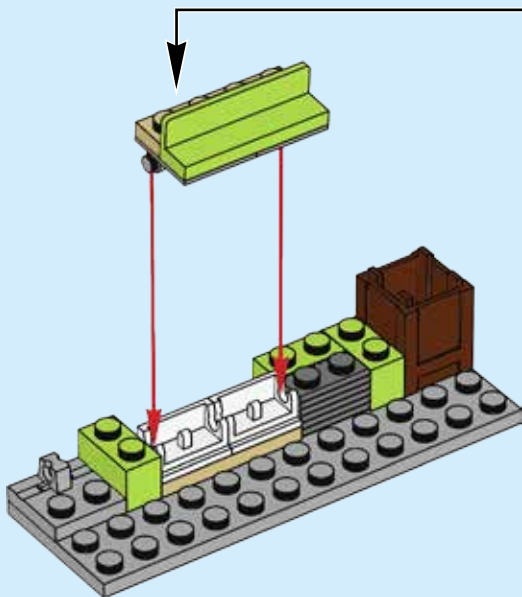
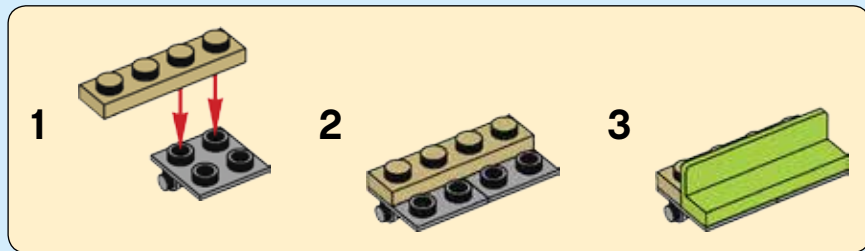



1x

8

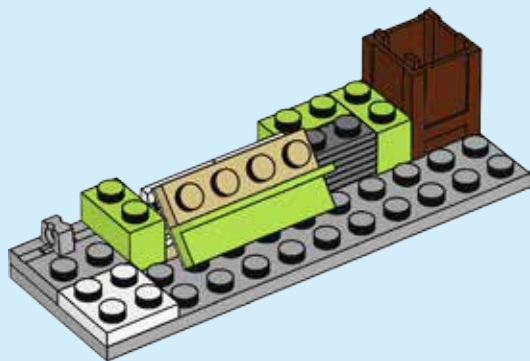

1x



1x

9

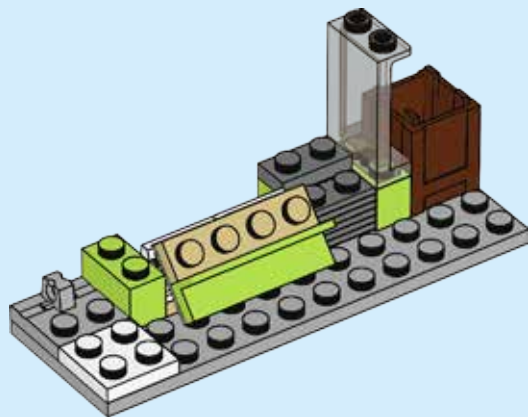

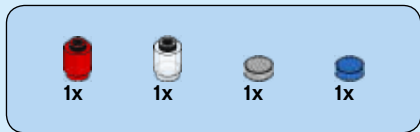

10

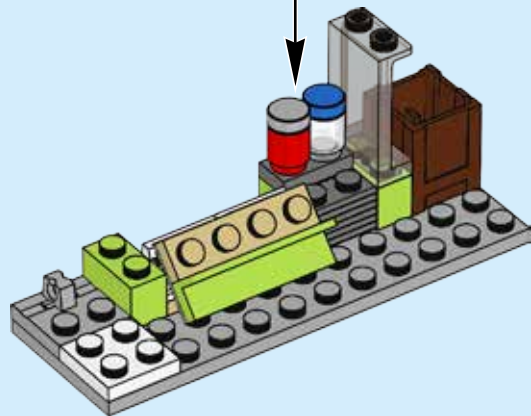
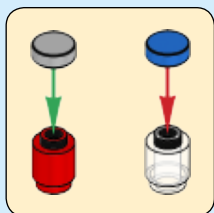

12

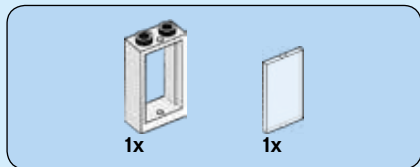

11

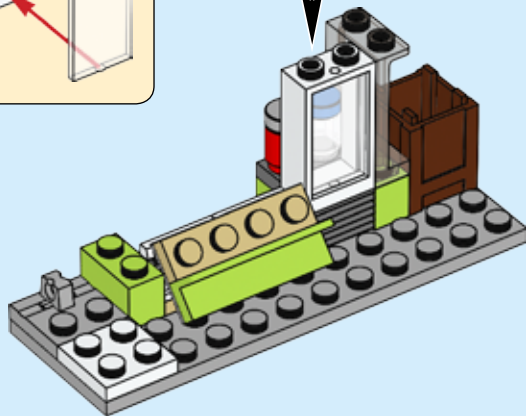
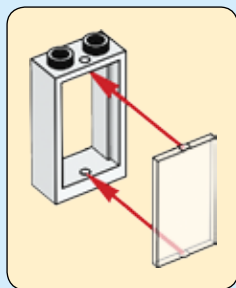

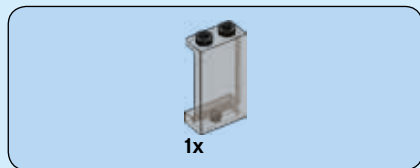

12

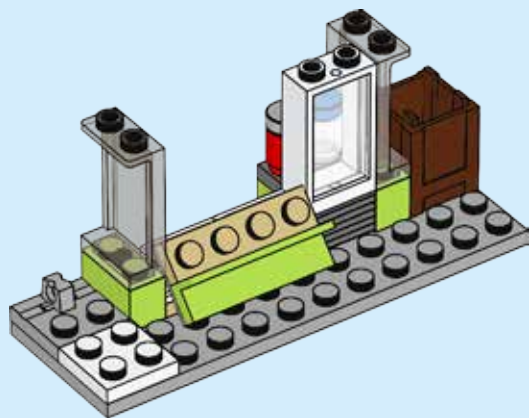

13

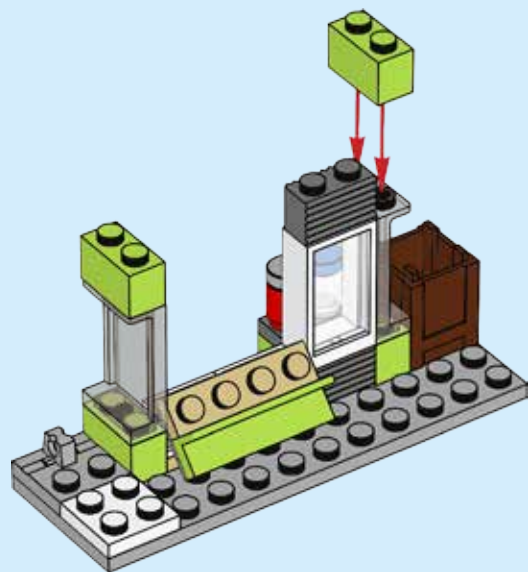

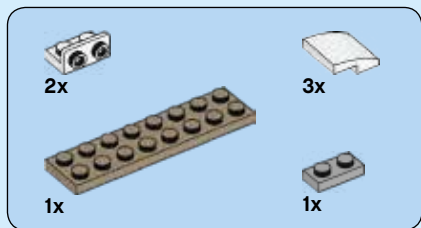

14

1

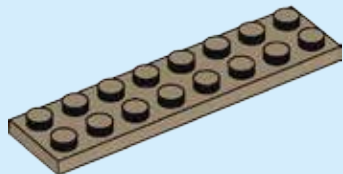

2

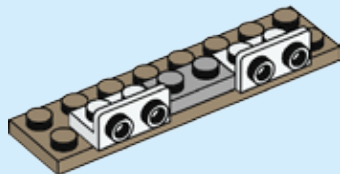

3

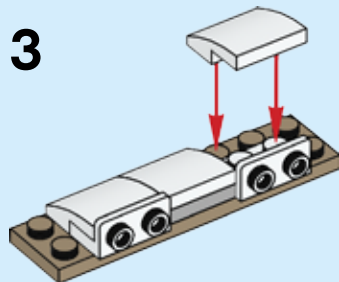

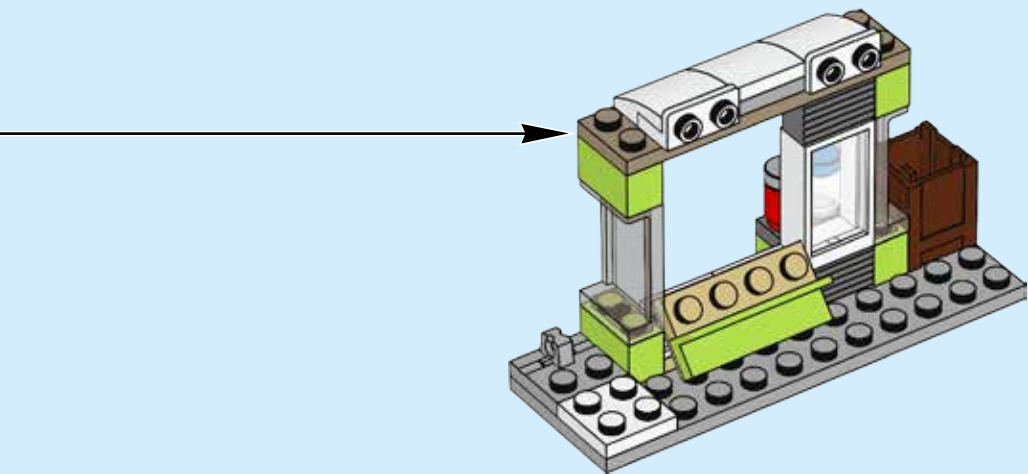

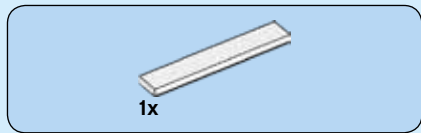

15

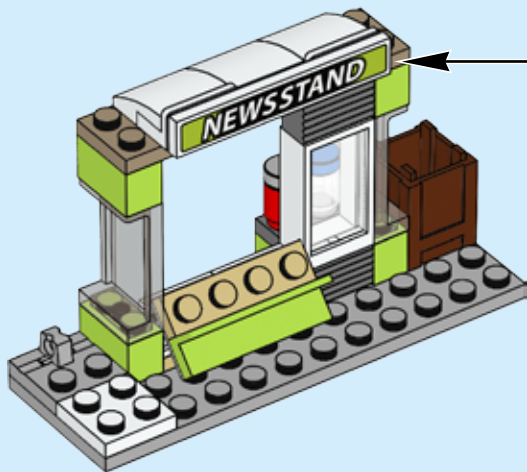
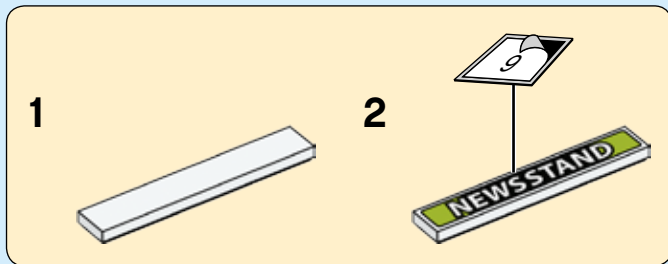

16





3x

16

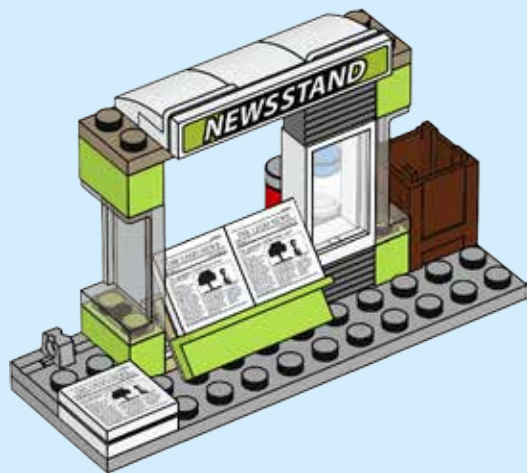

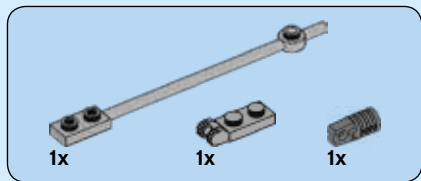

17

1

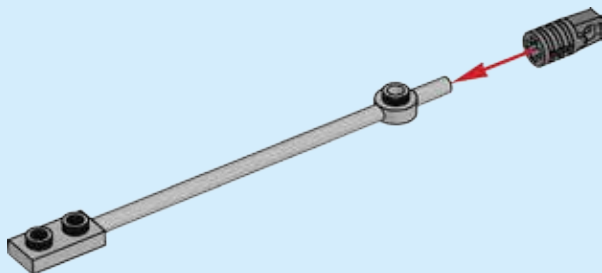

2

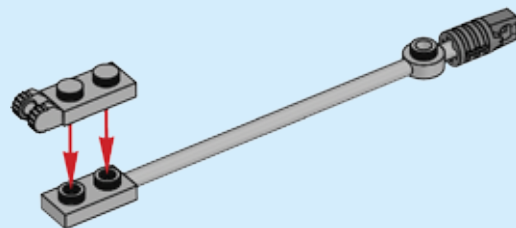

18

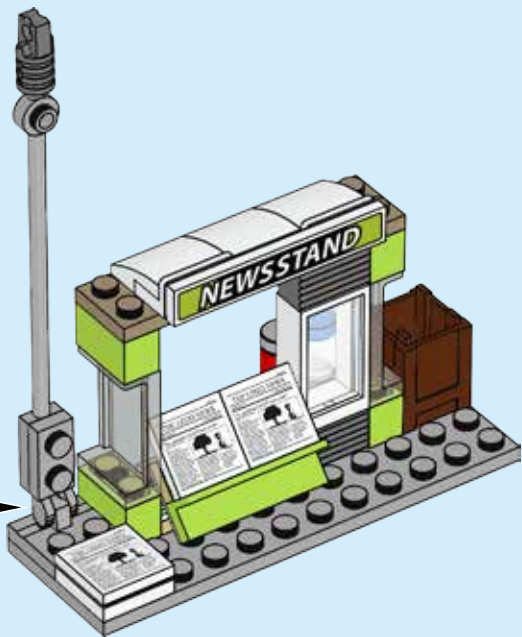

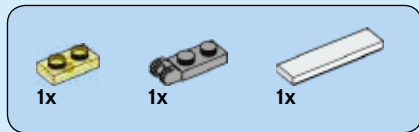

18

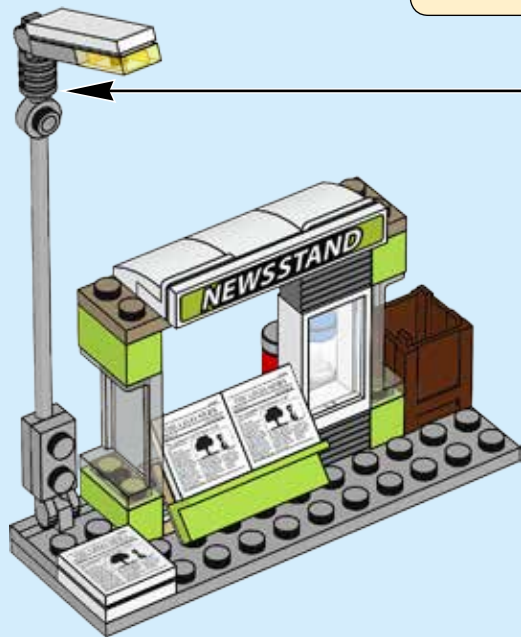
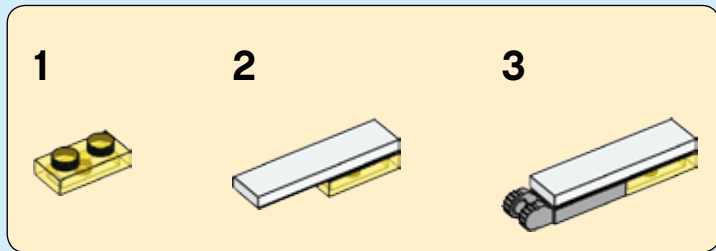



1x



1x

# 19

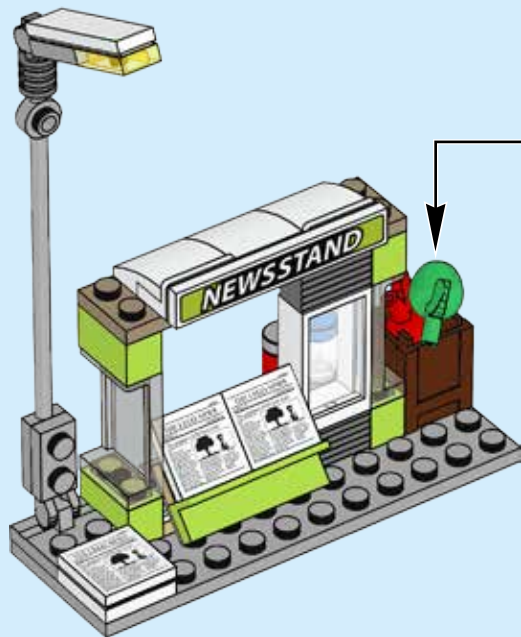

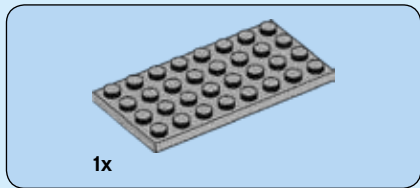
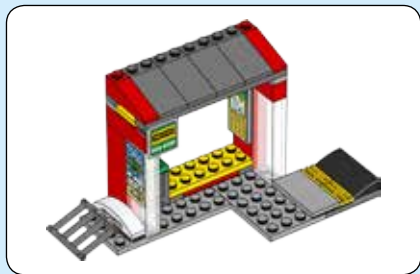

**1**

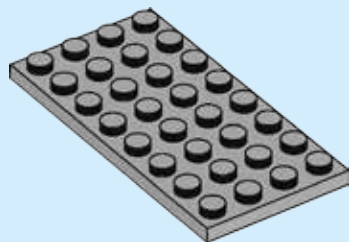



2

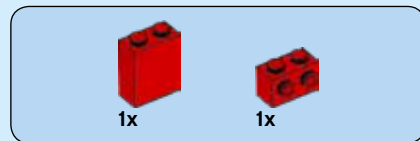
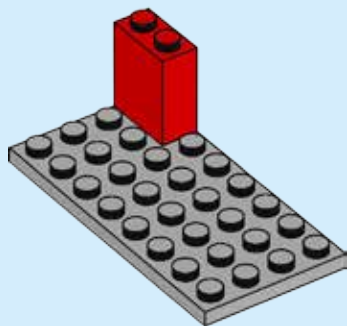

3

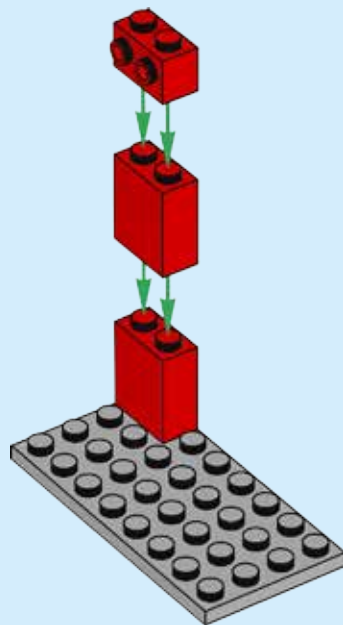

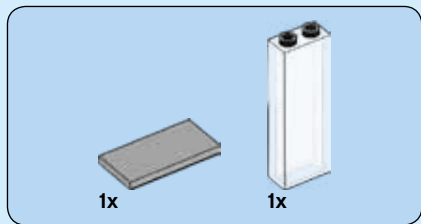

4

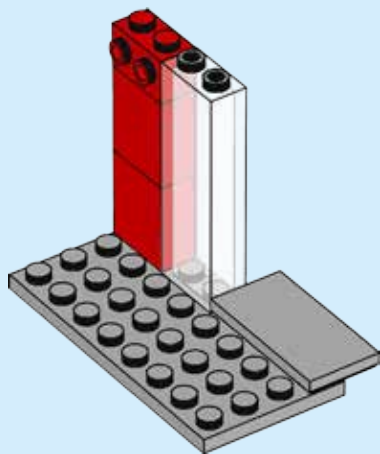





5

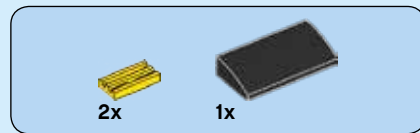
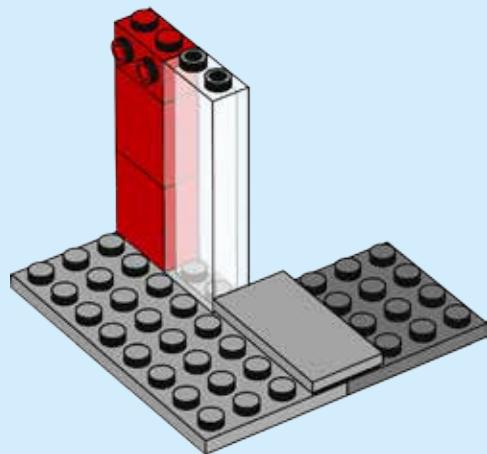

6

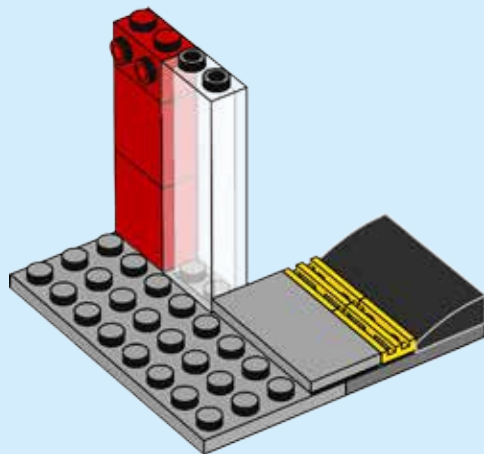

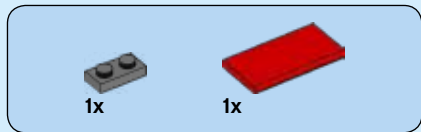

7

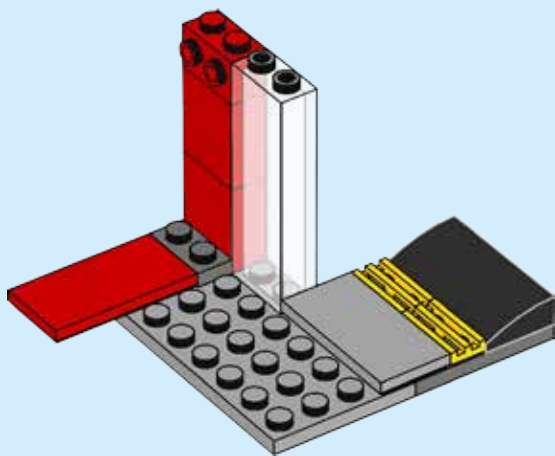

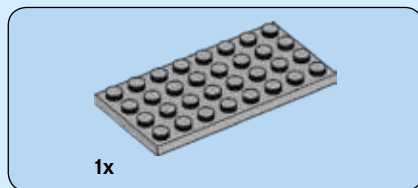

8

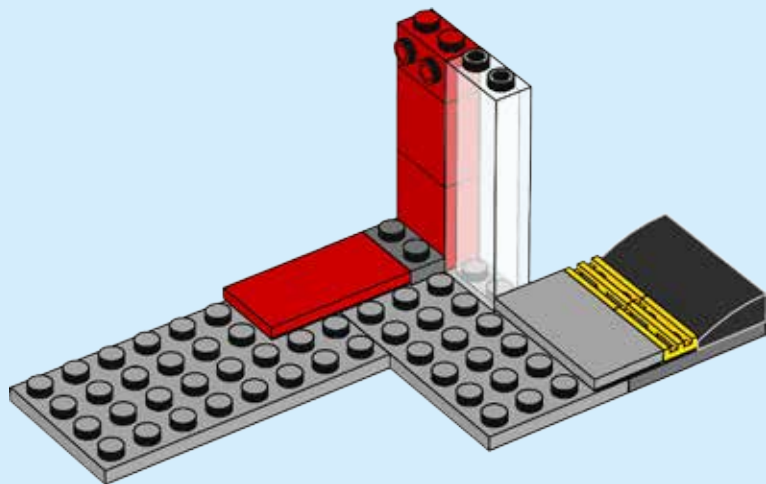



1x

9

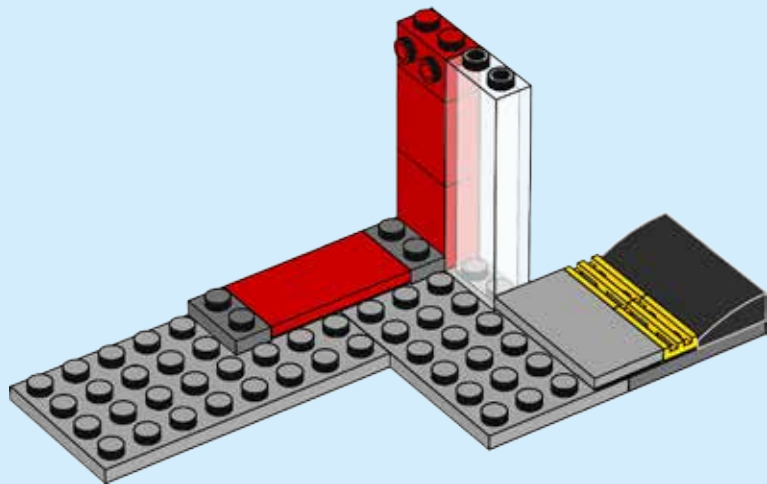



10

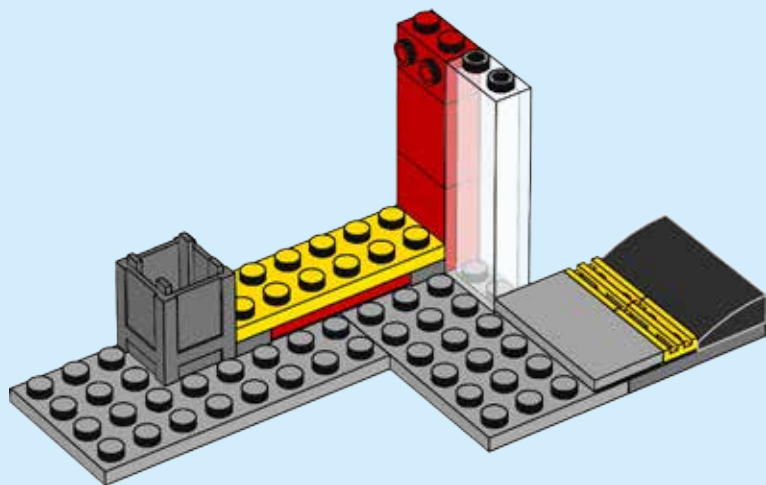



1x

# 11

1



2

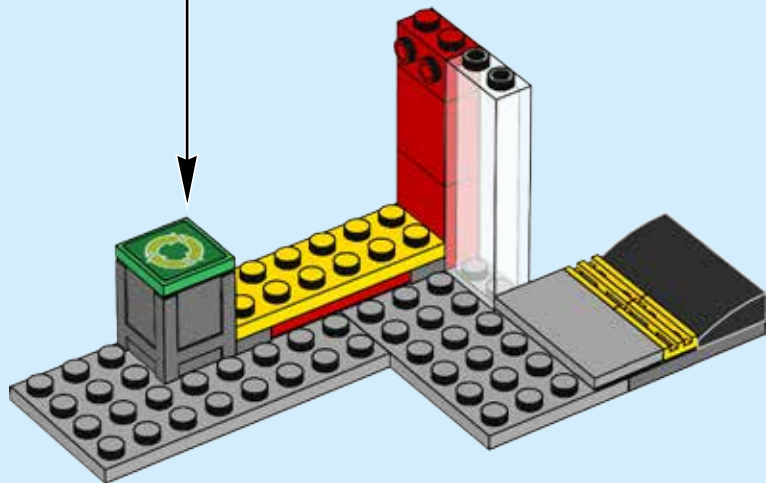
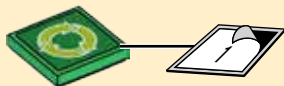



12

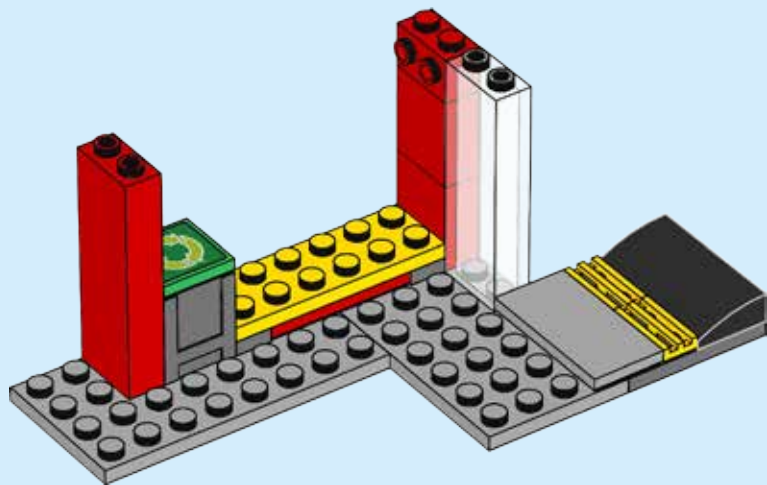

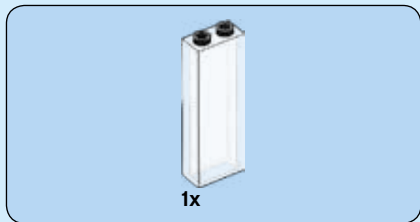

13

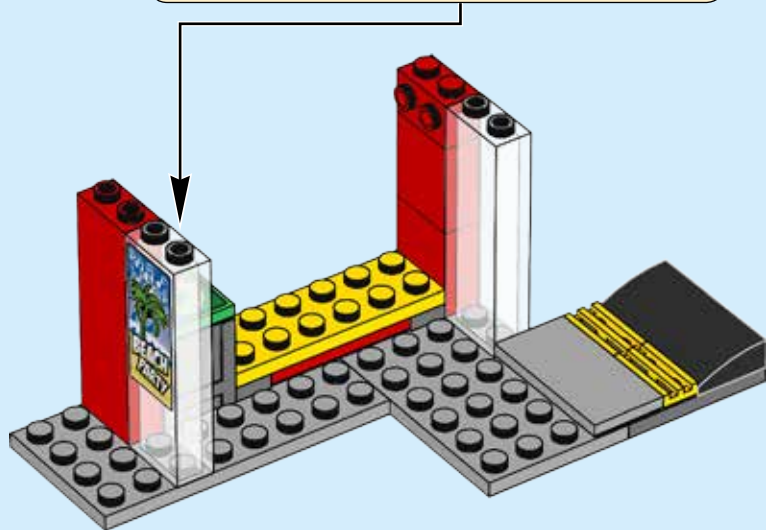
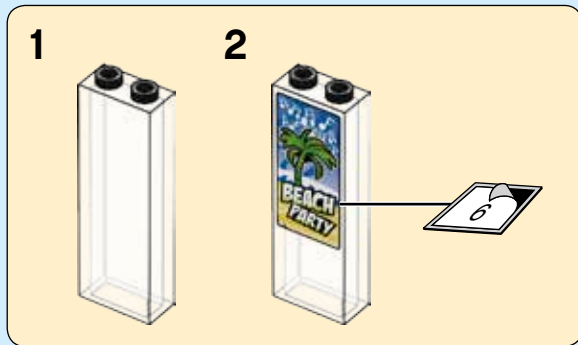





2x

14

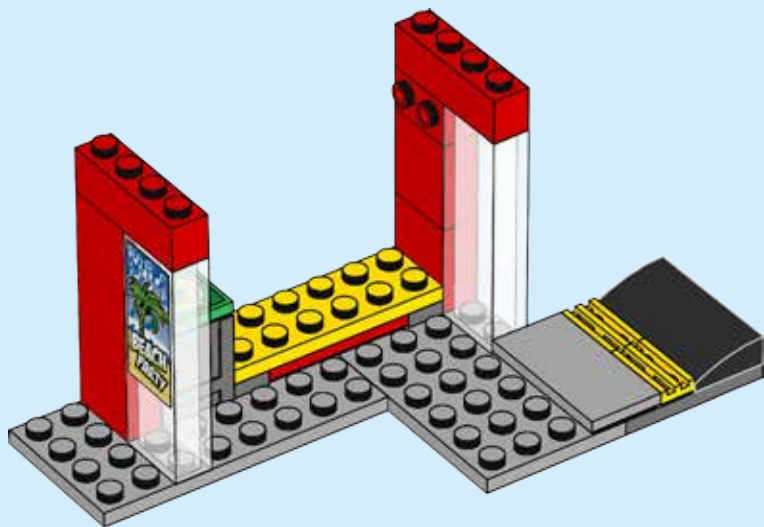



1x

15

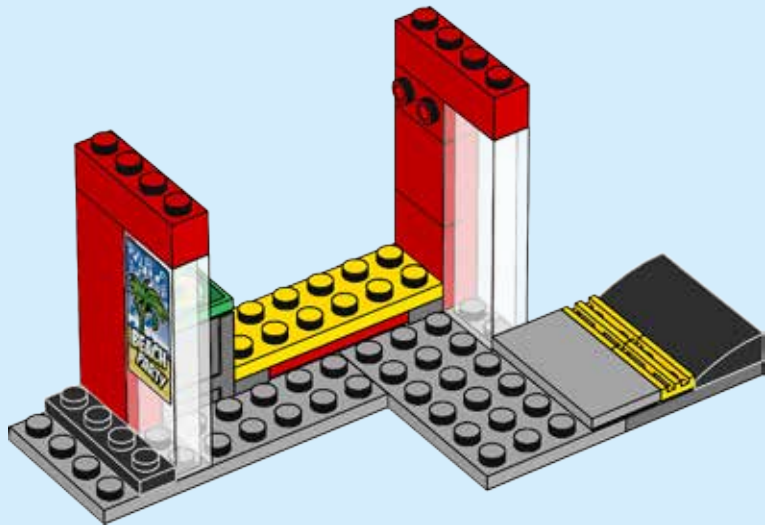



1x

16

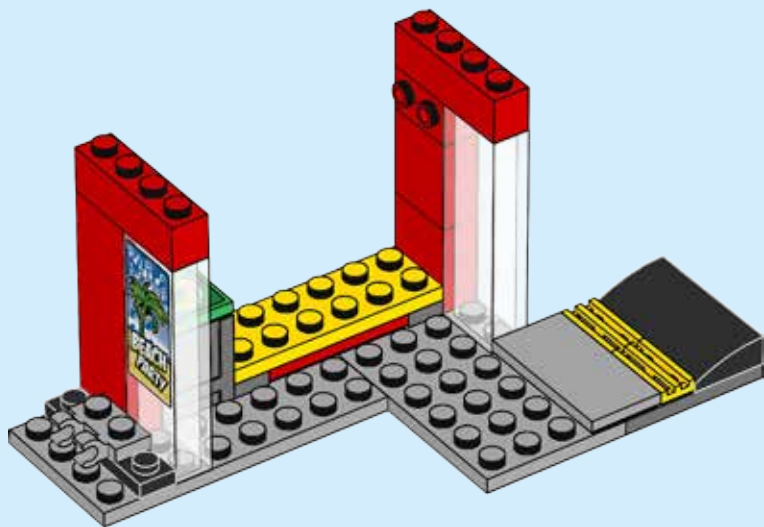



1x

17

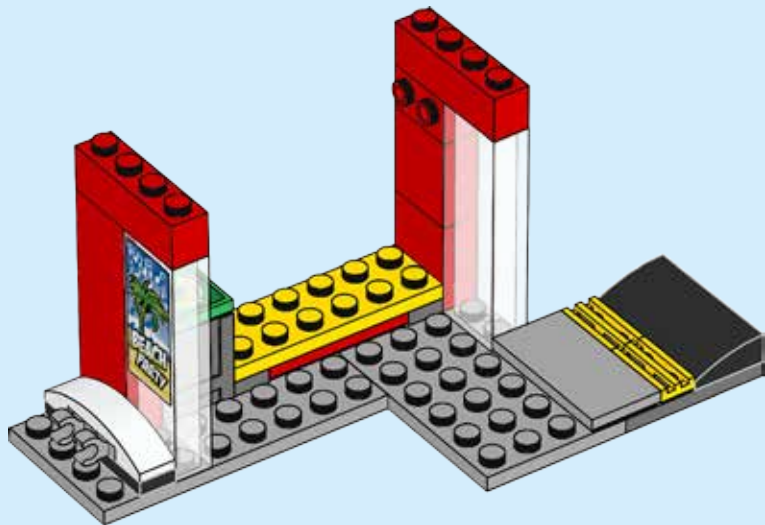

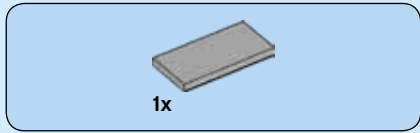

18

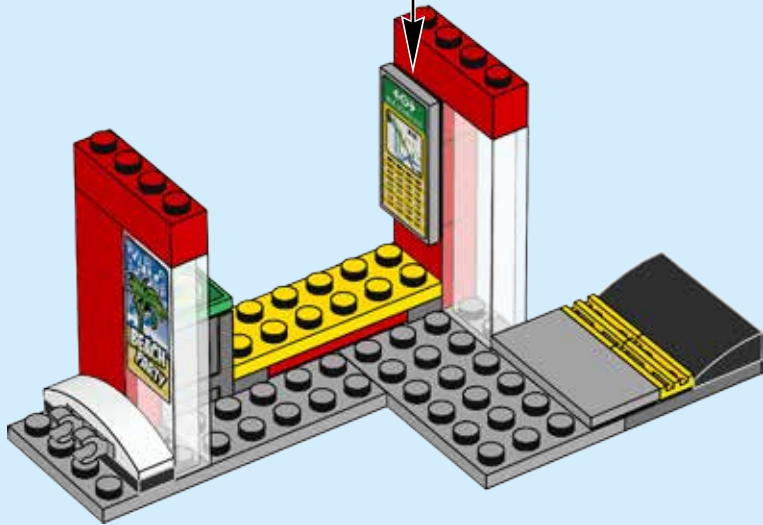
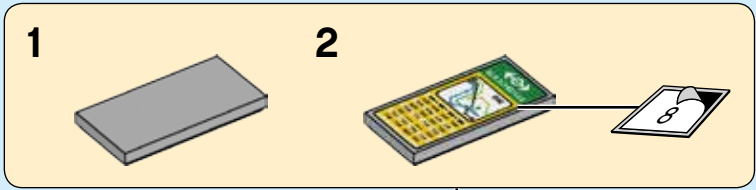



2x



3x



1x

# 19

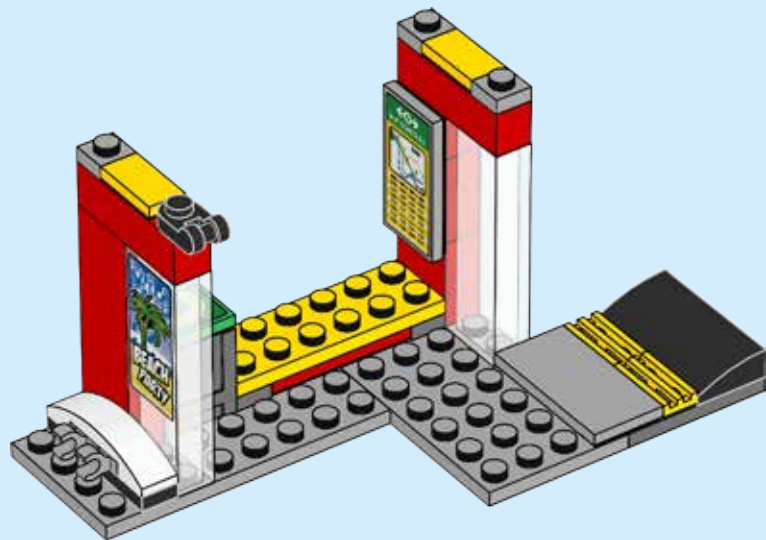

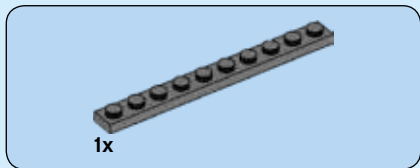

1x

20

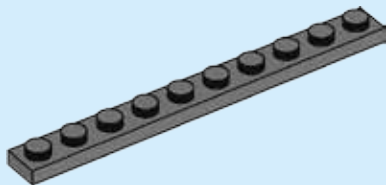

2x

21

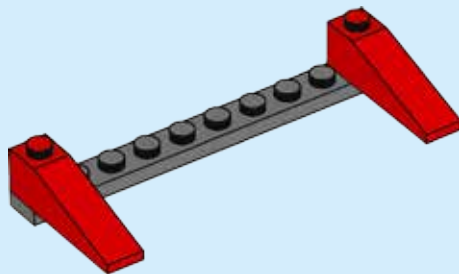

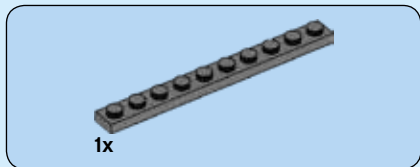

22

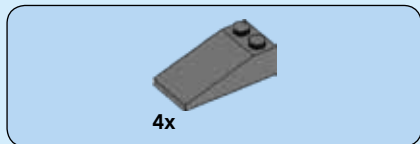
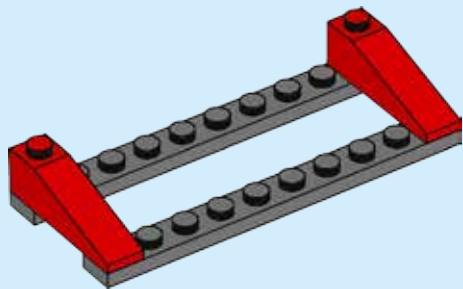

23

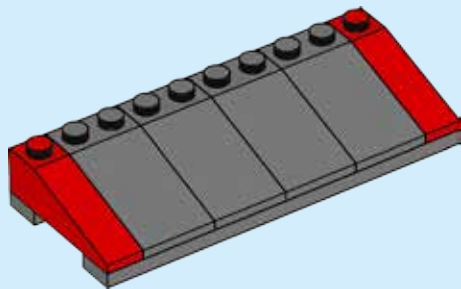



24

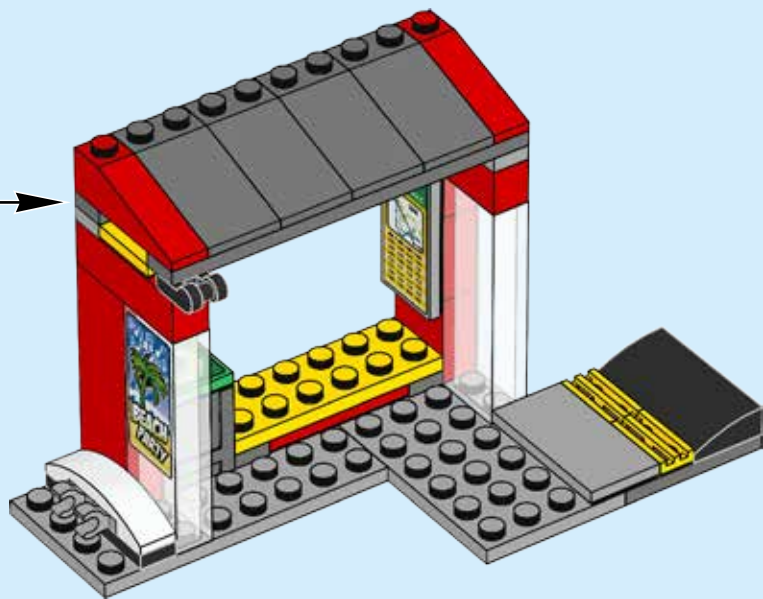



1x

25

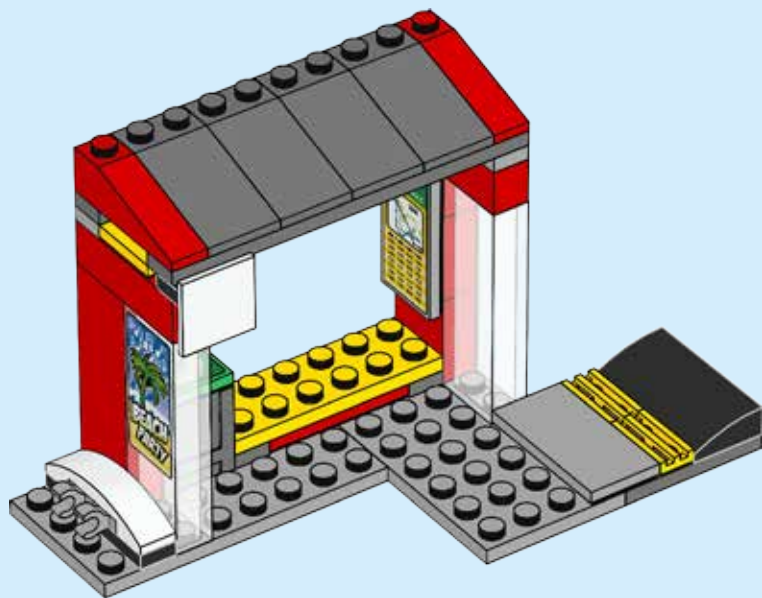

26

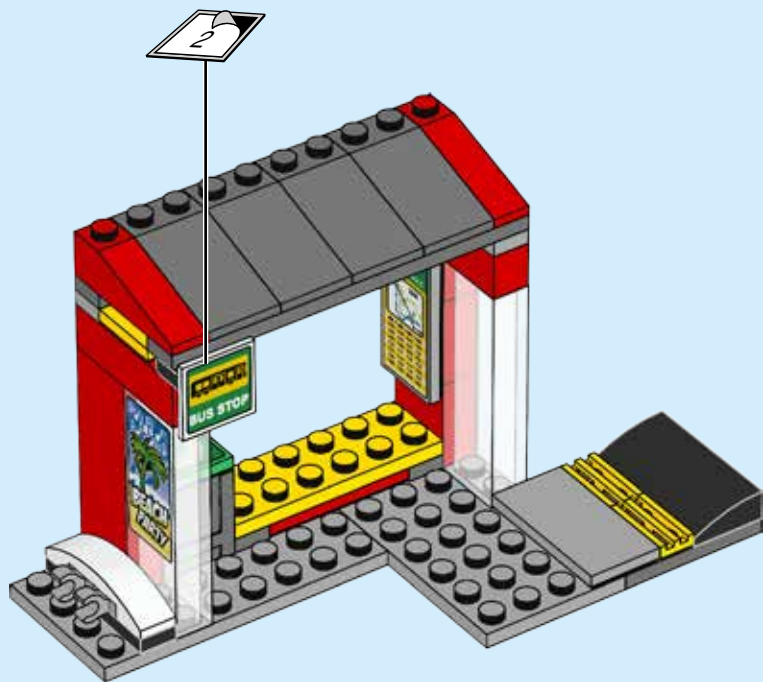



1x

27

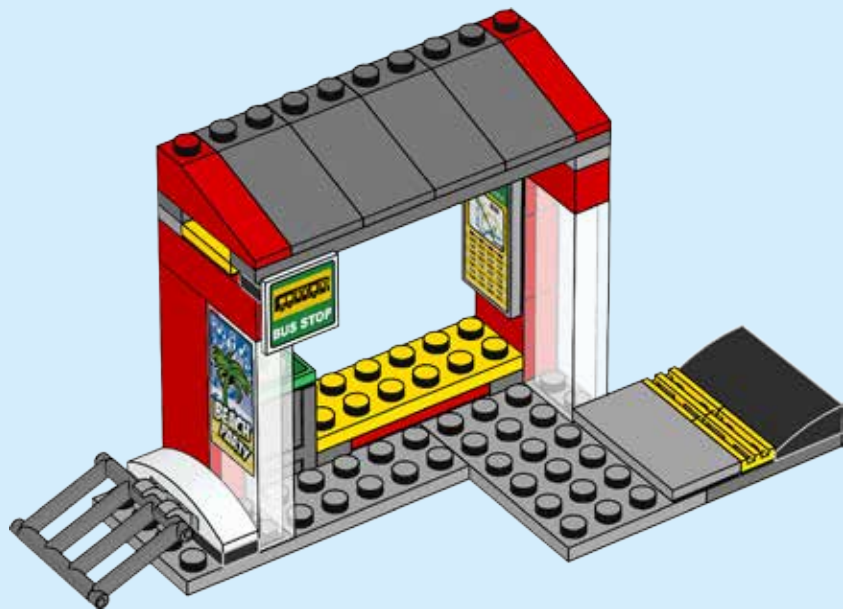

44

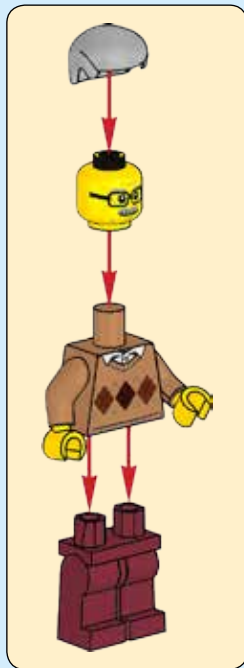
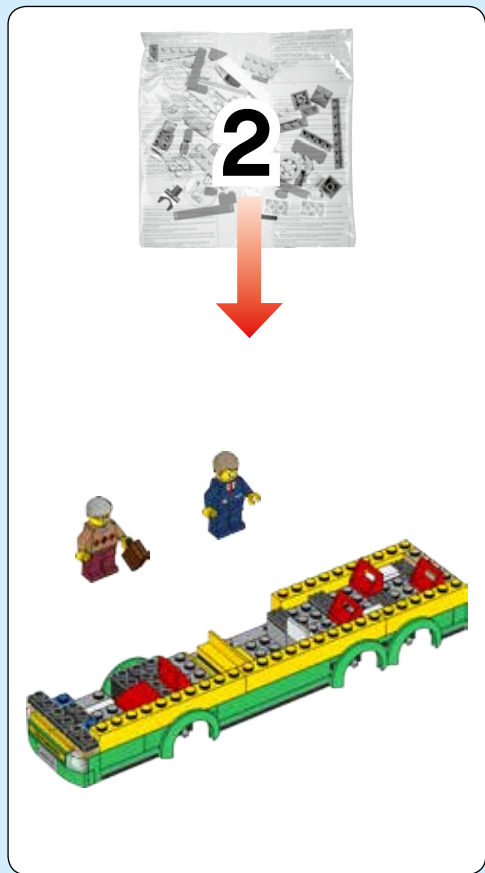

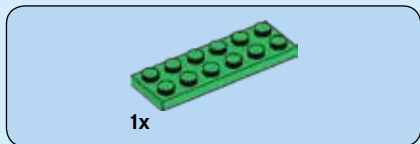

1

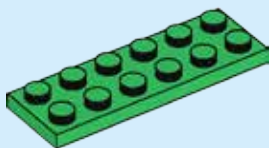



1x

2

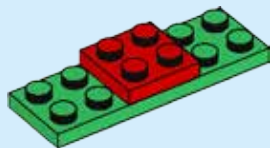

4x

3

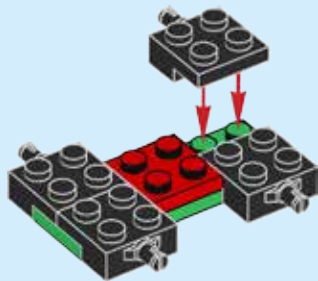

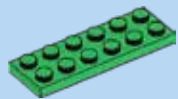

1x

4

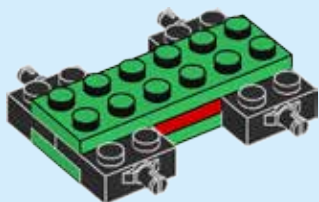



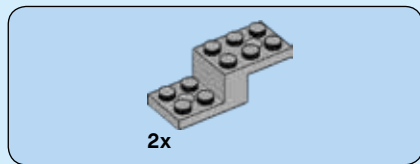

5

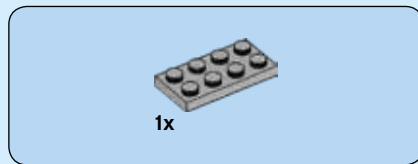
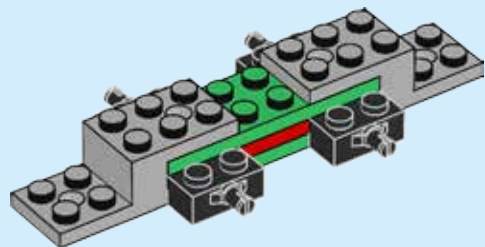

6

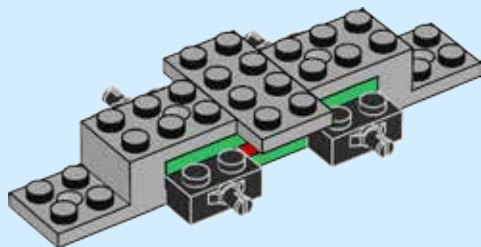

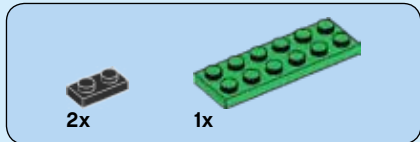

7

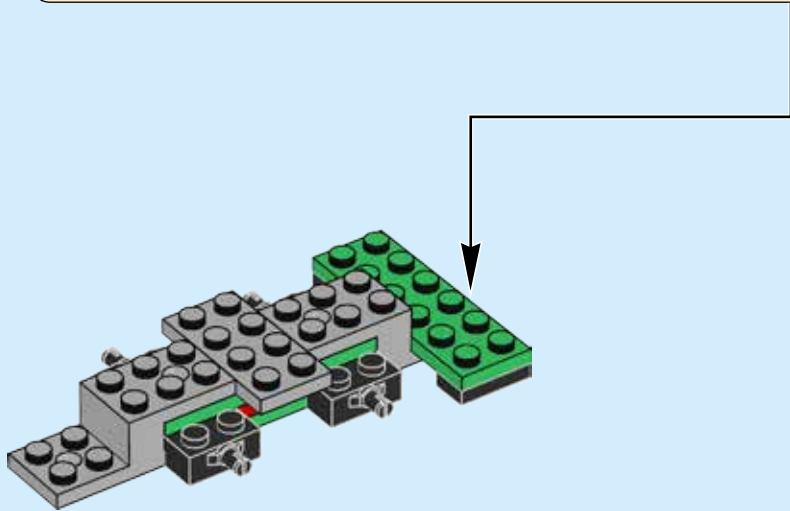
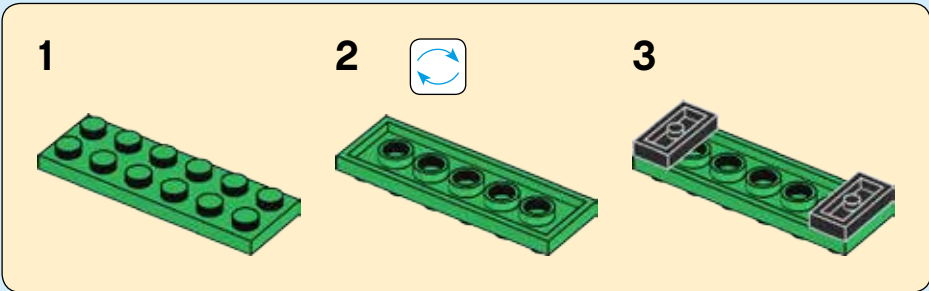

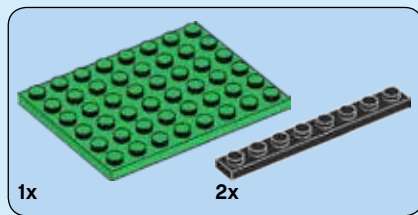

8

1

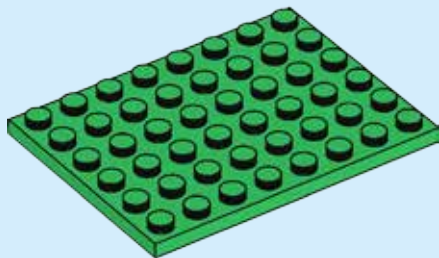

2

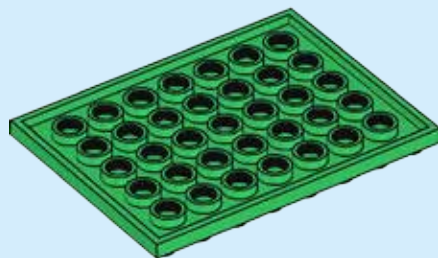
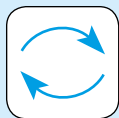

3

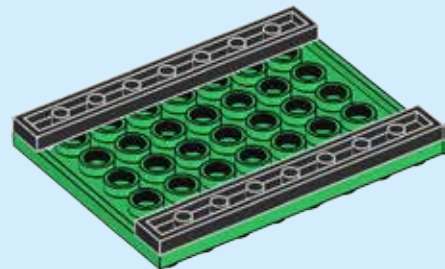

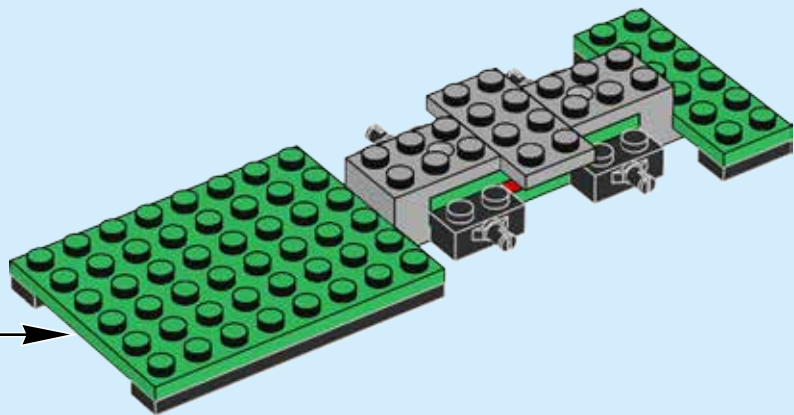

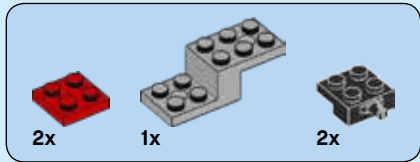

9

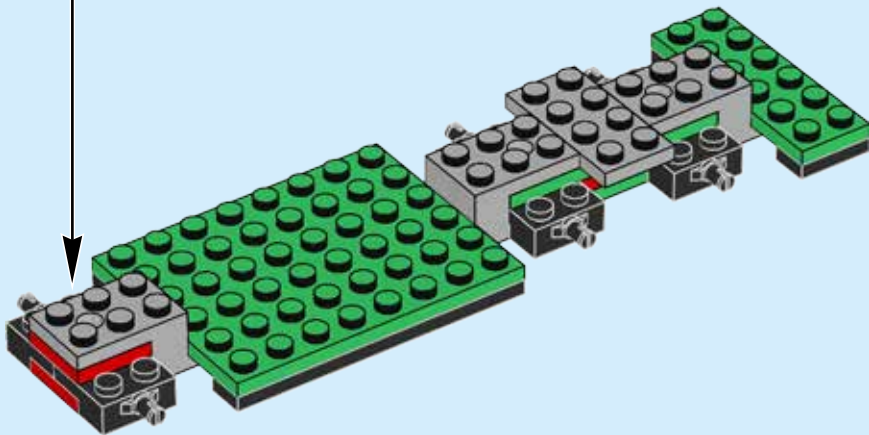
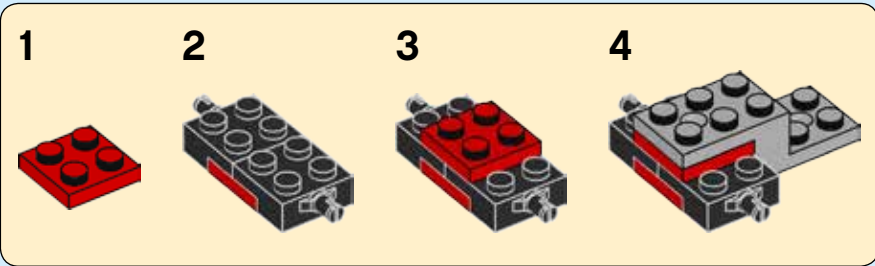



2x



1x

# 10

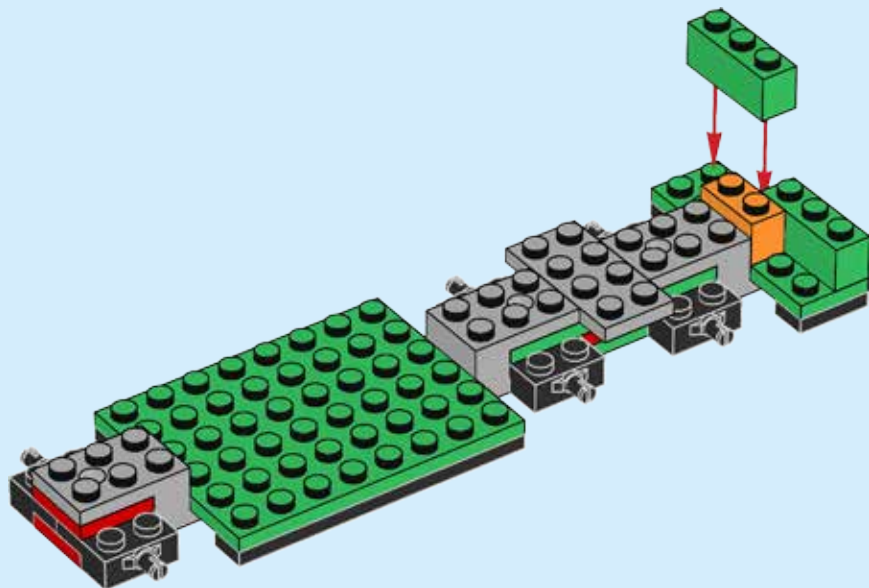



2x

11

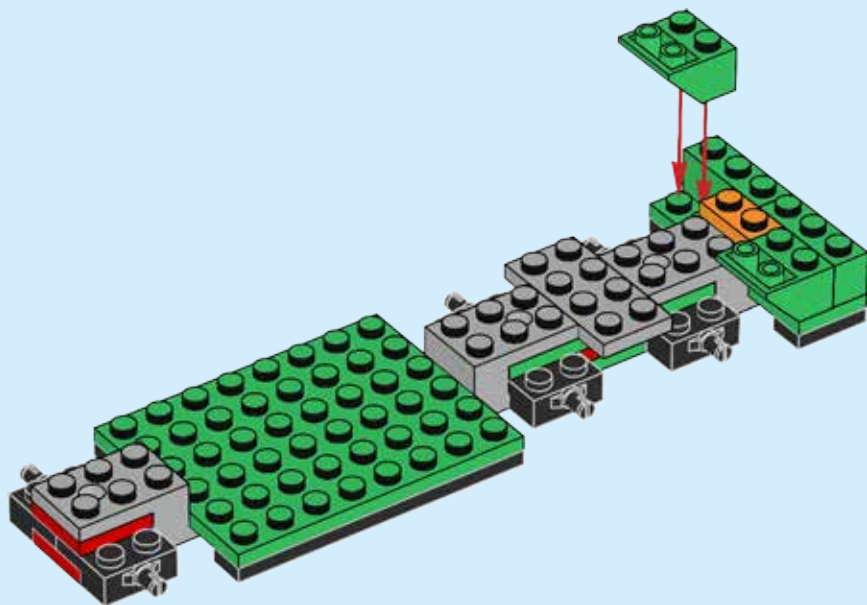



2x

12

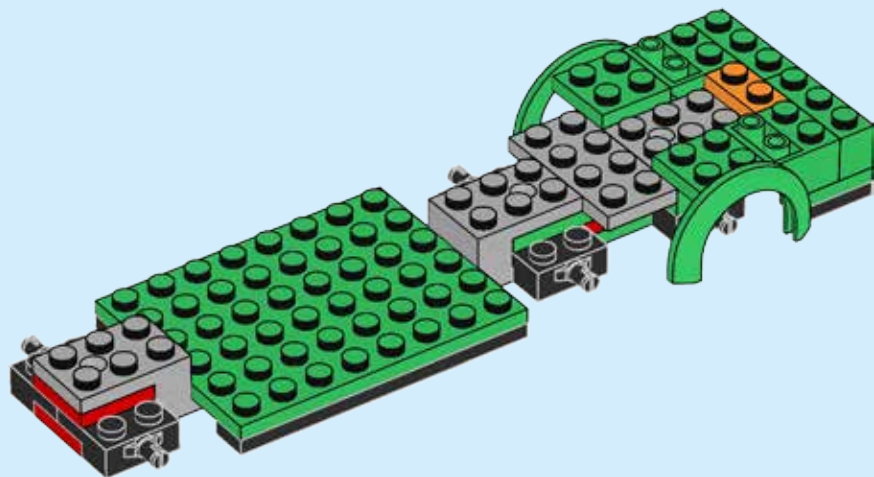



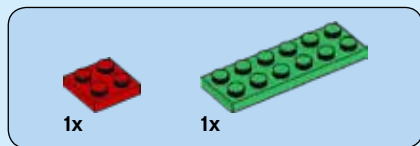

13

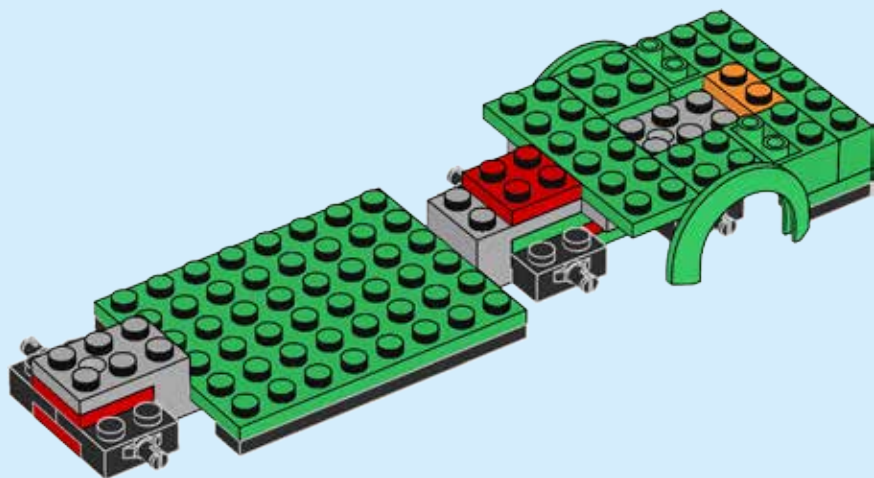



2x

14

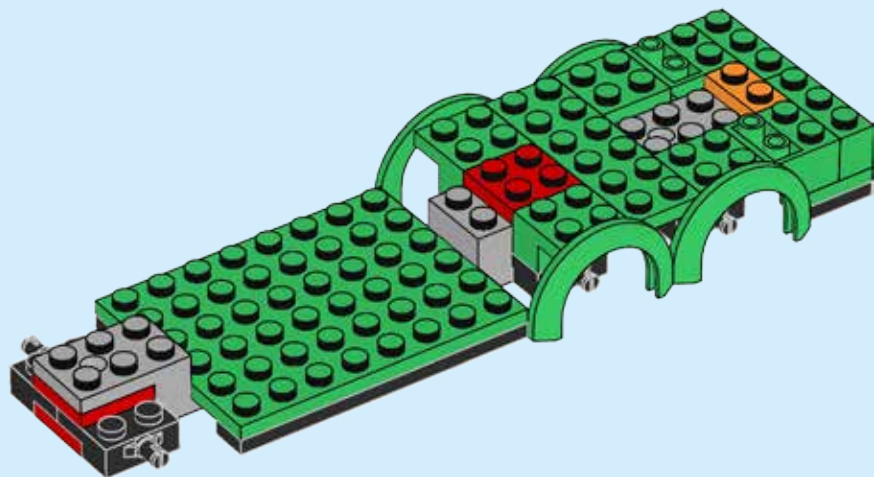

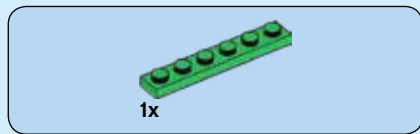

15

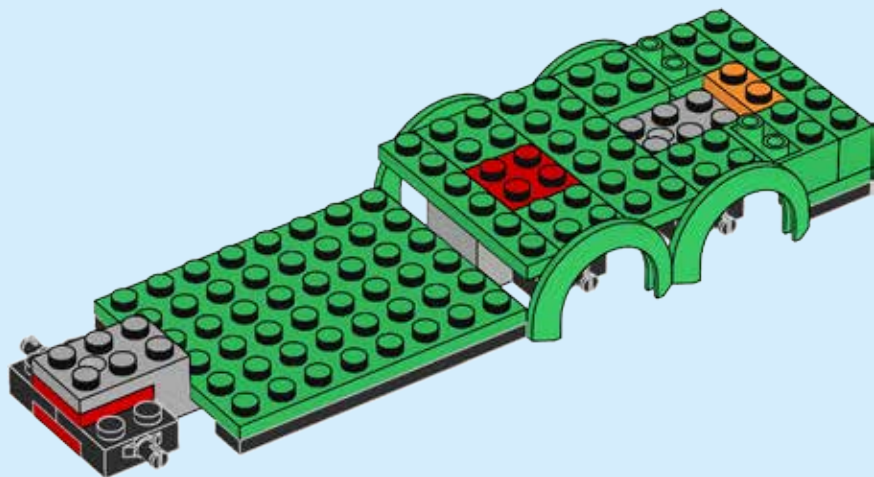

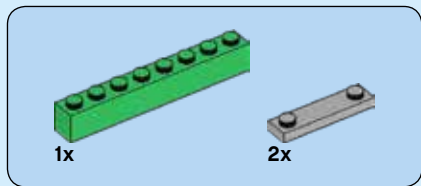

16

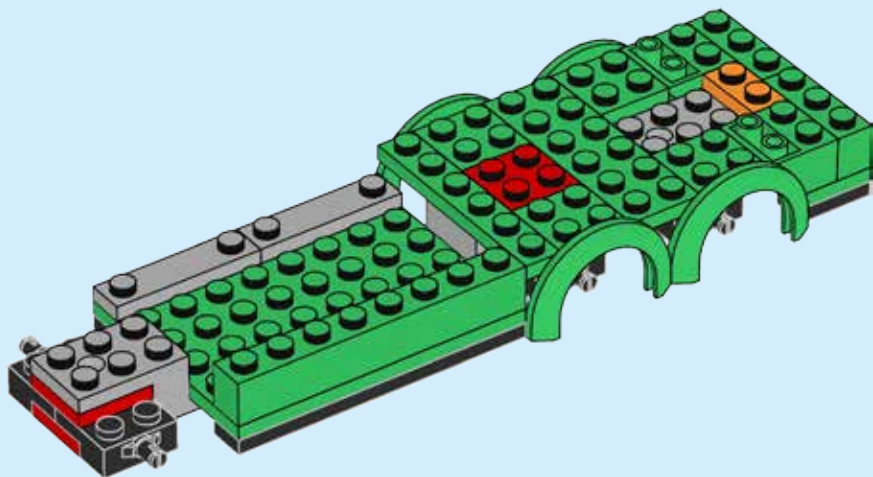

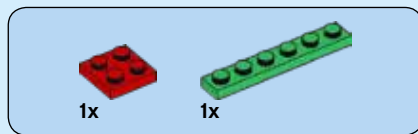

17

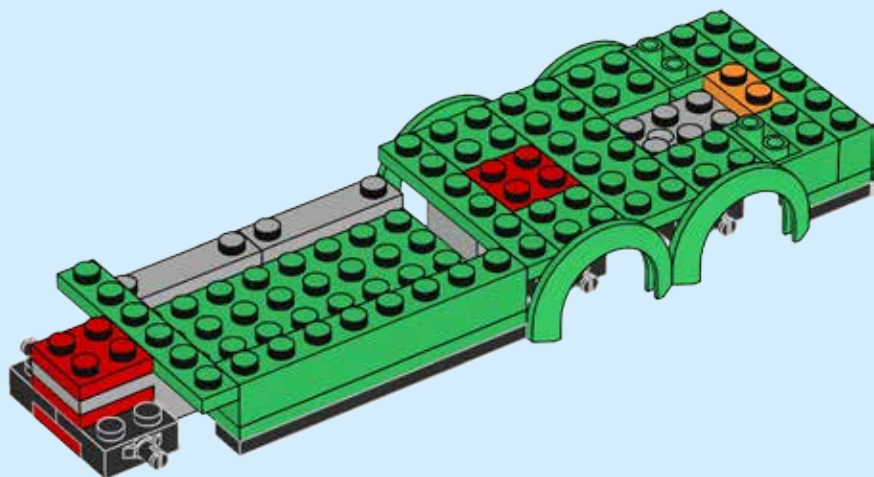



2x

18

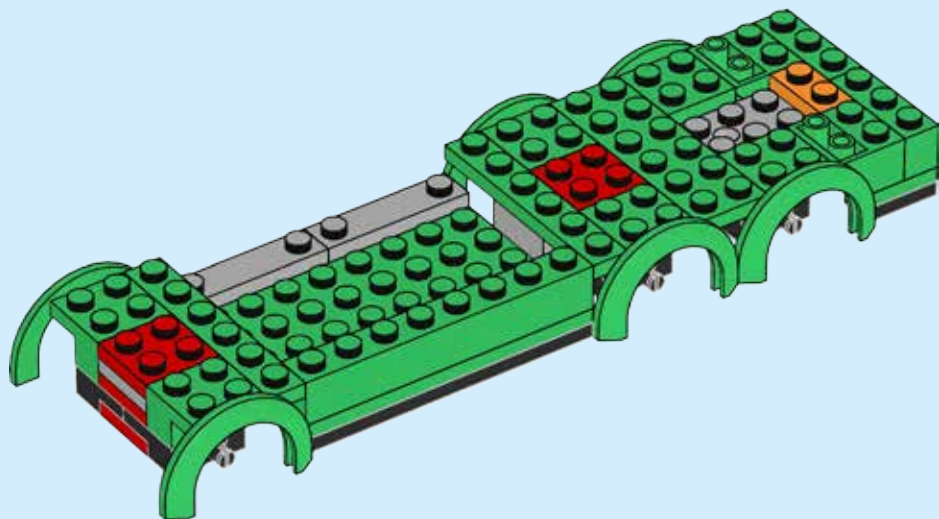

62

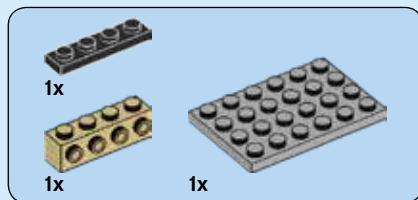

19

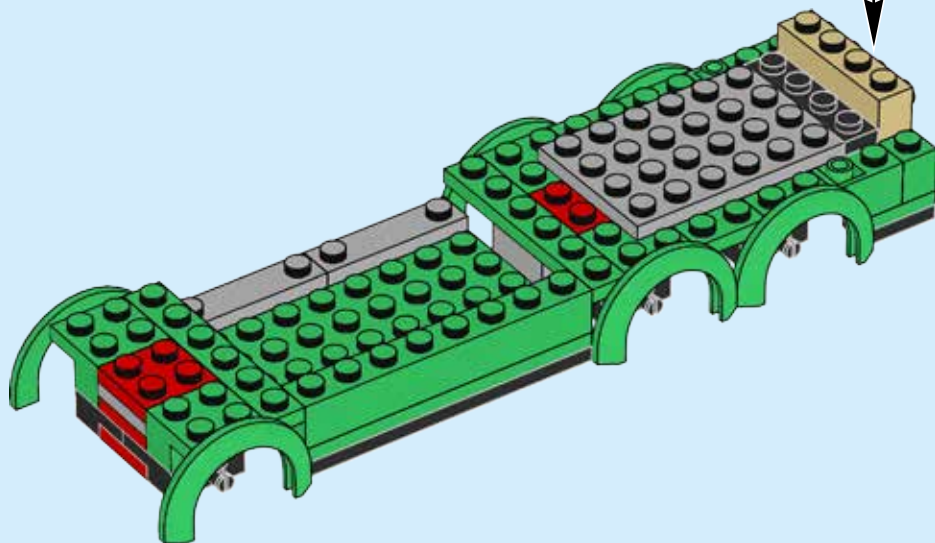
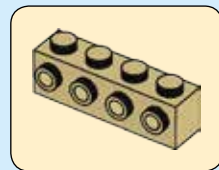



1x



1x



1x

# 20

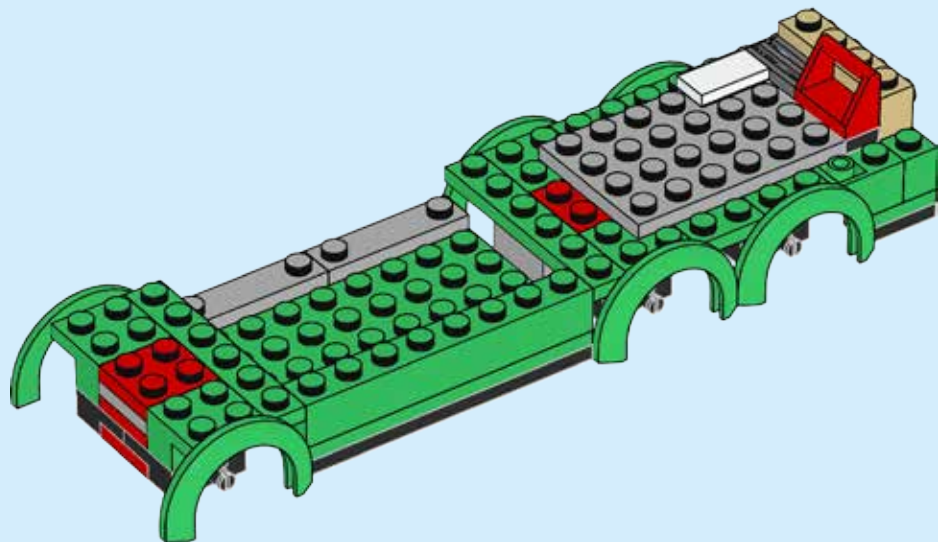





1x



1x



1x

# 21

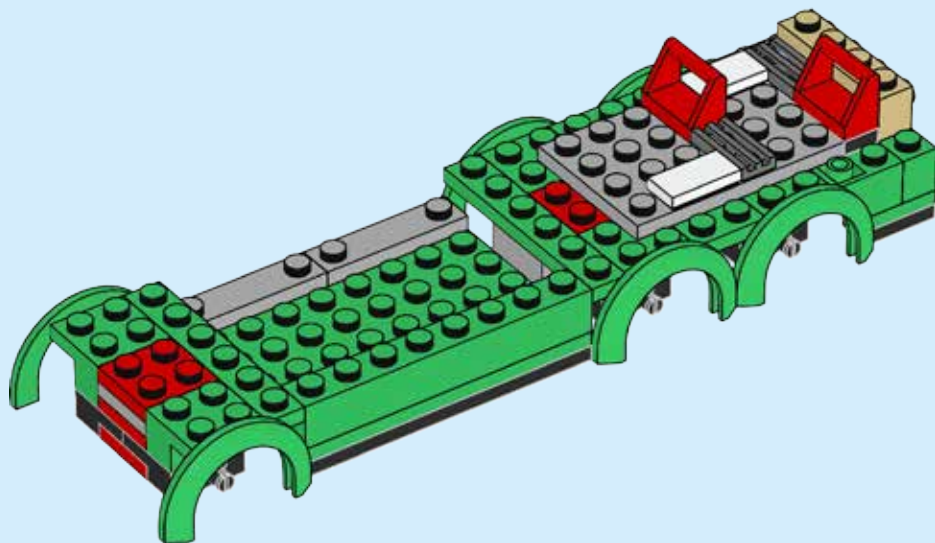



1x



1x

22

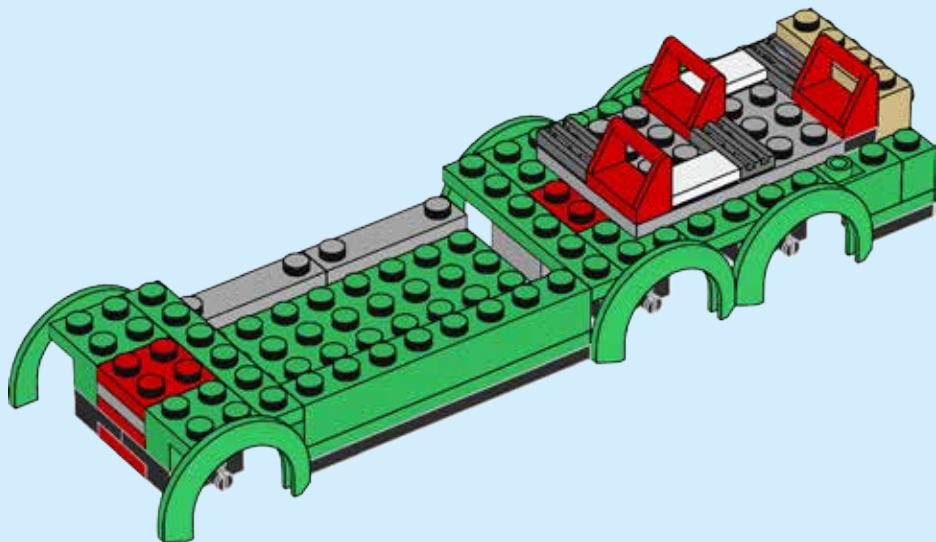

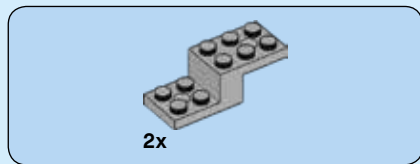

23

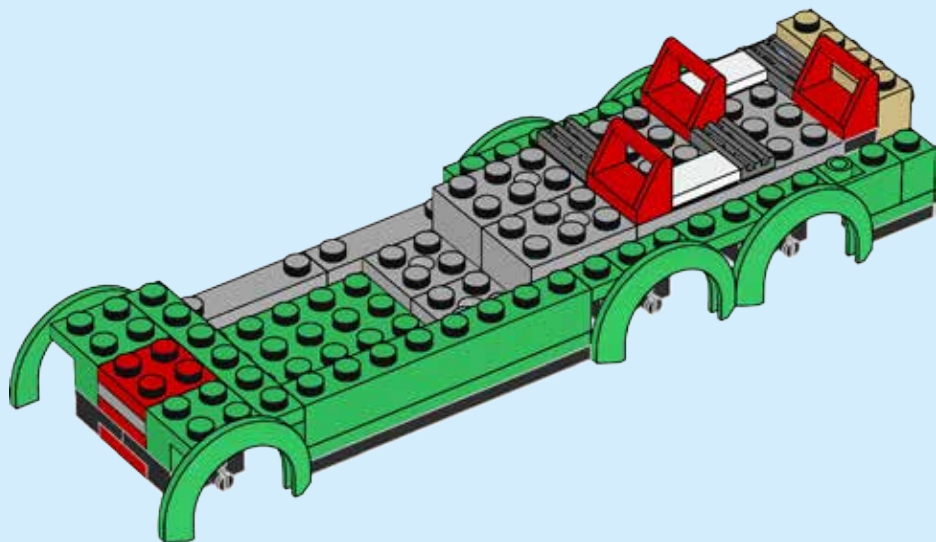

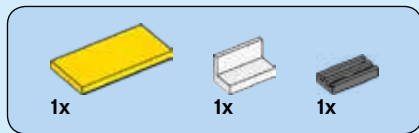

24

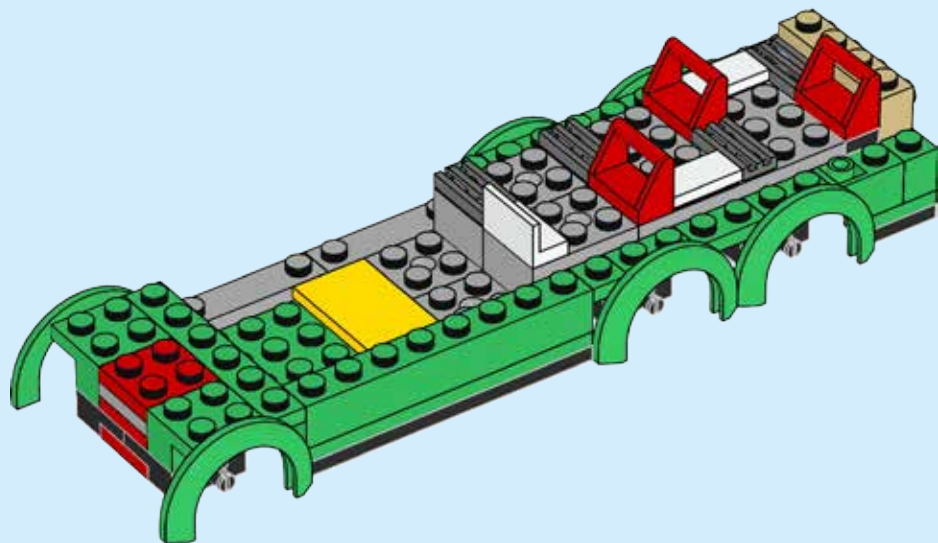

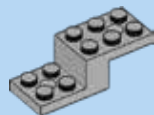

2x

25

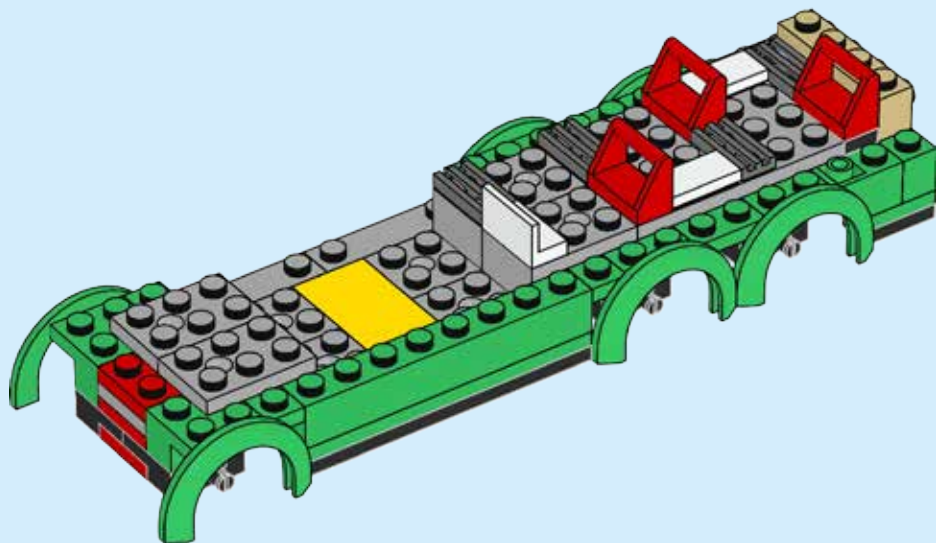

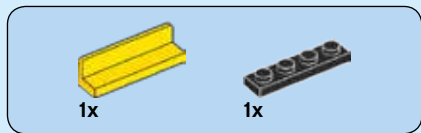

26

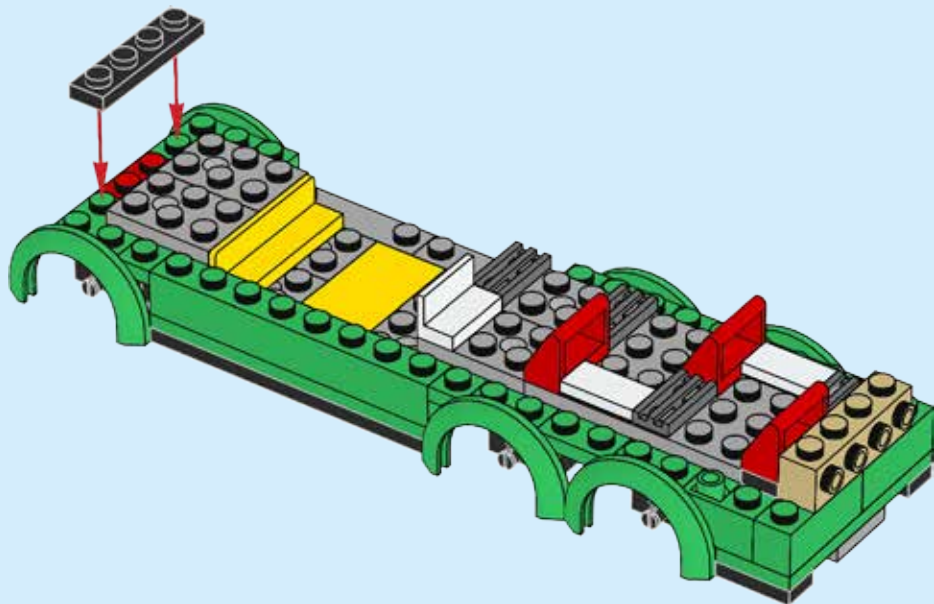



27

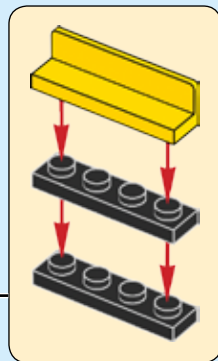
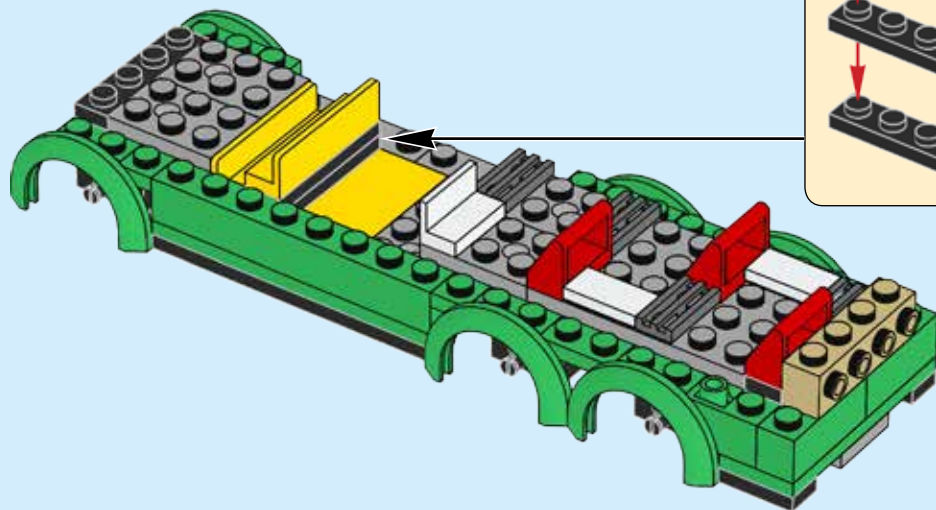

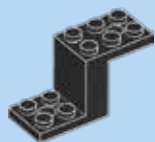

2x

28

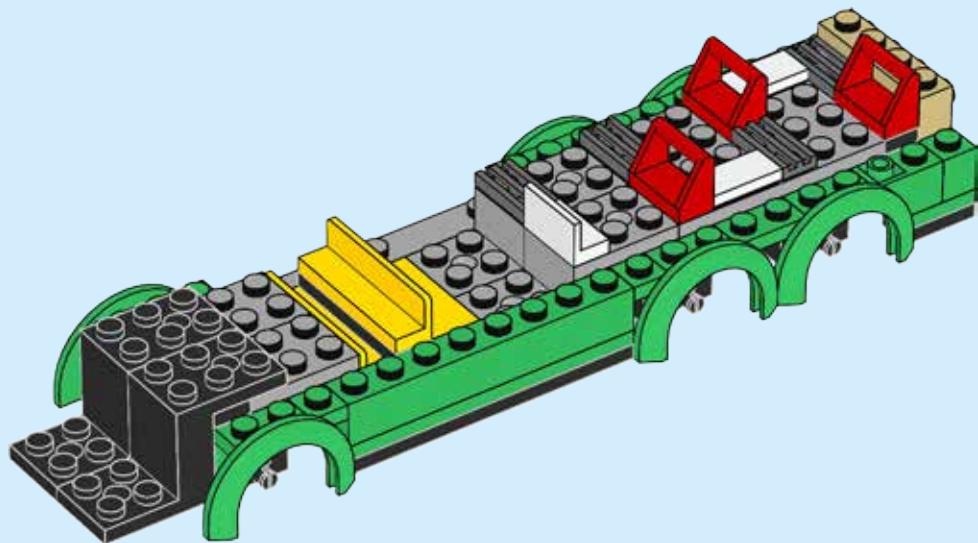





1x

29

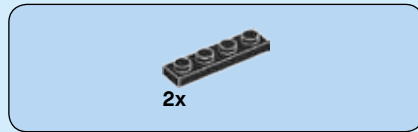
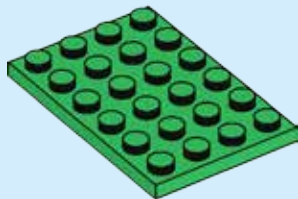

2x

30

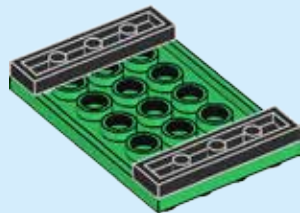
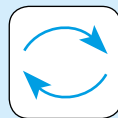



2x

# 31

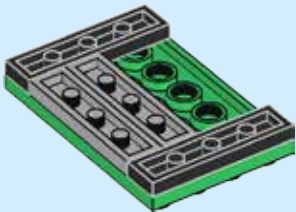

74



2x



1x

# 32

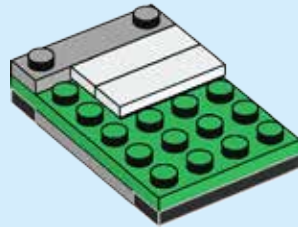
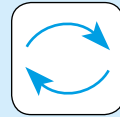

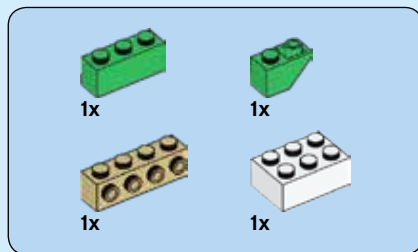

33

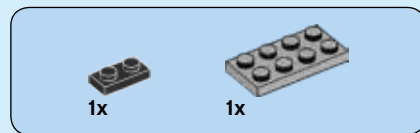
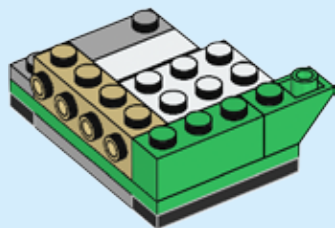

34

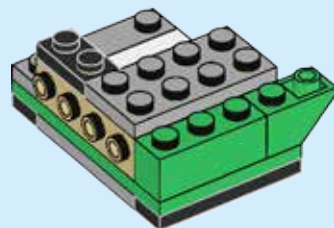

35

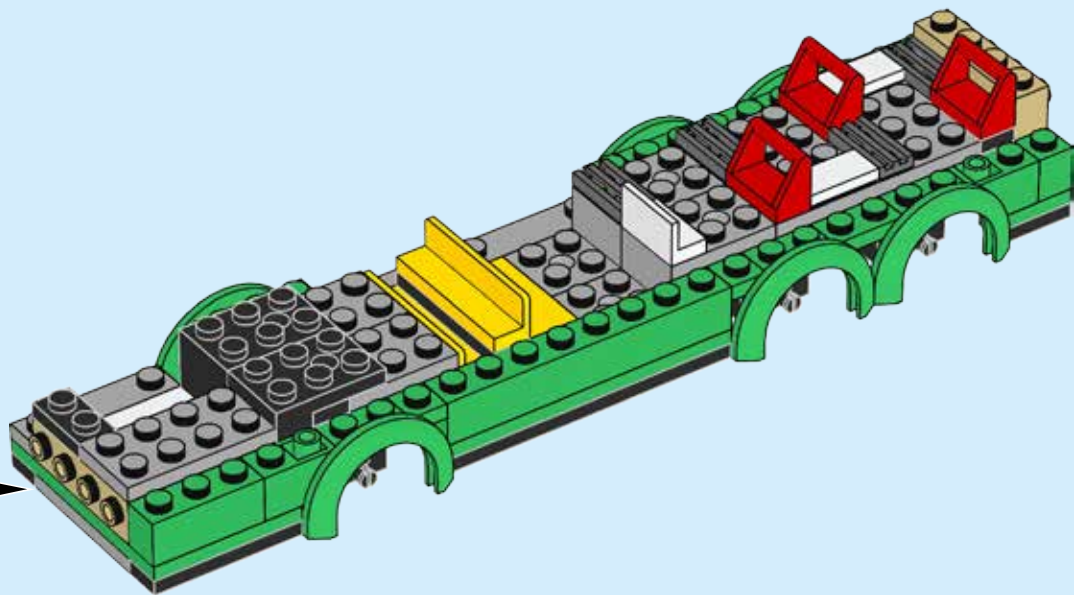

76

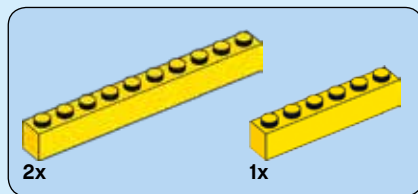

36

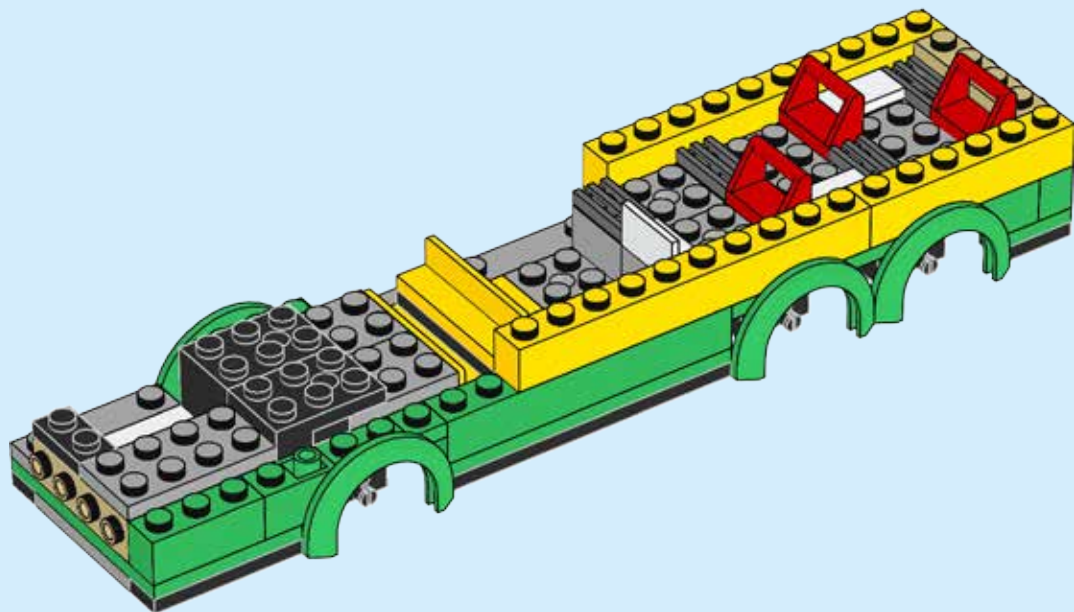



1x



1x



2x

# 37

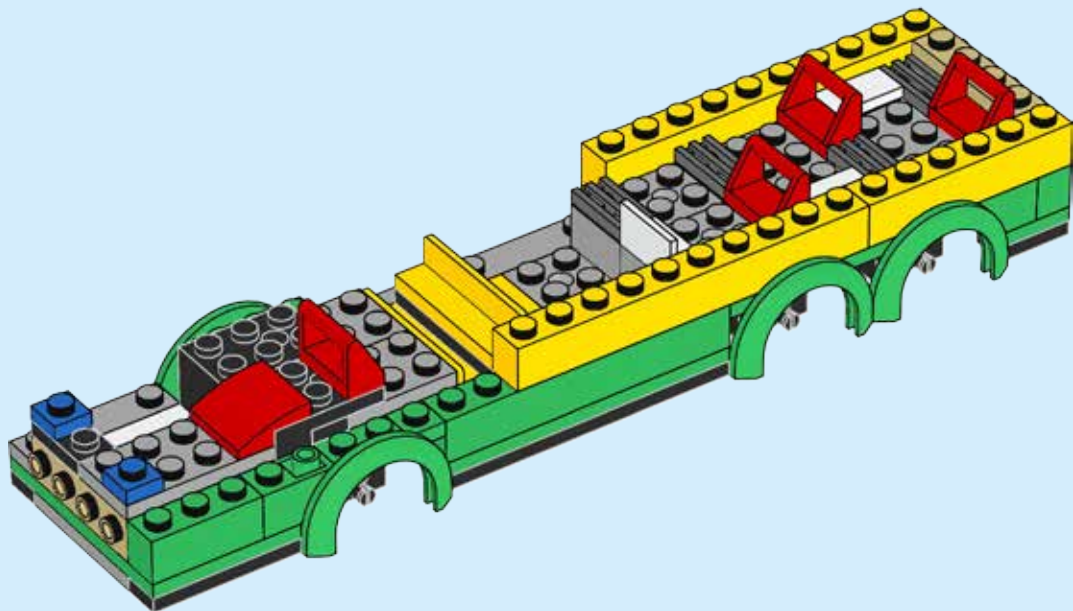

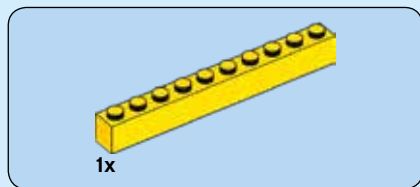

38

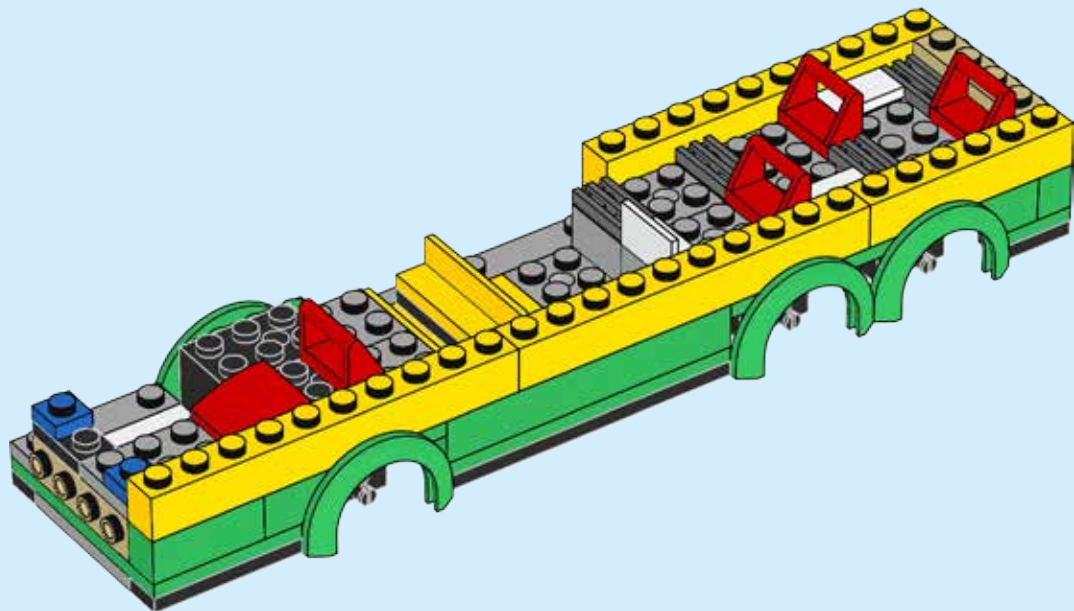

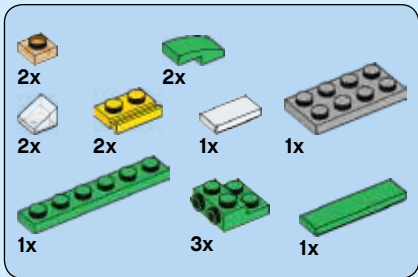

**39**

**1**

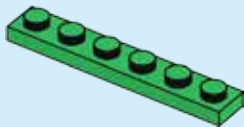

**2**

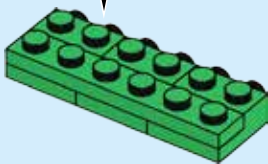
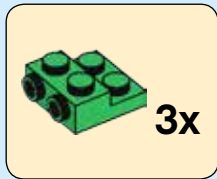

**3**

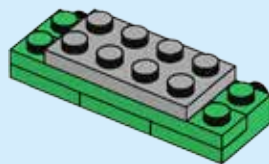



4

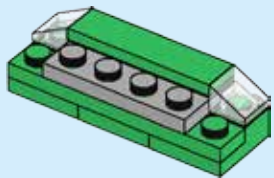

5

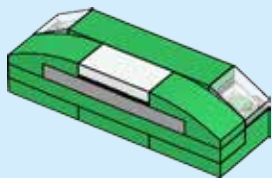

6

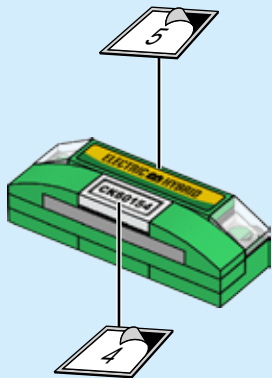

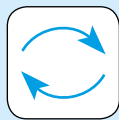

7

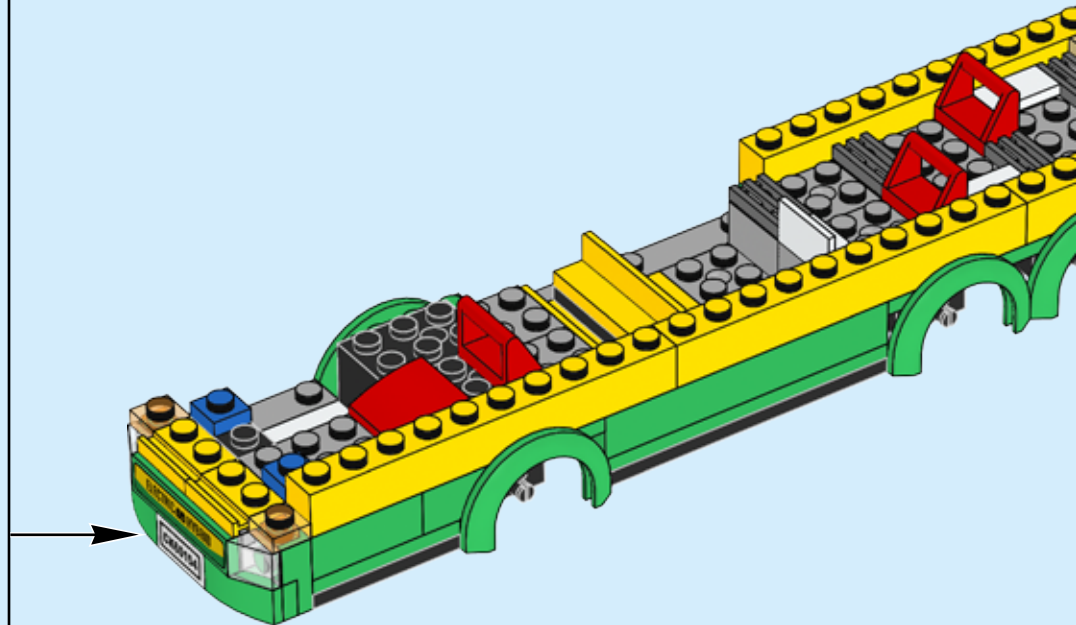
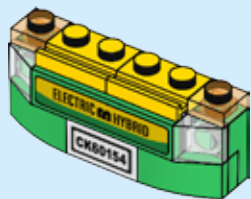



1x



2x

# 40

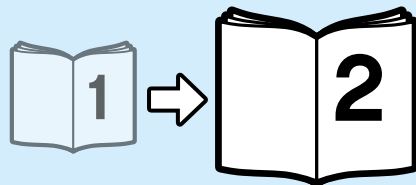
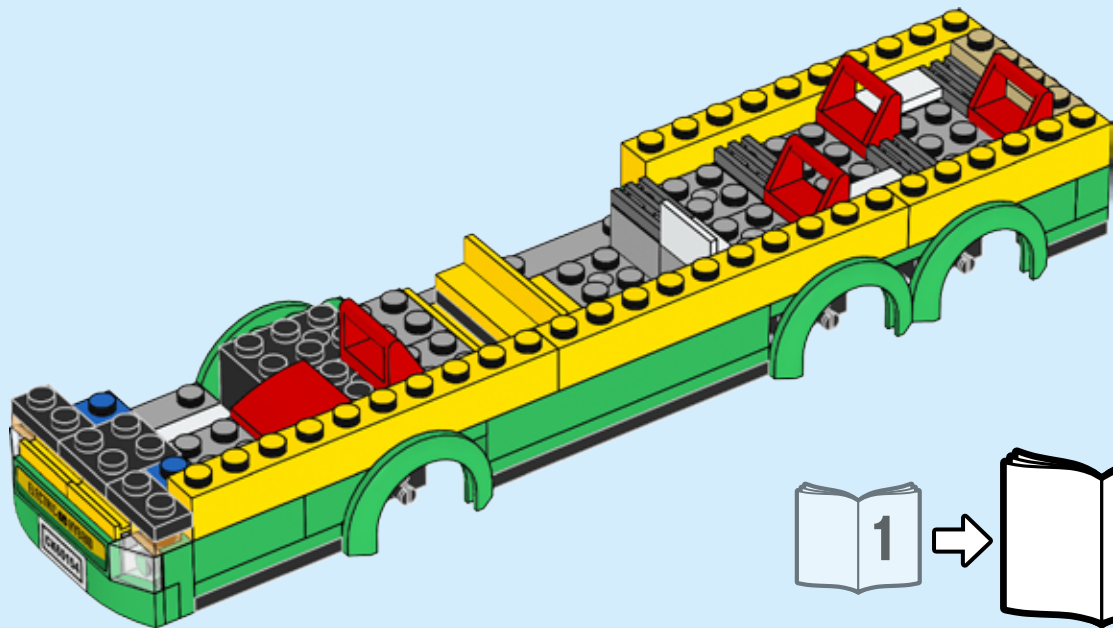

# WIN

GO TO [WWW.LEGO.COM/PRODUCTFEEDBACK](http://WWW.LEGO.COM/PRODUCTFEEDBACK) AND  
GIVE US YOUR SHORT **FEEDBACK** ABOUT THIS  
LEGO® SET FOR A CHANCE TO WIN  
A COOL LEGO PRIZE.

Terms & Conditions apply



## [LEGO.com/productfeedback](http://LEGO.com/productfeedback)

### GEWINNE

Erzähle uns auf  
[www.LEGO.com/productfeedback](http://www.LEGO.com/productfeedback)

etwas über die Erfahrungen, die du mit  
diesem LEGO® Set gemacht hast, und  
sichere dir die Chance auf einen coolen  
LEGO Preis!

Es gelten die Teilnahmebedingungen

### GAGNE

Rends-toi sur  
[www.LEGO.com/productfeedback](http://www.LEGO.com/productfeedback)

et donne-nous quelques commentaires sur  
ce produit LEGO® pour avoir une chance  
de gagner un prix LEGO !

Voir Conditions Générales

### GANAN

Visita  
[www.LEGO.com/productfeedback](http://www.LEGO.com/productfeedback)

y envíanos tu opinión acerca de este set  
LEGO®. ¡Participarás en el sorteo de un  
premio LEGO!

Términos y Condiciones aplicables

### 获取奖品

登录  
[www.LEGO.com/productfeedback](http://www.LEGO.com/productfeedback)

给出关于此乐高®套装的简短反馈，  
就有机会获得炫酷乐高奖品

《条款及条件》适用

LEGO and the LEGO logo are trademarks of the LEGO Group. ©2017 The LEGO Group.

6203741