



CITY

60068

 [LEGO.com/city](https://www.lego.com/city)



WARNING: CHOKING HAZARD.
Small parts. Not for children under 3 years.

1



2



3



4



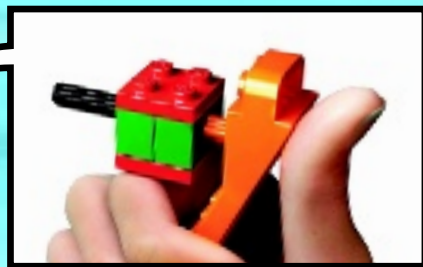

LEGO.com/brickseparator



AVERTISSEMENT : RISQUE D'ÉTOUFFEMENT.

Contient des petites pièces. Ne convient pas aux enfants de moins de 3 ans.



ADVERTENCIA: PELIGRO DE ASFIXIA.

No recomendado para niños menores de 3 años. Contiene piezas pequeñas.

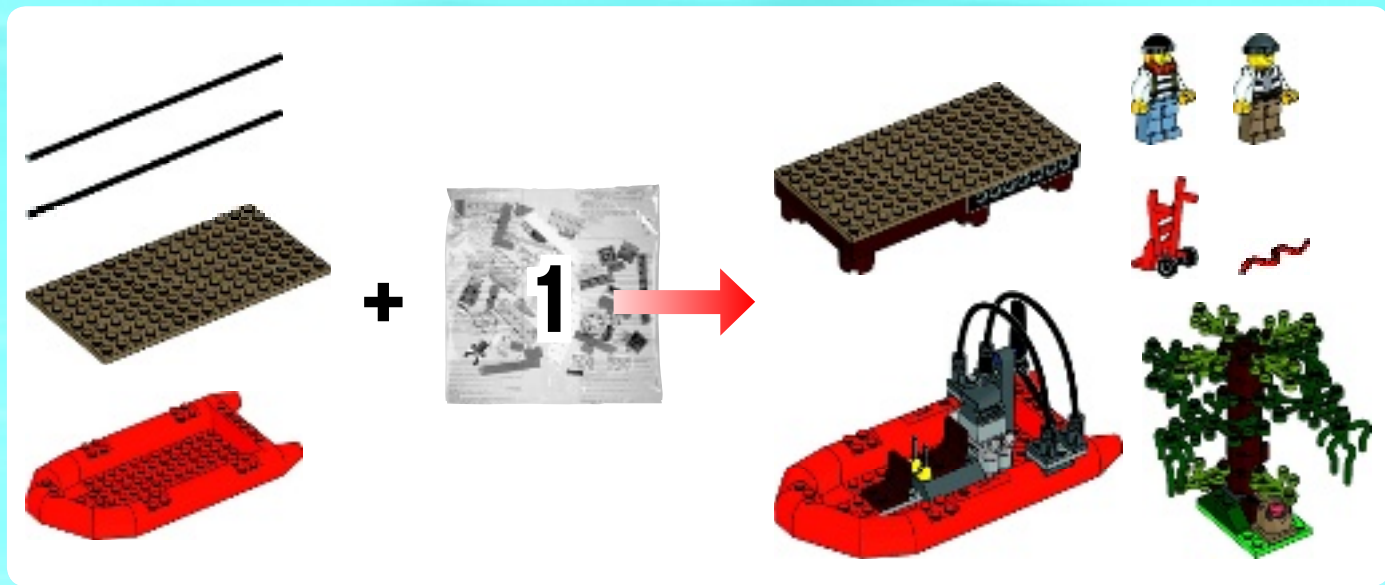

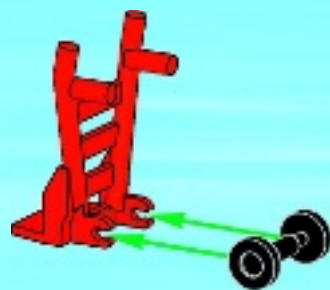

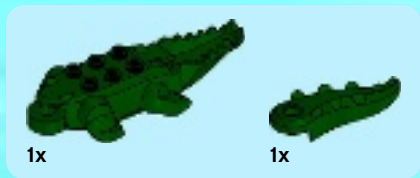

1

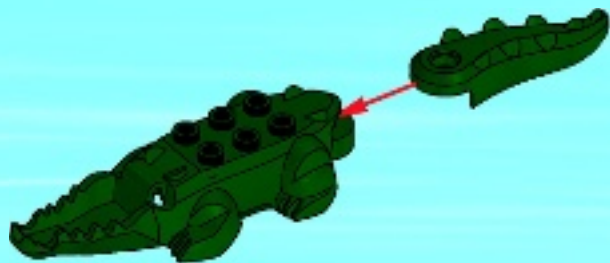



1x

2

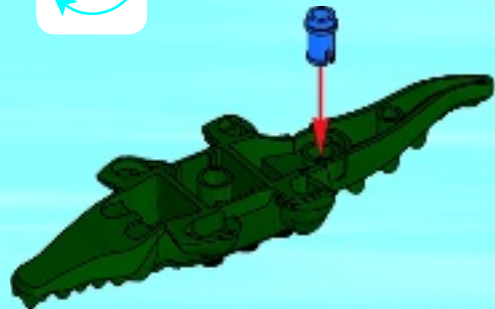

1x



1x

3



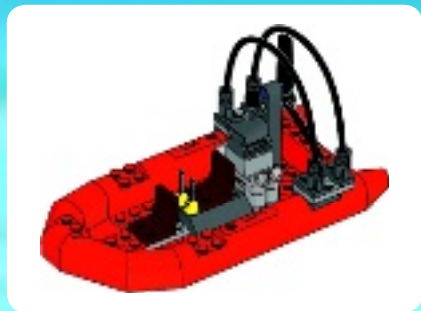

1

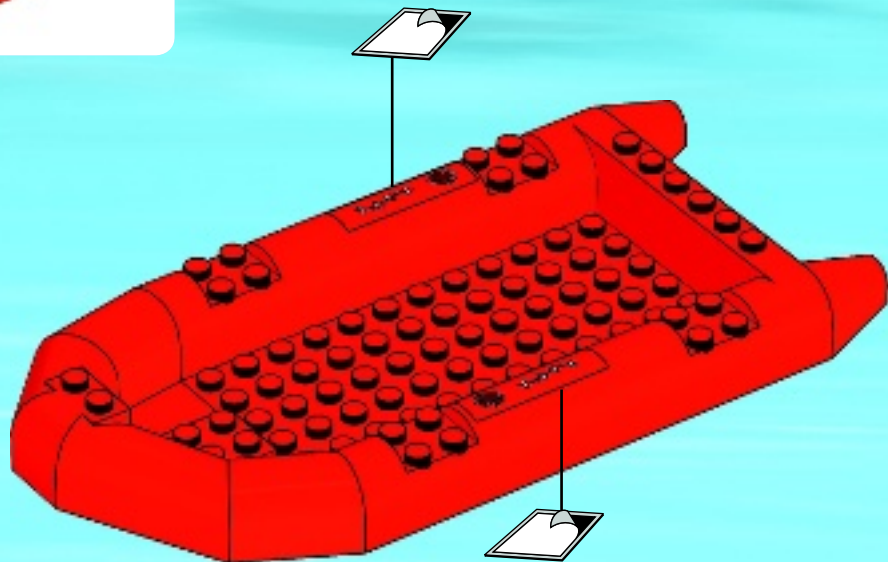

8



1x

2





2x

3





4

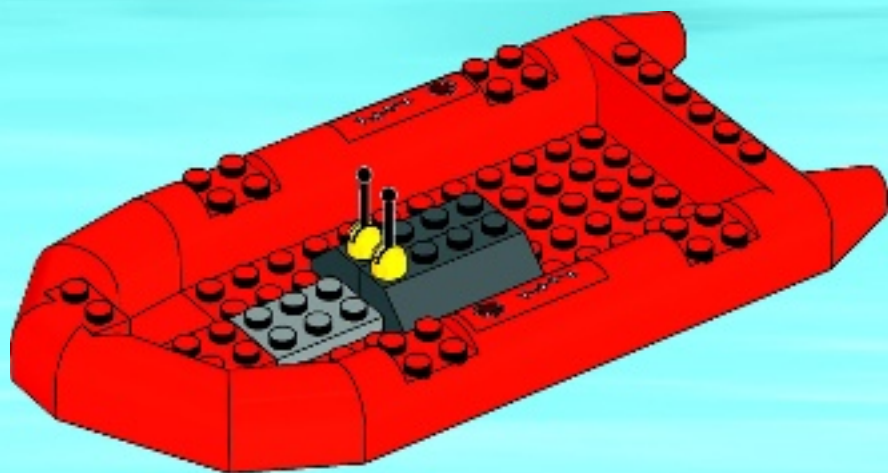



2x

5

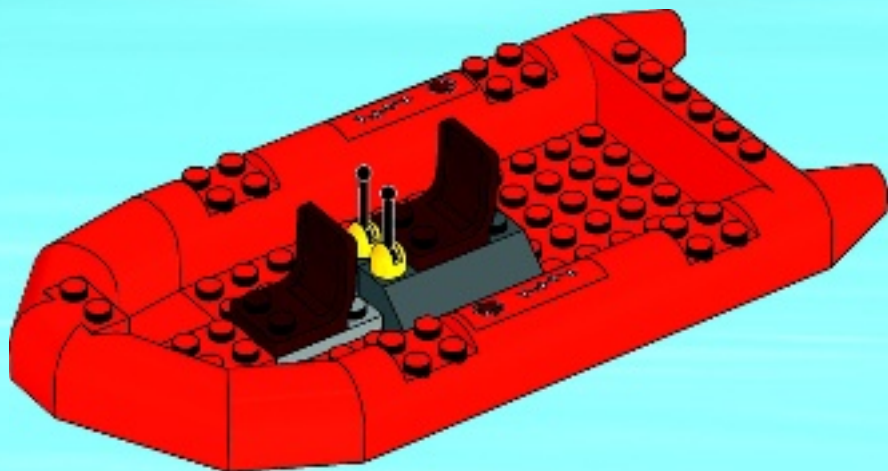



1x

6





2x

7

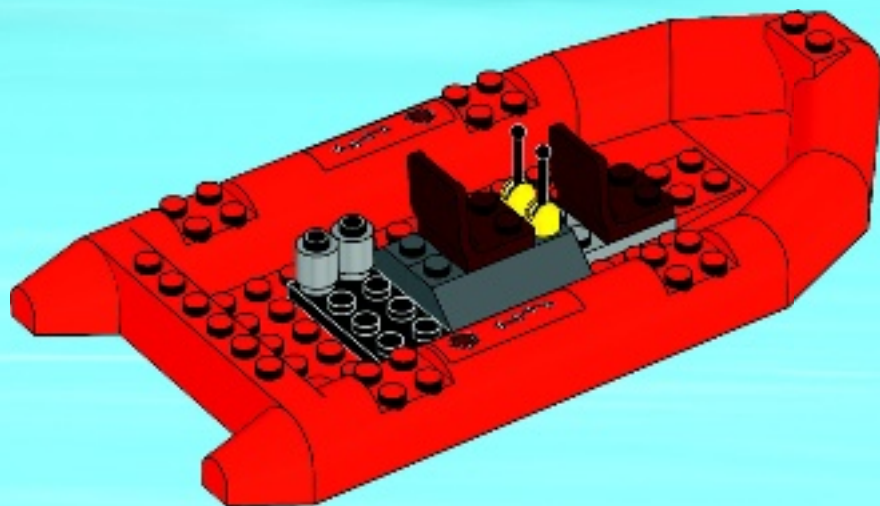



2x



1x

8

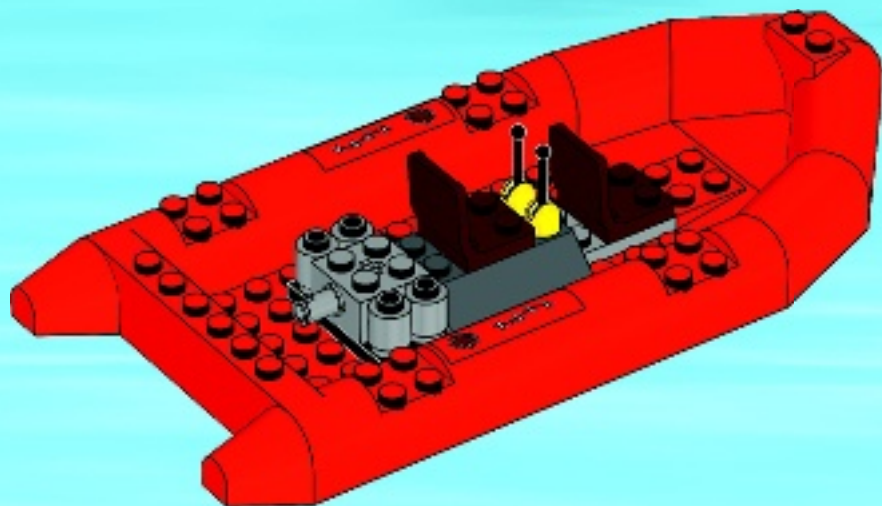



2x



1x

9

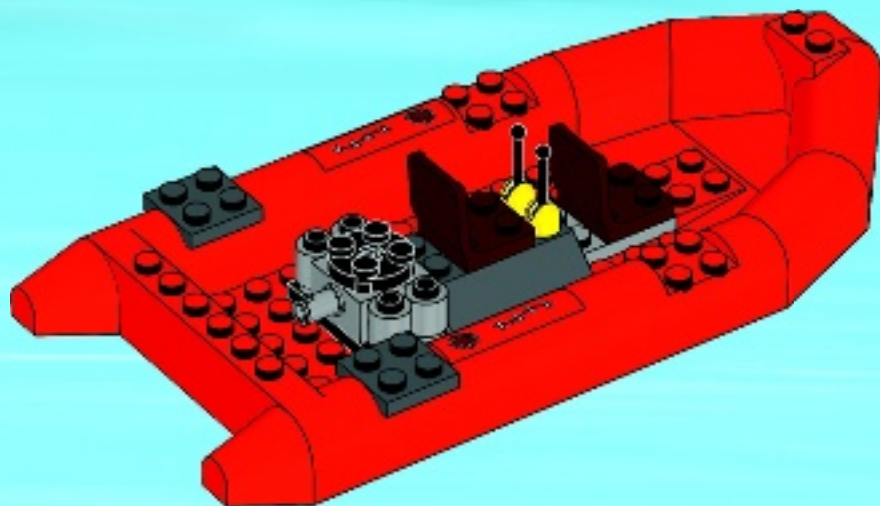



2x

10

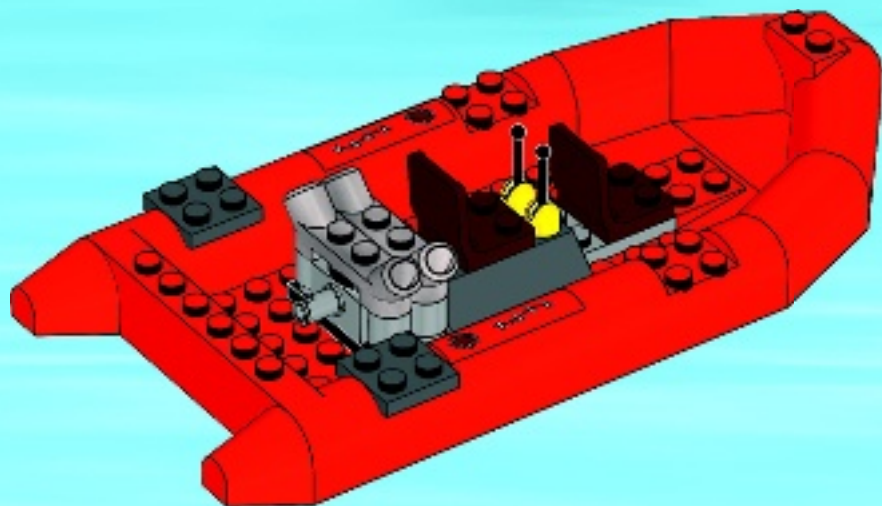



1x



2x

11

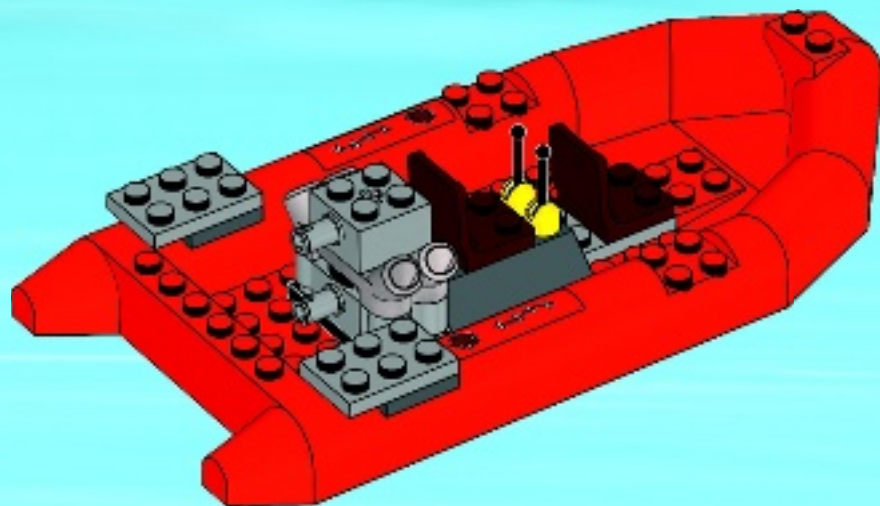



1x

12

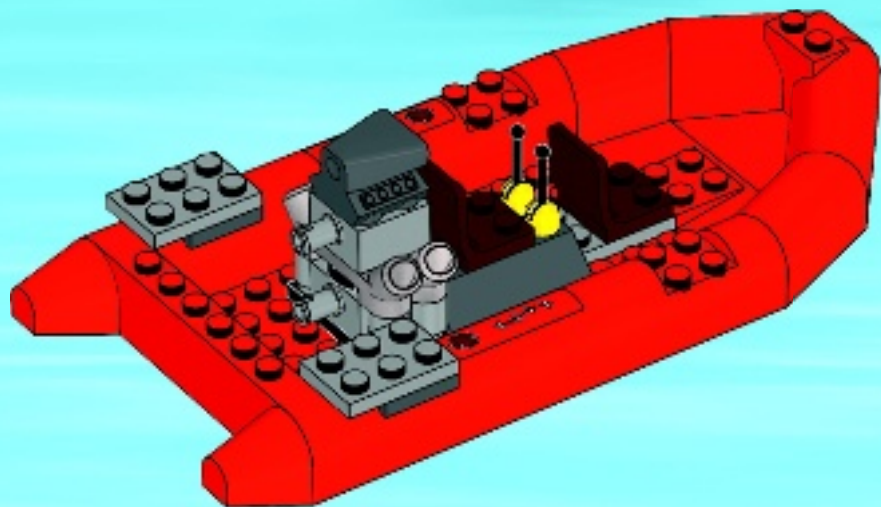



1x



1x

13

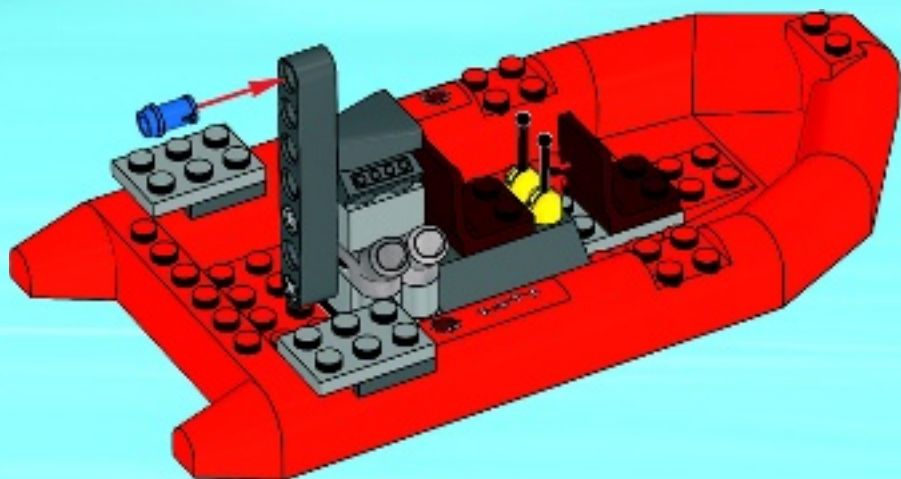



1x

14

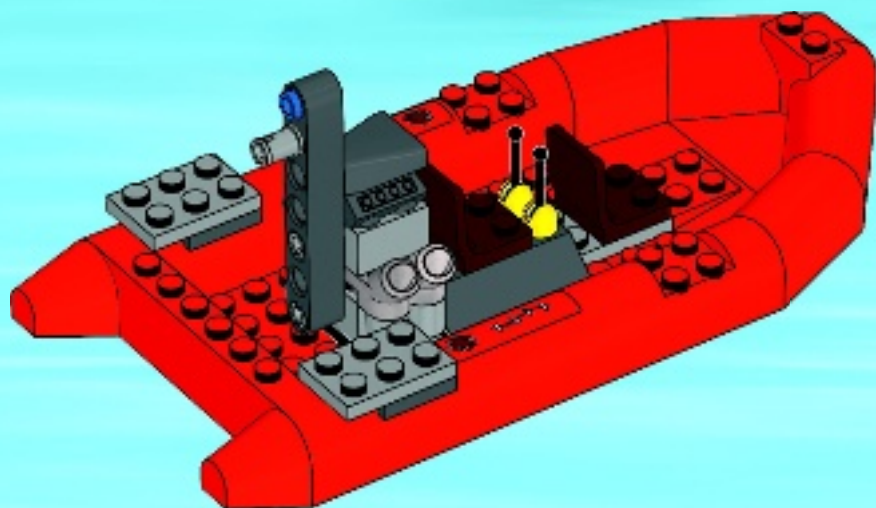



4x

15

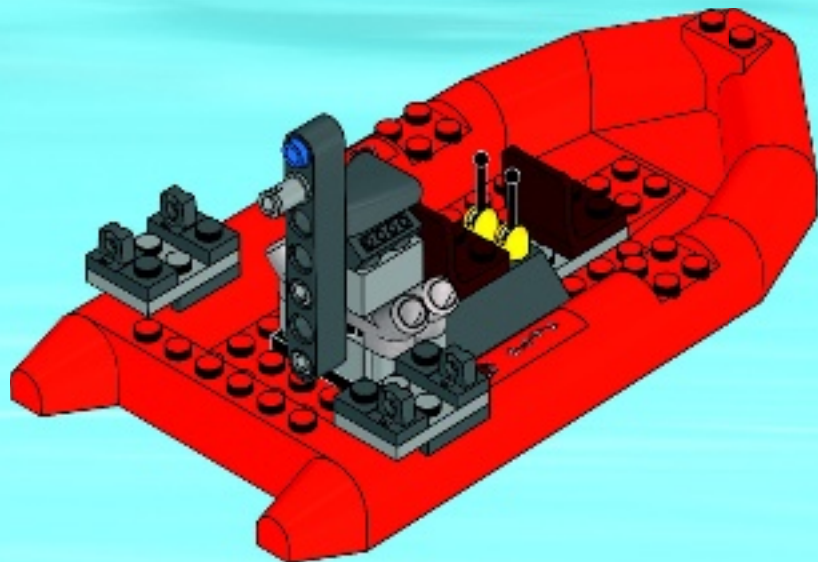



4x

16

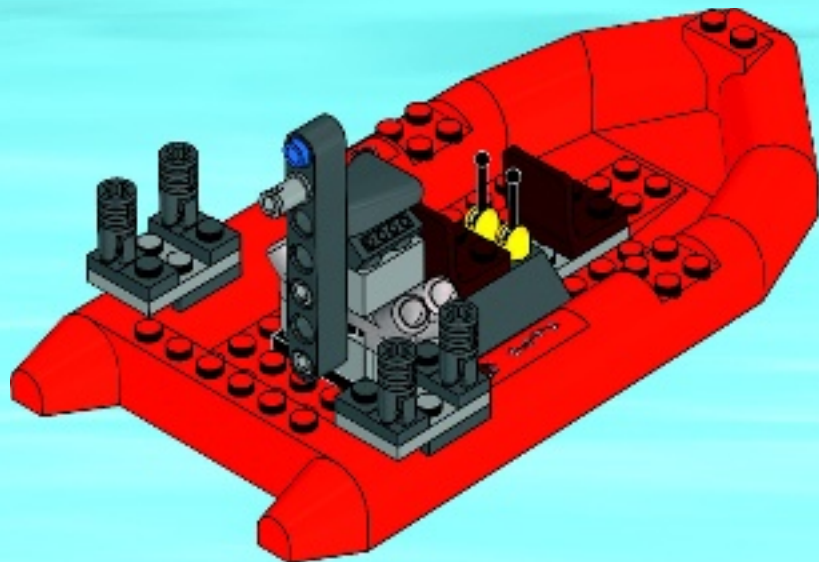



17

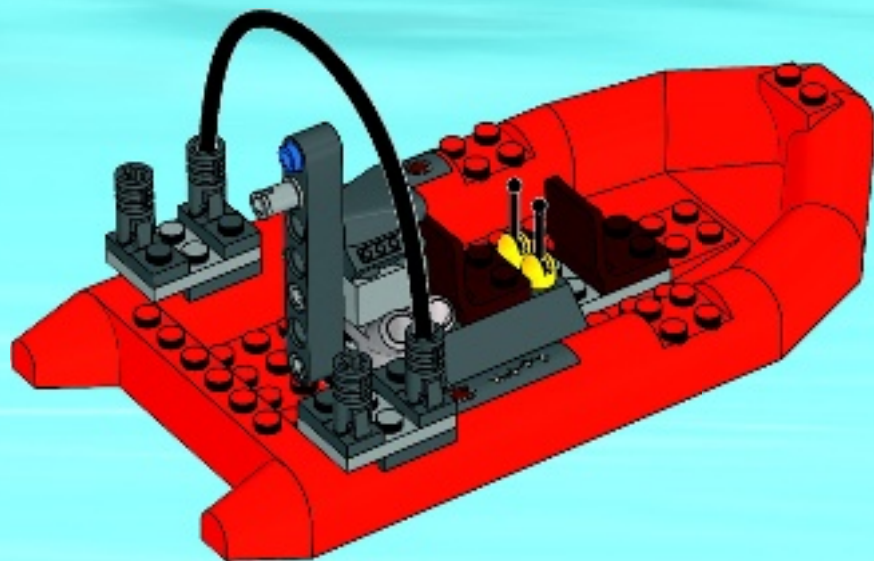



1x

18

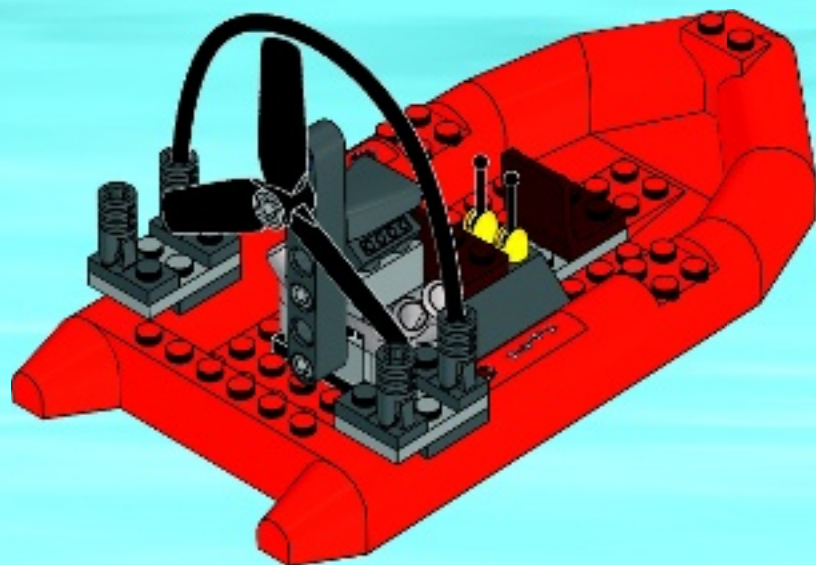



19

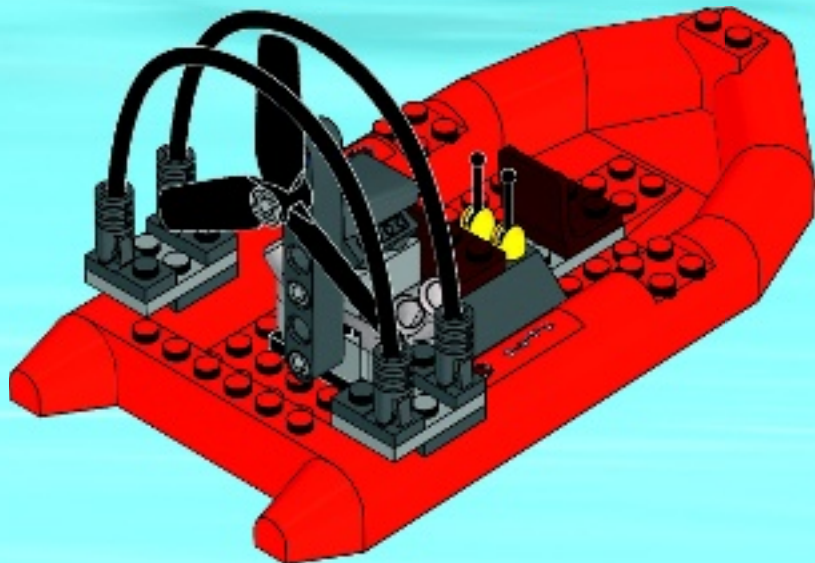



1x

1

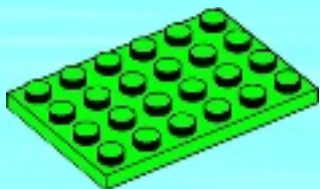

2x

2

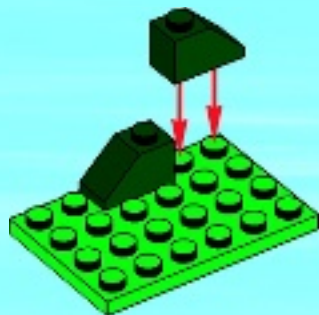



1x



1x

3





1x



2x

4

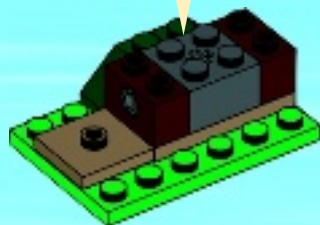
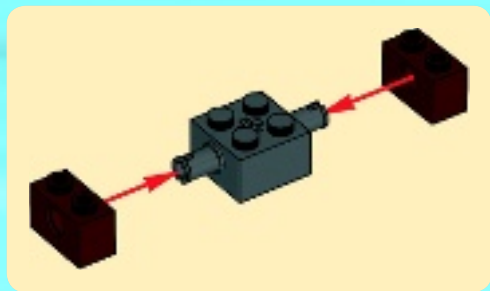

2x

5



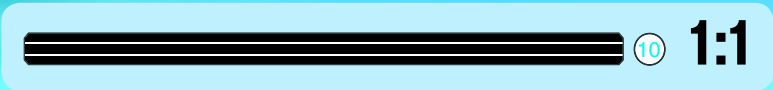

6

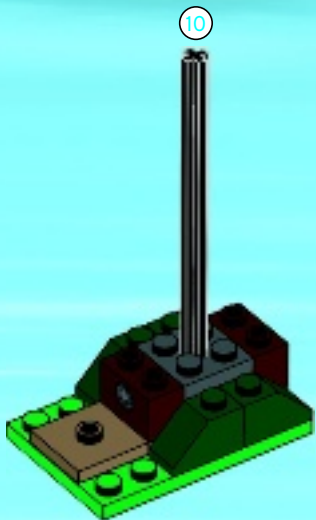



1x

7

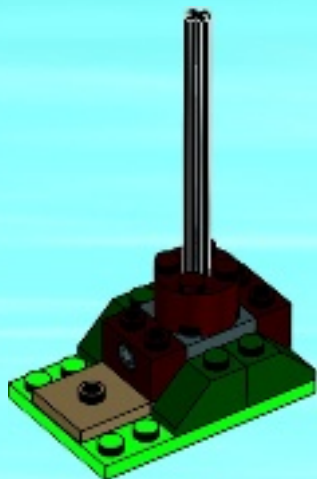

1x

8

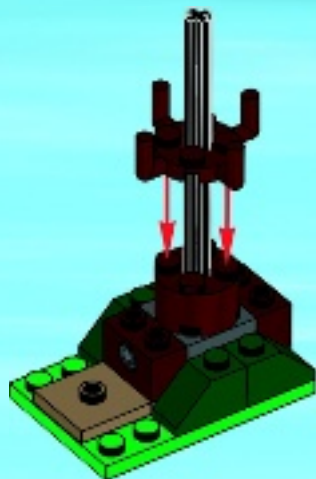



2x

9





2x

10



1x

11





2x

12





1x



1x

13



2x

14



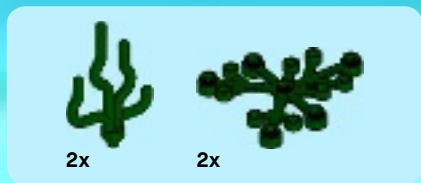

15

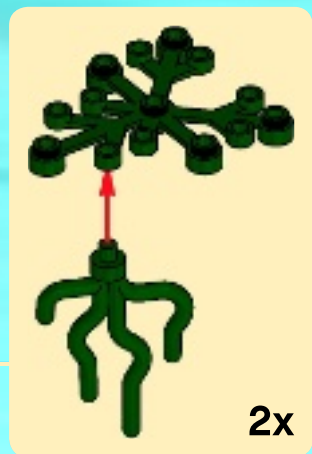



16

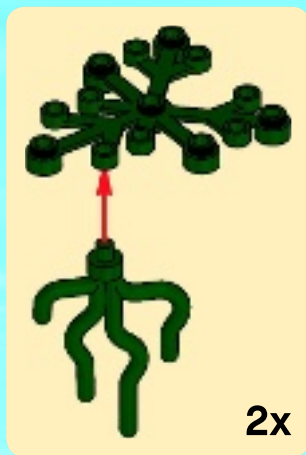



1x



4x

17

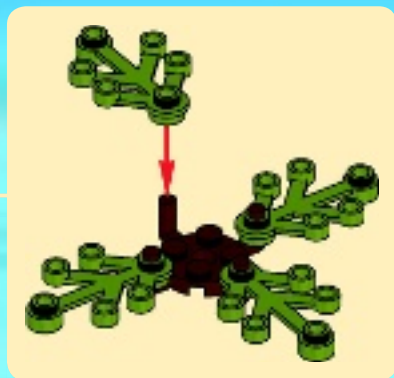

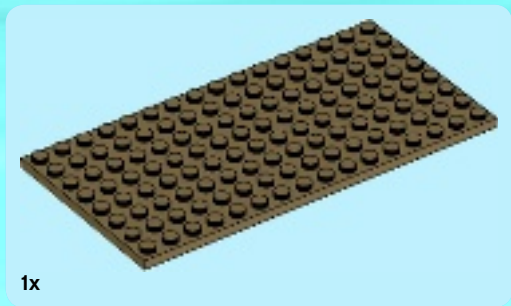

1x

1

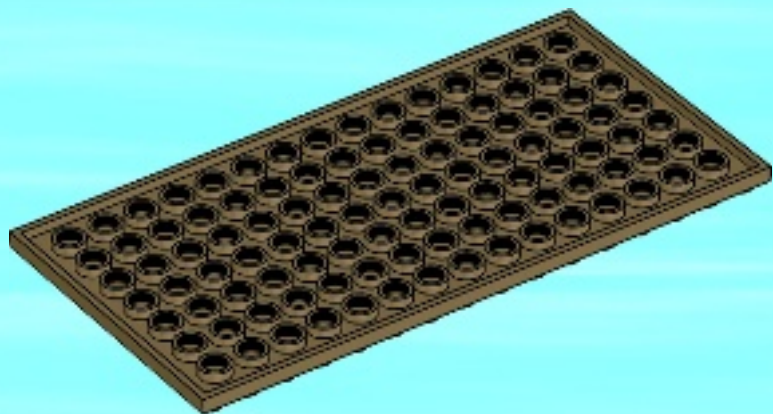

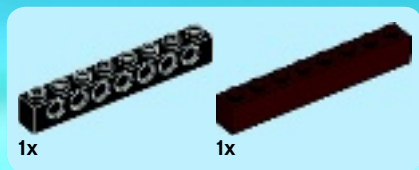

2

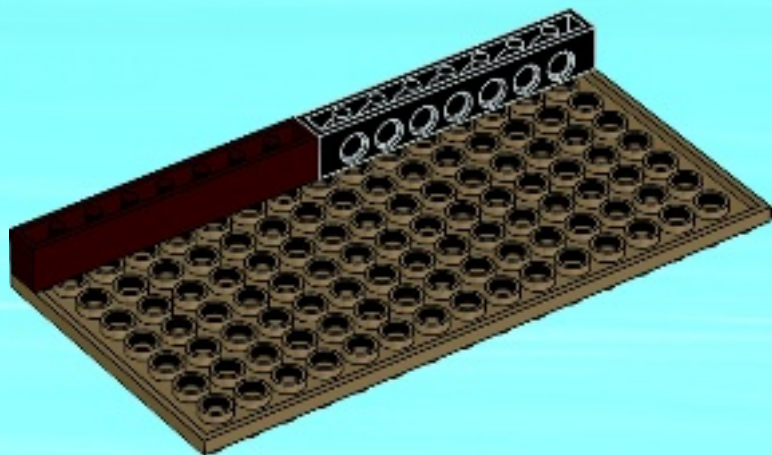



3x

3

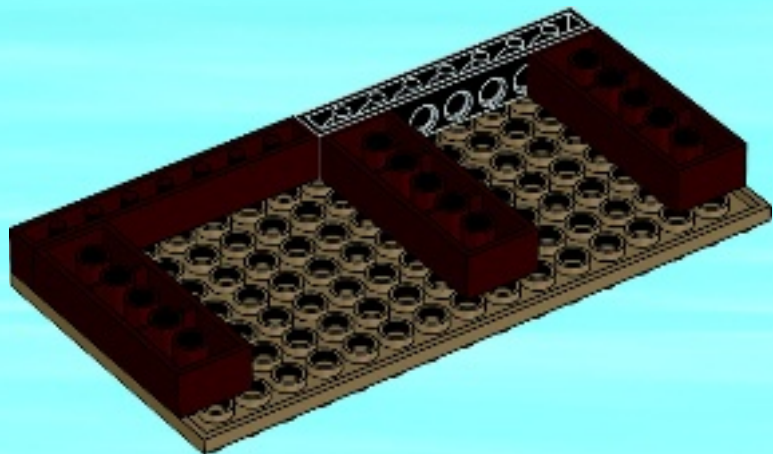



2x

4

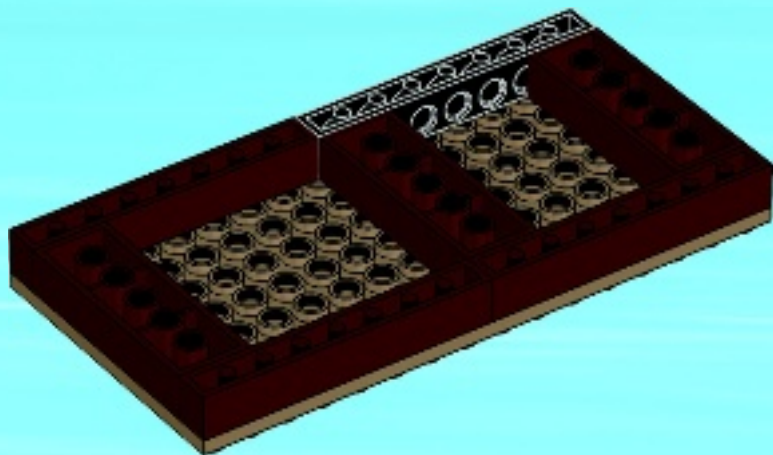



6x

5

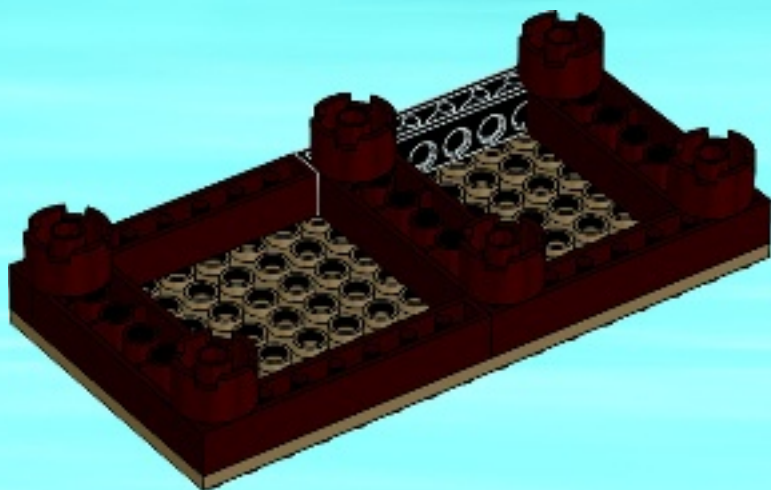





CITY



60069



60068



60067



60066



60065

LEGO.COM/CITY



CITY



60081



60084



60082



60083



60055



60060



60057



60053

LEGO.COM/CITY

LEGO CITY

FREE ONLINE GAME & APP!
JEU EN LIGNE ET APPLI GRATUITS !
¡JUEGO ONLINE Y APP GRATIS!



LEGO.COM/CITY

GET IT ON
Google play

Download on the
App Store



Apple, the Apple logo, iPad, iPhone and iPod touch are trademarks of Apple Inc., registered in the U.S. and other countries. App Store is a service mark of Apple Inc./Apple, le logo Apple, iPad, iPhone et iPod touch sont des marques de commerce d'Apple Inc., déposées aux États-Unis et dans d'autres pays. App Store est une marque de service d'Apple Inc./Apple, el logotipo de Apple, iPad, iPhone e iPod touch son marcas comerciales de Apple Inc. registradas en EE. UU. y otros países. App Store es una marca de servicio de Apple Inc. Google Play is a trademark of Google Inc./Google Play est une marque de commerce de Google Inc./Google Play est una marca comercial de Google Inc.