



SPORTS

3543



 **WARNING: CHOKING HAZARD.**
Toy contains small parts and a small ball.
Not for children under 3 years.



4224124

3540



3541



3542



3543





3540 Puck Passer



3541 Slap Shot



3542 Flip Shot



3543 Slammer Goalie



3544 Game Set



3545 Puck Feeder



⚠️ AVERTISSEMENT : RISQUE D'ÉTOUFFEMENT.

Le jouet contient des petites pièces ainsi qu'une petite boule.
Il ne convient pas aux enfants de moins de 3 ans.

⚠️ ADVERTENCIA: PELIGRO DE ASFIXIA.

Juguete que contiene partes pequeñas y una pelota pequeña.
No recomendado para niños menores de 3 años.

1

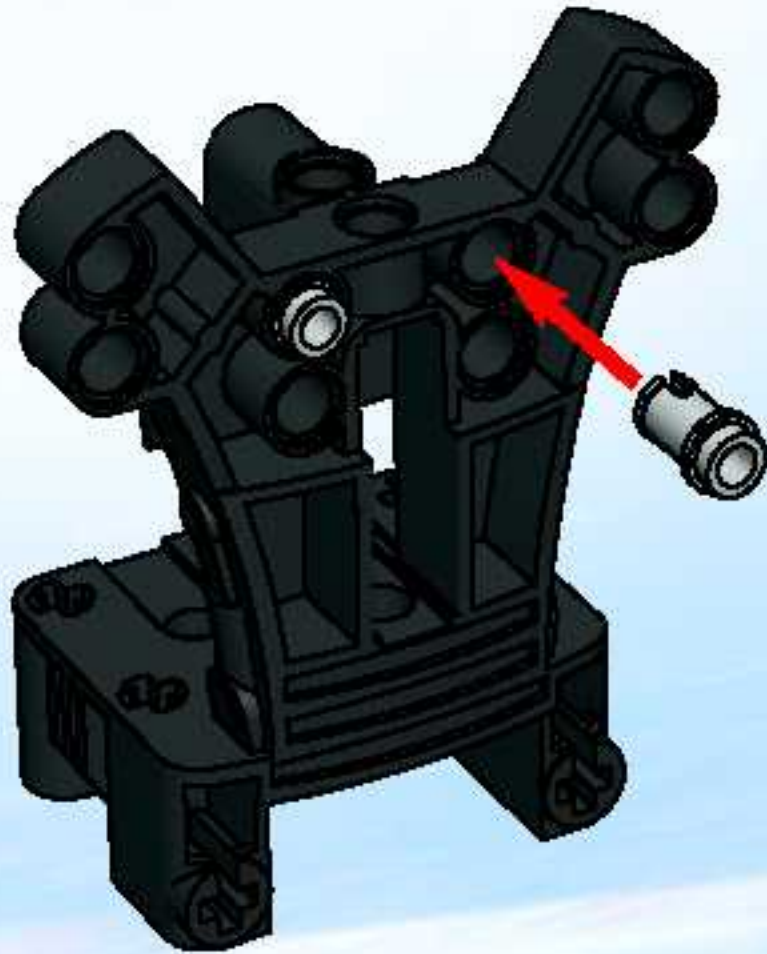

2

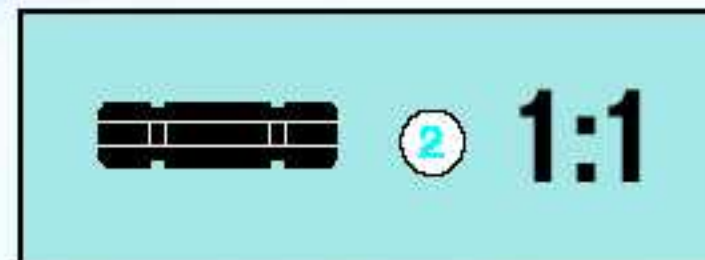
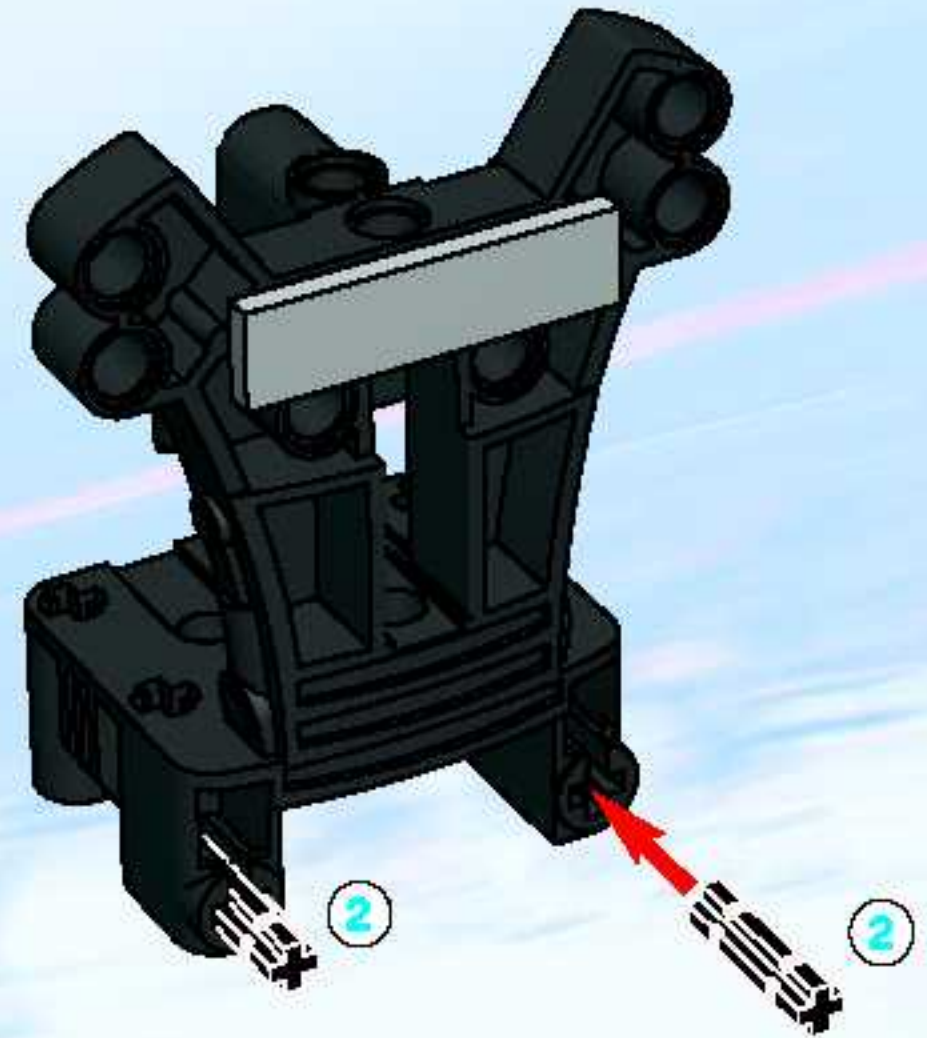

3

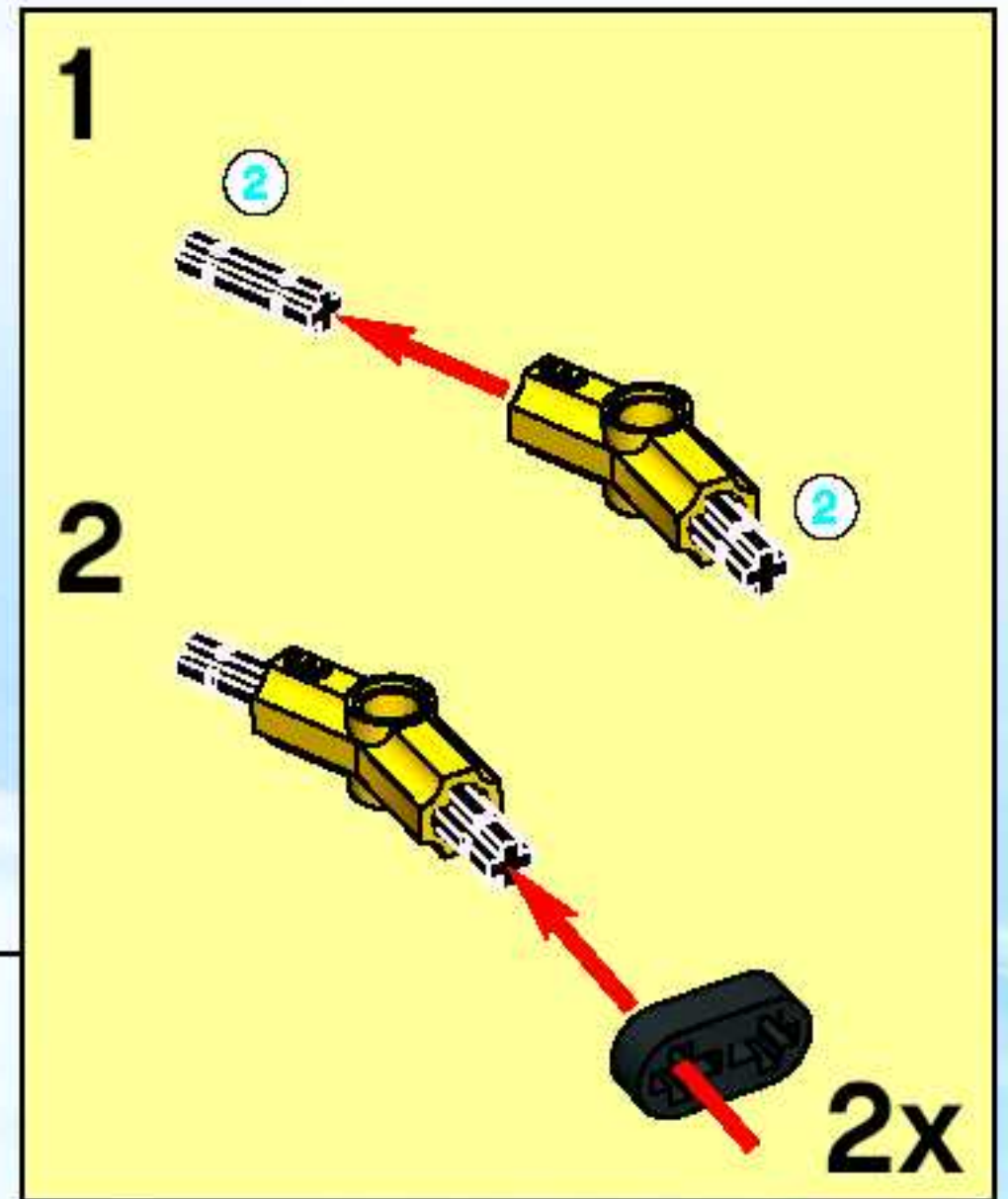
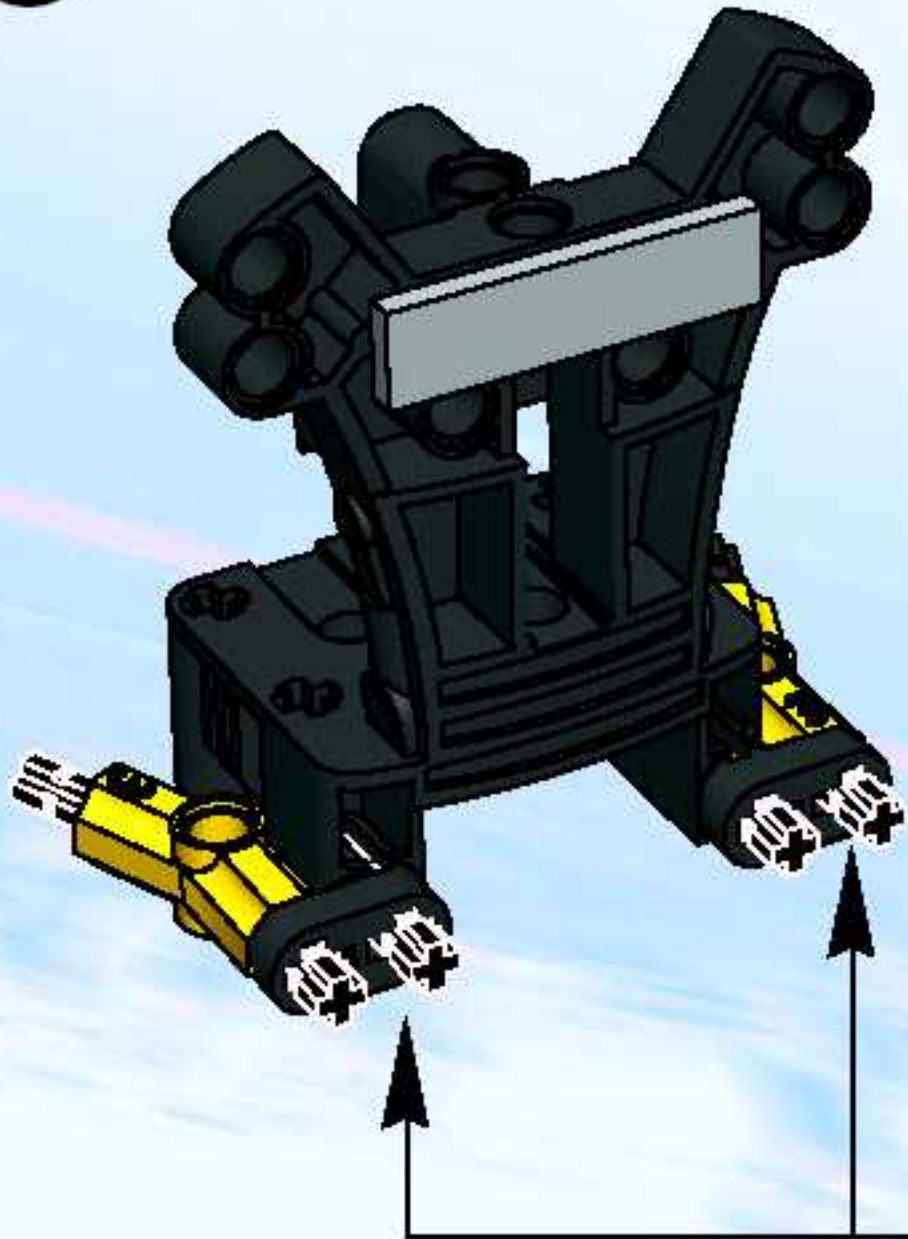

4

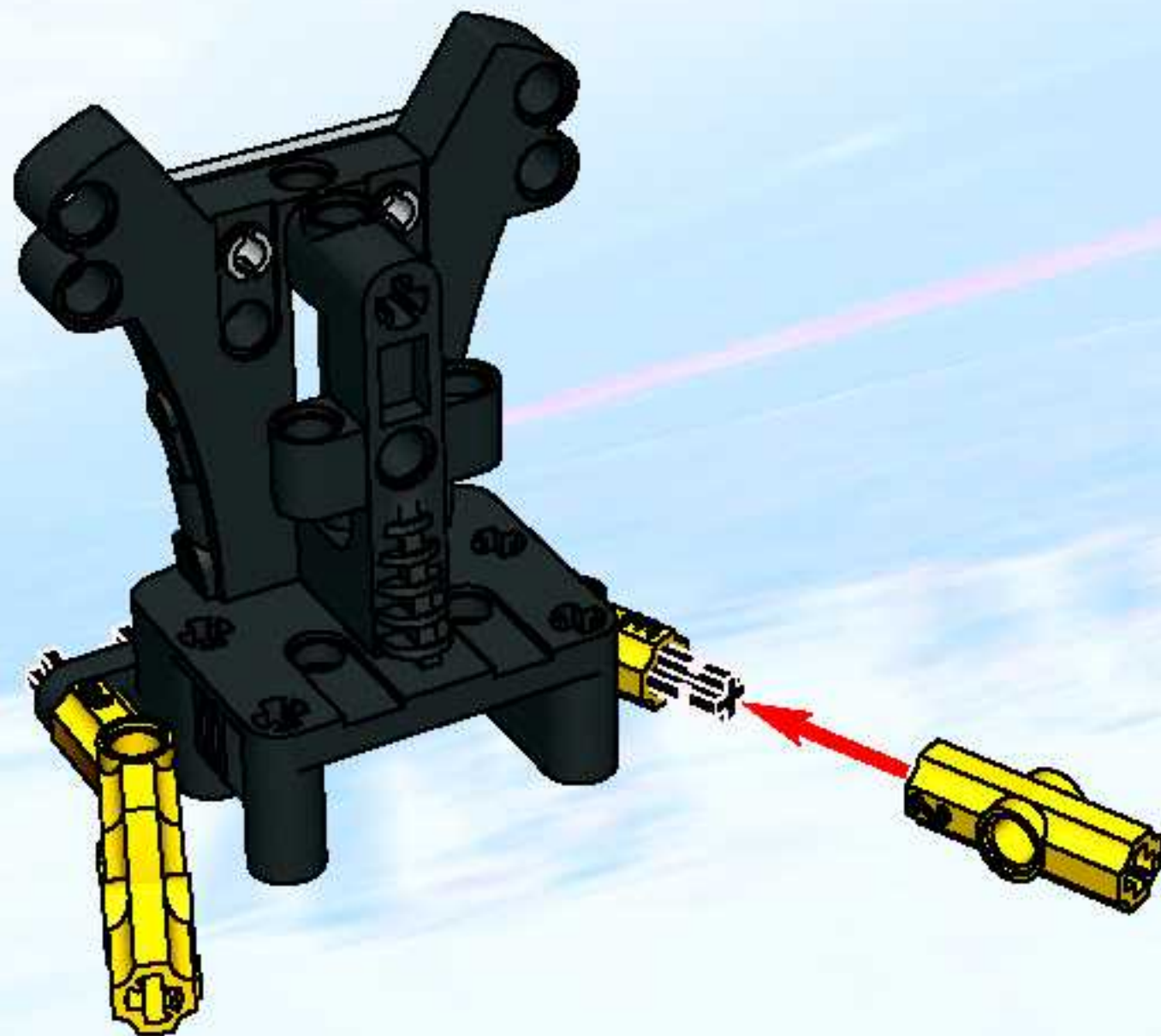

5

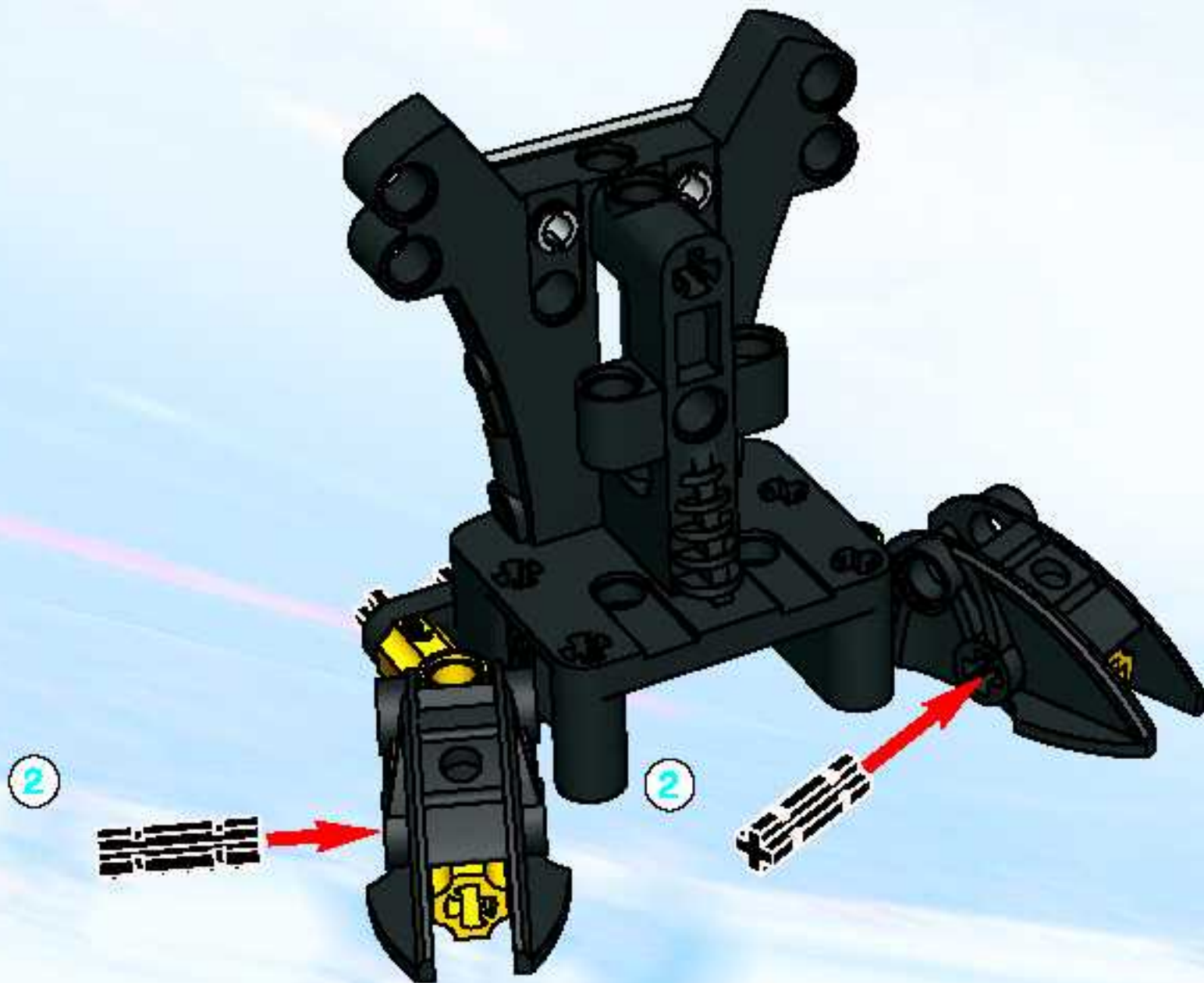

 2 **1:1**

6

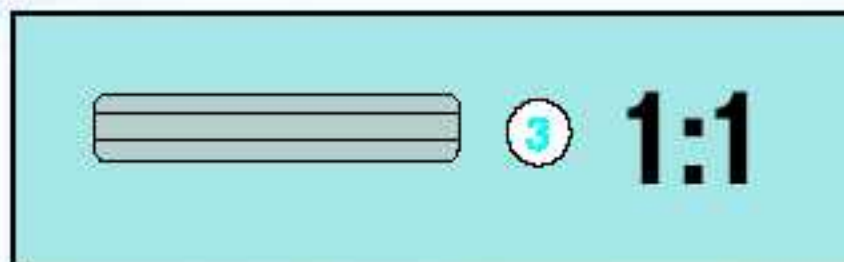

7



8

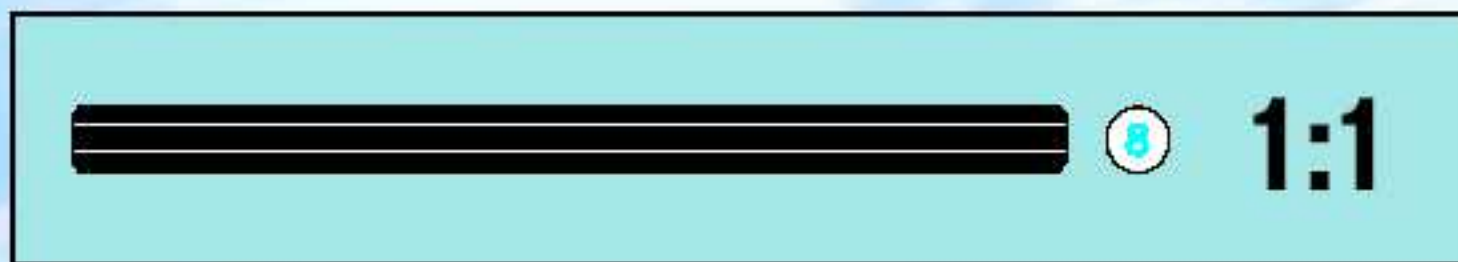
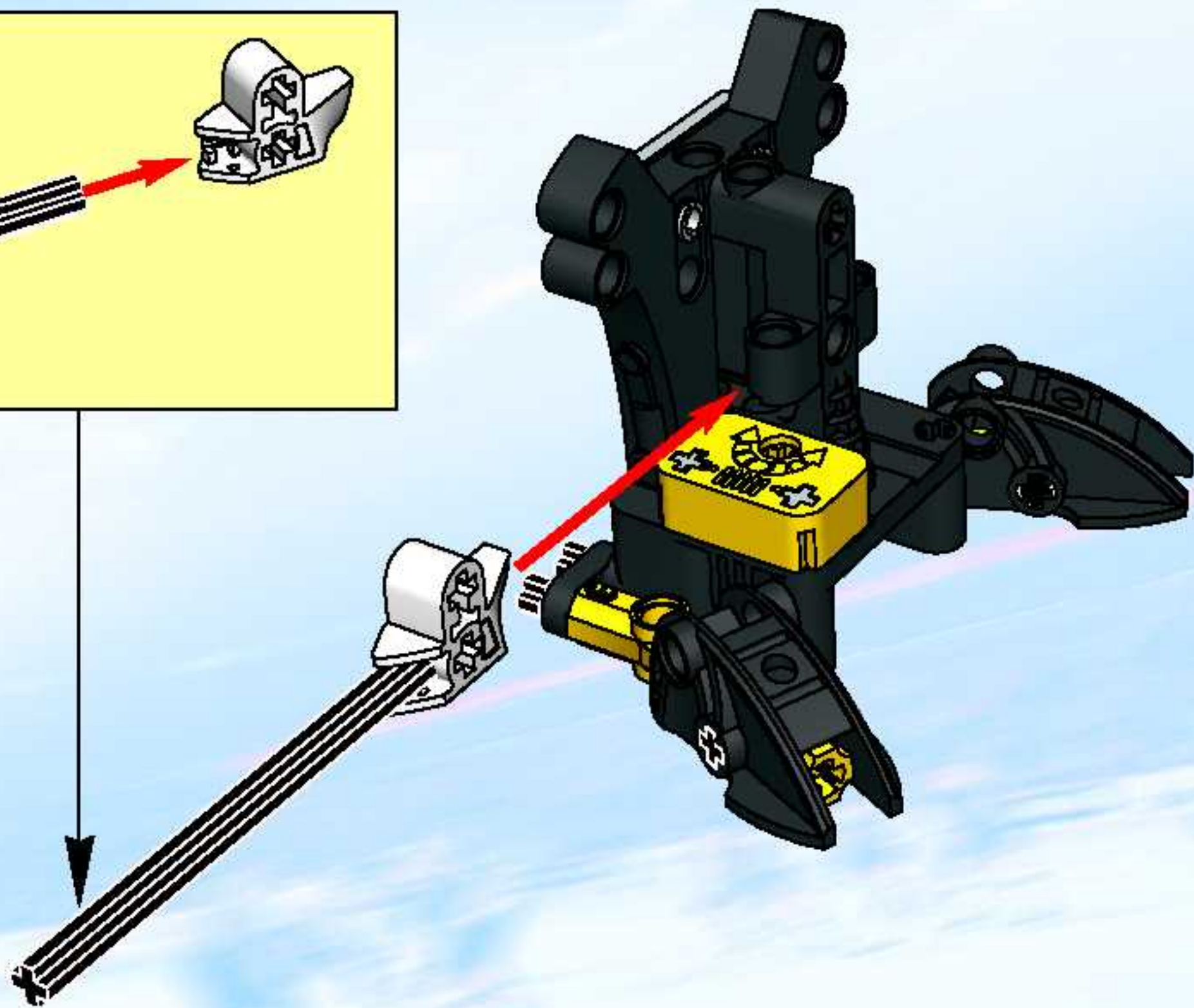
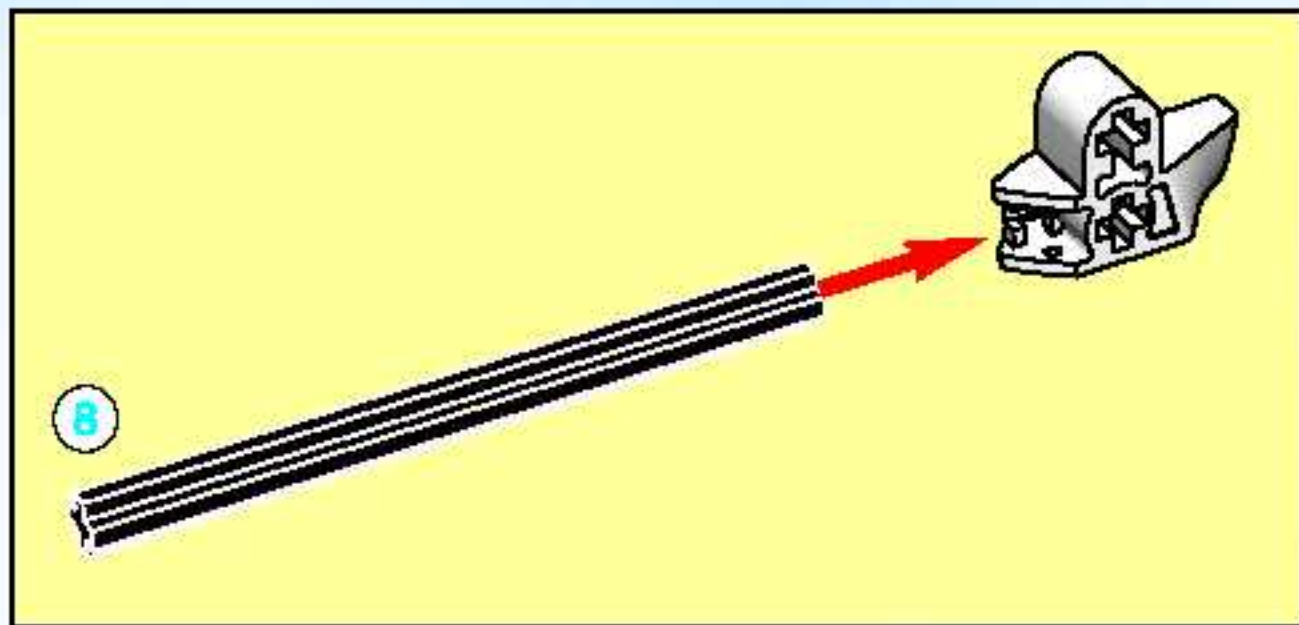

9

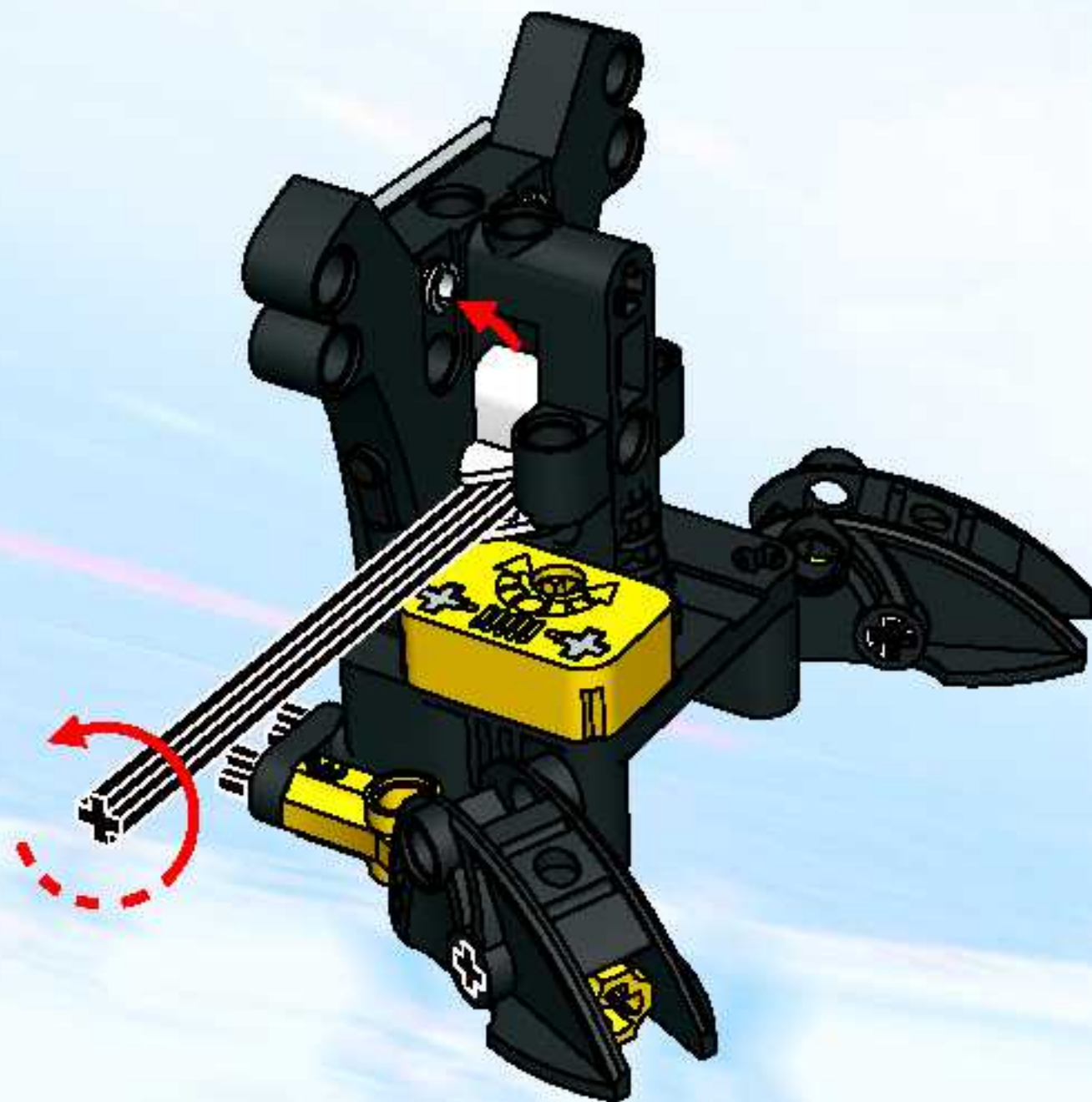

10



11

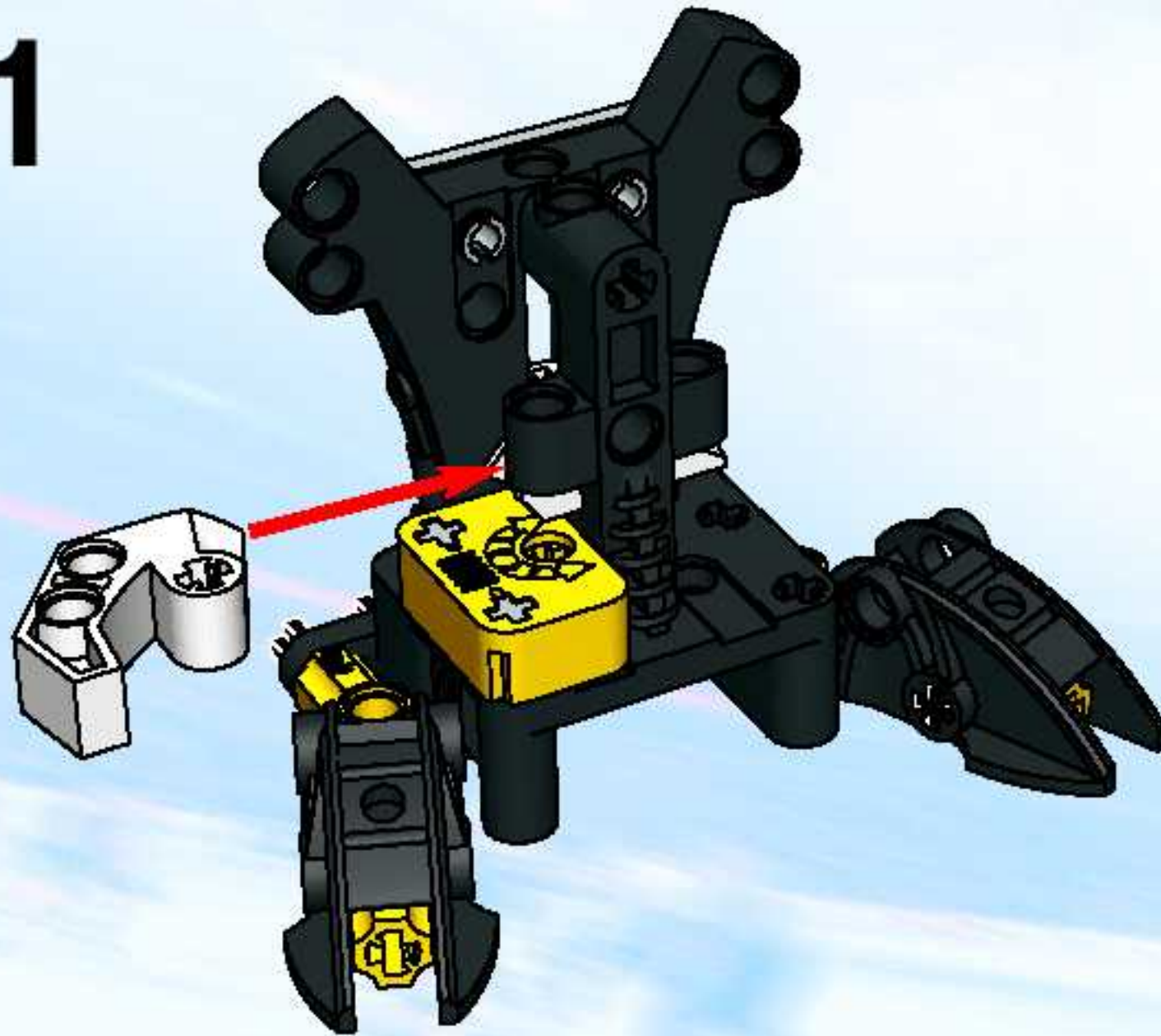

12

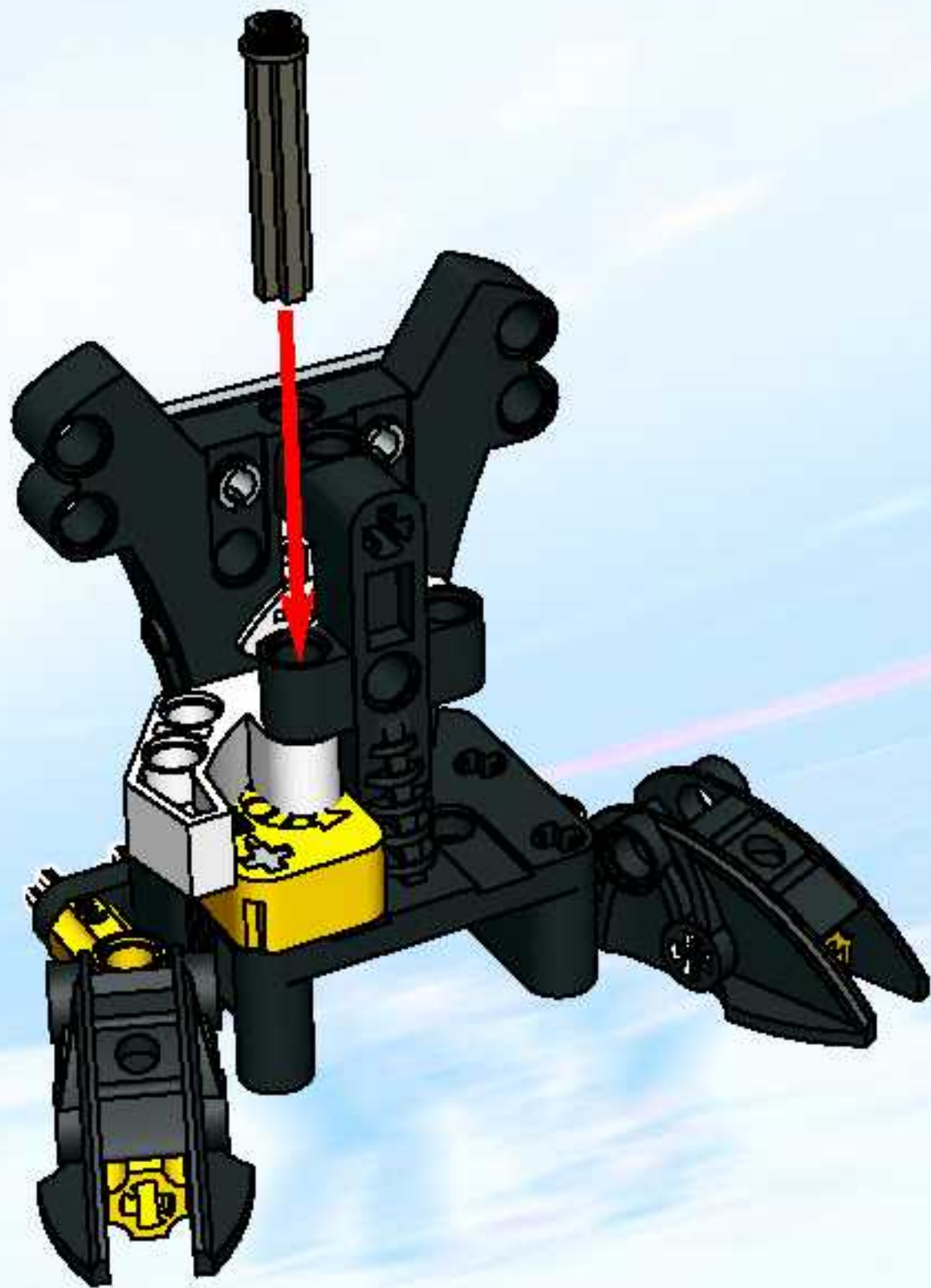

13



1

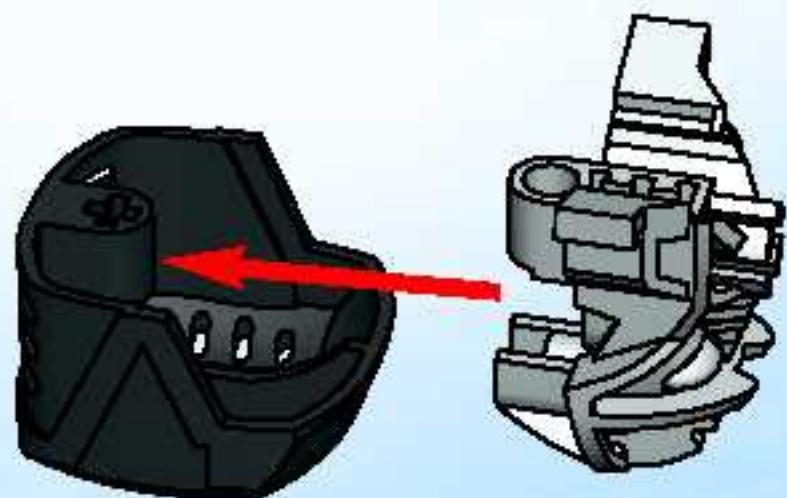

2

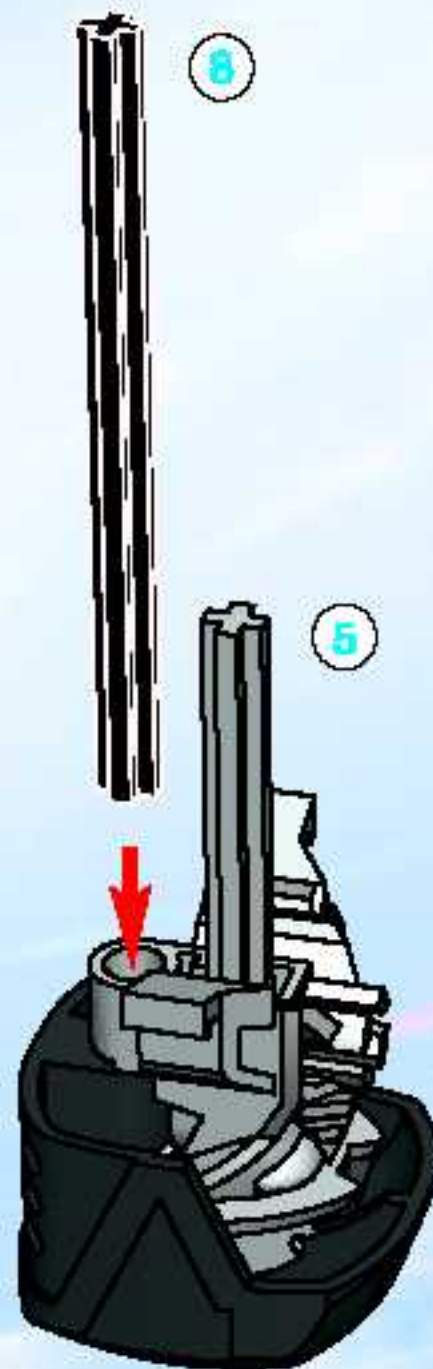

3

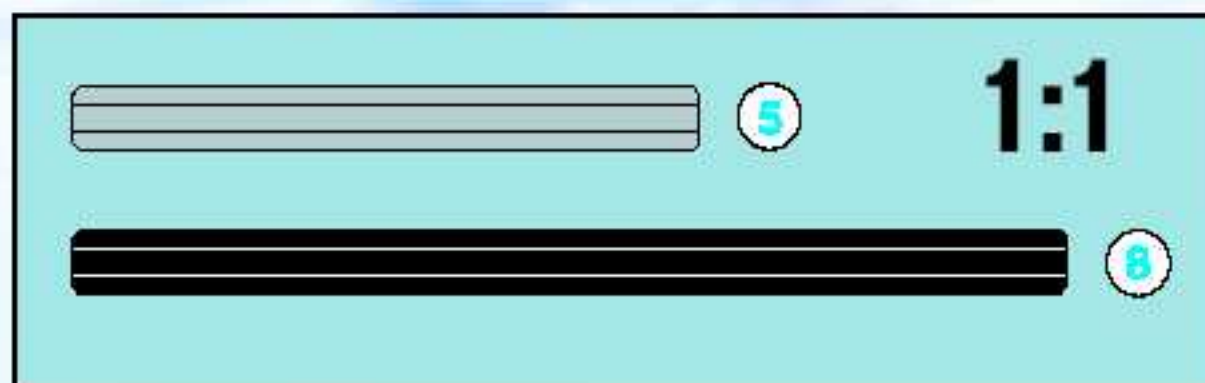
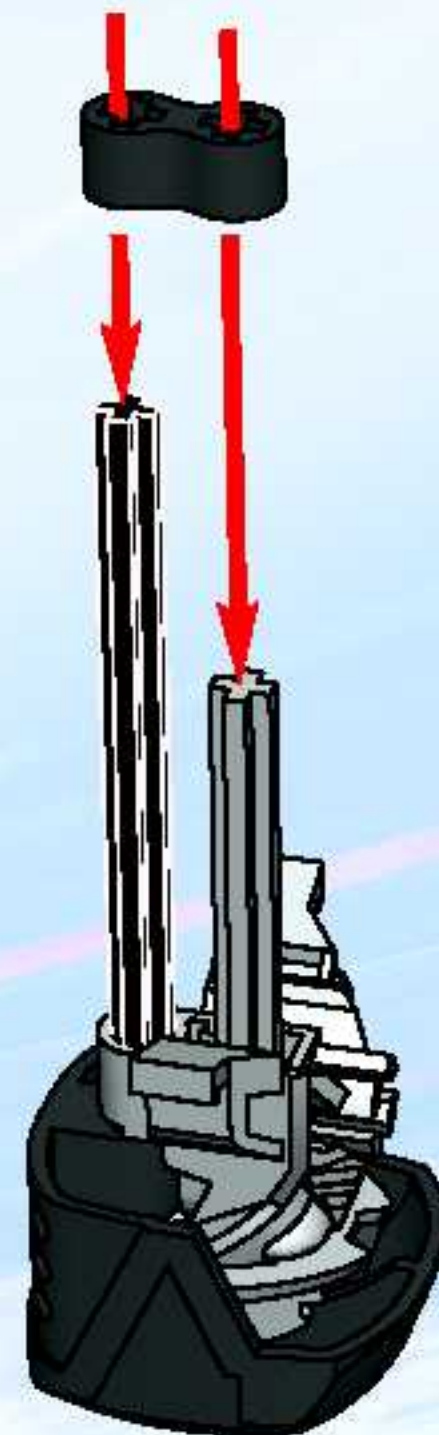

14

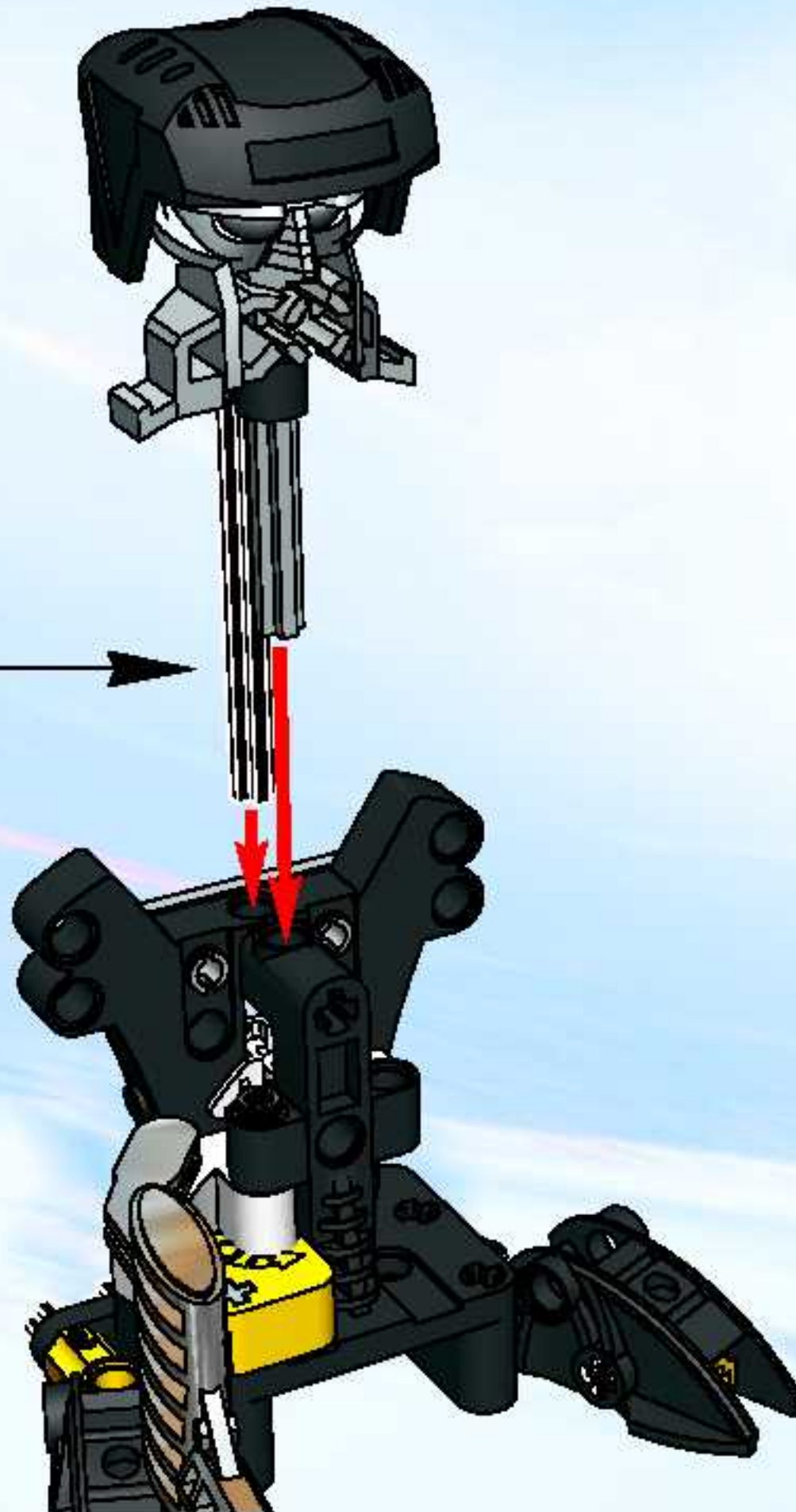

15

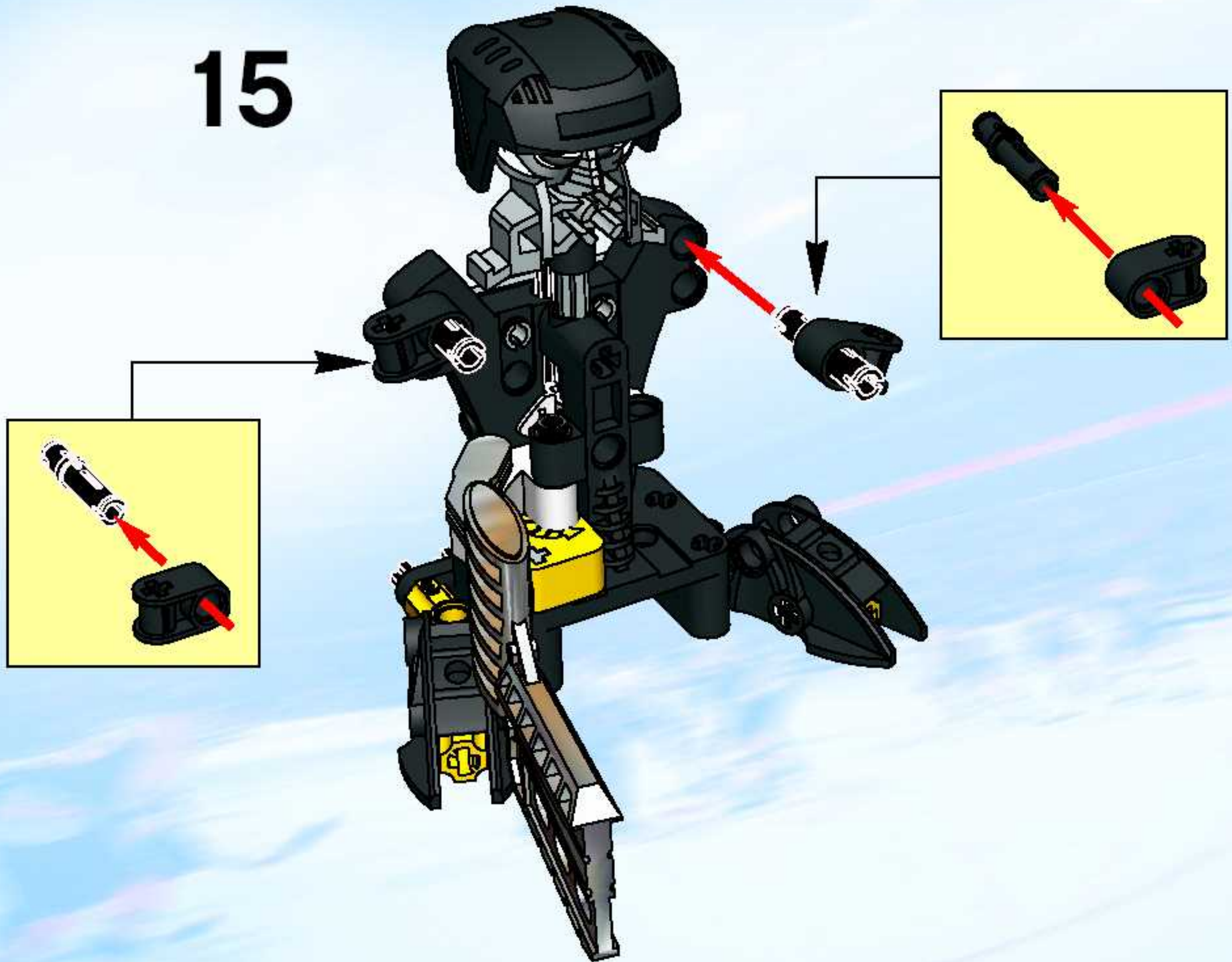

16



17

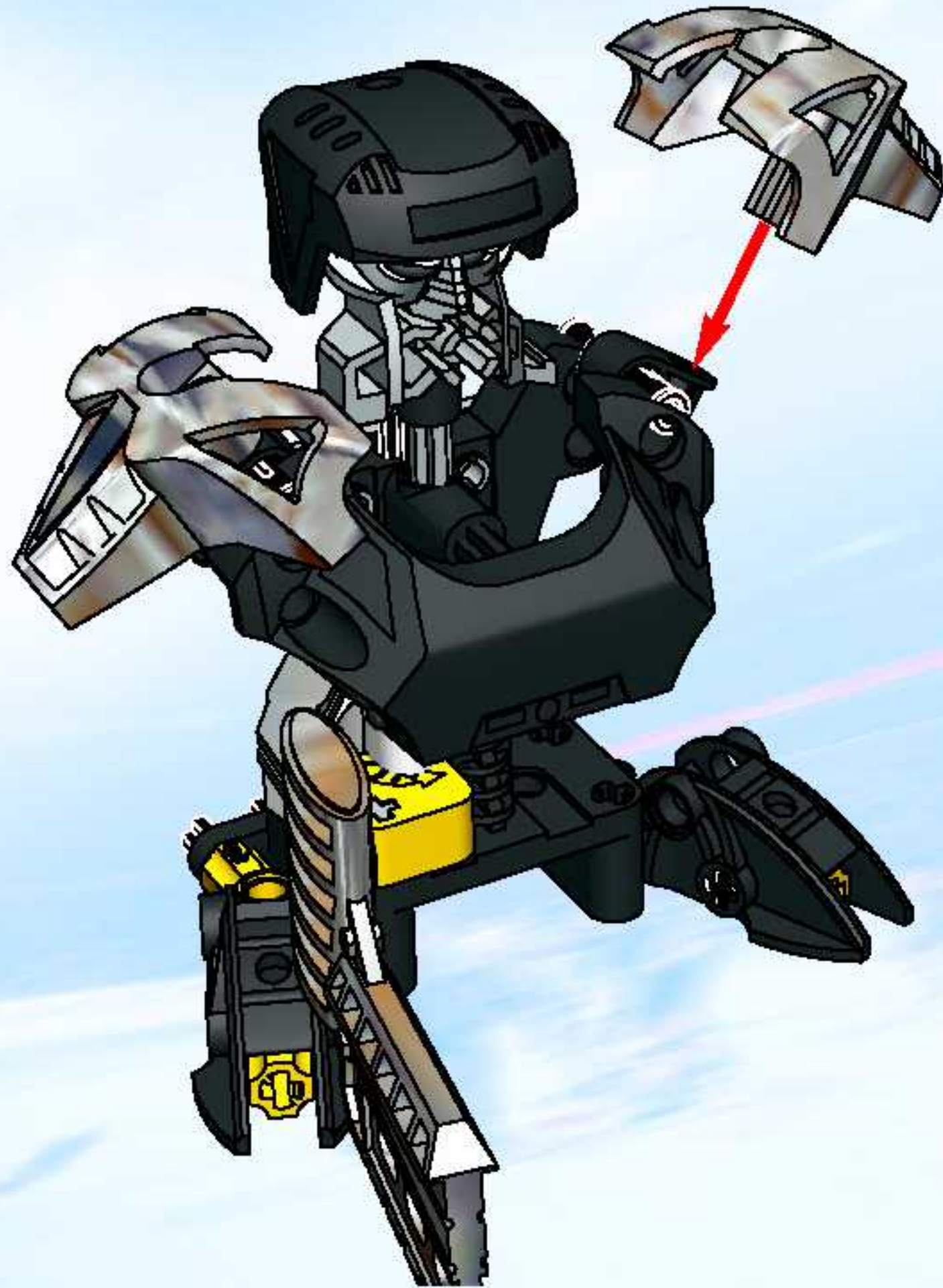

18

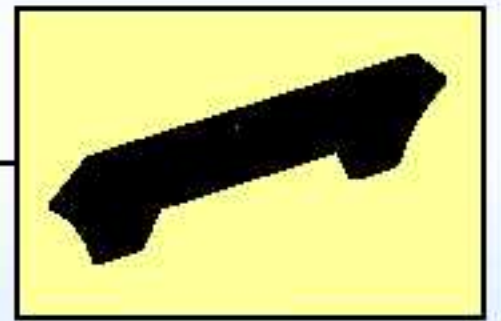

19



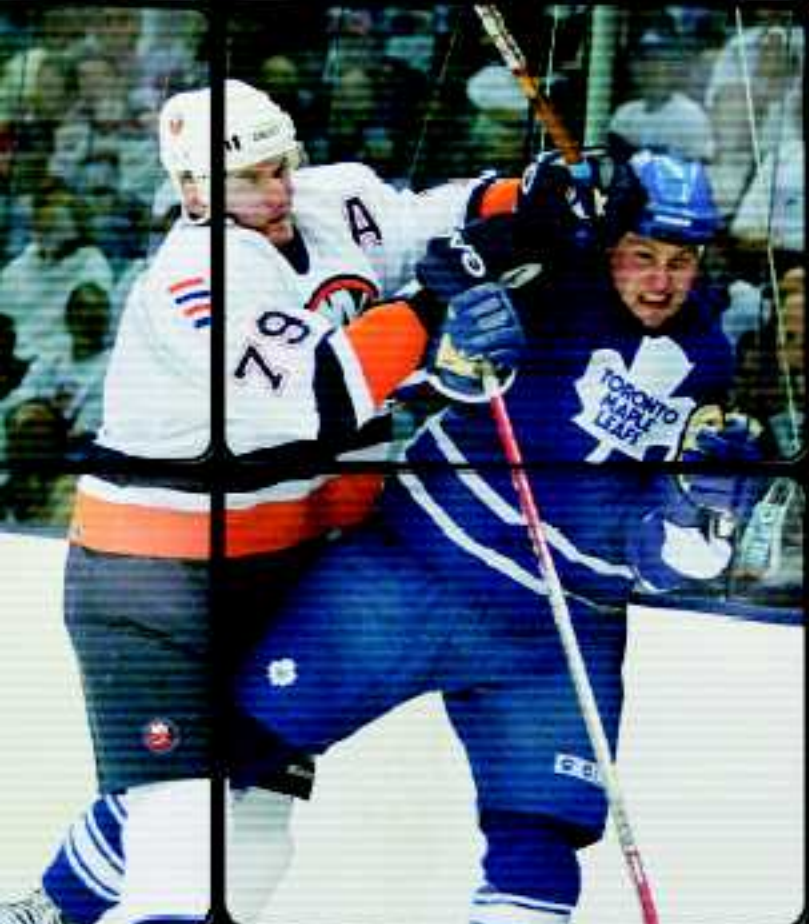

 www.LEGO.com/sports

nhlpa
.COM

NHL
.COM

LEGO, the LEGO logo and the Minifigure are trademarks of the LEGO Group.
©2003 The LEGO Group.

NHL and the NHL Shield are registered trademarks of the National Hockey League. All NHL logos and marks and team logos and marks depicted herein are the property of the NHL and the respective teams and may not be reproduced without the prior written consent of NHL Enterprises, L.P. © NHL 2003. All Rights Reserved.

© NHLPA. NHLPA, National Hockey League Players' Association and the NHLPA logo are trademarks of the NHLPA.



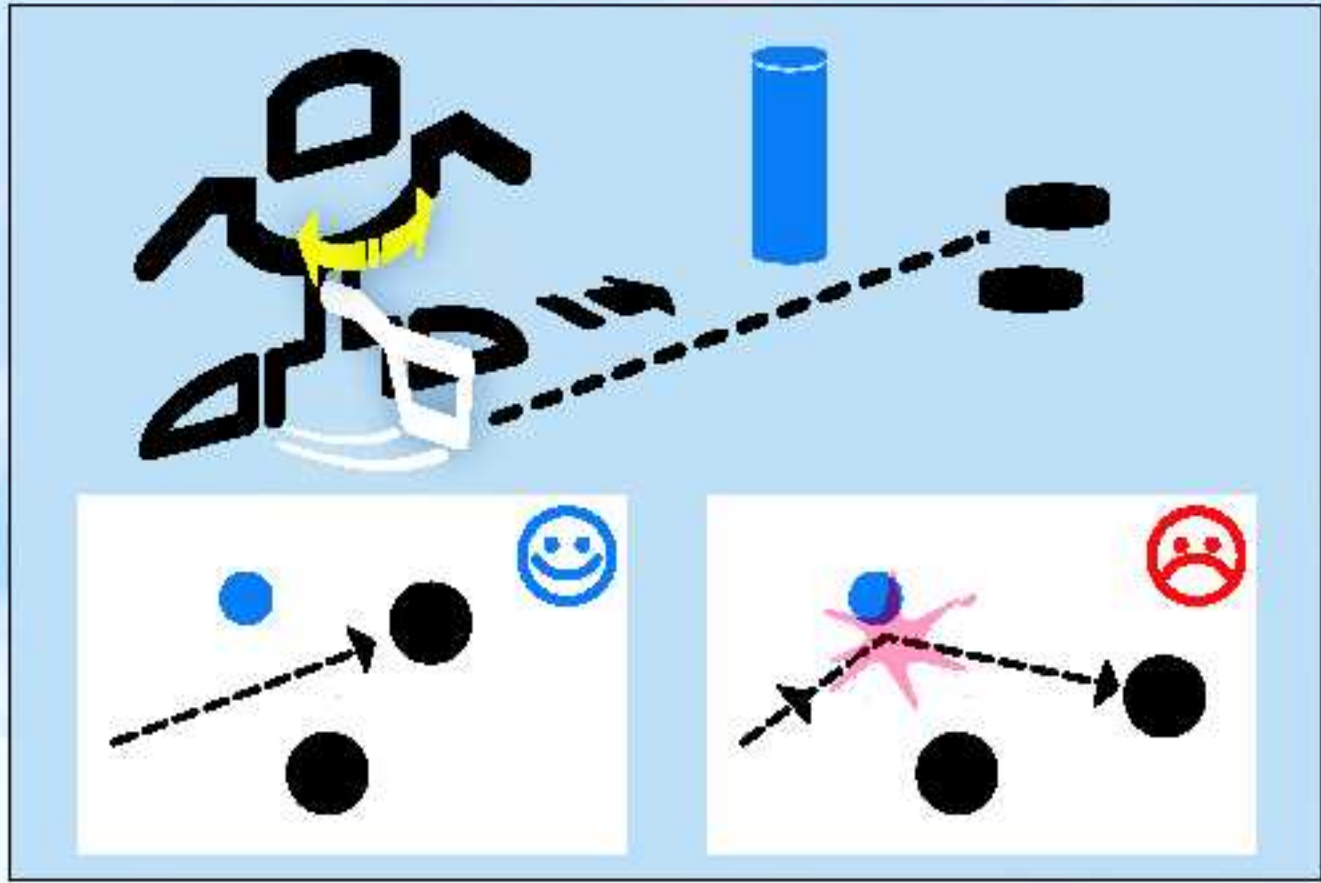
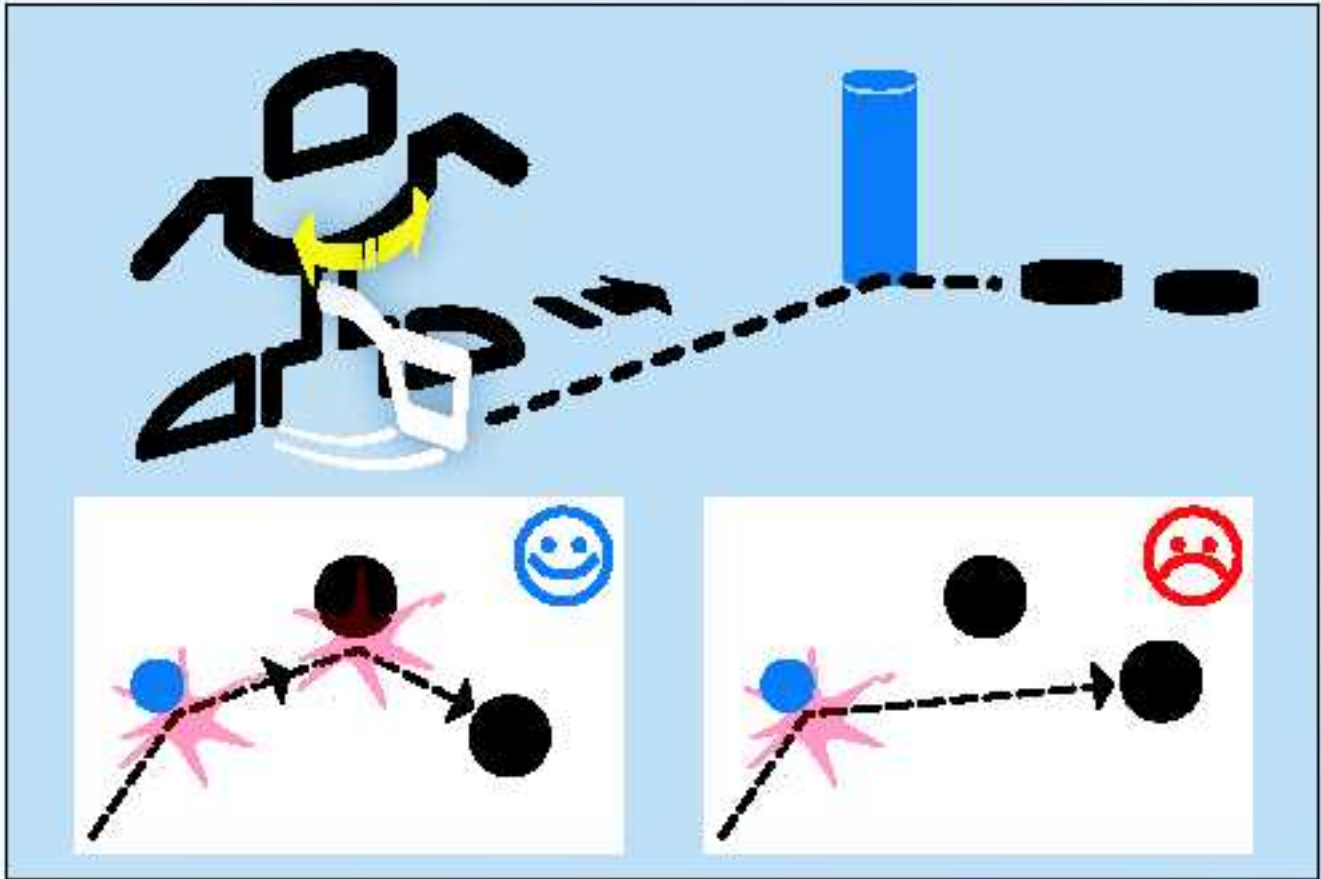





3428



3429



3433







3585



3536



3540 + 3543 =



BG: Почерете рпеји yHOTpeдa

LT: Prieš naudojimą nuvalyti

ET: Enne tarvitamist puhastada

LV: Pirms lietošanas jānotīra

TR: Kullamadan önce temizleyin



KO: 김모범으로 빡뮌이A7 권이 깨끗0 씻어주세요

RU: Перед использованием очистить

PL: Wyczyścić przed użyciem

CS: Před použitím omyjte vodou.

SK: Před použitím umyte vodou.

HU: Használat előtt tisztítsd meg!

UA: Перед використання очистити

HR: Očistite prije uporabe

SR: Очистити пре употребе

SL: Pred uporabo očisti

RO: A se curăța înainte de utilizare



EN: Clean before use

DE: Bitte vor Gebrauch reinigen

FR: Nettoyer avant usage

IT: Pulire prima dell'uso

NL: Vóór gebruik reinigen

ES: Limpiar antes de usar

DA: Rengøres før brug

FI: Puhdistaa ennen käyttöä

SV: Rengör innan användning

PT: Limpar antes da utilização

EL: Καθαρίστε πριν τη χρήση

JP: 汚れを落とすことから使用してください。

SPORTS

LEGO

NHL and the NHL Shield are registered trademarks of the National Hockey League. All NHL logos and marks and team logos and marks depicted herein are the property of the NHL and the respective teams and may not be reproduced without the prior written consent of NHL Enterprises, L.P. © NHL 2003. All Rights Reserved.

LNH et le Sigle LNH sont des marques déposées de la Ligue Nationale de Hockey. Tous les logos et marques LNH et les logos et marques de ses équipes sont la propriété de LNH et des équipes respectives et ne peuvent pas être reproduits sans le consentement préalable par écrit de LNH Enterprises, L.P. © LNH 2003.

NHL y el escudo de la NHL son marcas registradas de la Liga Nacional de Hockey. Todos los logotipos, marcas y logotipos de los equipos de la NHL representados en el mismo son propiedad de la NHL y de sus respectivos equipos y no deberán ser reproducidos sin el consentimiento escrito de NHL Enterprises, L.P. © NHL 2003. Todos los Derechos Reservados.

adidas, the adidas logo and the three stripe trademark are registered trademarks of the adidas-Salomon group, used with permission. Fevenova and the Trigon logo are trademarks of the adidas-Salomon group, used with permission. Fevenova et le logo Trigon sont des marques déposées du groupe adidas-Salomon, utilisées avec sa permission. Fevenova, le logo adidas et la marque aux trois bandes sont des marques adidas, le logo adidas y el símbolo de tres bandas son marcas registradas, el logotipo adidas y se utilizan con autorización. Fevenova y el logotipo Trigon son marcas registradas del grupo adidas-Salomon y se utilizan con autorización.

LEGO and the LEGO logo are trademarks of/son des marques de commerce de/son marcas registradas de LEGO Group. ©2003 The LEGO Group.

www.LEGO.com/sports

NBA identifications depicted are the exclusive property of NBA Properties, Inc. and/or the NBA Member teams, and are used with permission. Les identifications NBA reproduites sont la propriété exclusive de NBA Properties, Inc. et/ou des équipes membres de la NBA et sont reproduites sous autorisation de la NBA son propriété exclusive de NBA Properties, Inc. y/o de los miembros de los equipos de la NBA, y son usados bajo permiso. SPALDING is a trademark of/est une marque de commerce de/es una marca registrada de Spalding Sports Worldwide, Inc. or/ou Spalding Sports, Inc.; a filiale de Spalding/une filiale de Spalding. © Spalding Sports Worldwide, Inc. 2003.

