

3428

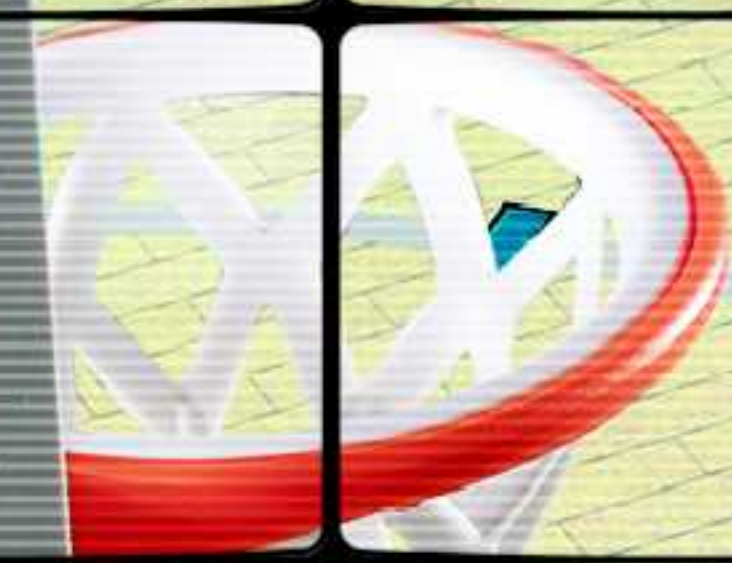

SPORTS



⚠ WARNING: CHOKING HAZARD.
Toy contains small parts and a small ball.
Not for children under 3 years.

4195741



3427





3428



3429



3433

3560



3561



3562



3563



3564



3565



3566



3567



⚠️ AVERTISSEMENT : RISQUE D'ÉTOUFFEMENT.
Le jouet contient des petites pièces ainsi qu'une petite boule.
Il ne convient pas aux enfants de moins de 3 ans.

⚠️ ADVERTENCIA: PELIGRO DE ASFIXIA.
Juguete que contiene partes pequeñas y una pelota pequeña.
No recomendado para niños menores de 3 años.

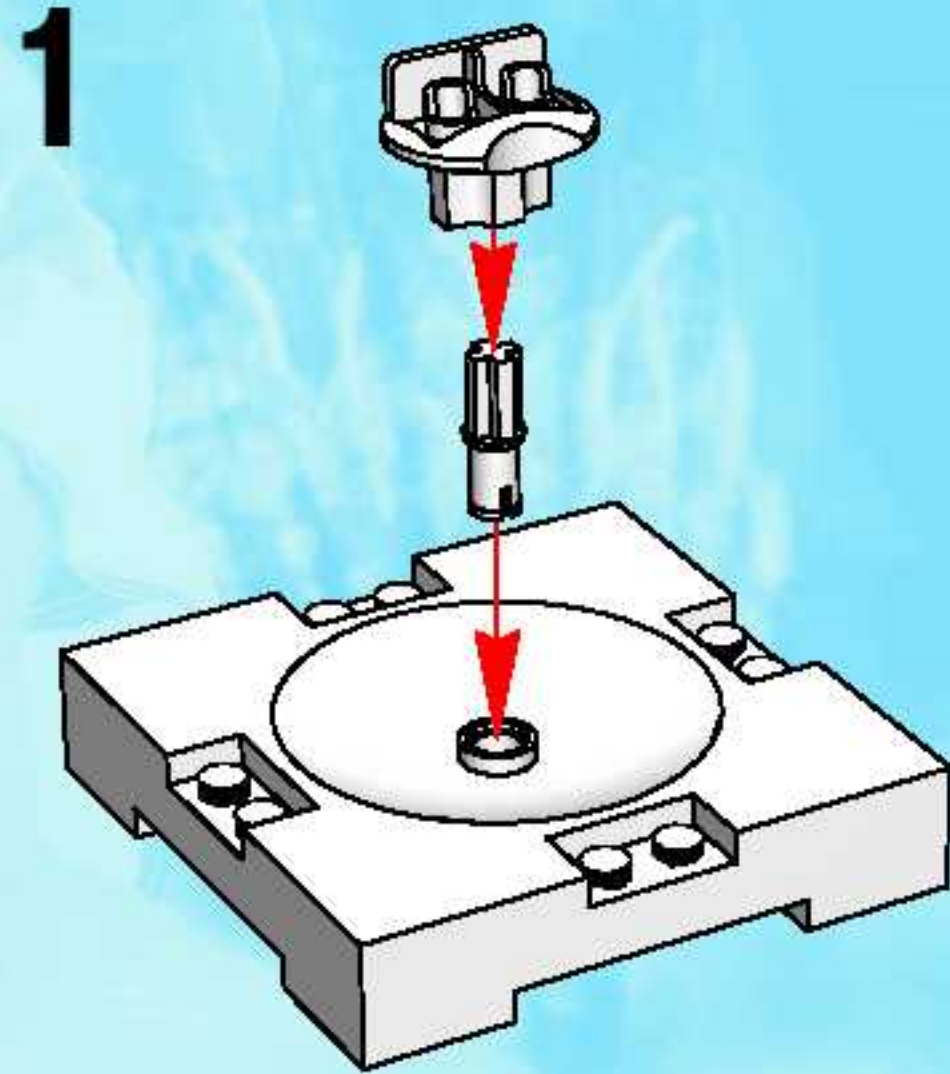
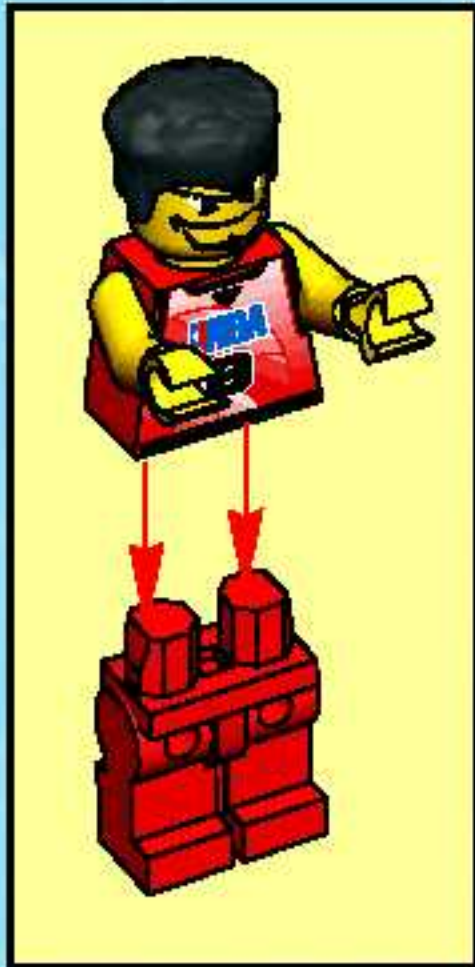

2

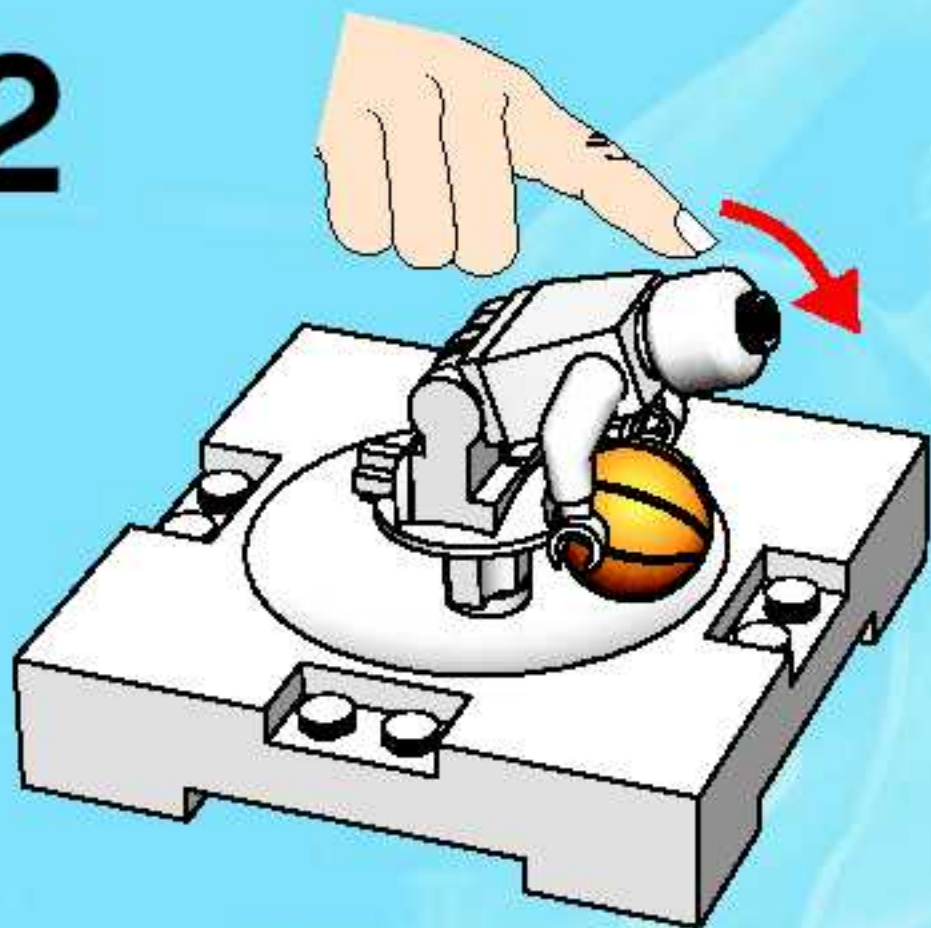

3

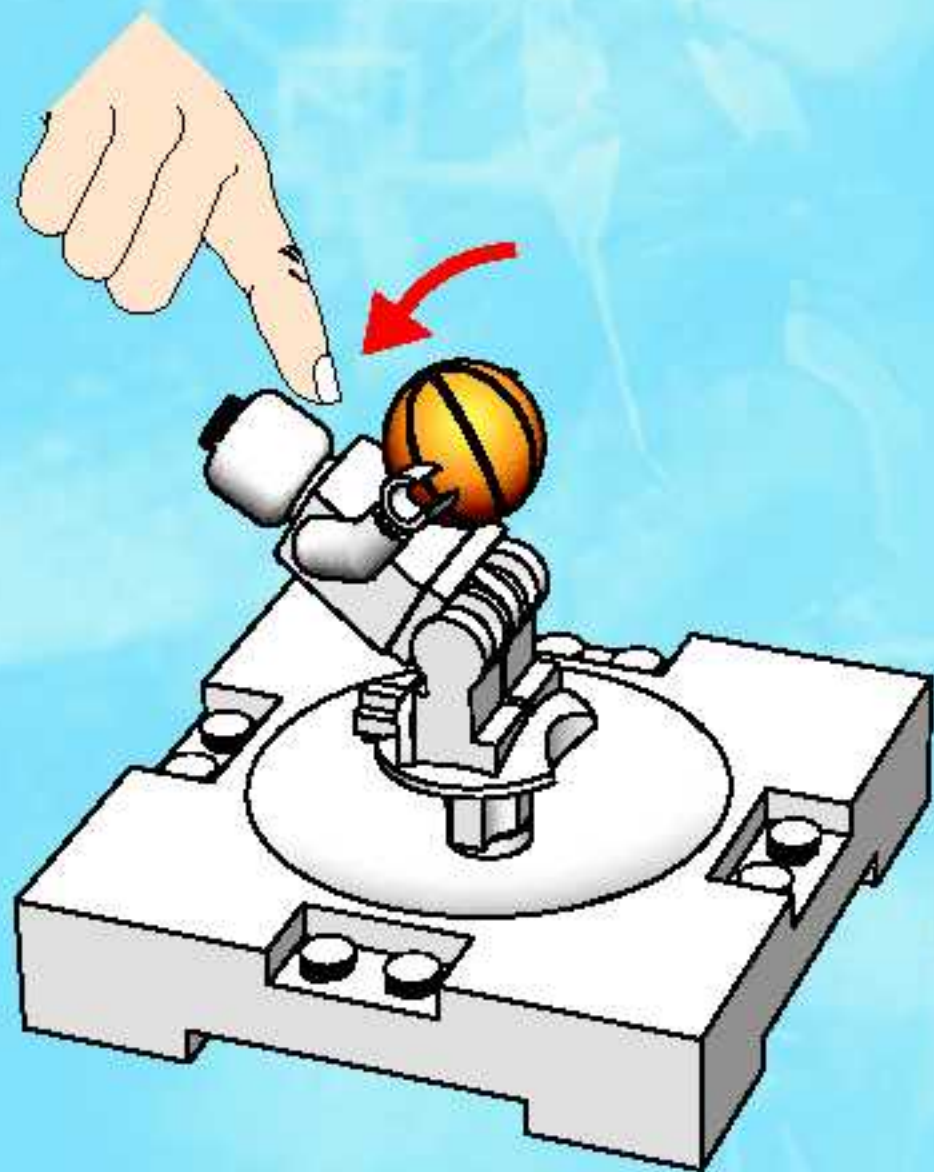

4

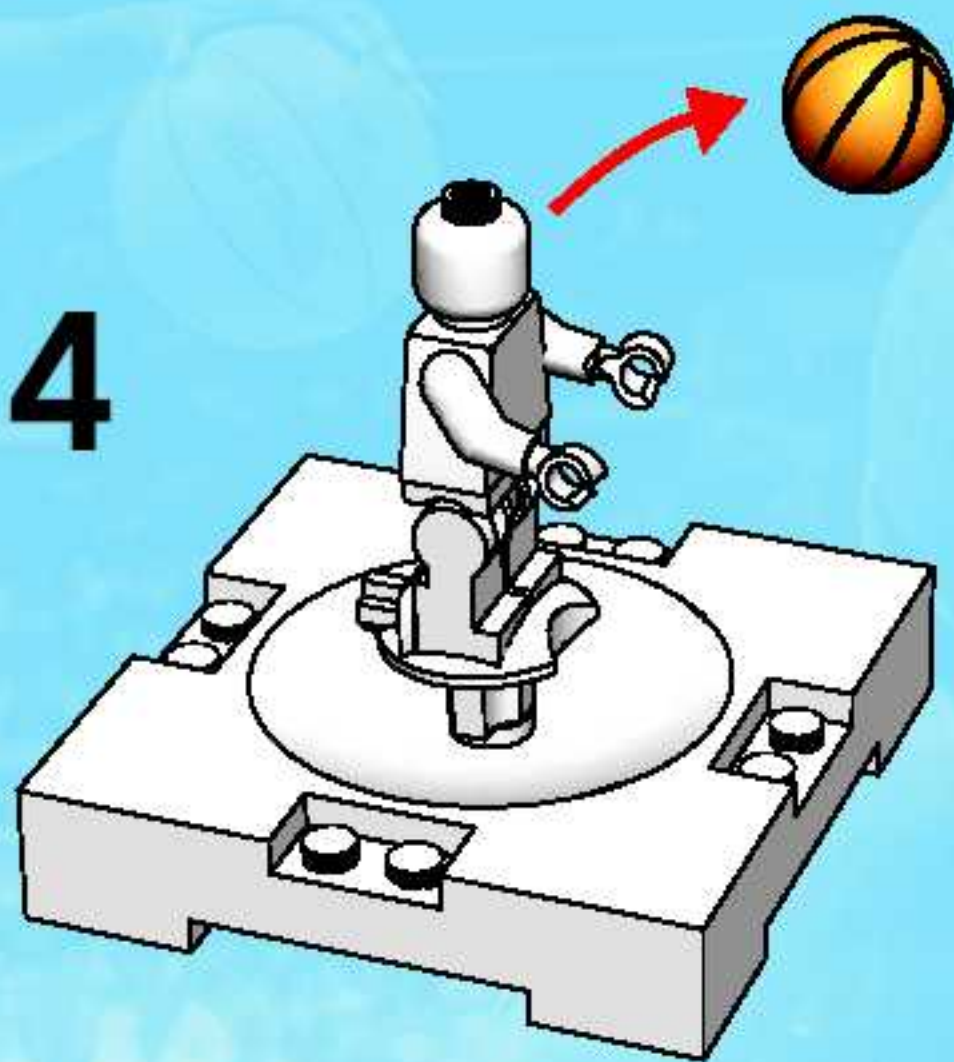

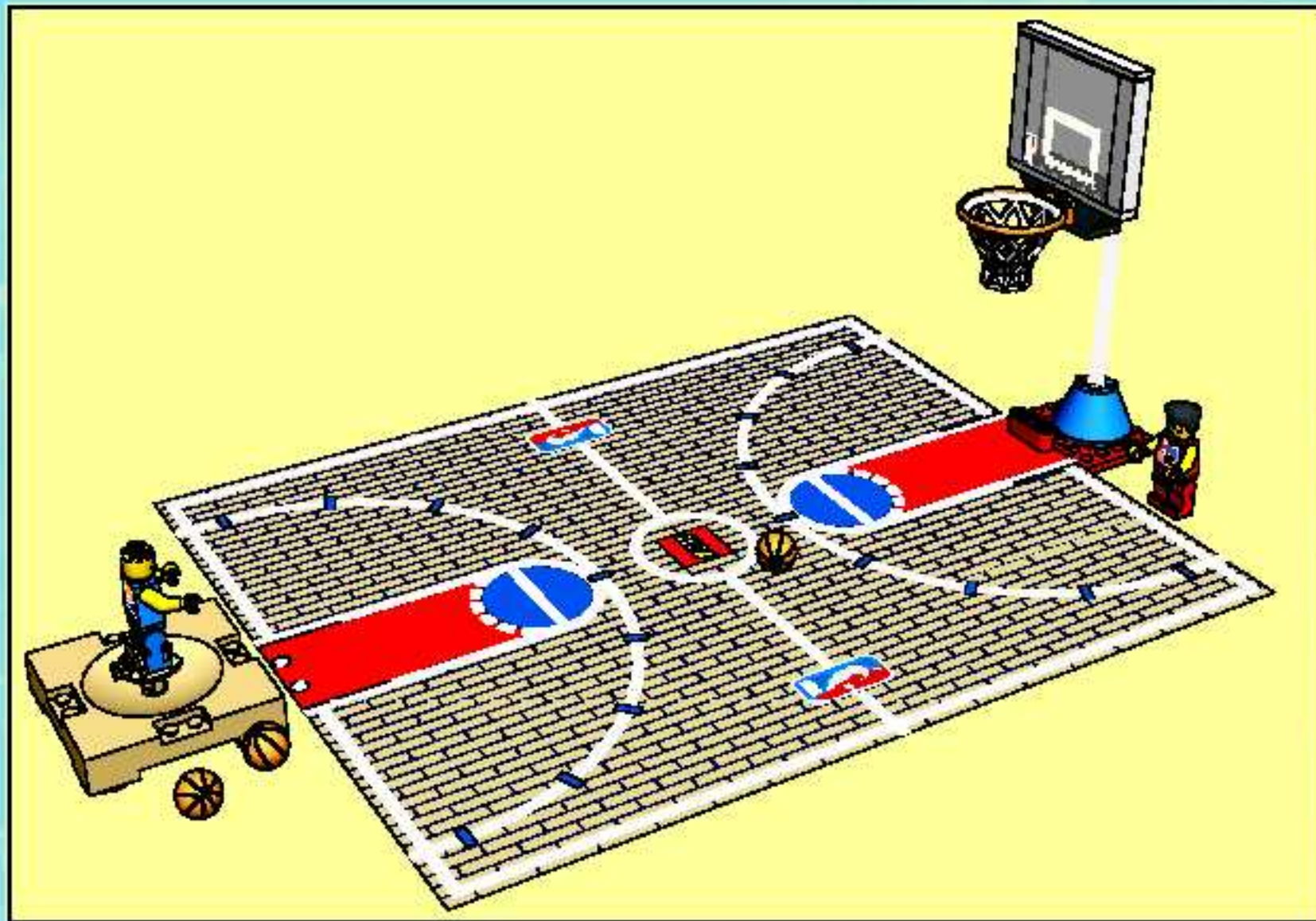

2

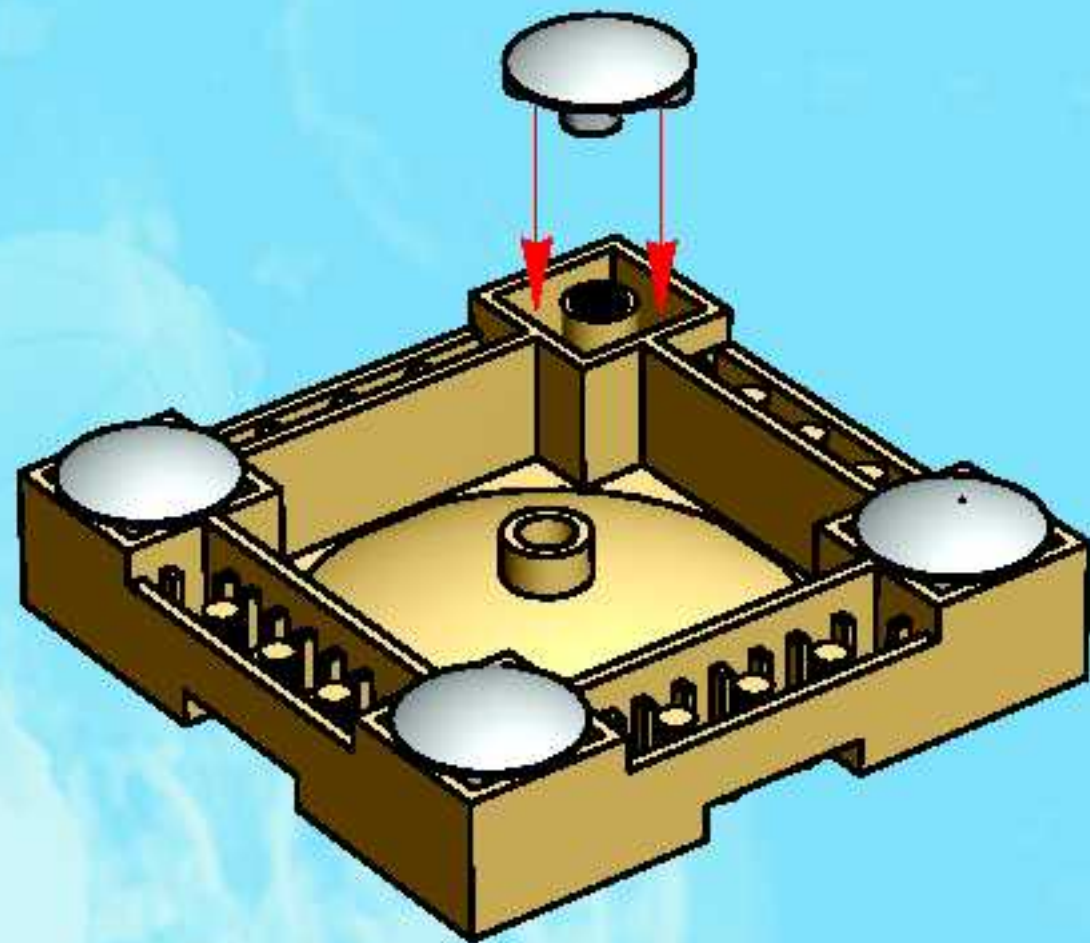

1

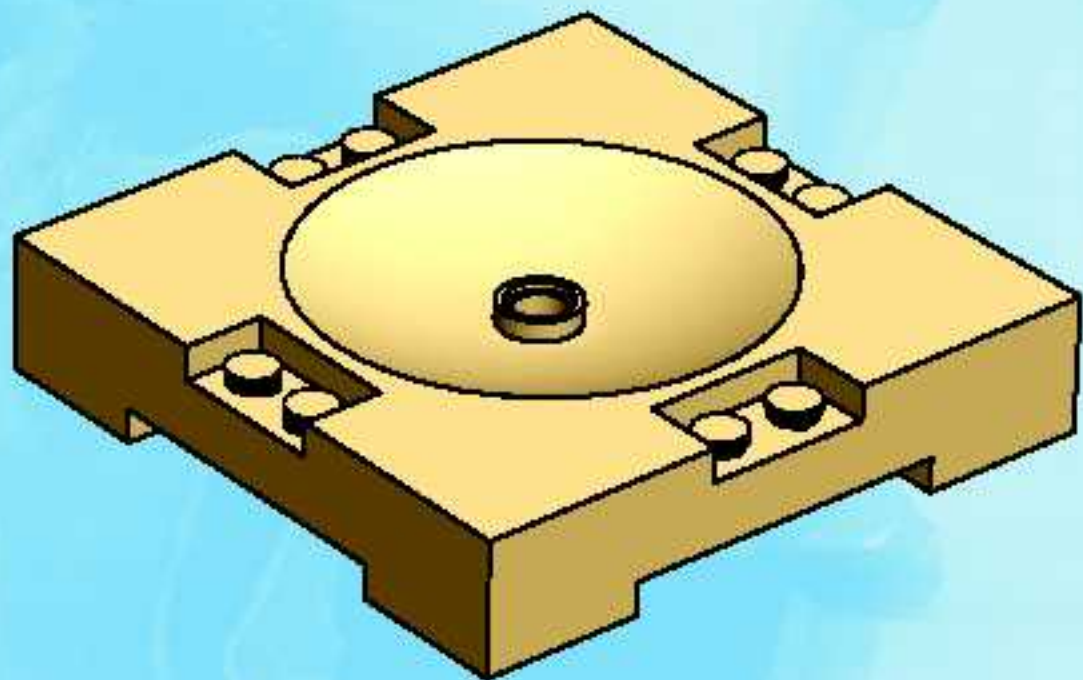

3

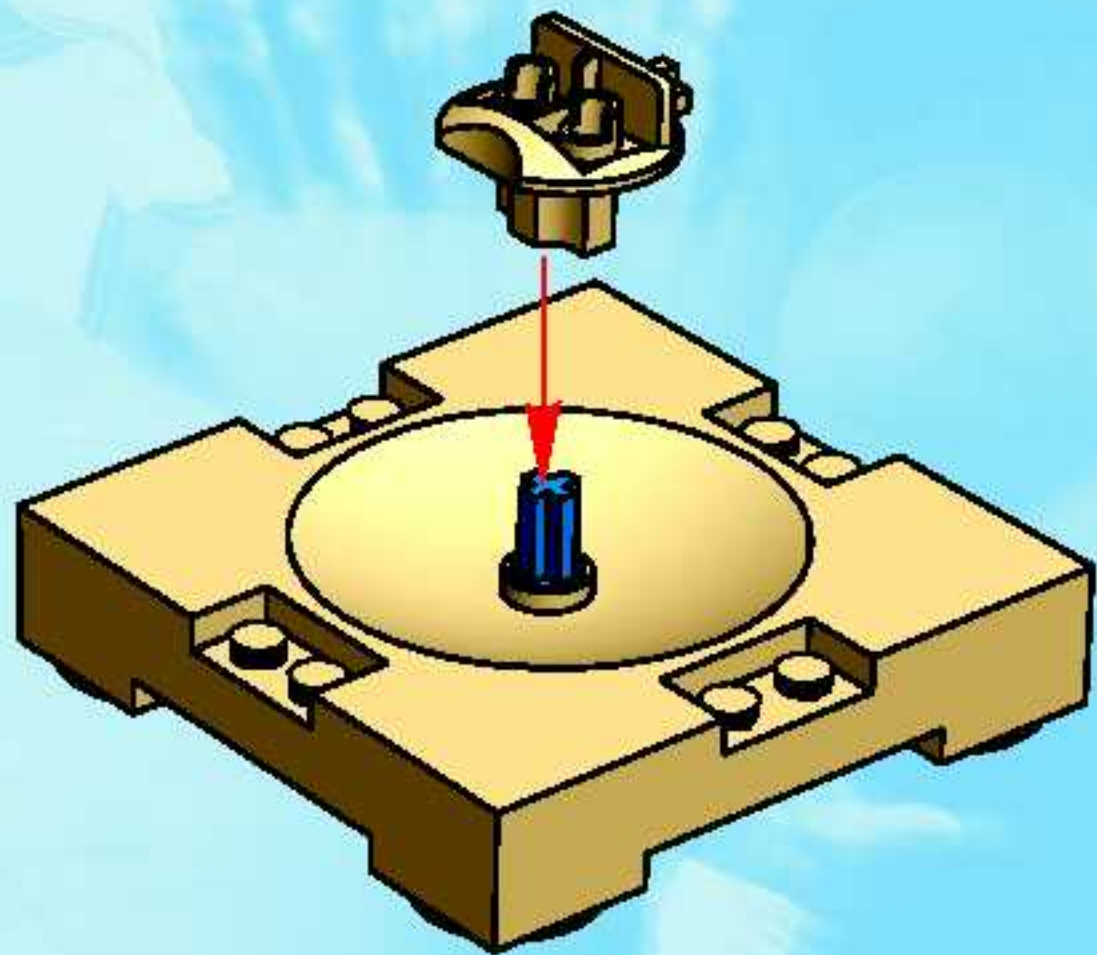

1

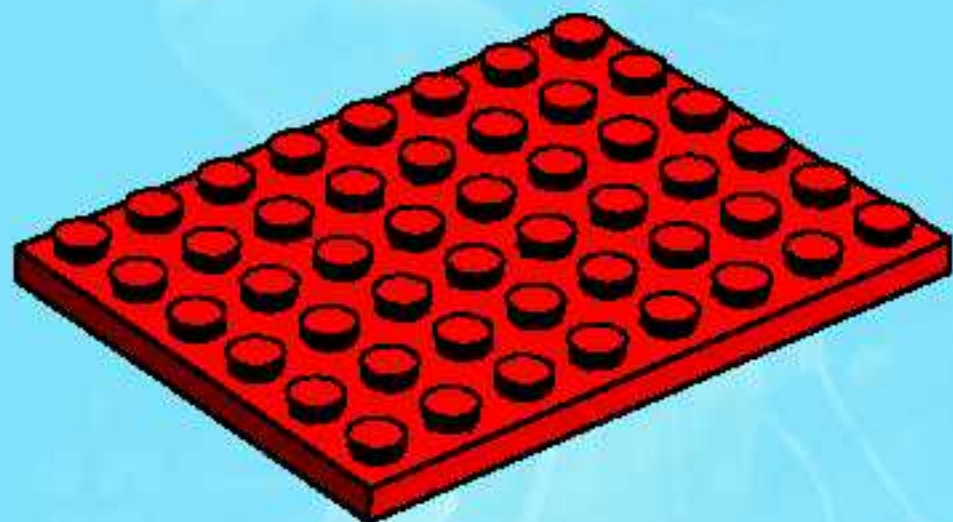

2

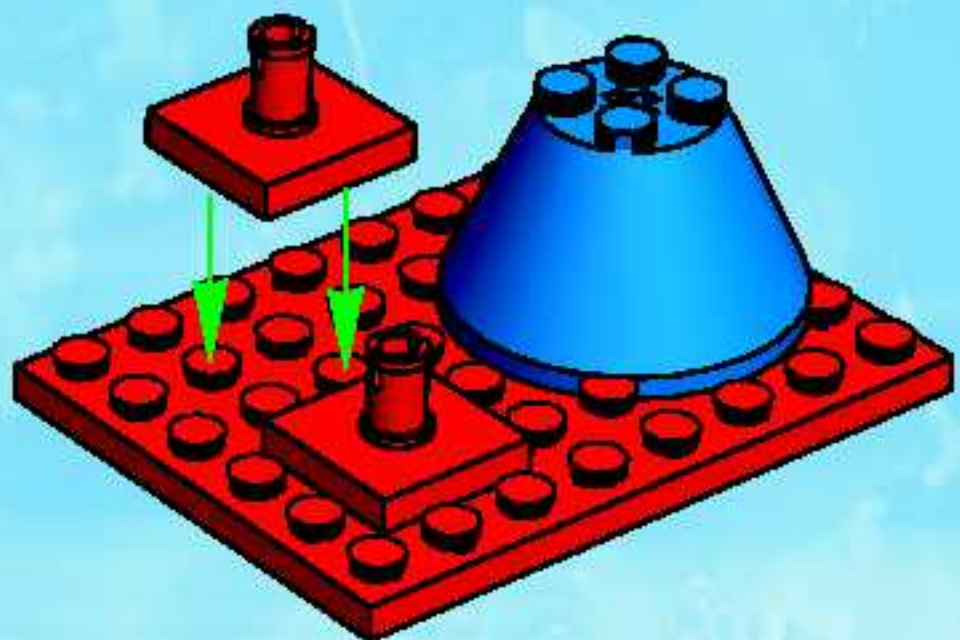

3

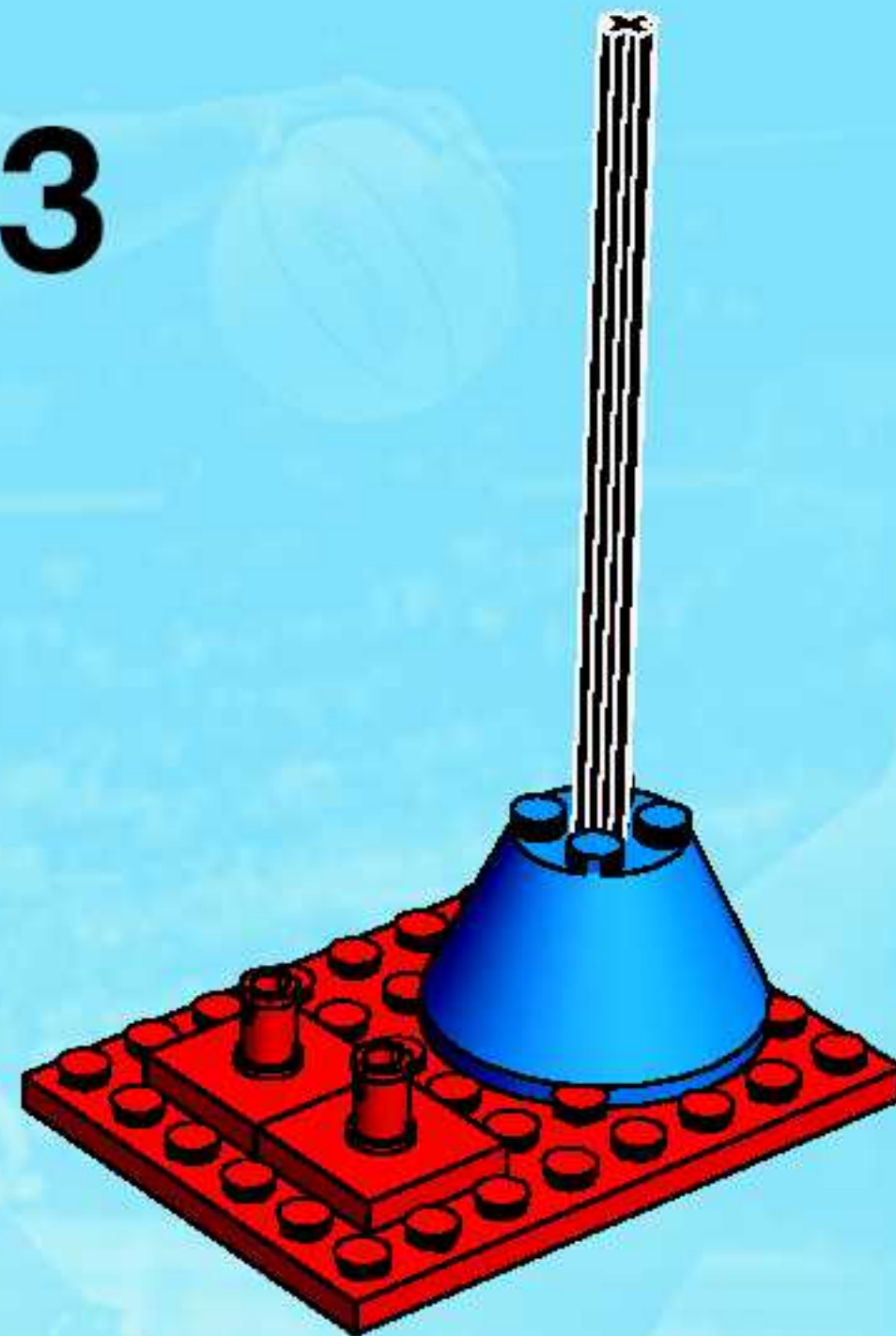

4

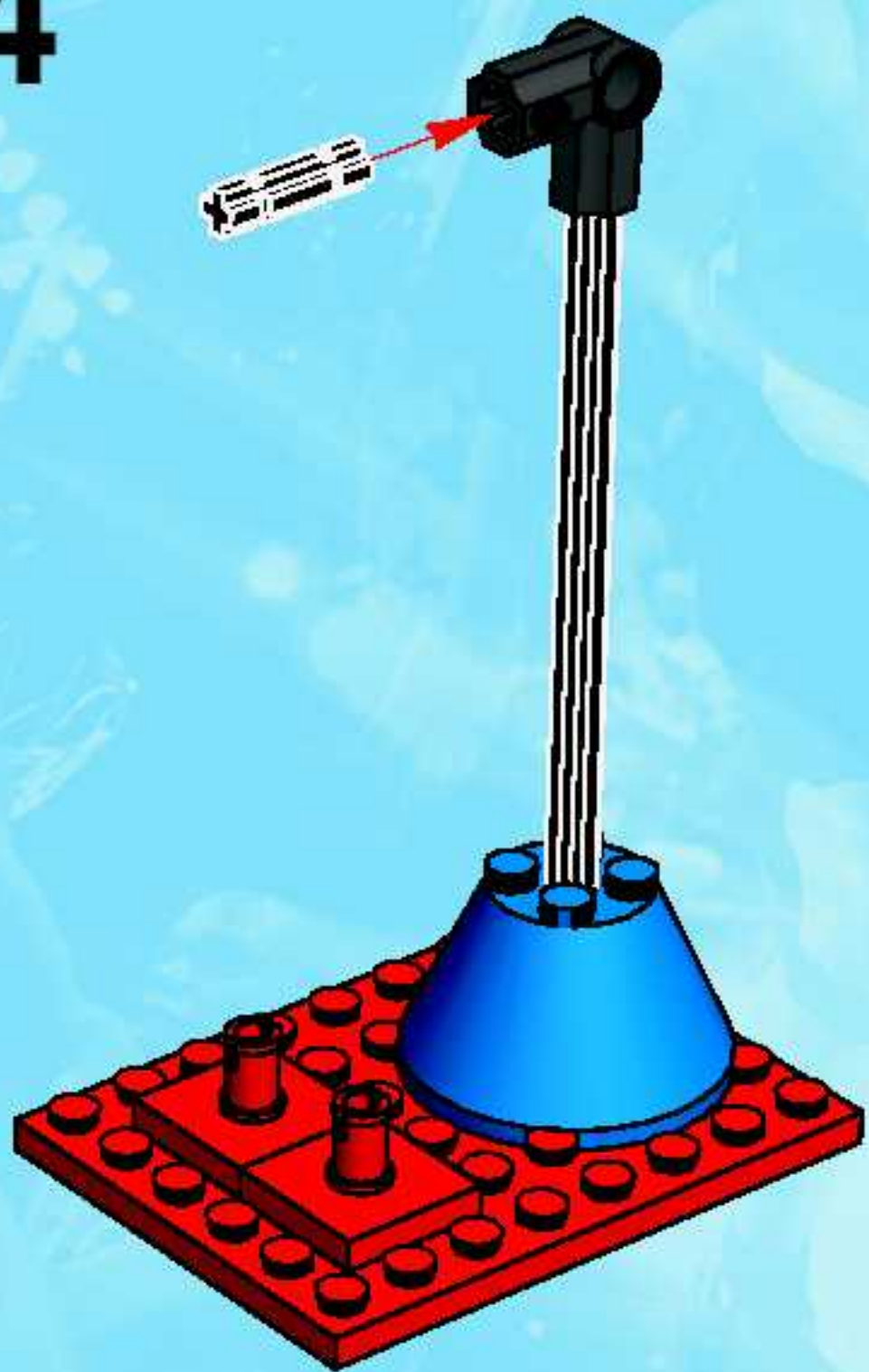

1

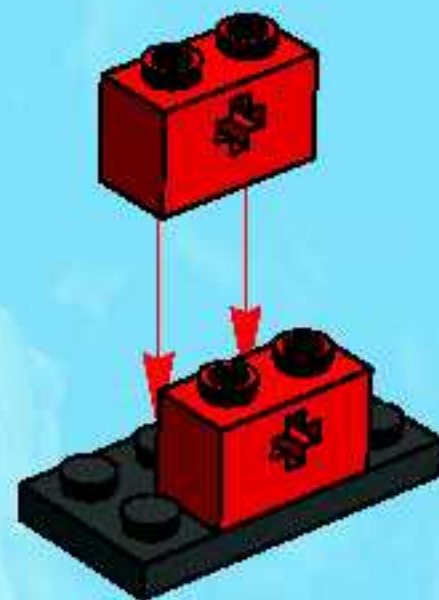

2



3

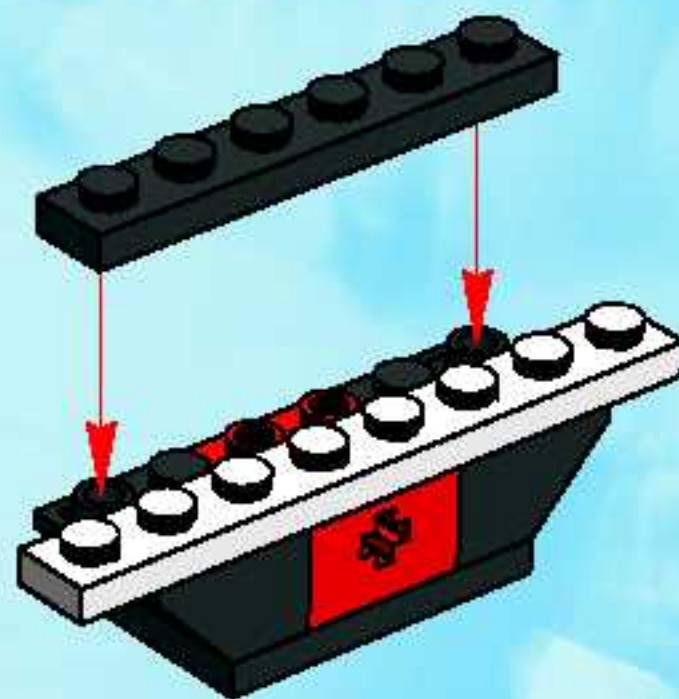

4

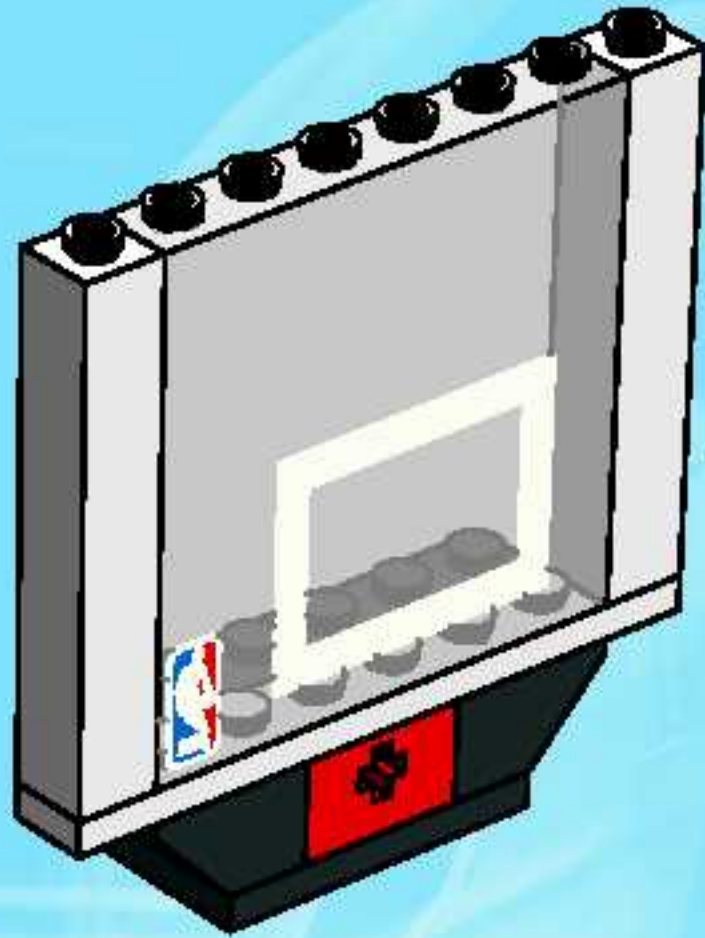

5

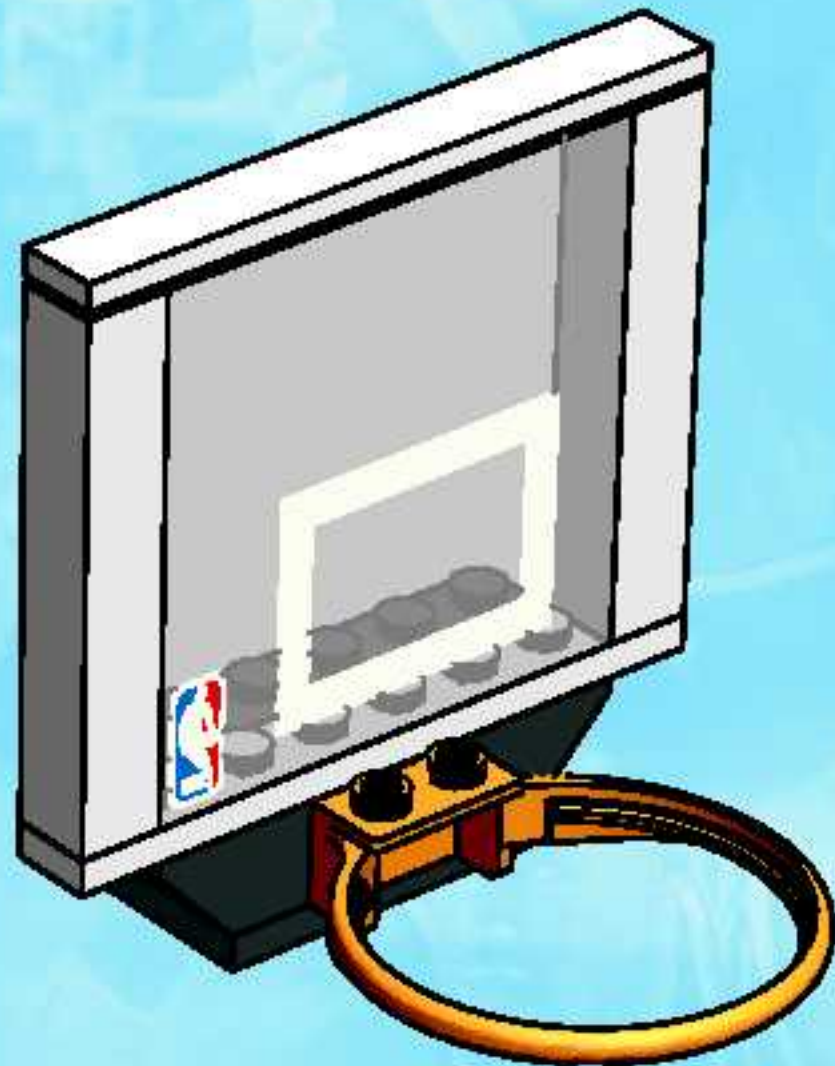

5

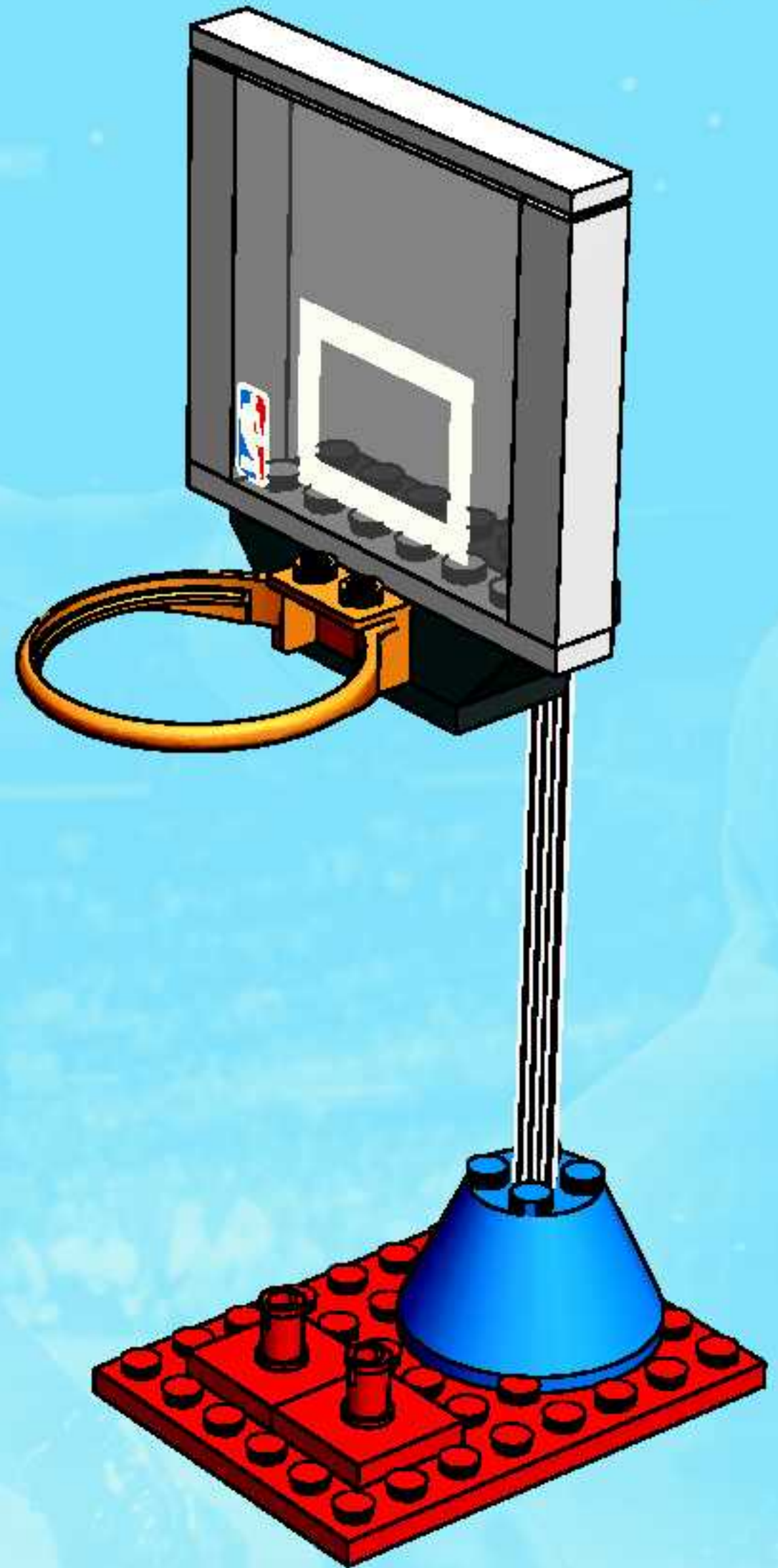

6

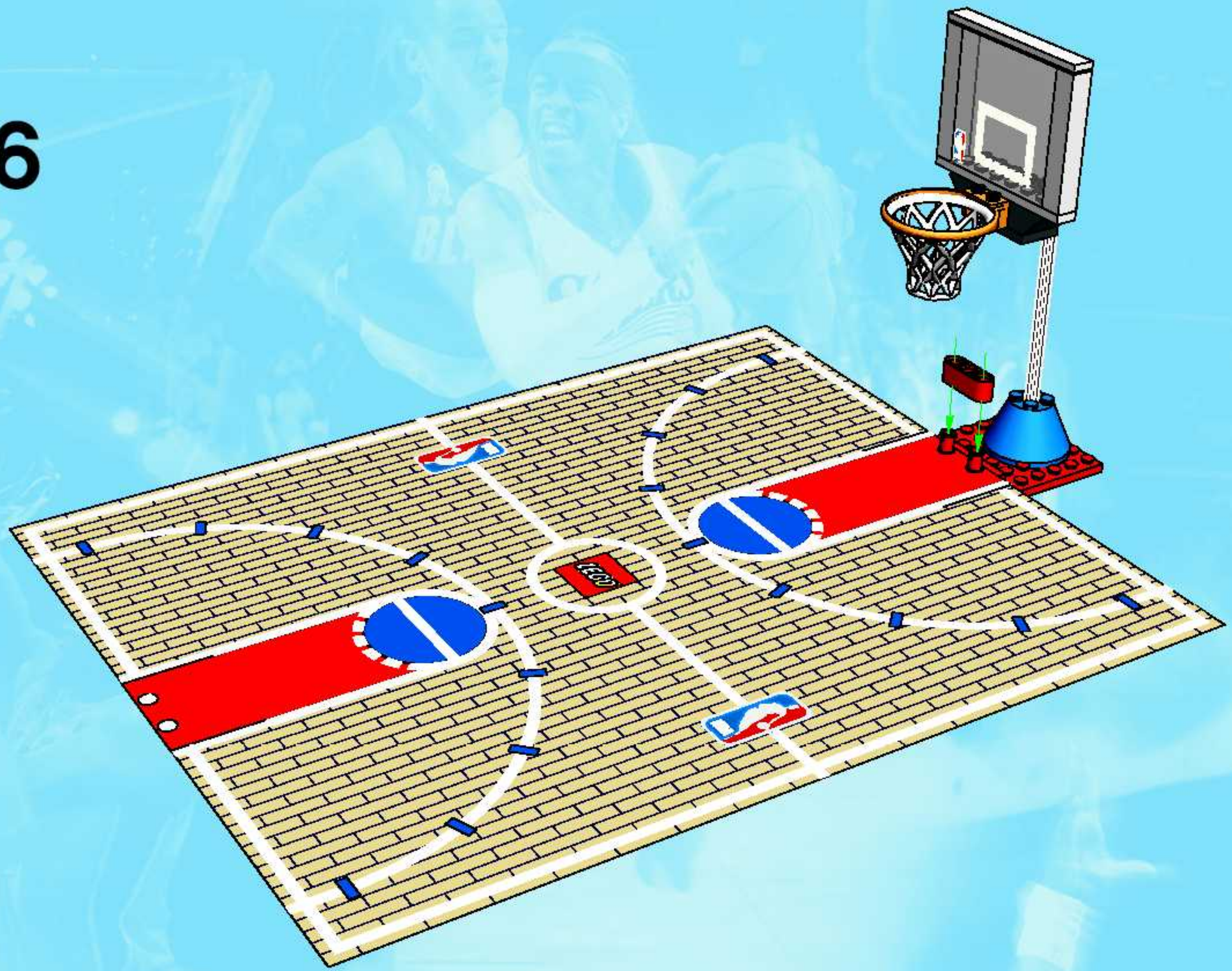

7

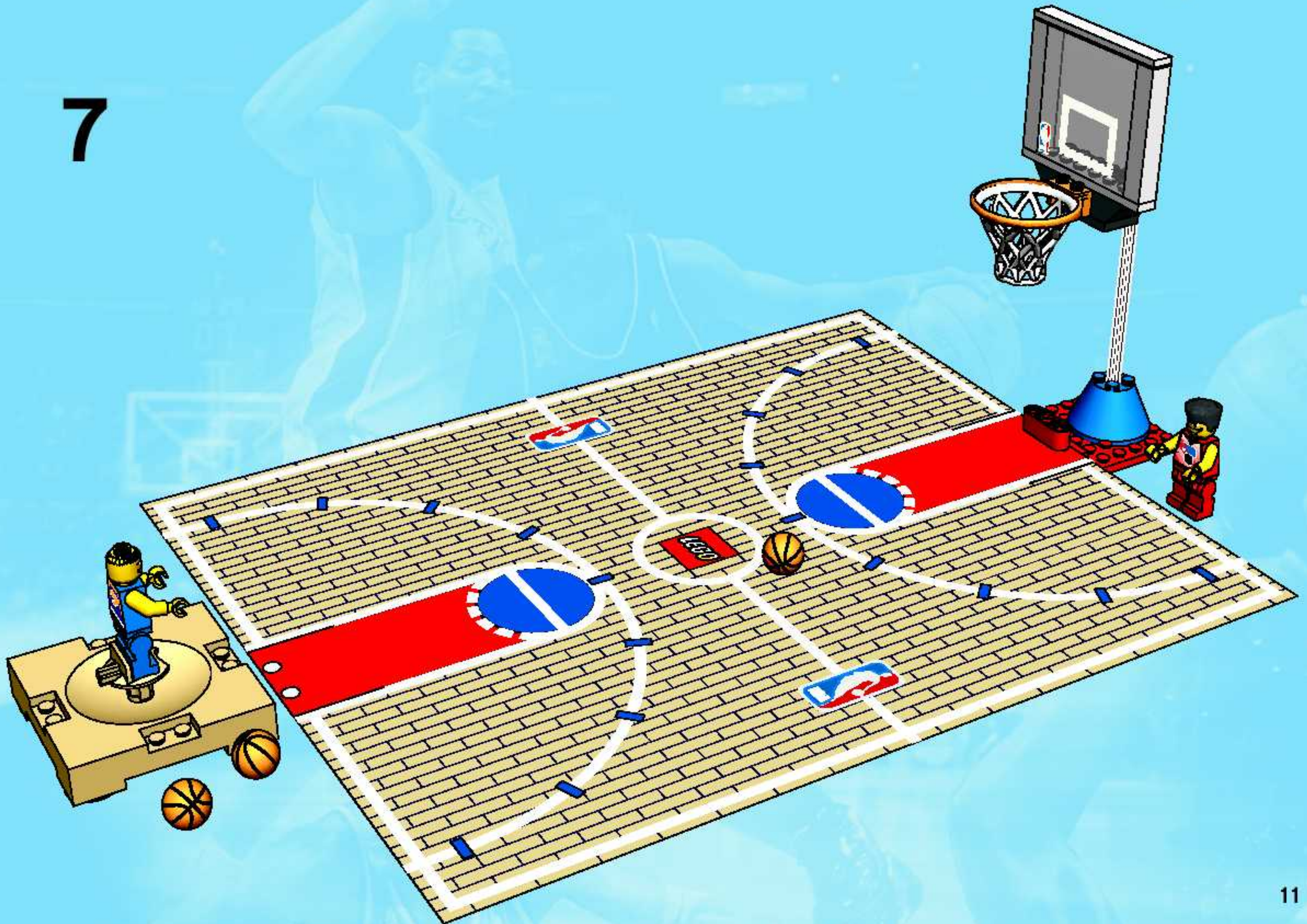



 www.LEGO.com

NBA  **.COM**

 **NBA**



#3428



#3427 + #3428





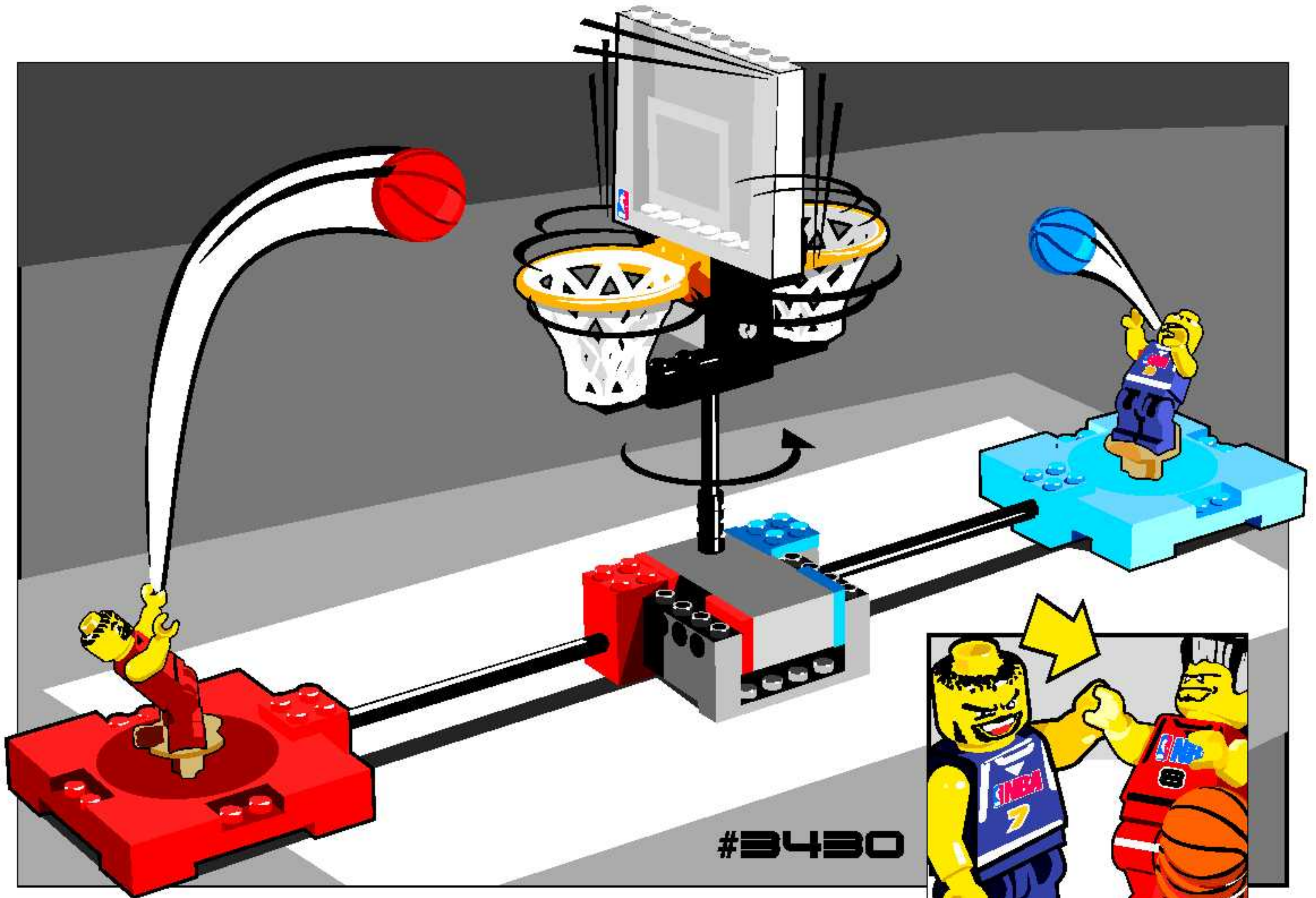

#3430



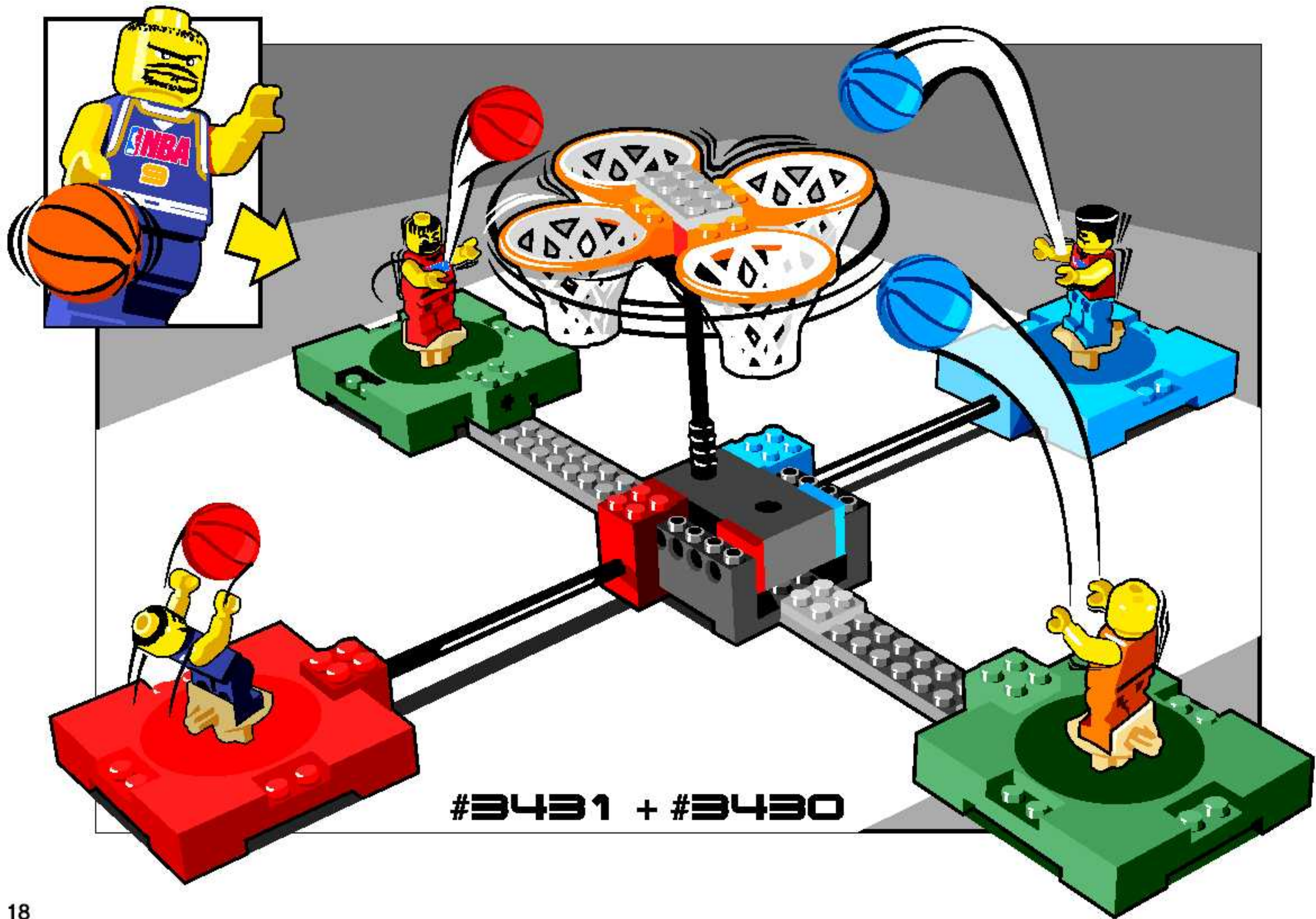

#3431 + #3430



#3431

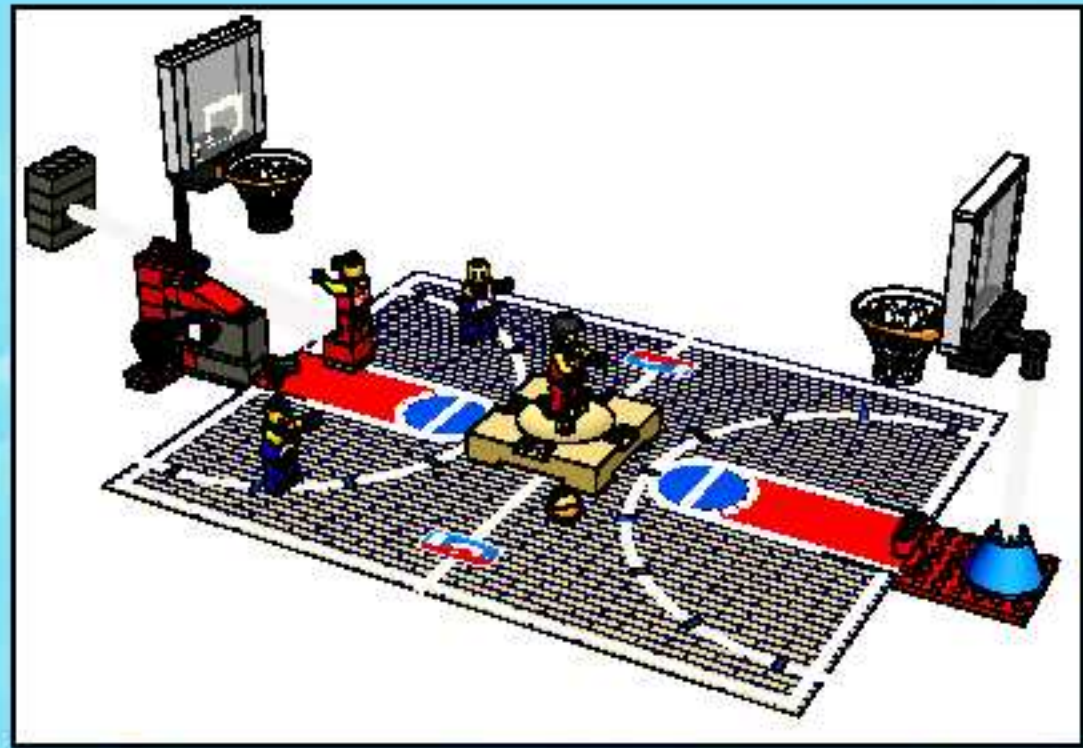

1

3429+3428

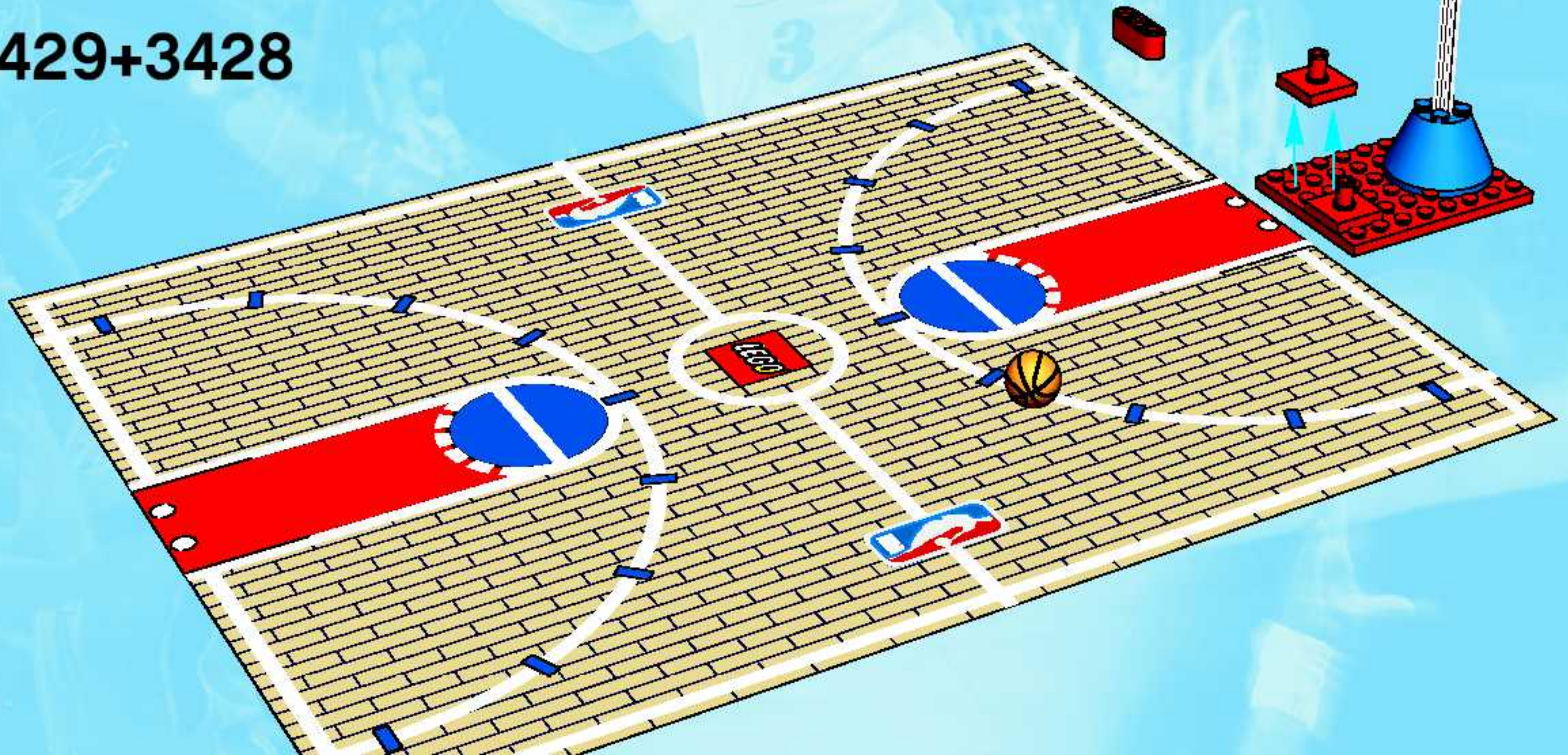

2

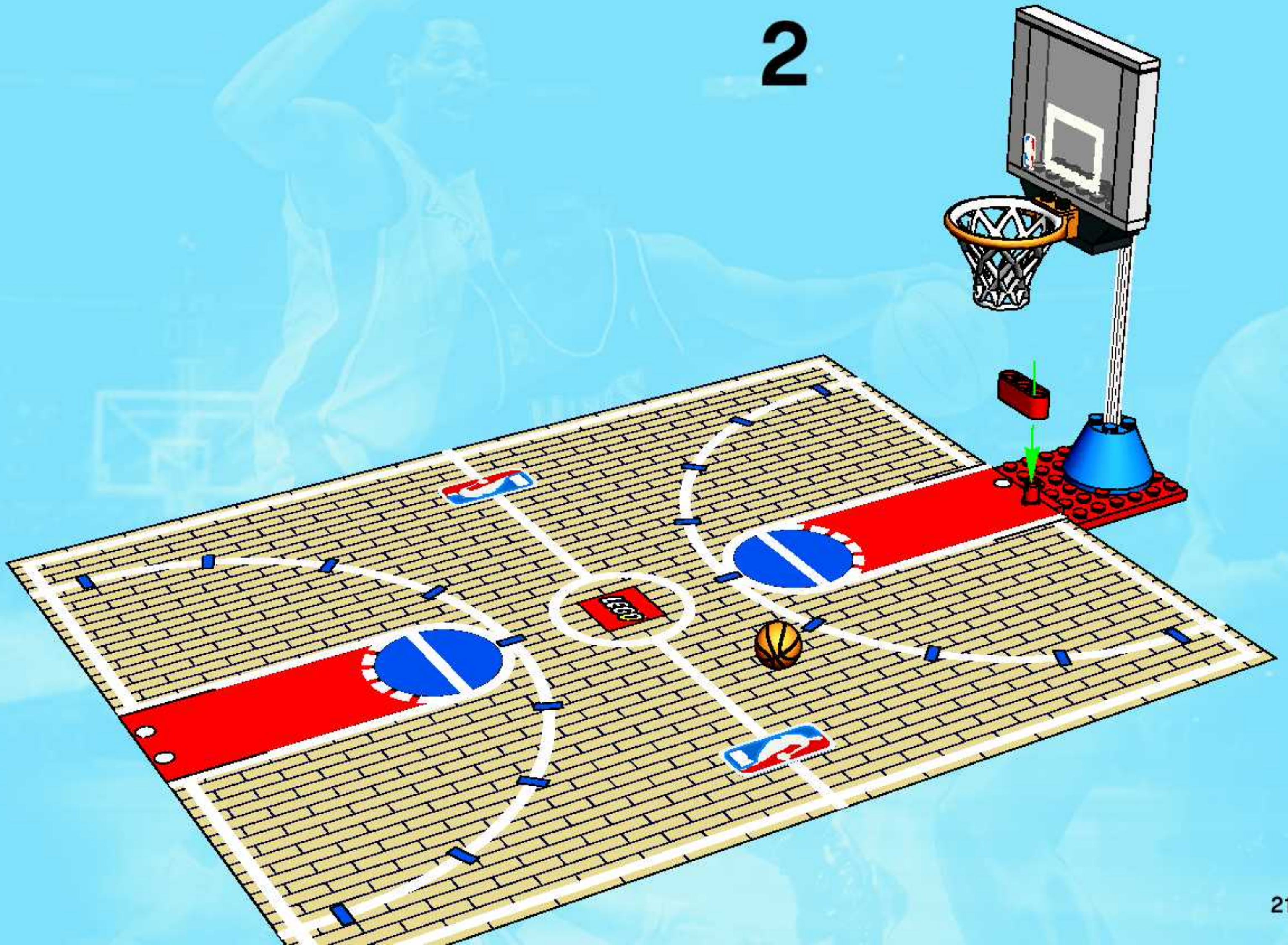



1

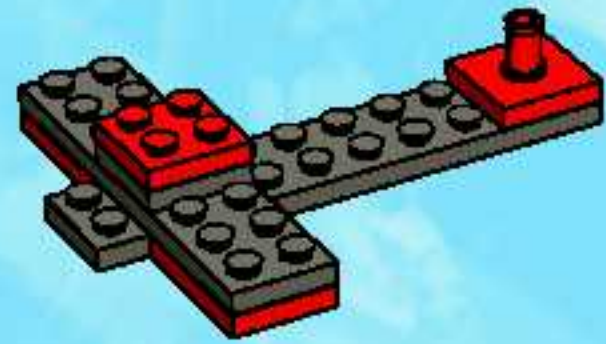

2

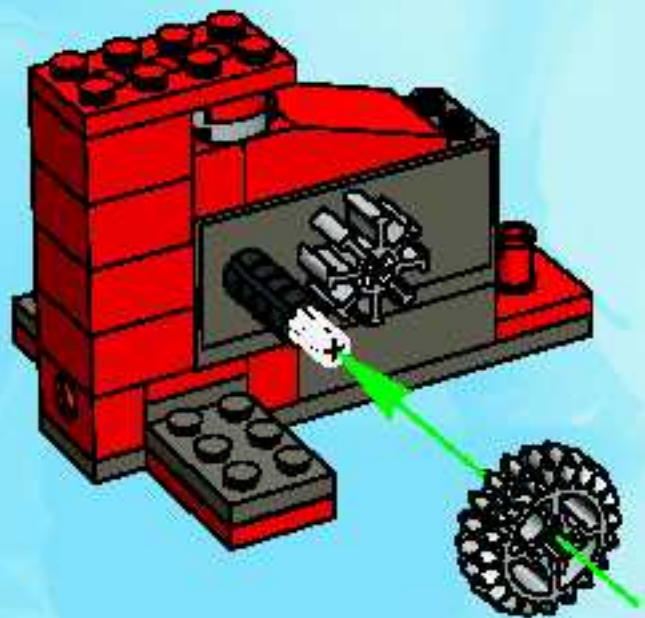

3



3





1

3427+3428

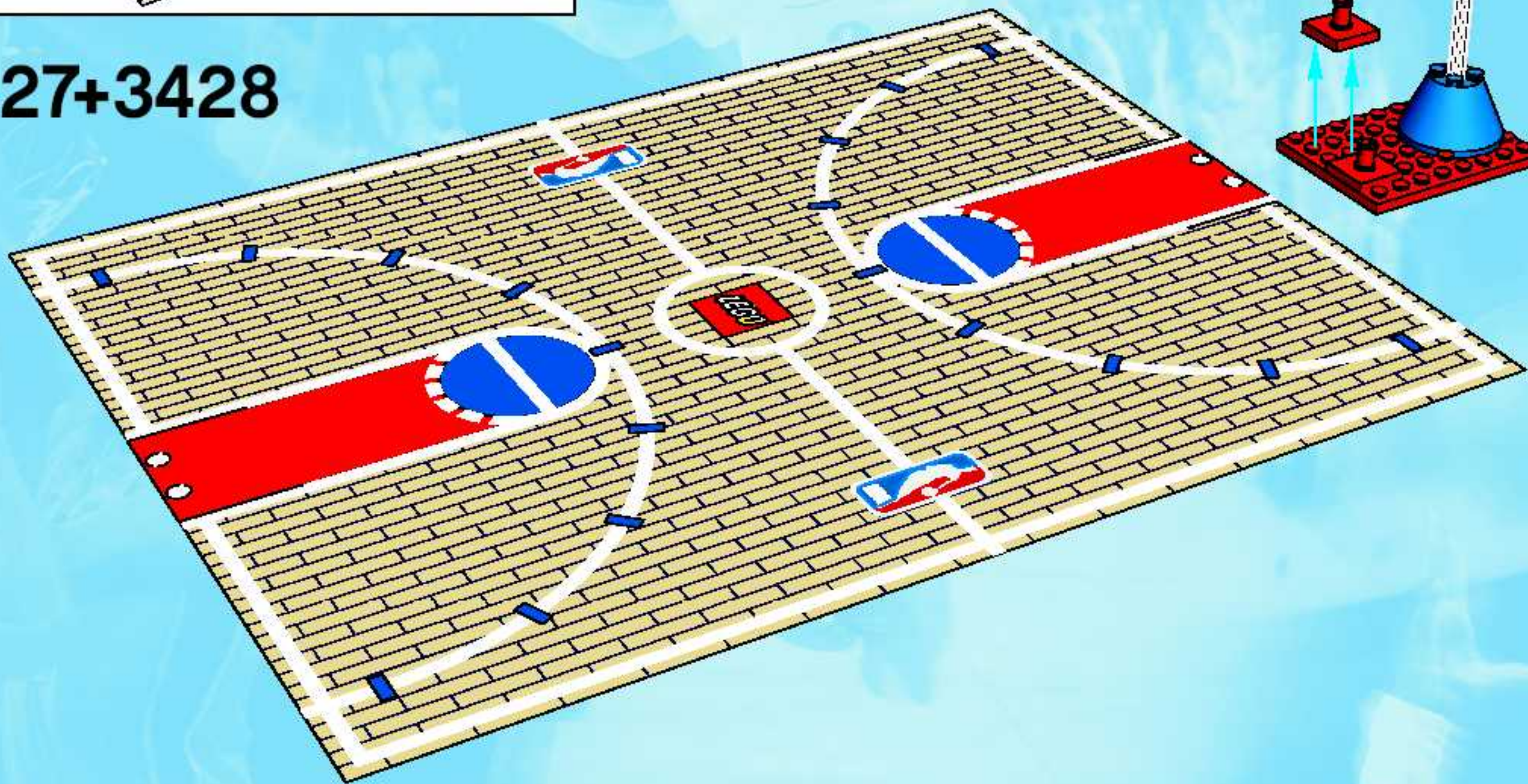

2



3



4

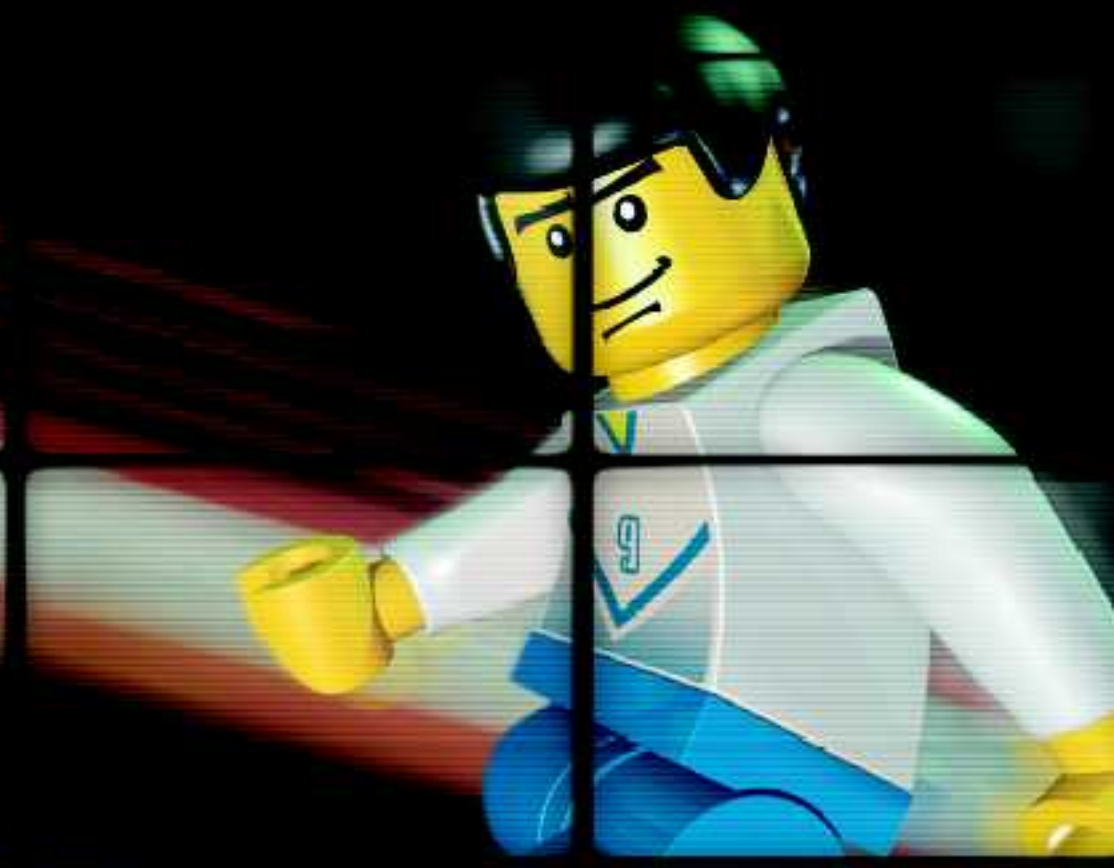

adidas, the adidas logo and the three stripe trademark are registered trademarks of the adidas-Salomon group, used with permission. Fevernova and the Trigon logo are trademarks of the adidas-Salomon group, used with permission.

adidas, le logo adidas et la marque aux trois bandes sont des marques déposées du groupe adidas-Salomon, utilisées avec sa permission. Fevernova et le logo Trigon sont des marques déposées du groupe adidas-Salomon, utilisées avec sa permission.

adidas, el logotipo adidas y el símbolo de tres bandas son marcas registradas del grupo adidas-Salomon y se utilizan con autorización. Fevernova y el logotipo Trigon son marcas registradas del grupo adidas-Salomon y se utilizan con autorización.

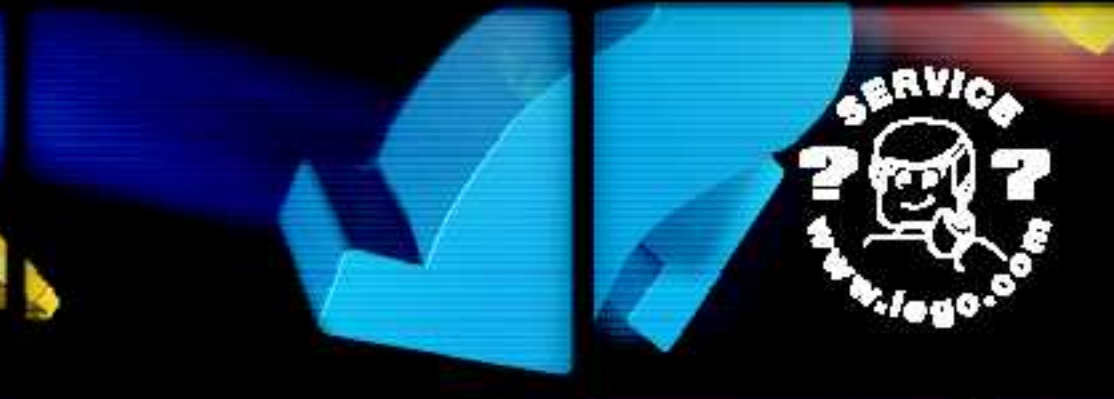

NBA identifications depicted are the exclusive property of NBA Properties, Inc. and/or the NBA Member Teams, and are used with permission.

Les identifications NBA reproduites sont la propriété exclusive de NBA Properties, Inc. et/ou des équipes membres de la NBA et sont reproduites sous autorisation.



SPALDING is a trademark of/est une marque de commerce de/ es una marca registrada de Spalding Sports Worldwide, Inc. or/ou/ Lisco Sports, Inc., a Spalding affiliate/une filiale de Spalding/un afiliado de Spalding. ©Spalding Sports Worldwide, Inc. 2003.

Las identificaciones retratadas de la NBA son propiedad exclusiva de NBA Properties, Inc. y/o de los miembros de los equipos de la NBA, y son usados bajo permiso.

LEGO and the LEGO logo are trademarks of/son des marques de commerce de/ son marcas registradas de LEGO Group. ©2003 The LEGO Group.



www.LEGO.com

