

1

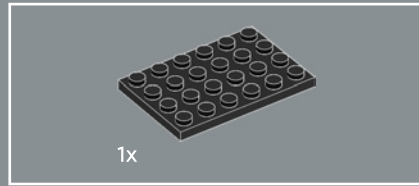

2

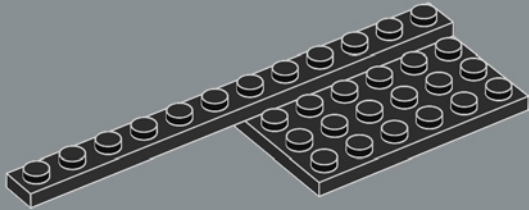

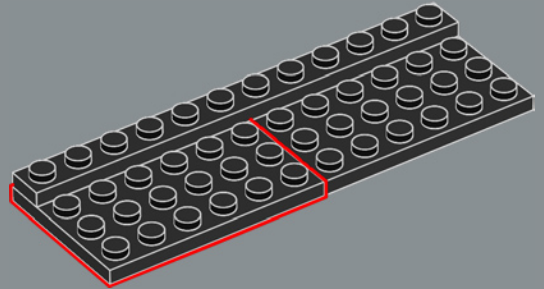
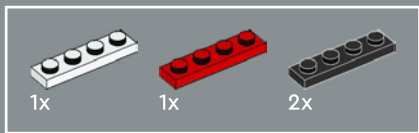

3

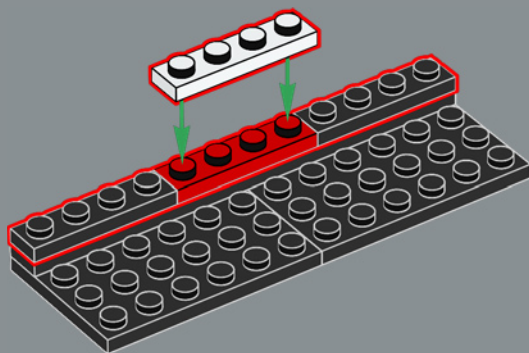

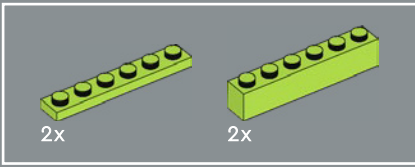

4

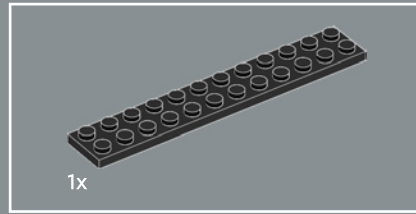
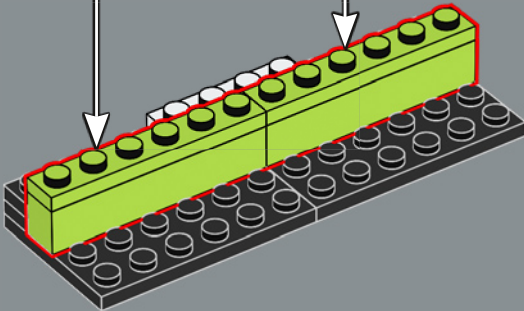
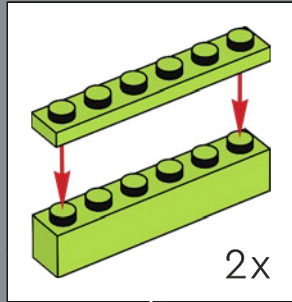

5

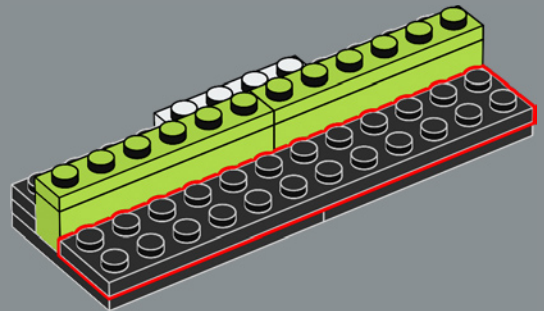

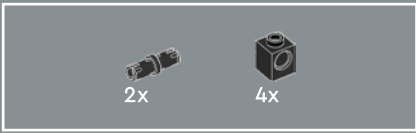

6

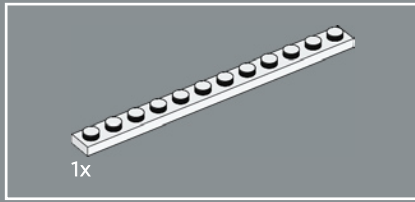
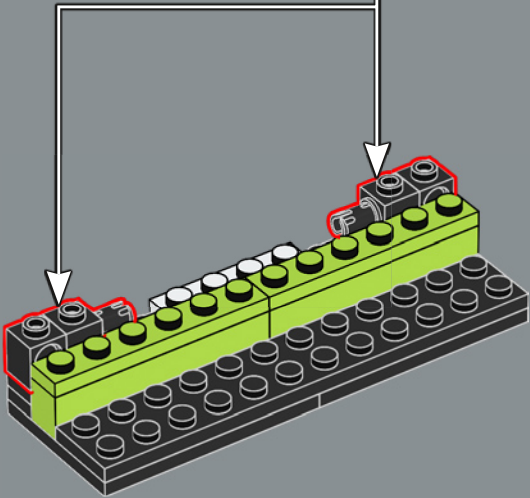
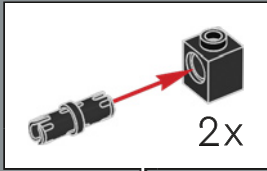

7

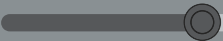
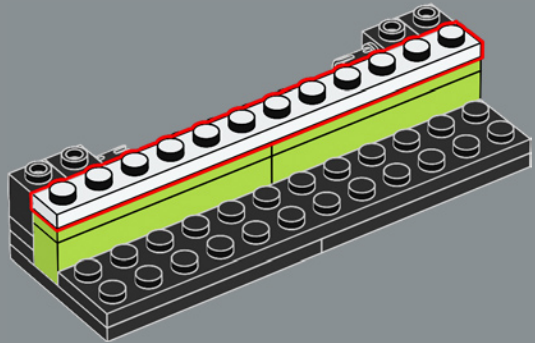

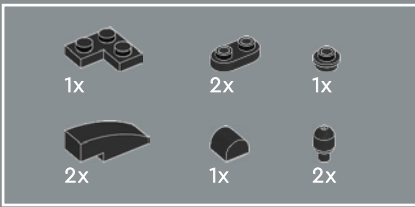

8

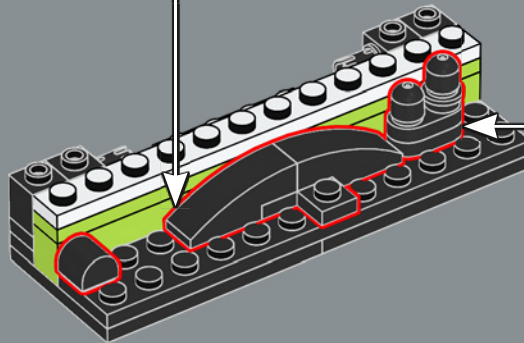
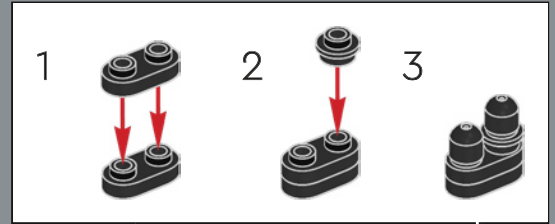
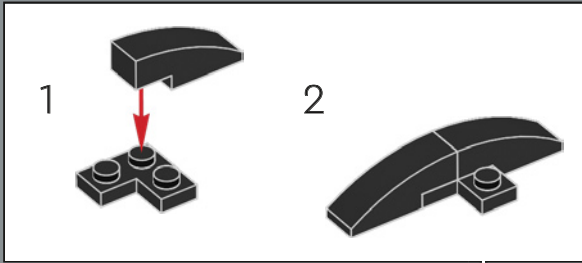



9

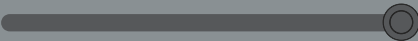
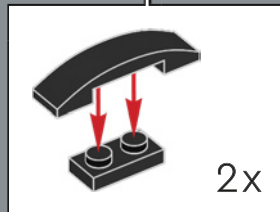
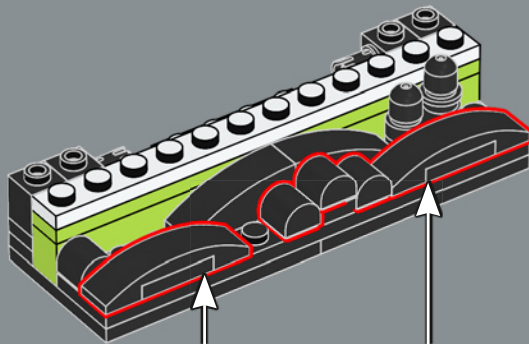



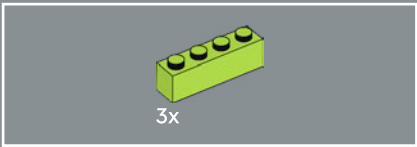

10

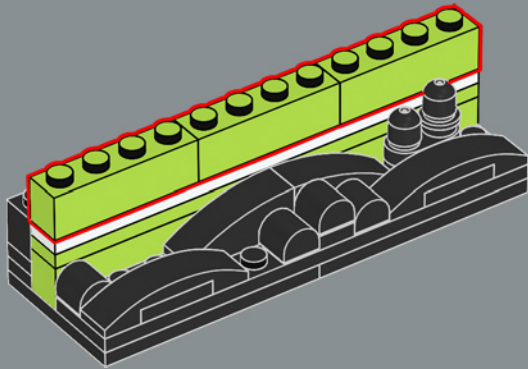
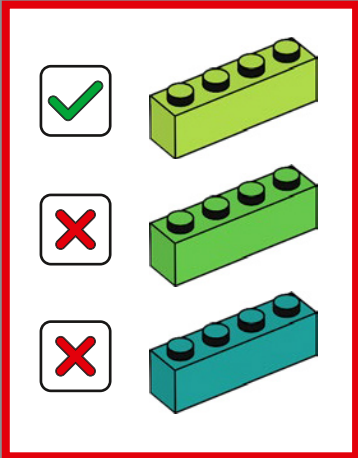

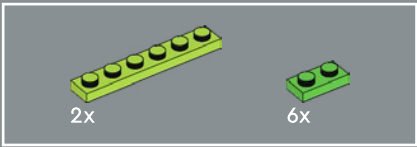

11

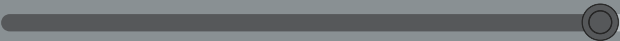
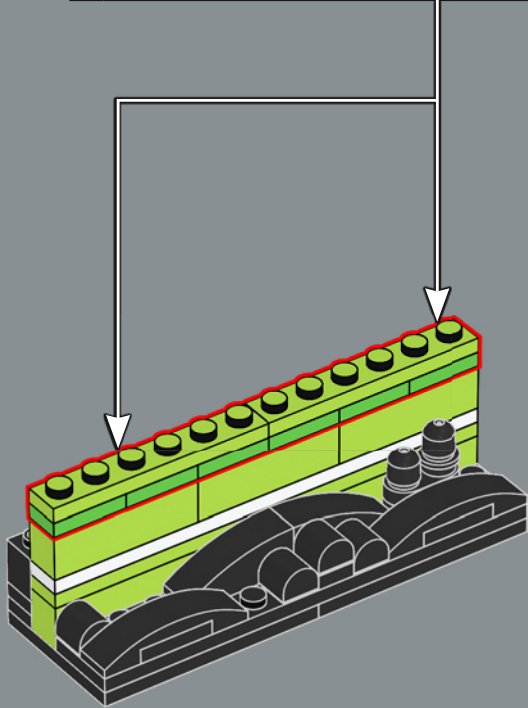
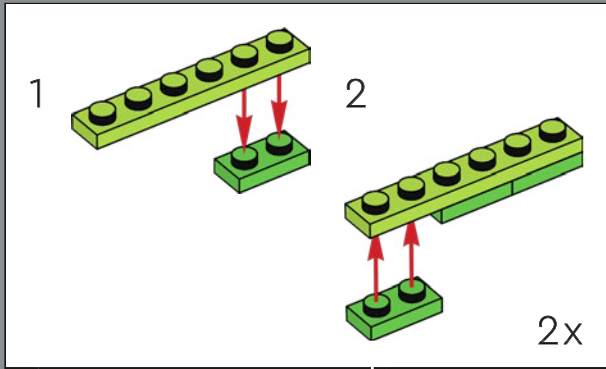

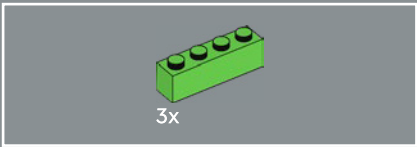

12

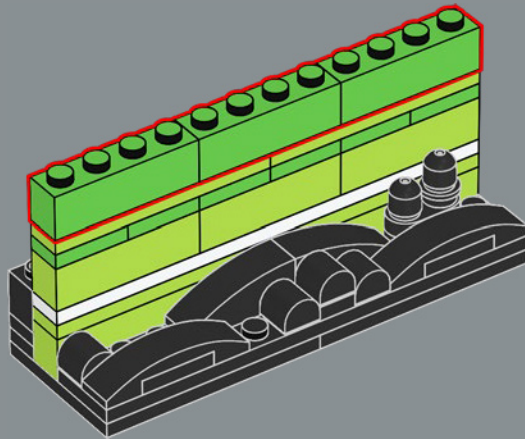
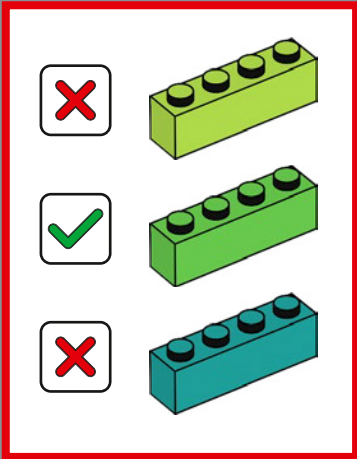

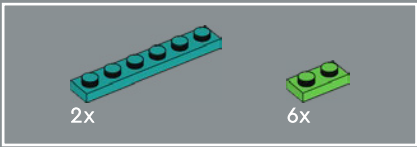

13

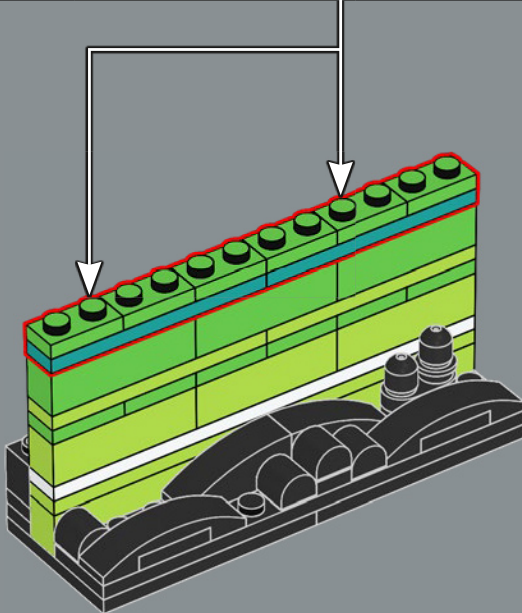
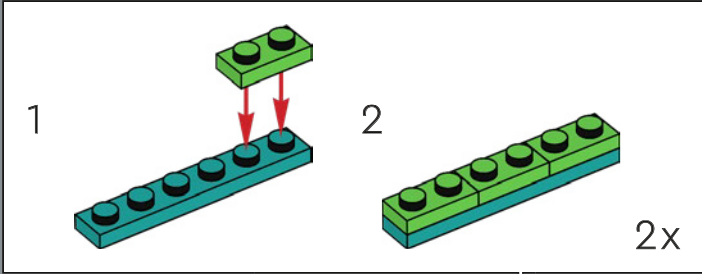

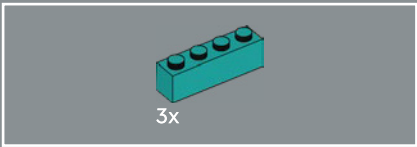

14

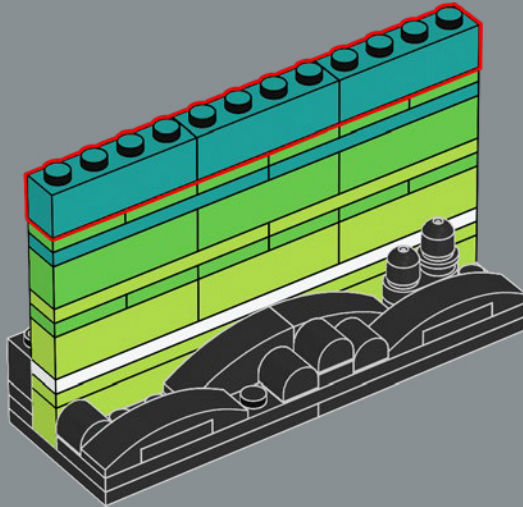
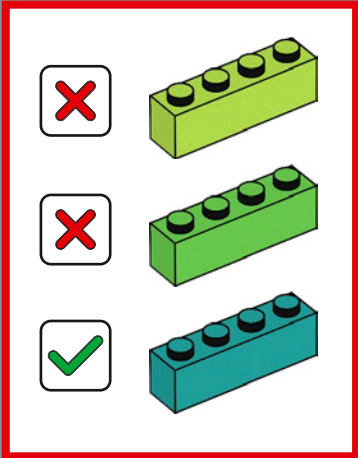

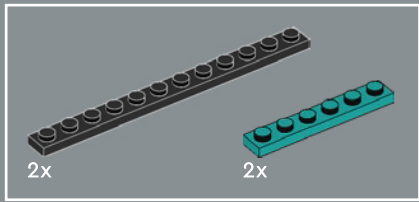

15

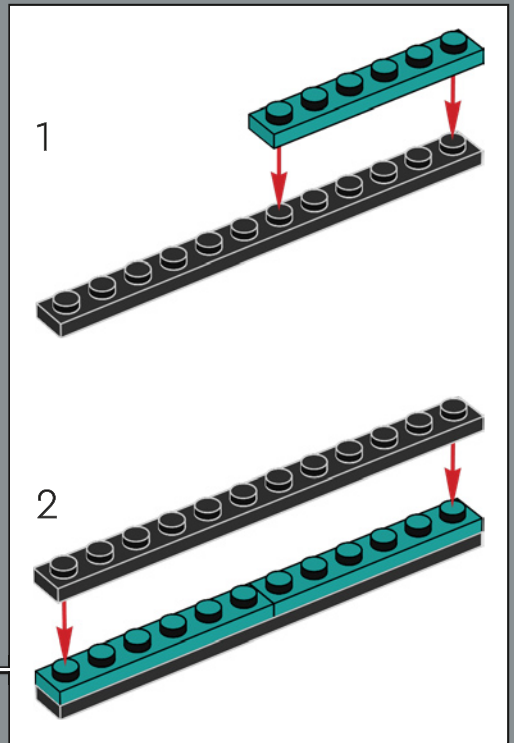
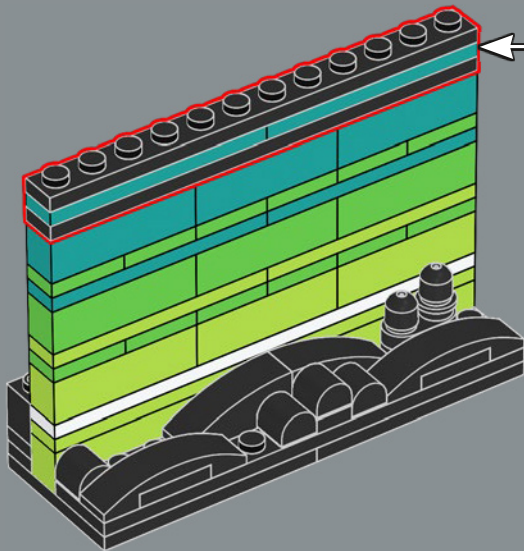

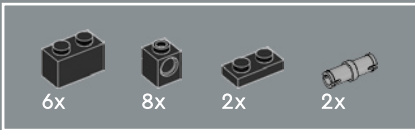

16

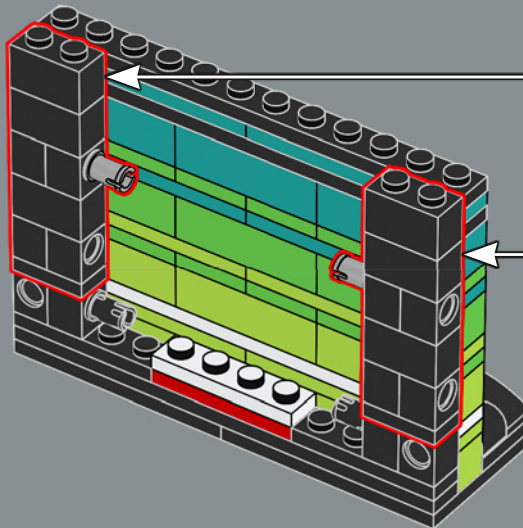
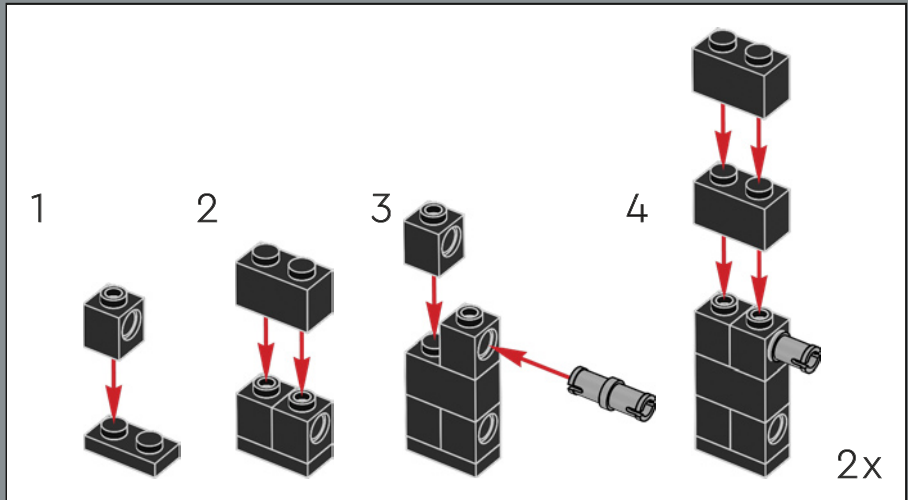







2x



4x

18

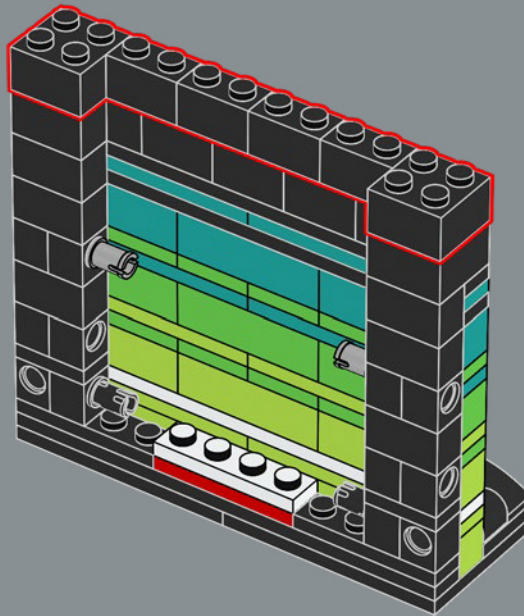

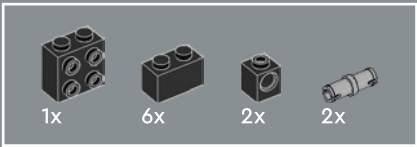

19

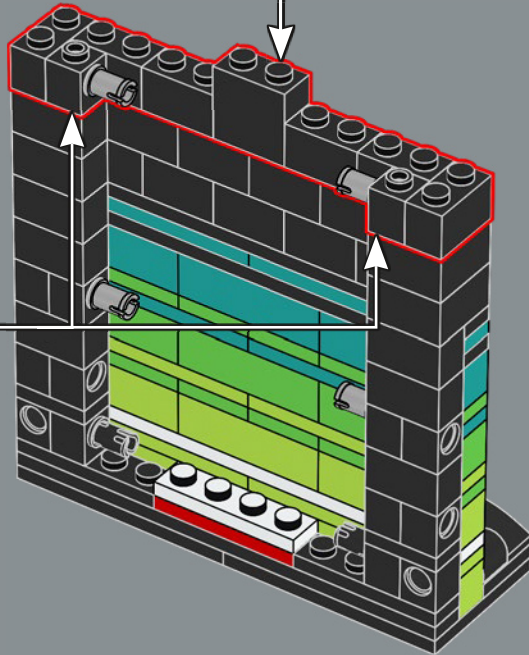
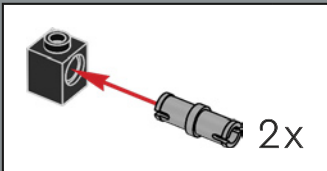
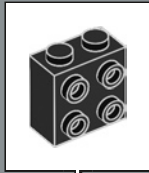

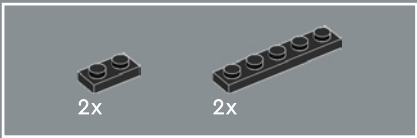

20

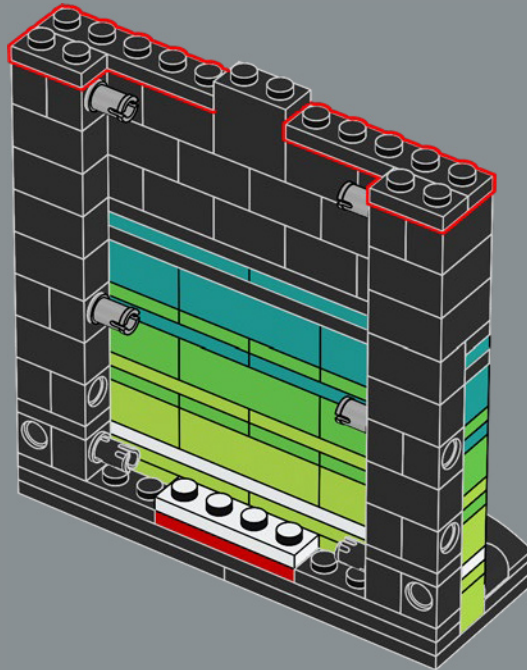



2x



2x



2x

21

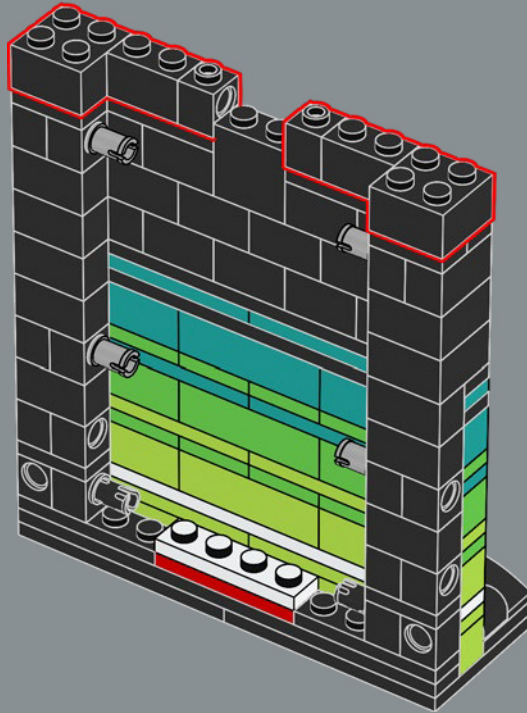



2x



2x

22

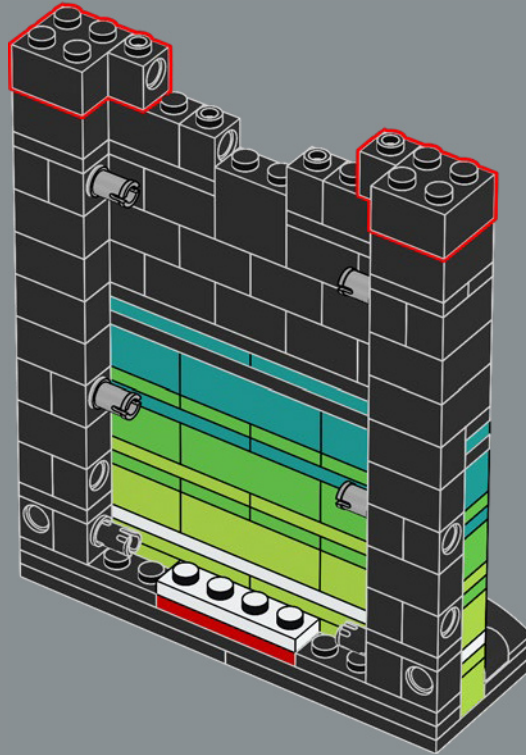



23

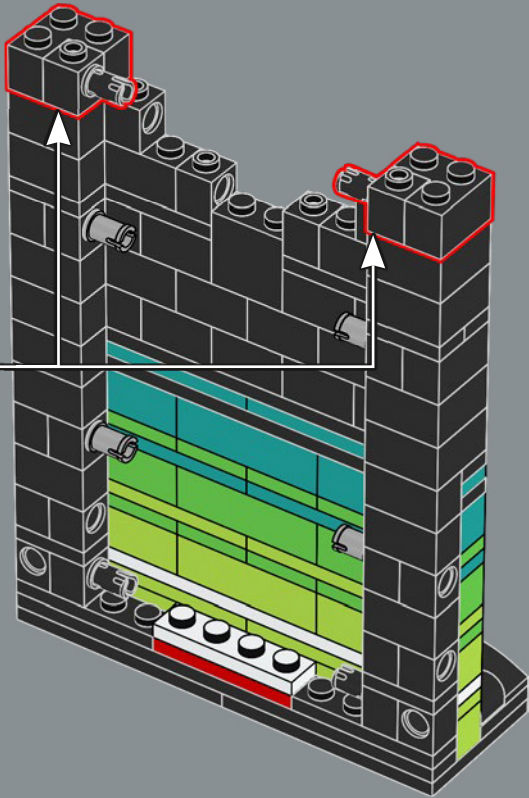
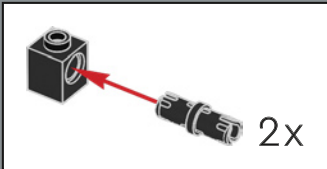

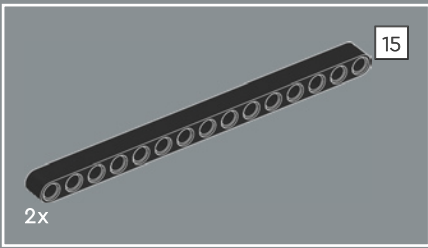

24

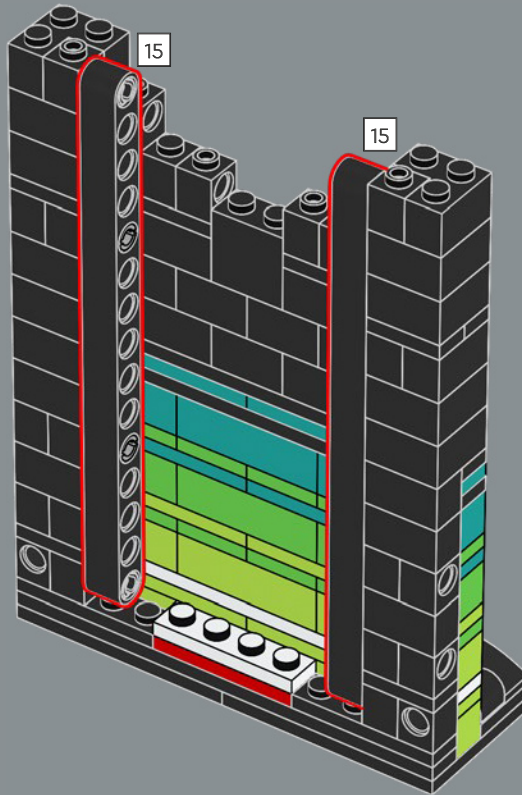

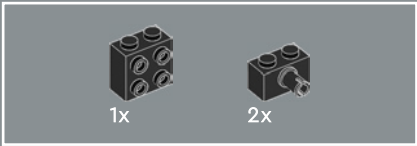

25

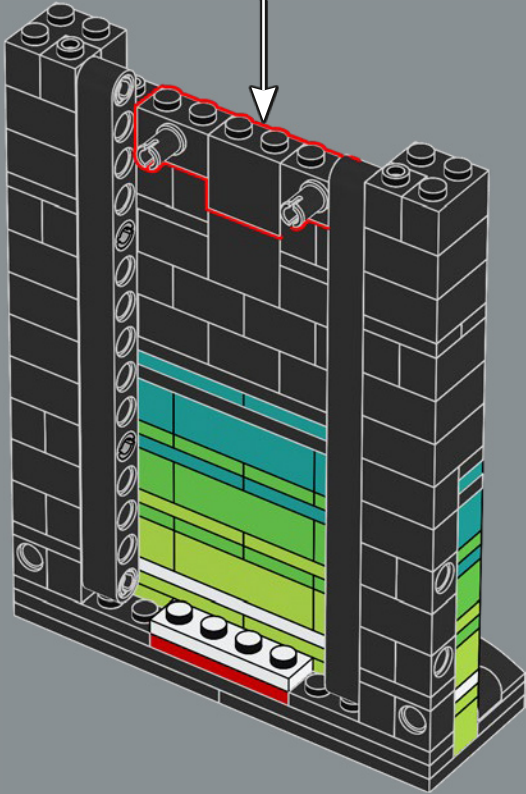
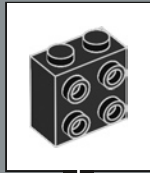



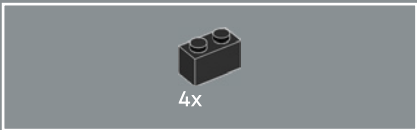

26

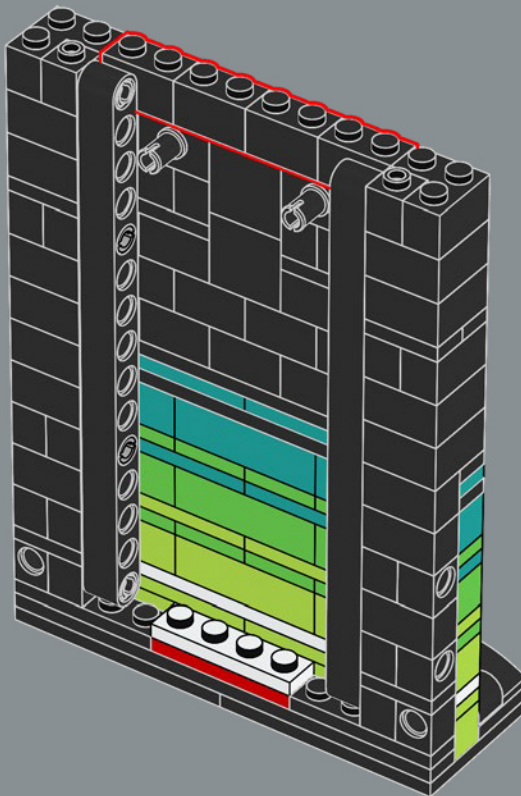

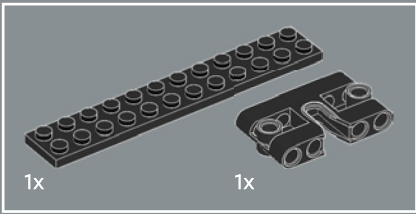

27

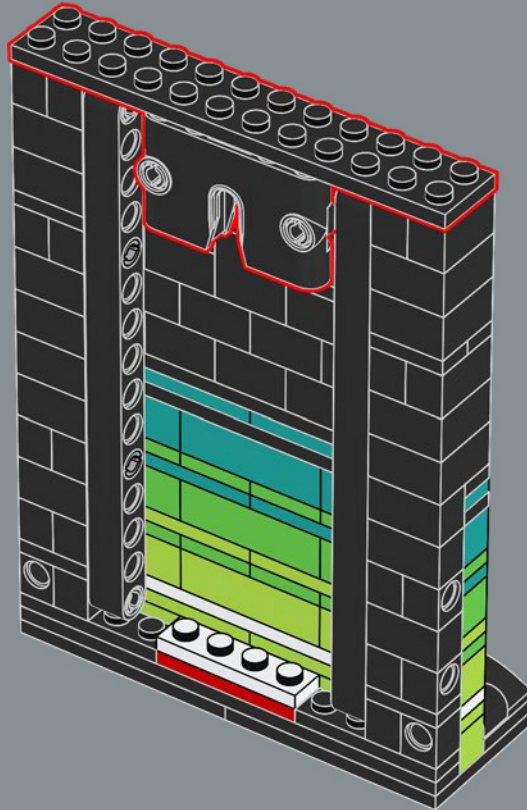

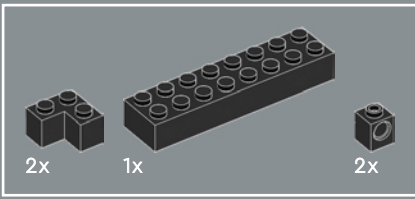

28

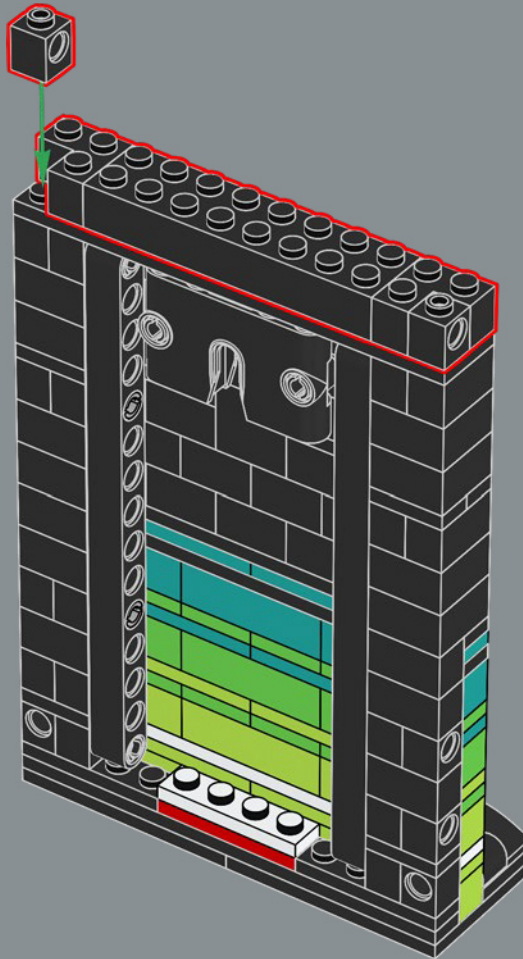

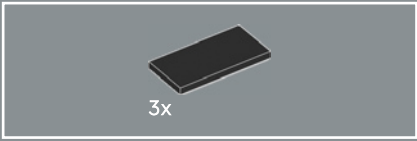

29

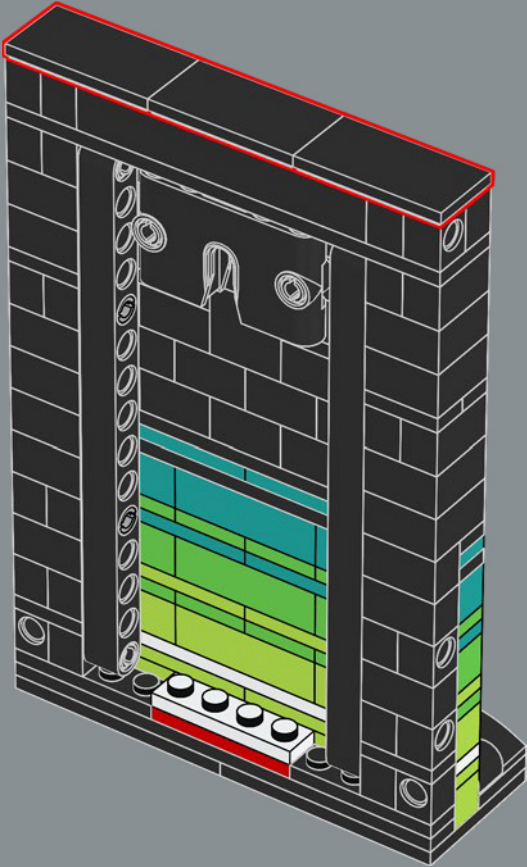

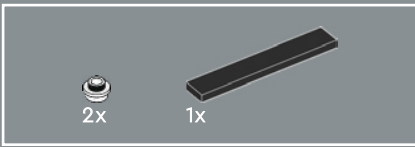

30

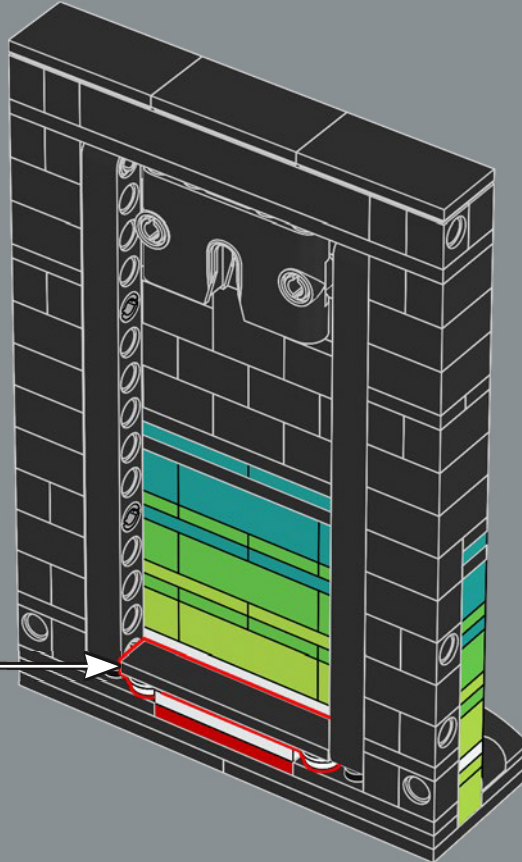
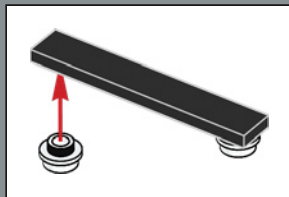

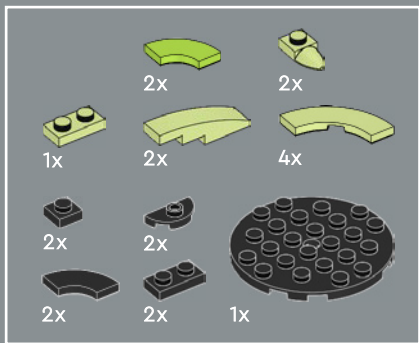

31

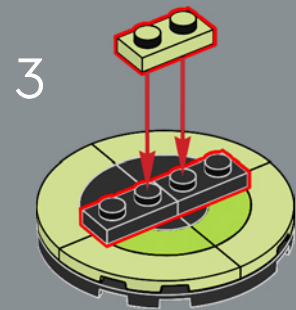
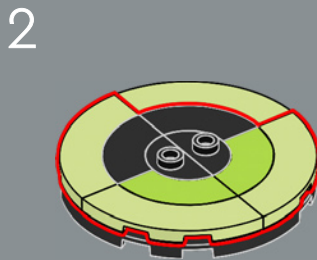
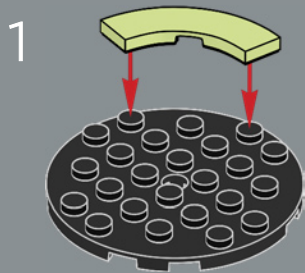

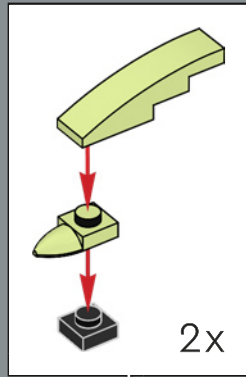

4

