



# MINECRAFT

21248





### **Get excited about our new packaging!**

We're switching from plastic to paper-based packaging. That's why you might find a mix of paper and plastic in our boxes!

### **Nos nouveaux emballages vous emballeront !**

Nous passons des emballages en plastique aux emballages à base de papier. C'est pourquoi vous pourriez trouver un mélange de papier et de plastique dans nos boîtes !

### **¡Te presentamos nuestros nuevos empaques!**

Estamos sustituyendo las bolsas de plástico por bolsas con base de papel. ¡Por eso, puedes encontrar una mezcla de papel y de plástico en nuestras cajas!

**[LEGO.com/sustainable-packaging](https://LEGO.com/sustainable-packaging)**



# BUILDER



Apple and the Apple logo are trademarks of Apple Inc., registered in the U.S. and other countries and regions. App Store is a service mark of Apple Inc. Google Play and the Google Play logo are trademarks of Google LLC. Tencent and the Tencent logo are trademarks of Tencent Inc.

[LEGO.com/devicecheck](https://www.lego.com/devicecheck)

**EN** Ask parents' permission before going online | **DE** Eltern um Erlaubnis bitten, bevor du online gehst | **FR** Demande l'autorisation d'un parent avant d'aller en ligne | **IT** Chiedi il permesso ai tuoi genitori prima di andare online | **ES** Pídeles permiso a tus papás antes de conectarte a Internet | **PT** Peça autorização aos pais antes de acederes online | **ZH** 上网前应先征得父母的同意 | **PL** Poproś rodziców o zgodę, zanim wejdiesz do Internetu | **CS** Než půjdeš na internet, požádej rodiče o svolení | **SK** Skôr než pôjdeš na internet, vypýtaj si povolenie od rodičov | **HU** Kérj szülői engedélyt, mielőtt online csatlakoznál! | **RO** Cere permisiunea părinților înainte de a te conecta online | **BG** Поискайте разрешение от родител, преди да влезете онлайн | **LV** Pirms došanās tiešsaistē palūdz atļauju vecākiem | **ET** Enne Interneti kasutamist küsi vanematelt luba | **LT** Prieš prisijungdami prie interneto, atsklauskite tėvų

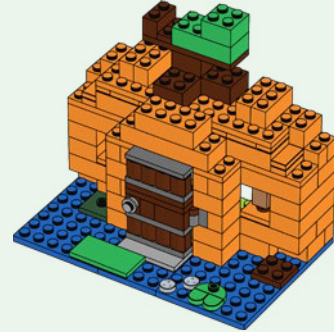
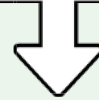
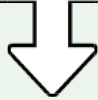
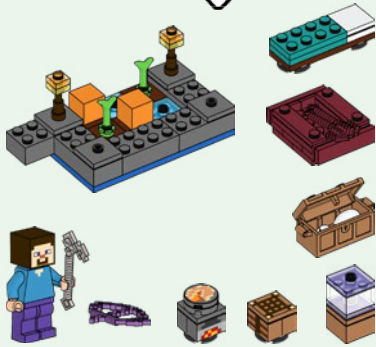
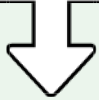

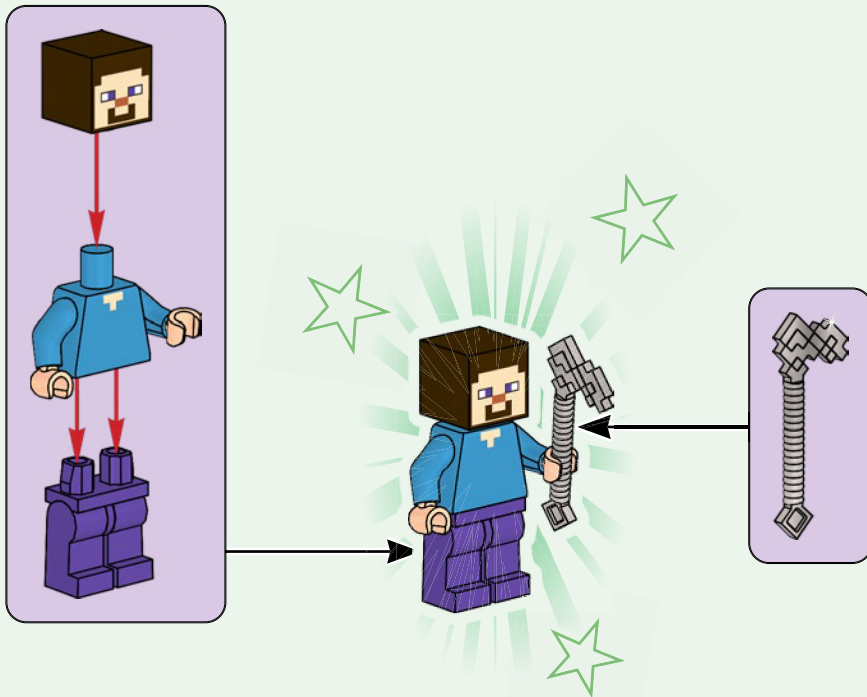
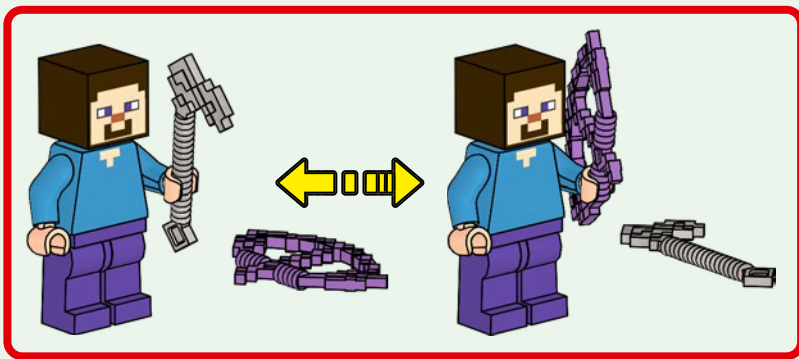

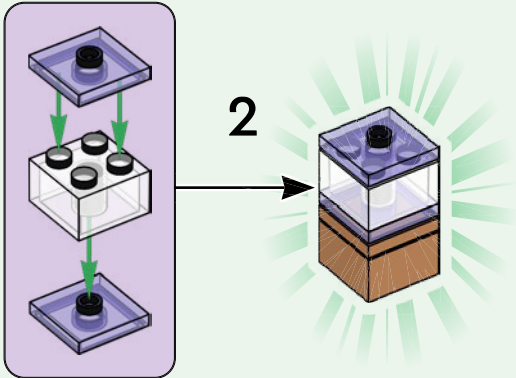
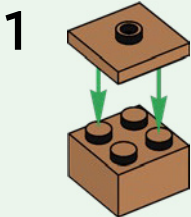
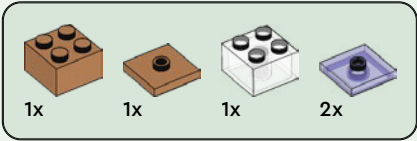
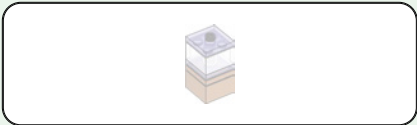

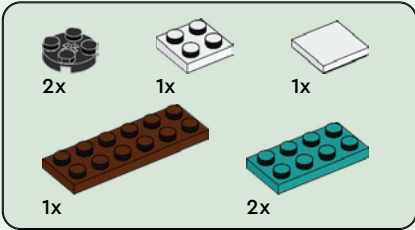
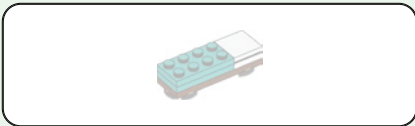

1

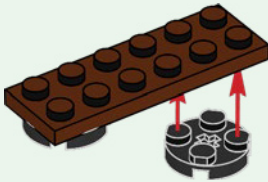

2

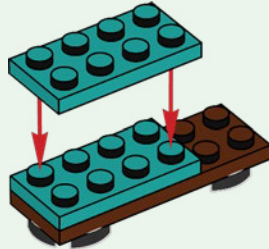

3

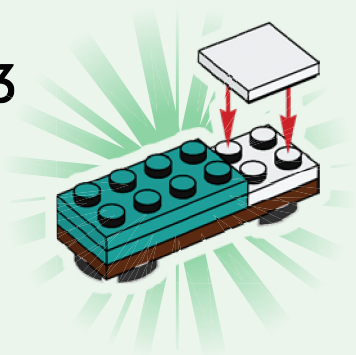

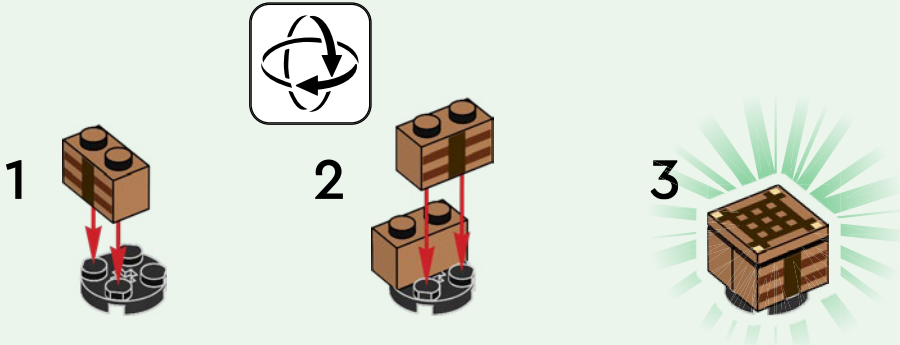
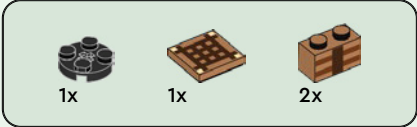



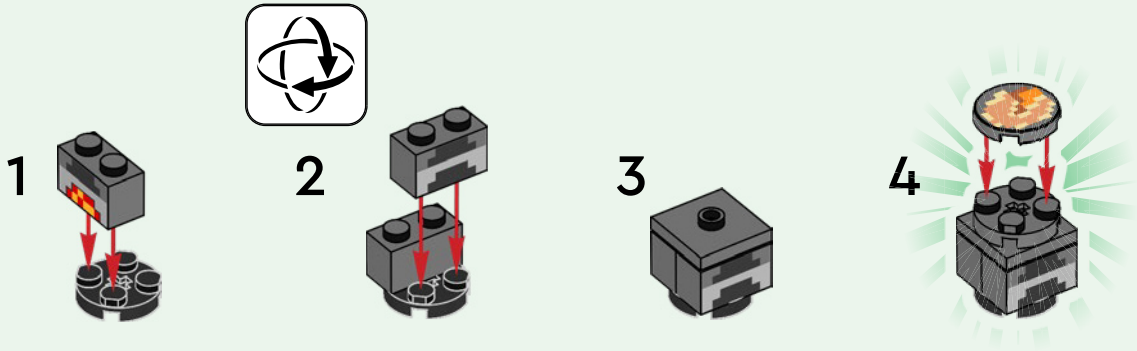
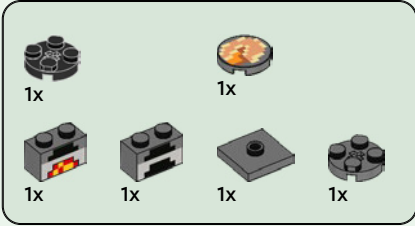

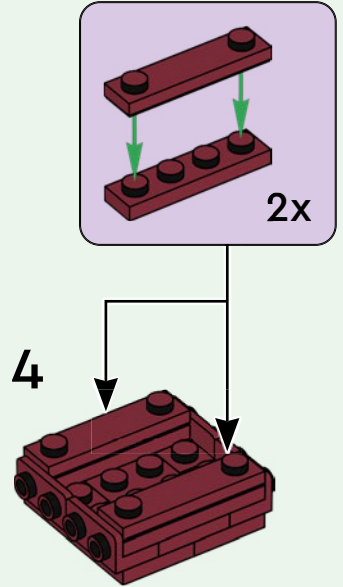
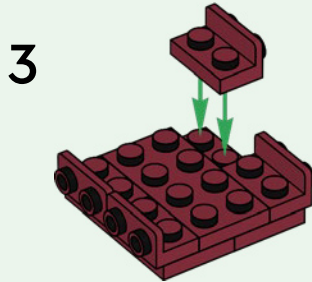
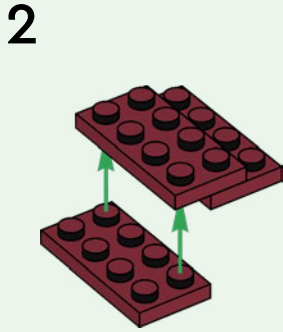
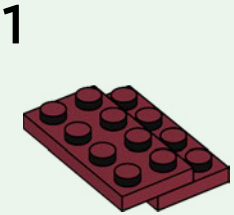
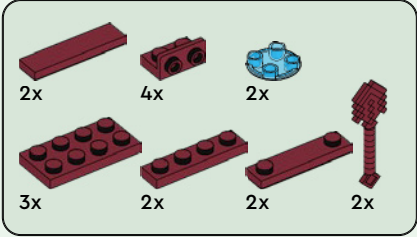
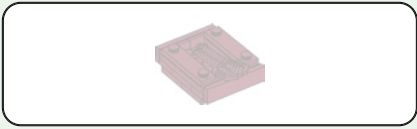

5

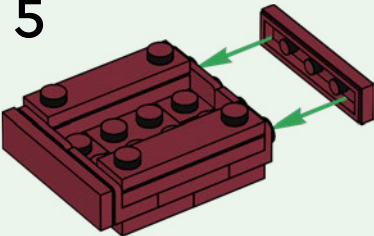

6

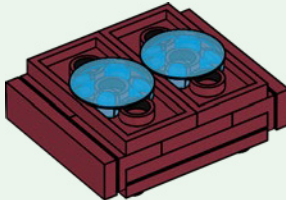

7

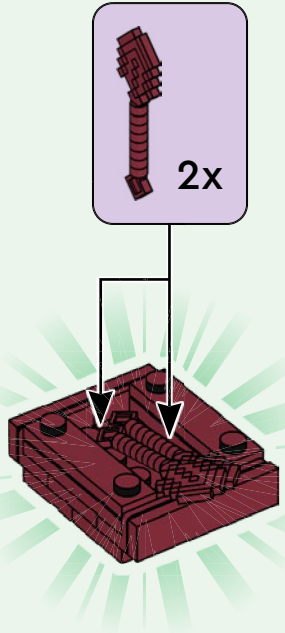

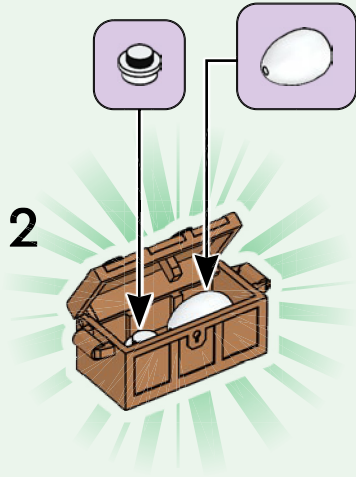
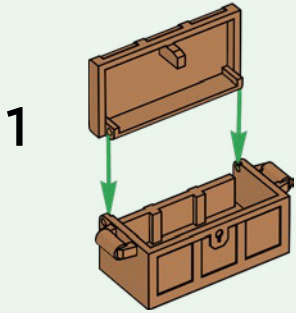
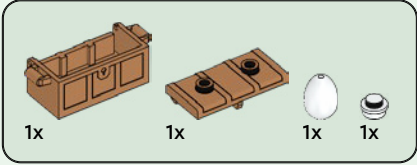
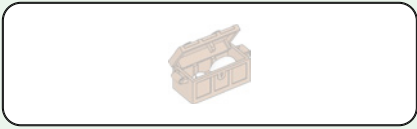

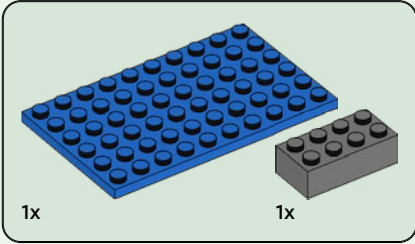
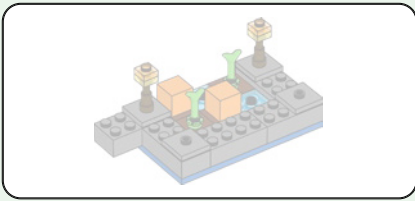

1

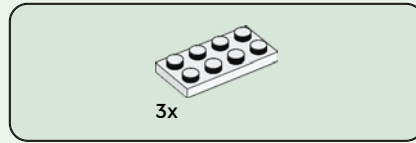
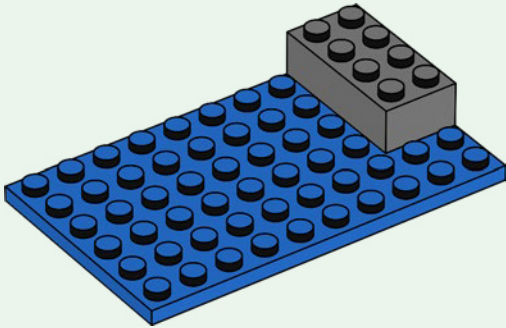

2

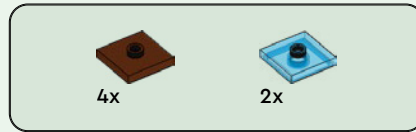
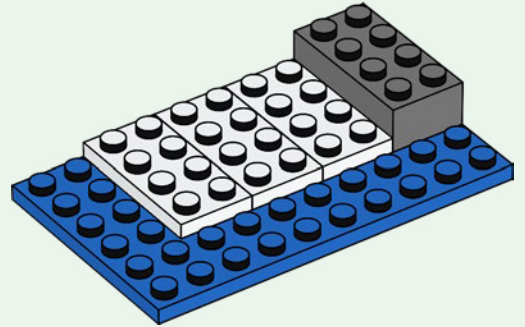

3

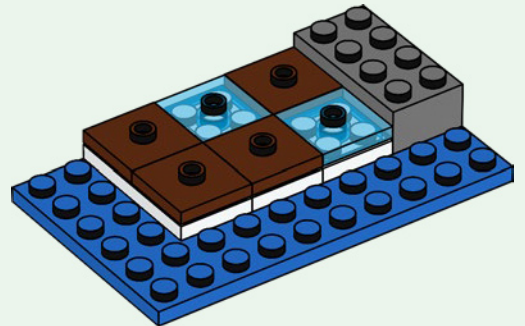

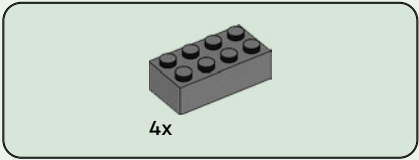

4

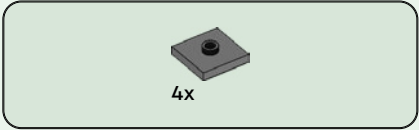
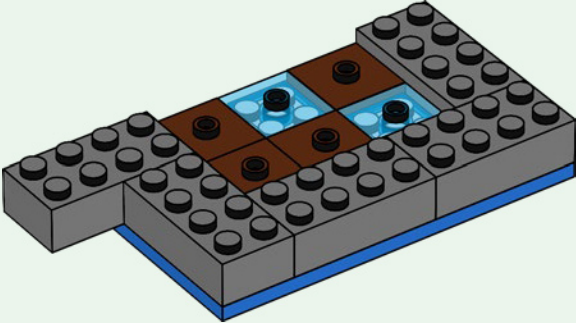

5

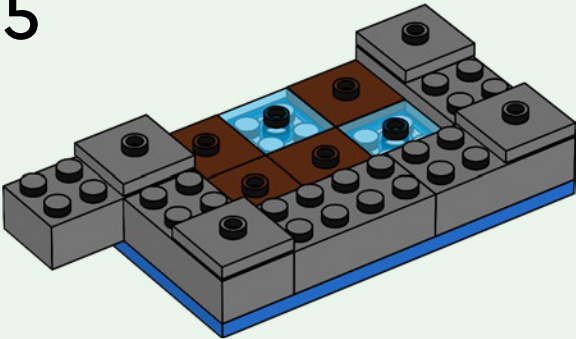

6

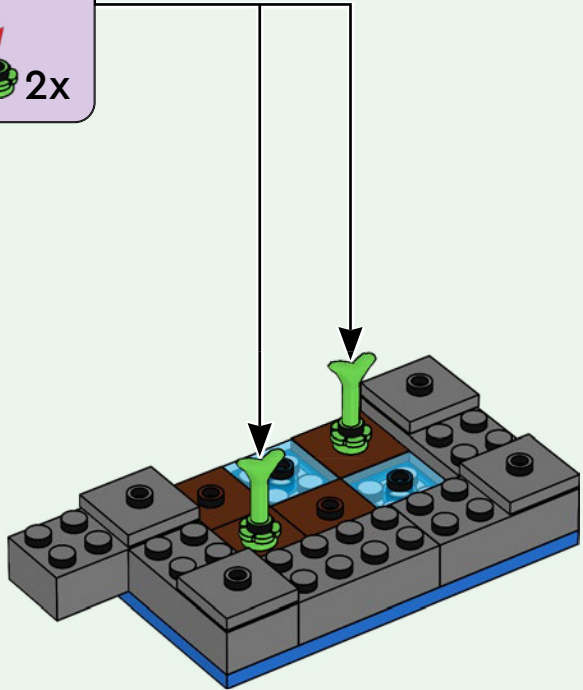
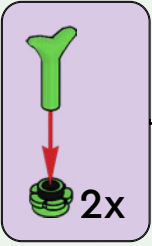



2x

7

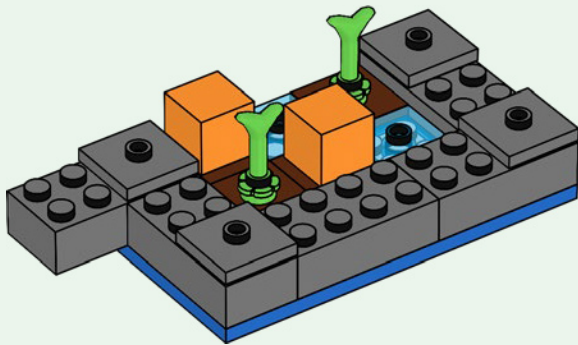

2x



2x



2x

8



2x

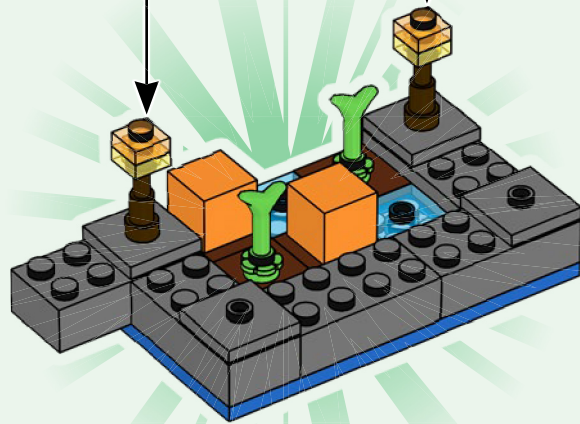

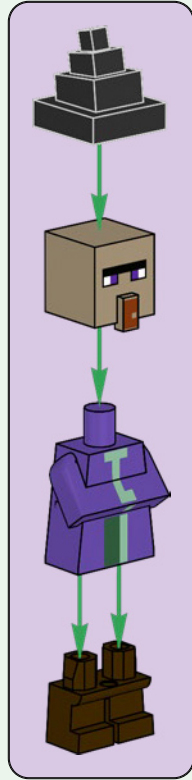



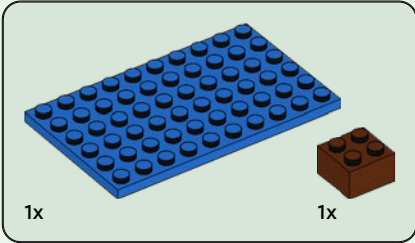
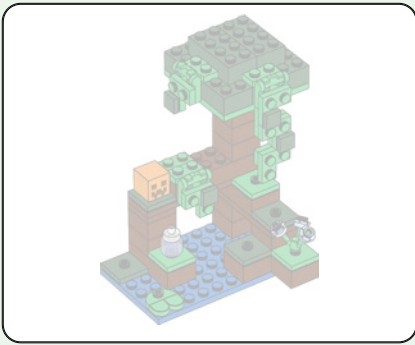

9

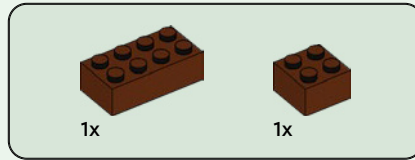
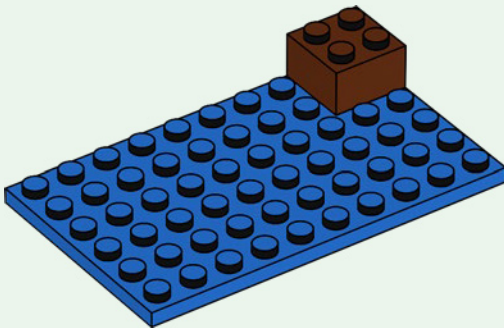

10

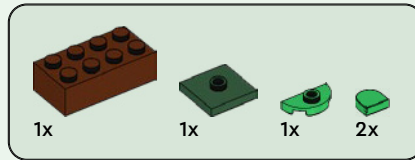
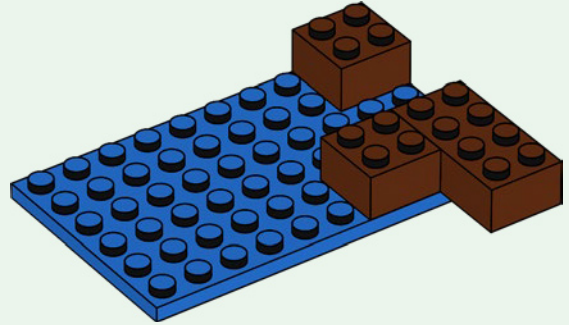

11

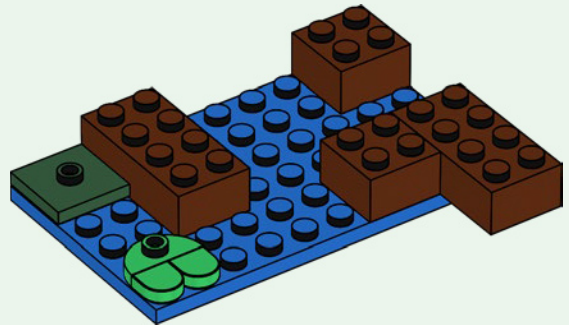



2x

12

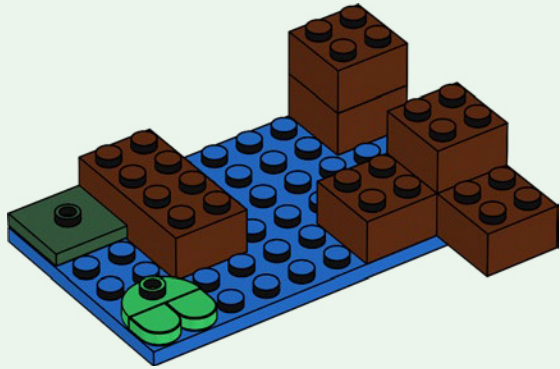

1x



1x

13

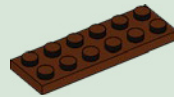
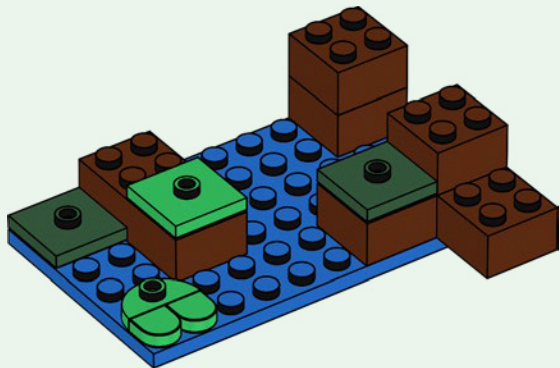

1x

14

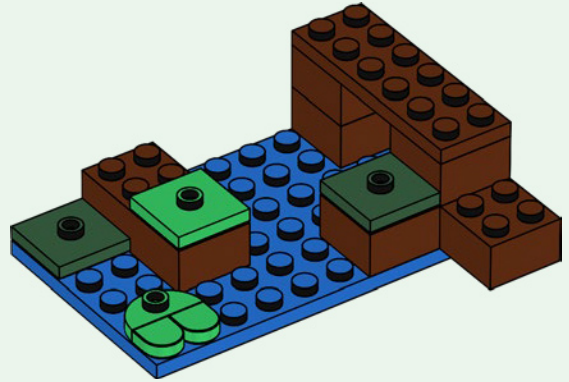

1x



1x



1x

15

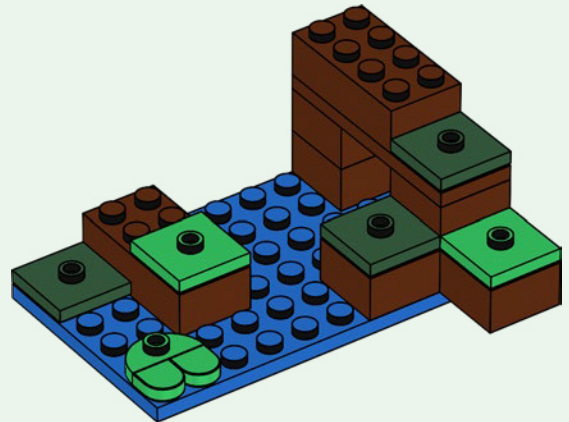



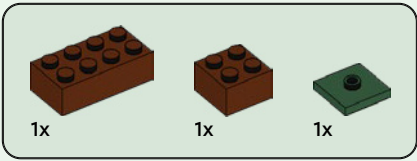

18

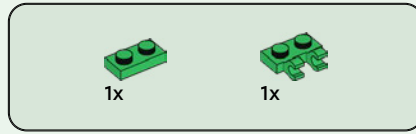
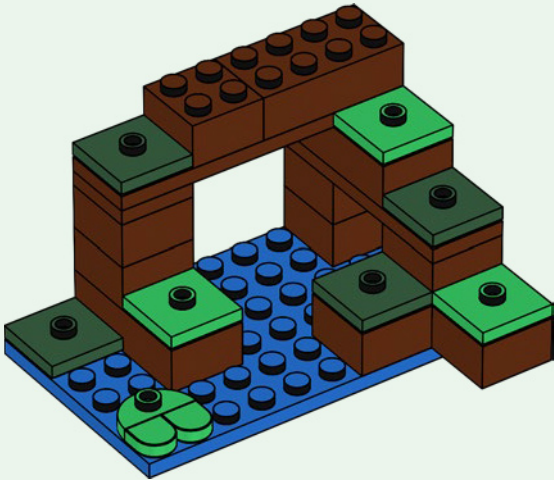

19

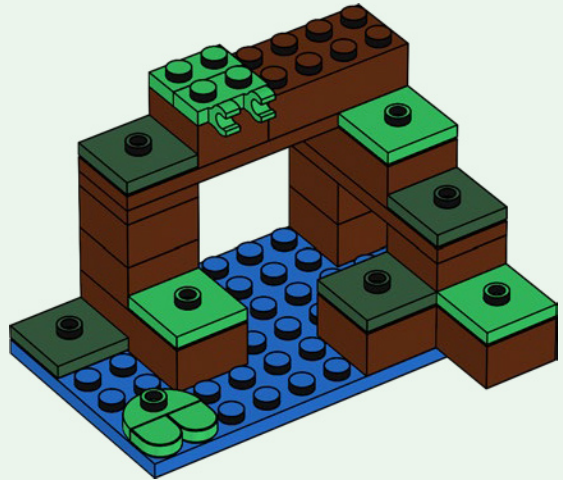

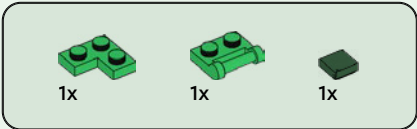

20

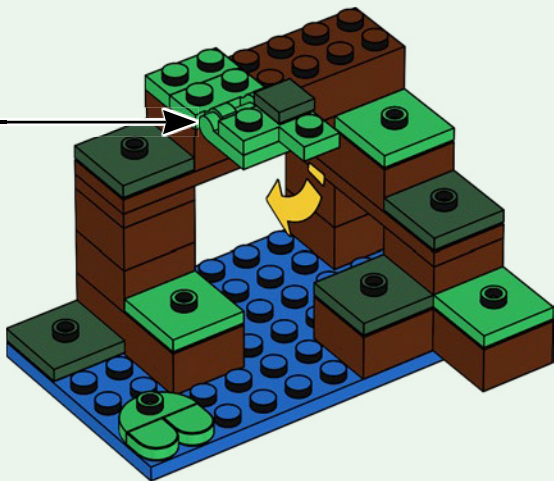
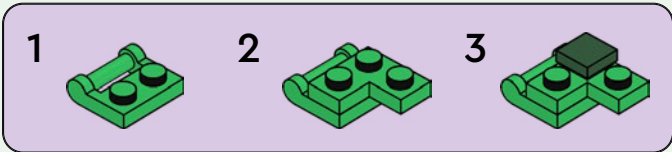

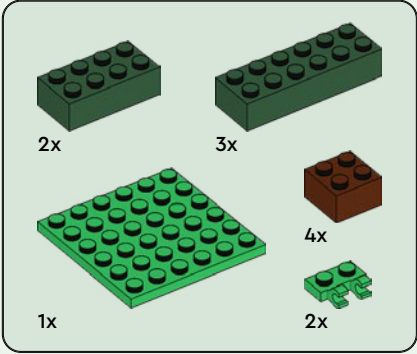
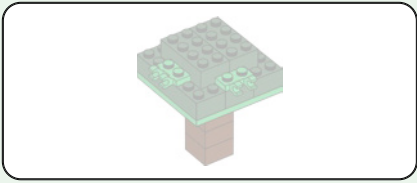

21

1

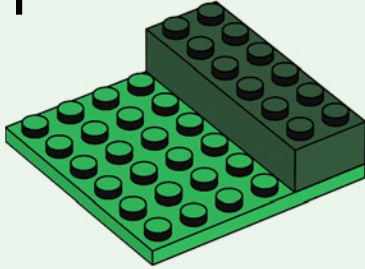

2

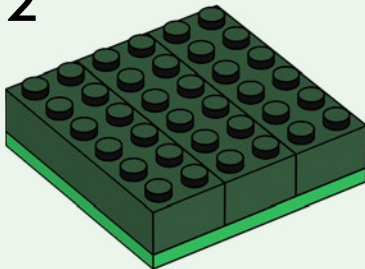

3

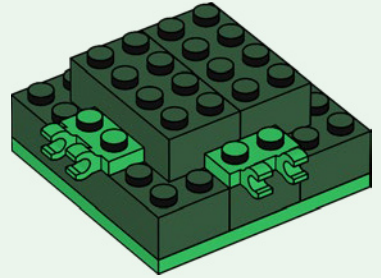

4

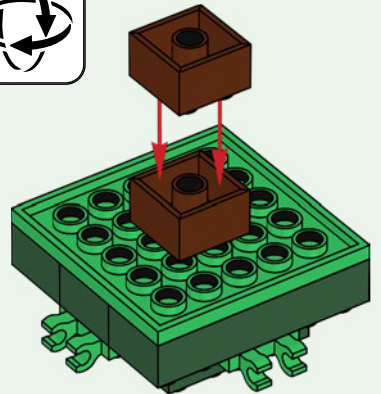

5

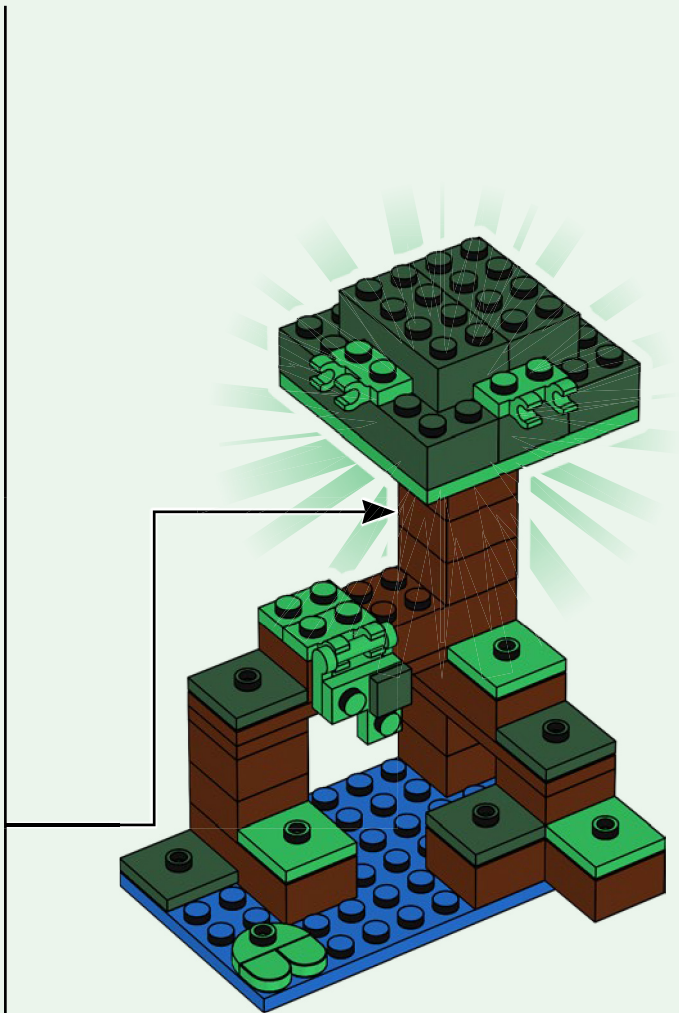
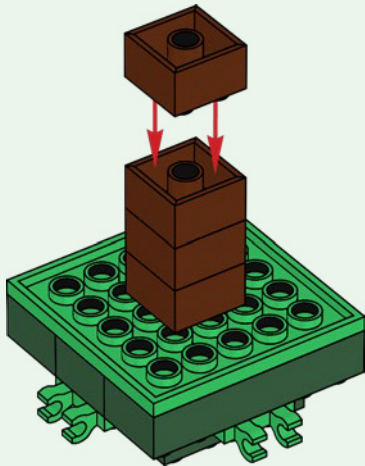

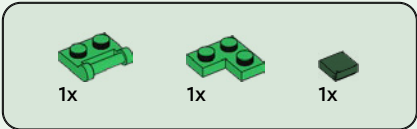

22

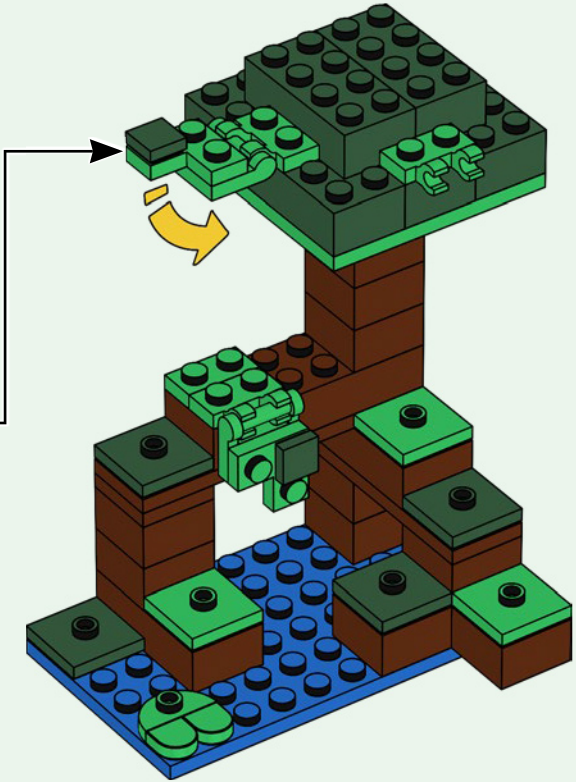
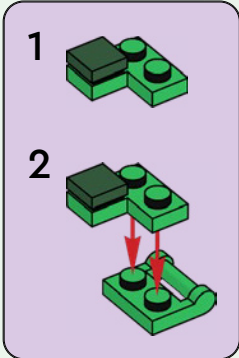



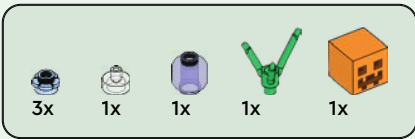

23

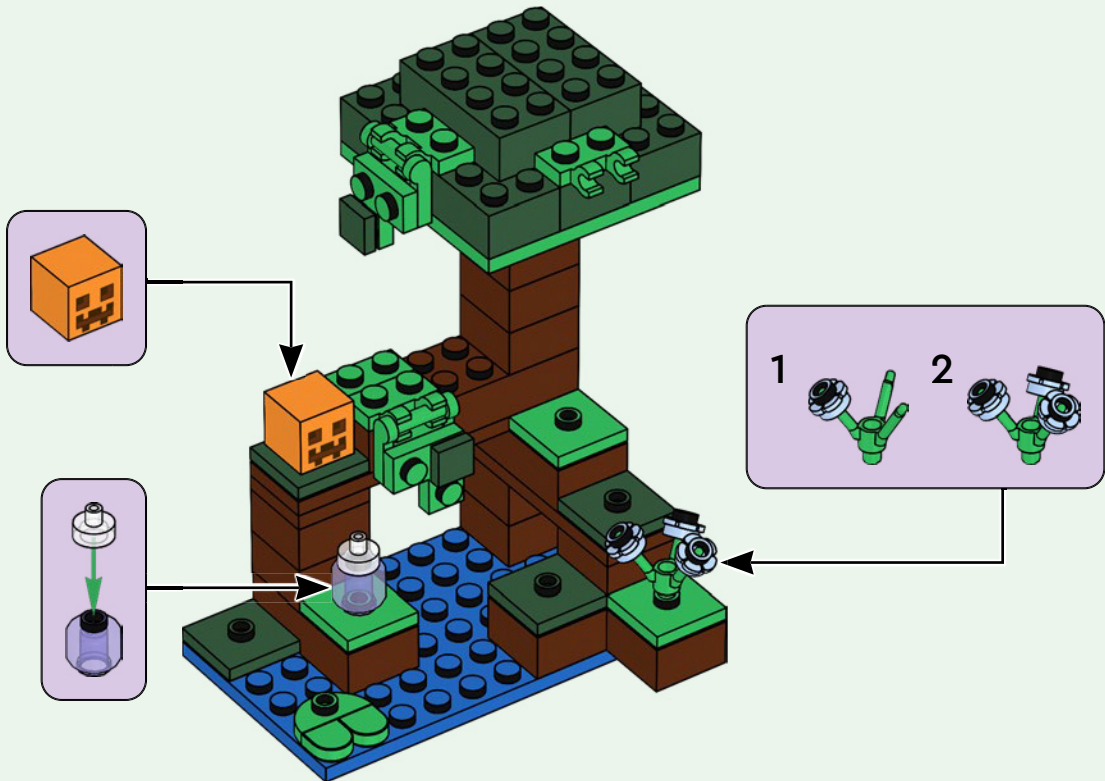

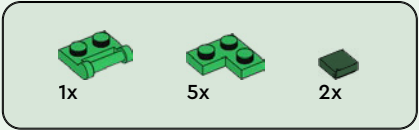
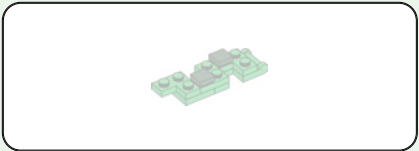

# 24

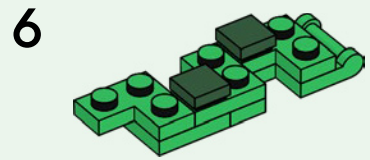
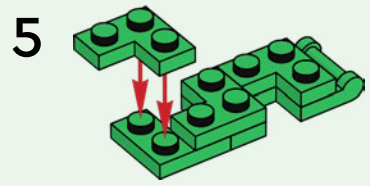
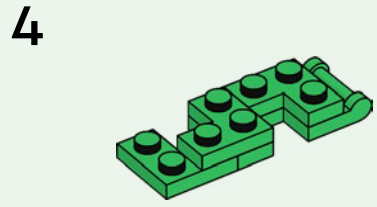
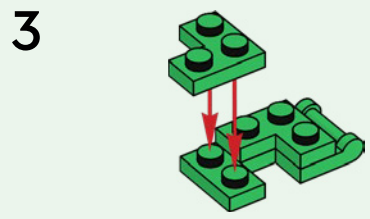
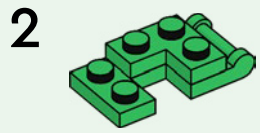
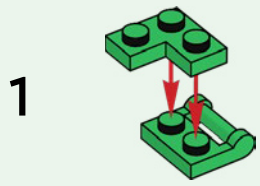

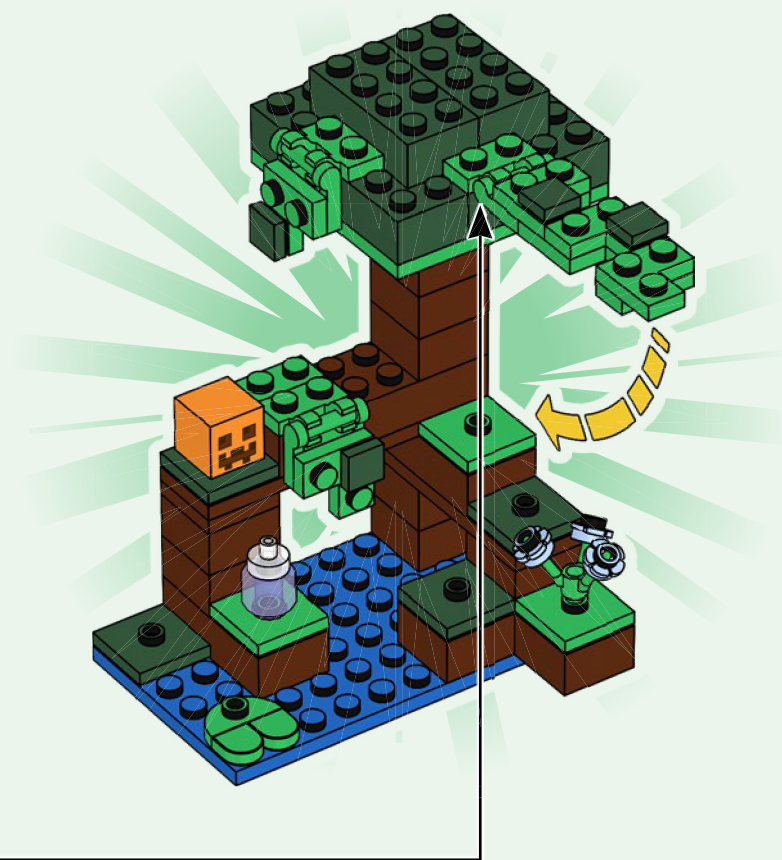

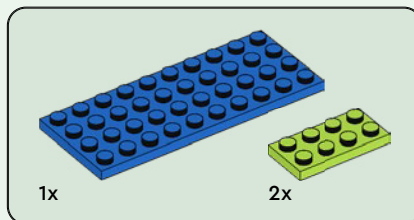
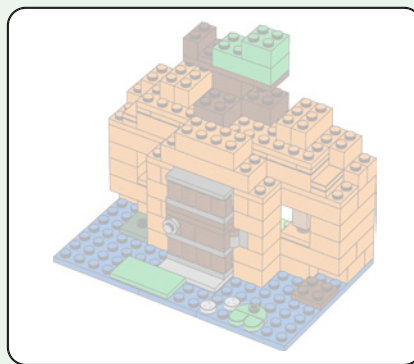

25

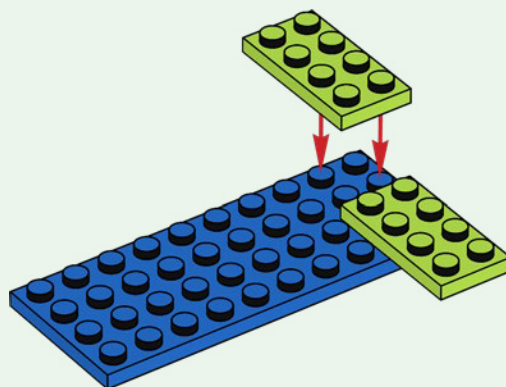

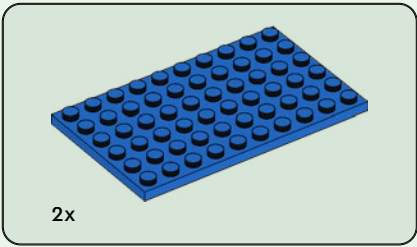

26

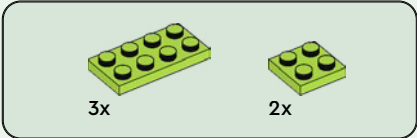
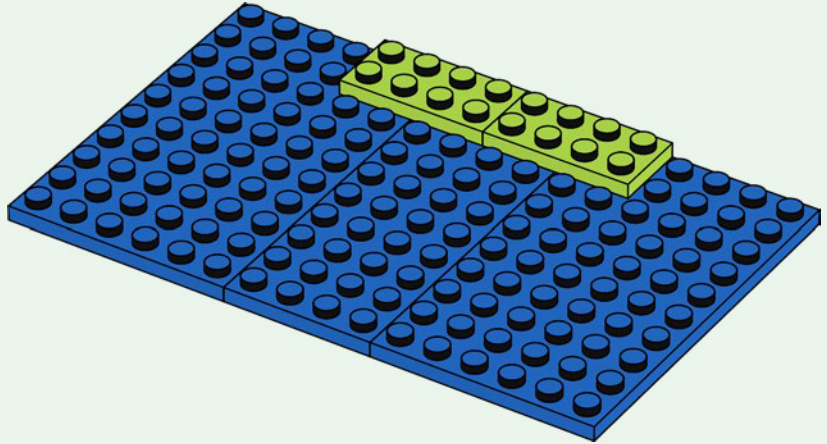

27

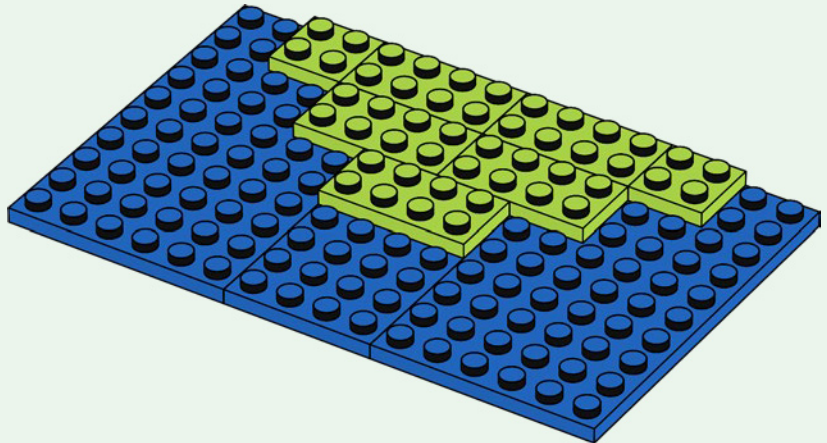



4x



2x

28

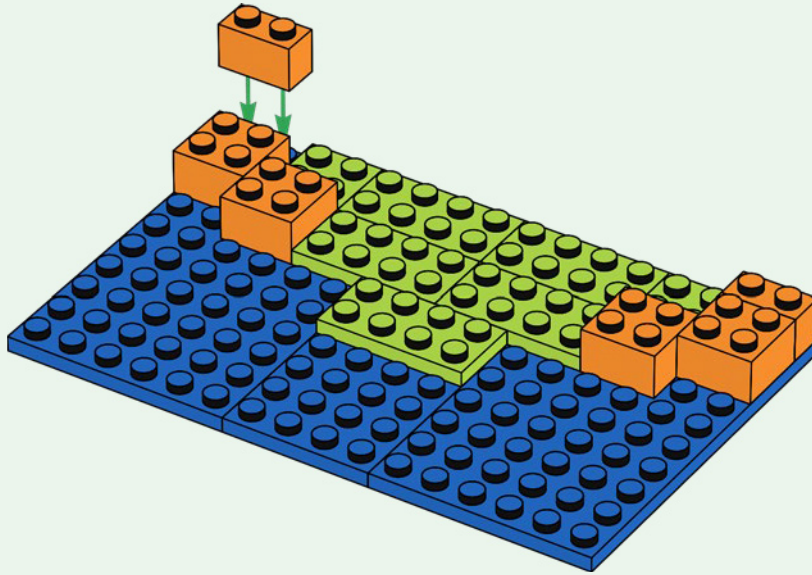

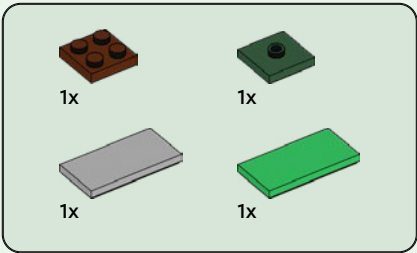

29

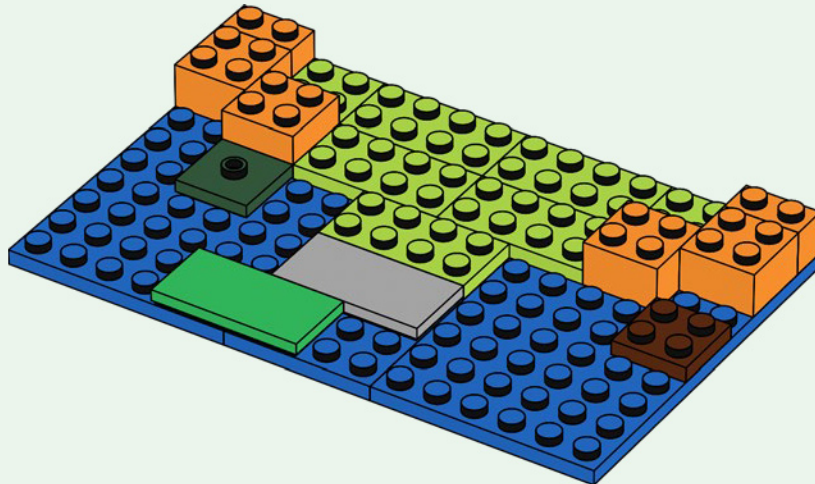

2x  
1x  
2x

30

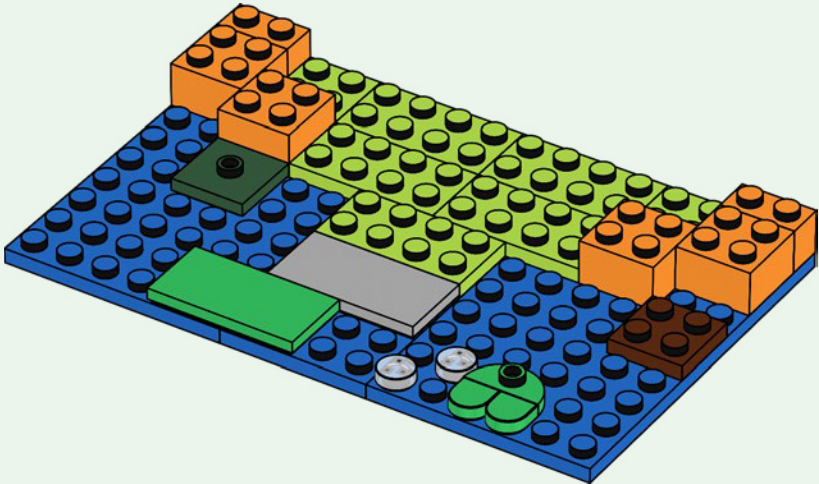









4x

33

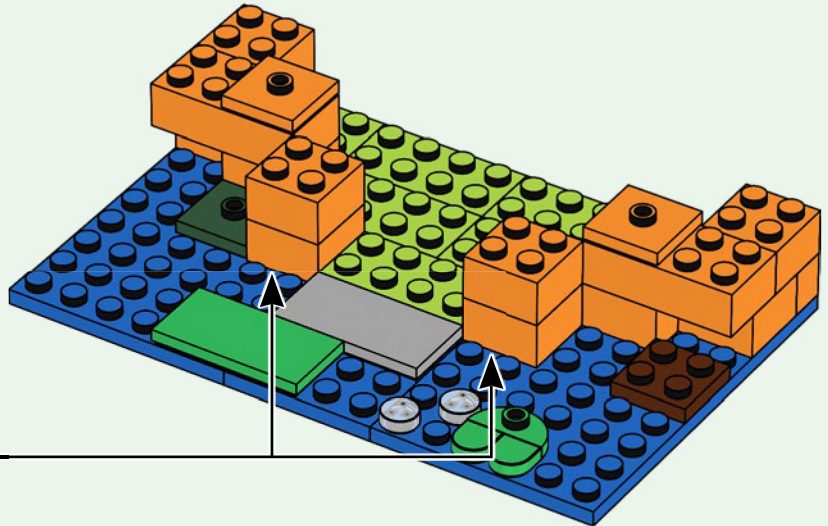
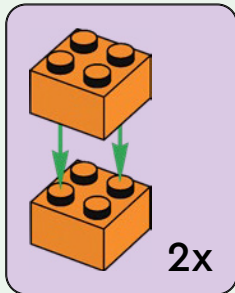

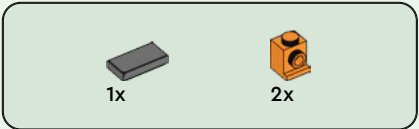

# 34

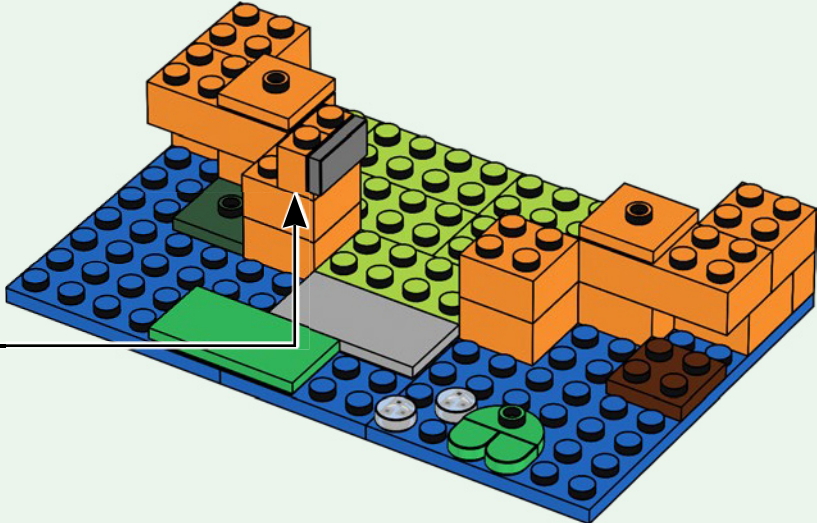
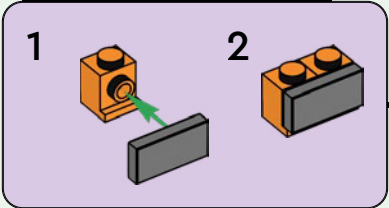



2x



4x

# 35

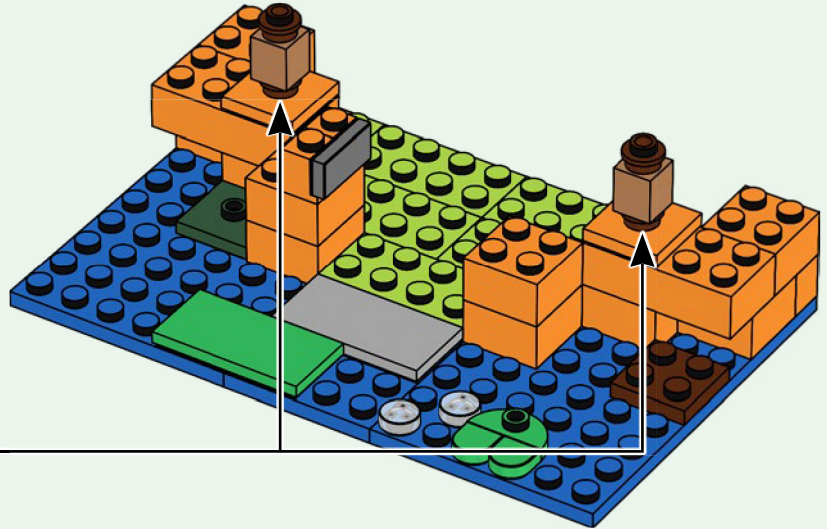
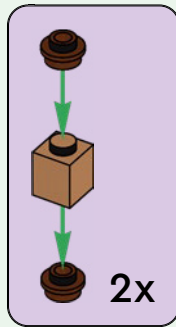



2x

36

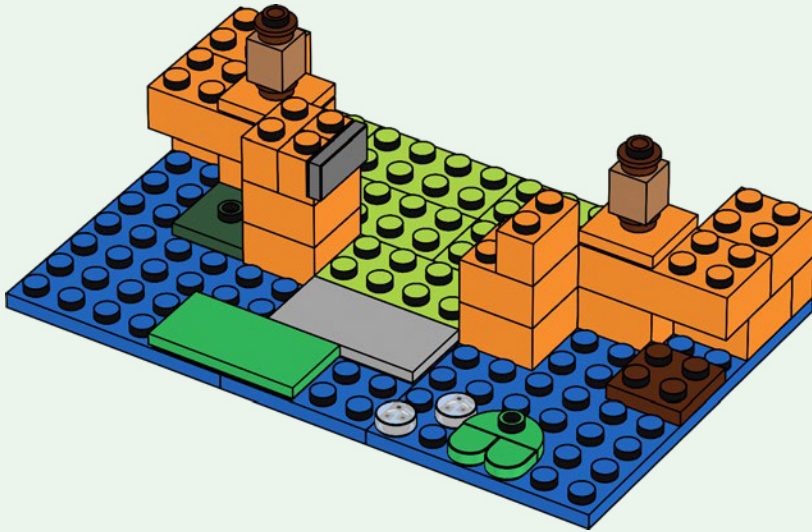

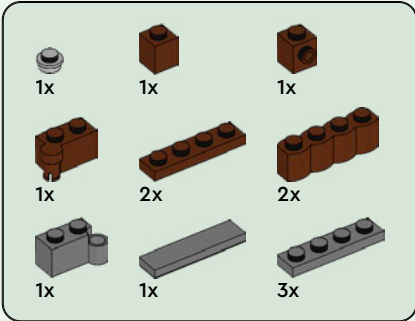
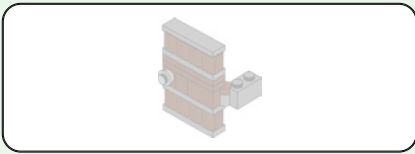

37

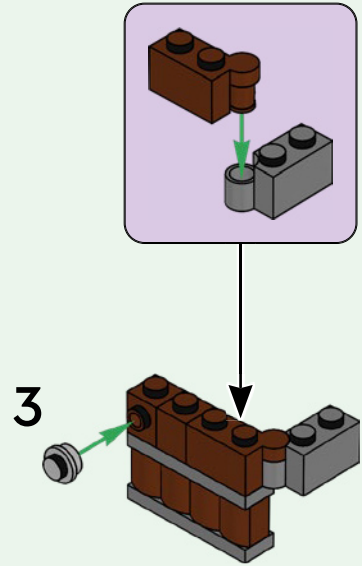
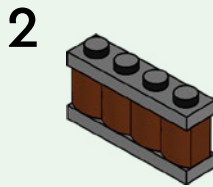
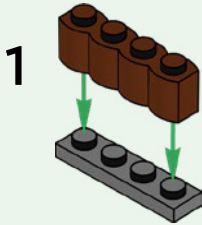

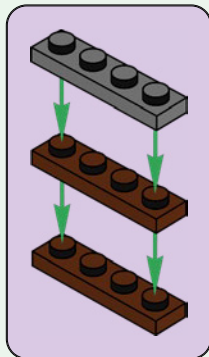

4

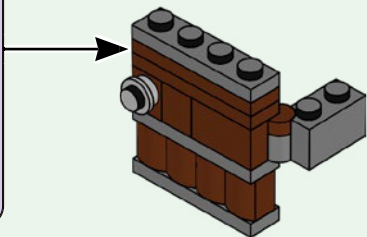

5

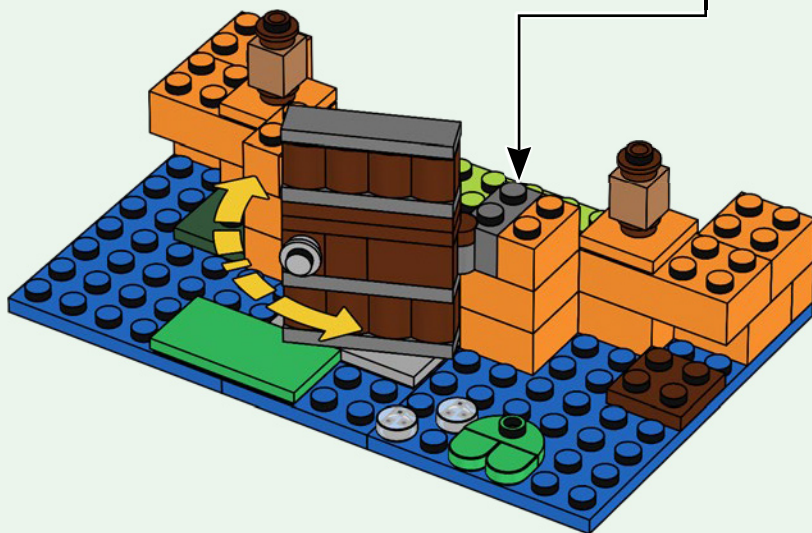
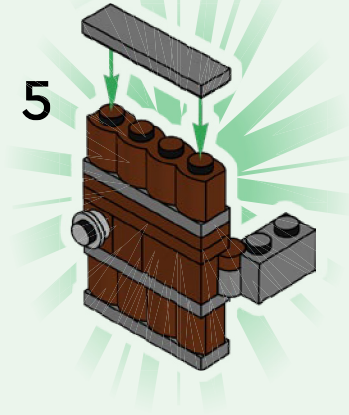





2x

38

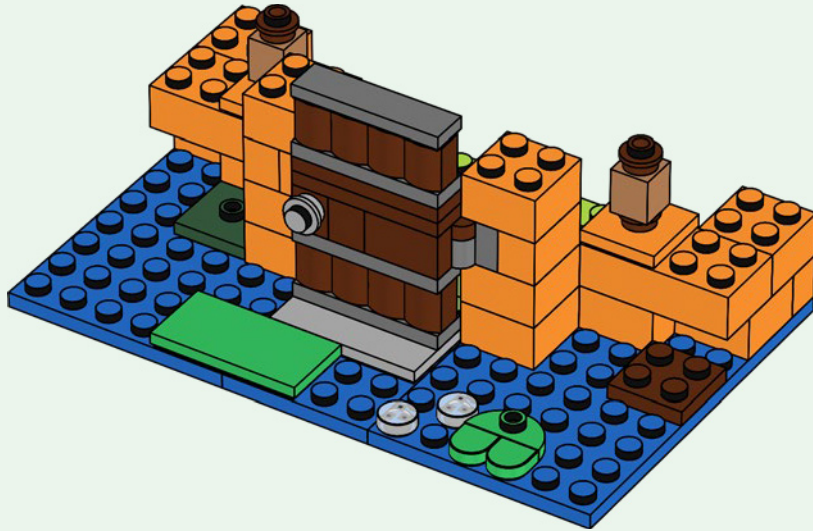

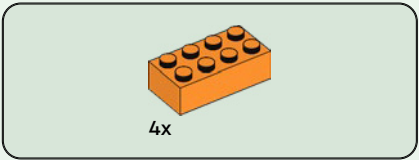

39

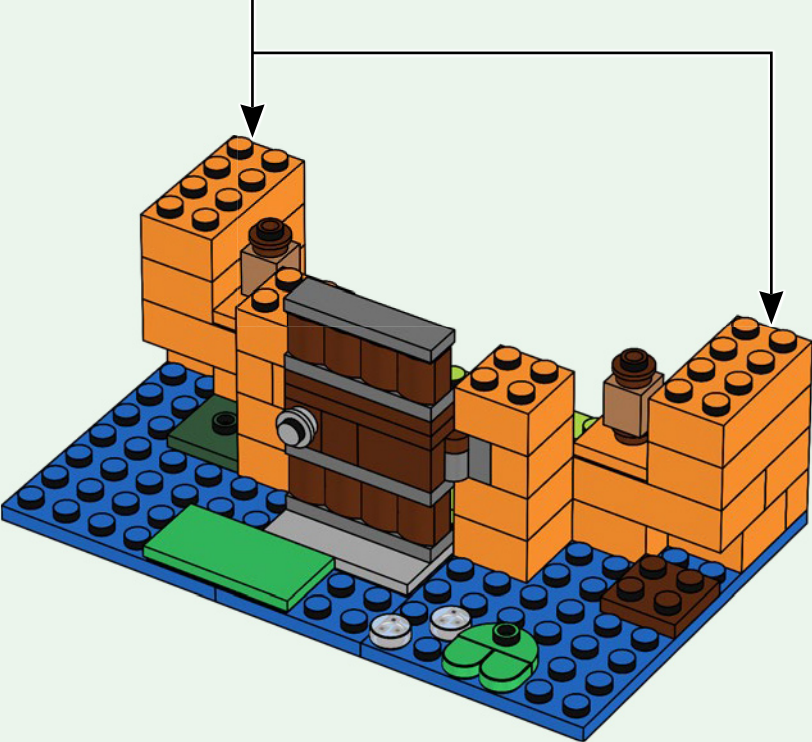
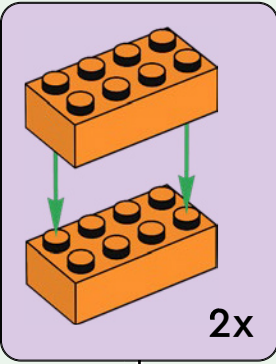

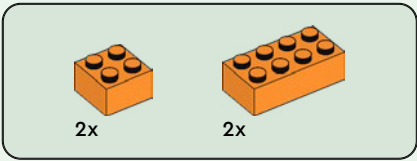

40

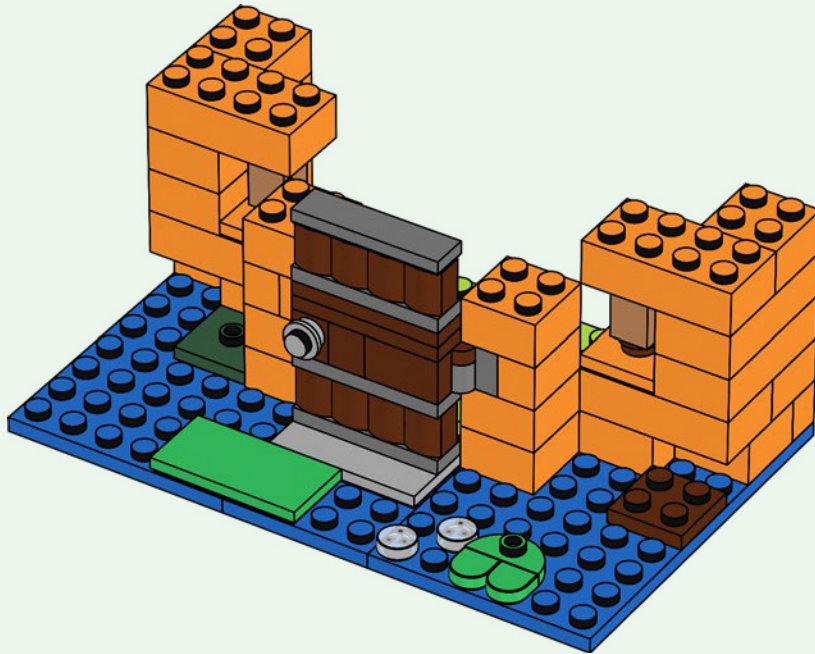



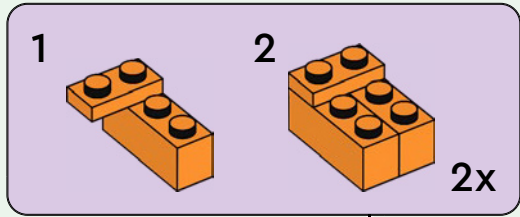
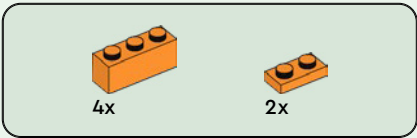

42

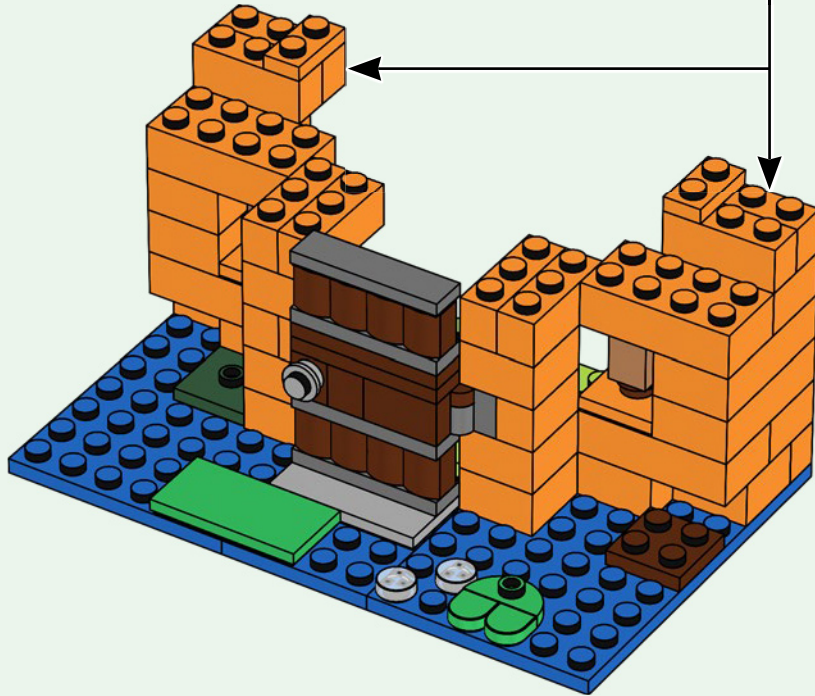



4x

43

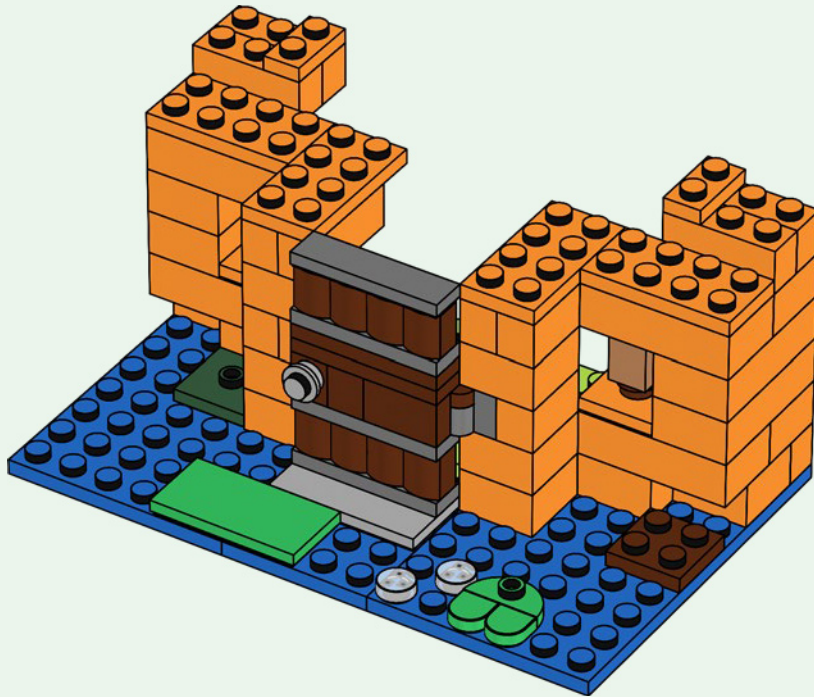

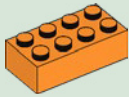

2x

44

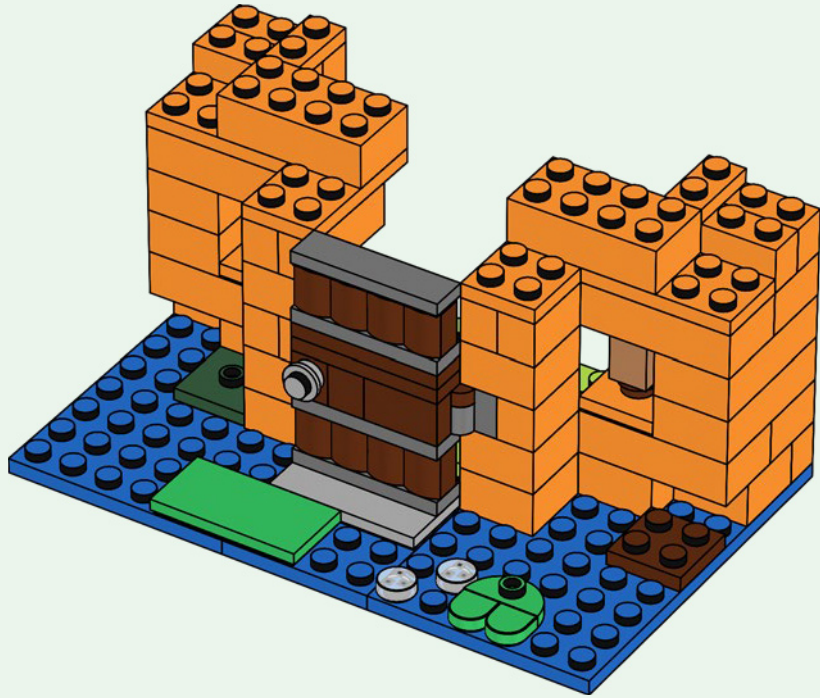

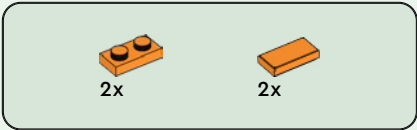

45

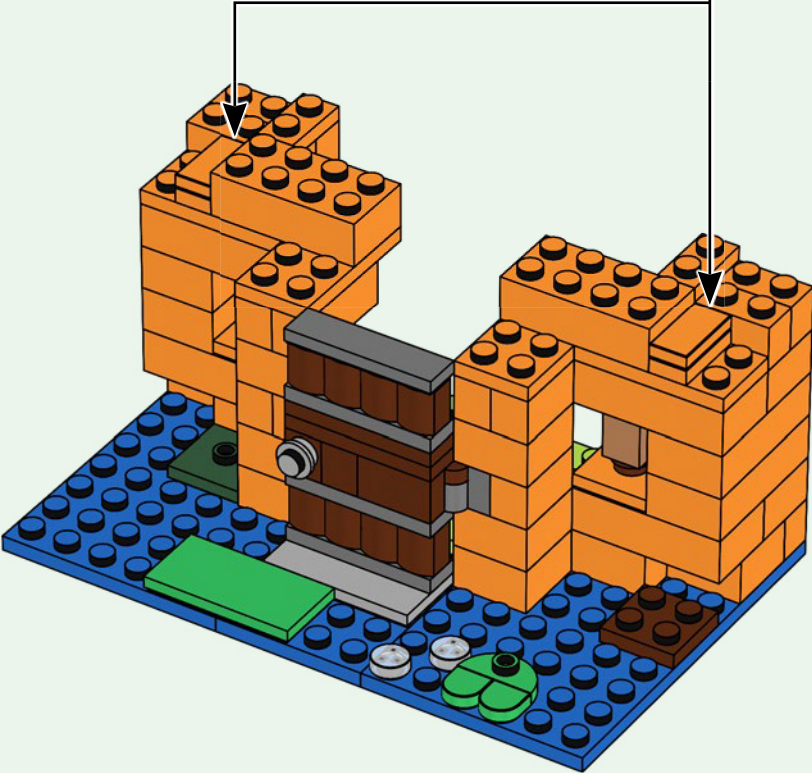
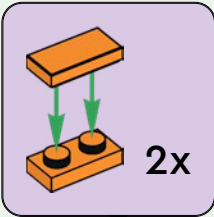







2x

47

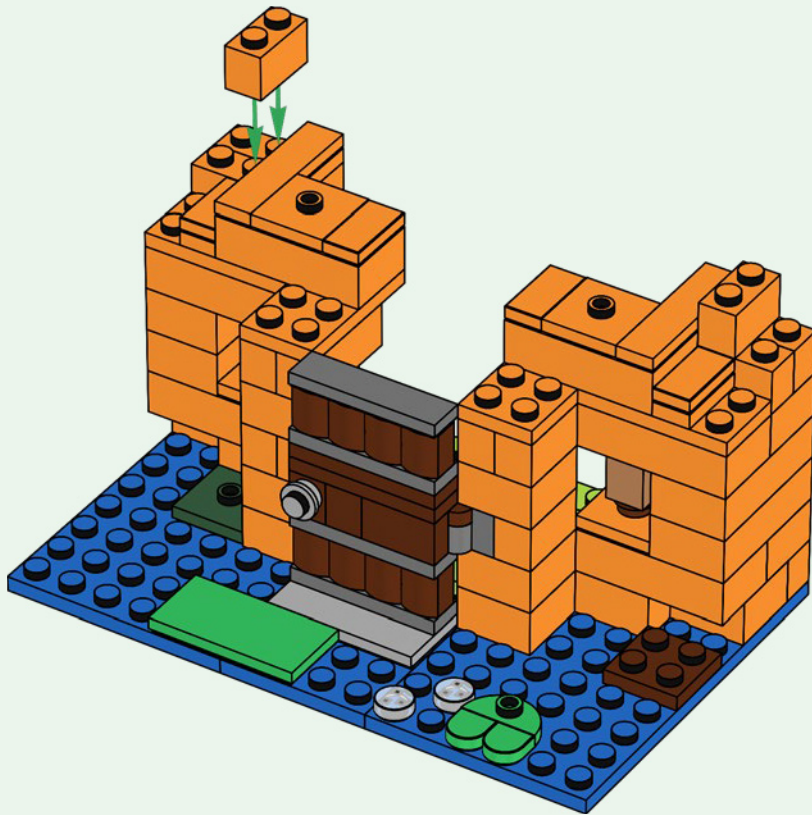

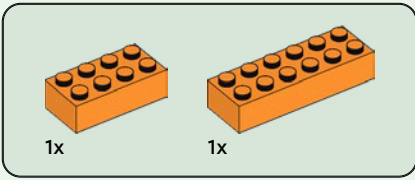

48

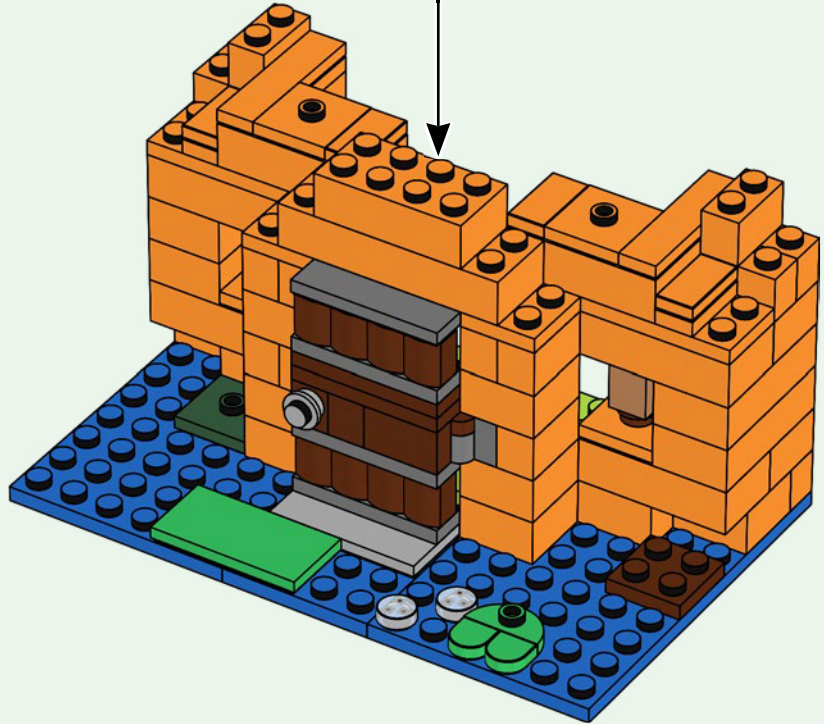
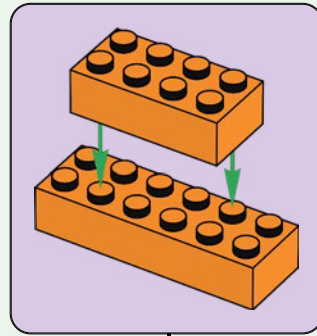

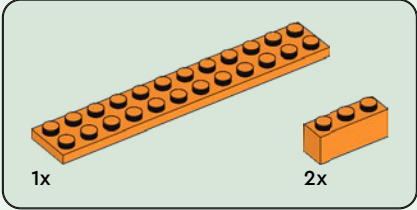
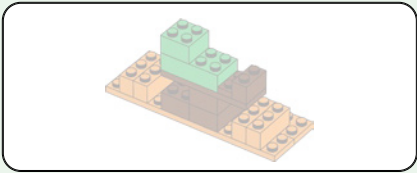

49

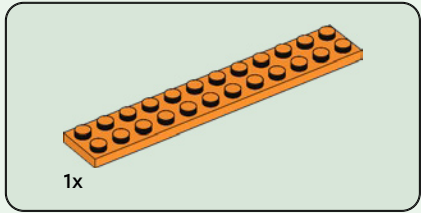
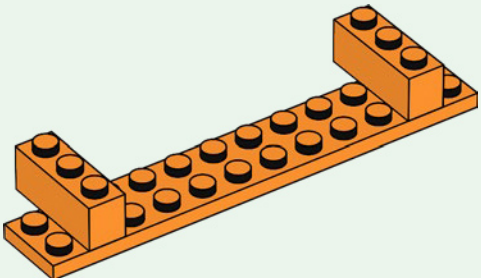

50

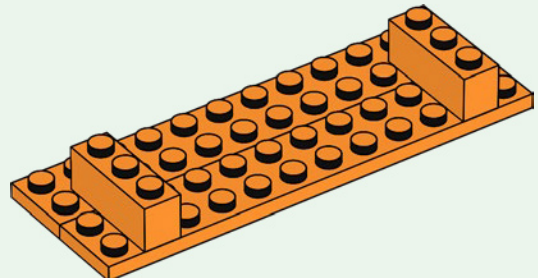

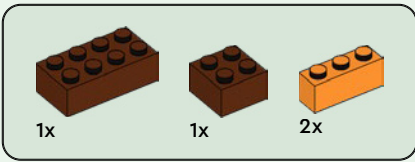

51

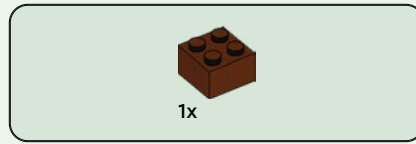
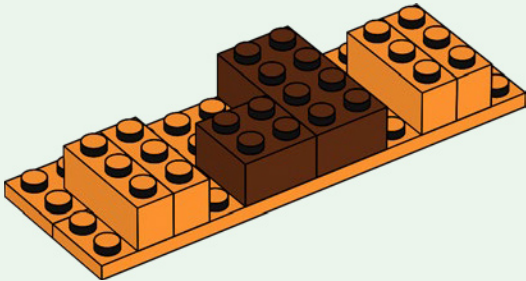

52

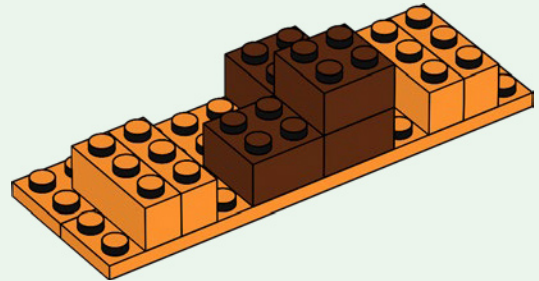

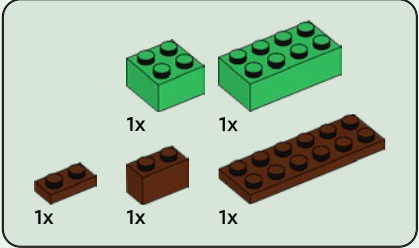
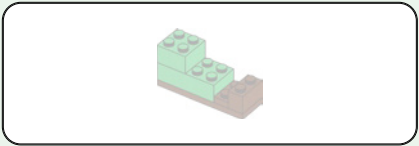

53

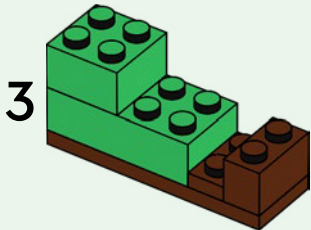
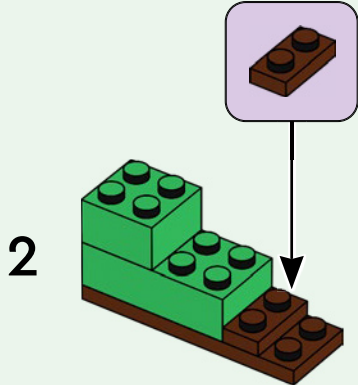
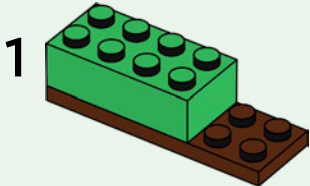

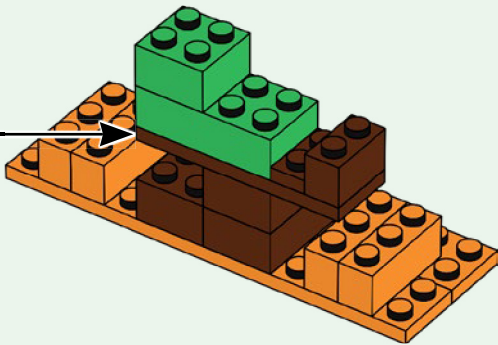

54

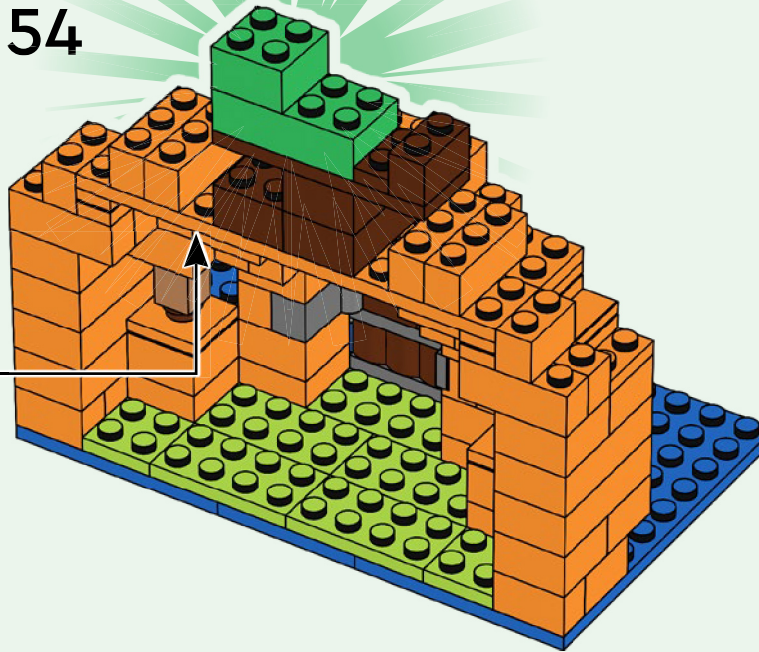

55

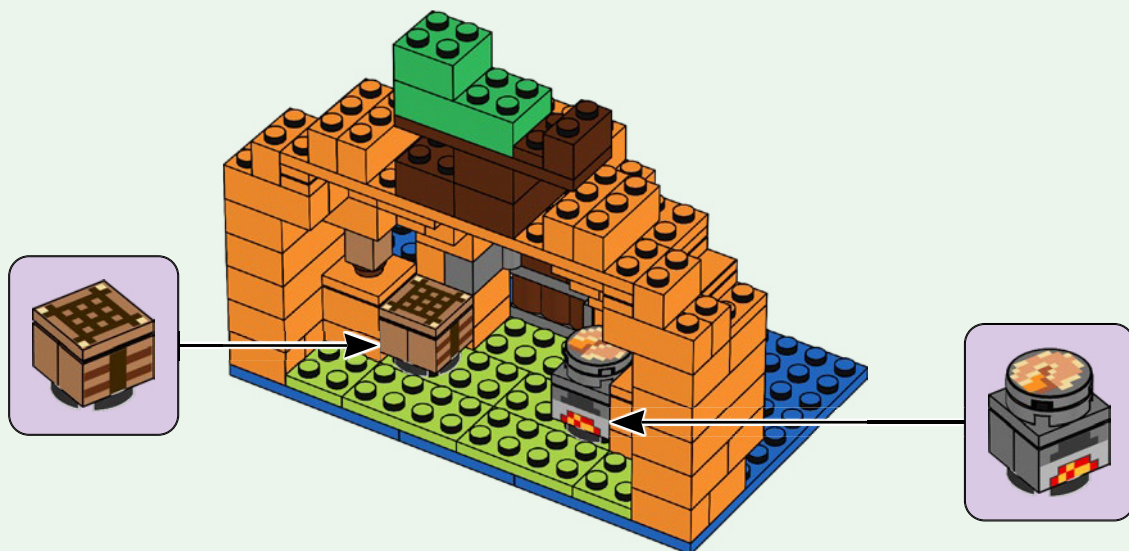



56

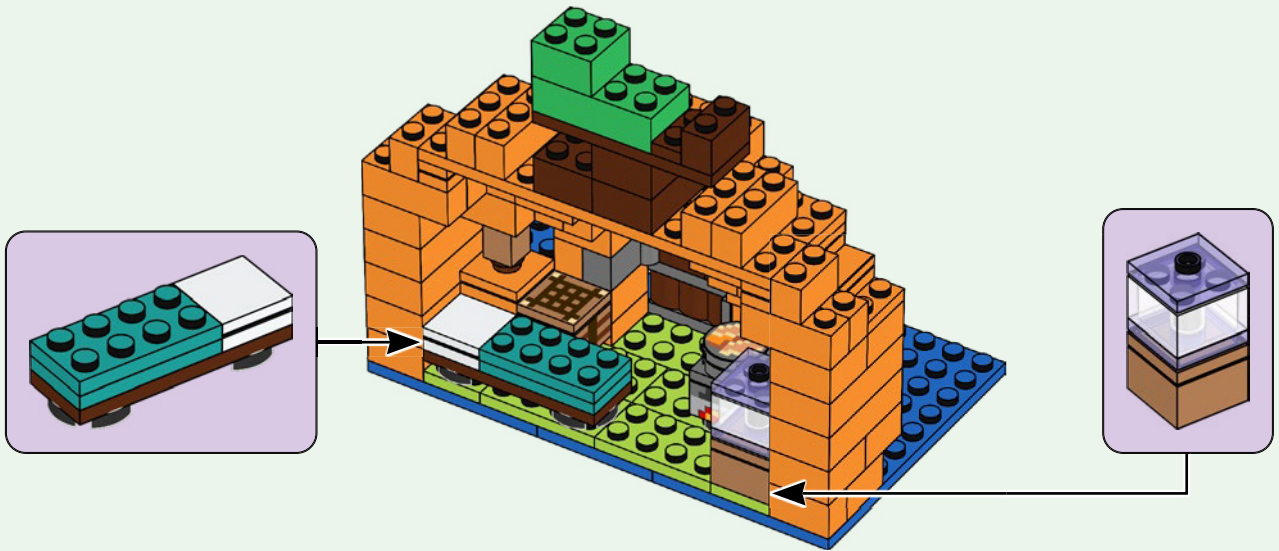

57

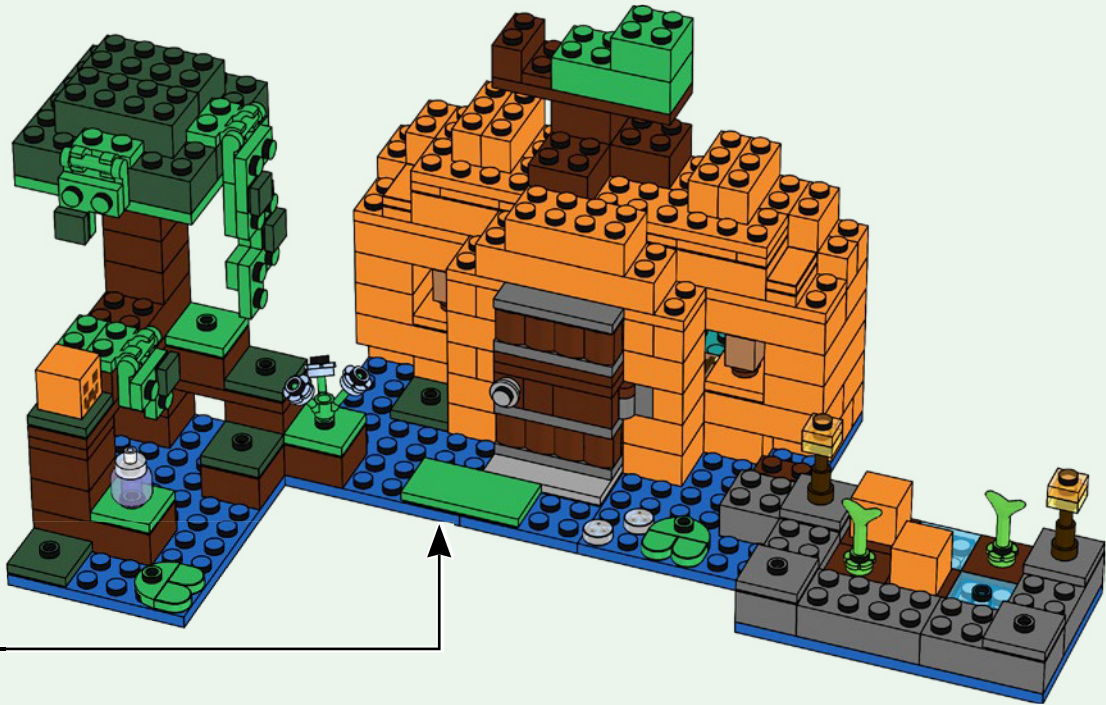





# MINECRAFT

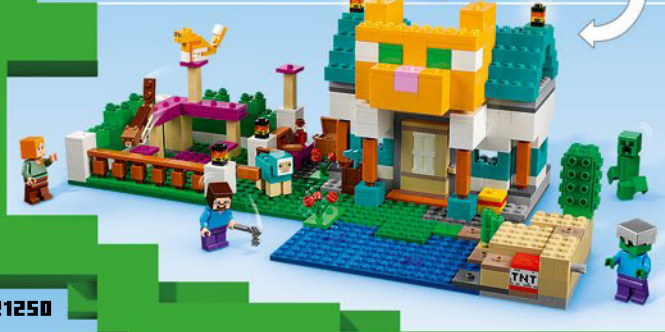



# MINECRAFT



Create your own designs

Conçois tes propres créations

Crea tus propios diseños



1x  
614101



1x  
6143595



1x  
302201



1x  
306801



3x  
302001



1x  
303023



4x  
6339304



4x  
403226



1x  
6430829



4x  
6250600



2x  
6424859



1x  
6269971

62



1x  
302328



3x  
6347288



3x  
4521931



3x  
6389692



1x  
300328



7x  
4157120



1x  
4566179



1x  
4106356



1x  
6097194



2x  
6206150



2x  
4119479



2x  
6437905



1x  
6186867



1x  
6239418



2x  
6171732



2x  
6382531



2x  
6252045



2x  
4521571



1x  
6162469



2x  
6138167



4x  
4177932



4x  
4188771



6x  
4121739



4x  
6126063



14x  
4153825



12x  
4118787



2x  
4160593



4x  
4158355



11x  
4153827

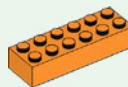

1x  
6382506

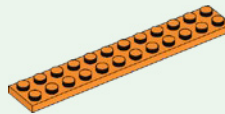

2x  
6313826



2x  
6338181



2x  
4537937



5x  
4537936



1x  
6276025



2x  
6446204



1x  
6453064



4x  
6055171



5x  
6186827



2x  
4260493



3x  
6215657



2x  
6446206



4x  
6409758



2x  
4539061



2x  
6257594



2x  
4539060



3x  
4539071



2x  
6252040



4x  
6215659



1x  
4211242



1x  
6062574



1x  
4211149



1x  
4211150

  
1x  
6345000

  
4x  
4565394

  
2x  
4216695

  
13x  
4211210

  
2x  
4211181

  
2x  
4211190

  
5x  
4211201

  
3x  
4211247

  
1x  
4211211

  
1x  
4211525

  
1x  
6437904

  
1x  
4560183

  
1x  
4211042

  
1x  
6437903

  
1x  
6216860

  
1x  
6216862

  
1x  
4211052

  
1x  
4210795

  
5x  
6126083

  
3x  
4211001

  
1x  
4211053

  
5x  
4211085

  
3x  
6209683

  
1x  
4586410

  
1x  
6437902

  
1x  
6162384

  
1x  
6005225

  
2x  
4538950

  
2x  
6057986

  
2x  
6097024

  
1x  
6058085

  
1x  
6102994

  
1x  
6097003

  
1x  
6394960

  
1x  
6102984

  
1x  
6421061

  
1x  
6104050

  
1x  
6167567



 [LEGO.com/service](https://www.LEGO.com/service)

YOU COULD **WIN**



Scan this QR code or go to **LEGO.COM/PRODUCTFEEDBACK** and give us your short feedback about this LEGO® set for a chance to win a cool LEGO prize.

Terms and Conditions apply\*

**EN: YOU COULD WIN.** Terms and Conditions apply\* **DE: Du könntest GEWINNEN.** Es gelten die Teilnahmebedingungen\* **FR: Tu pourrais GAGNER.** Des conditions s'appliquent\* **IT: Potresti VINCERE tu.** Termini e condizioni sono applicabili\* **ES: Puedes GANAR.** Aplican términos y condiciones\* **PT: Poderá GANHAR.** Aplicam-se termos e condições\* **ZH: 轻松获奖. 条款和条件适用\*** **PL: Szansa na WYGRANĄ.** Obowiązują warunki korzystania\* **CS: Máte šanci VYHRÁT.** Platí všeobecné smluvní podmínky\* **SK: Máte šancu VYHRAŤ.** Platia všeobecné zmluvné podmienky\* **HU: TE IS NYERHETSZ.** Felhasználási feltételek érvényesek\* **RO: Ai putea CÂȘTIGA.** Se aplică termeni și condiții\* **BG: Можете да СПЕЧЕЛИТЕ.** Има определени правила и условия\* **LV: Tu vari LAIMĒT.** Ir spēkā noteikumi un nosacījumi.\* **ET: Sul on võimalus VÕITA.** Kehtivad tingimused\* **LT: Jūs galite LAIMĖTI.** Taikomos sąlygos\*

\*[LEGO.com/productfeedback-terms](https://www.lego.com/productfeedback-terms)

LEGO and the LEGO logo are trademarks of the/son des marques de commerce du/son marcas registradas de LEGO Group.  
©2023 The LEGO Group.

© 2023 Mojang AB. All Rights Reserved. Minecraft, the Minecraft logo, the Mojang Studios logo and the Creeper logo are trademarks of the Microsoft group of companies.

6474807