

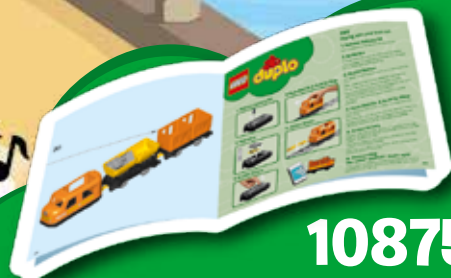

LEGO duplo



10875
LEGO.com/DUPLO



duplo

**FUN &
PLAYFUL
LEARNING**

**UN
APPRENTISSAGE
LUDIQUE
ET AMUSANT**

Disney
JUNIOR
**MICKEY
AND THE
ROADSTER
RACERS**

**APRENDIZAJE
CON DIVERSION
Y JUEGOS**



10861
Âges 1½-3



10881
Âges 2-5

Âges/edades

1½



10863
Âges 1½-3



10871
Ages 2-5

10875
Ages 2-5



10880
Ages 2-5



5





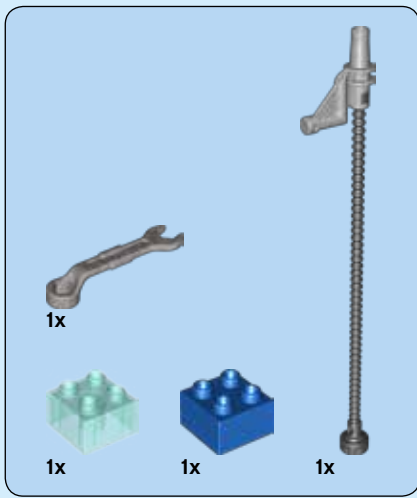

1

1



2

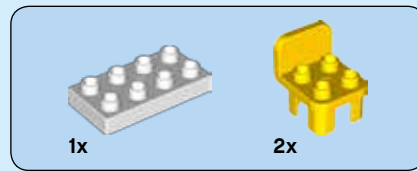

2

1



2



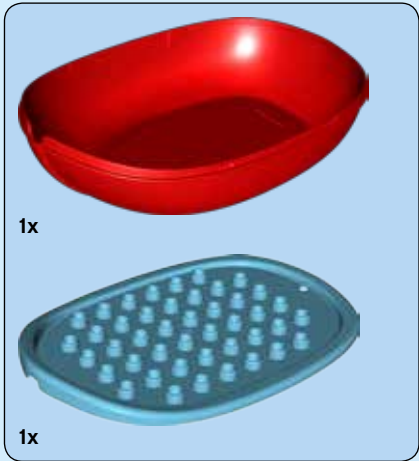

1

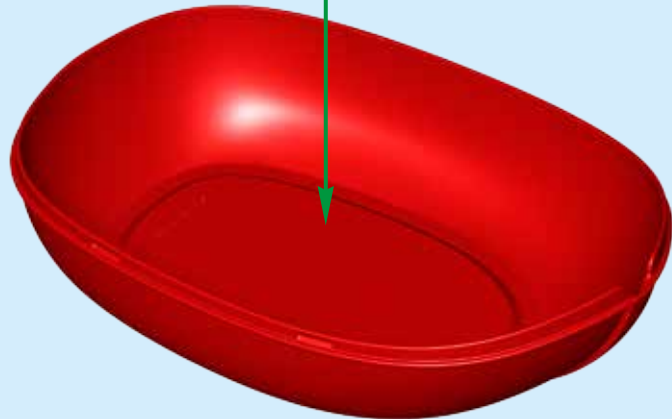
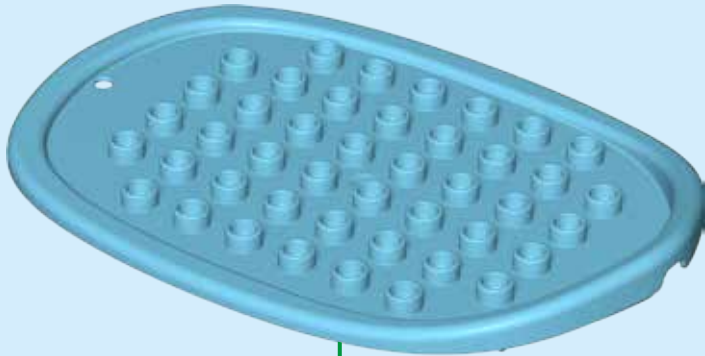

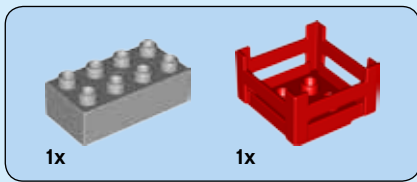

2

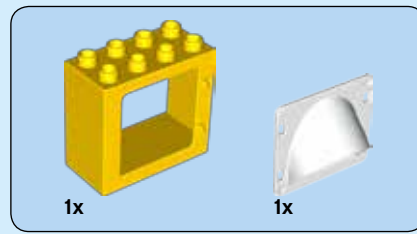
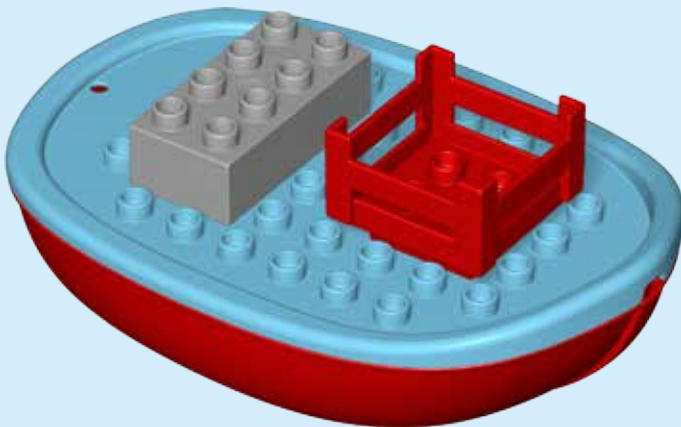

3

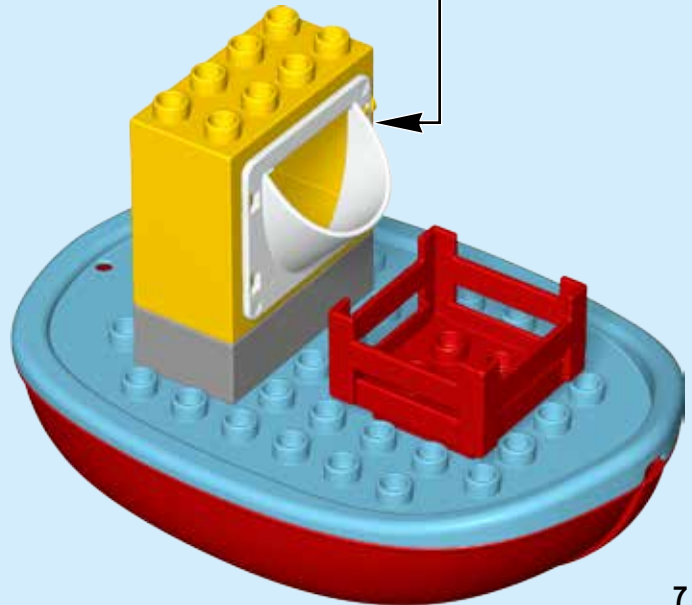
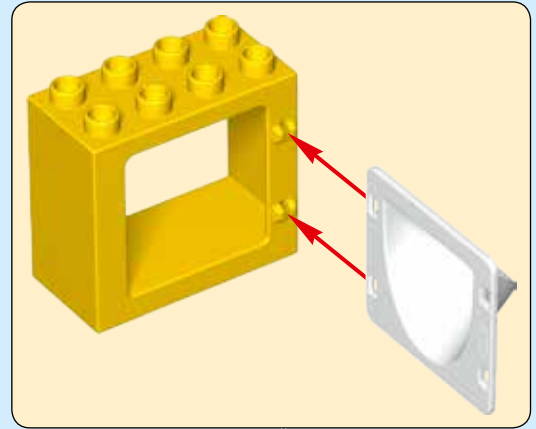

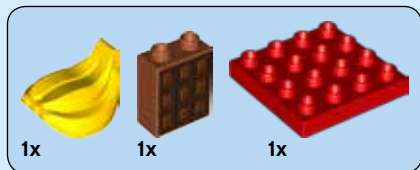

4

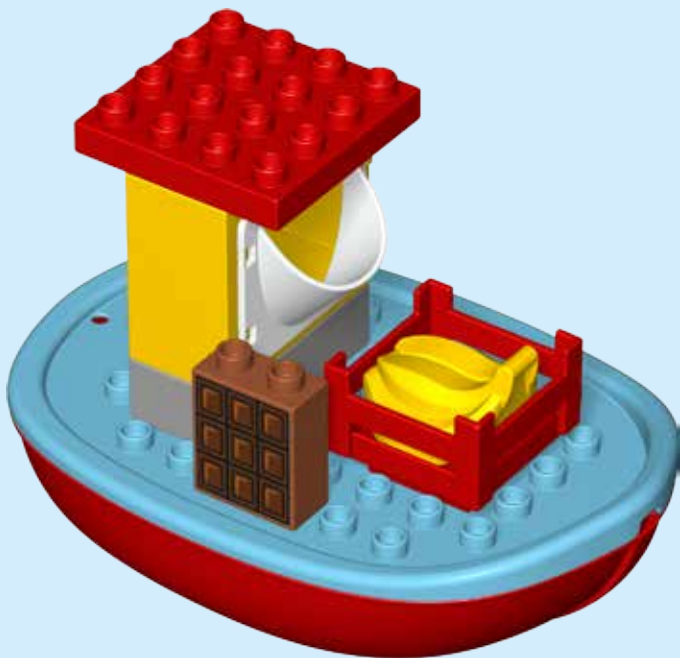

5



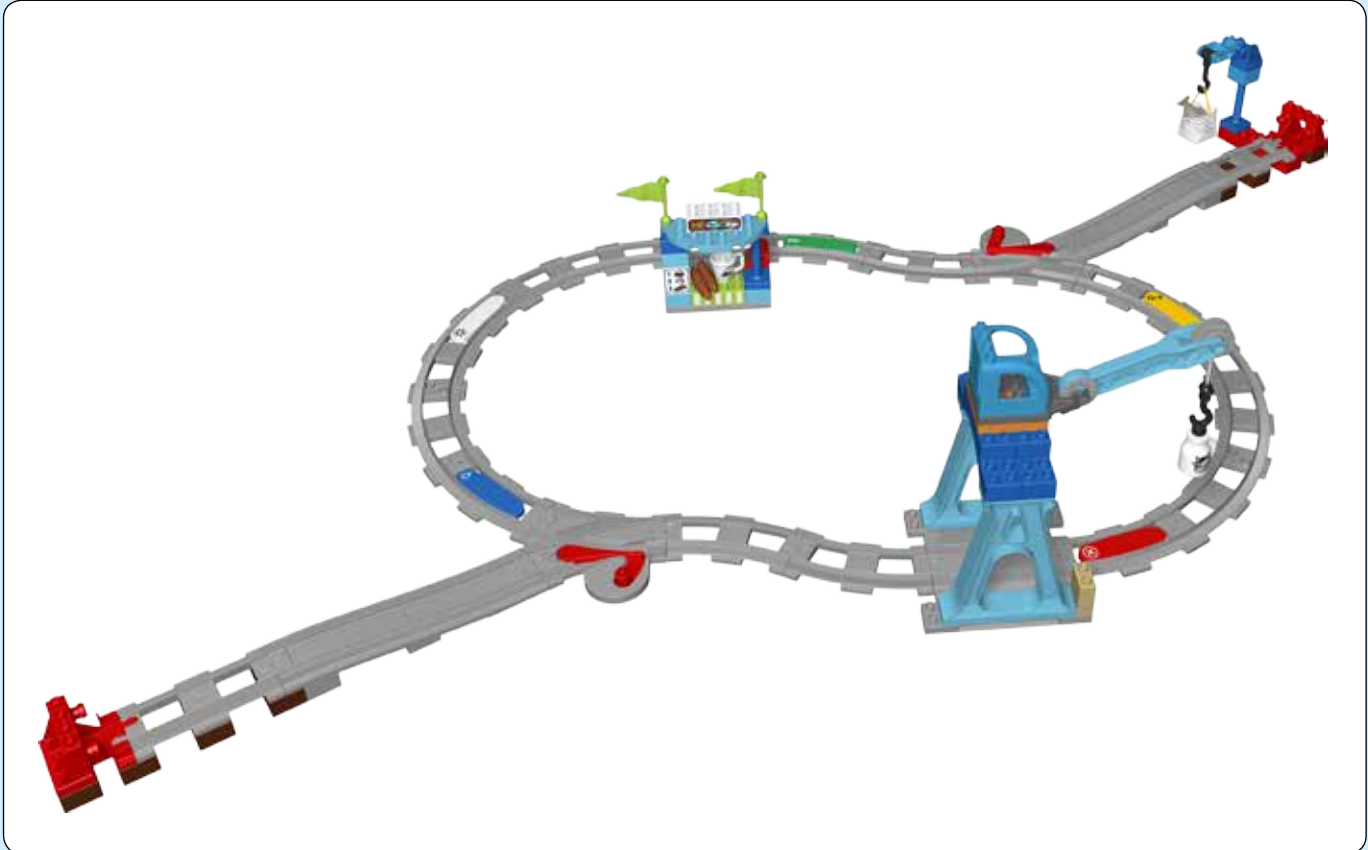

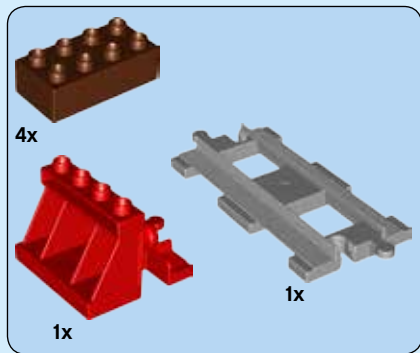

1

1

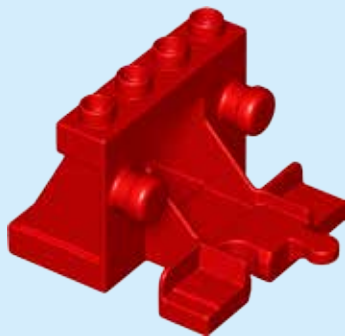

2

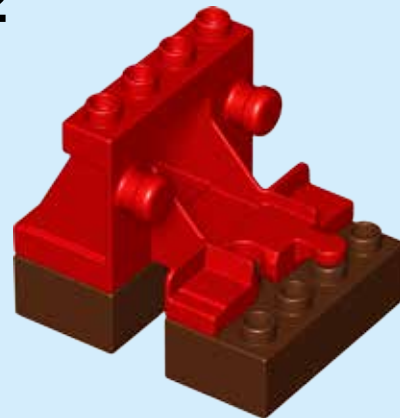

3

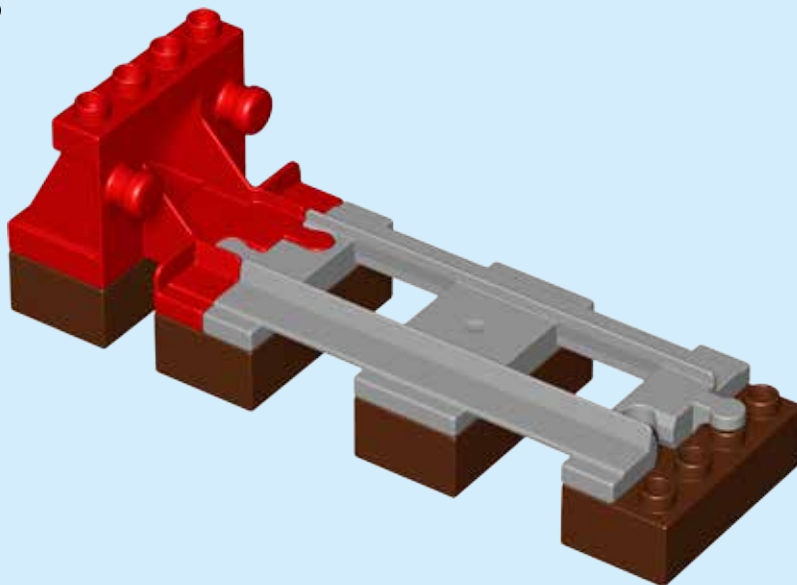

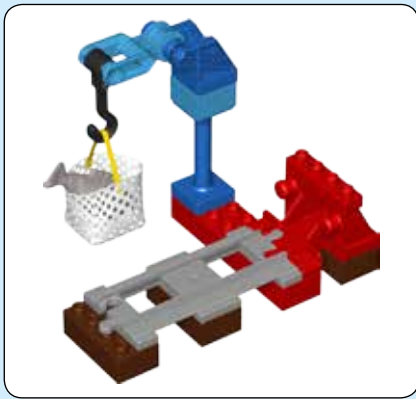

1x

2

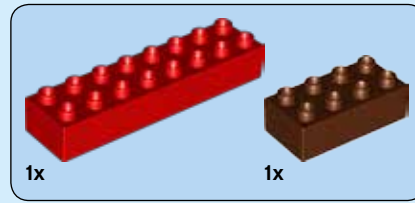
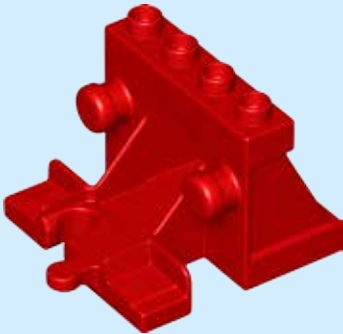

1x

1x

3

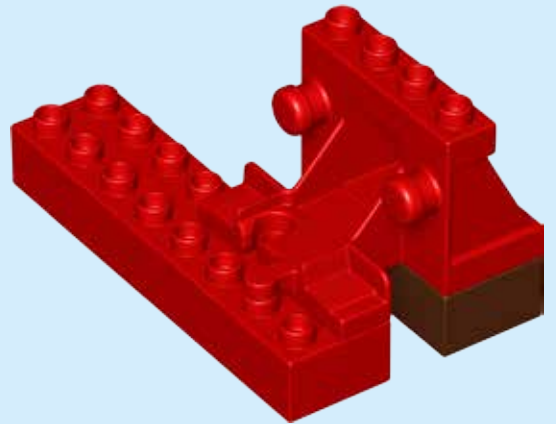

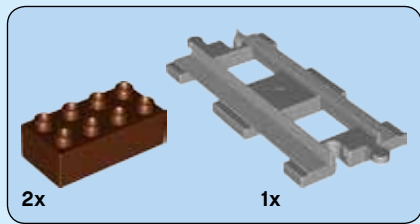

4

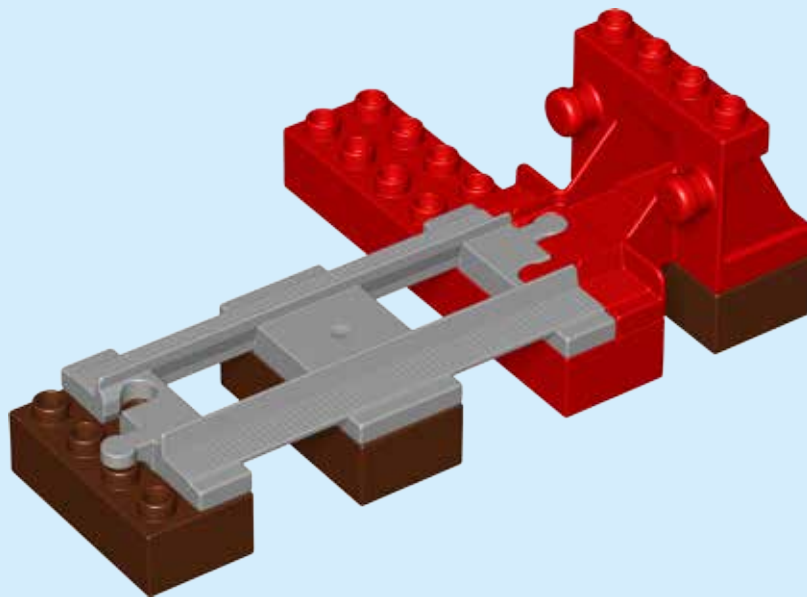

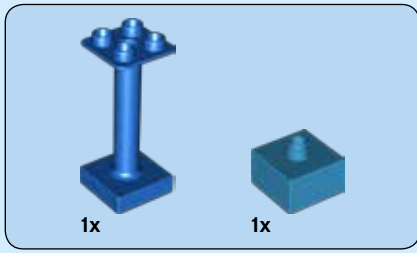

5

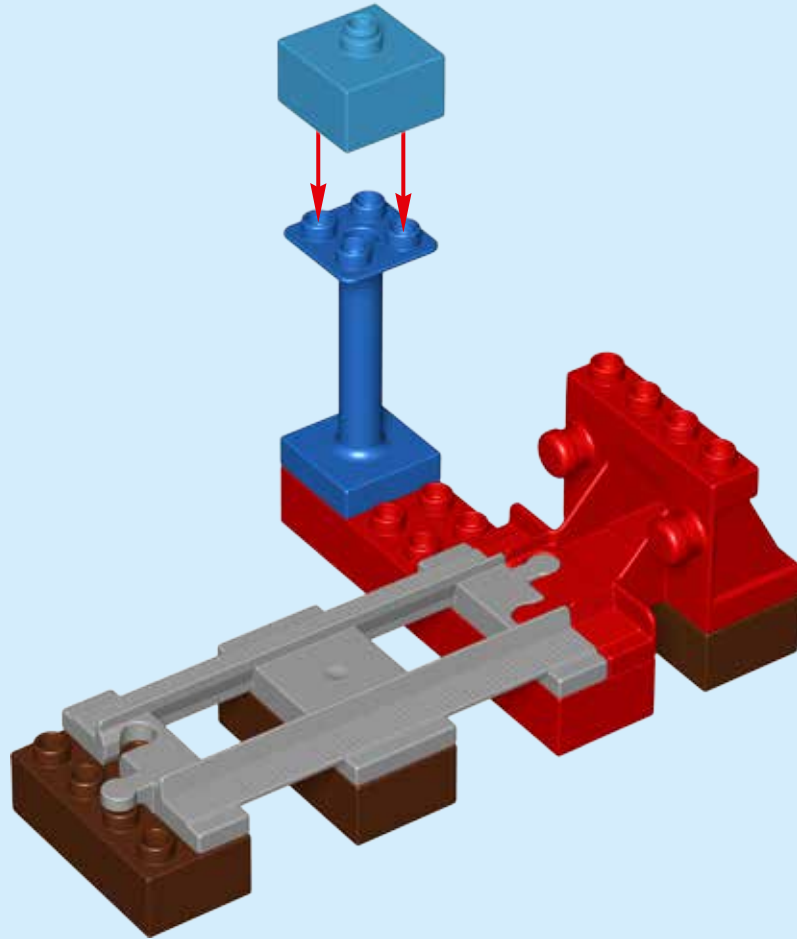



6

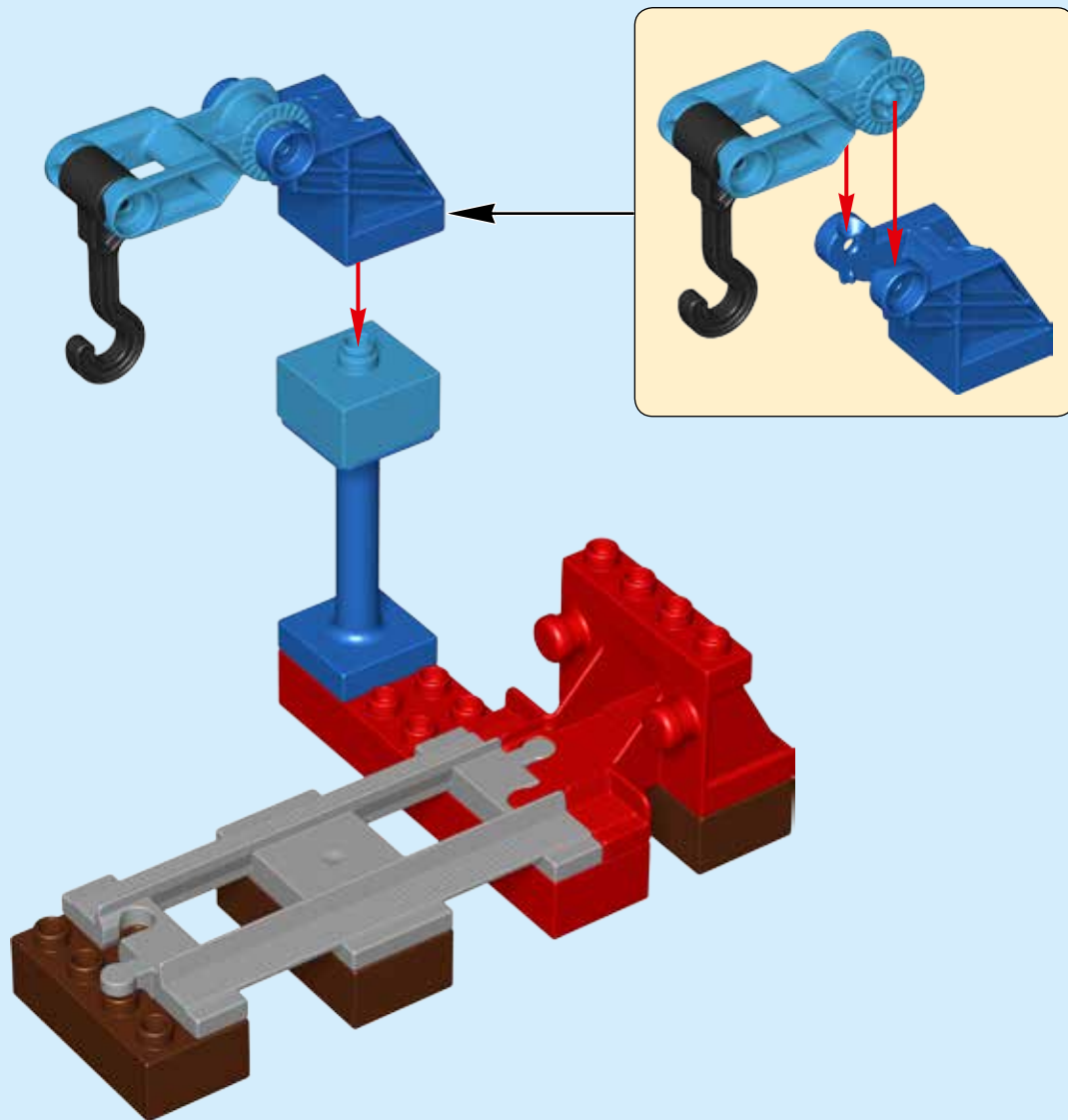

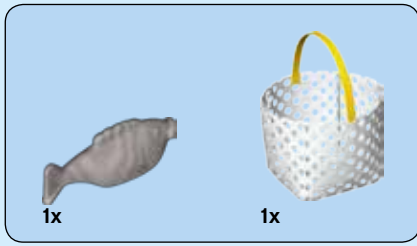

7

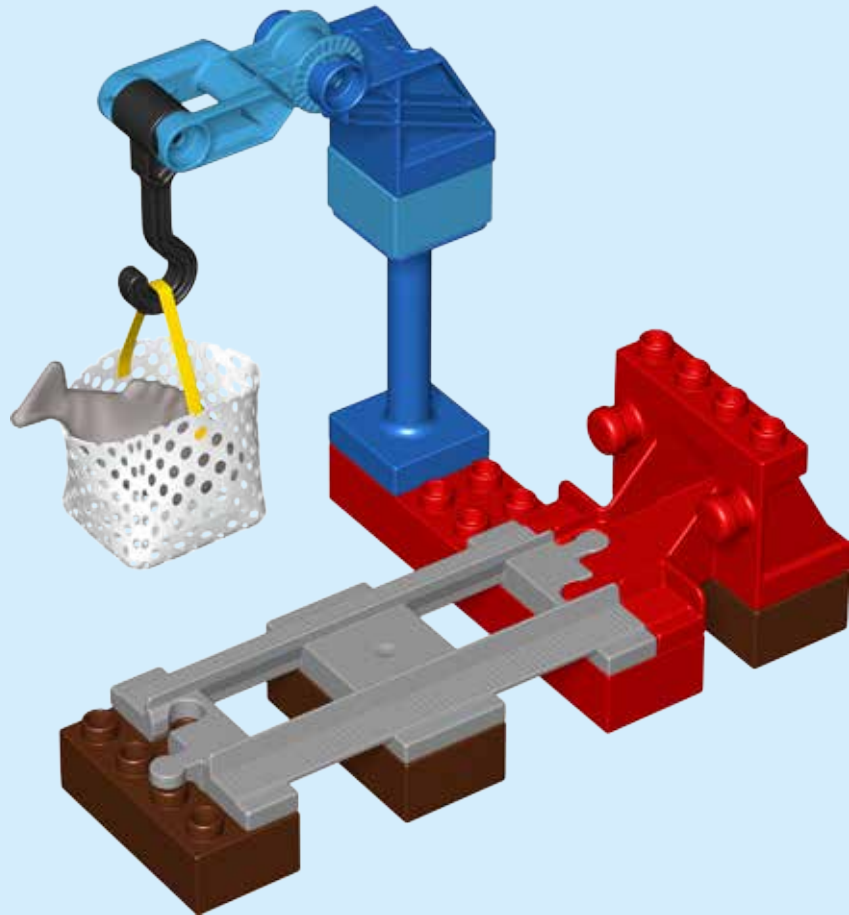

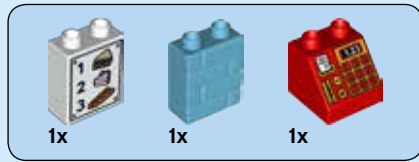
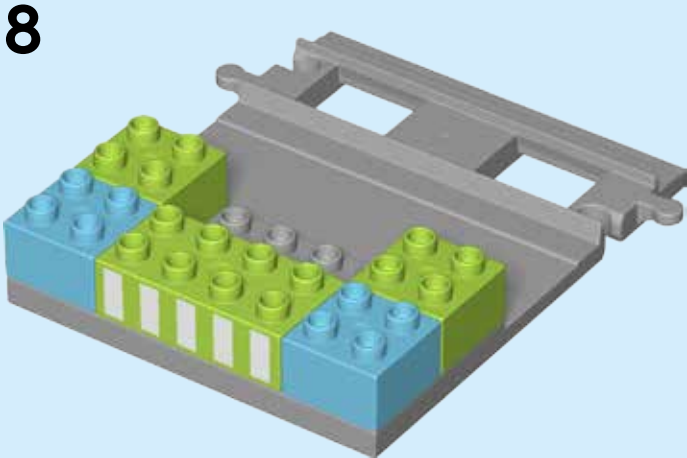
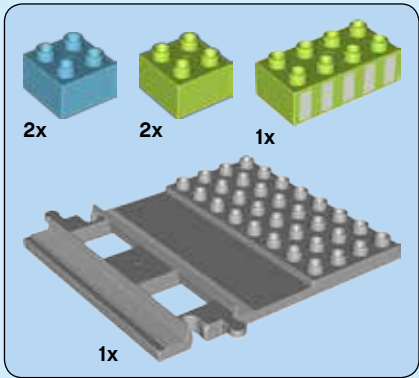

9

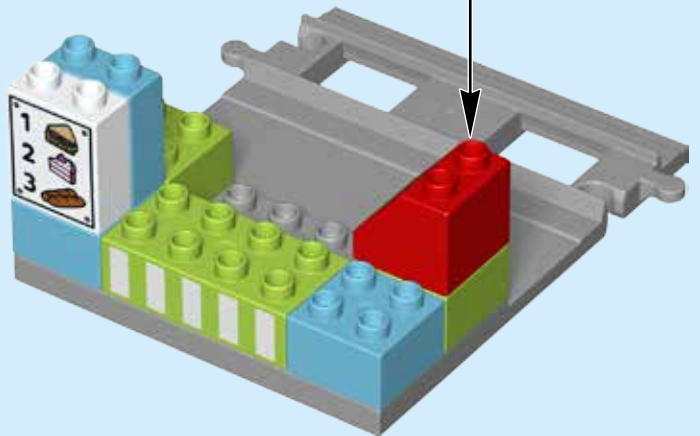

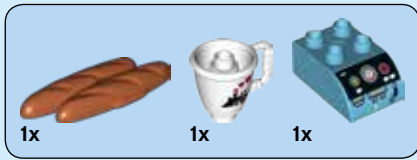

10

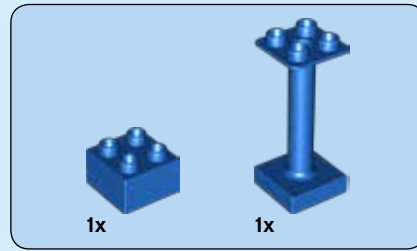
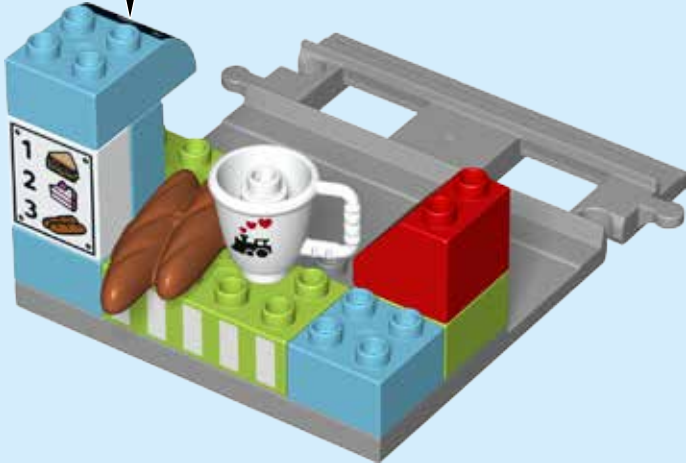
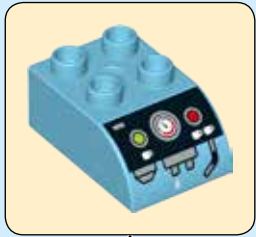

11

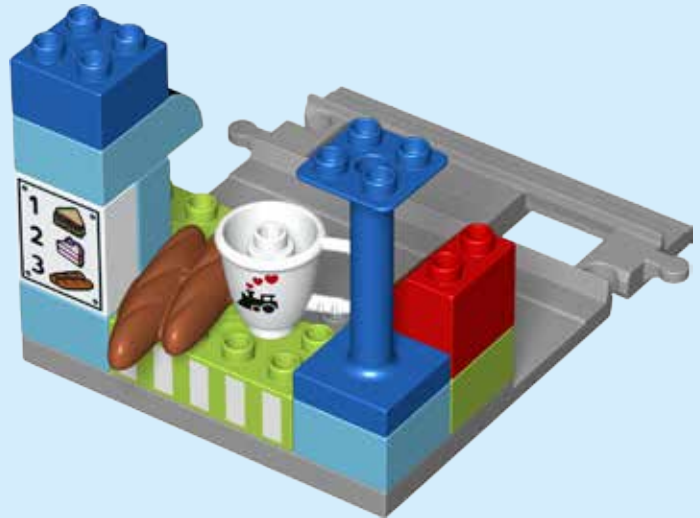

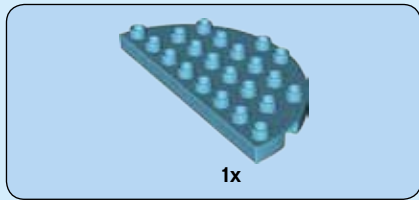

12

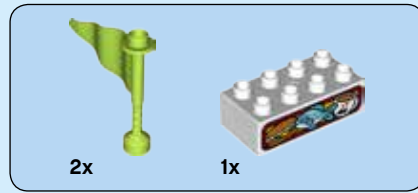
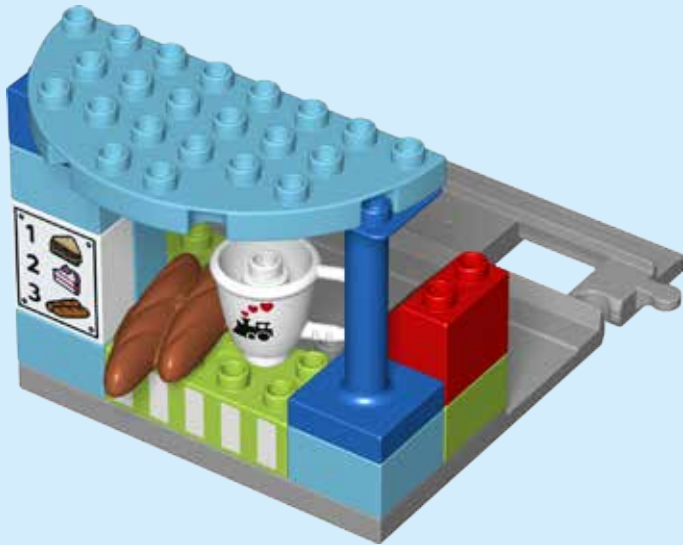

13



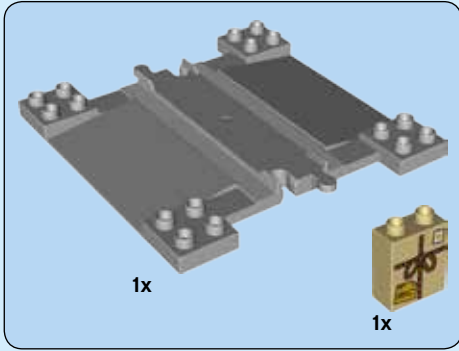
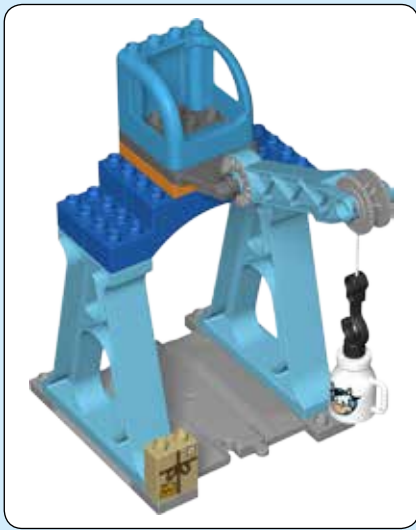

14

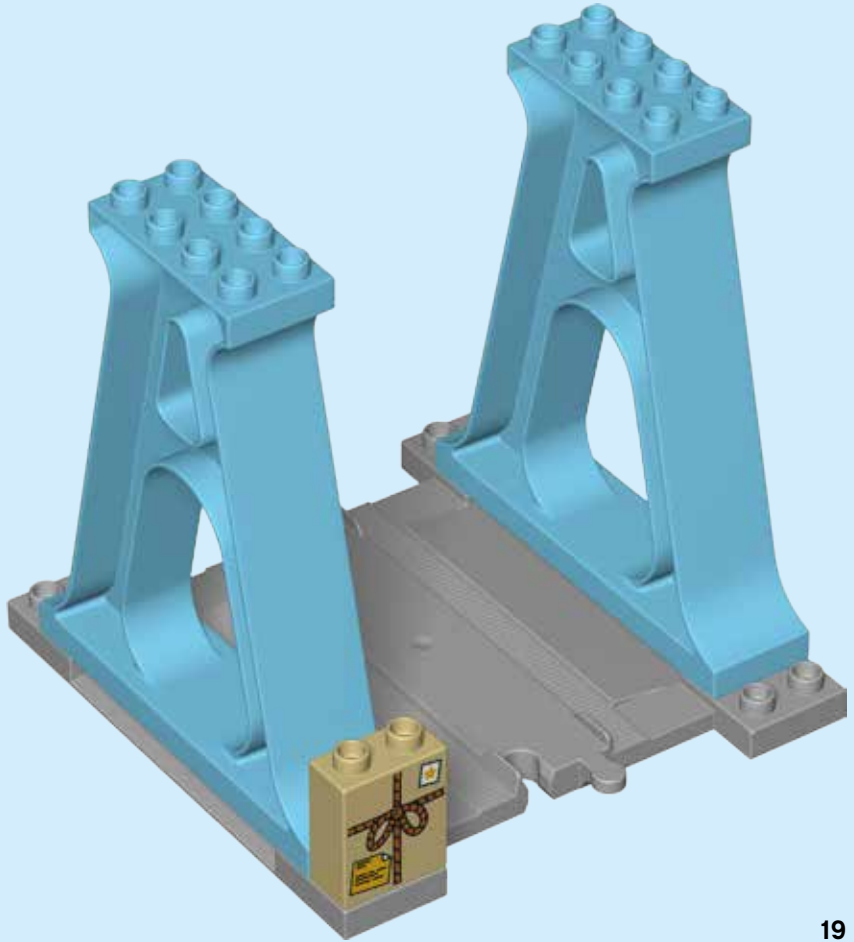

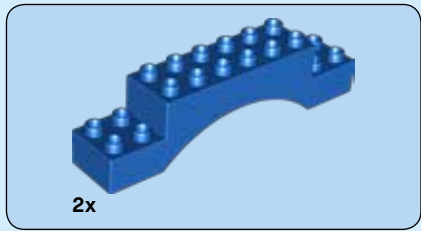

15

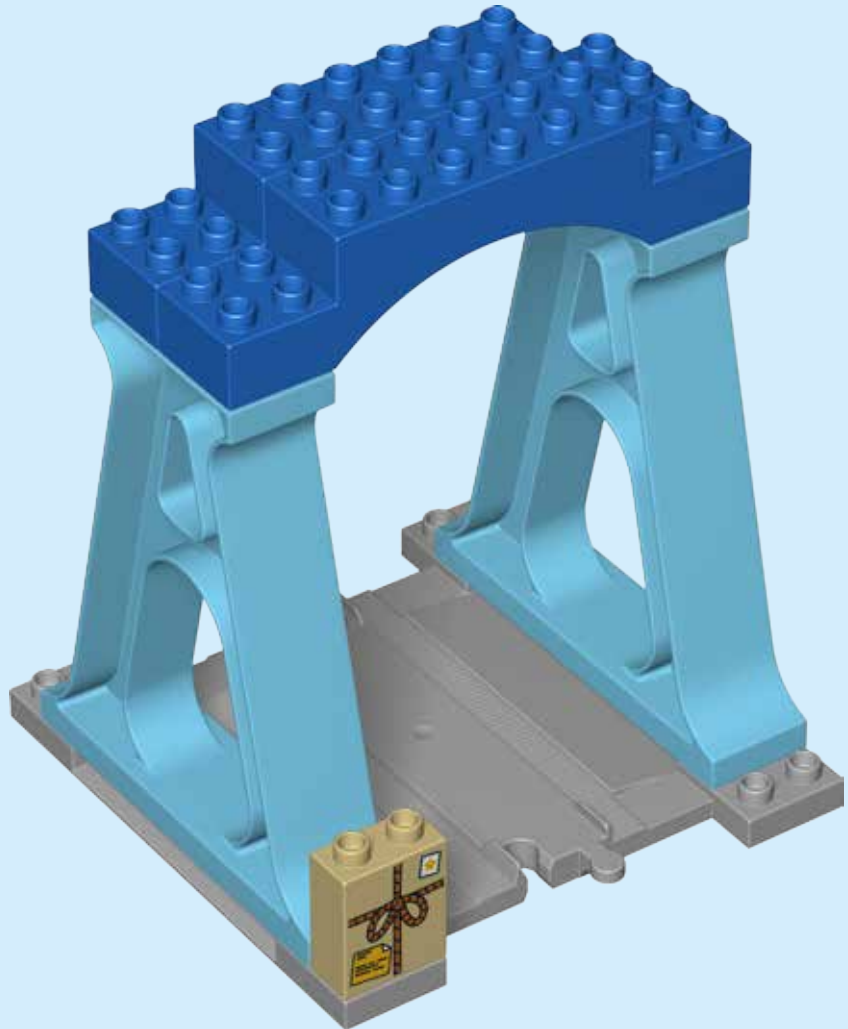

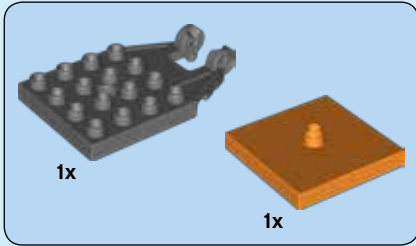
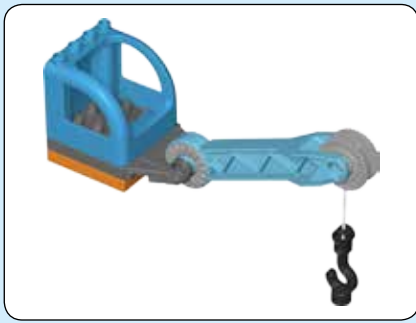

16

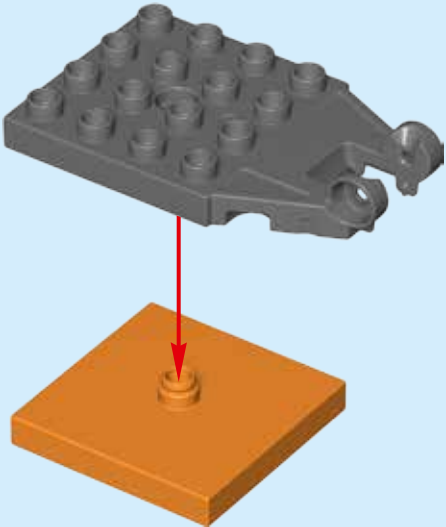

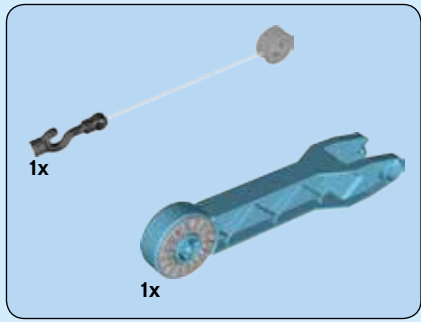

17

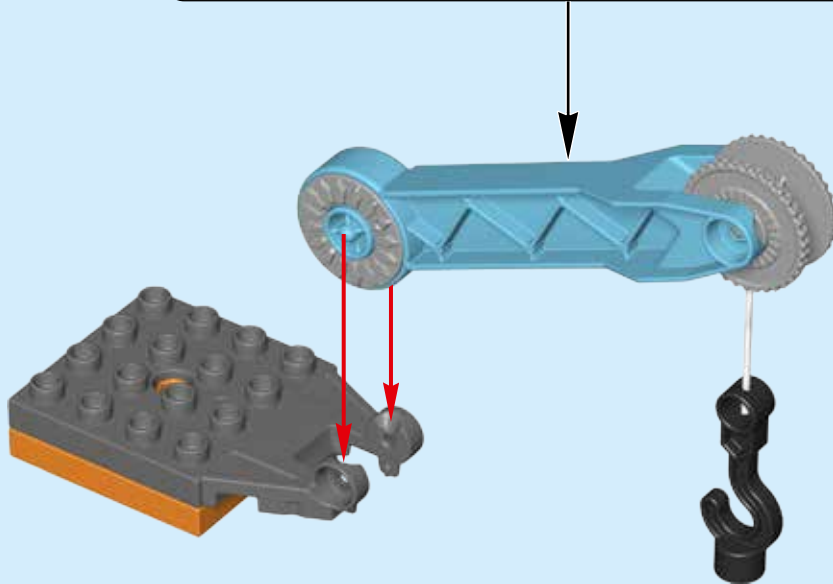
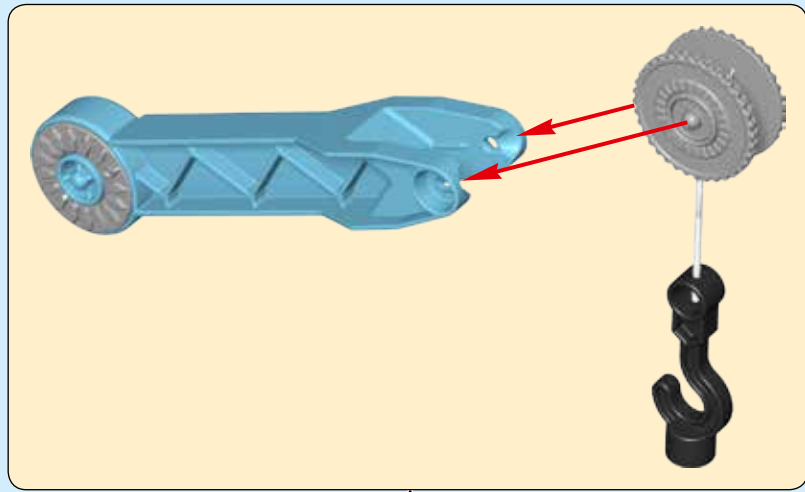

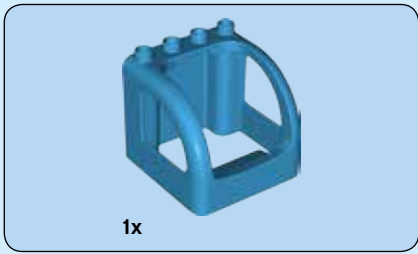

18

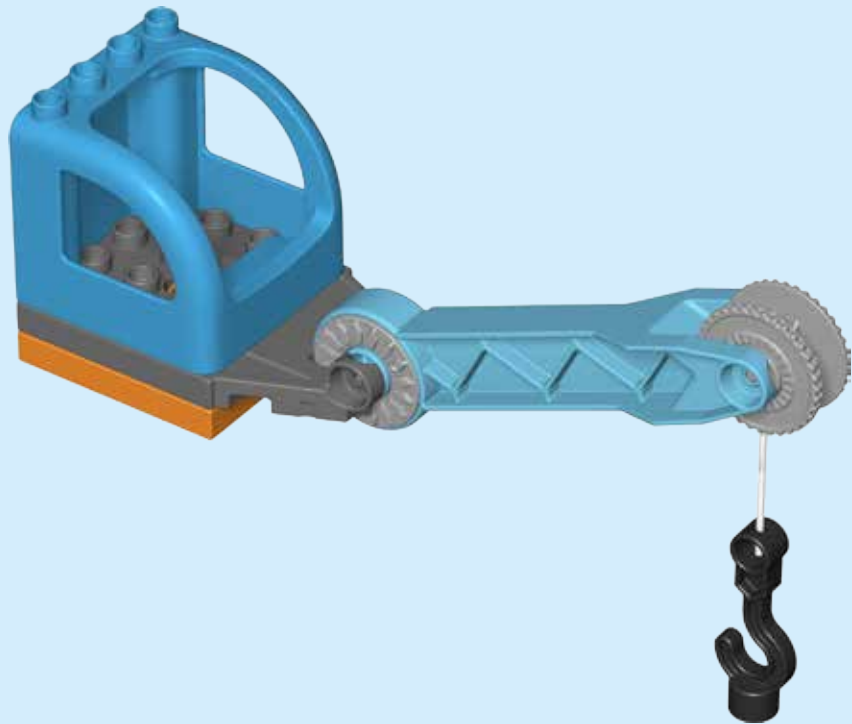

19

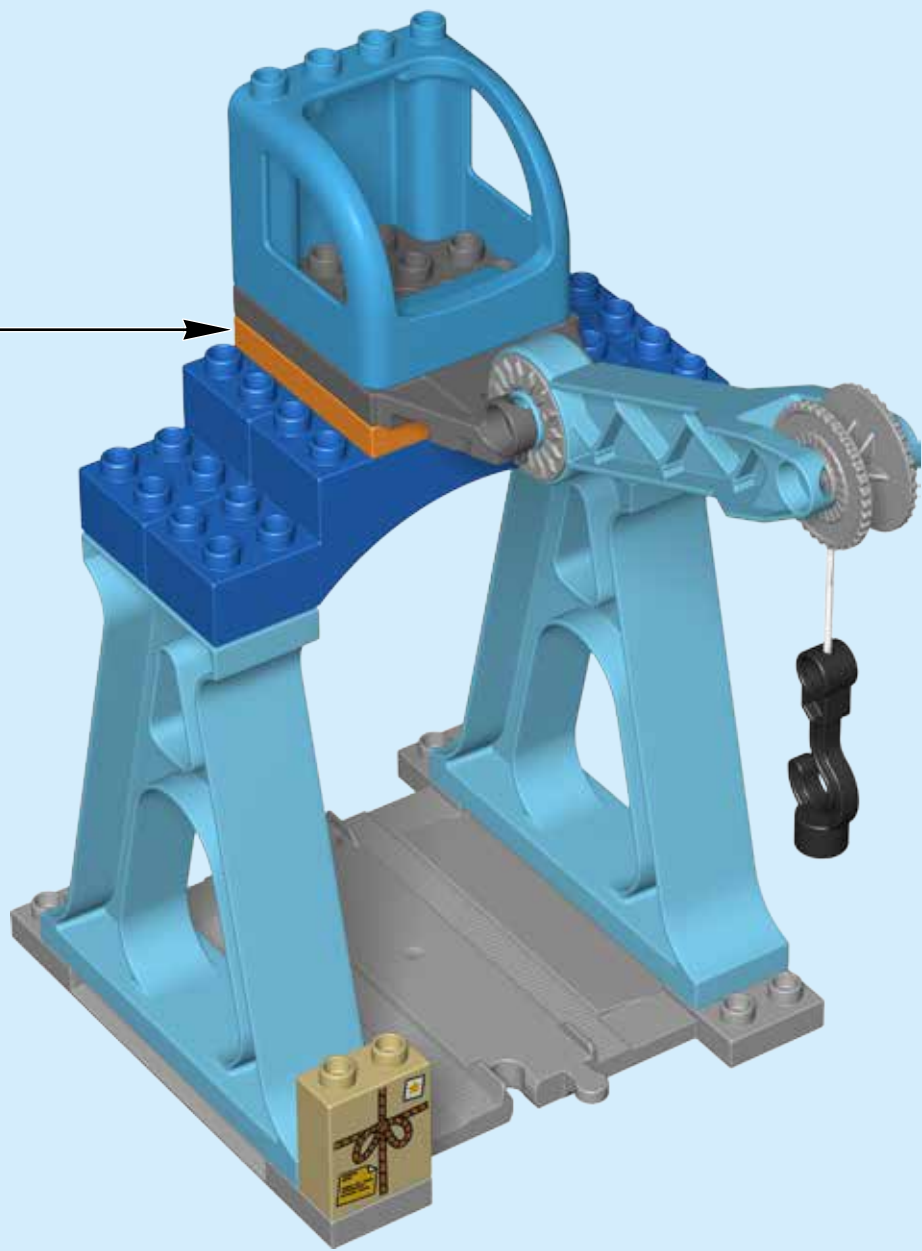



1x

20

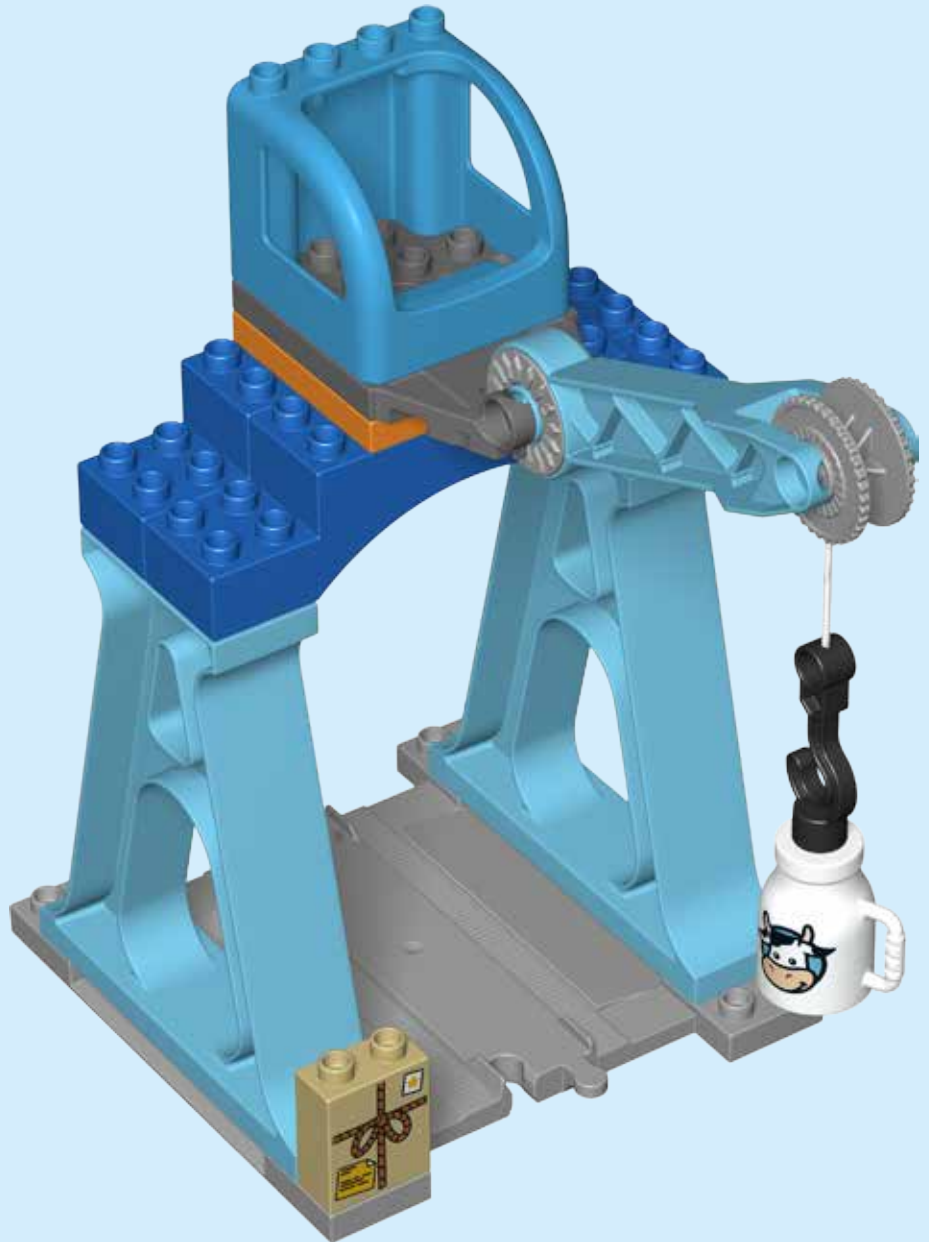

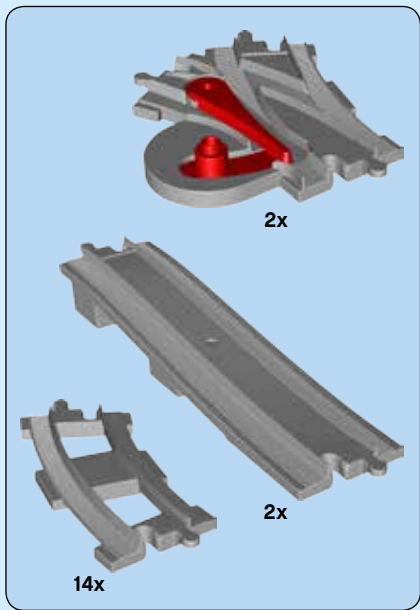

21

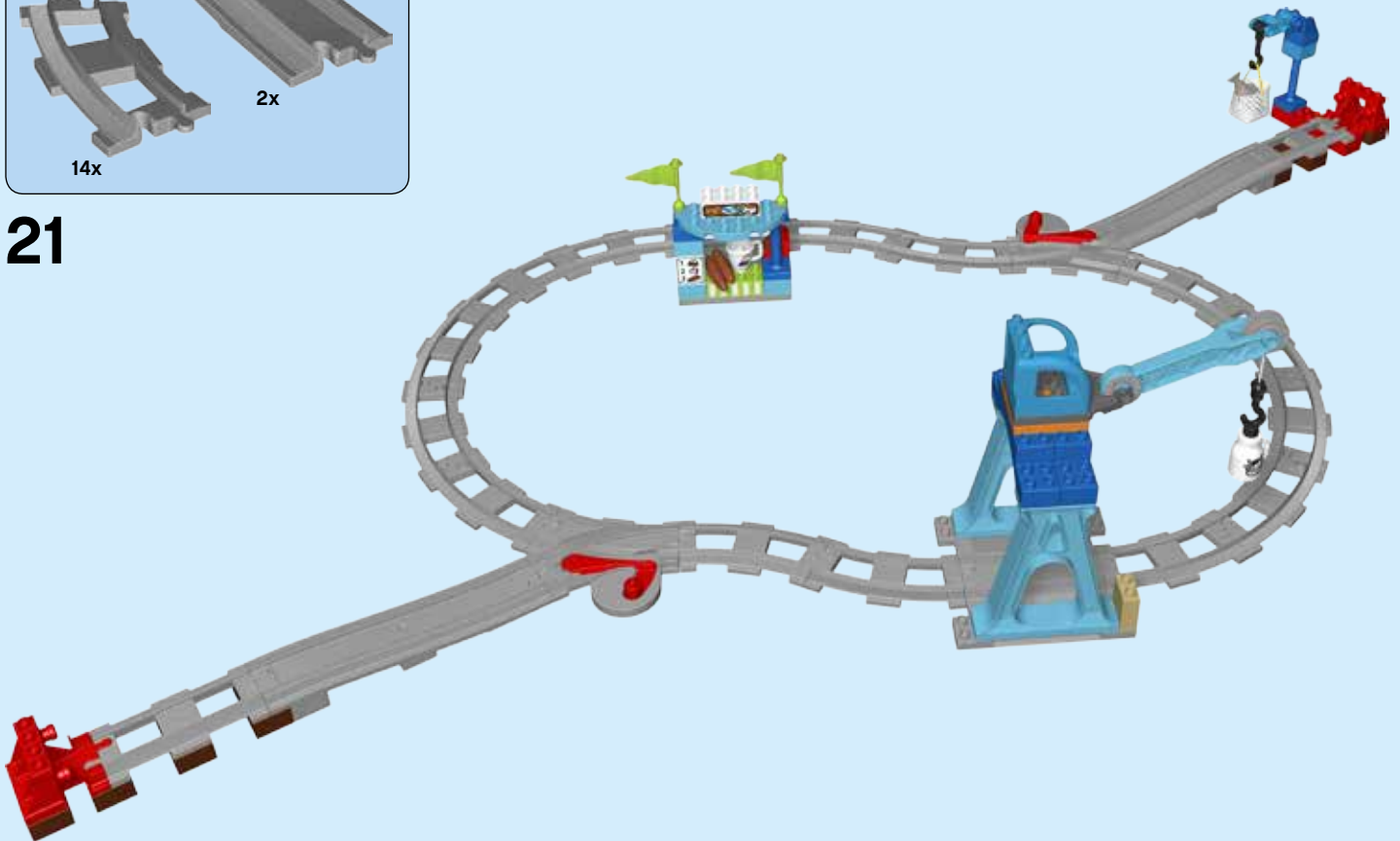

26

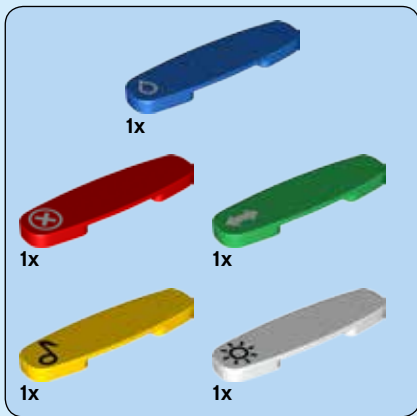

22

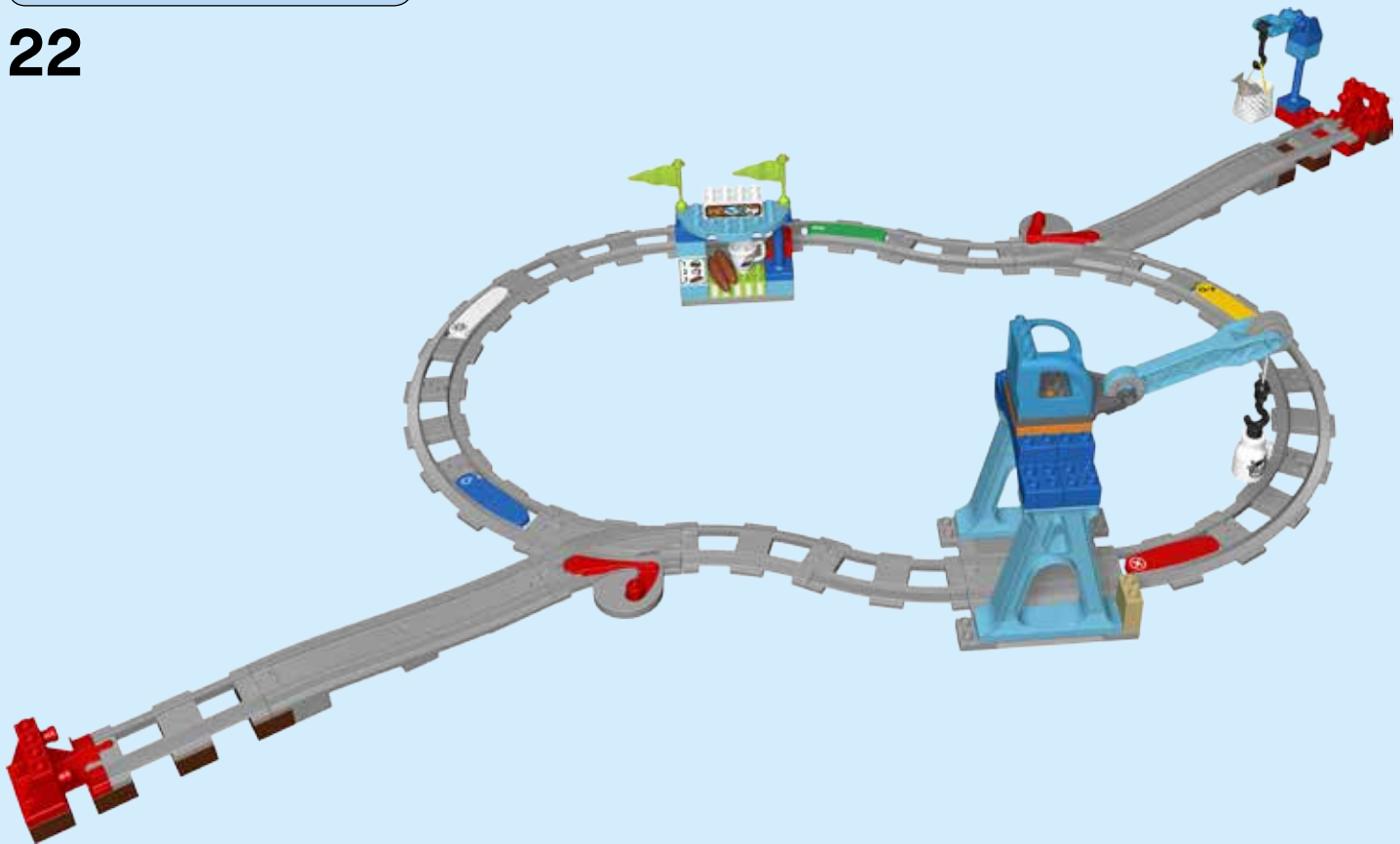

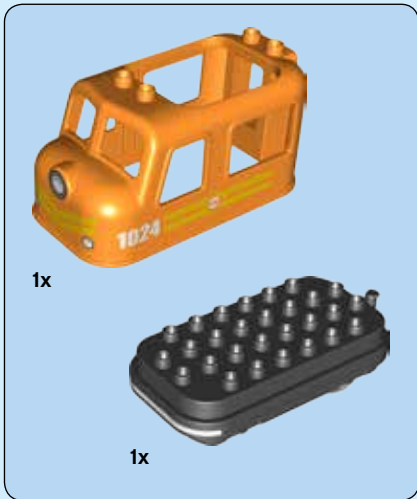

23

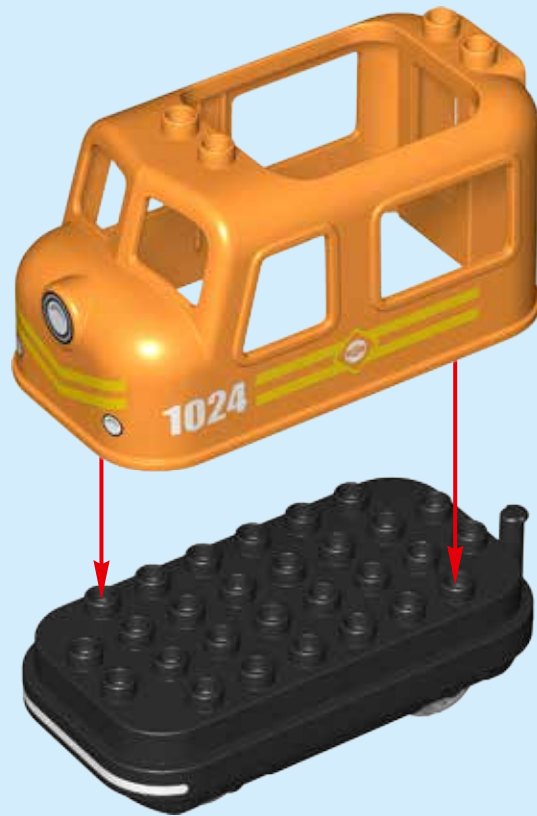



24

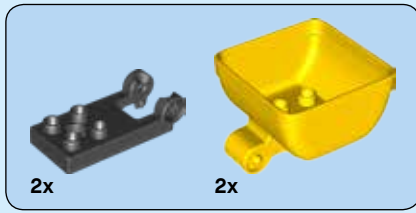

25

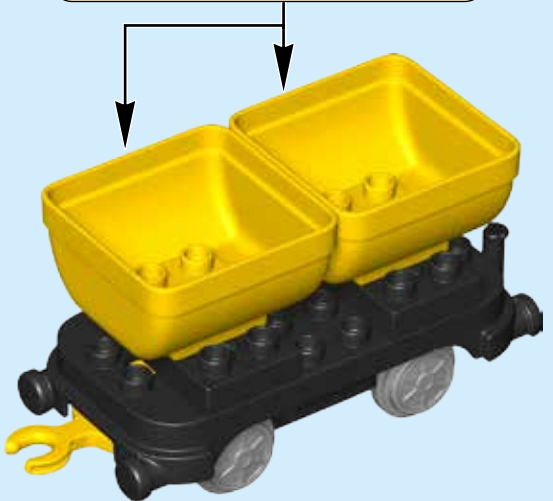

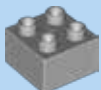

2x

26



27





28

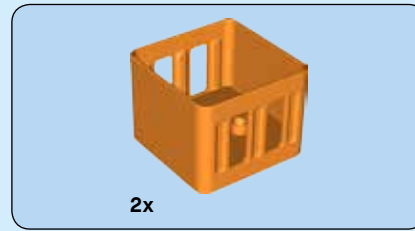

29

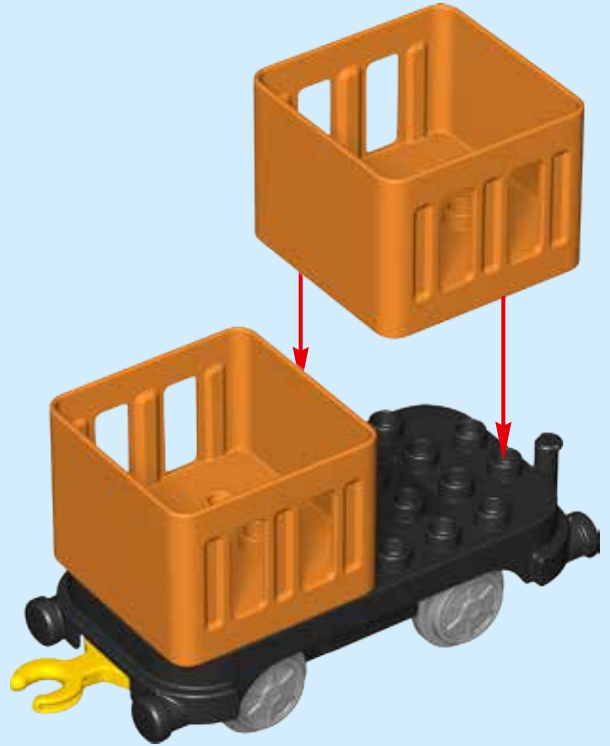

30





duplo

1. Release battery lid

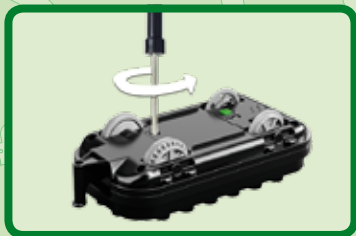

2. Batteries

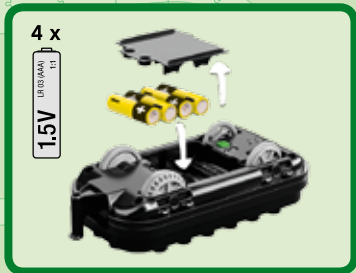

3. On/Off Button



4. Push-And-Go & Hold-To-Stop



5. Action Bricks



ENUS

Playing with your train set

1. Release battery lid

Use a screwdriver to release the battery lid

2. Batteries

To insert batteries correctly follow the illustration.

Low batteries or overloading the train is indicated by the front light flashing orange.

3. On/Off Button

The green On/Off button is placed underneath the train.

Make sure that the 4 x AAA batteries are inserted.

To turn the train On, press the green button.

Successful activation will be indicated by the front light turning white and a short sound.

To turn the train Off the green button must be pressed.

4. Push-And-Go & Hold-To-Stop

Push-And-Go and Hold-To-Stop requires that the train is On.

To make the train go push it in the desired direction.

To stop the train you hold it by hand. The train will also stop if movement is otherwise prevented.

5. Action Bricks

To play with the Action Bricks, it requires that the train is On and the Action Bricks are placed on the LEGO® DUPLO® tracks.

The Action Bricks can only be placed on the flat curved and straight tracks.

The train can detect the Action Brick going both forwards and backwards.

6. Connecting the LEGO® DUPLO® Train app

Learn more at LEGO.com/devicecheck to find a compatible device, download the app and find instructions for set up.



FRCA

Pour jouer avec le train

1. Ouvrir le couvercle des piles

Utiliser un tournevis pour ouvrir le couvercle des piles.

2. Piles

Suivre les instructions pour insérer correctement les piles.

La lumière à l'avant devient orange et clignote lorsque les piles sont faibles ou que le train est trop chargé.

3. Bouton Marche/Arrêt

Le bouton vert Marche/Arrêt est placé sous le train.

S'assurer que les 4 piles AAA sont à leur place.

Pour mettre le train en marche, appuyer sur le bouton vert.

Lorsque la lumière à l'avant devient blanche et émet une courte alerte sonore, le train est en marche.

Il suffit d'appuyer sur le bouton vert pour éteindre le train.

4. Pousser pour démarrer et retenir pour arrêter

Les options Pousser pour démarrer et Retenir pour arrêter nécessitent que le train soit allumé.

Pour faire démarrer le train, il faut le pousser dans la direction souhaitée.

Pour arrêter le train, il faut le retenir avec la main. Le train s'arrêtera également si quoi que ce soit l'empêche de se déplacer.

5. Briques d'action

Pour jouer avec les briques d'action, le train doit être allumé et les briques d'action doivent être posées sur les rails LEGO® DUPLO®.

Les briques d'action peuvent être placées uniquement sur des rails droits ou légèrement courbés.

Le train peut détecter les briques d'action, peu importe s'il avance ou s'il recule.

6. Connexion de l'application LEGO® DUPLO® Train

Visiter [LEGO.com/devicecheck](https://www.lego.com/devicecheck) pour en apprendre davantage et vérifier la compatibilité d'un appareil, télécharger l'application et trouver les instructions de configuration.

ESMX

Para jugar con tu tren

1. Apertura de la tapa de las pilas

Usa un desarmador para abrir la tapa de las pilas.

2. Pilas

Mira la ilustración para insertar correctamente las pilas.

Cuando el indicador luminoso delantero parpadea en color naranja, significa que las pilas se están agotando o que el tren está sobrecargado.

3. Botón de encendido/apagado

El botón verde de encendido/apagado se localiza debajo del tren.

Asegúrate de haber insertado las 4 pilas AAA.

Para encender el tren, presiona el botón verde.

Si la activación tiene lugar correctamente, el indicador luminoso delantero se iluminará en color blanco y sonará un breve aviso acústico.

Para apagar el tren, presiona el botón verde.

4. “Empuja para avanzar” y “ Sujeta para detener”

Para usar las funciones “Empuja para avanzar” y “Sujeta para detener”, el tren debe estar encendido.

Empuja el tren en el sentido que quieras para que se ponga en marcha.

Para detenerlo, sujétalo con la mano.

El tren también se detendrá si no puede avanzar por cualquier motivo.

5. Bricks de acción

Para jugar con los bricks de acción, el tren debe estar encendido y los bricks de acción colocados en las vías LEGO® DUPLO®.

Los bricks de acción sólo se pueden colocar en vías curvas planas y vías rectas.

El tren puede detectar los bricks de acción hacia delante y hacia atrás.

6. Conexión a la app LEGO® DUPLO® Train

Visita [LEGO.com/devicecheck](https://www.lego.com/devicecheck) para revisar si tu dispositivo es compatible, descarga la app y sigue las instrucciones de configuración.

ENUS

Auto Stop and Auto Off

To prolong battery life, the train has two functions:

1. Auto Stop - Unless you Hold-To-Stop and Push-And-Go, the train will stop driving after 15 minutes. The train will not turn off.

2. Auto Off - If left standing still while on, the train turns off after 120 minutes. To continue playing, press the green button to turn it on again.

Safety

For safety reasons, the train will stop driving if lifted.

To start the train again, place it back onto the tracks and push it in the desired direction.

FRCA

Arrêt automatique et mise hors tension automatique

Pour prolonger la durée de vie des piles, le train a deux fonctions :

1. Arrêt automatique : à moins qu'on le retienne pour l'arrêter ou qu'on le pousse pour démarrer, le train s'arrêtera après 15 minutes. Le train ne s'éteindra pas.

2. Mise hors tension automatique : si le train est laissé immobile toujours allumé, il s'éteindra automatiquement après 120 minutes. Pour continuer à jouer, appuyer sur la touche verte pour le rallumer.

Sécurité

Pour des raisons de sécurité, le train s'arrêtera s'il est soulevé.

Pour redémarrer le train, le placer sur les rails et le pousser dans la direction souhaitée.

ESMX

Paro automático y apagado automático

Para que las pilas duren más, el tren cuenta con dos funciones:

1. Paro automático: a menos que uses las funciones "Sujeta para detener" o "Empuja para avanzar", el tren se detendrá después de 15 minutos. El tren no se apagará.

2. Apagado automático: si permanece encendido pero no recibe uso, el tren se apagará después de 120 minutos. Si quieres seguir jugando, presiona el botón verde para encenderlo de nuevo.

Seguridad

Por razones de seguridad, el tren deja de funcionar cuando se levanta.

Para poner el tren en marcha de nuevo, vuelve a colocarlo en las vías y empujalo en el sentido que quieras.



duplo

ADD & COMBINE

AJOUTER ET COMBINER

UNE Y COMBINA



10875



10872



10882

10875 + 10872 + 10882

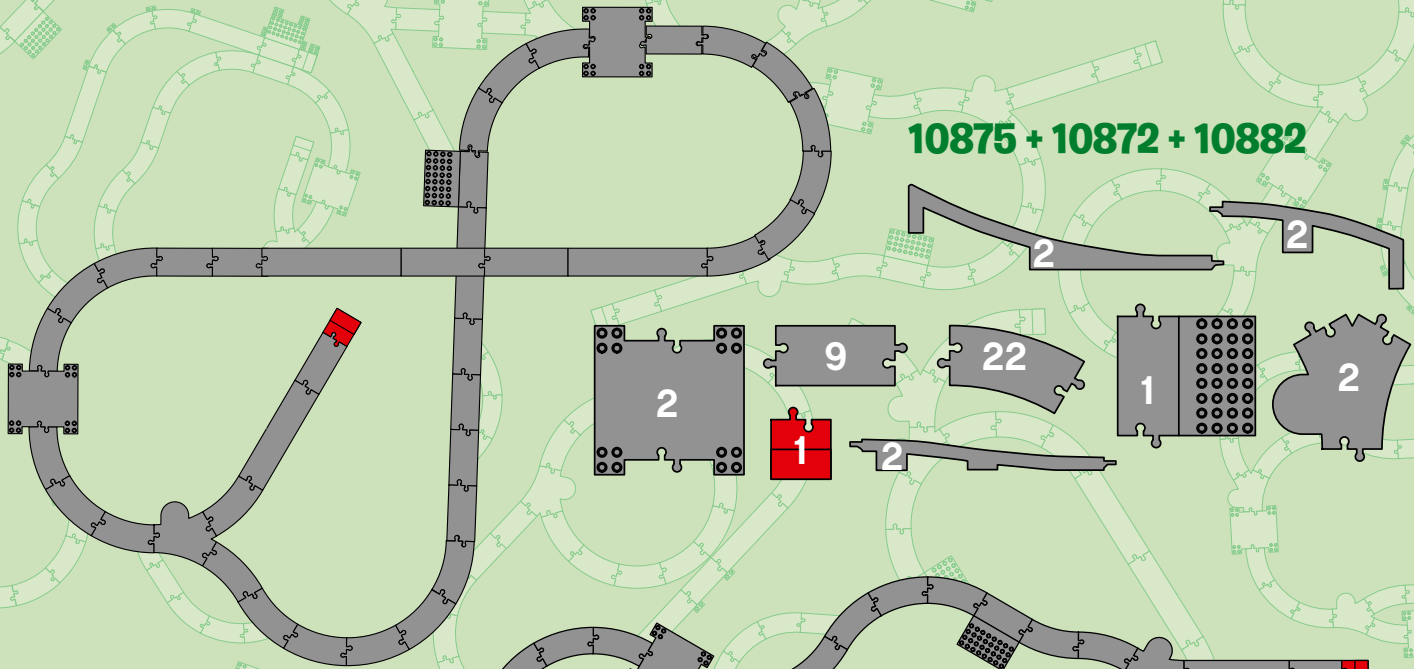

10875 + 10872 + 10882

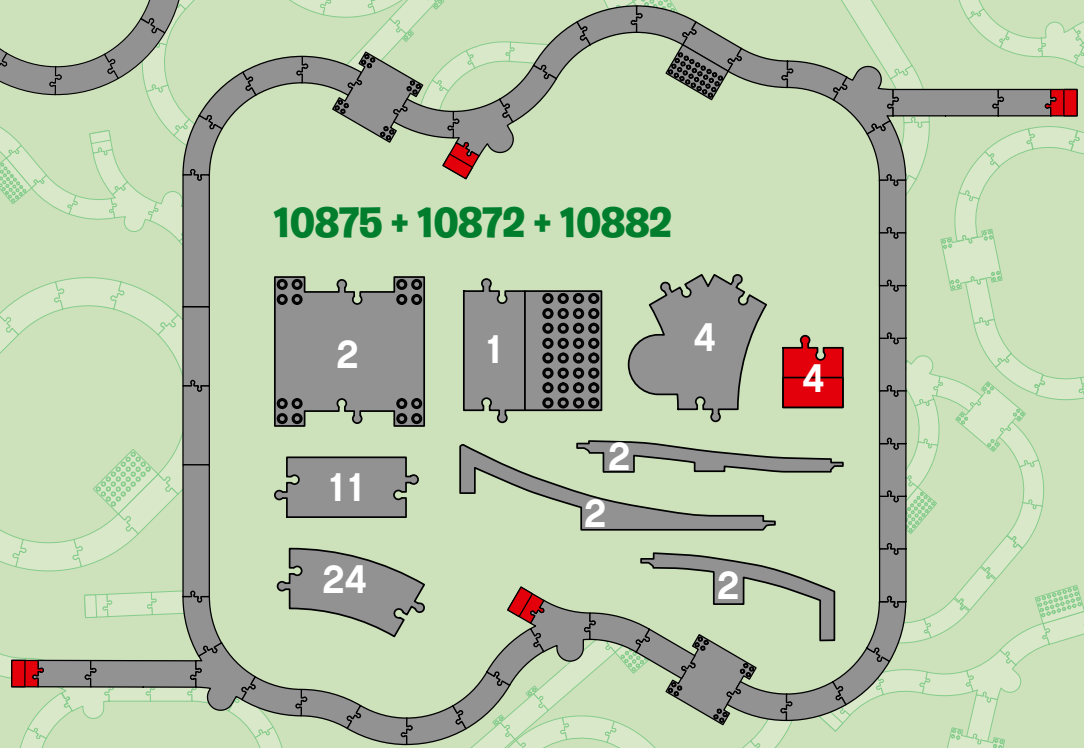



LEGO duplo



Try the new connected LEGO® DUPLO® Train app

Become the train driver with a remote control function and fun activities to complete

Essayez la nouvelle application LEGO® DUPLO® Train

Il est facile de conduire le train grâce à la fonction de commande à distance et d'effectuer les activités amusantes.

Prueba la nueva app LEGO® DUPLO® Train

Conviértete en un auténtico maquinista con la función de control remoto y las divertidas actividades



Customer Service
Kundenservice
Service Consommateurs
Servicio Al Consumidor

LEGO.com/service or dial

 : 00800 5346 5555

 : 1-800-422-5346

Learn more at LEGO.com/devicecheck
Pour en savoir plus, visiter LEGO.com/devicecheck
Más información en LEGO.com/devicecheck

The LEGO® DUPLO® train app is free and only compatible with LEGO DUPLO Trains 10874 and 10875
L'application LEGO® DUPLO® Train est gratuite et uniquement compatible avec les trains
LEGO DUPLO 10874 et 10875
La app gratuita LEGO® DUPLO® Train sólo es compatible con los trenes LEGO DUPLO 10874 y 10875

The fun continues!
L'amusement continue !
¡La diversión continúa!

FACILE À CONSTRUIRE
FÁCIL DE CONSTRUIR

EASY TO BUILD



4-7



1½-5

win

Go to
www.LEGO.com/productfeedback
and give us your short
feedback about this LEGO® DUPLO®
set for a chance to win
a cool LEGO prize

Terms & Conditions apply



LEGO.com/productfeedback

GEWINNE

Erzähle uns auf
www.LEGO.com/productfeedback

etwas über die Erfahrungen, die du mit
diesem LEGO® Set gemacht hast, und
sichere dir die Chance auf einen coolen
LEGO Preis!

Es gelten die Teilnahmebedingungen

GAGNE

Rends-toi sur
www.LEGO.com/productfeedback

et donne-nous quelques commentaires
sur ce produit LEGO® pour avoir une
chance de gagner un prix LEGO !

Voir Conditions Générales

GANAN

Visita
www.LEGO.com/productfeedback

y envíanos tu opinión acerca de este set
LEGO®. ¡Participarás en el sorteo de un
premio LEGO!

Términos y Condiciones aplicables

获取奖品

登录
www.LEGO.com/productfeedback

给出关于此乐高®套装的简短反馈，
就有机会获得炫酷乐高奖品

《条款及条件》适用

LEGO, the LEGO logo, DUPLO and the DUPLO logo are trademarks of the/son des marques de commerce du/son marcas registradas de LEGO Group. ©2018 The LEGO Group.

6249355