

1

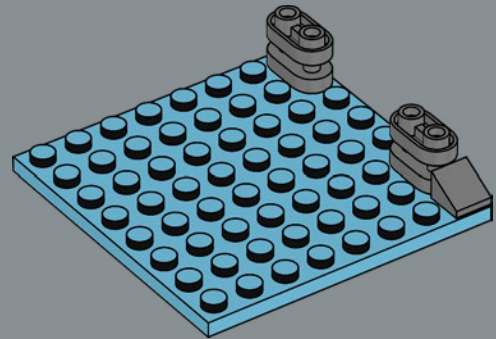

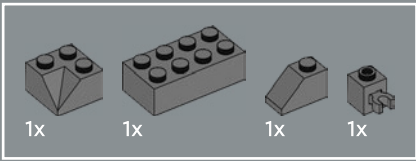

2

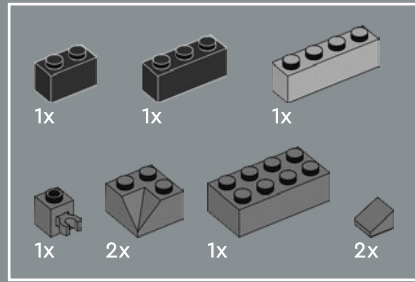
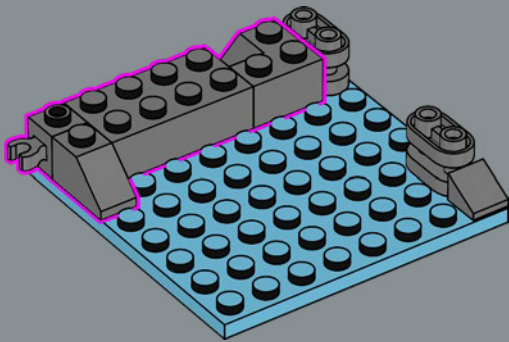

3

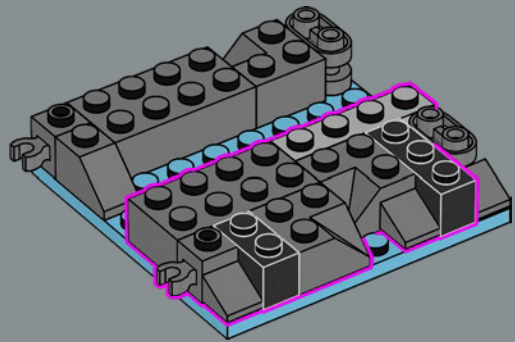



4

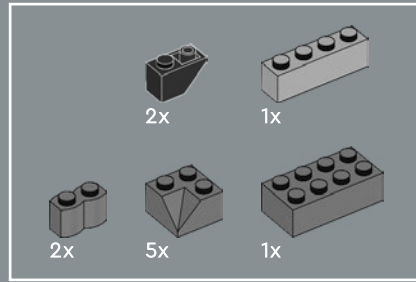
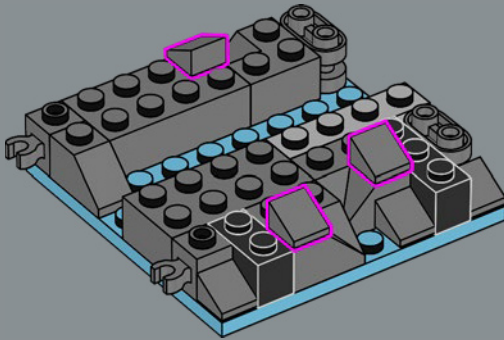

5

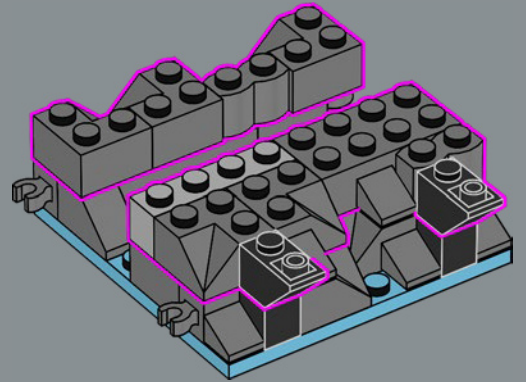



6

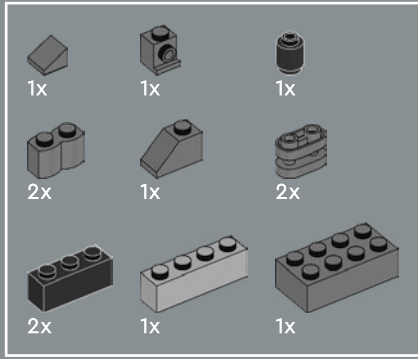
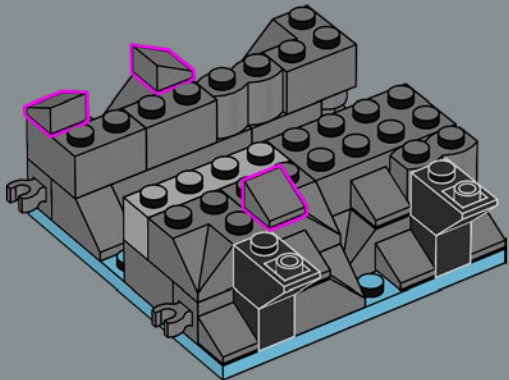

7

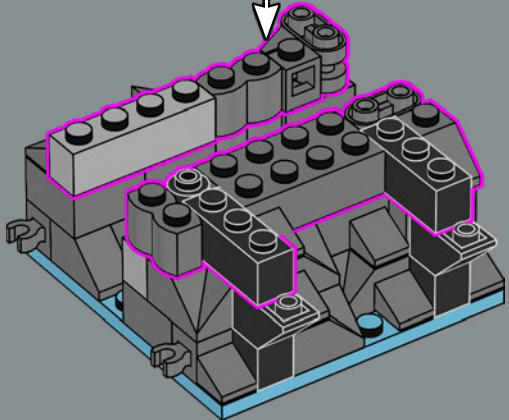
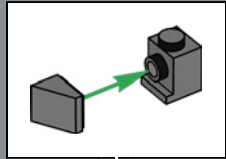

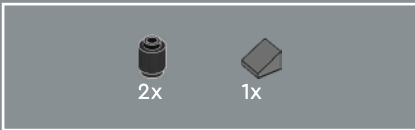

8

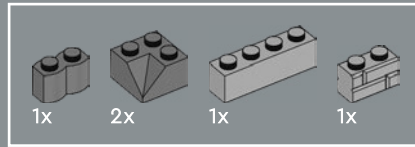
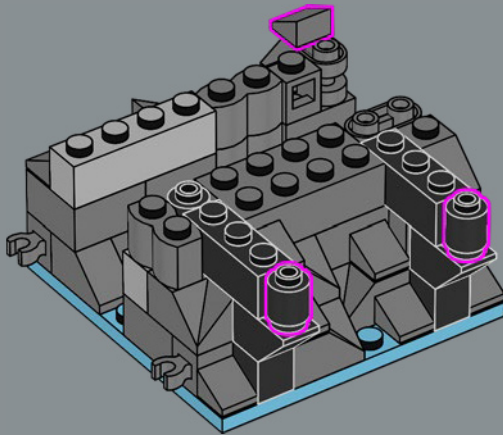

9

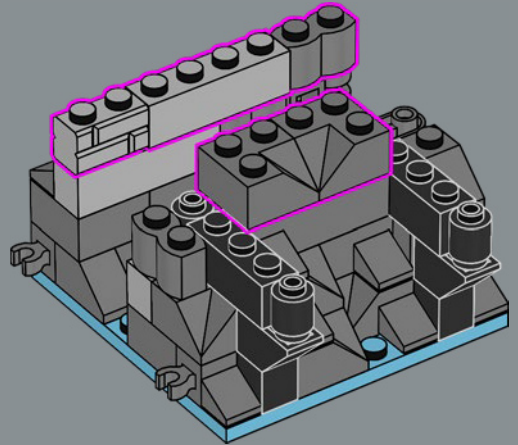

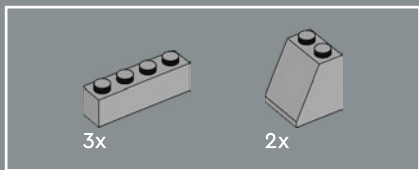

10

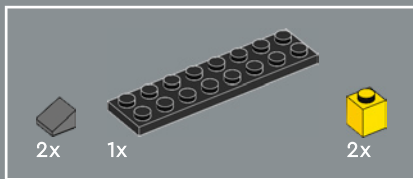
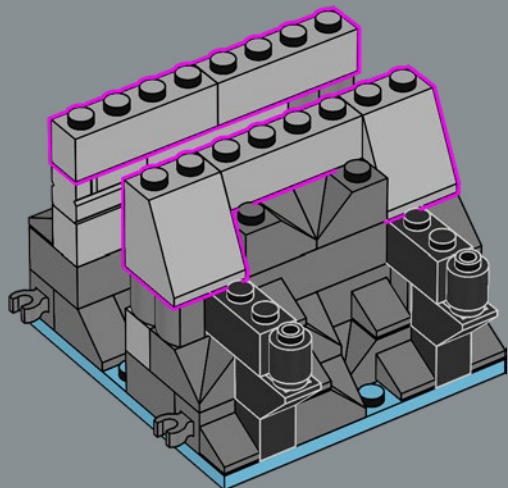

11

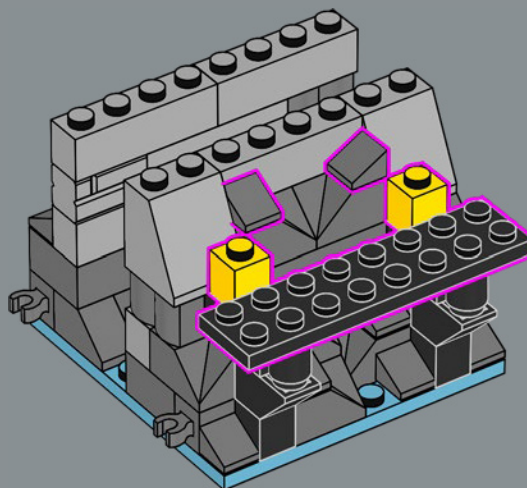

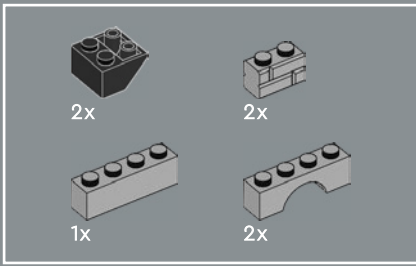

12

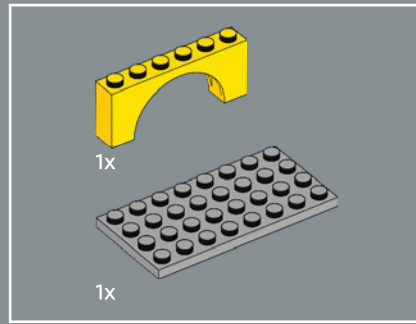
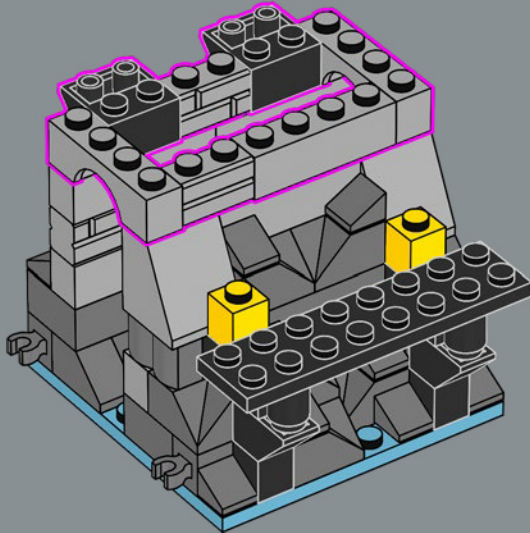

13

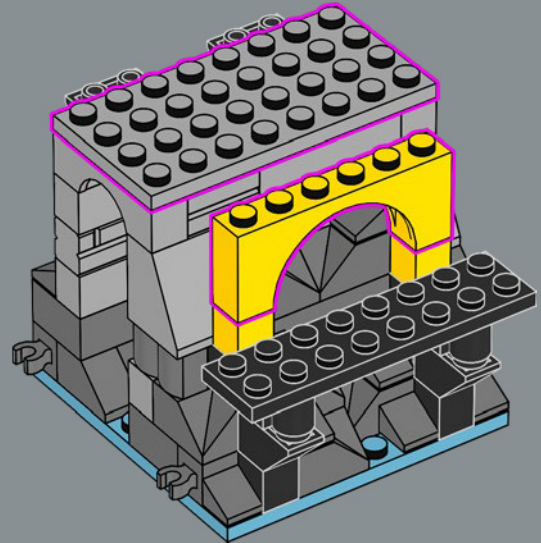

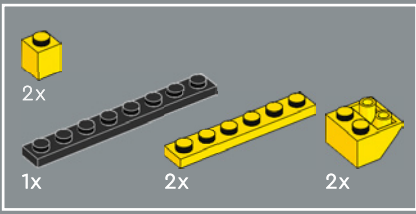

14

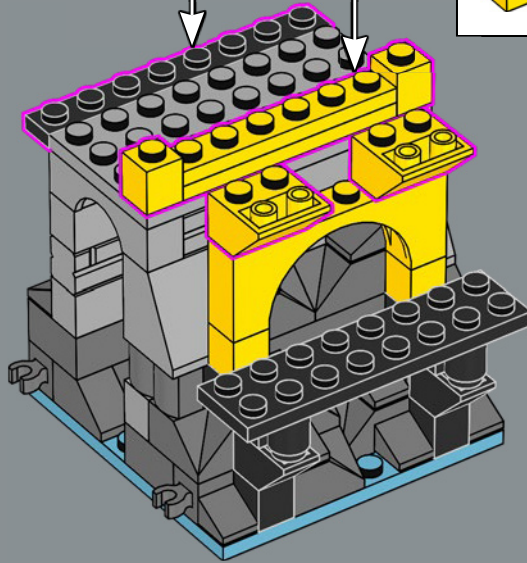
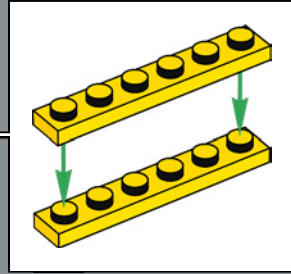
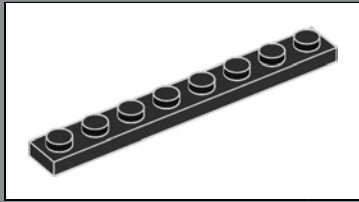

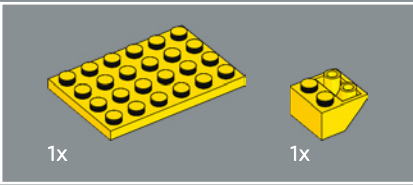
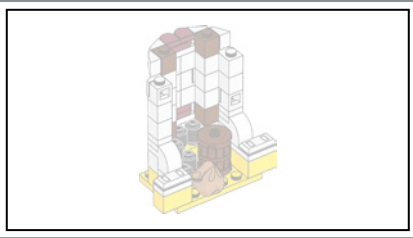

1x

1x

15

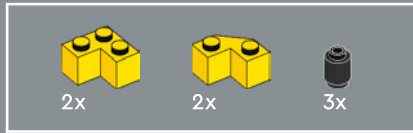
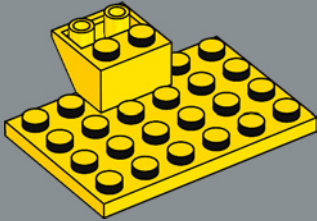

2x

2x

3x

16

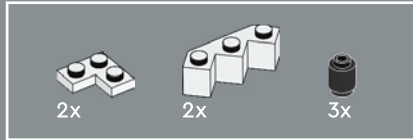
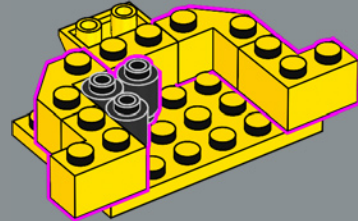

2x

2x

3x

17

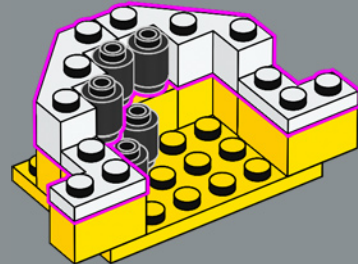

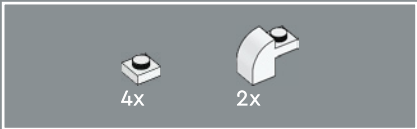

18

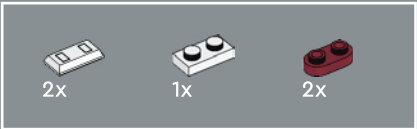
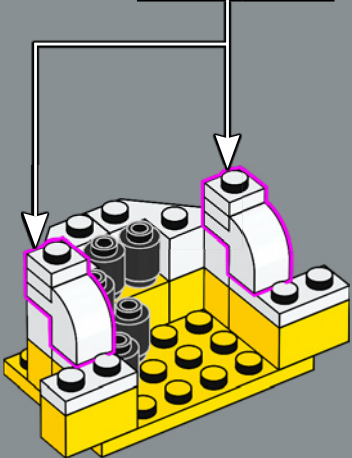
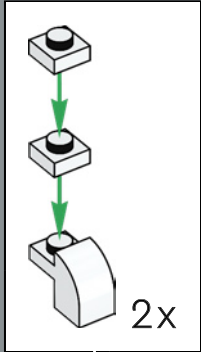

19

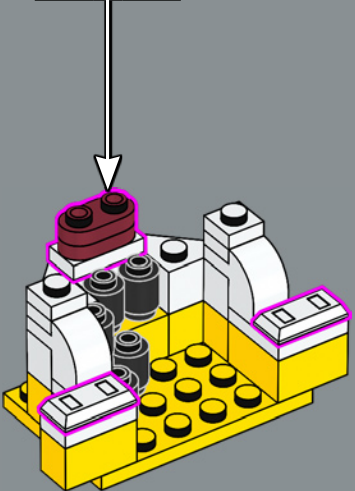
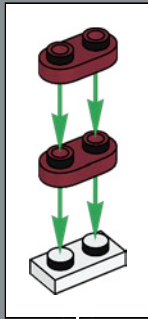

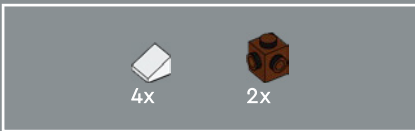

20

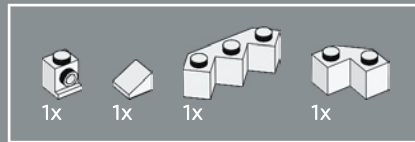
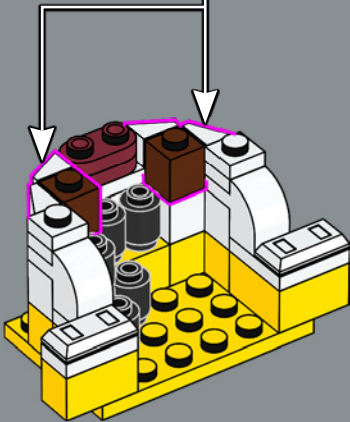
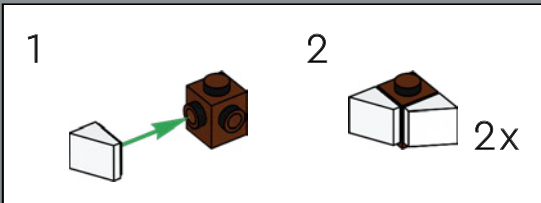

21

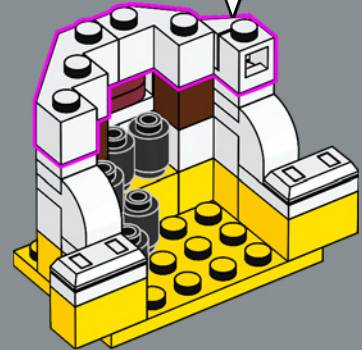
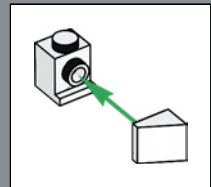

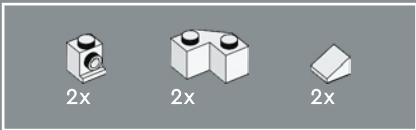

22

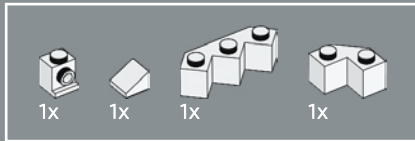
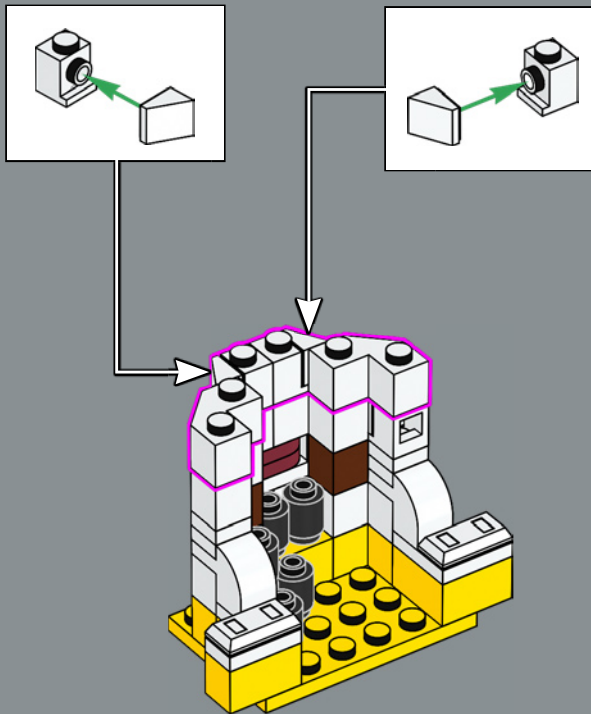

23

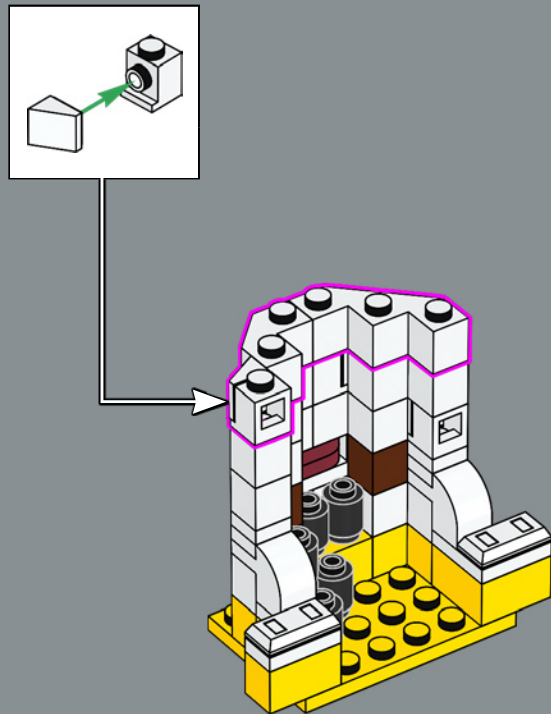



24

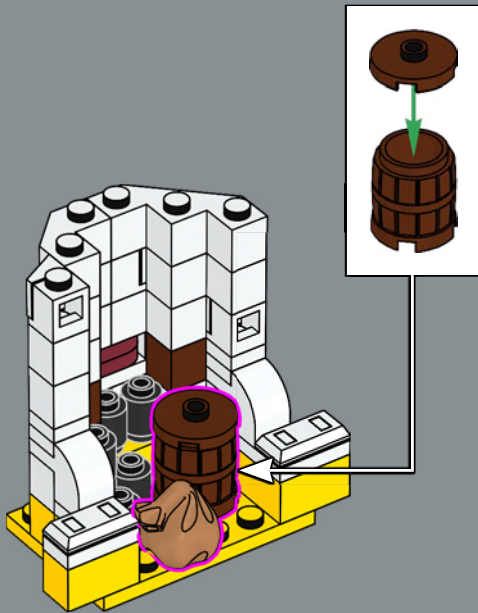

25

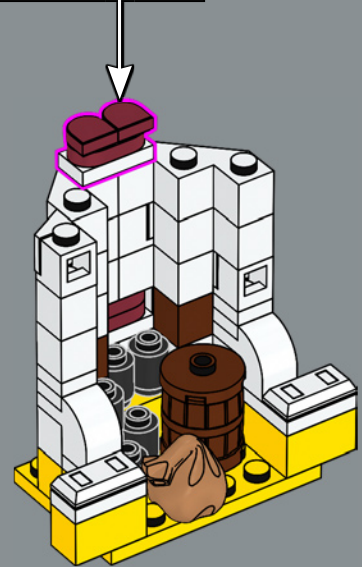
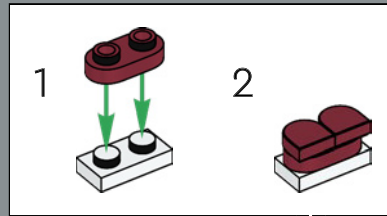



4x



2x

26

1



2



2x

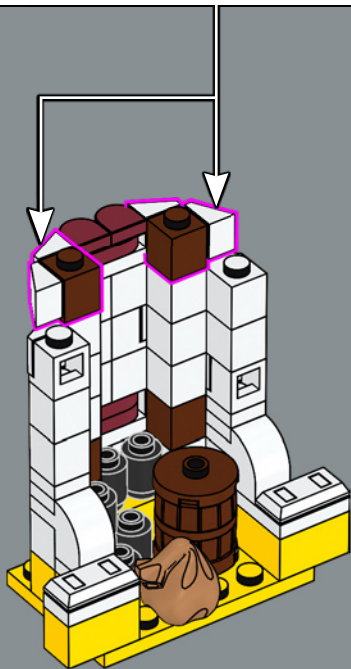

27

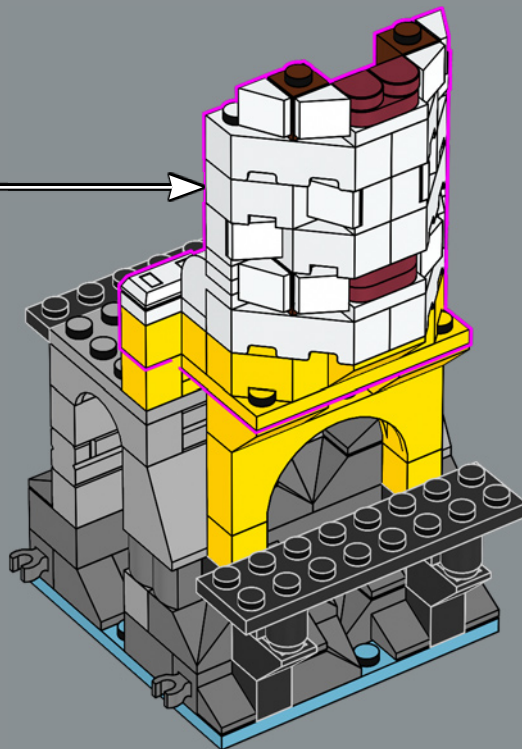

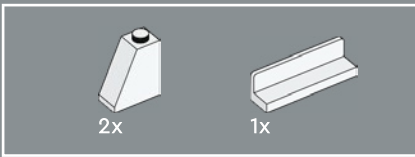

28

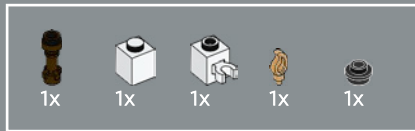
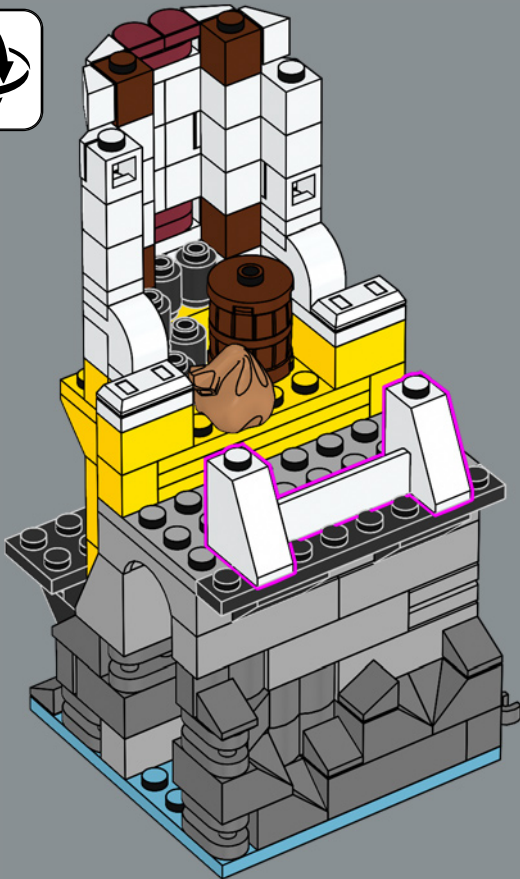

29

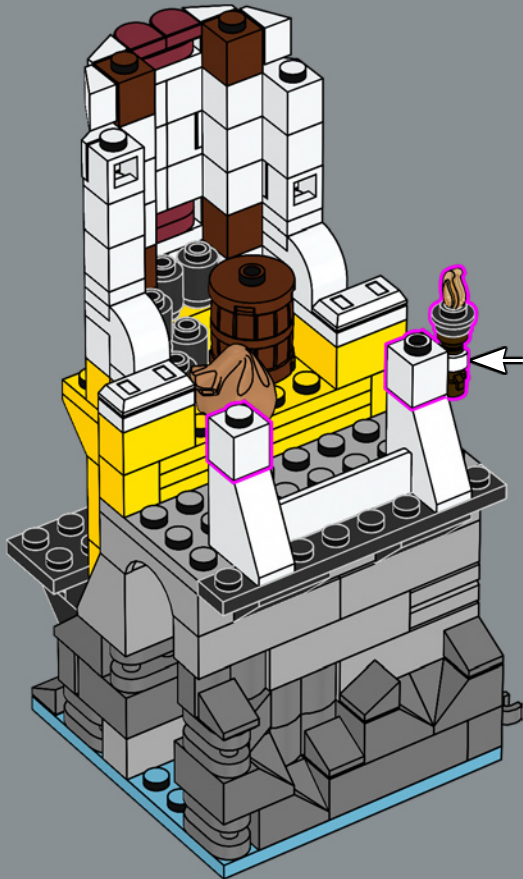



2x

30

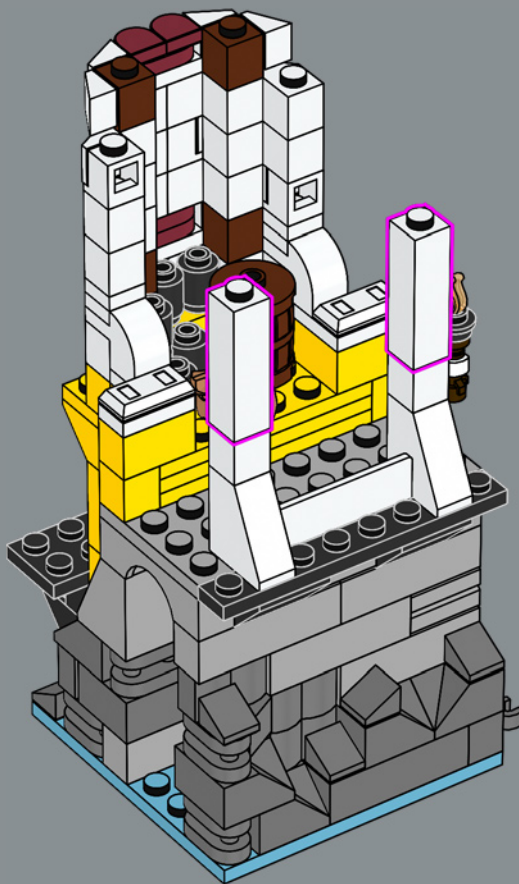

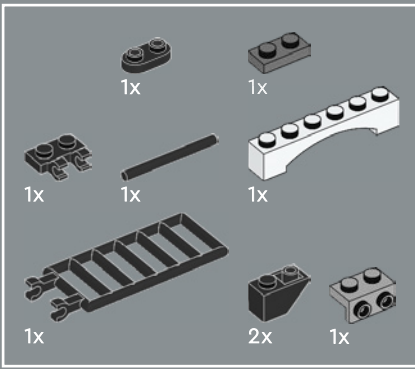

31

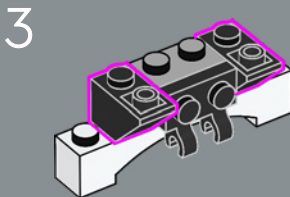
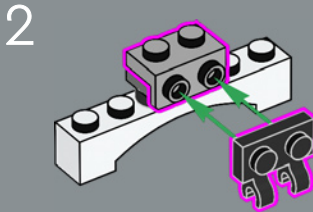
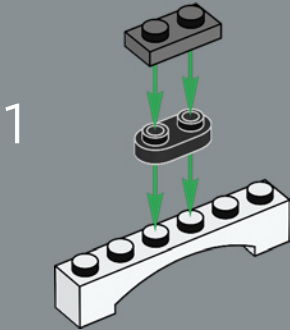

4

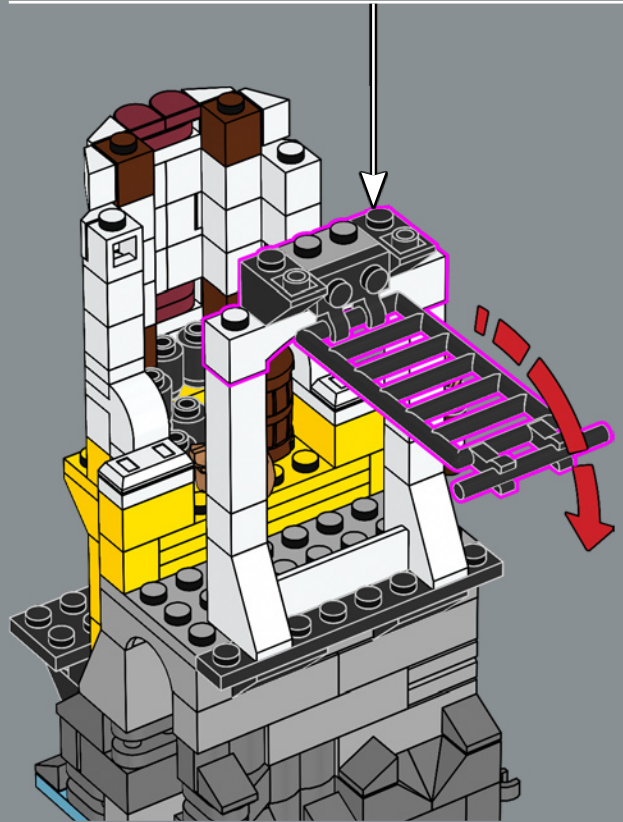
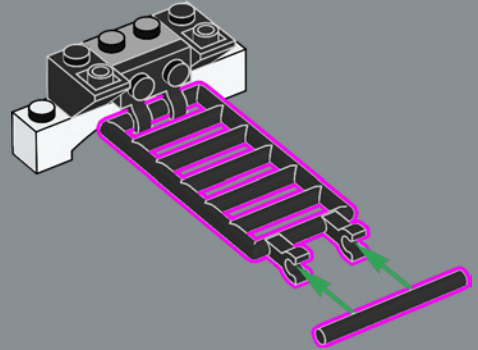

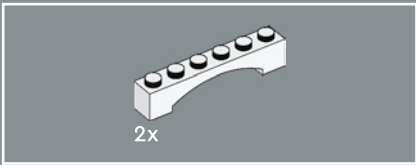

32

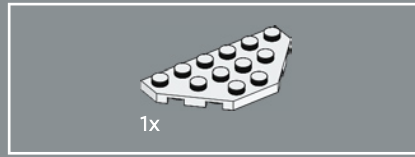
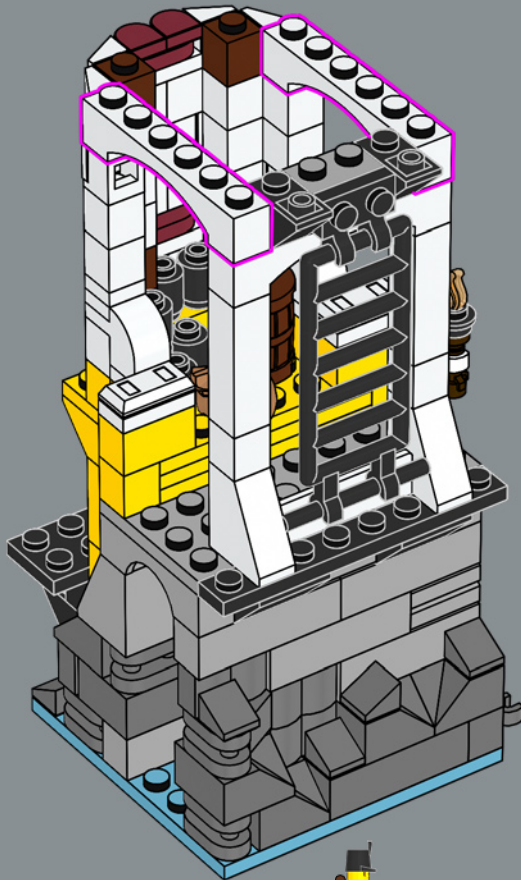

33

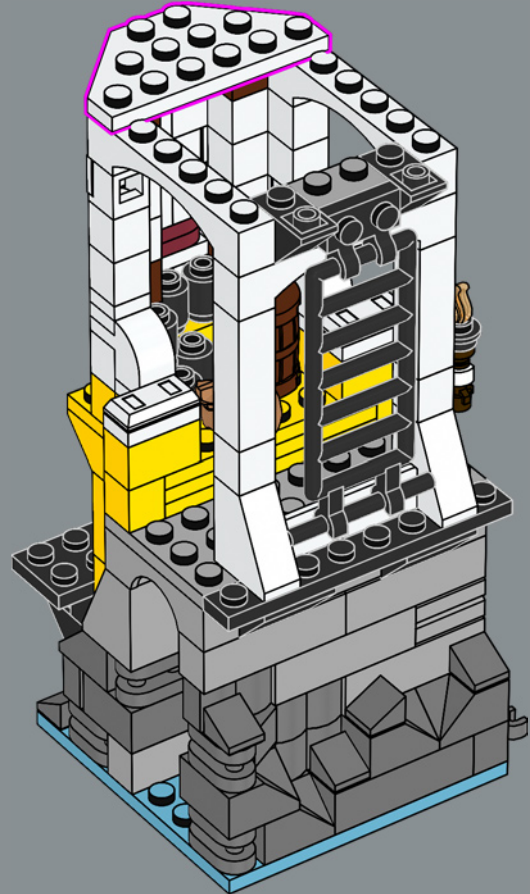

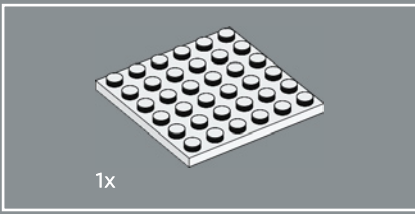

34

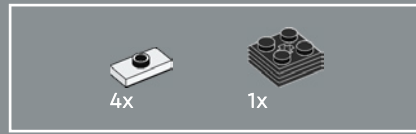
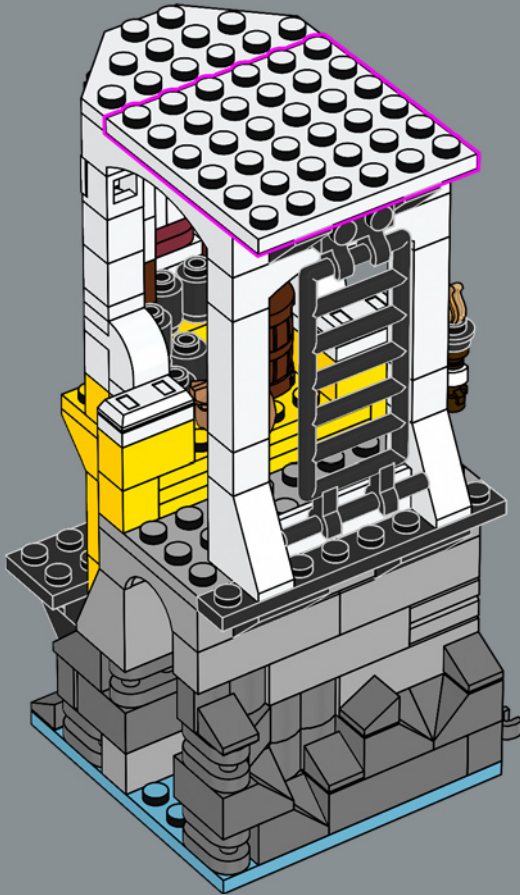

35

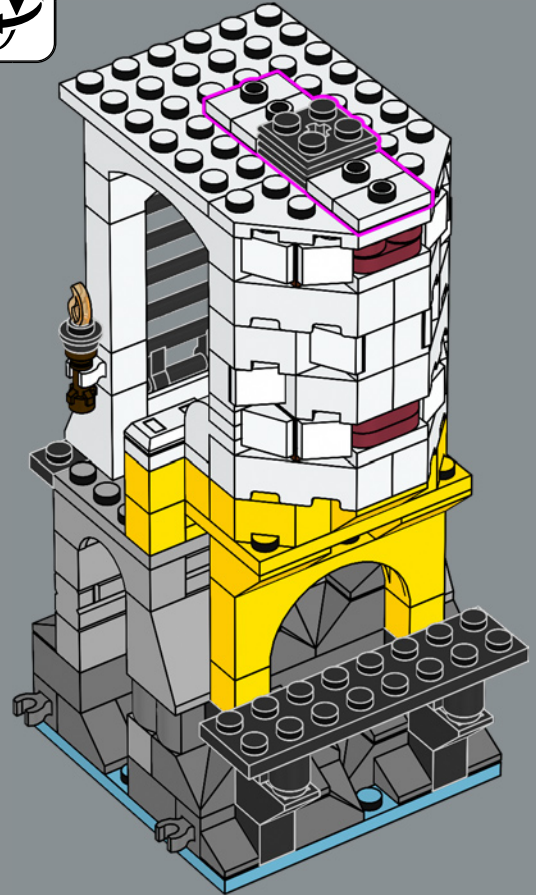

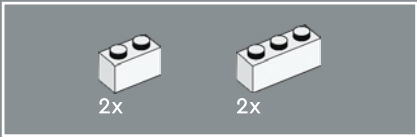

36

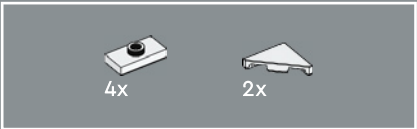
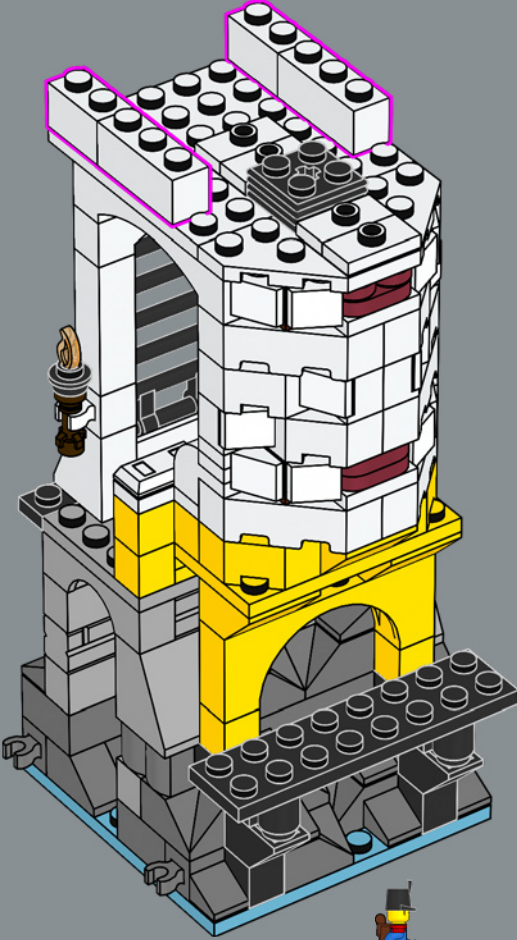

37

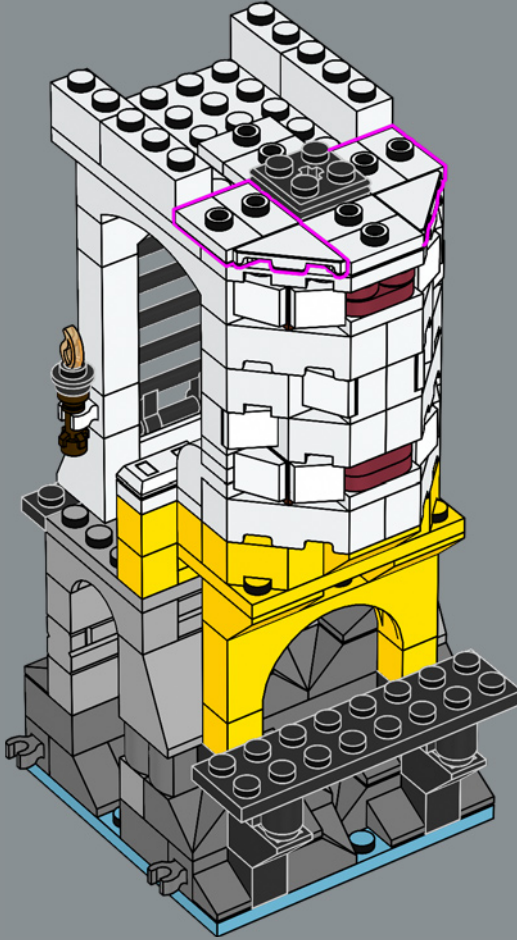

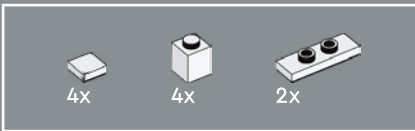

38

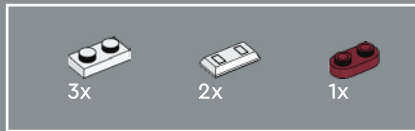
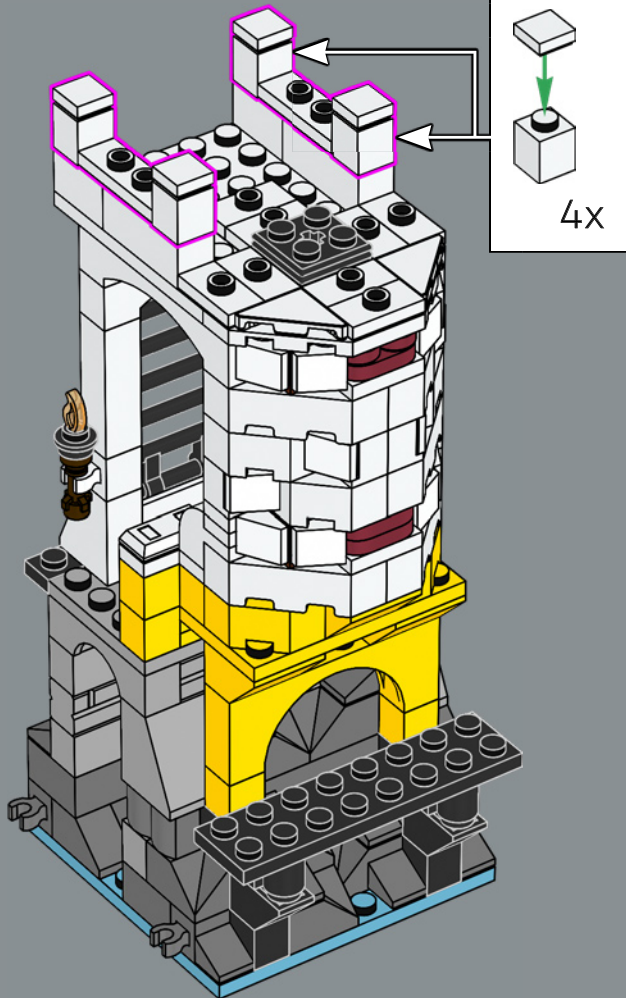

39

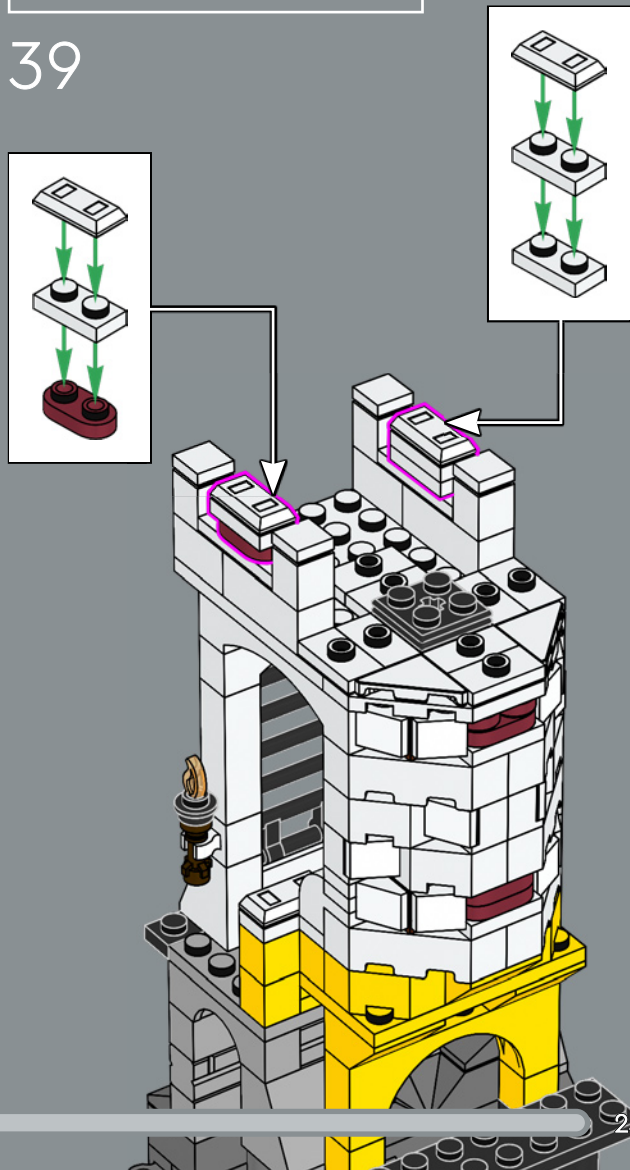

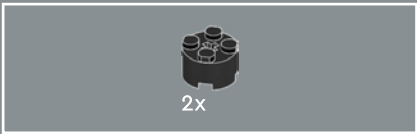

40

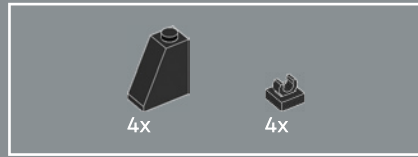
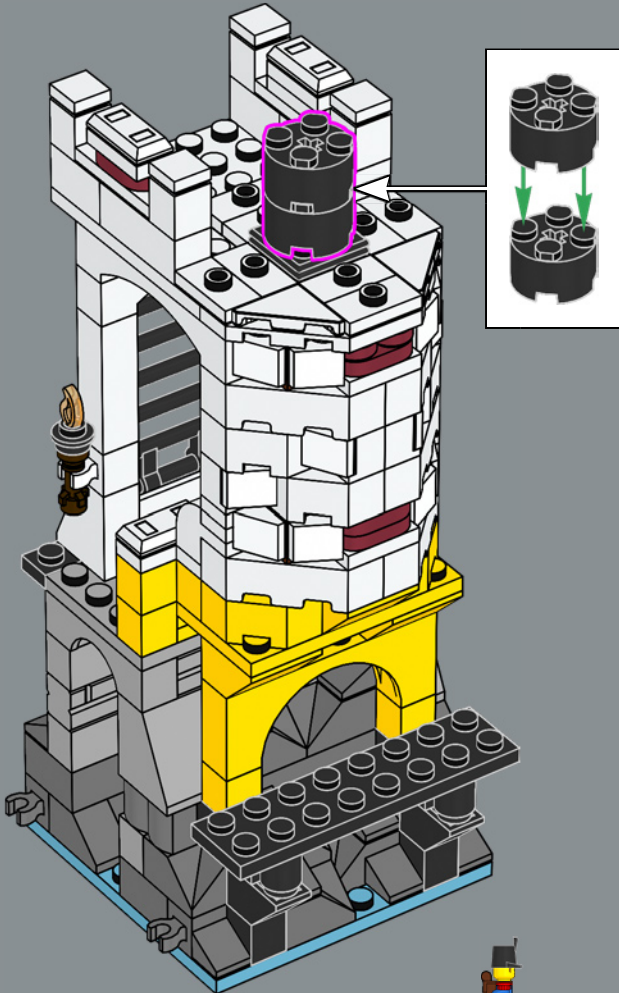

41

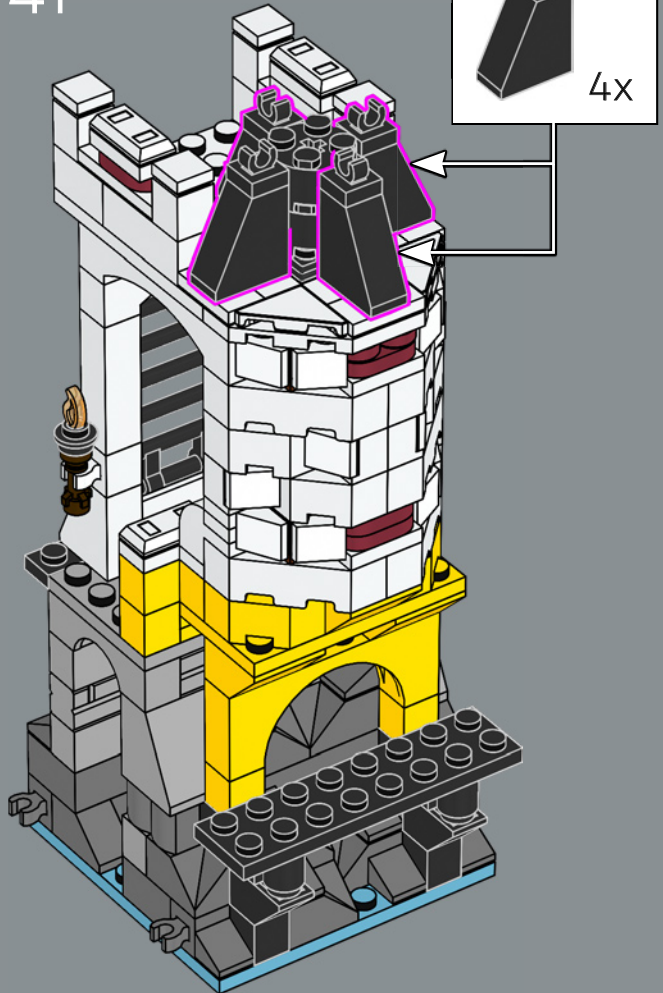



42

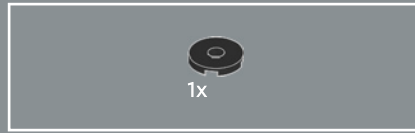
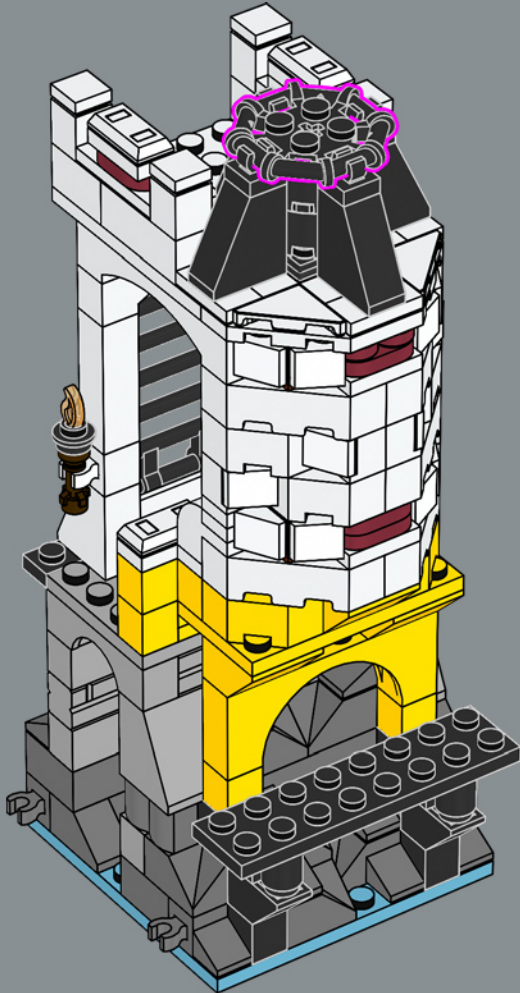

43

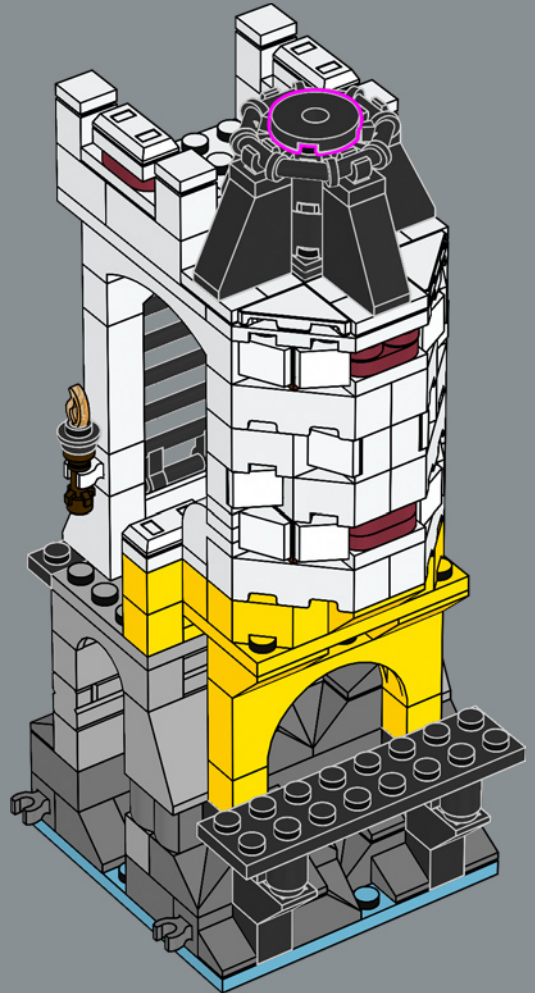

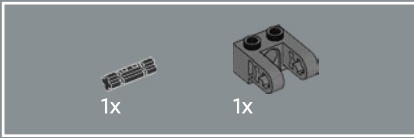
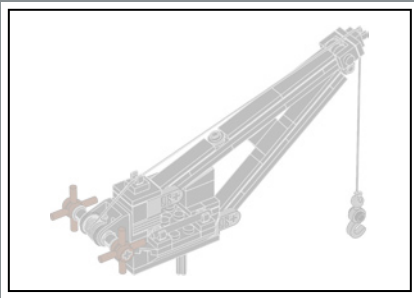

44

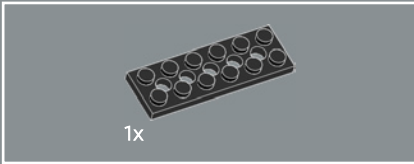
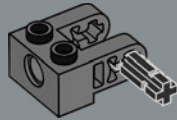

45

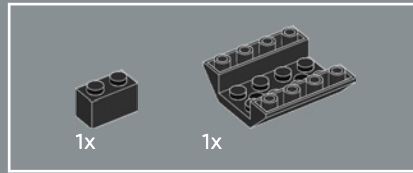
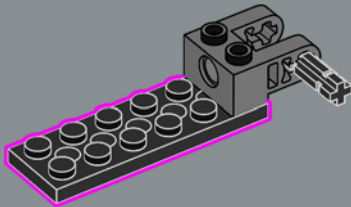

46

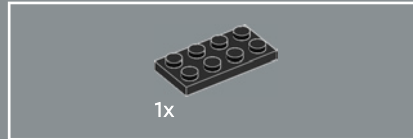
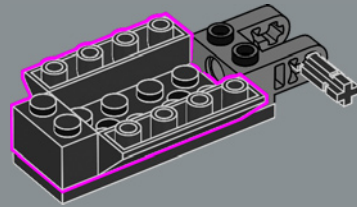

47

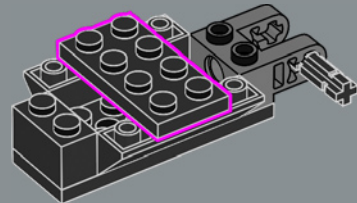

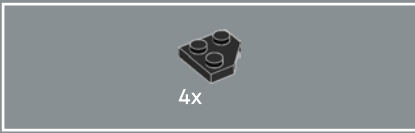

48

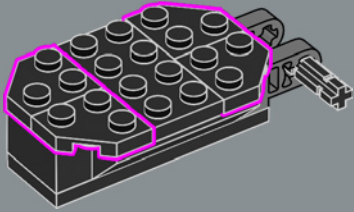

50

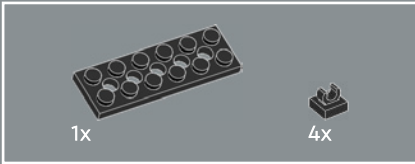
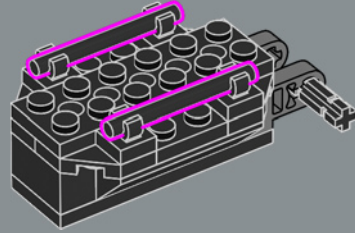

49

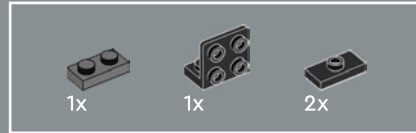
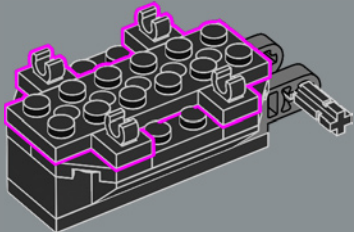

51

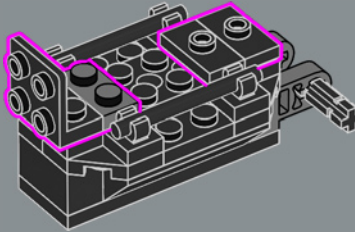

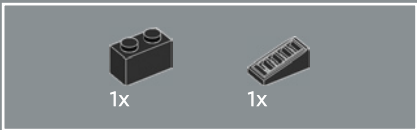

52

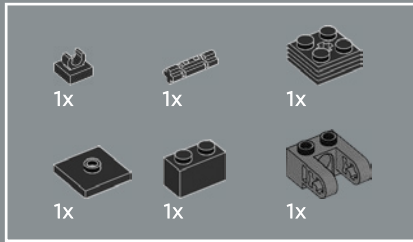
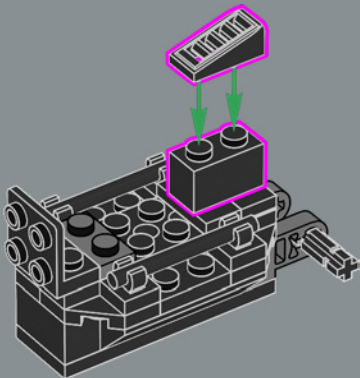

53

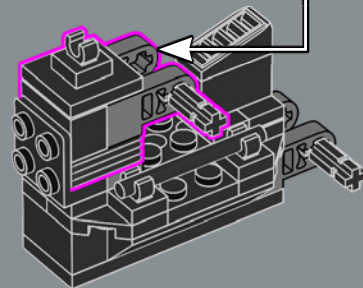
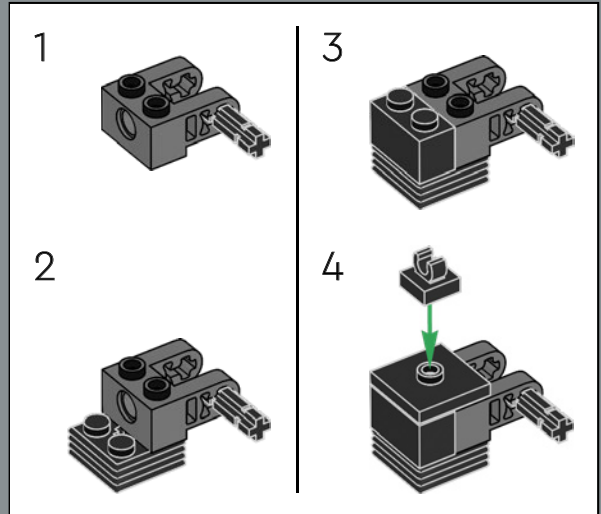

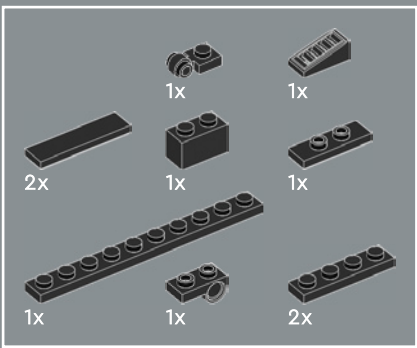

54

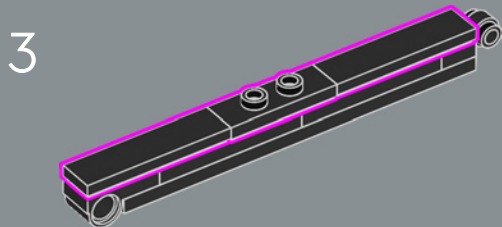
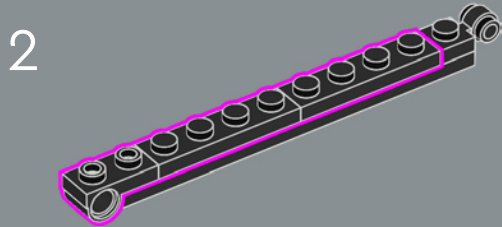
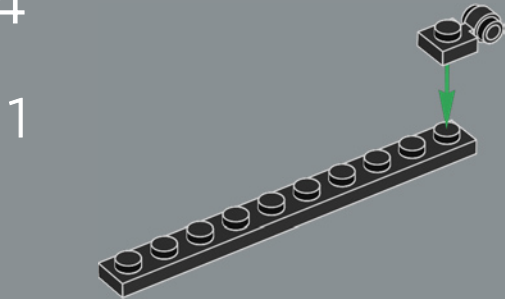

4

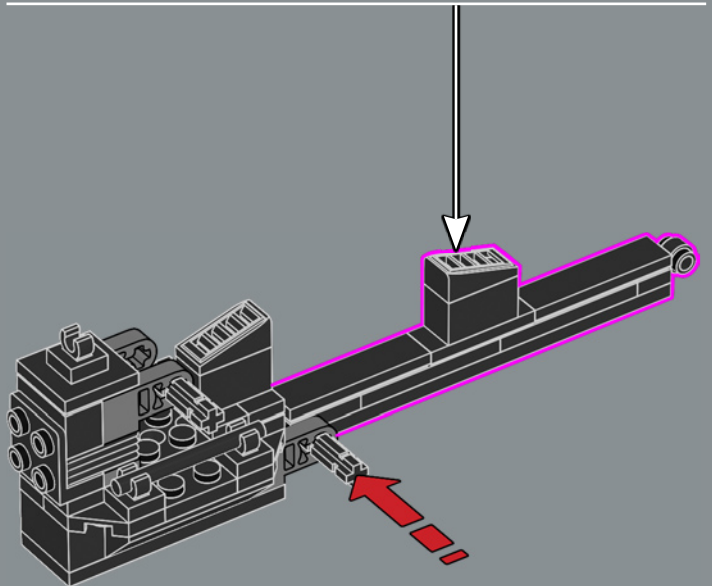
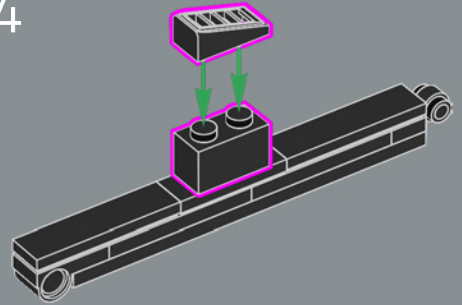

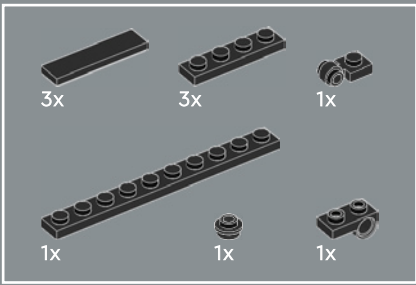

55

1

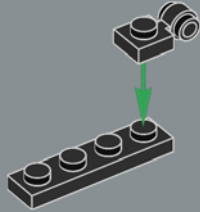

2

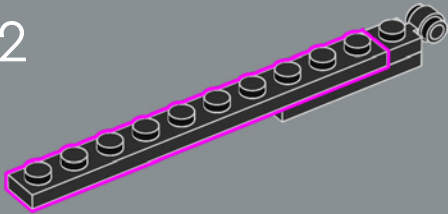

3

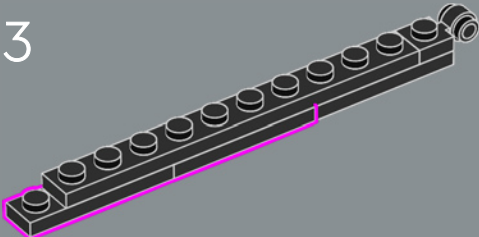

4

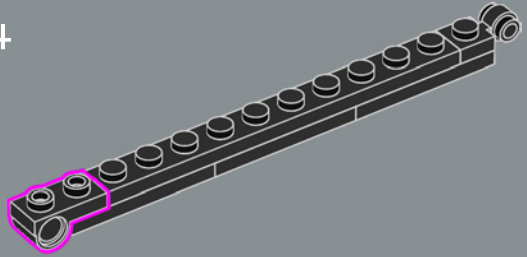

5

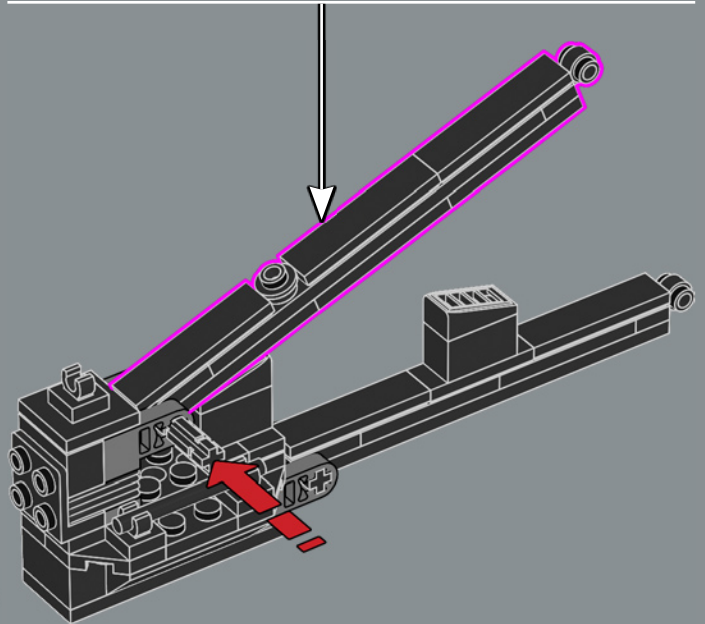
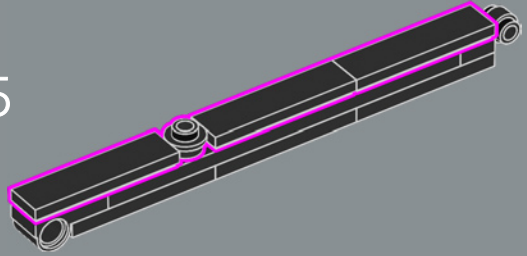



56

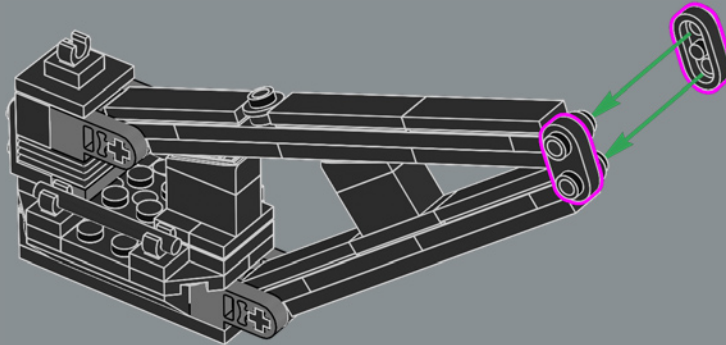

57

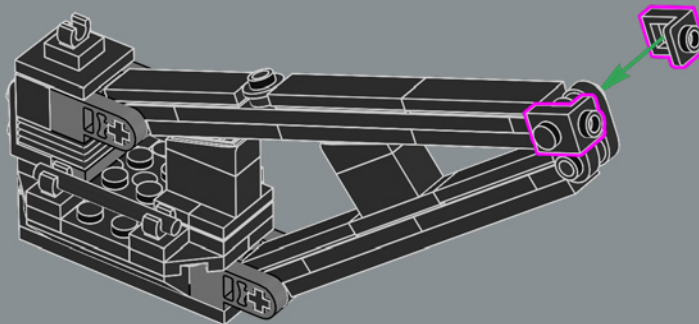

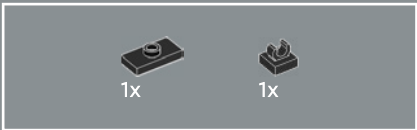

58

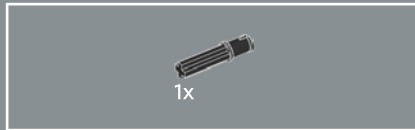
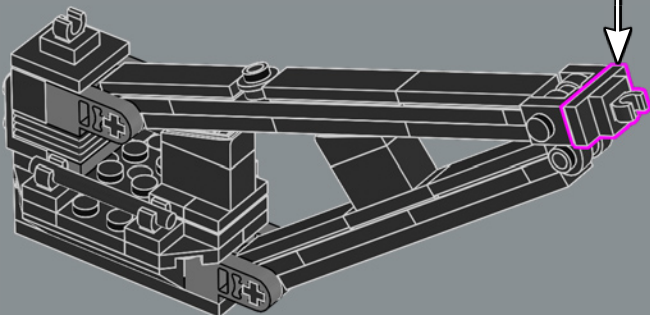
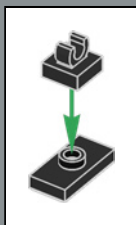

59

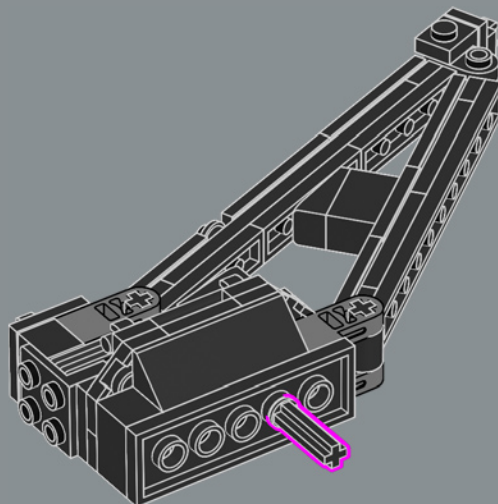

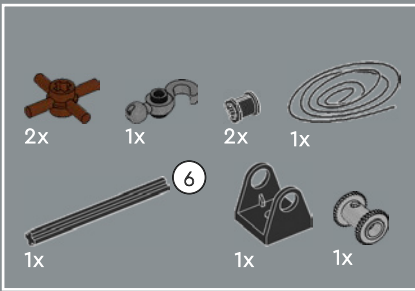

60

1

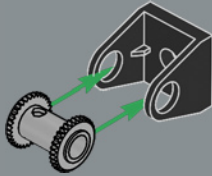

2

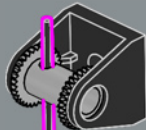

3

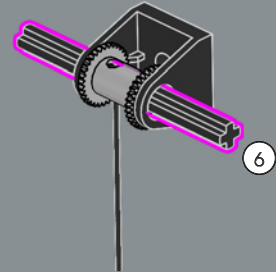

4

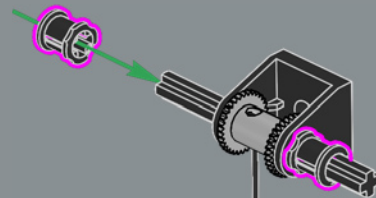

5

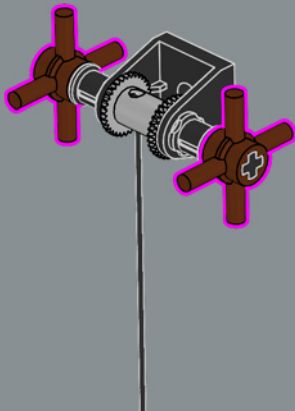

6

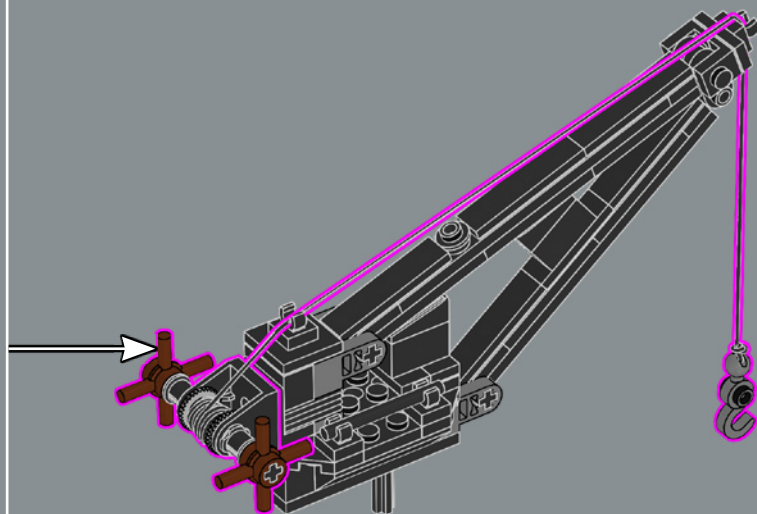
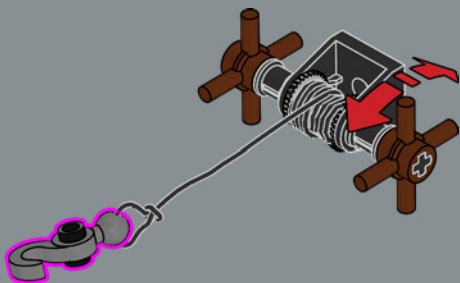



61

A larger crane means the governor and his crew can handle even heavier cargo.

Une grue plus grande signifie que le gouverneur et son équipage peuvent manipuler des cargaisons encore plus lourdes.

Con una grúa de mayor tamaño, el gobernador y su gente pueden levantar y mover cargas aún más pesadas.

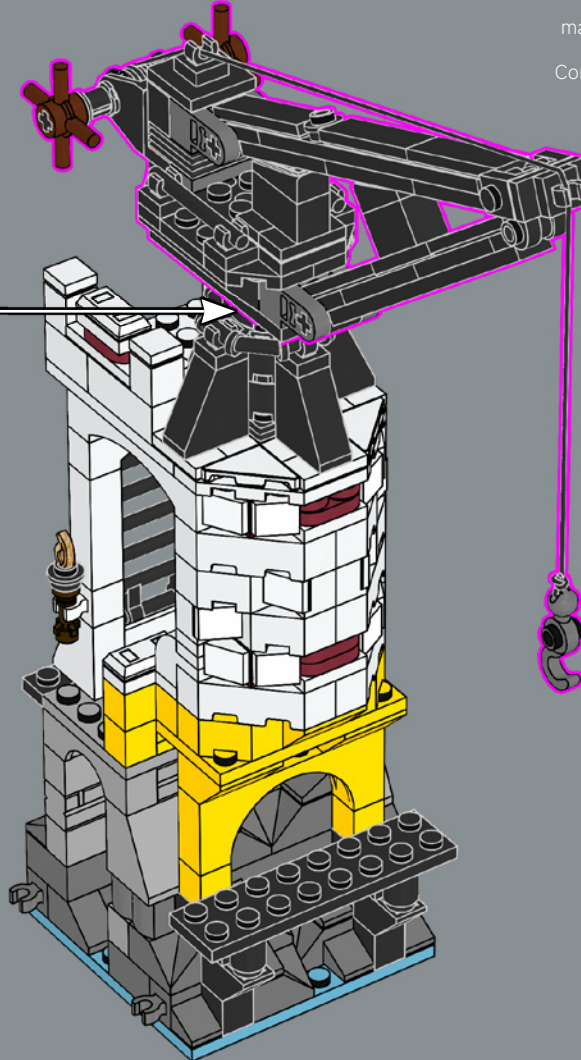

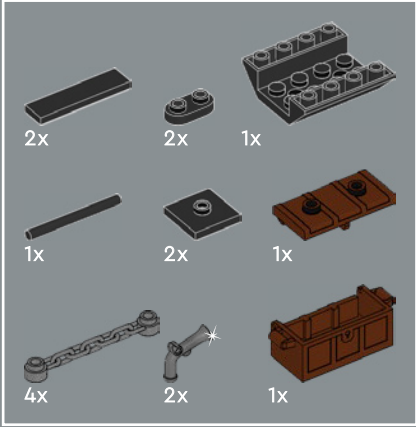
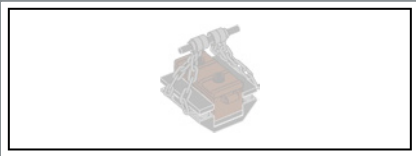

62

1

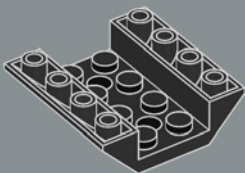

2

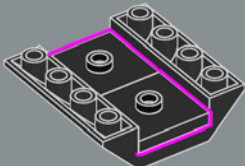

3

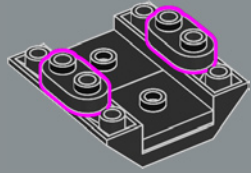

4

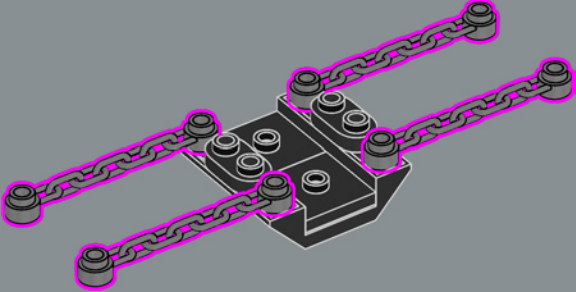

5

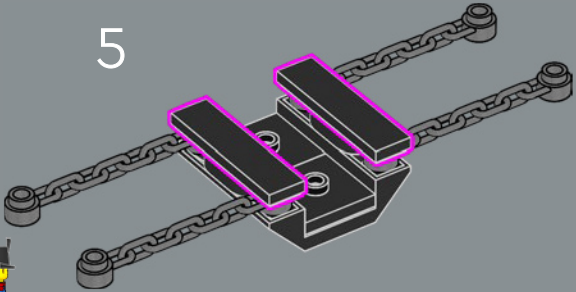

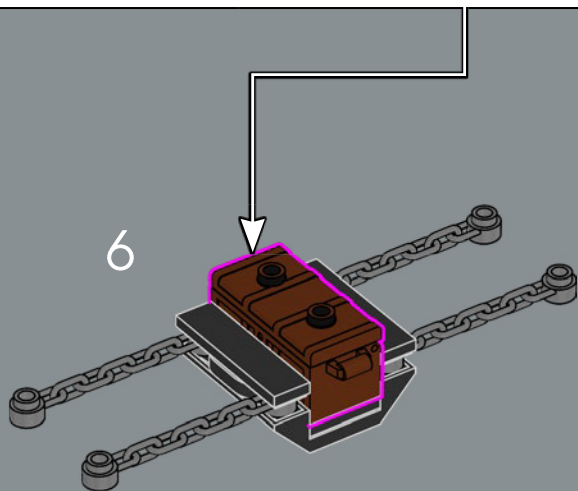
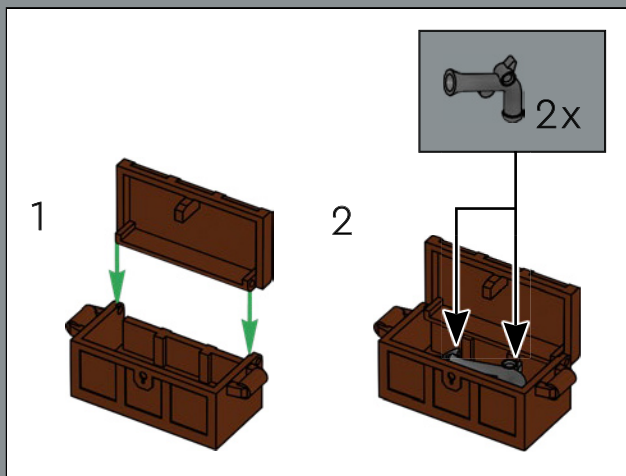

7

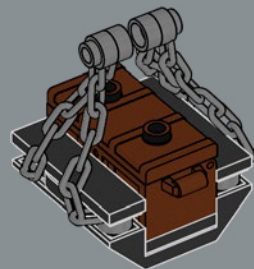

8

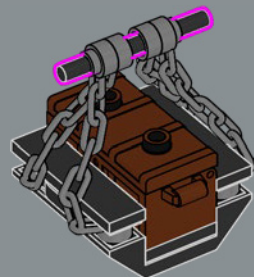

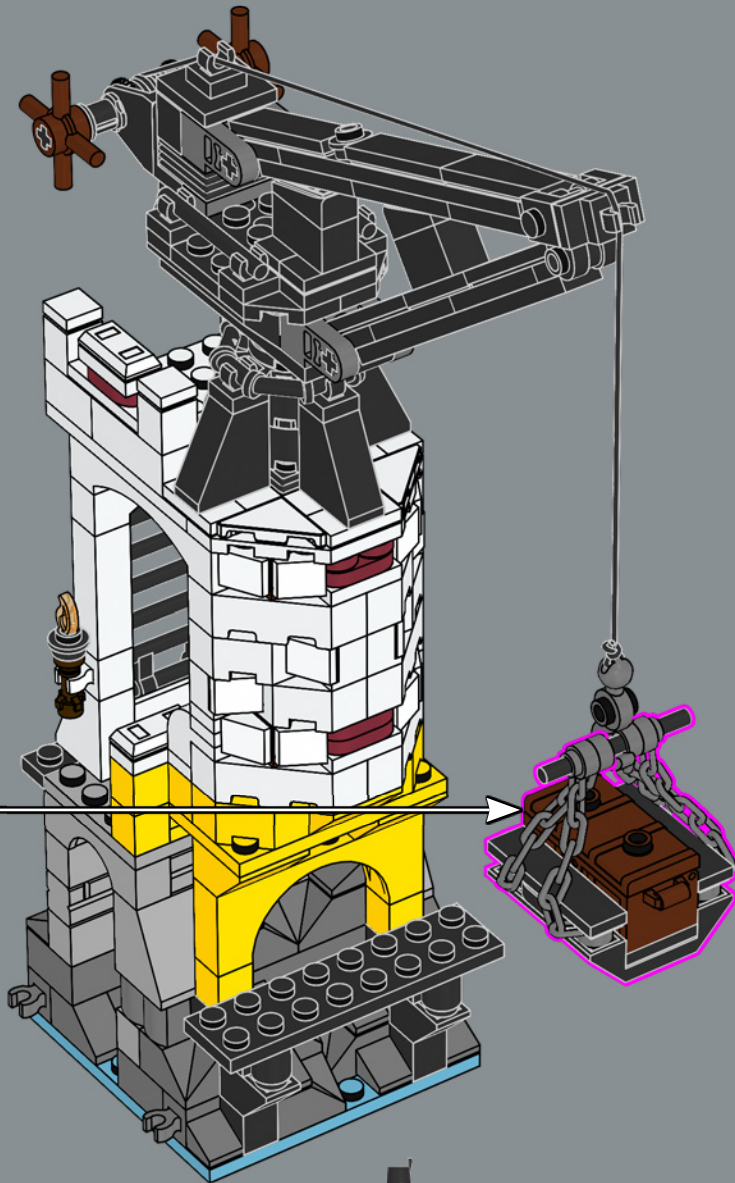

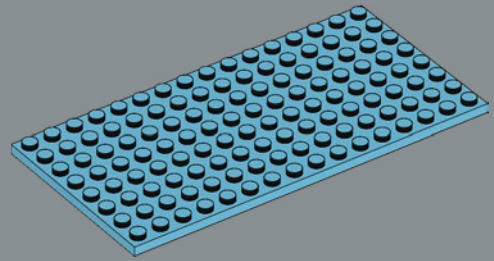
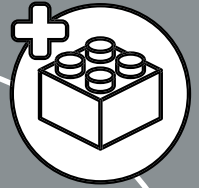

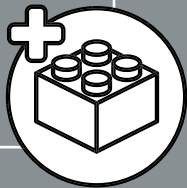
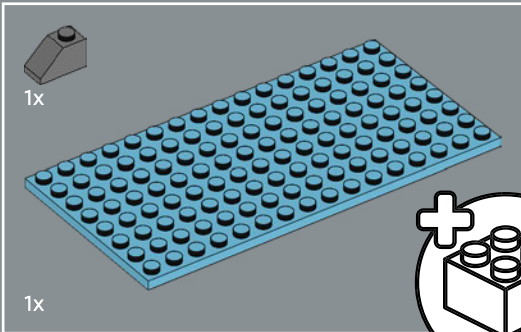
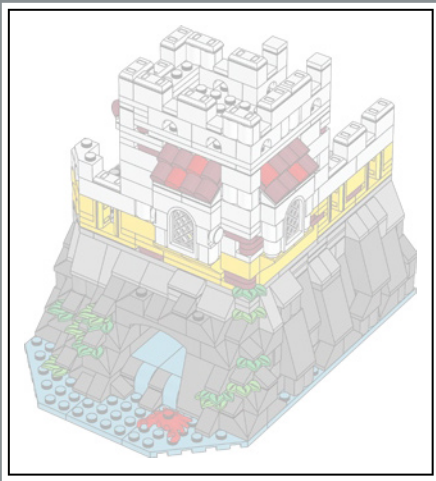

1

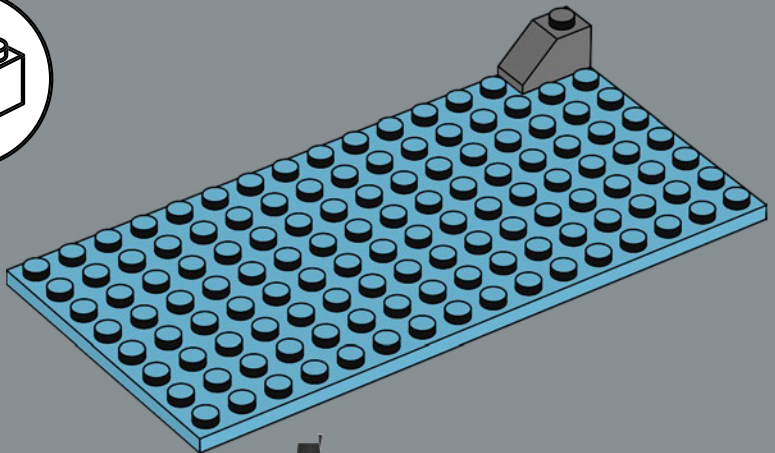

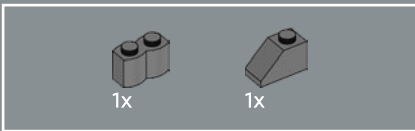

2

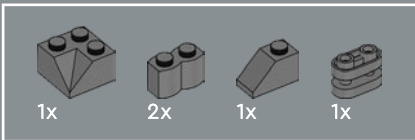
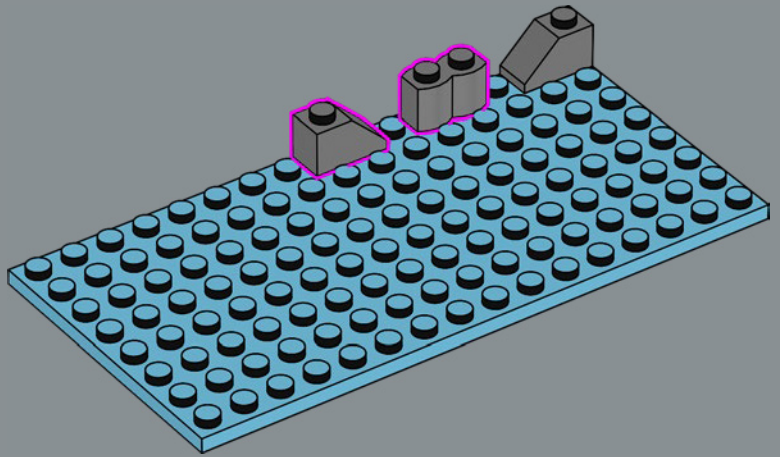

3

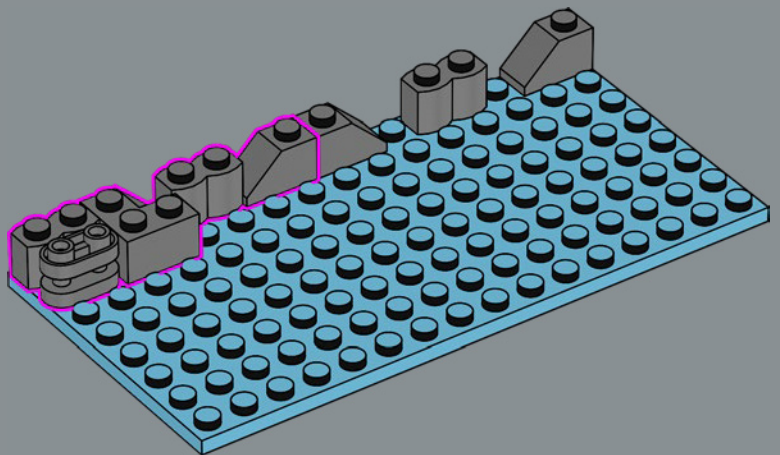

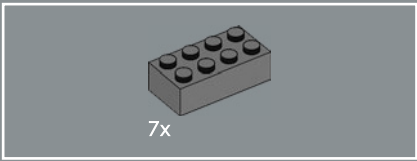

4

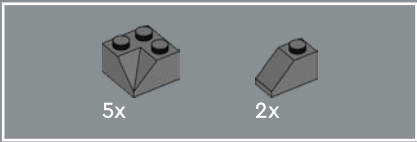
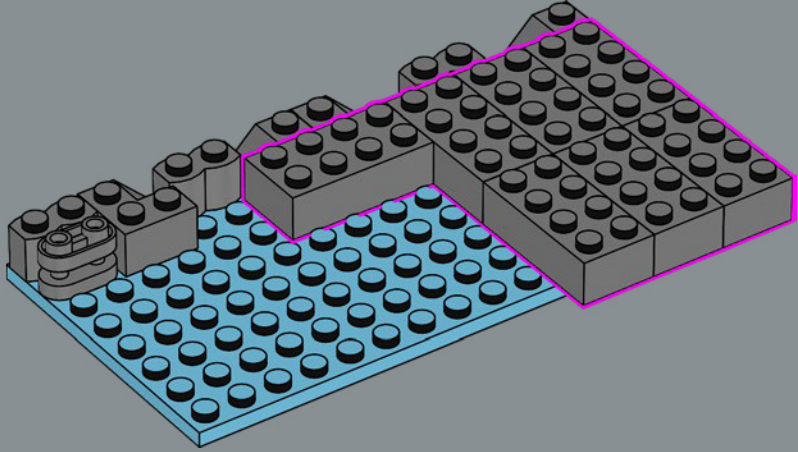

5

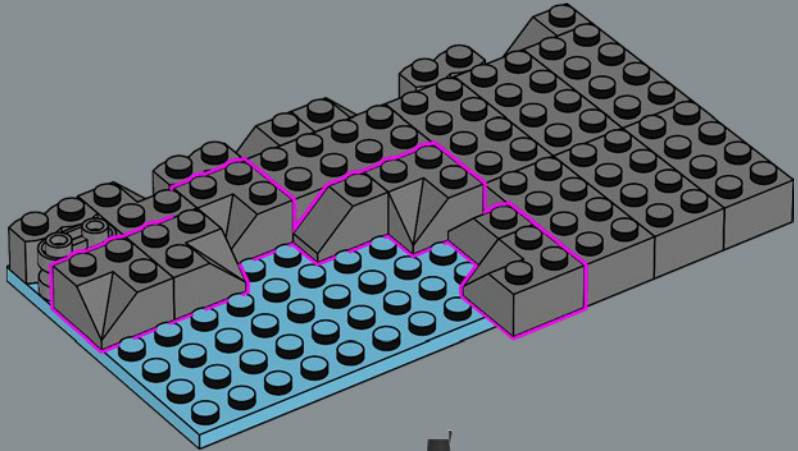

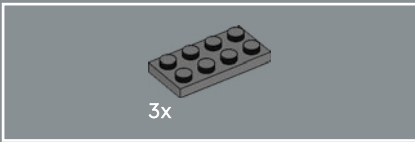

6

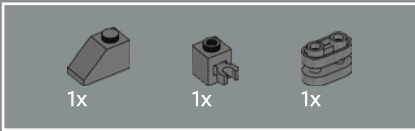
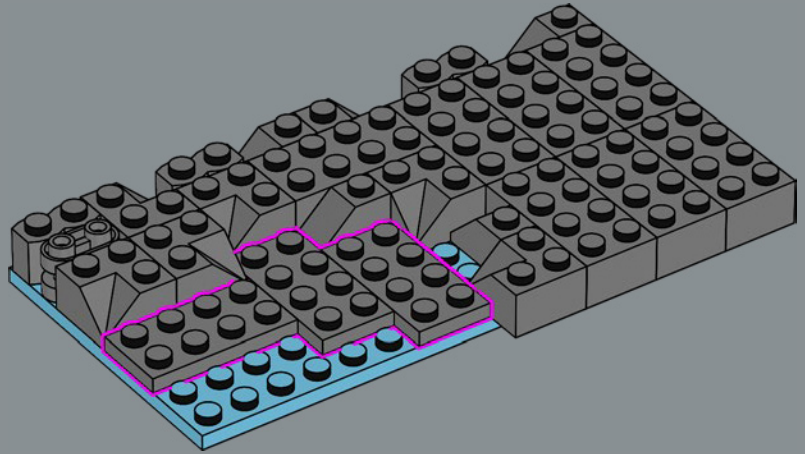

7

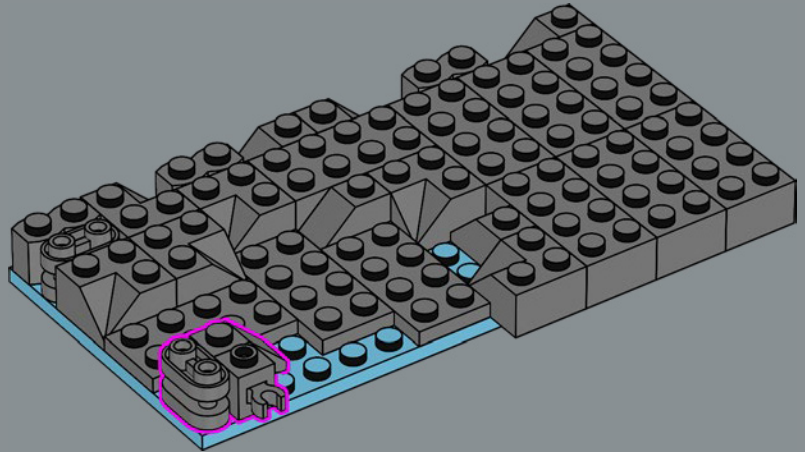

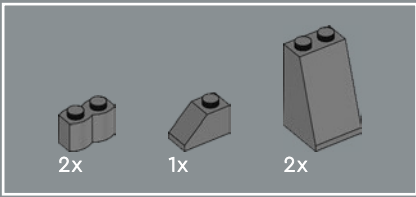

8

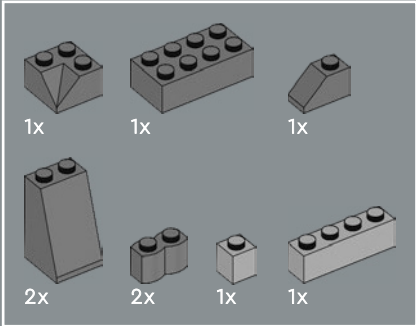
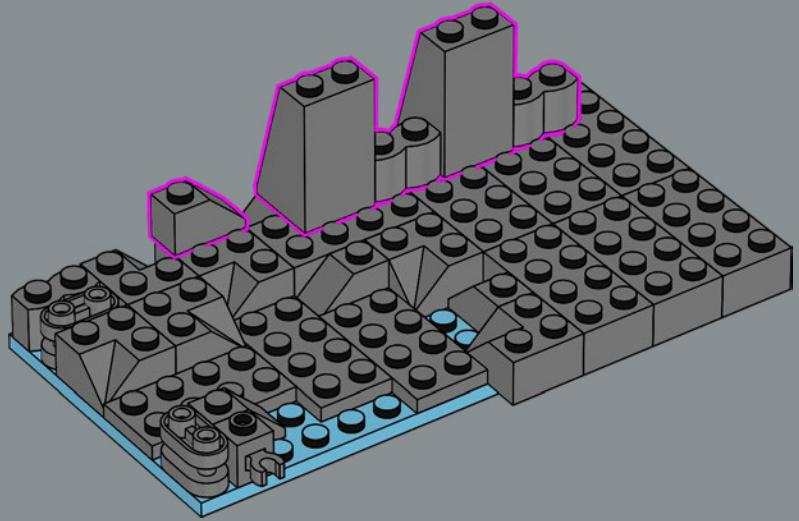

9

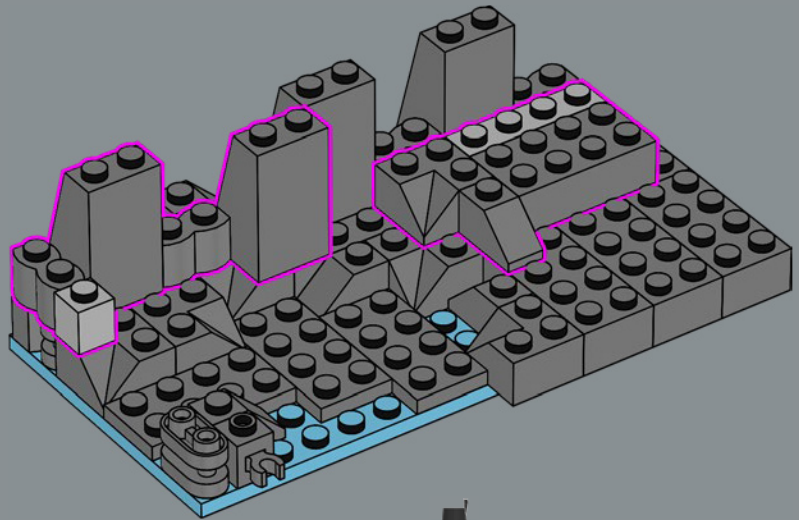

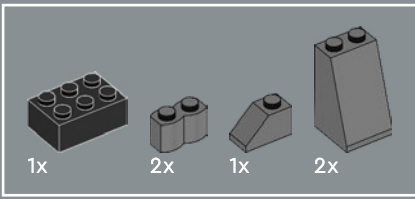

10

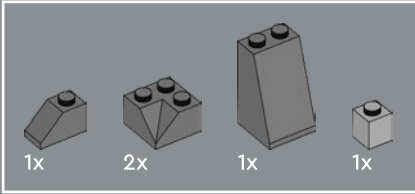
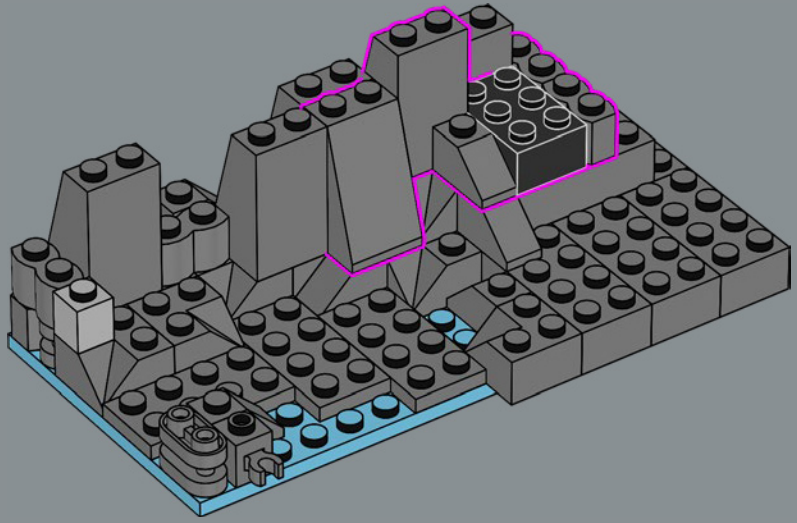

11

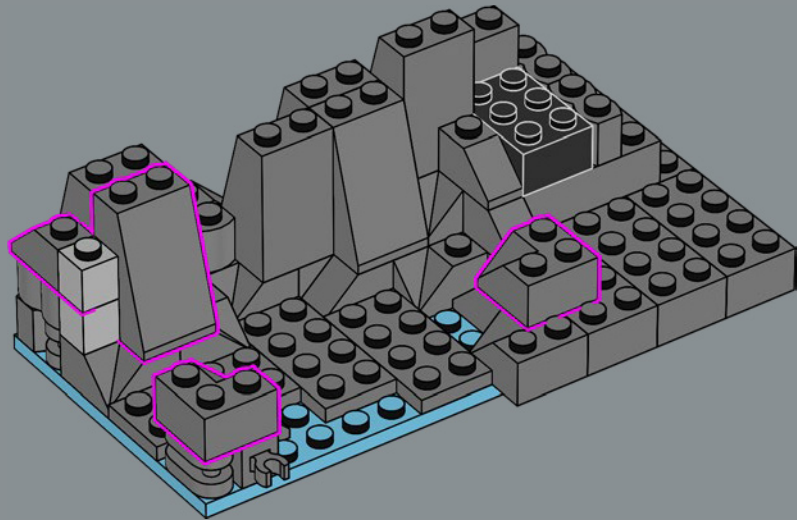

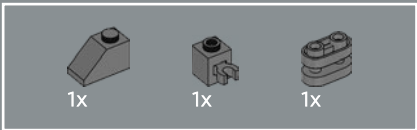

12

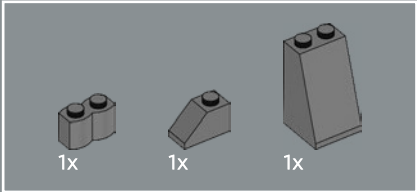
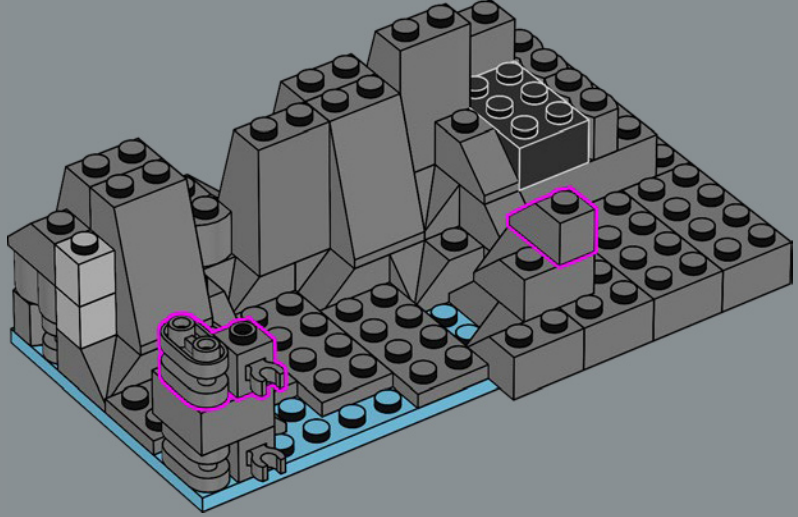

13

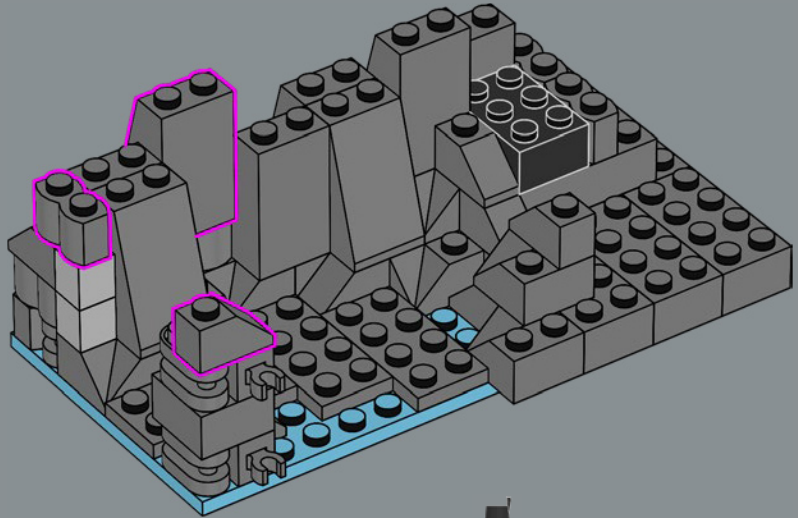

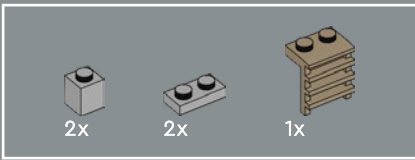

14

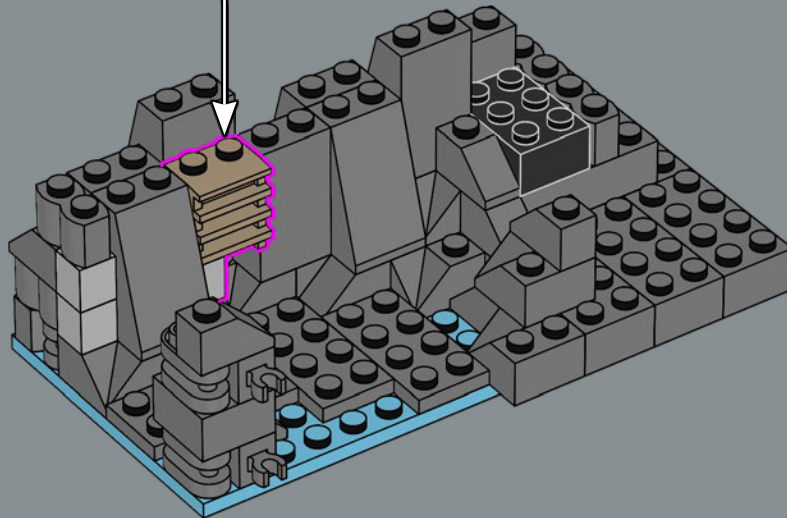
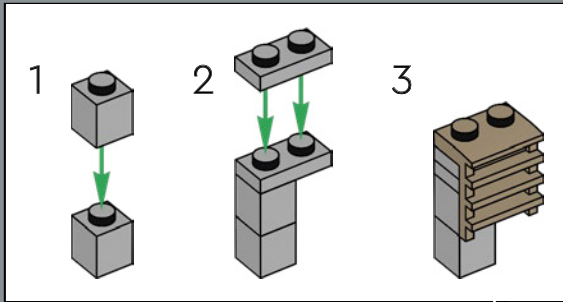

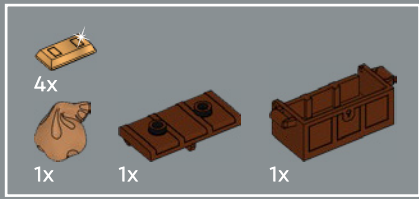

15

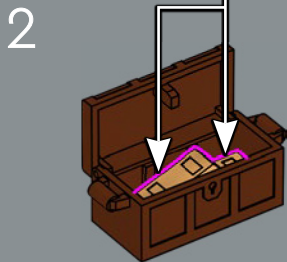
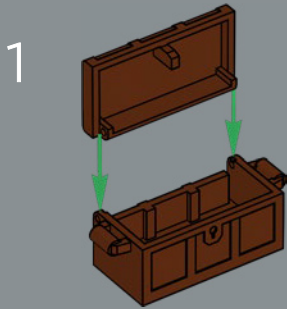

3

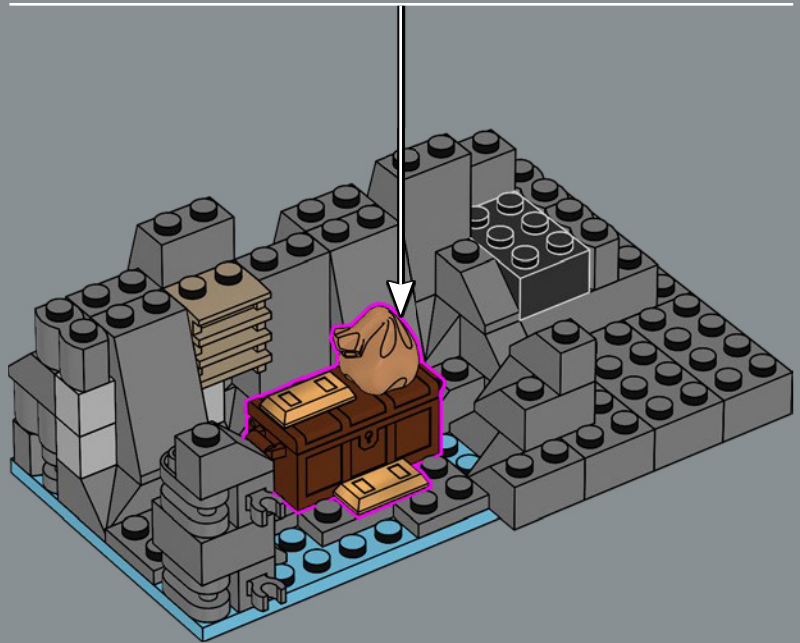

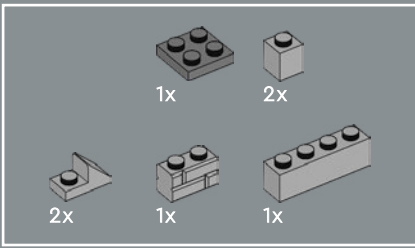

16

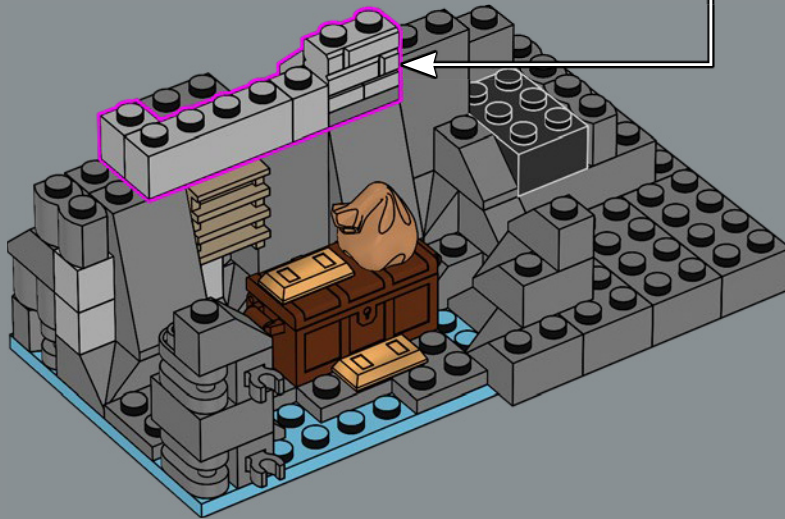
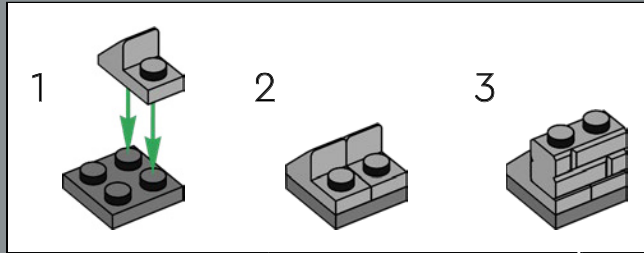

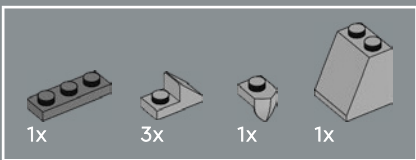

17

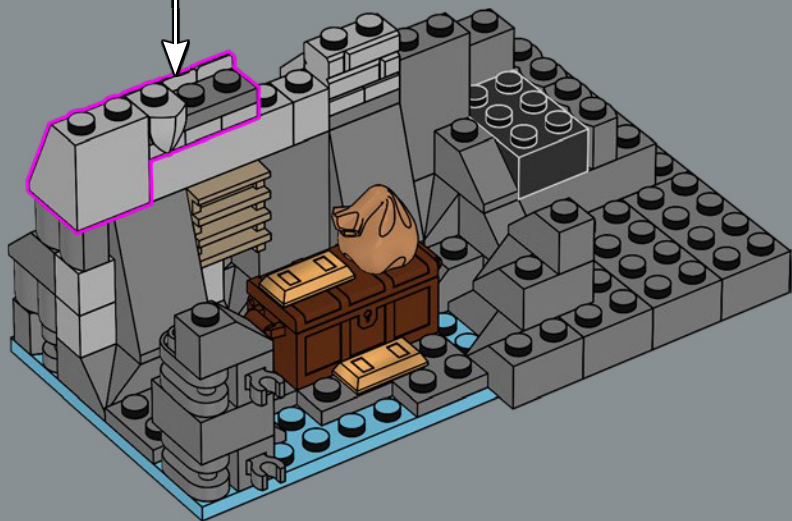
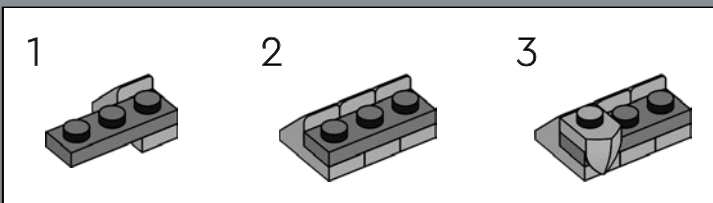

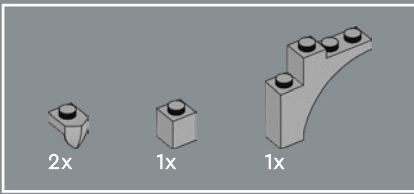

18

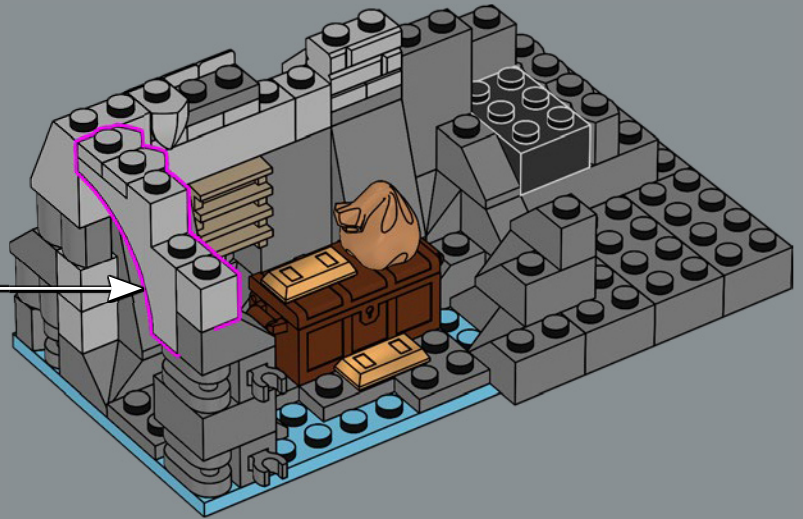
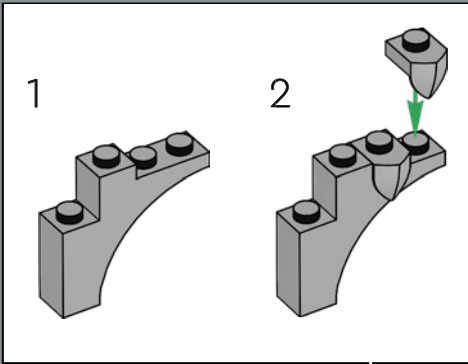

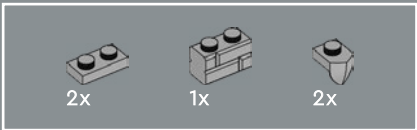

19

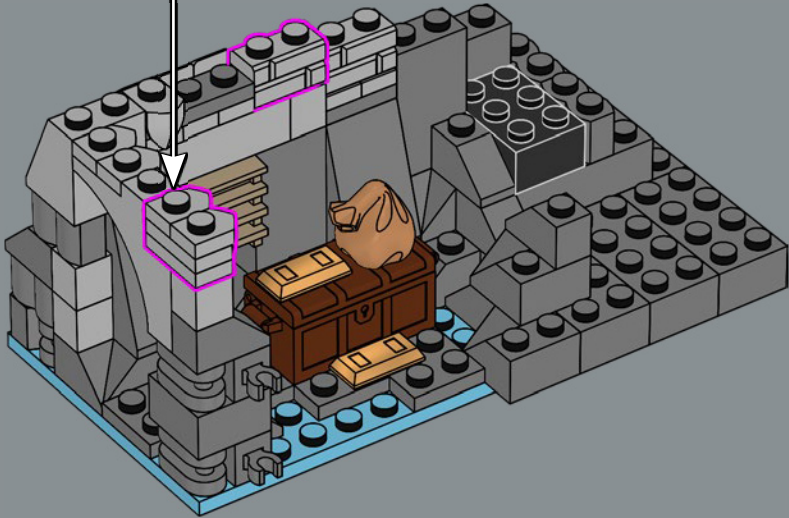
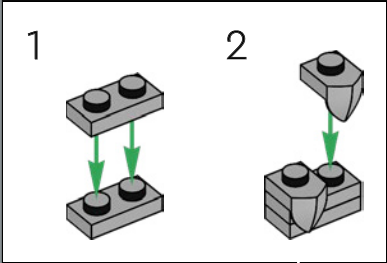

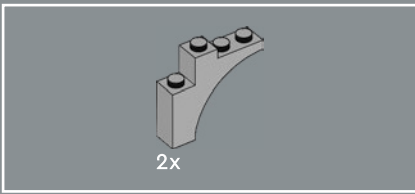

20

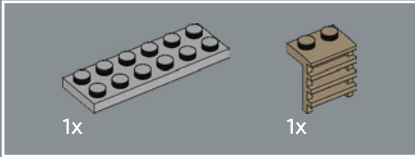
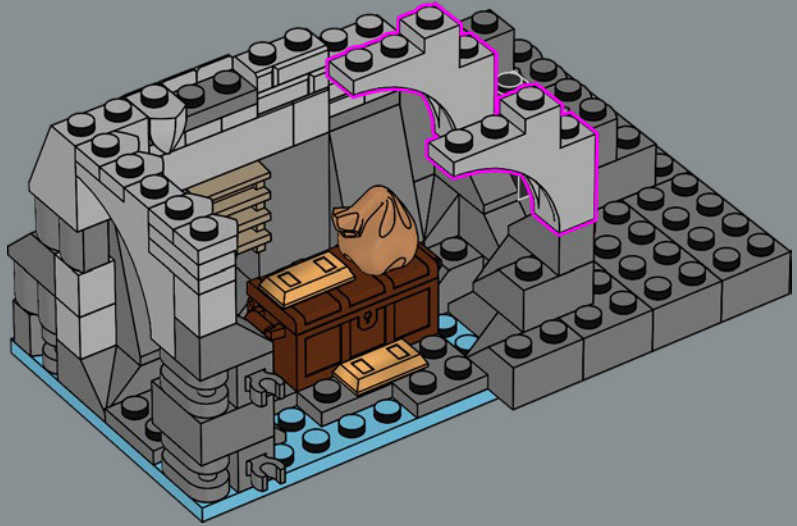

21

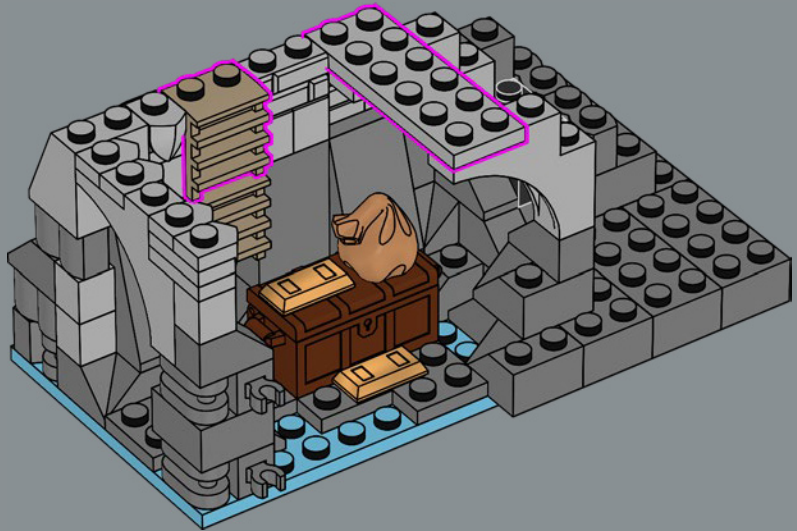

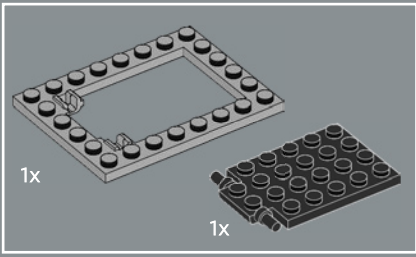

22

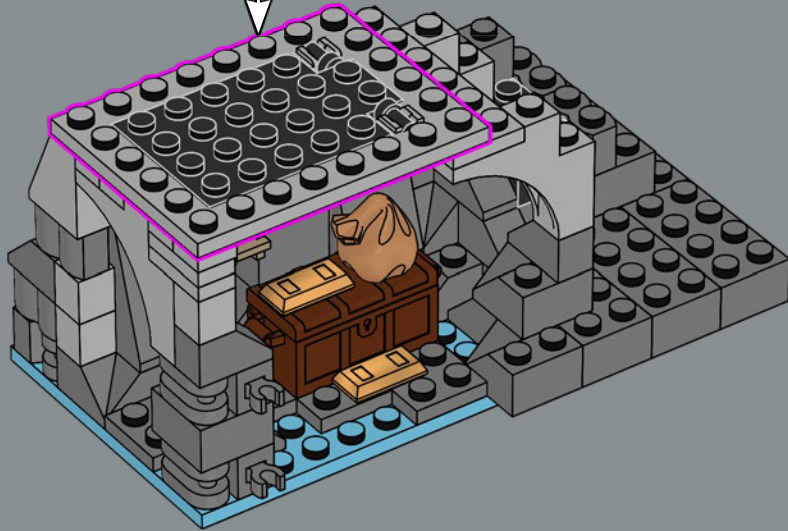
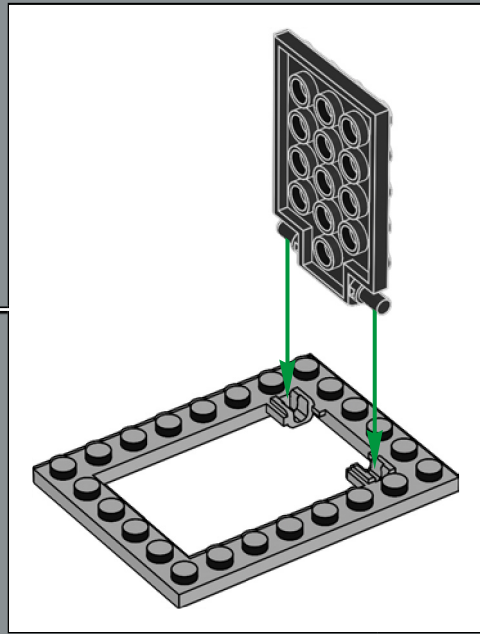

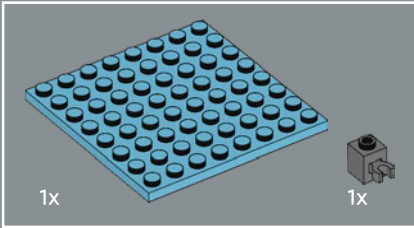
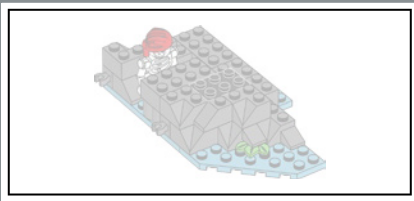

23

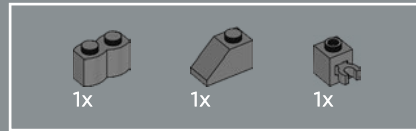
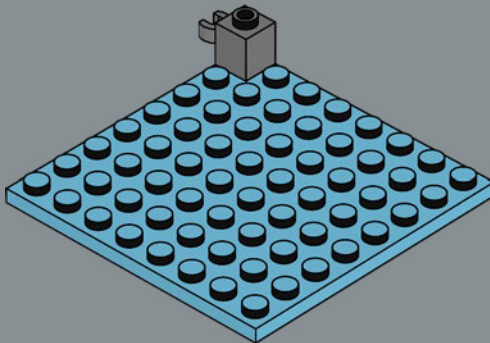

24

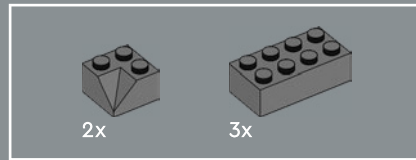
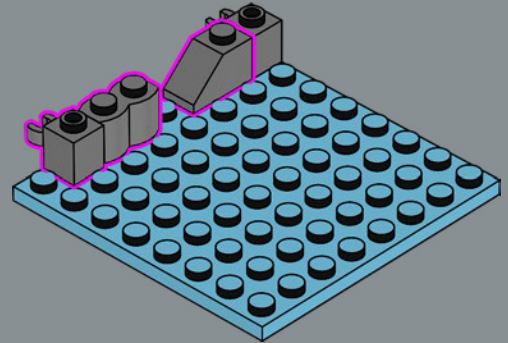

25

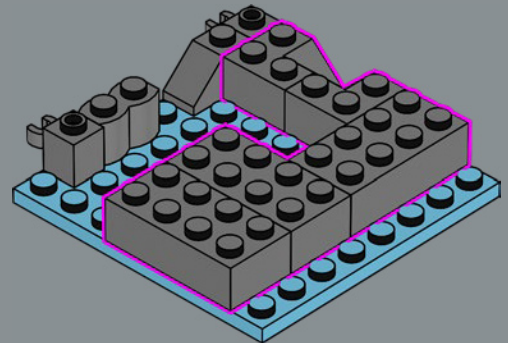

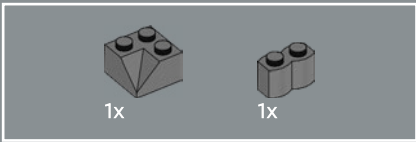

26



How this poor skeleton met his fate is unknown. Perhaps he was trying to escape? Or went in search of the hidden letter?

On ignore comment ce pauvre squelette a connu son sort. Peut-être essayait-il de s'échapper ? Ou peut-être essayait-il de trouver la lettre cachée ?

Se desconoce cómo encontró su destino este pobre esqueleto. ¿Quizá tratando de escapar? ¿O llegó hasta aquí buscando la carta oculta?

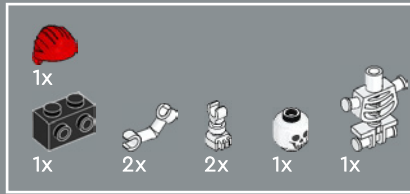

27

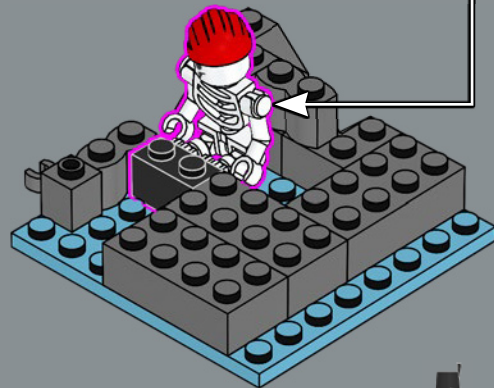
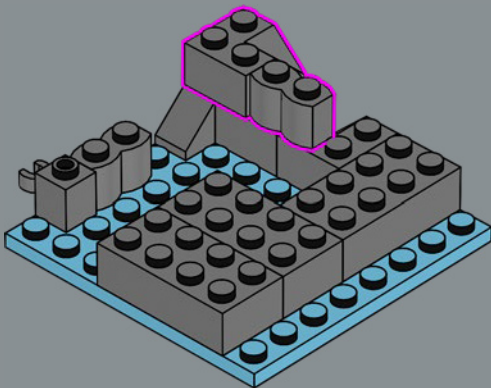
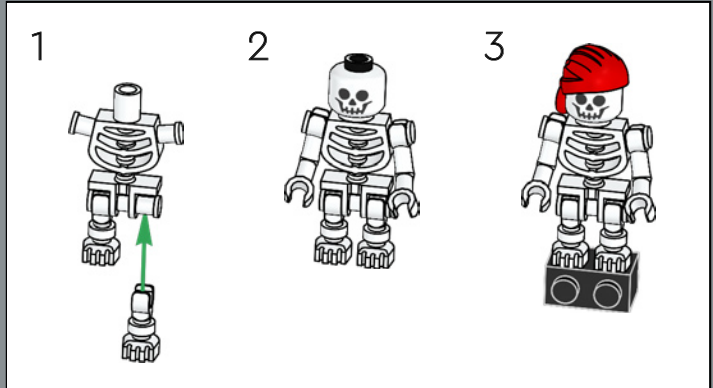

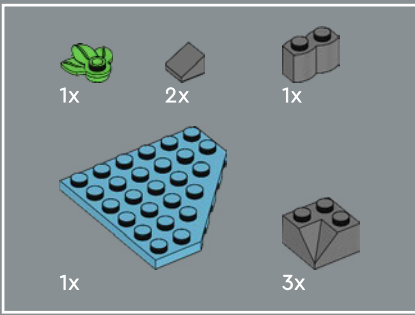

28

1

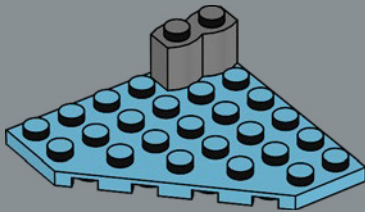

2

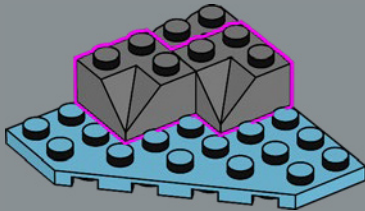

3

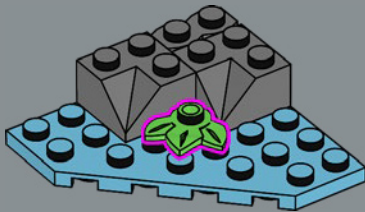

4

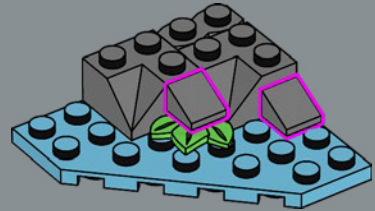

5

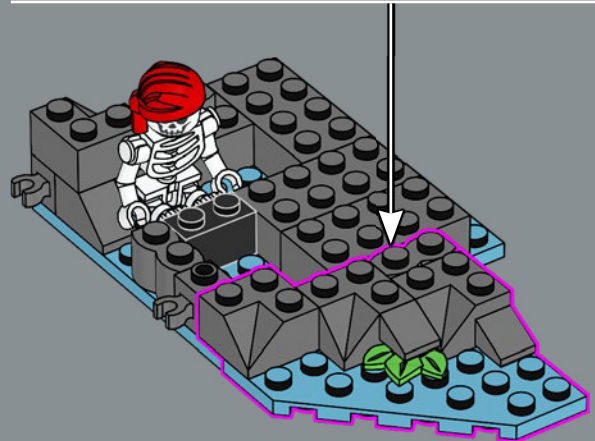
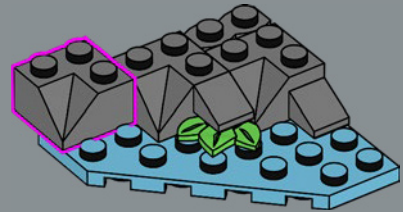

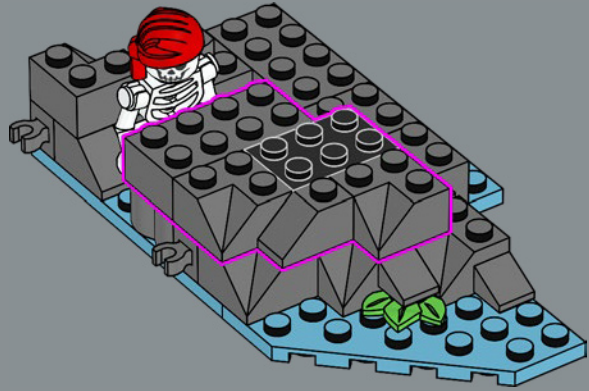
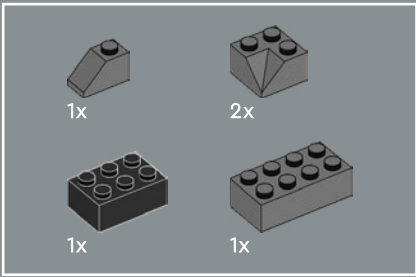

29

30

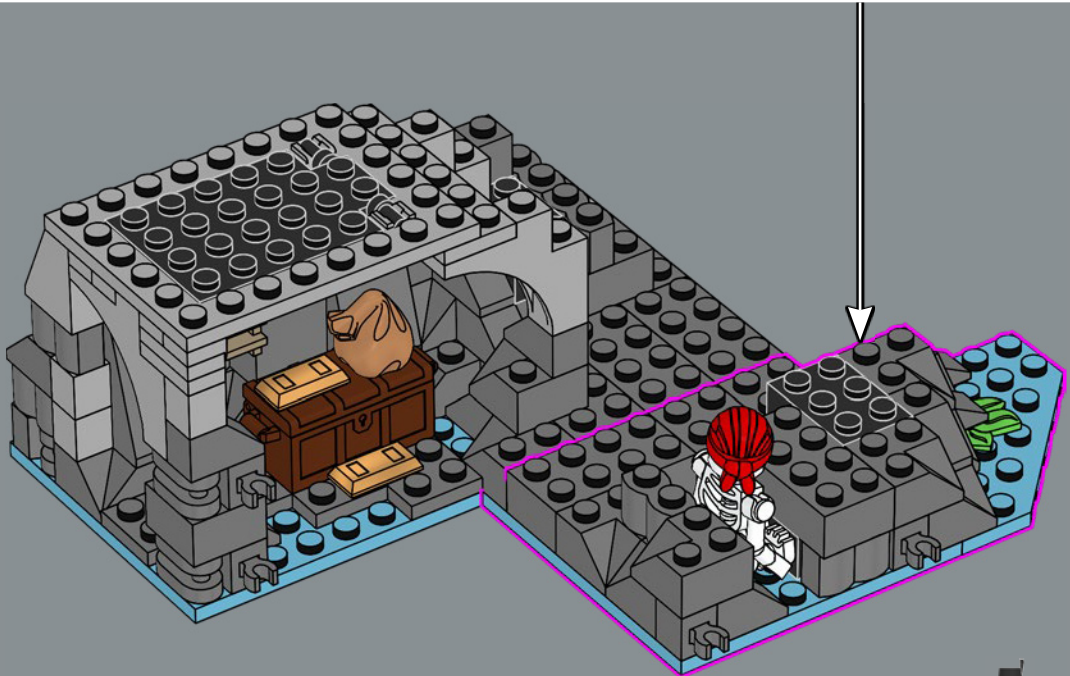

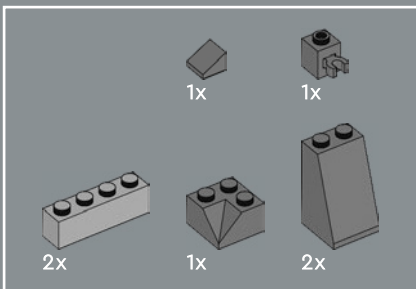

31

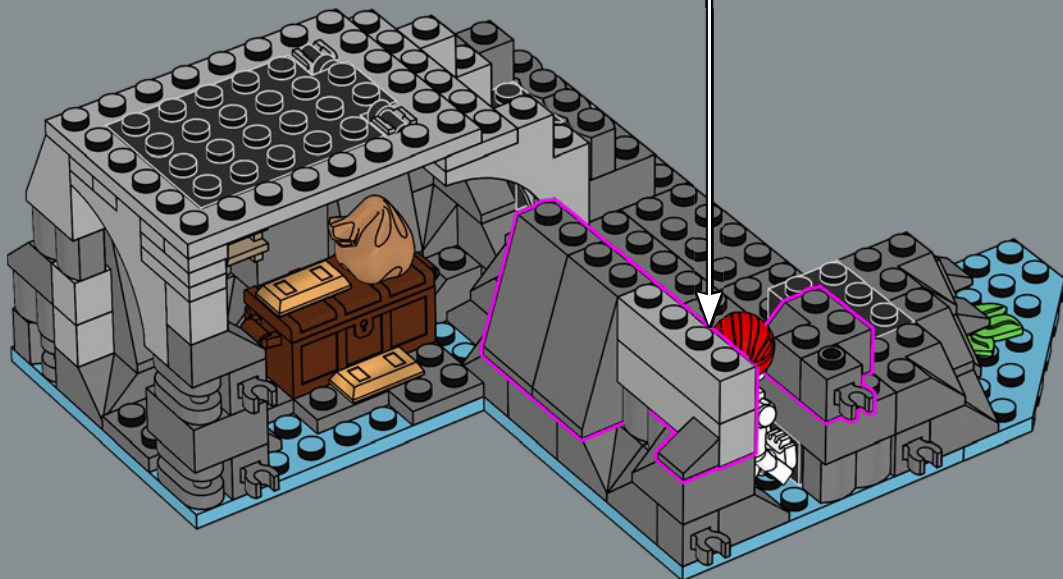
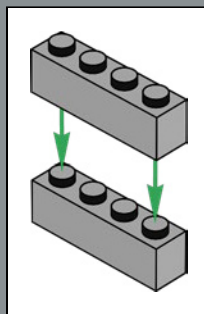

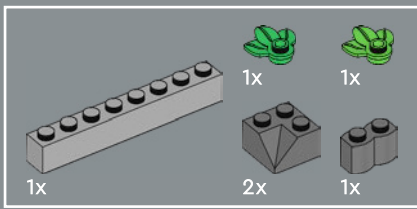

32

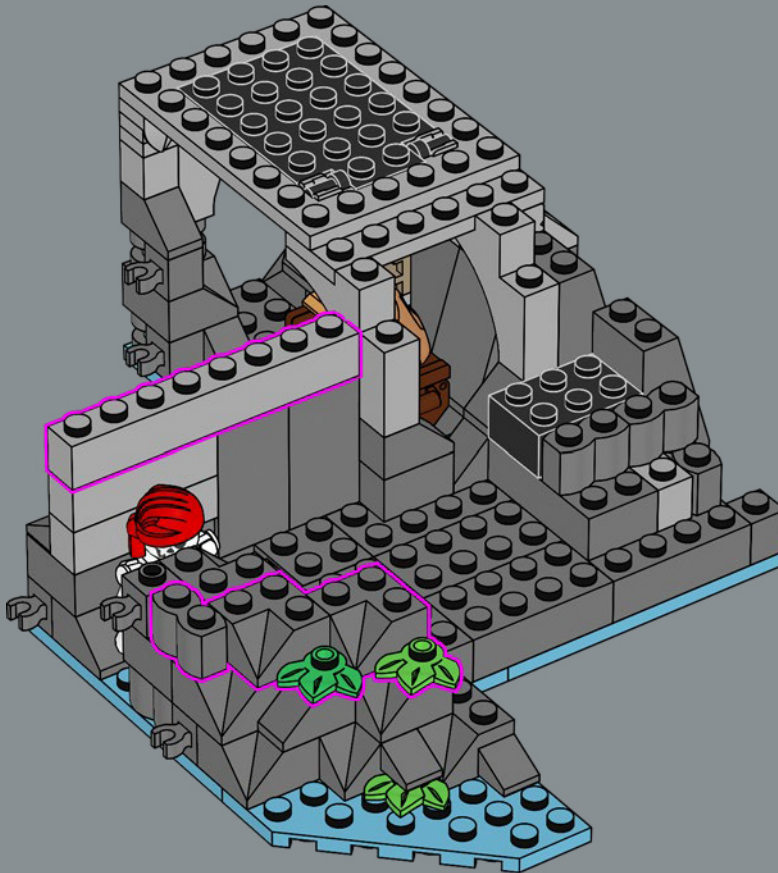

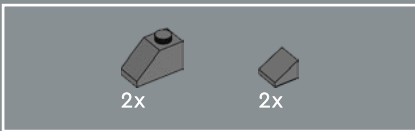

33

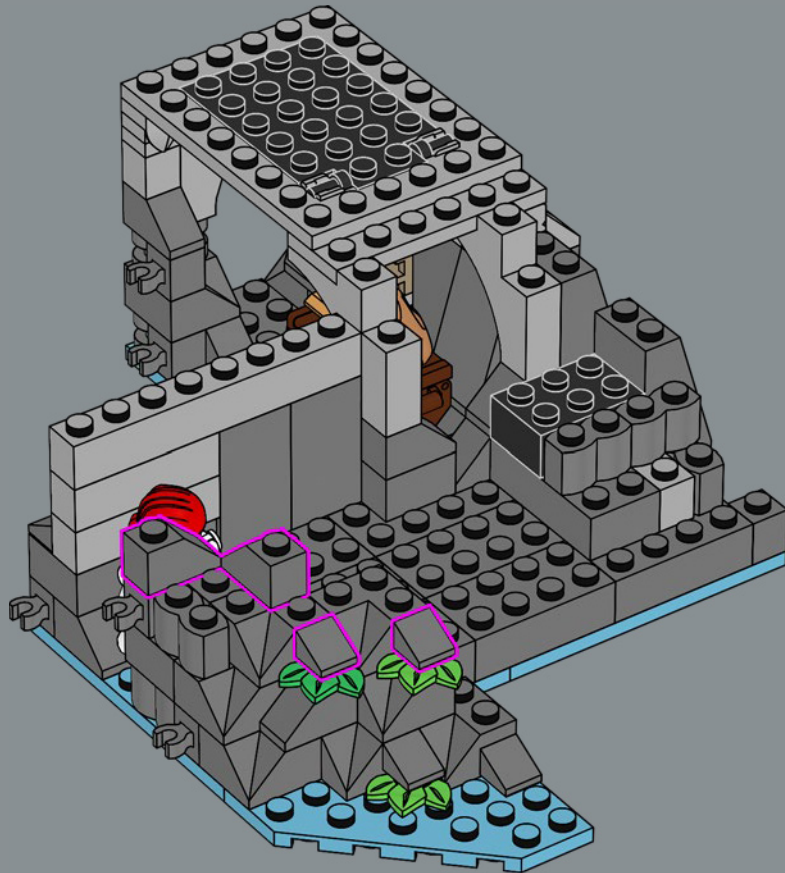

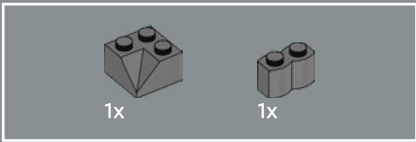

34

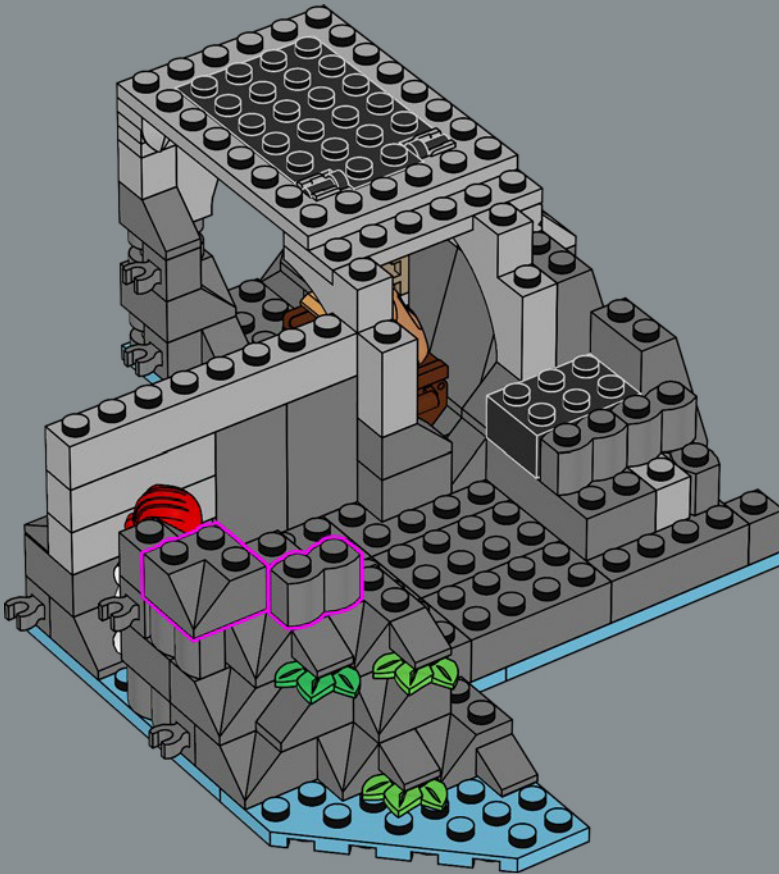

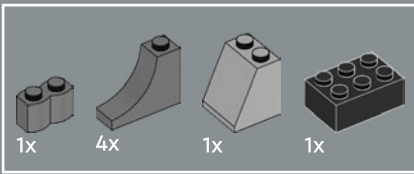

35

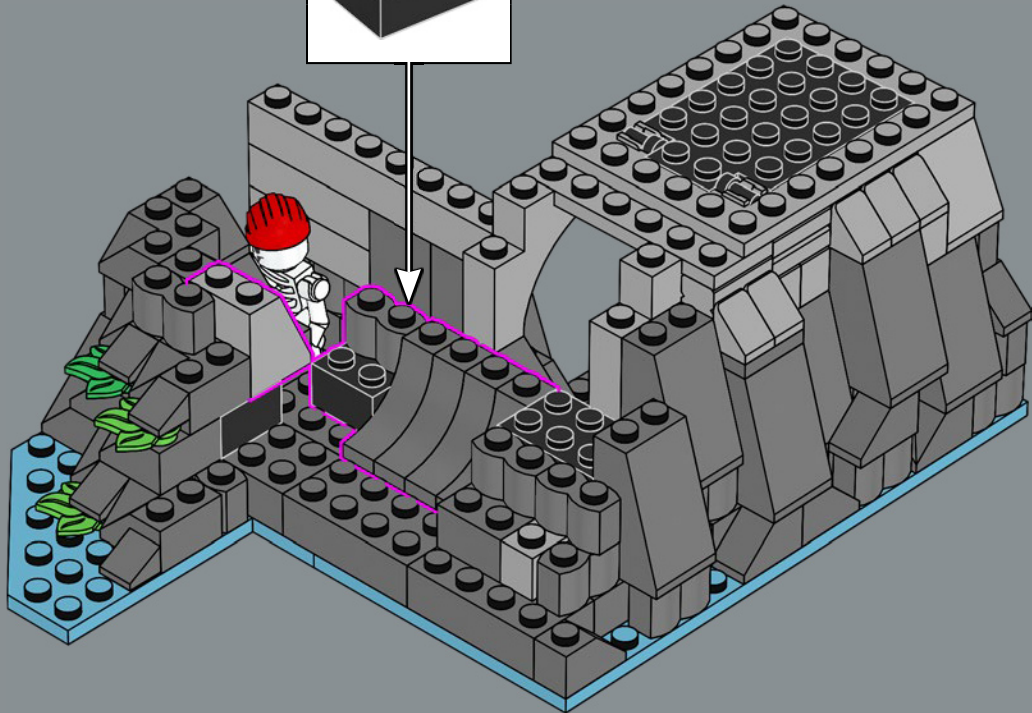
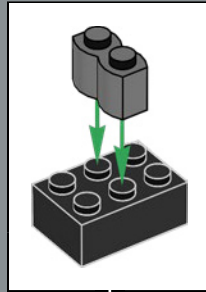

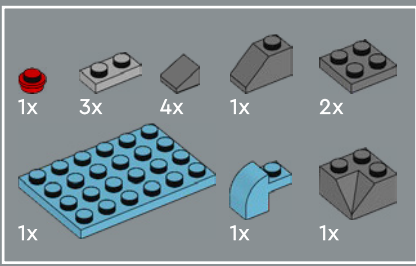

36

1

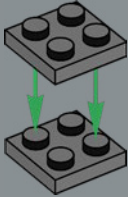

2

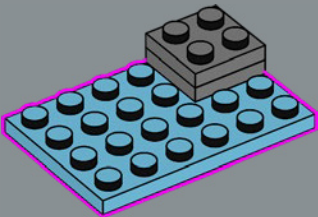

3

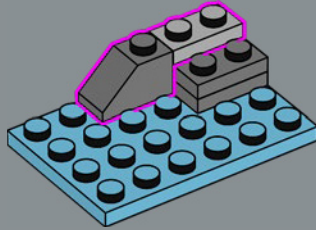

4

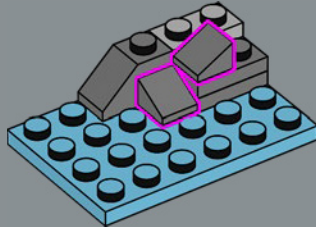

5

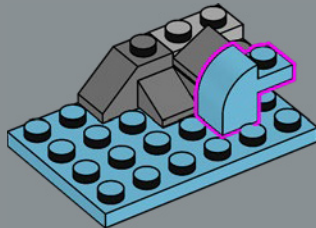

6

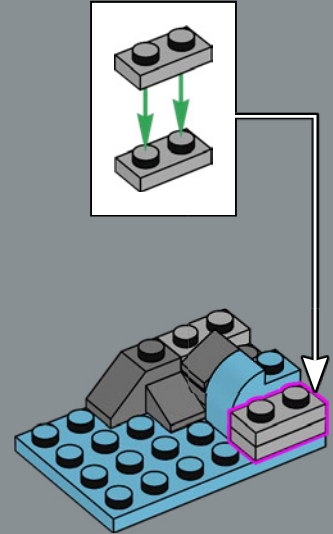

7

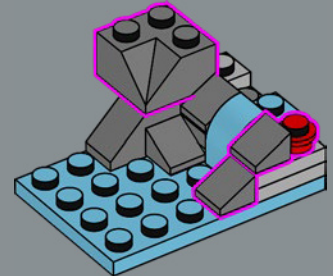

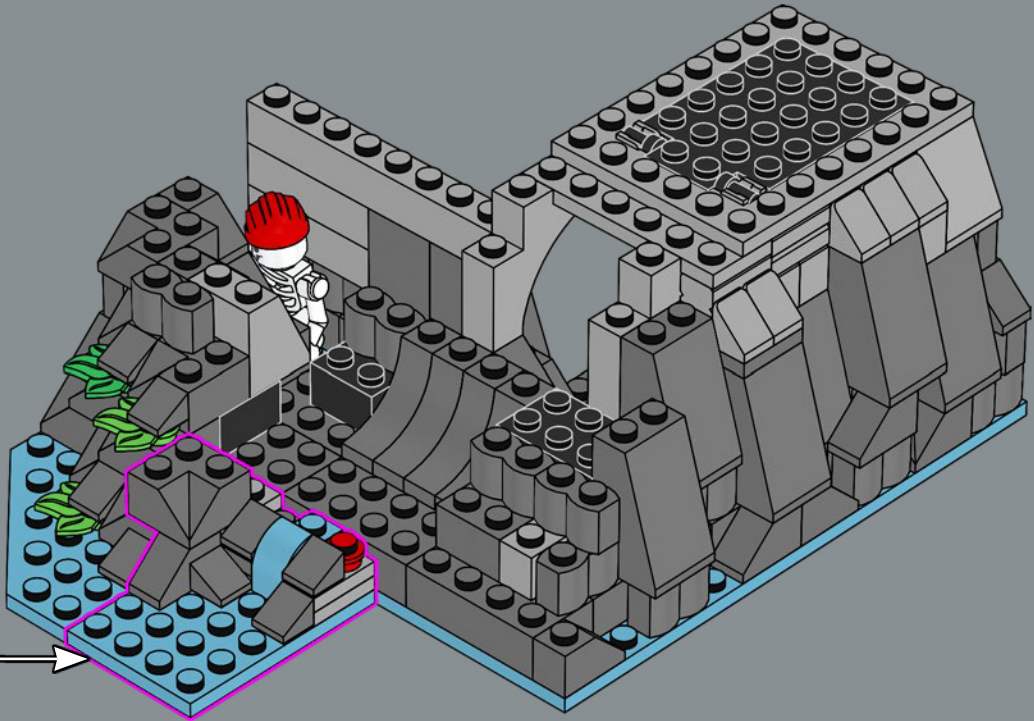

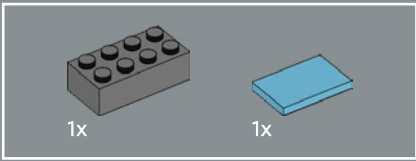

37

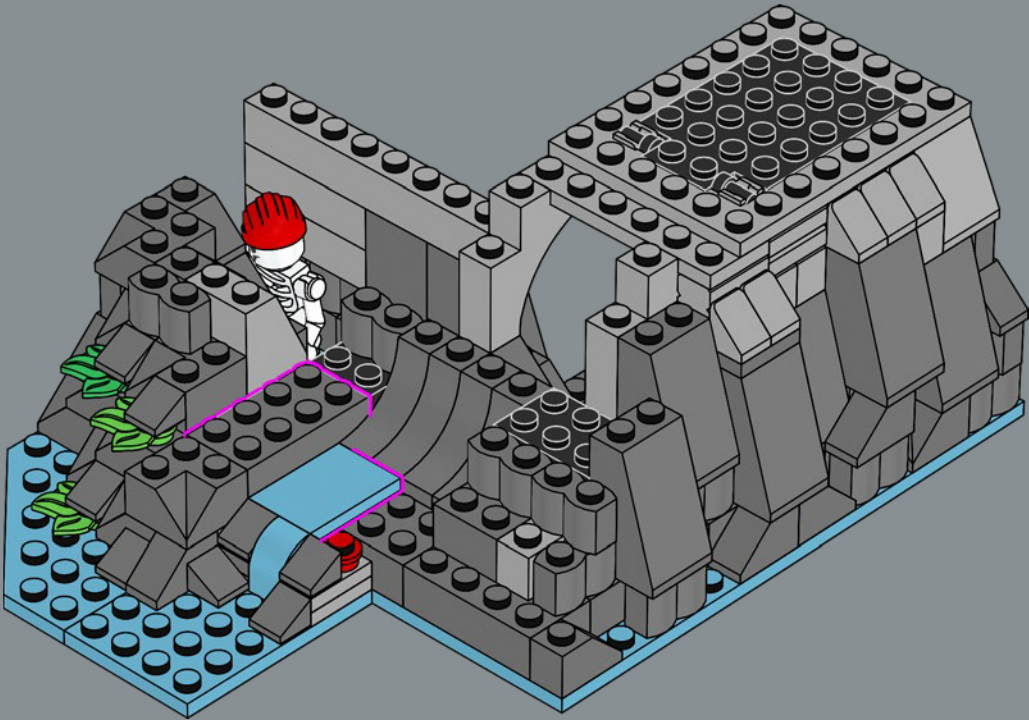

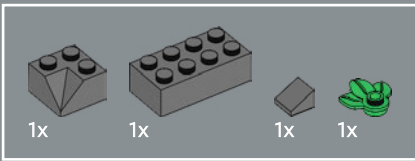

38

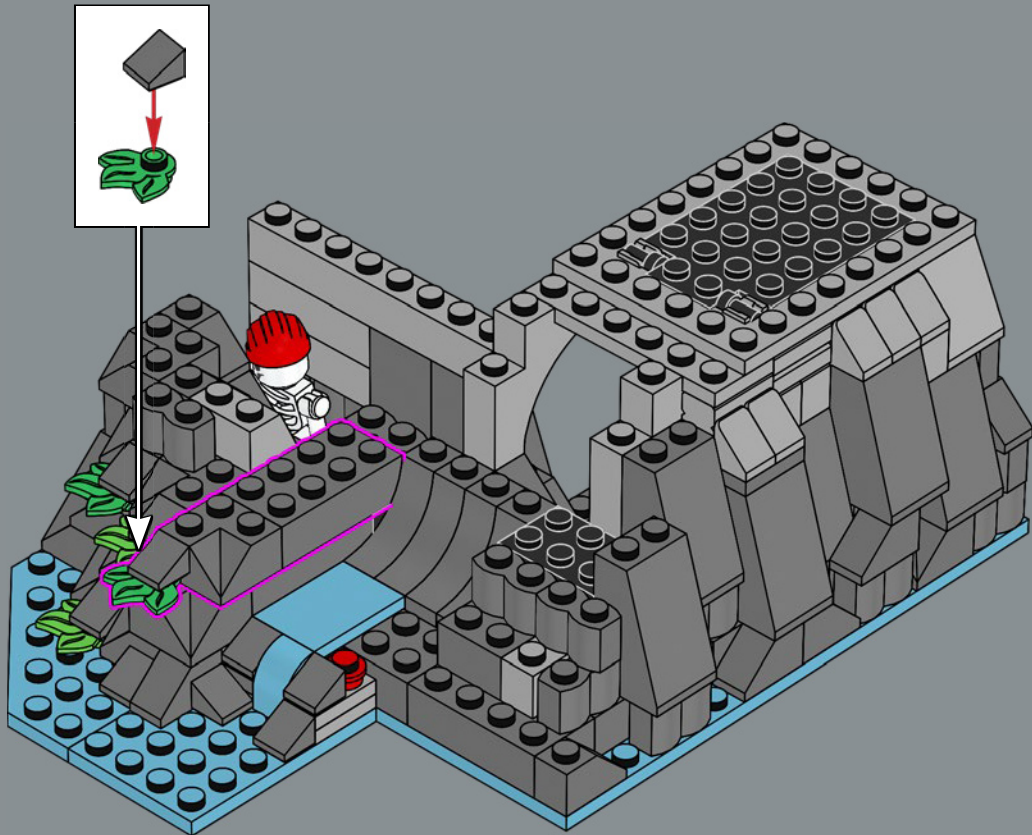

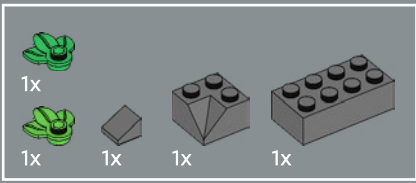

39

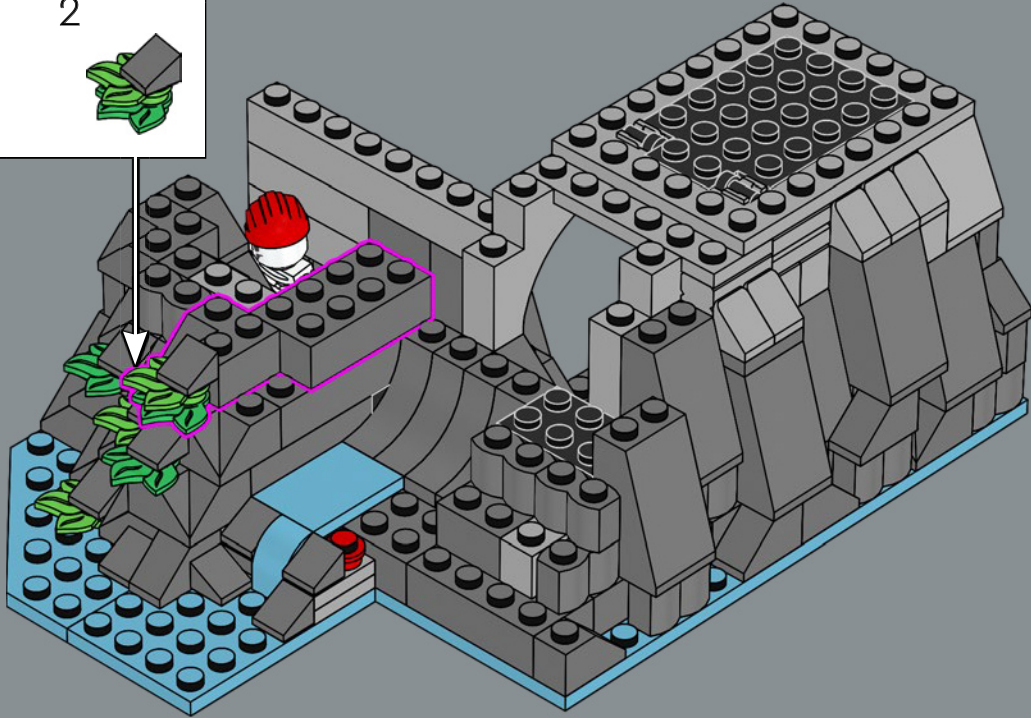
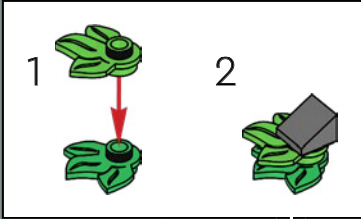

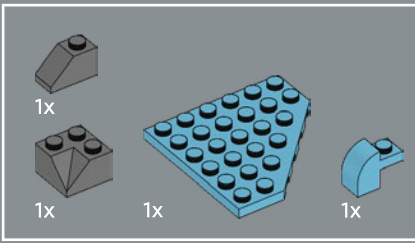

40

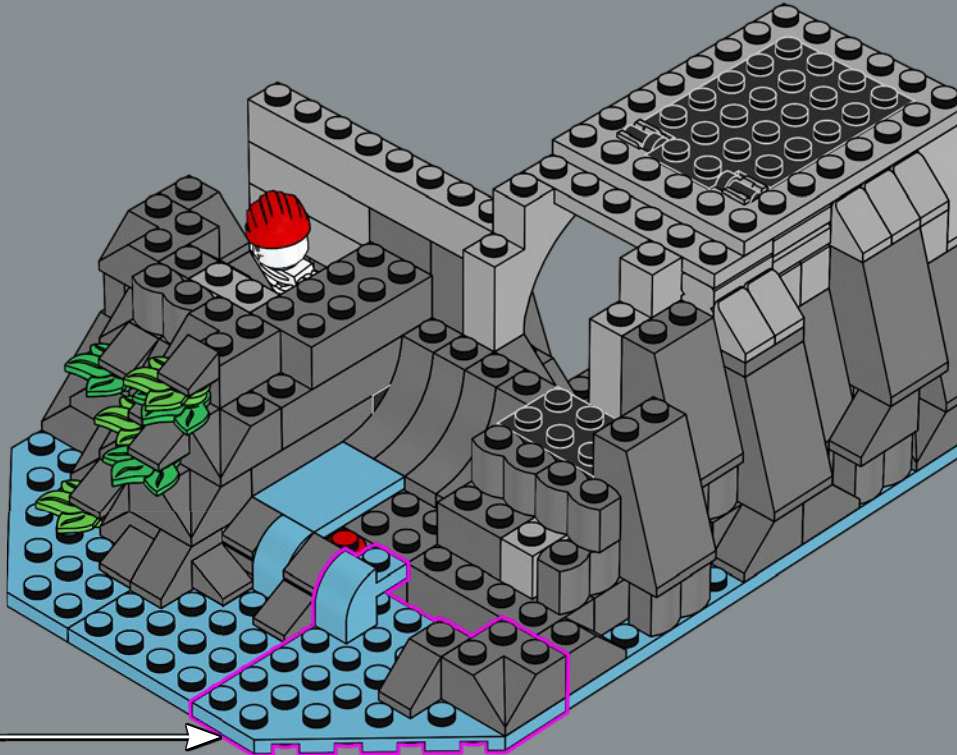
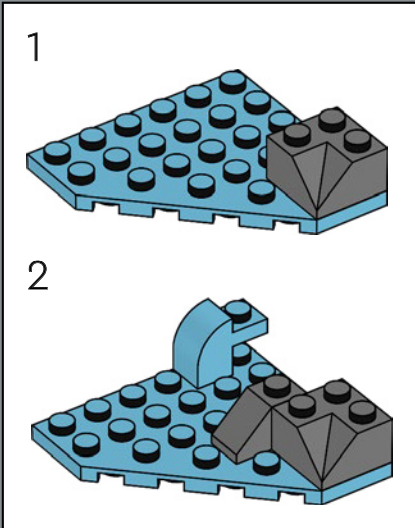

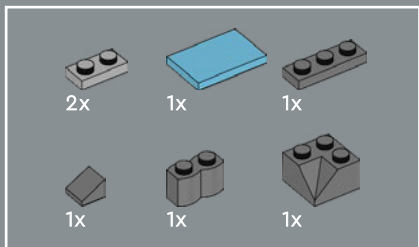

41

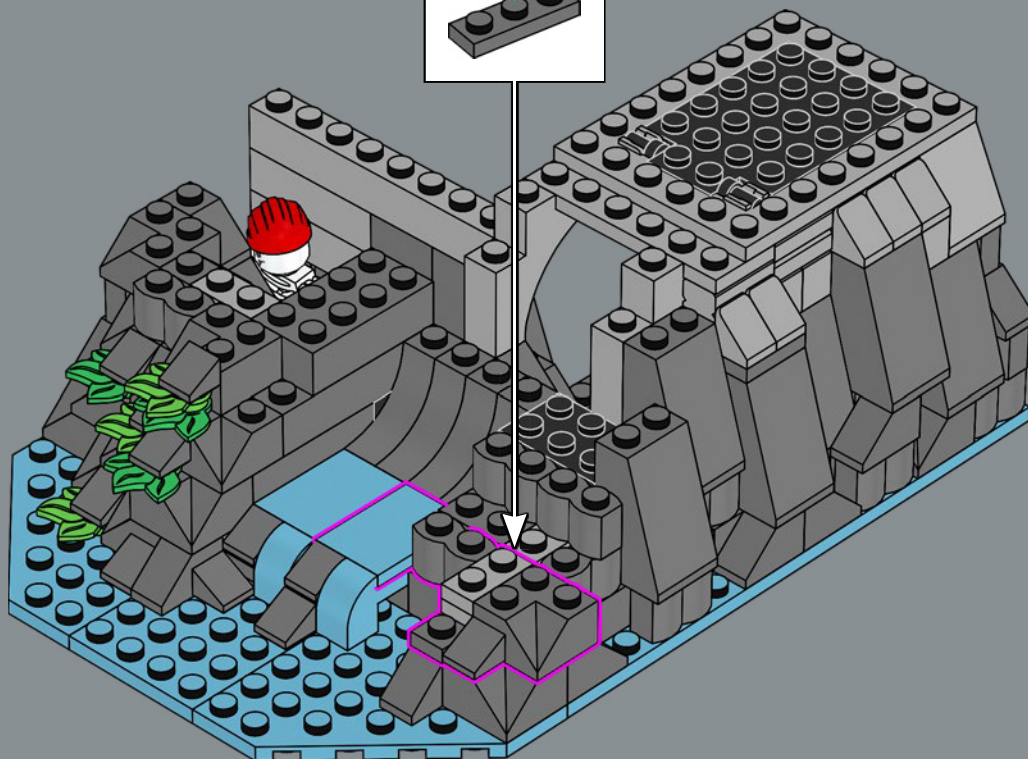
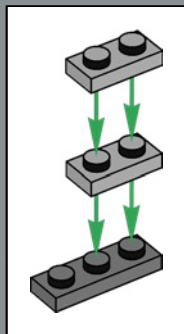

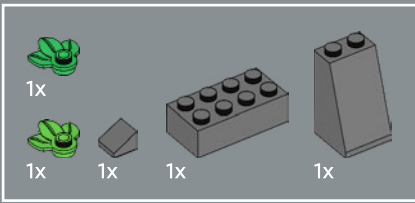

42

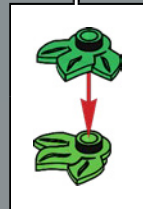
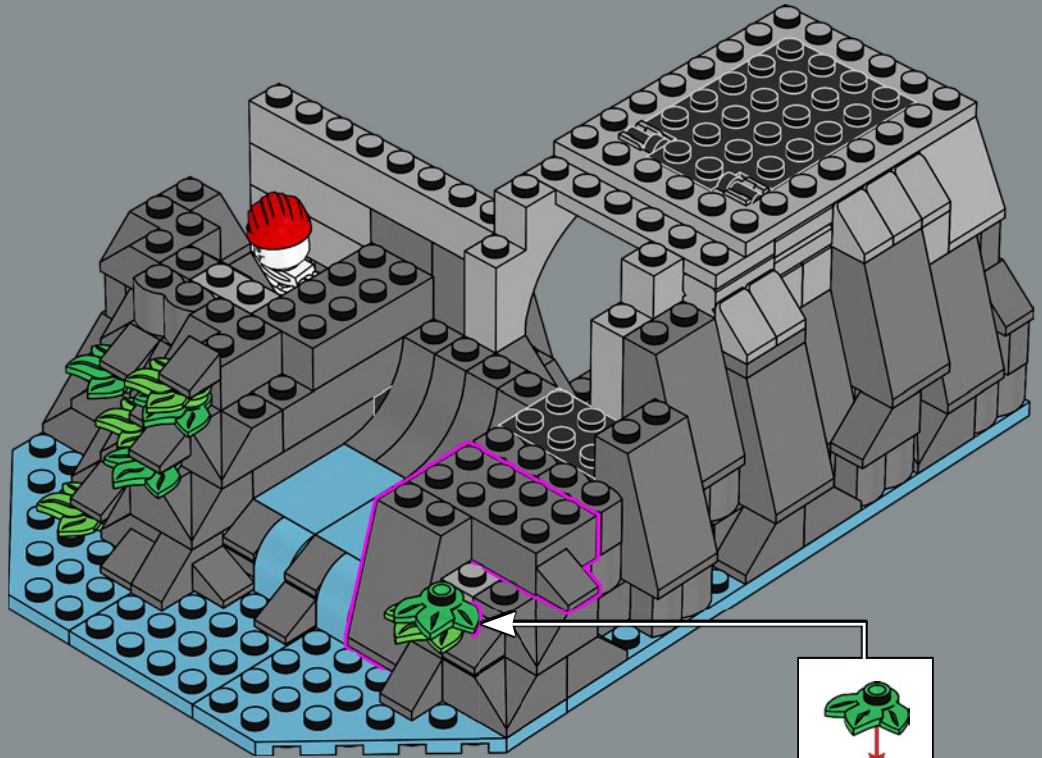

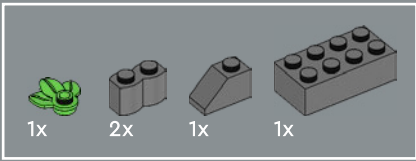

43

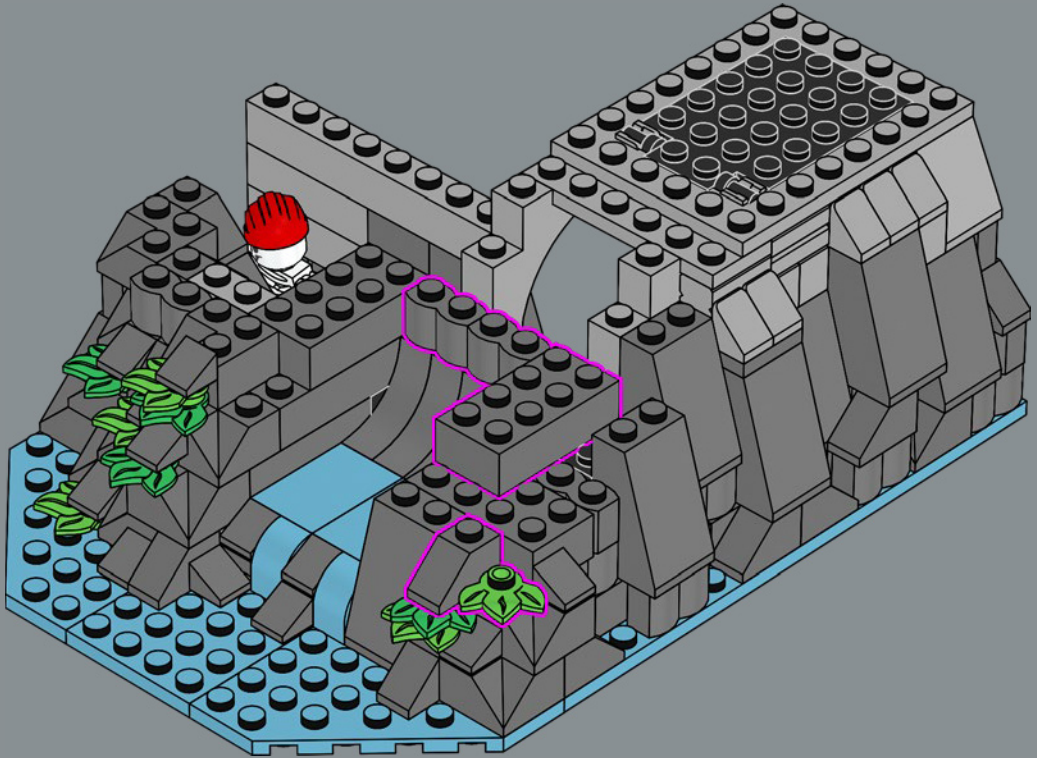

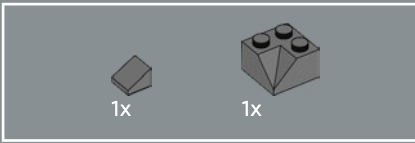

44

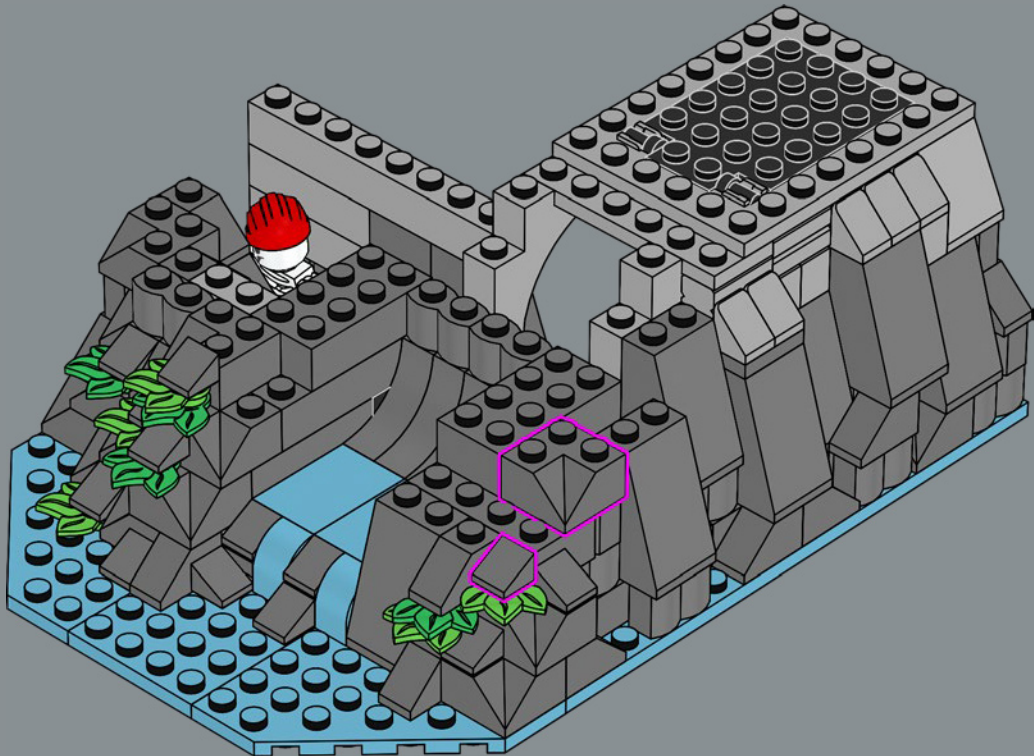

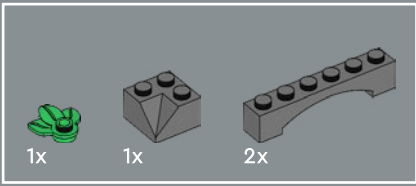

45

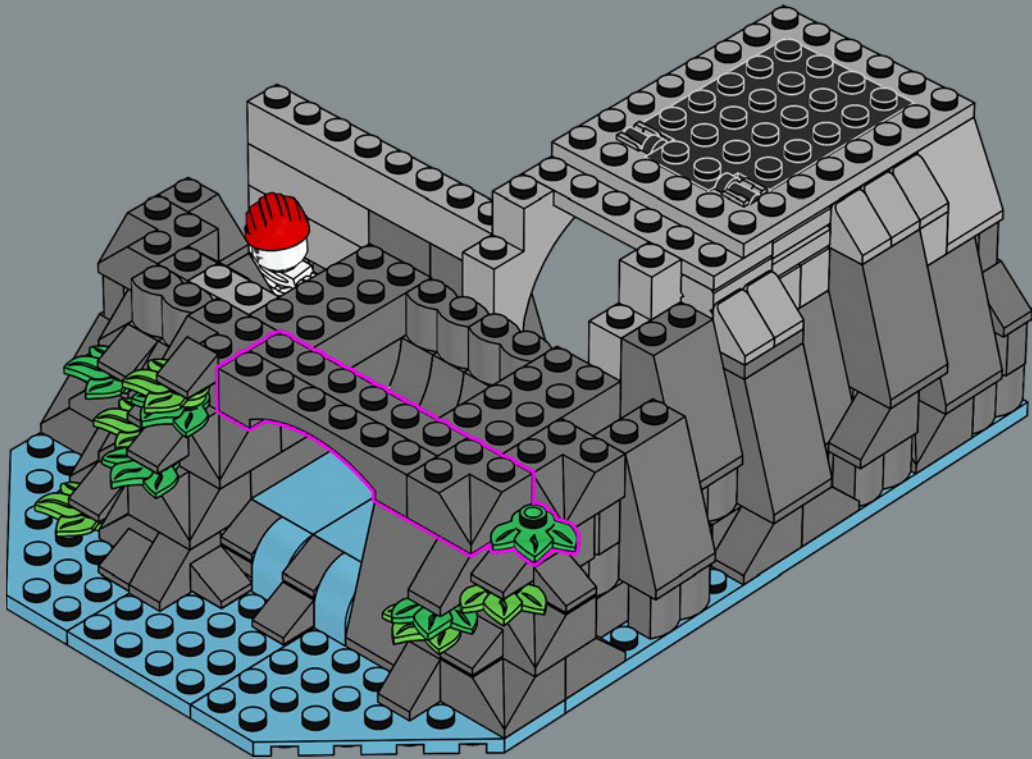

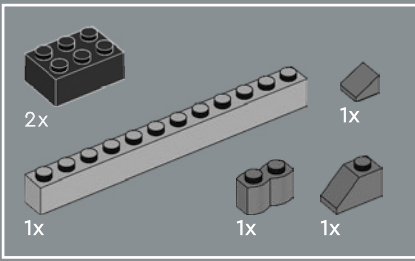

46

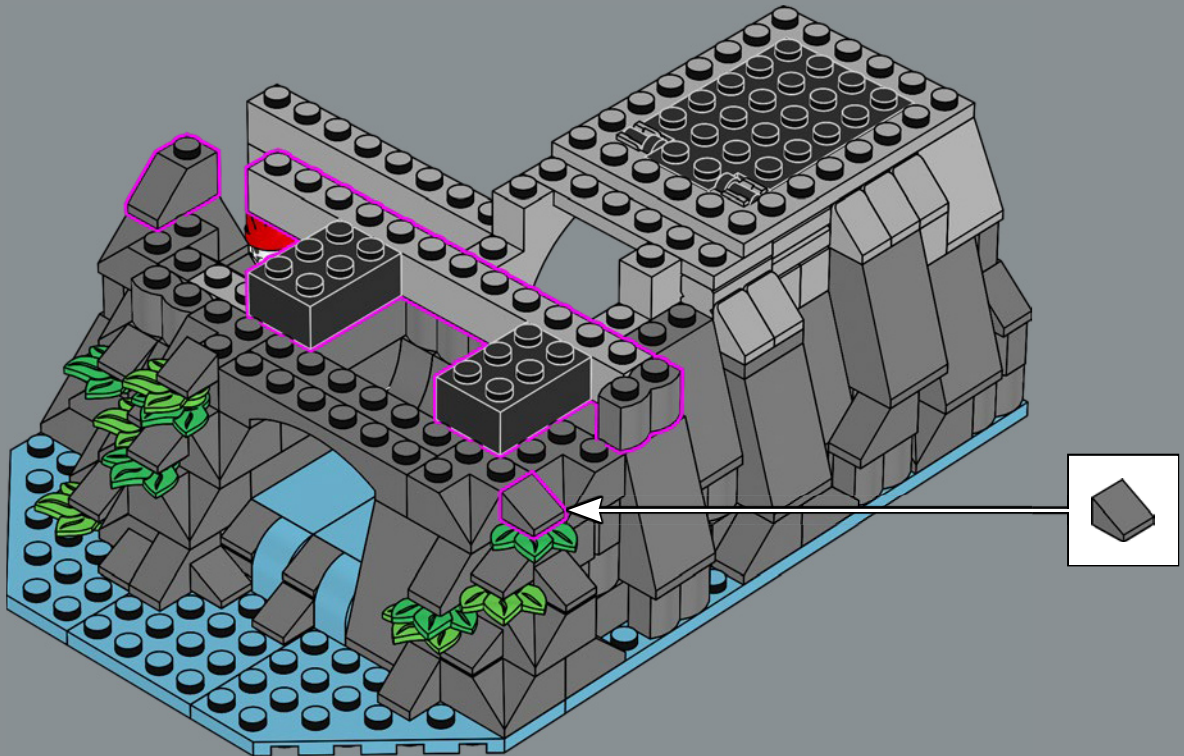

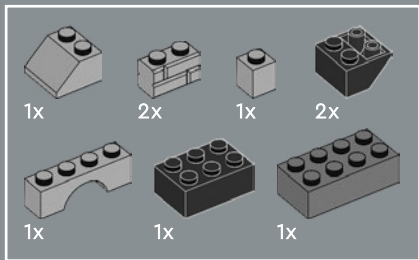

47

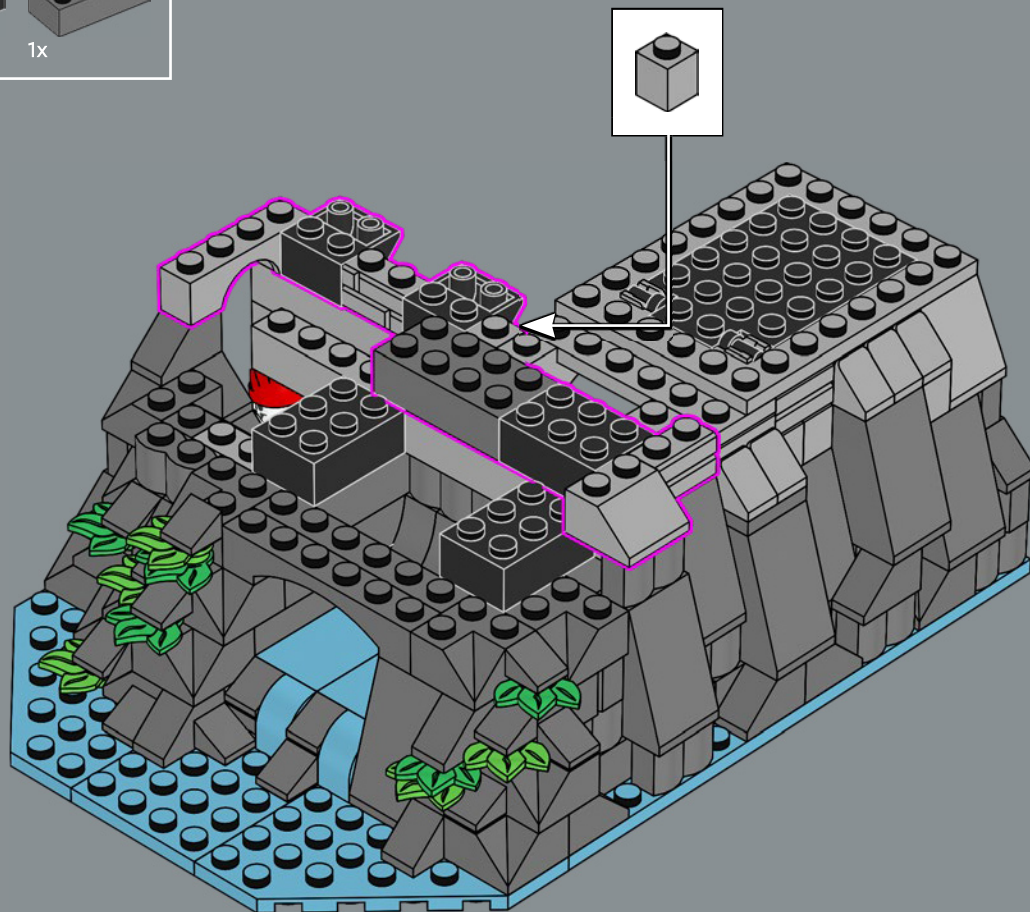

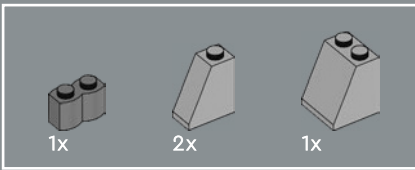

48

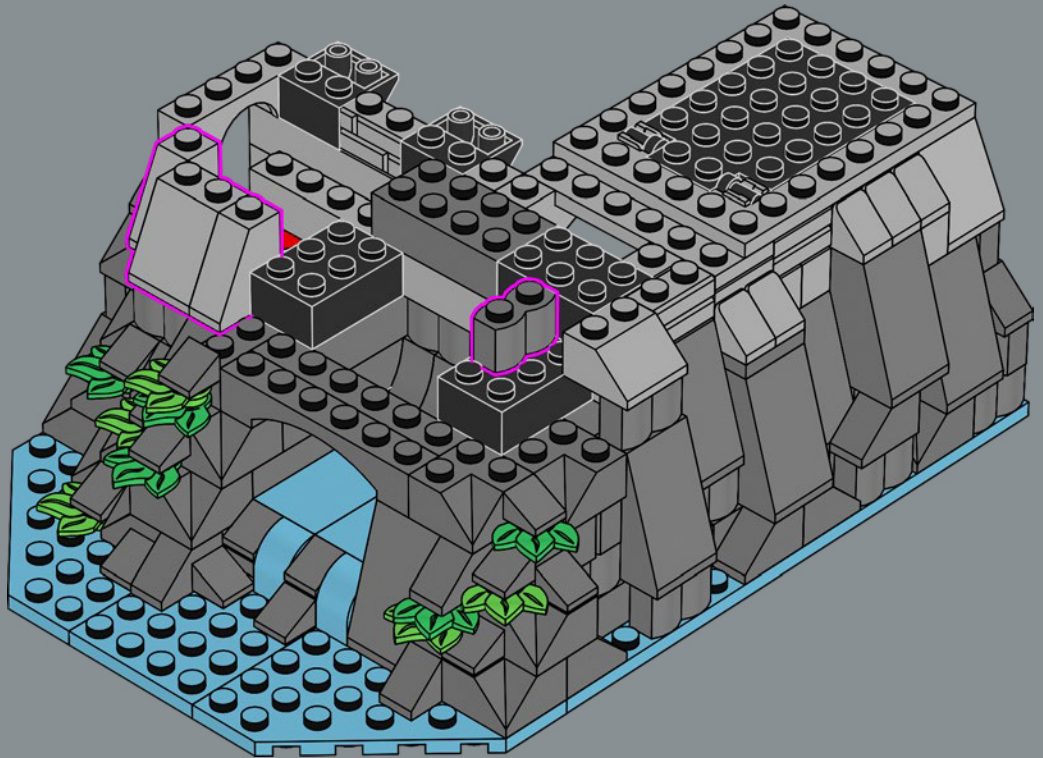

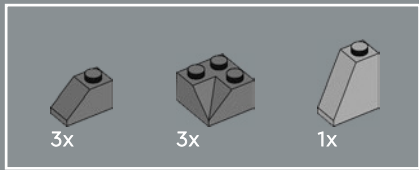

49

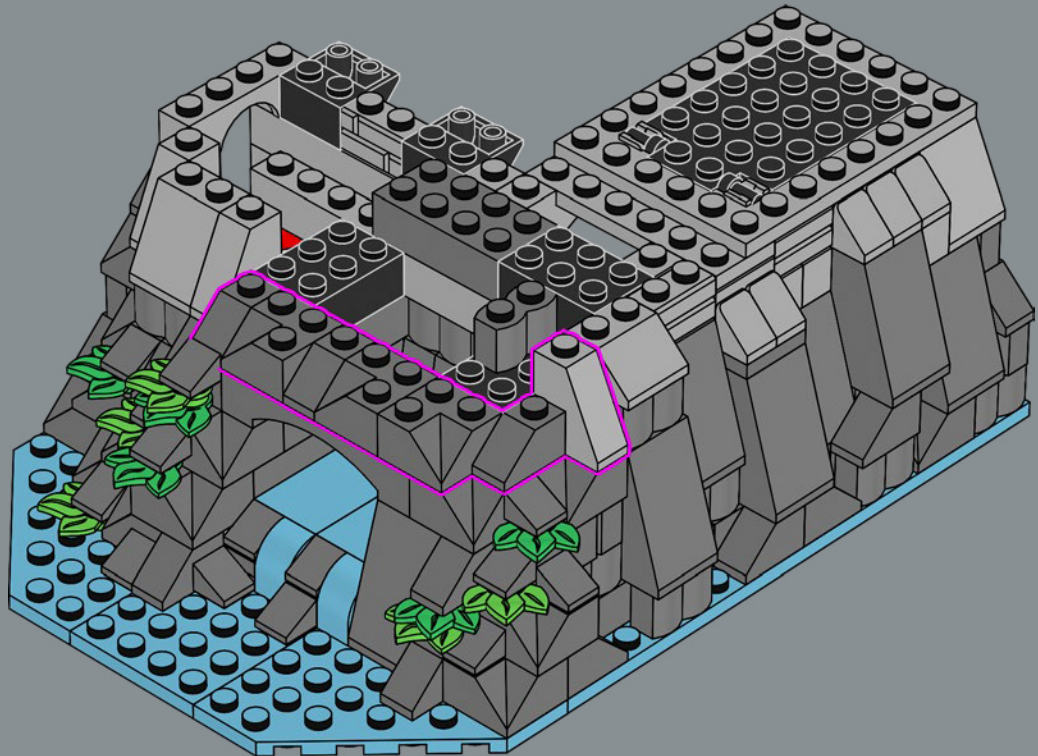

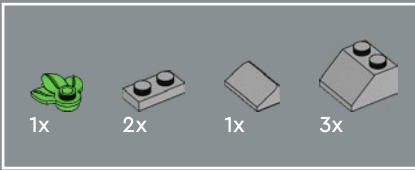

50

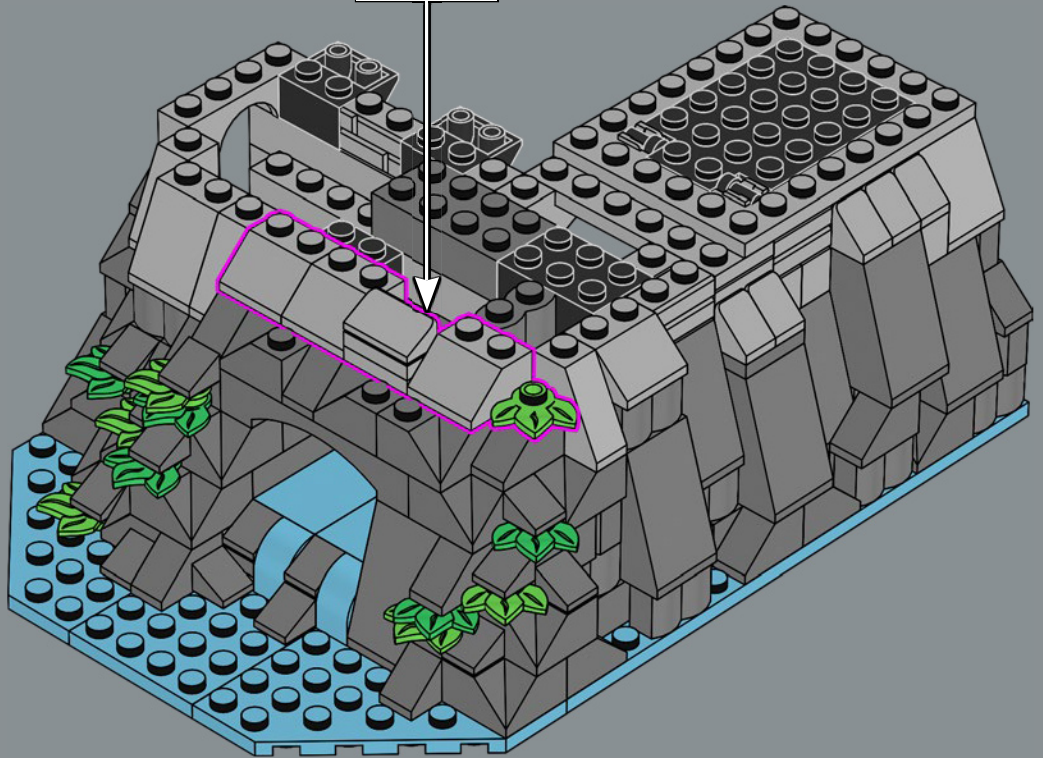
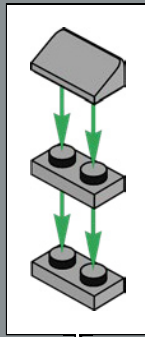

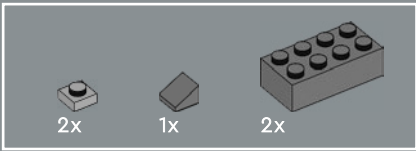

51

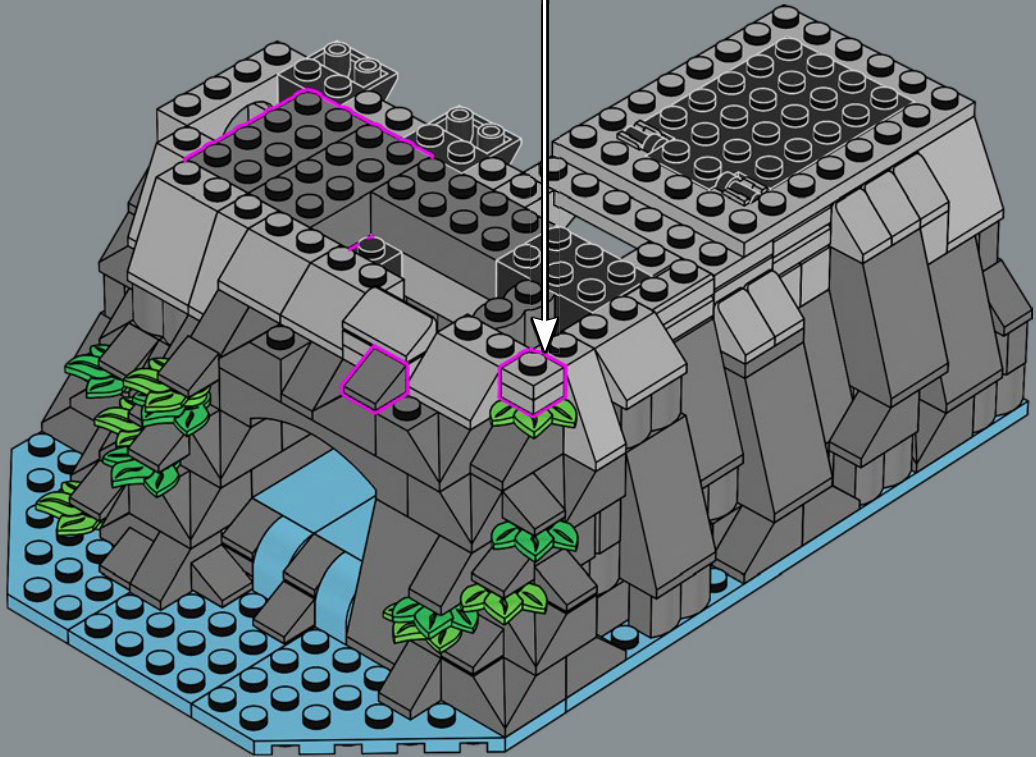
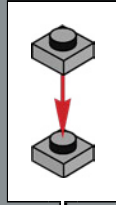

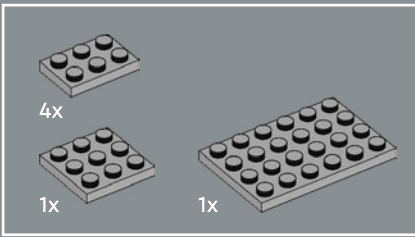

52

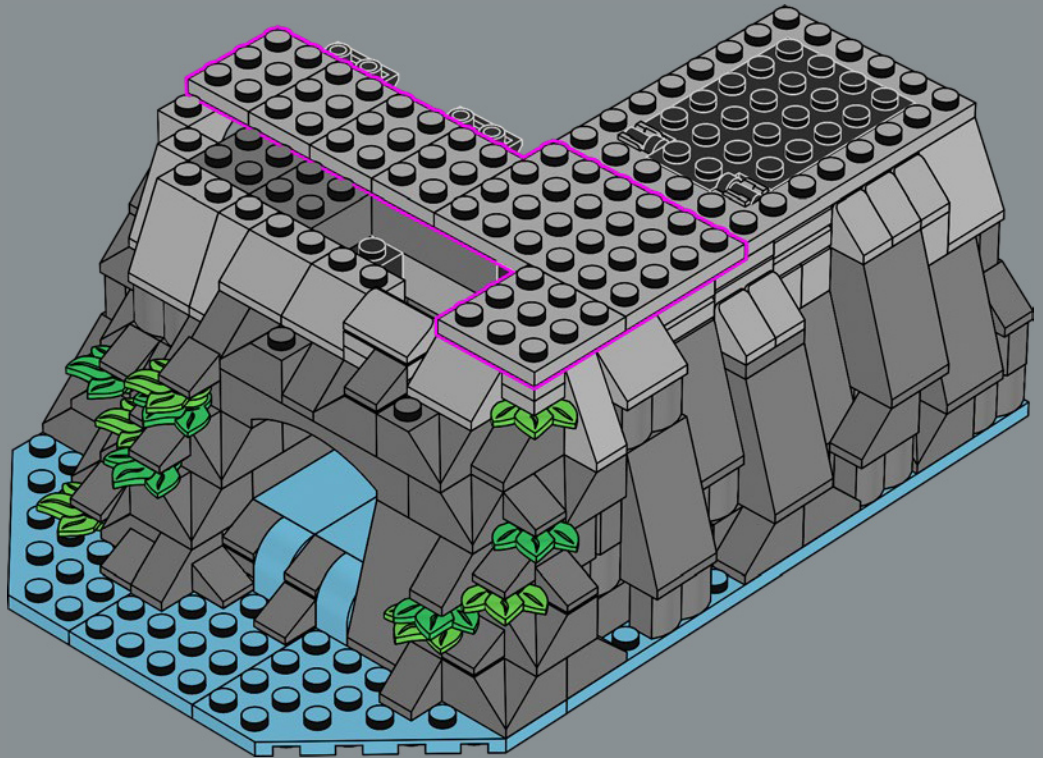



2x



2x



1x

53

A cleverly hidden hatch door allows captured pirates to escape to the beach where their buccaneer buddies can pick them up.

Une trappe astucieusement cachée permet aux pirates capturés de s'échapper vers la plage, où leurs copains boucaniers peuvent les récupérer.

Una portezuela ingeniosamente oculta permite a los piratas escapar a la playa, donde los recogerán sus compañeros bucaneros.

1

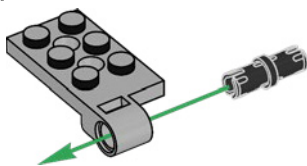

2

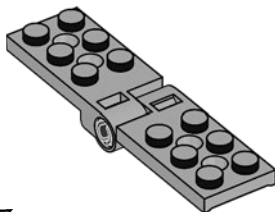

3

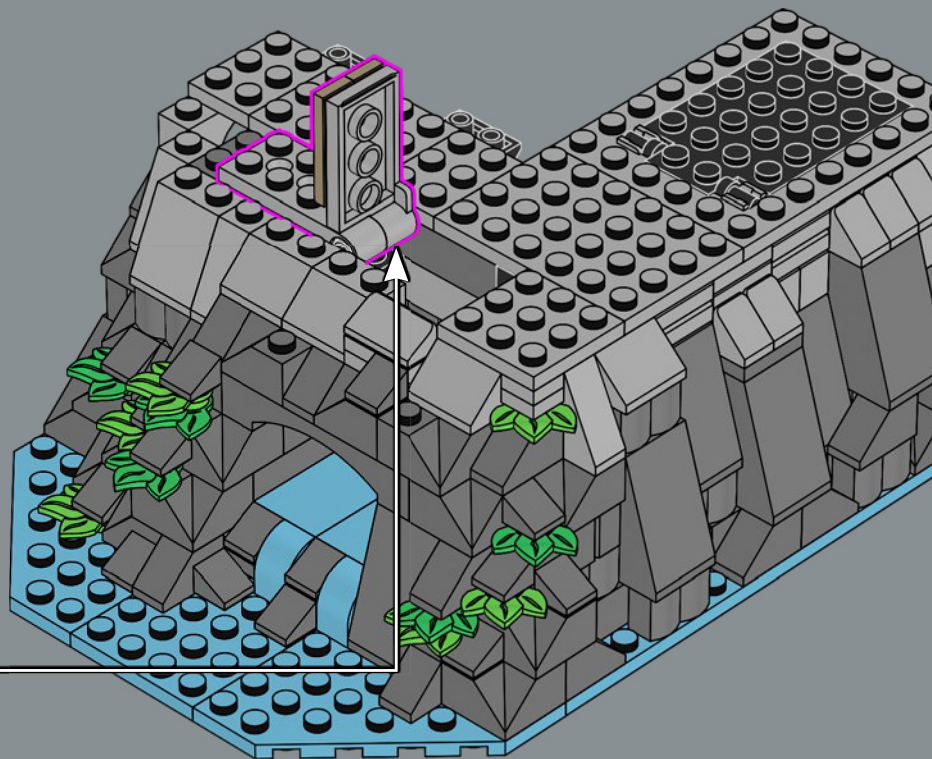
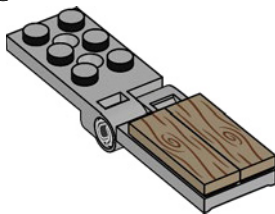

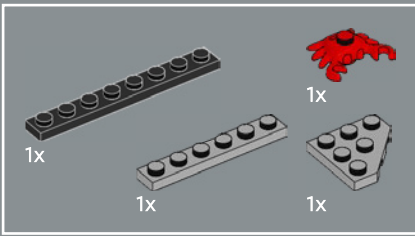

54

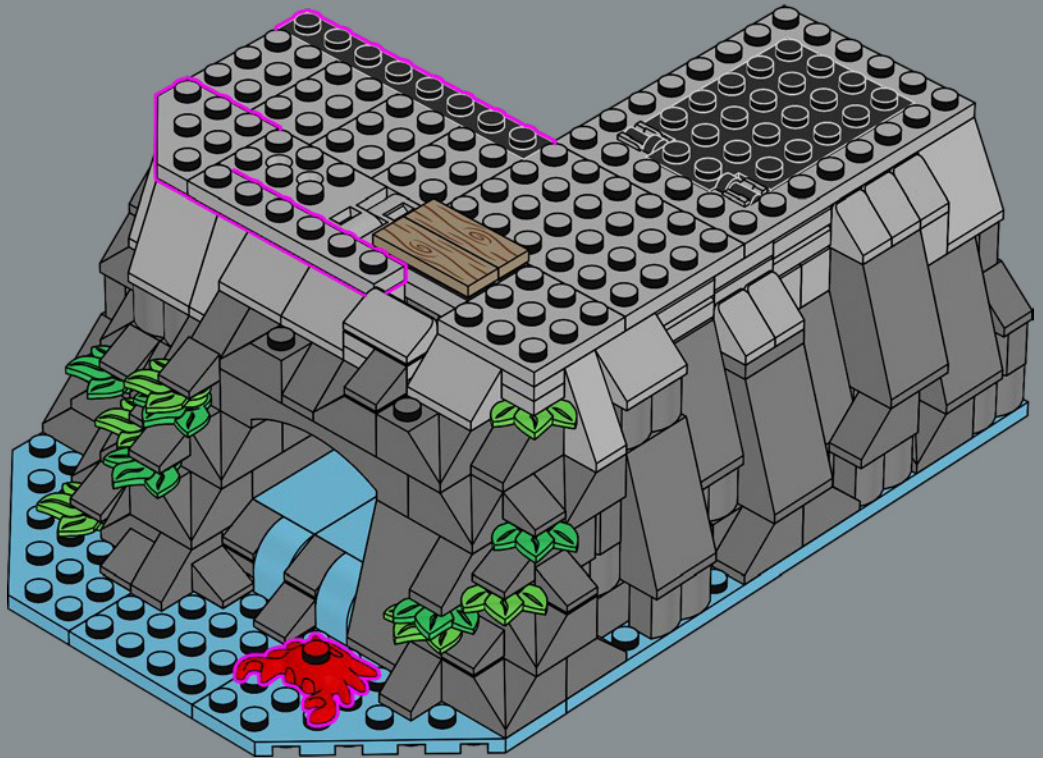



1

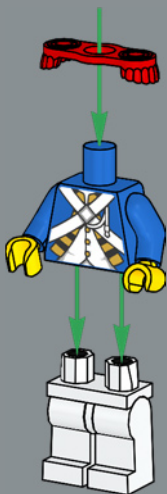

2



3



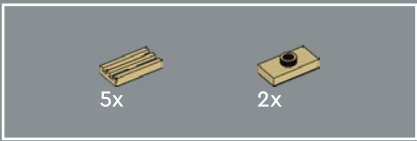

55

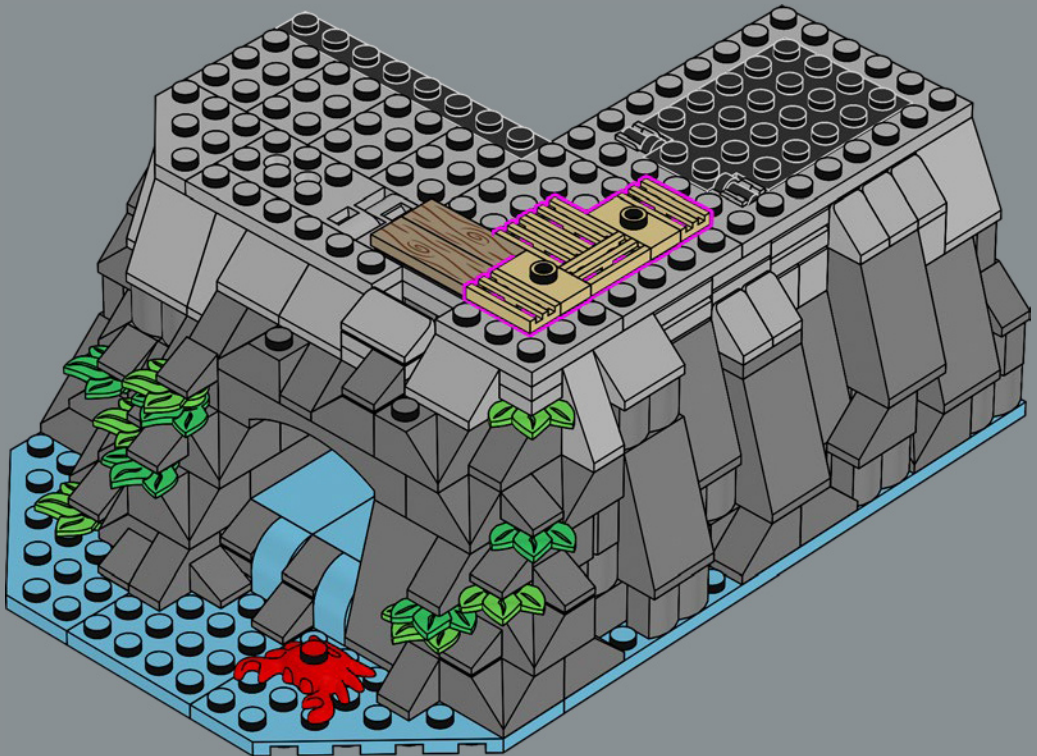

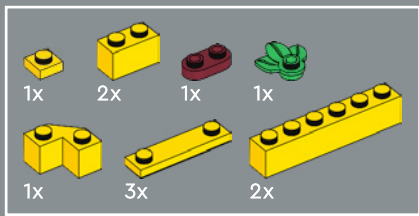

56

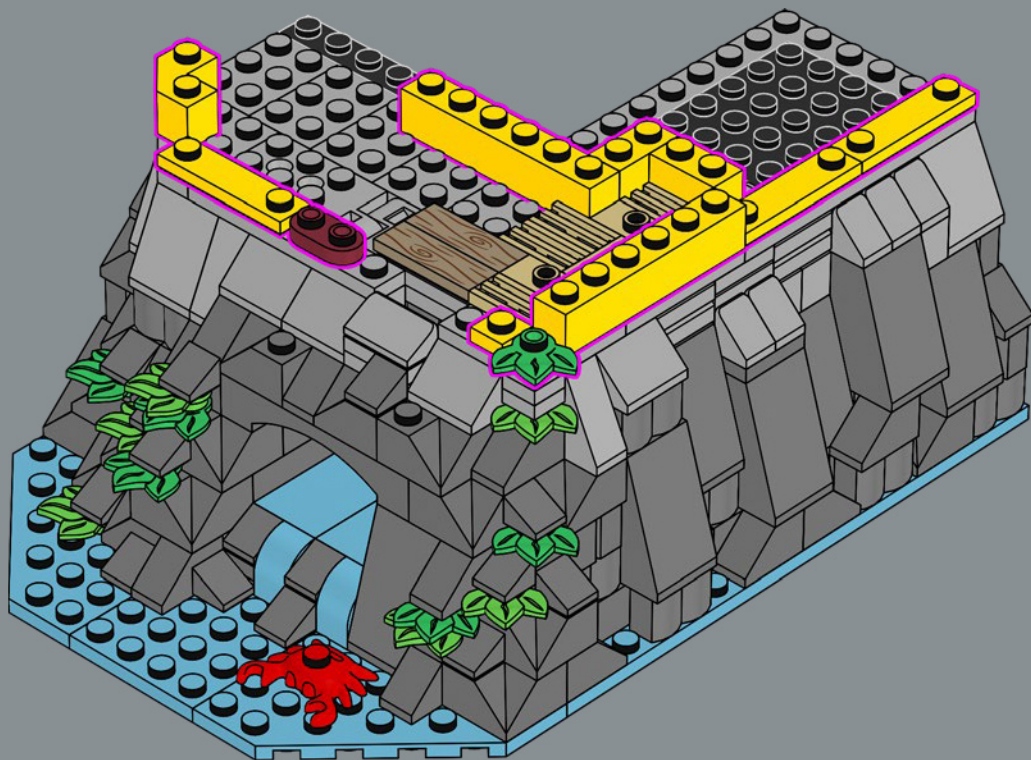



57

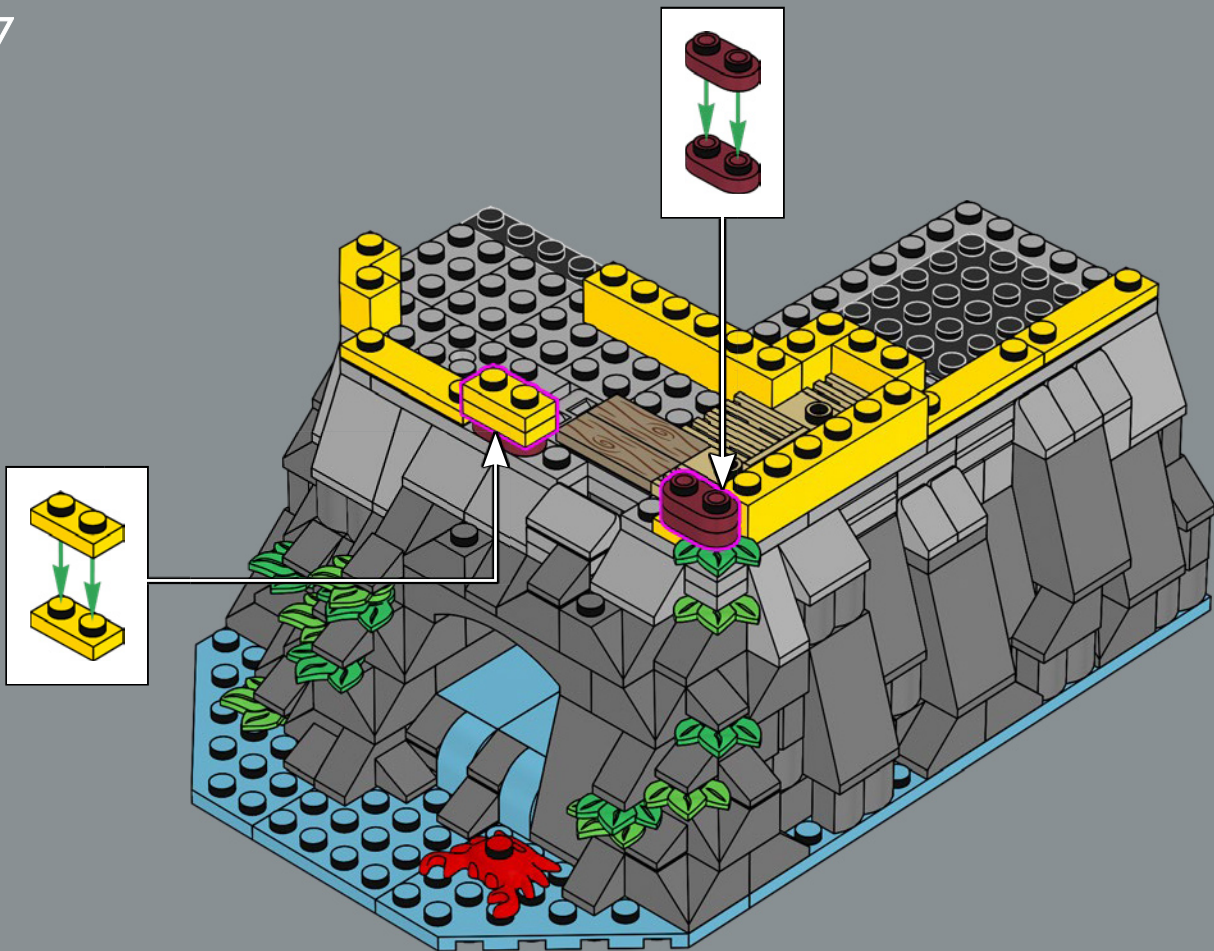

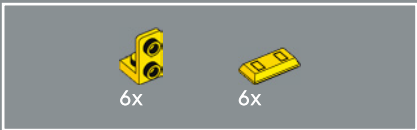

58

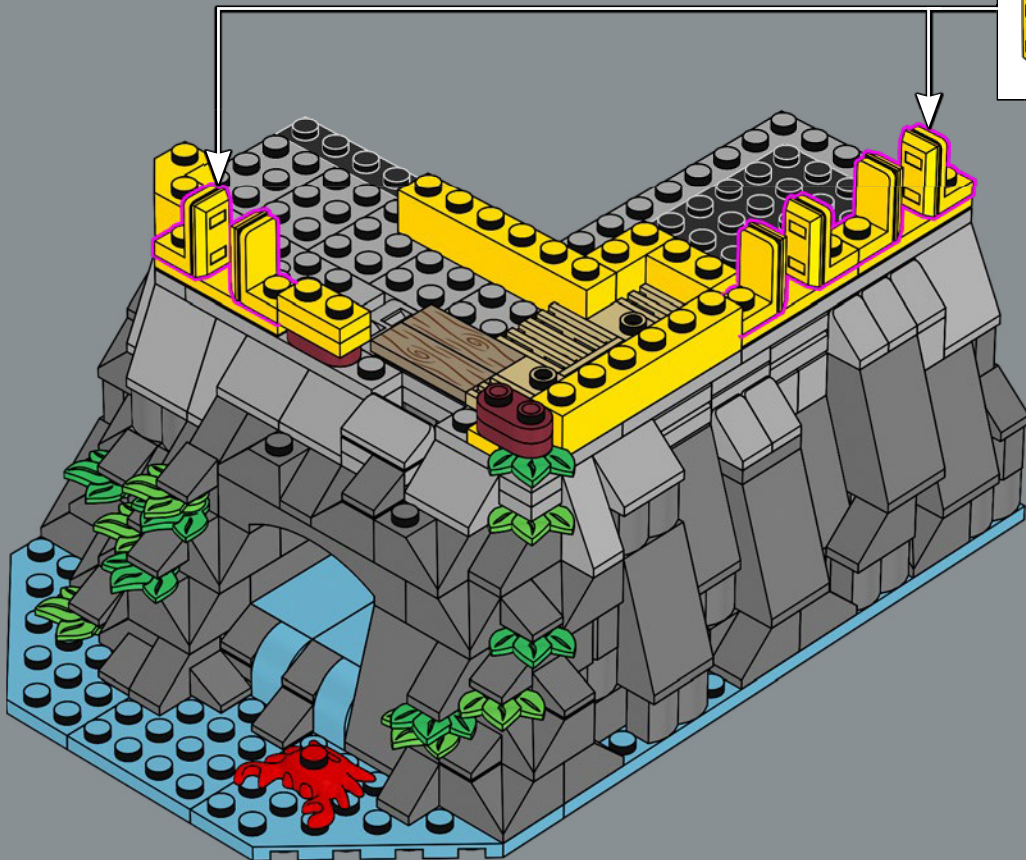
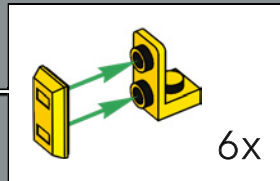



4x



1x

59

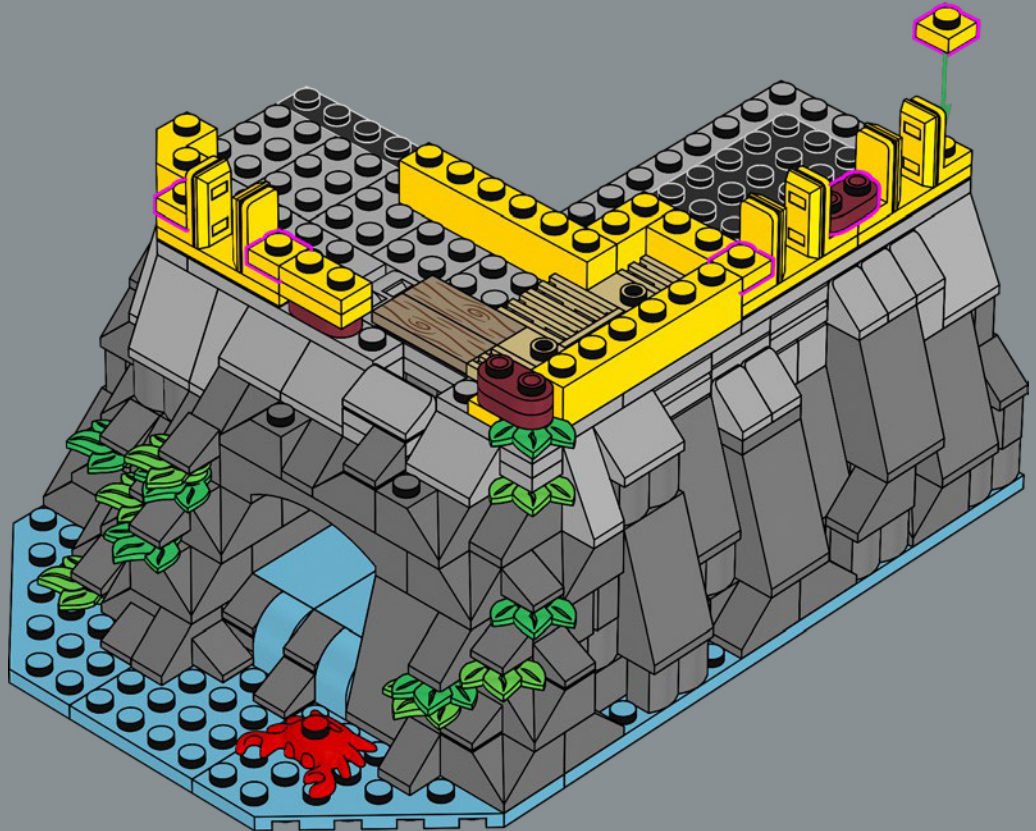



2x



1x



1x



60



Things have improved for pirate prisoners too!
Now they can rest comfortably on a hay mattress.

Les choses se sont améliorées pour les prisonniers
pirates aussi ! Désormais, ils peuvent se reposer
confortablement sur un matelas de foin.

¡Las cosas también mejoraron para los prisioneros
piratas! Ahora pueden descansar cómodamente en
un colchón de paja.

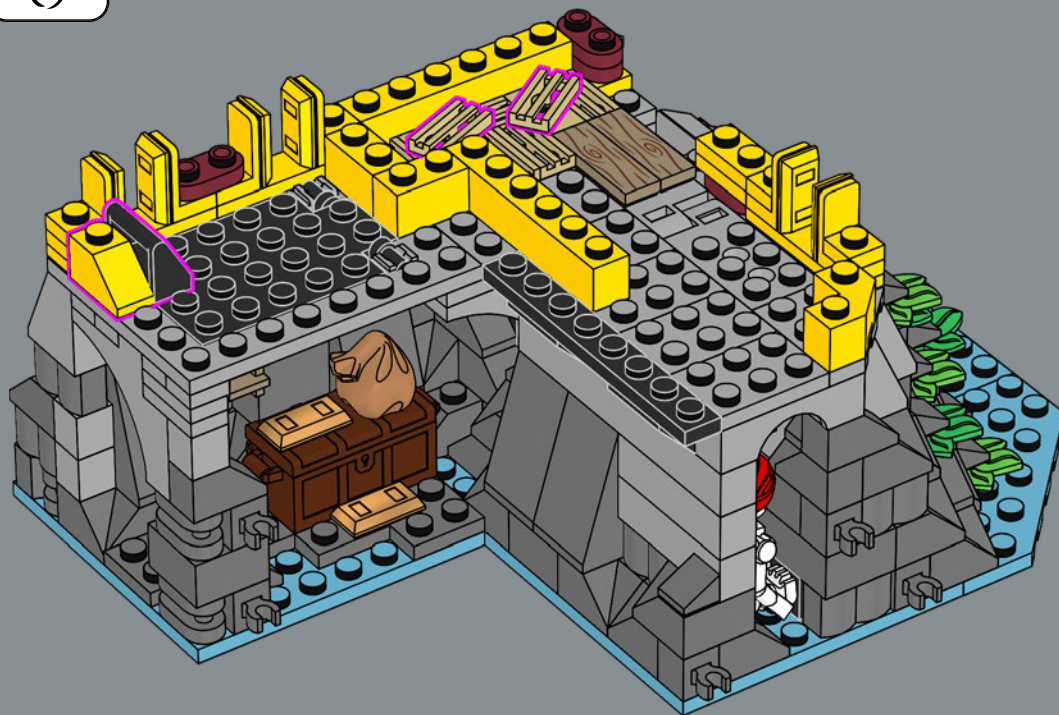



2x



2x



2x

61

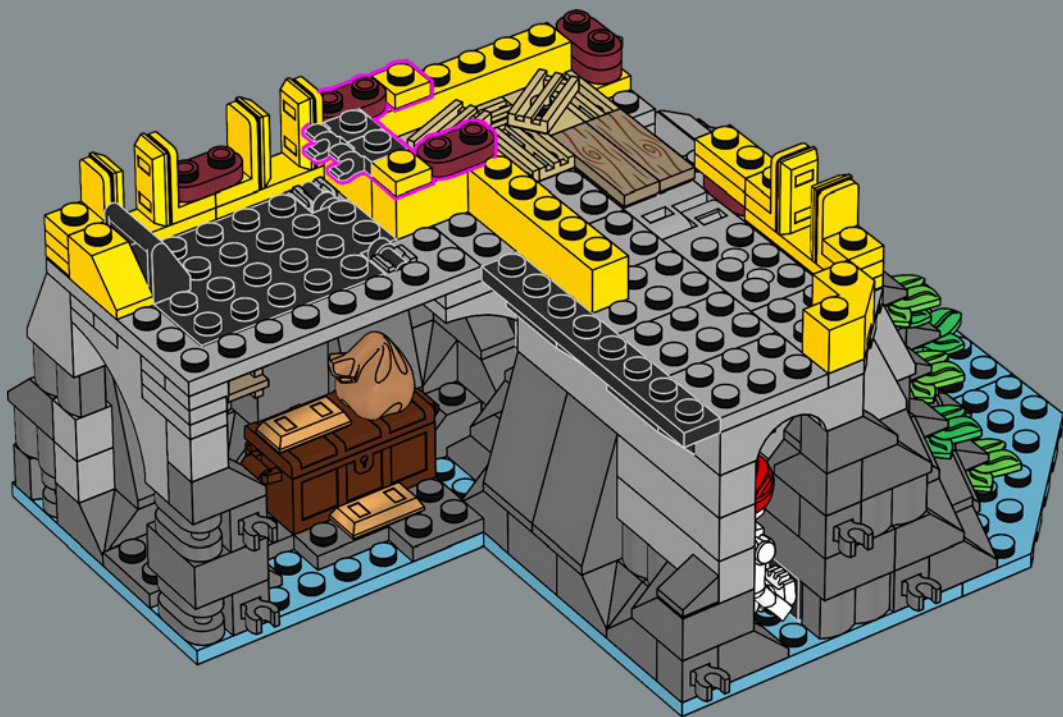



62

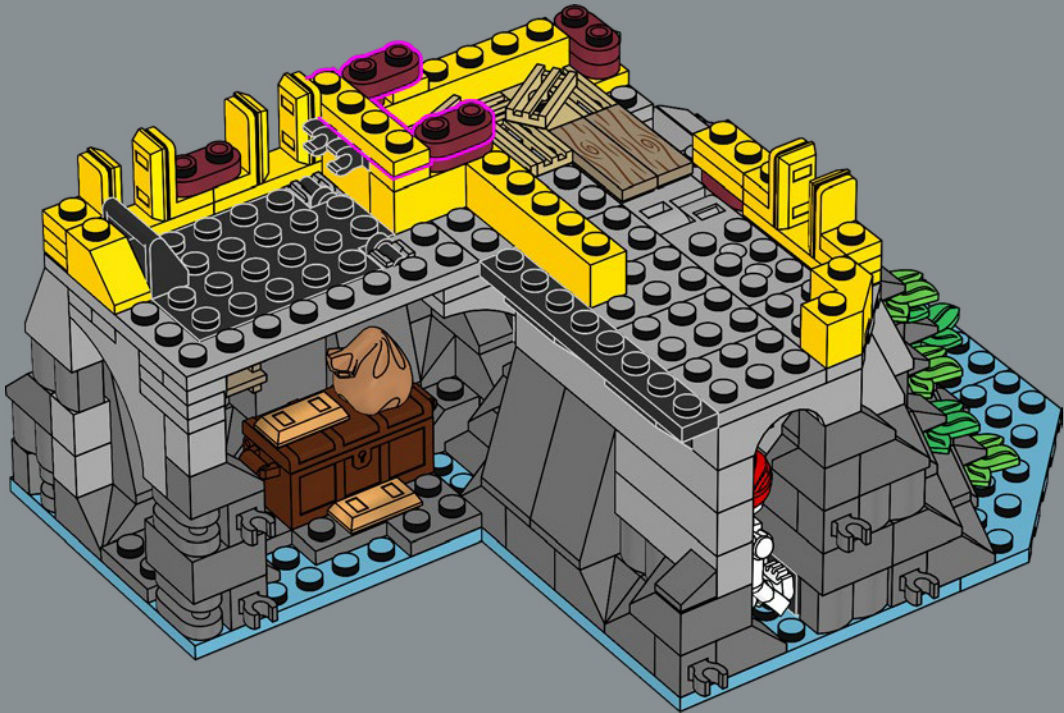

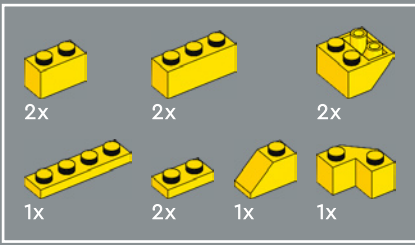

63

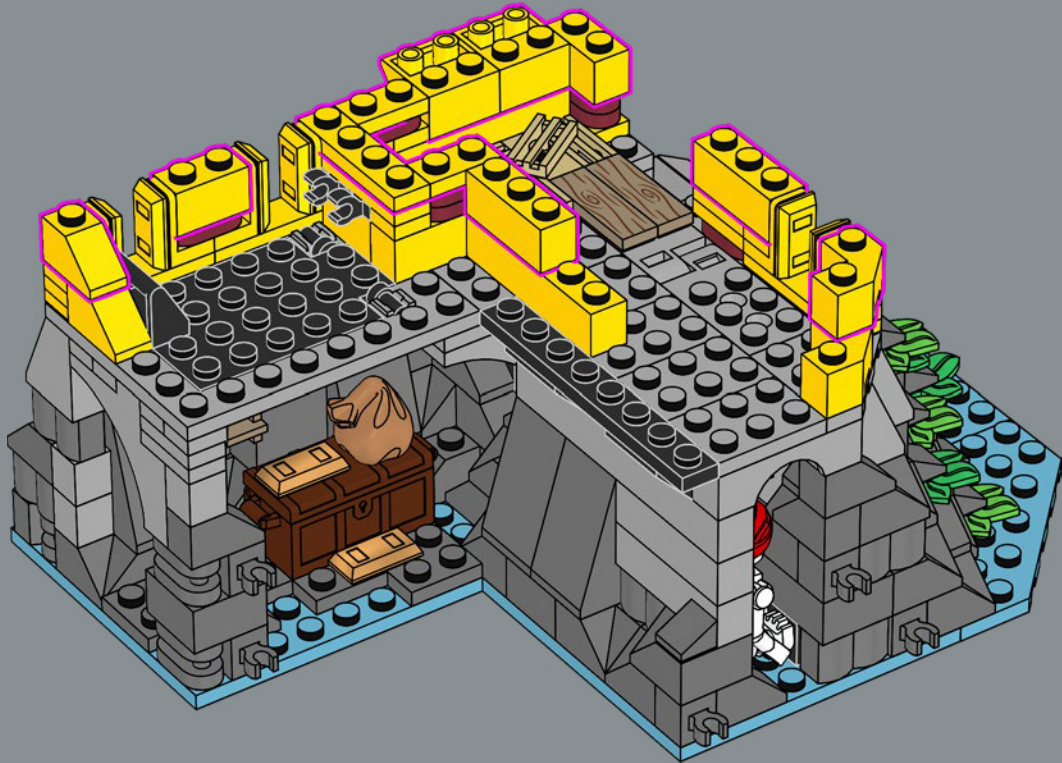



64

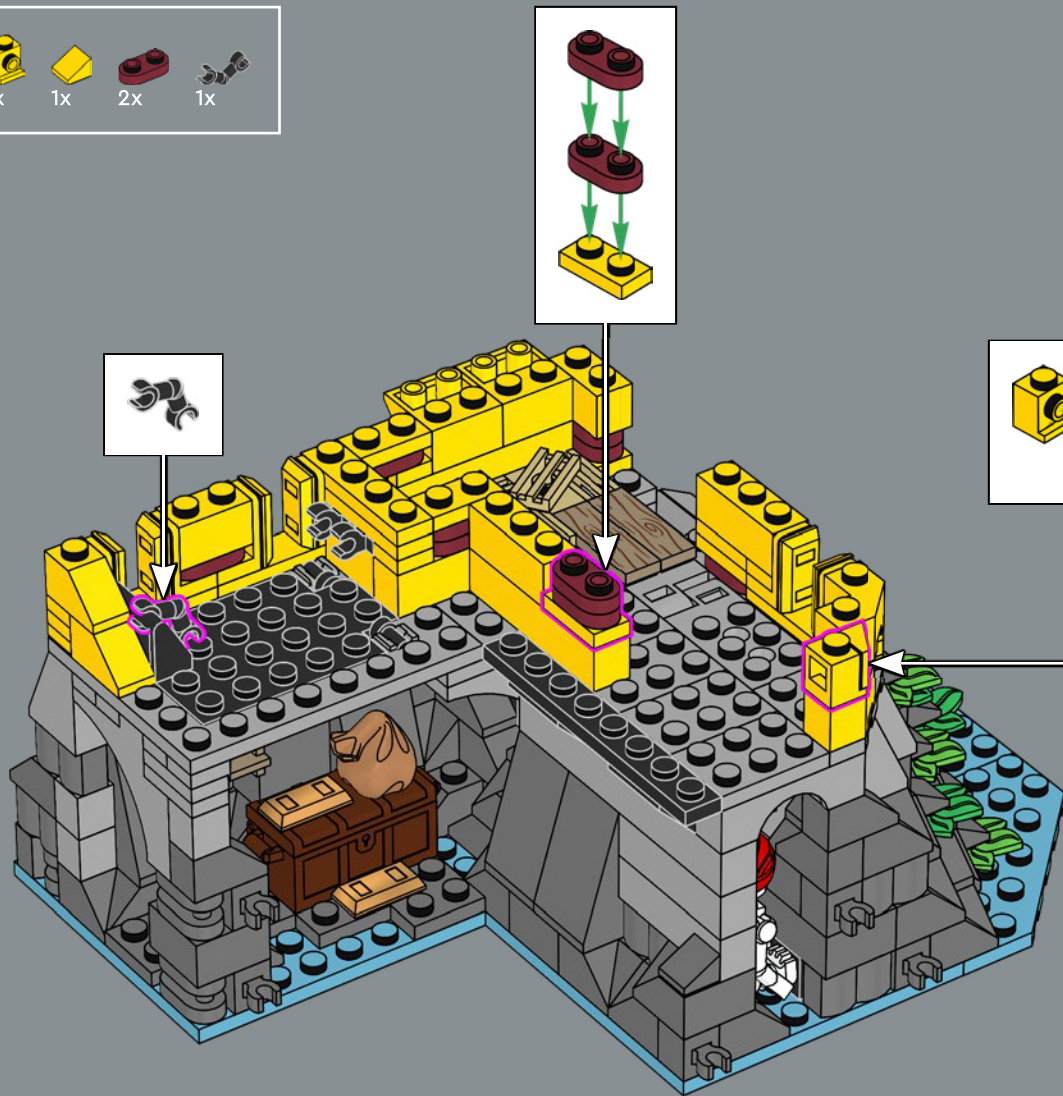

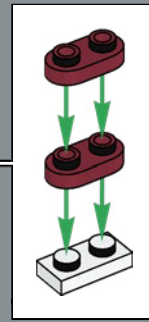
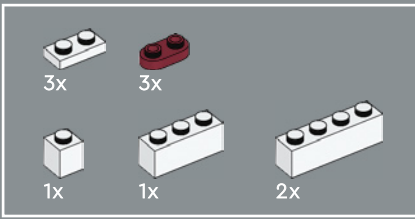

65

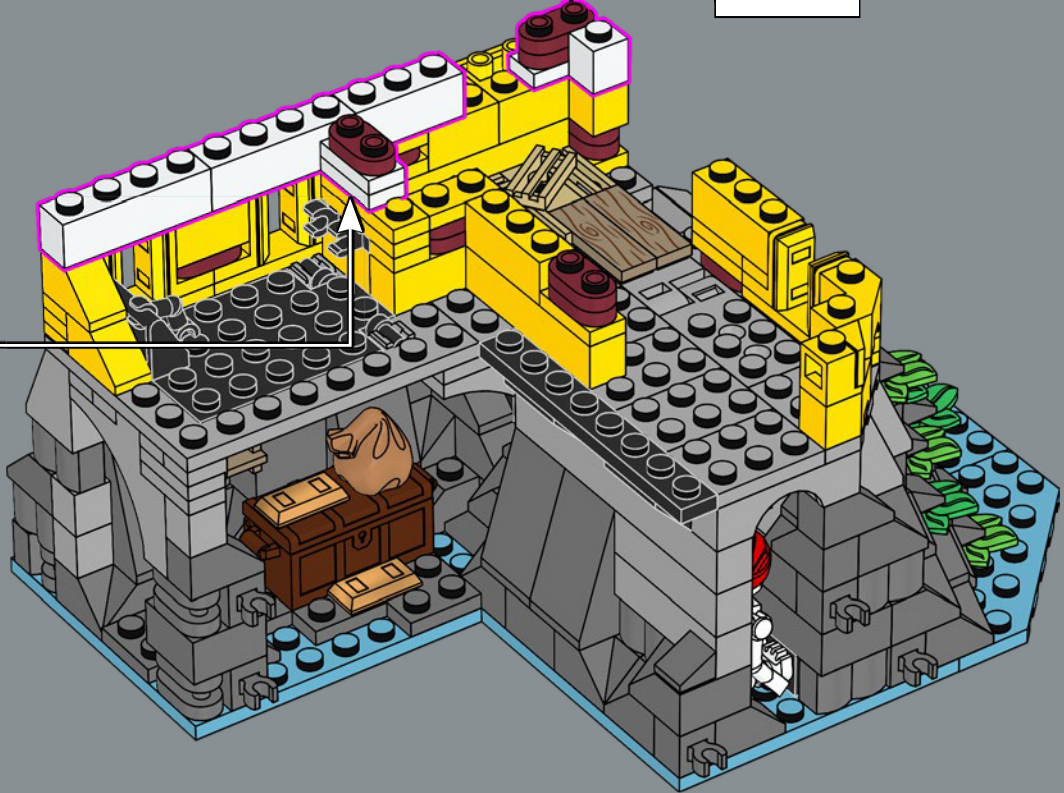
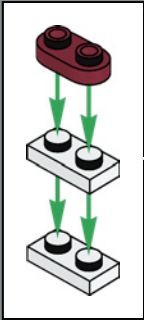

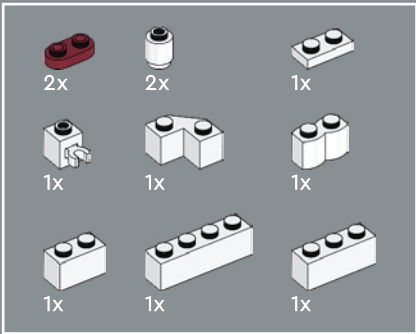

66

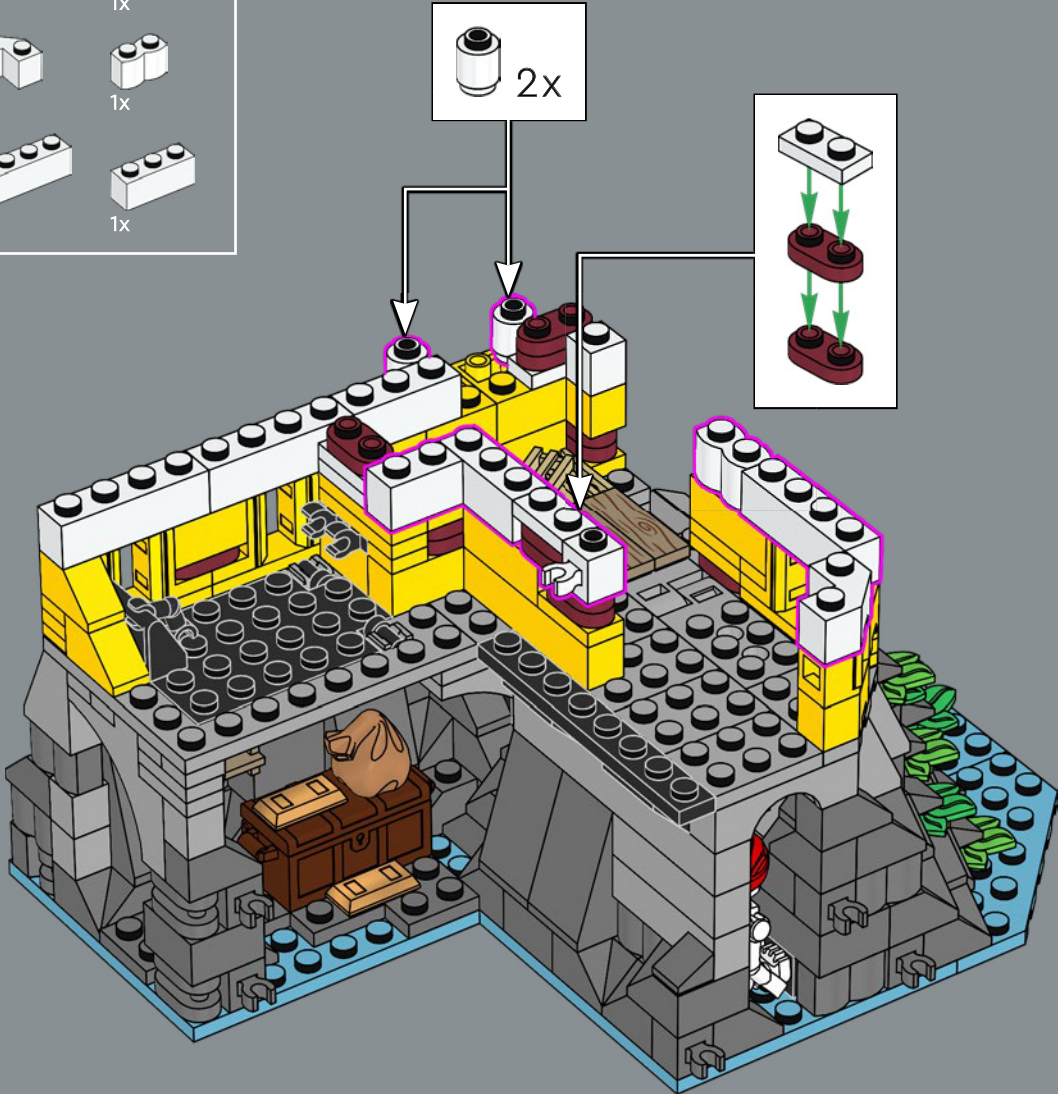
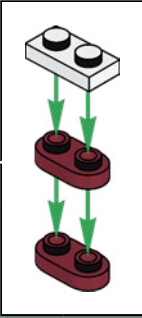
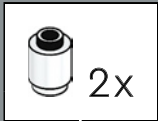

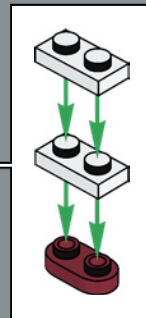
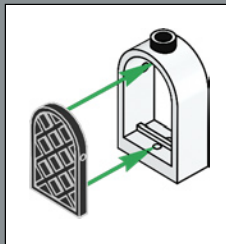
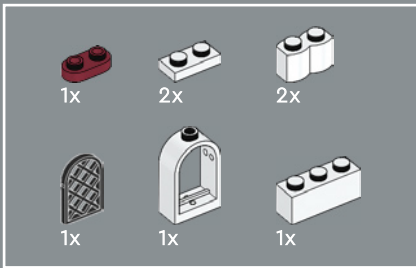

67

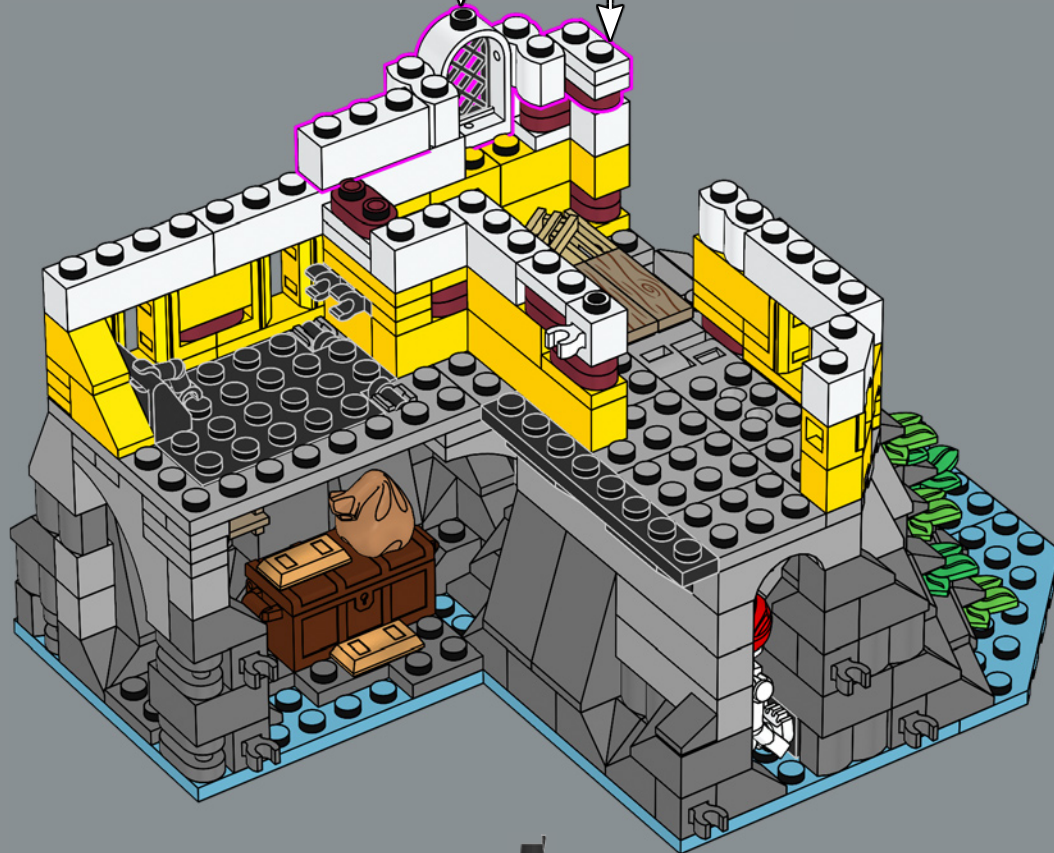

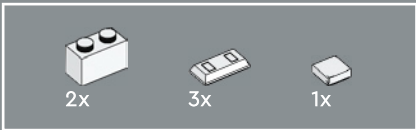

68

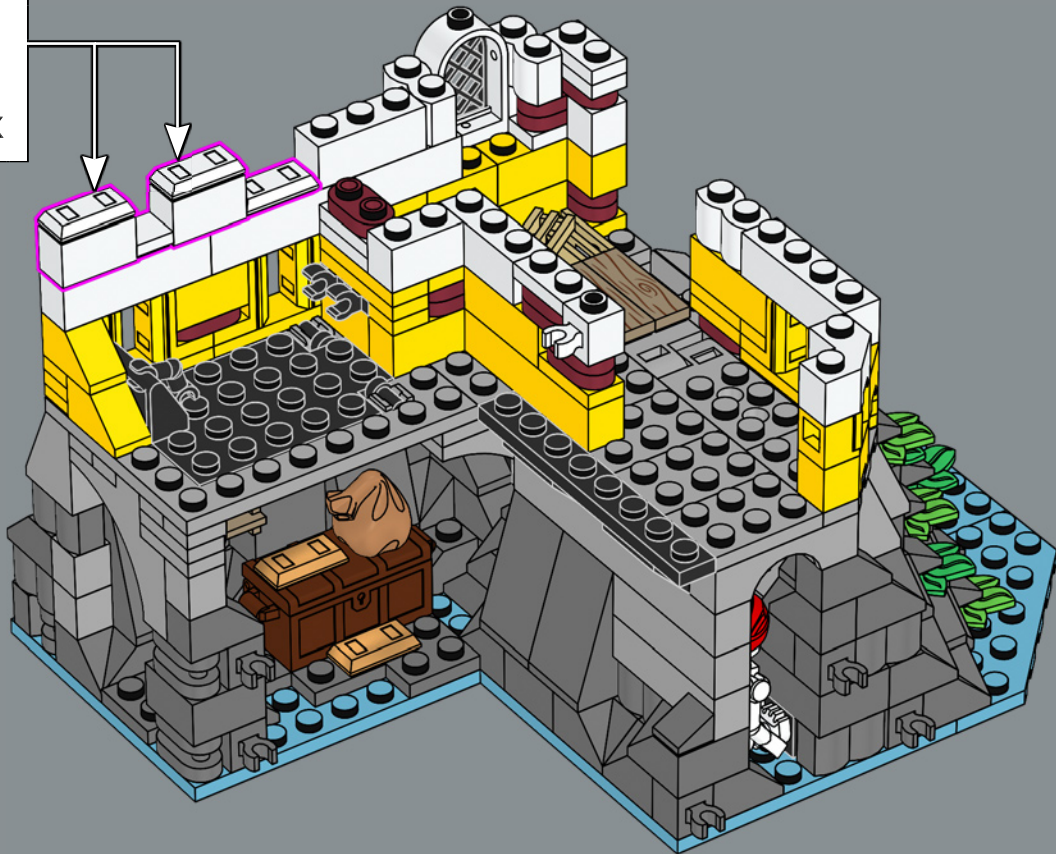
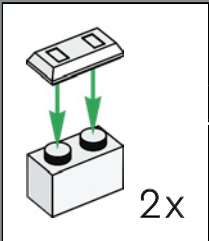

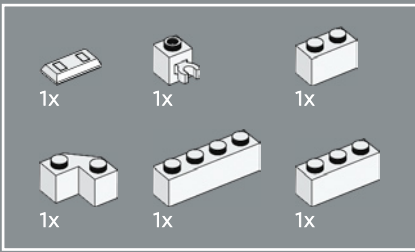

69

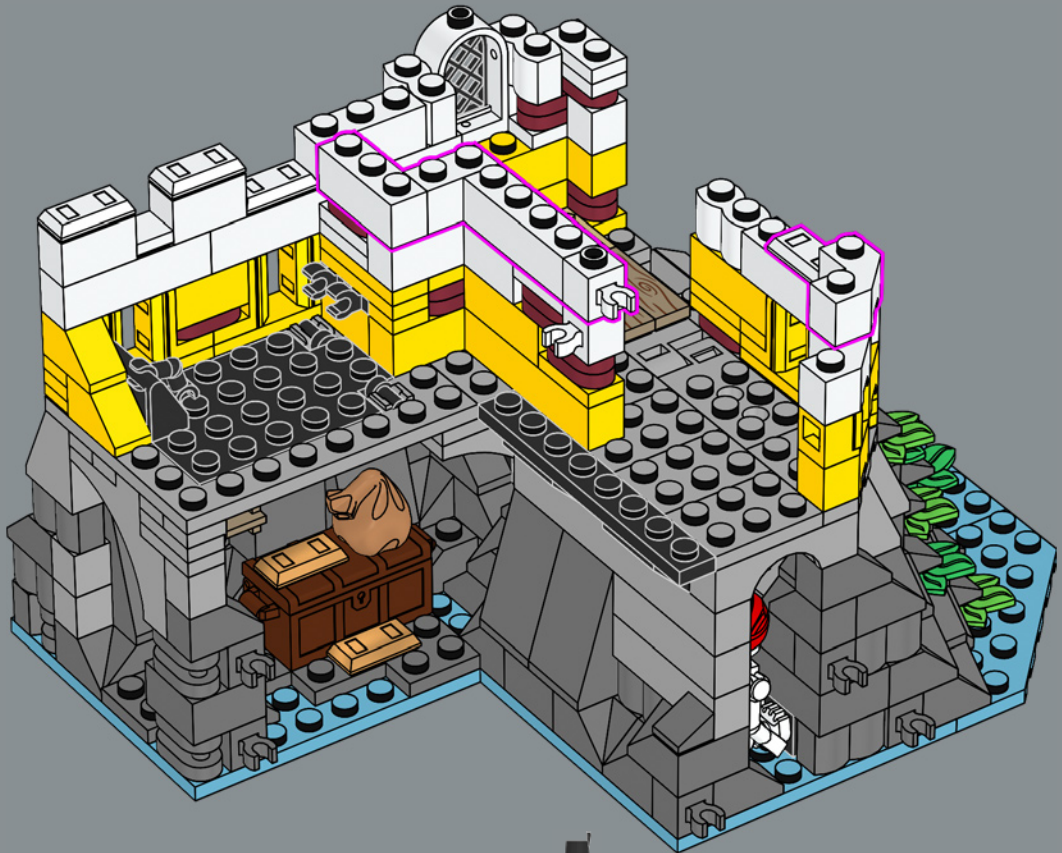

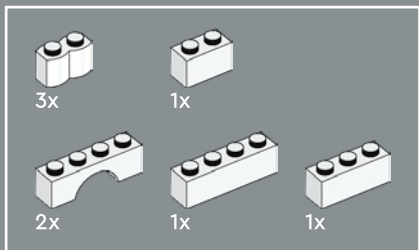

70



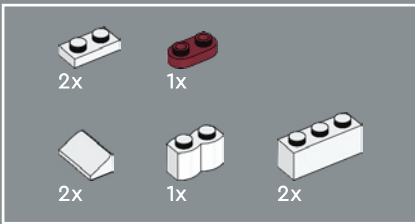

71

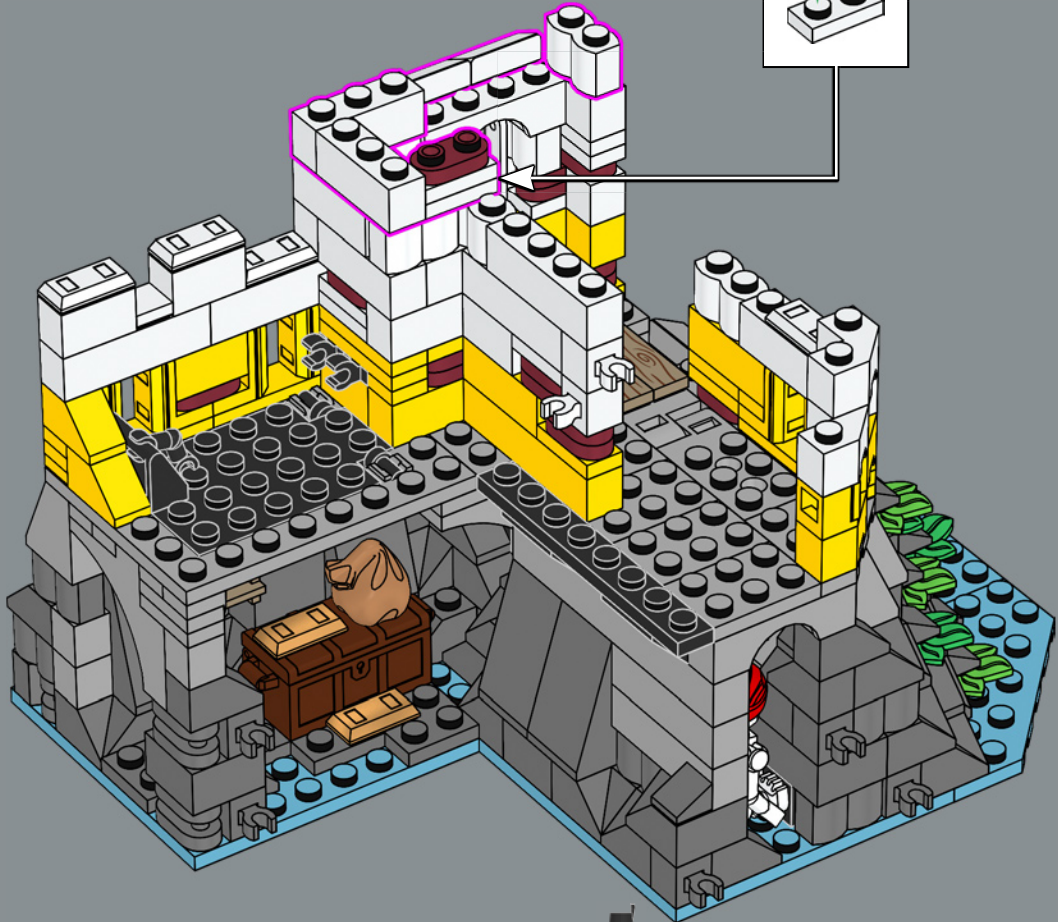
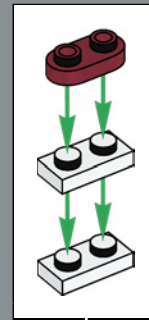

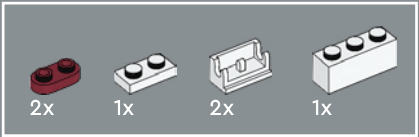

72

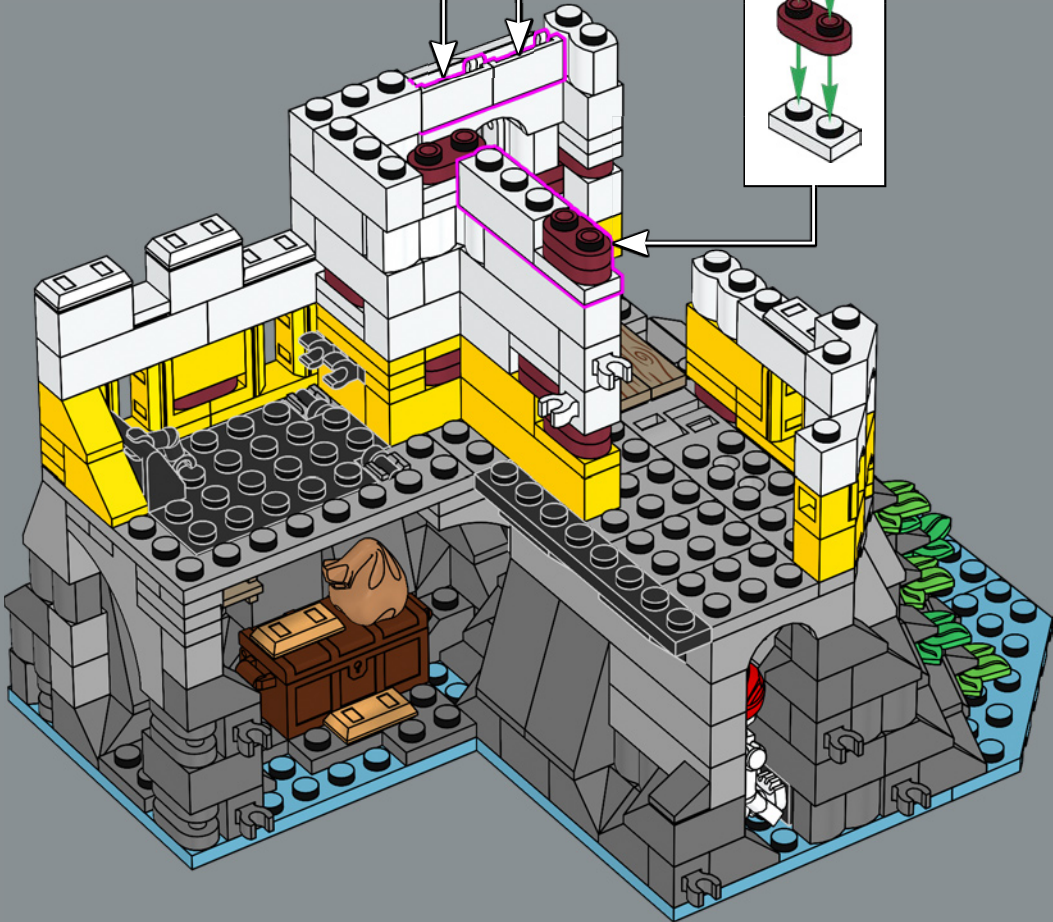
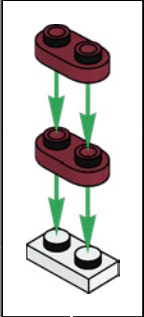
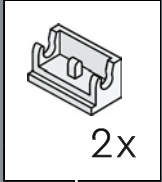

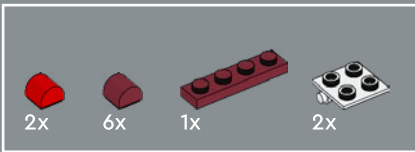

73

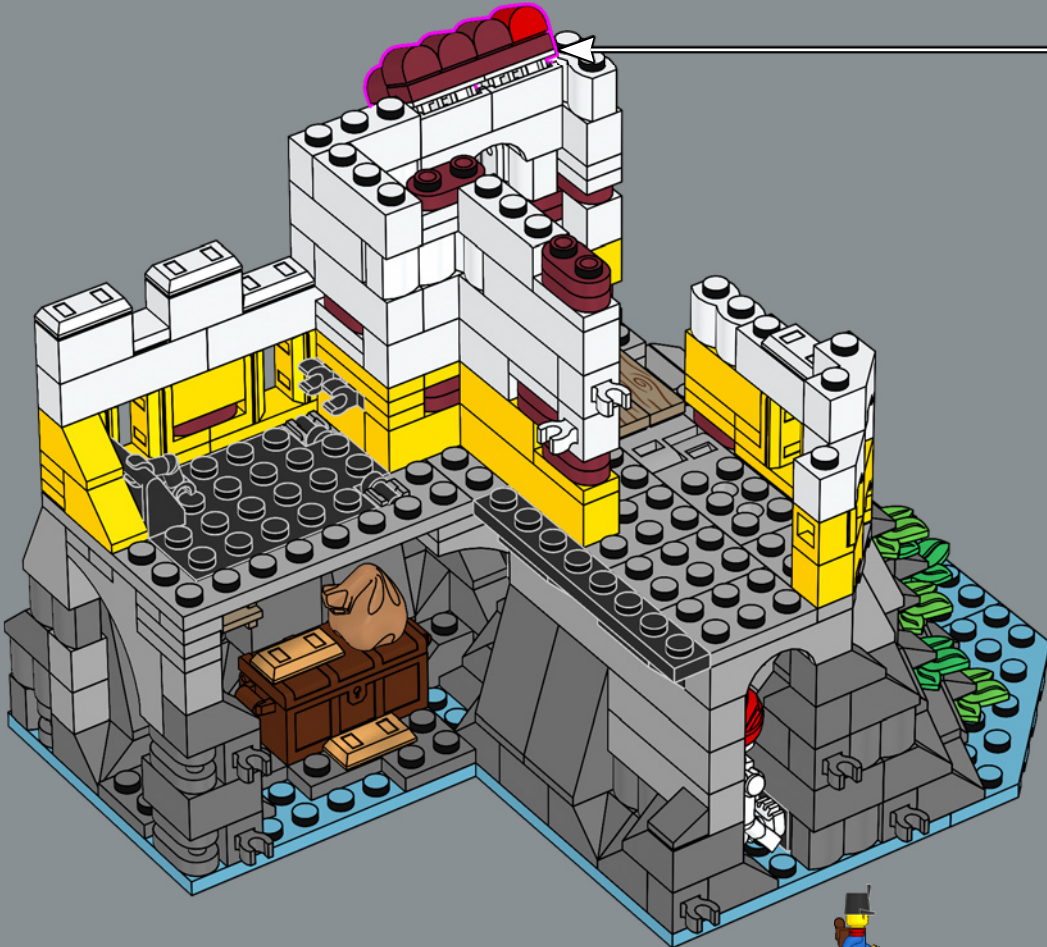
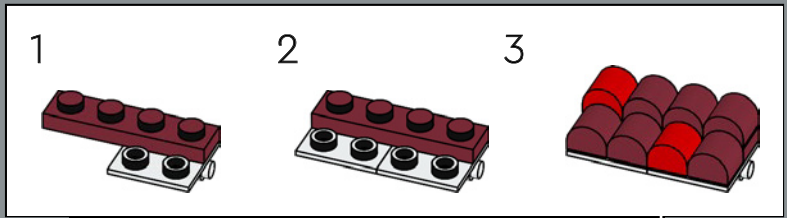

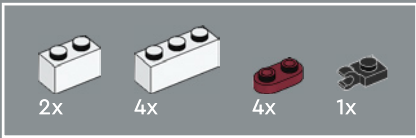

74

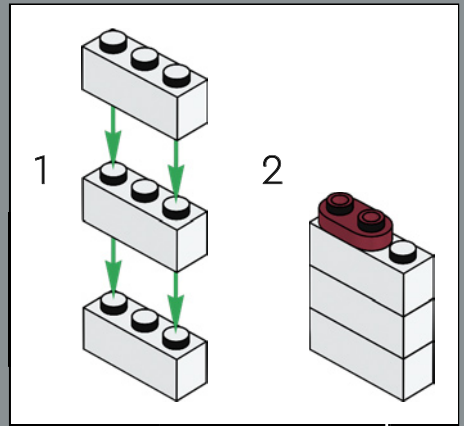
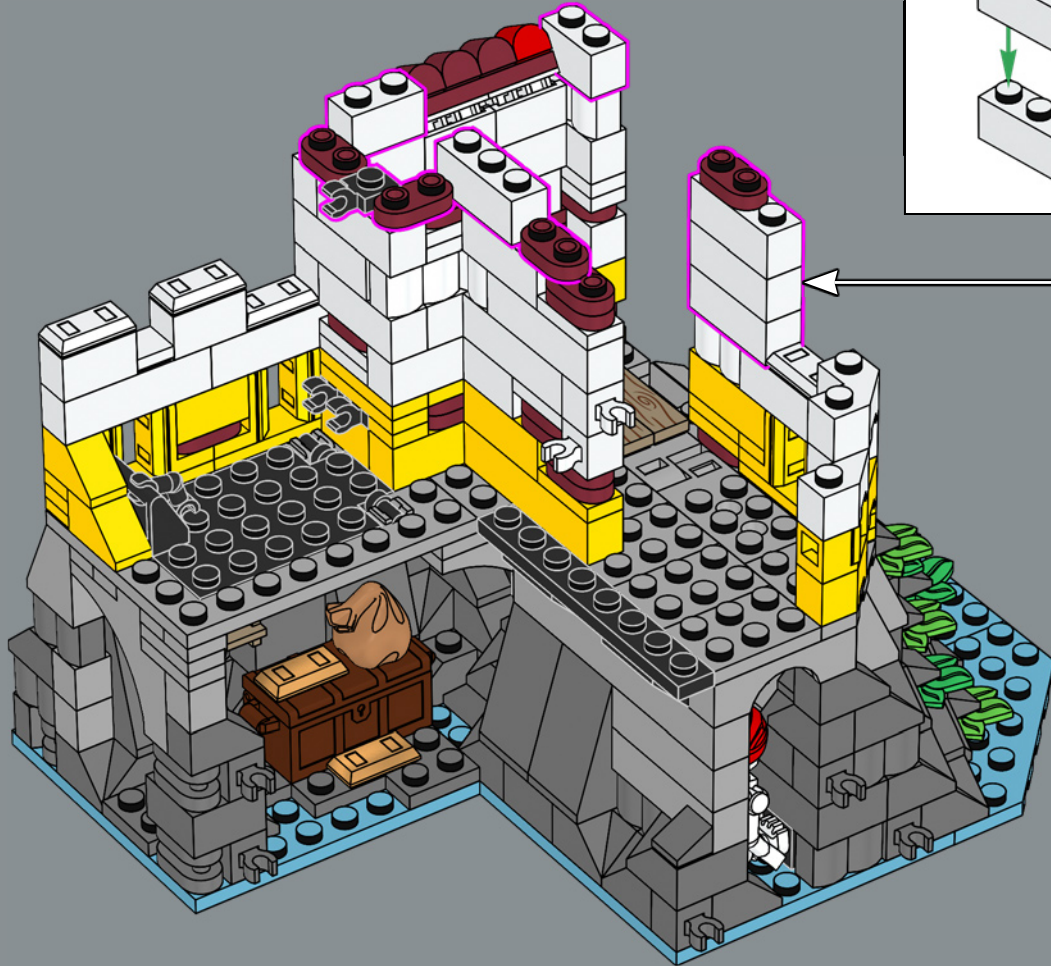

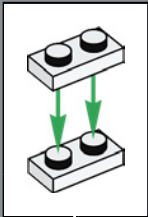
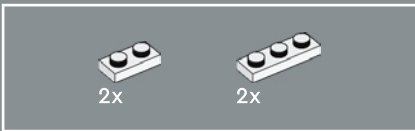

75

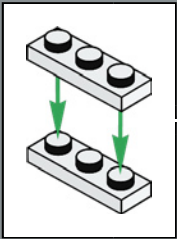

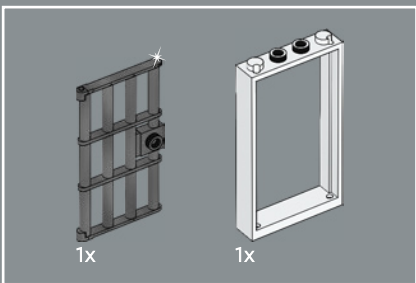

76

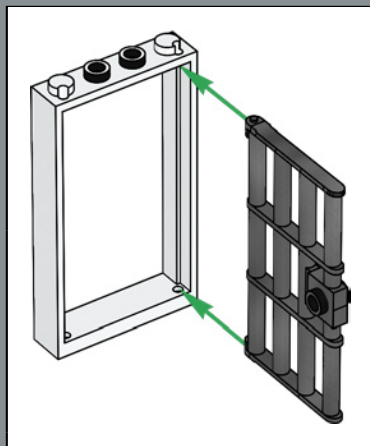

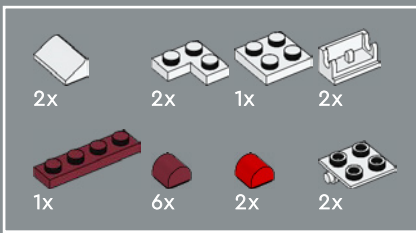

77

1



2

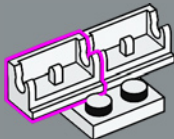

3

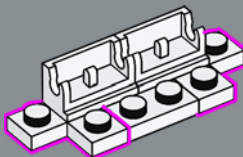

4

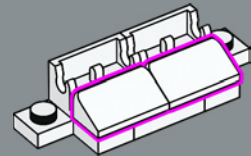

5

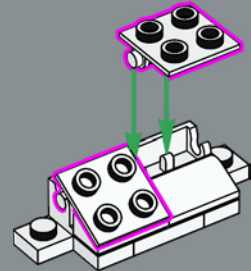

6

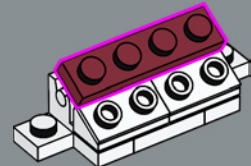

7

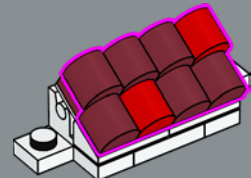

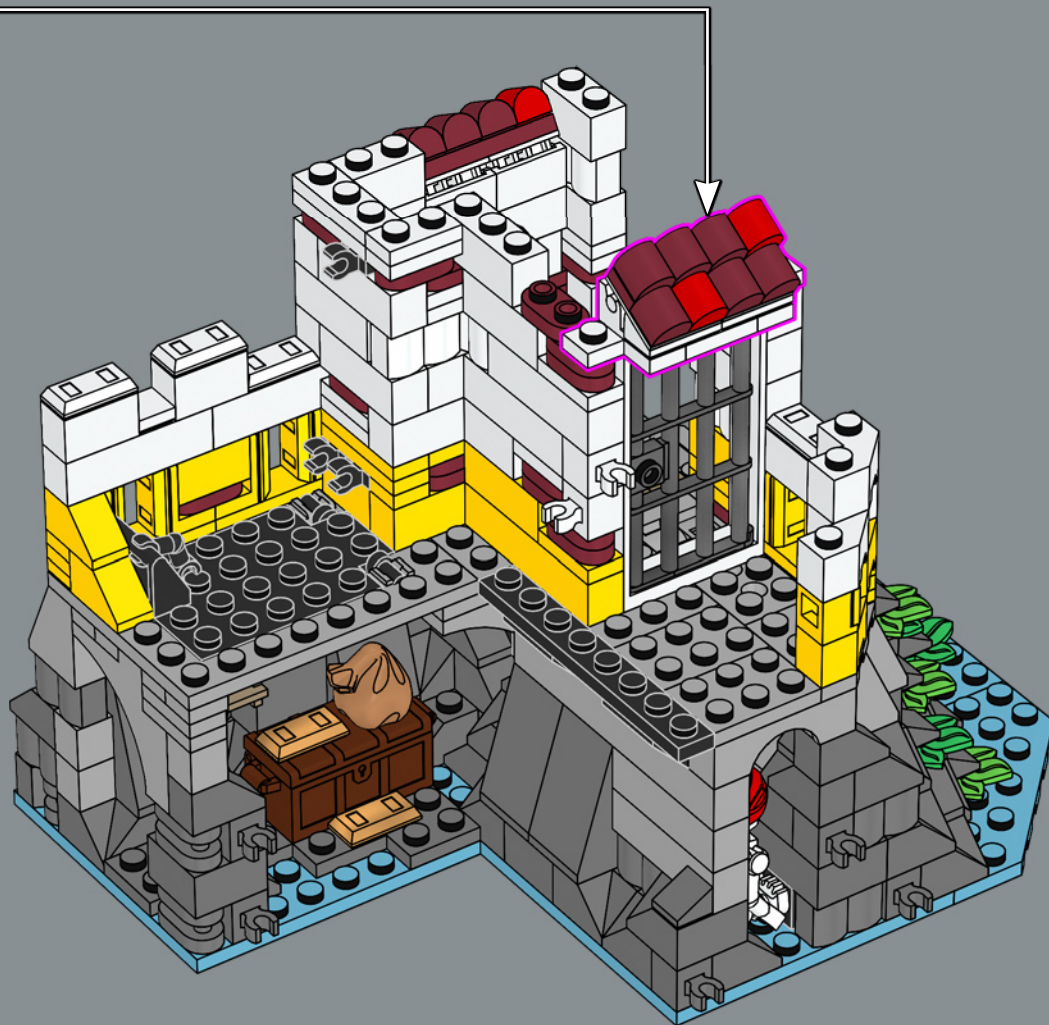



78

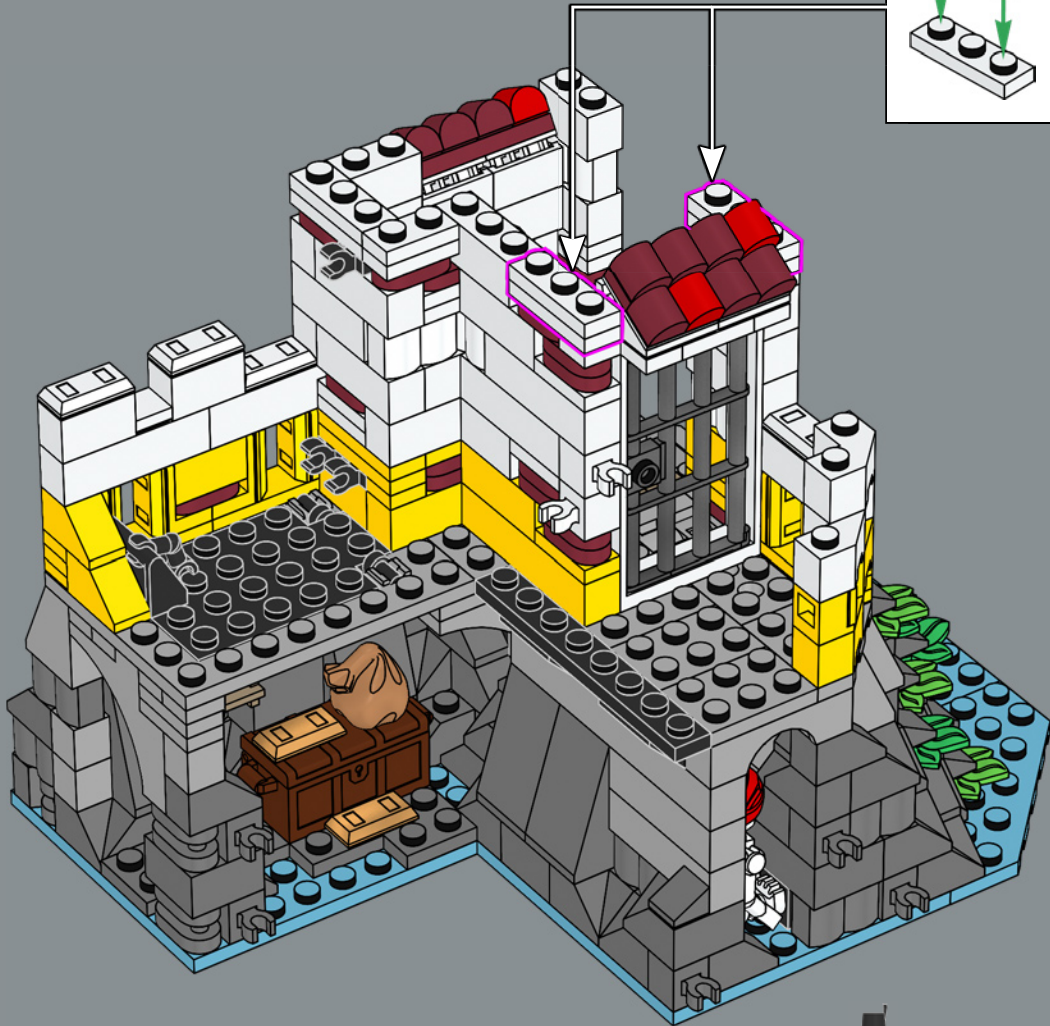
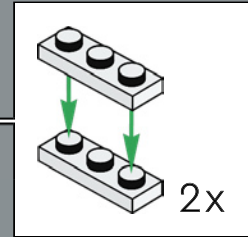

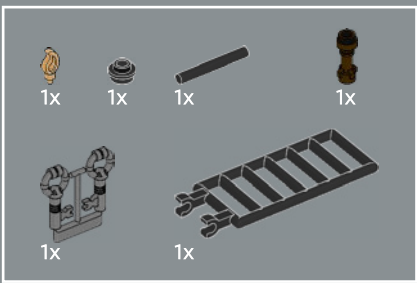

79

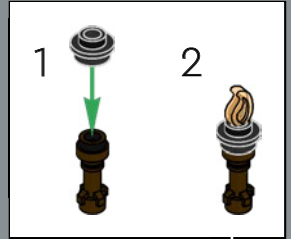
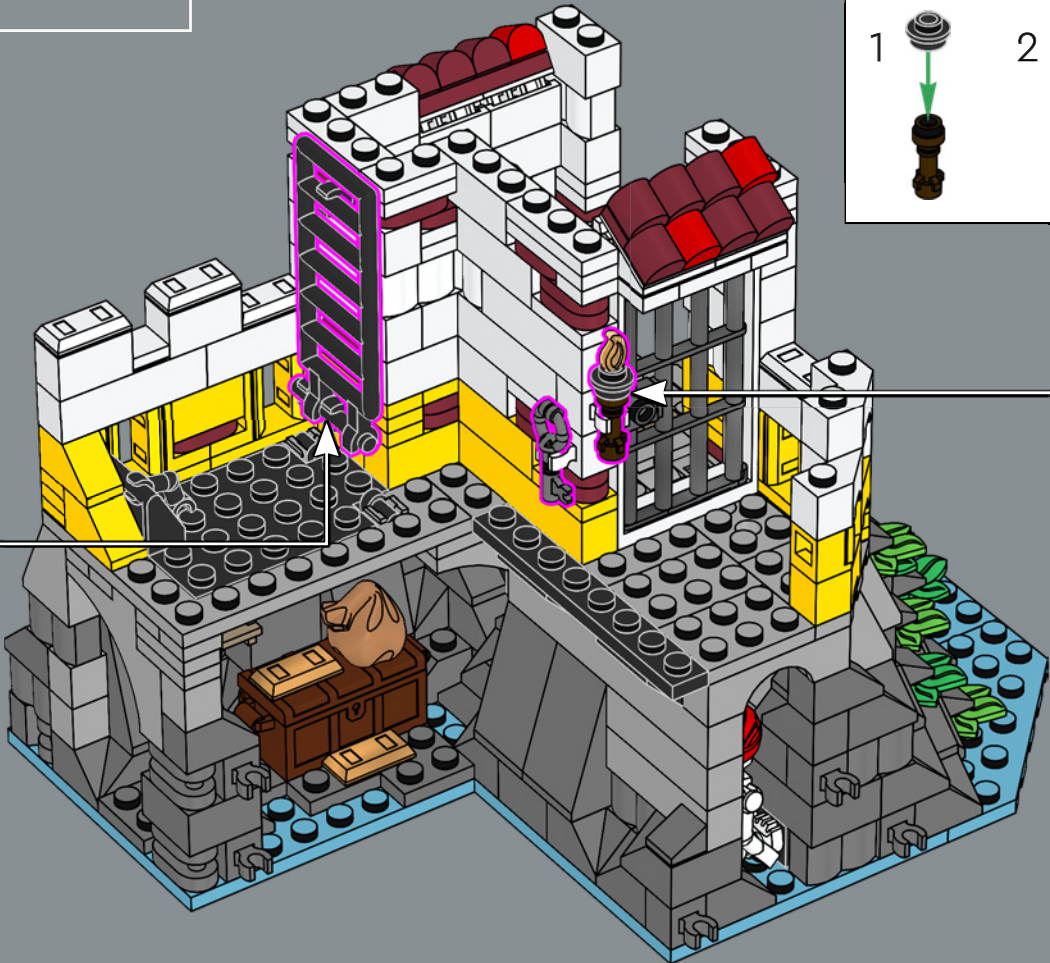
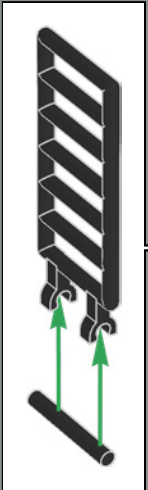

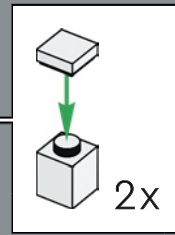
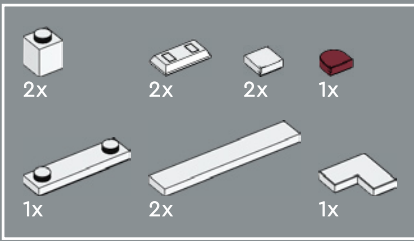

80

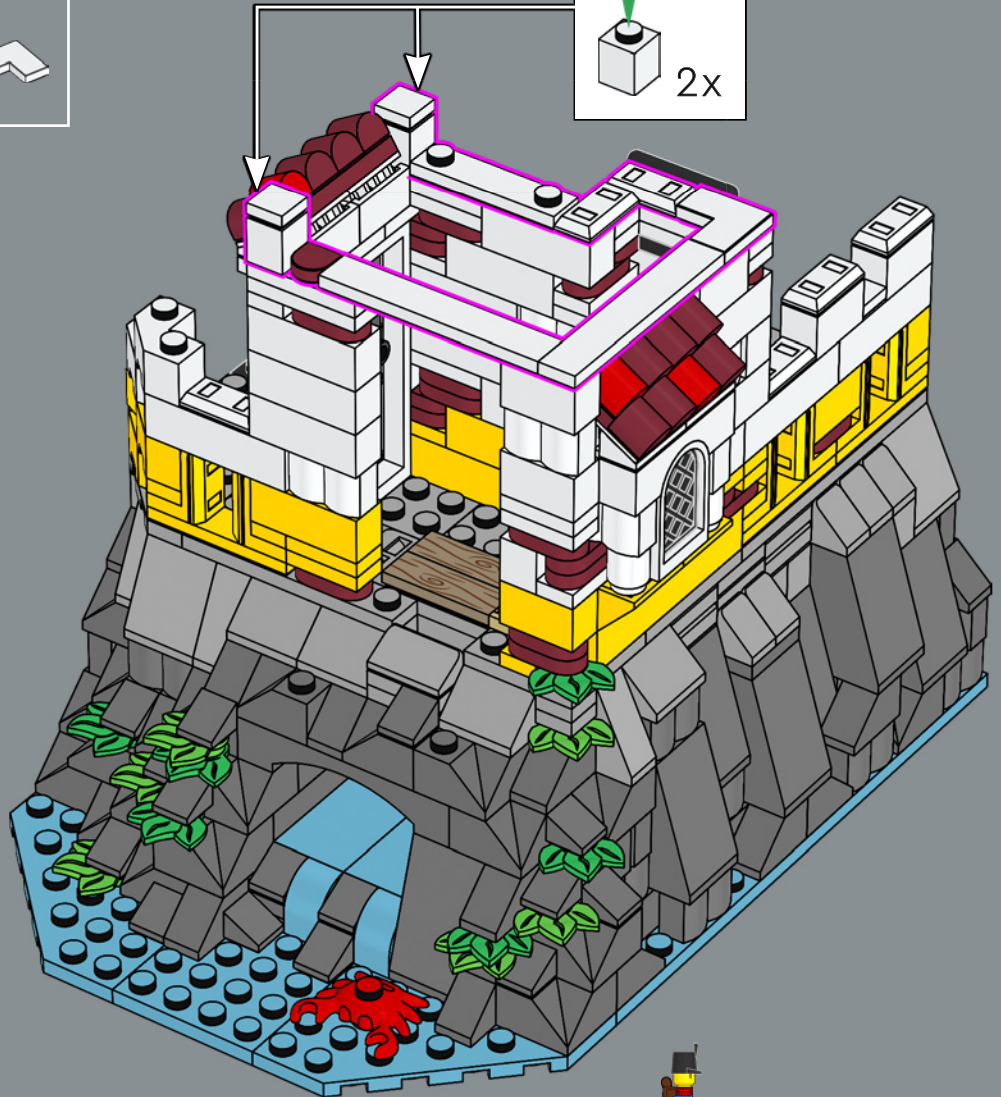

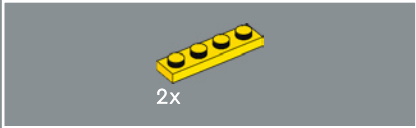
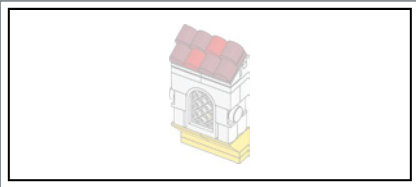

81

2x

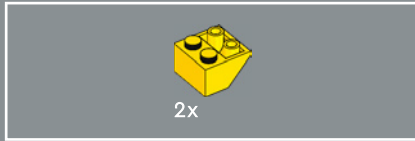
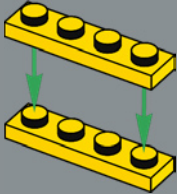

2x

82

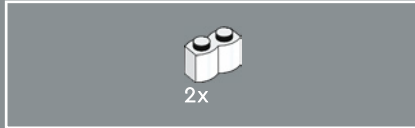
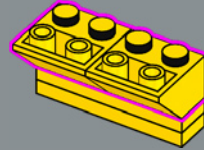

2x

83

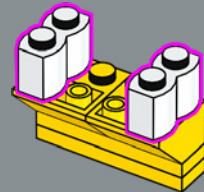

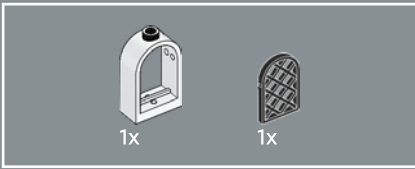

84

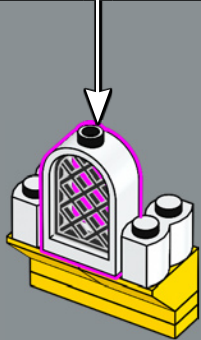
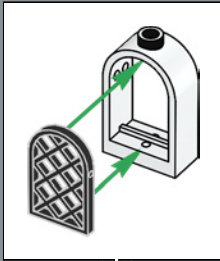

85

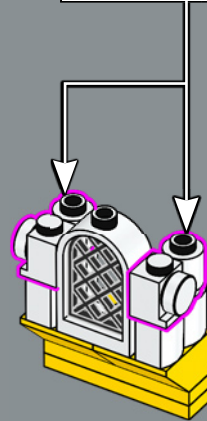
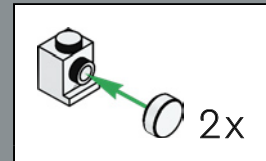

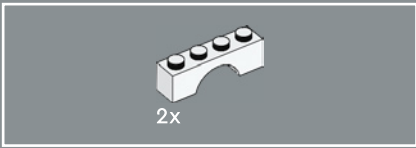

86

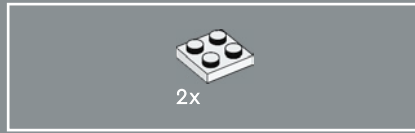
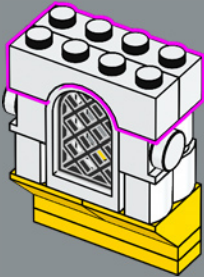

87

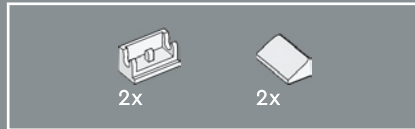
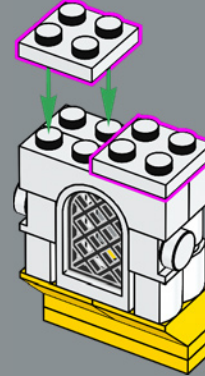

88

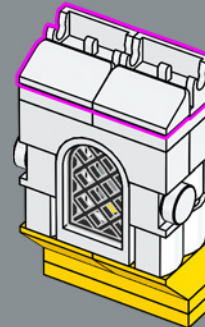



89

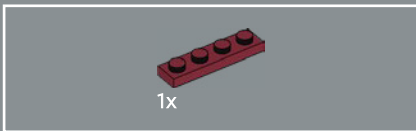
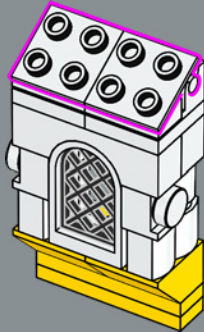

90



91





The roof and some of the windows can be removed to access the rooms inside.

Le toit et certaines des fenêtres peuvent être retirés pour accéder aux pièces intérieures.

El techo y algunas de las ventanas se pueden quitar para acceder a las habitaciones del interior.

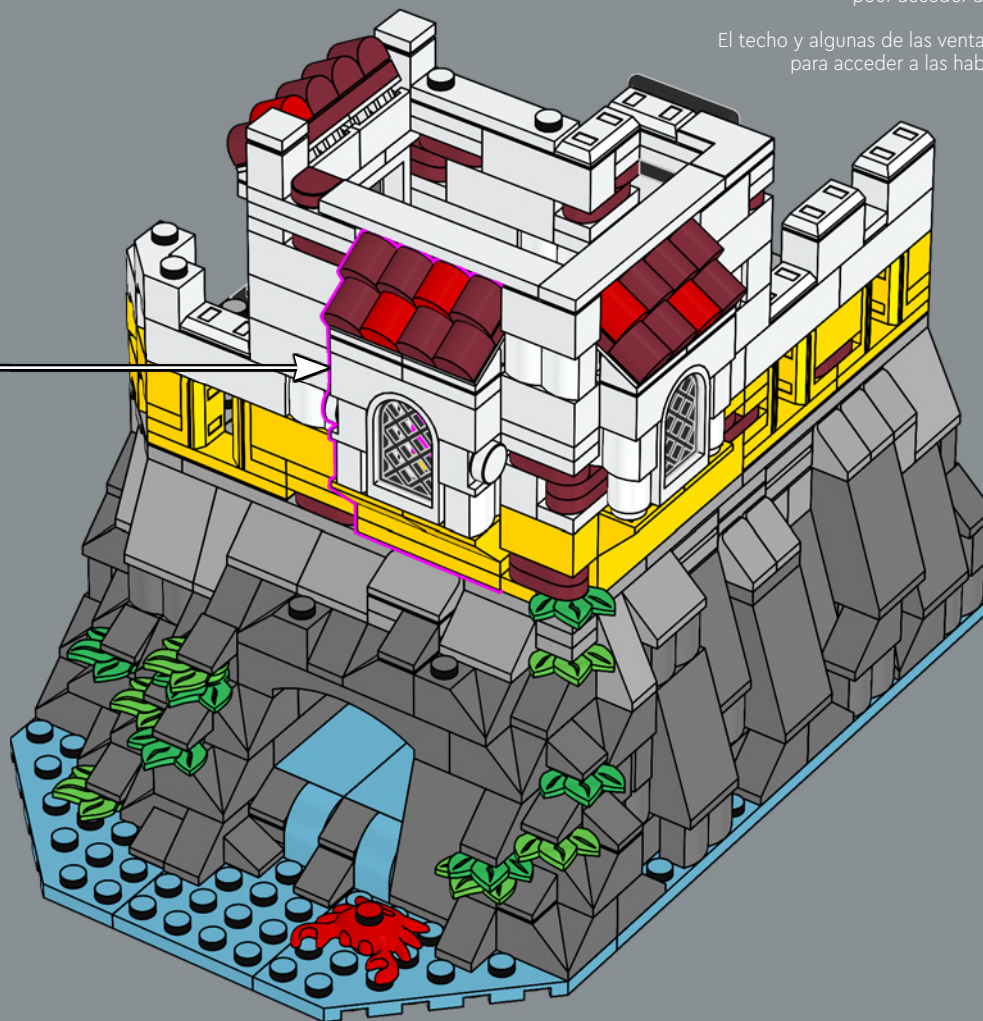

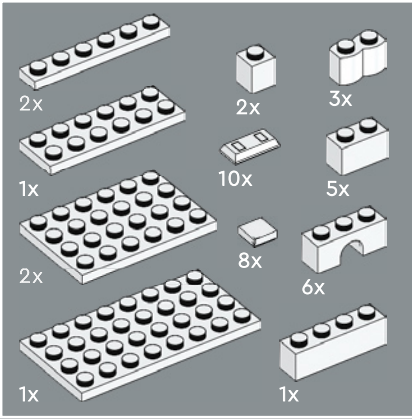
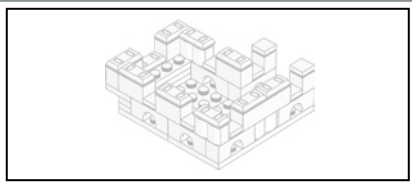

93

1

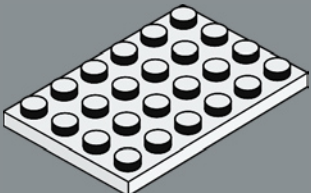

2

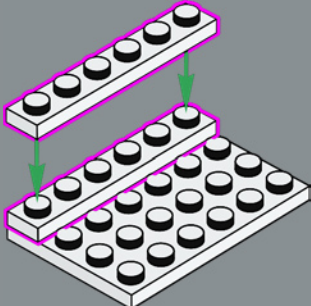

3

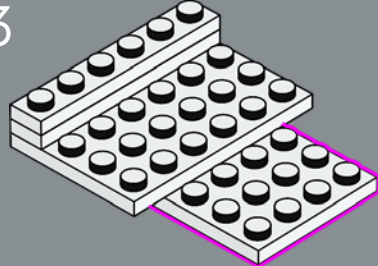

4

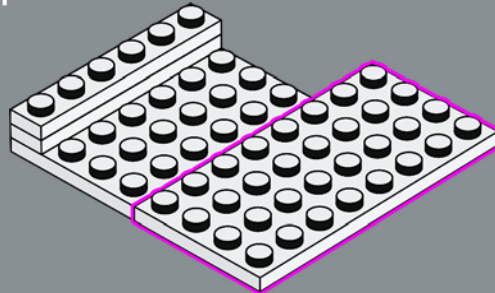

5

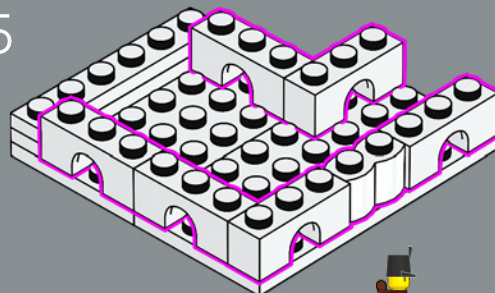

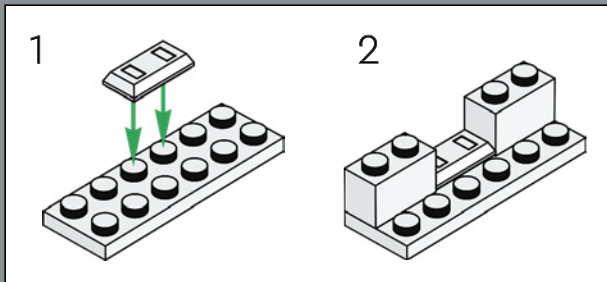

6

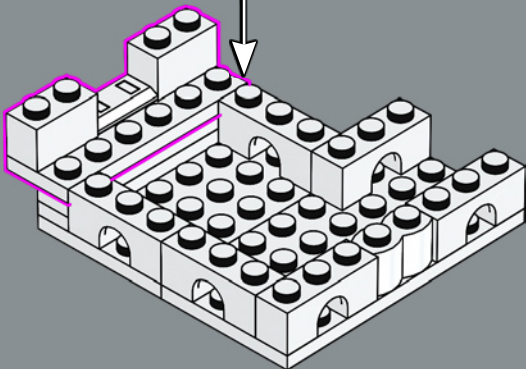

7

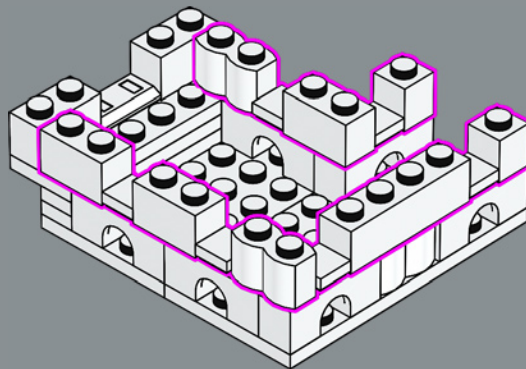

8

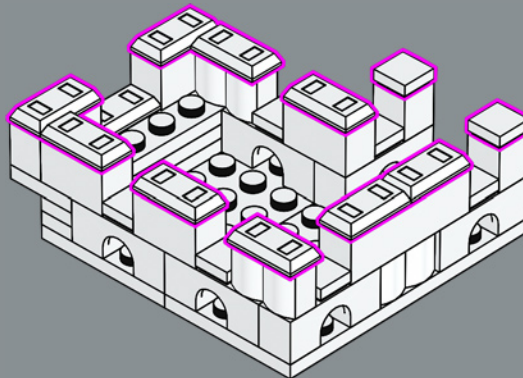

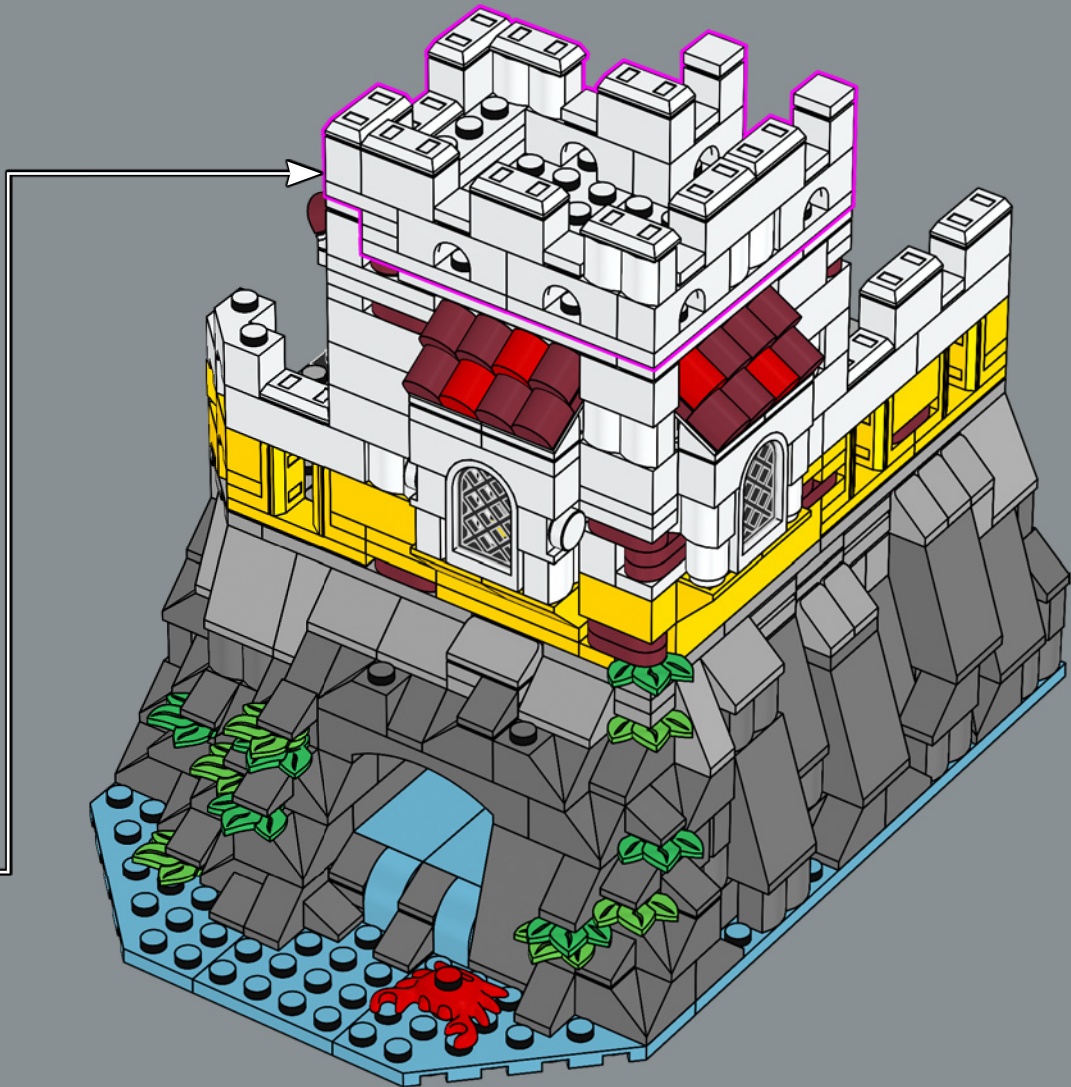



94

The model unfolds for a bigger and more detailed display of all the trials, tribulations and merriment of the crew (and their prisoners).

Le modèle se déploie pour mieux exposer les épreuves, les tribulations et les réjouissances de l'équipage (et de ses prisonniers).

El modelo se despliega para exhibir en mayor tamaño y detalle todas las penas y alegrías de los ocupantes (y sus prisioneros).



1

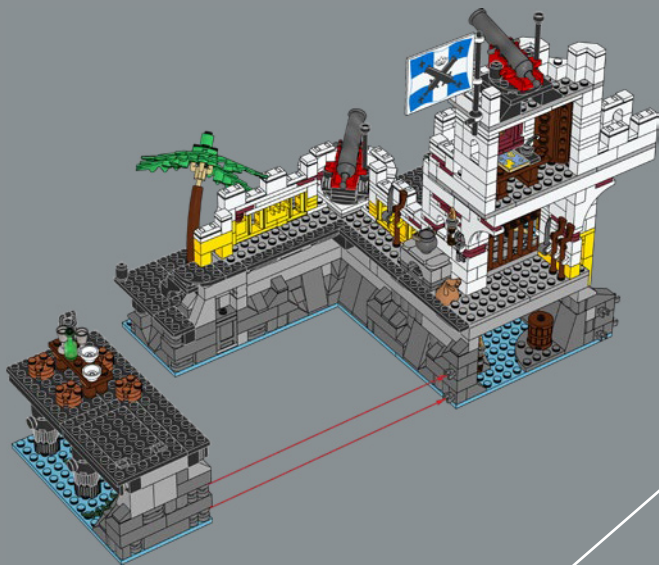

2

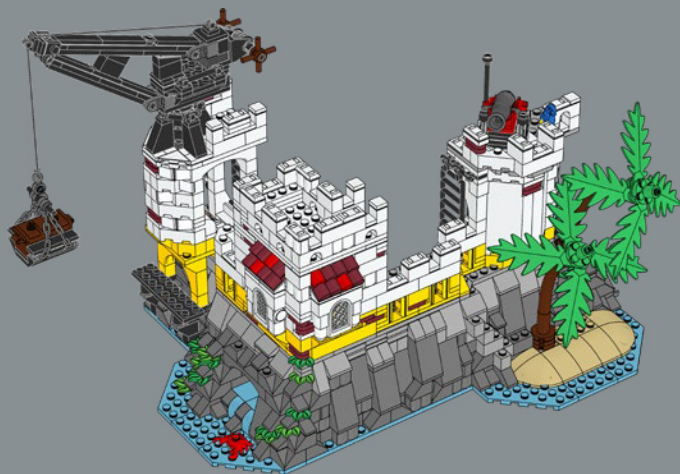
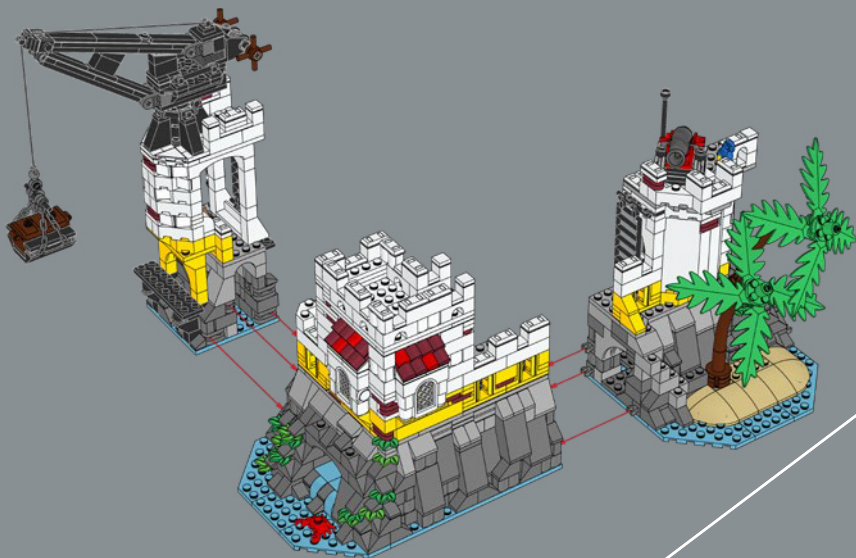

3



