

1

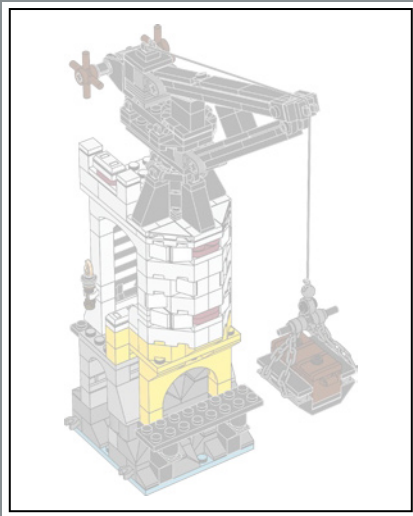

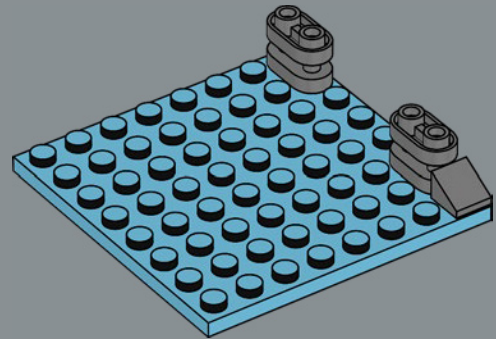

2

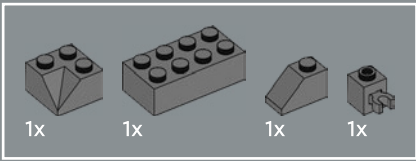
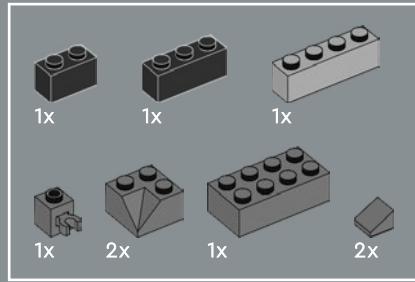
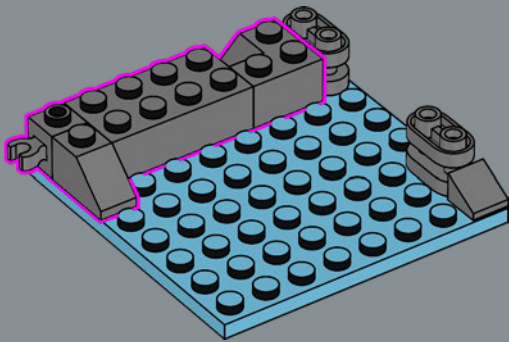

3

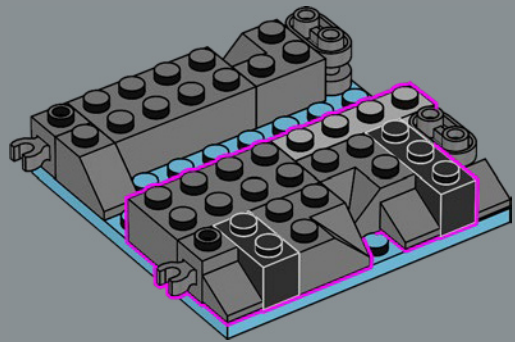



4

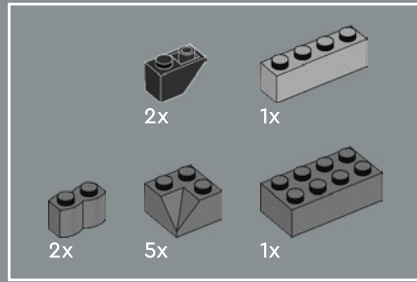
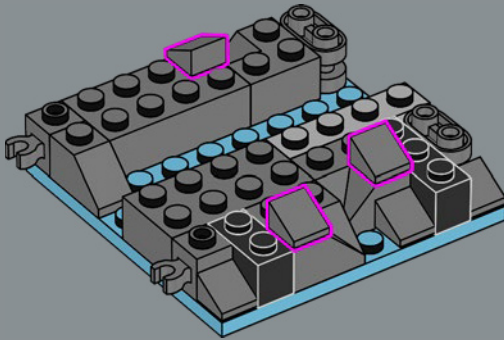

5

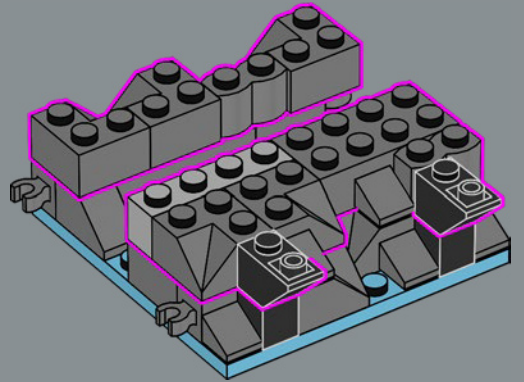



6

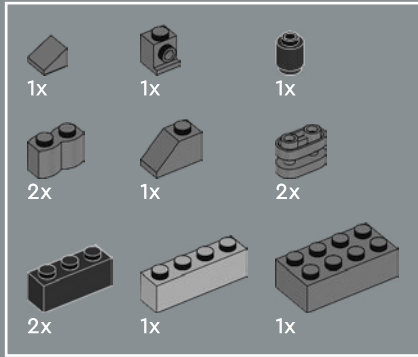
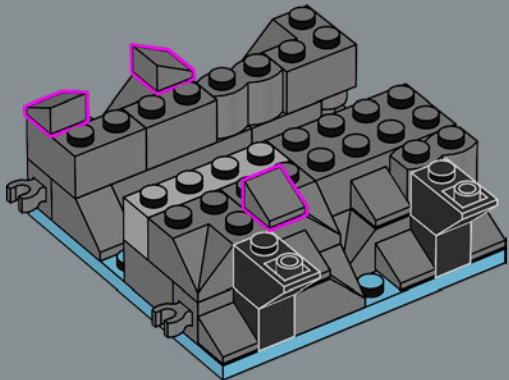

7

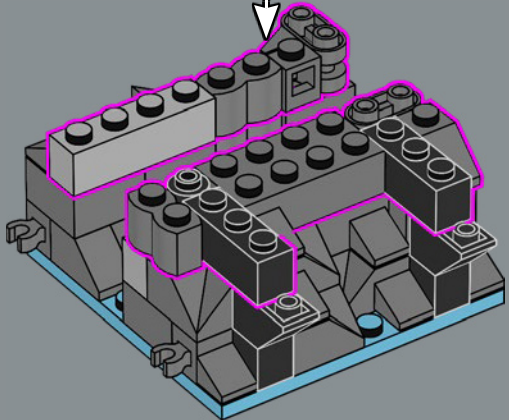
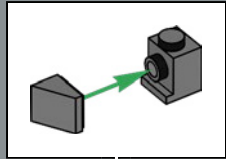

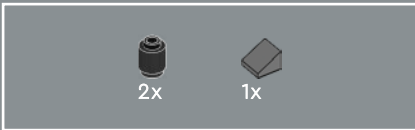

8

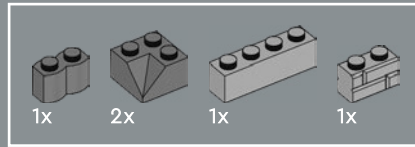
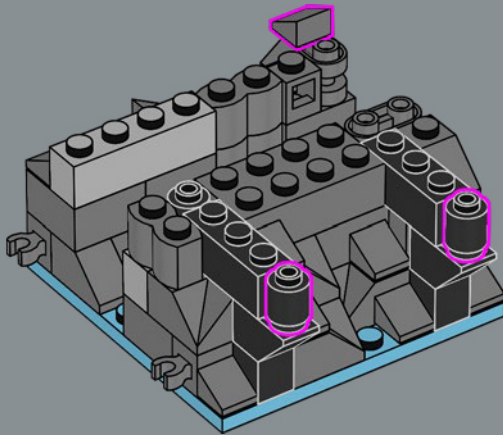

9

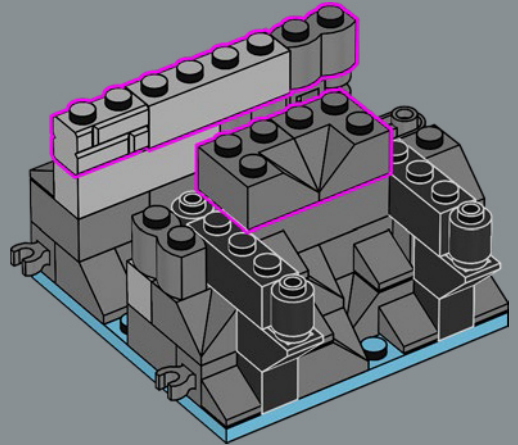

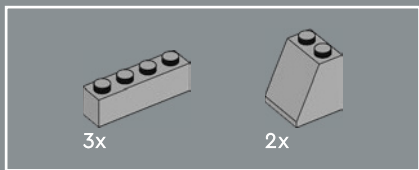

10

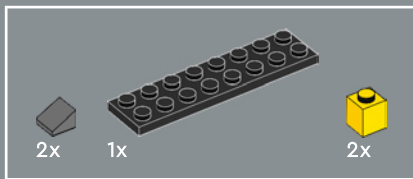
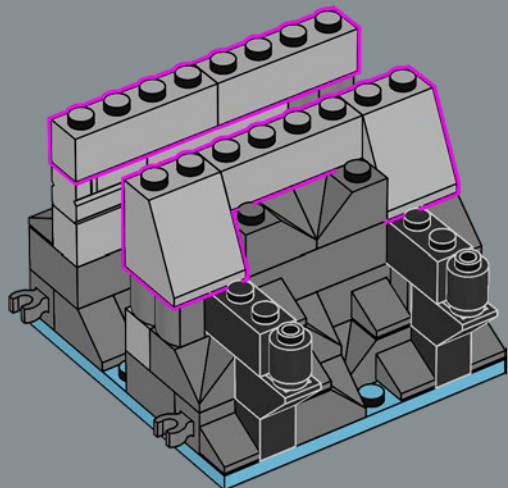

11

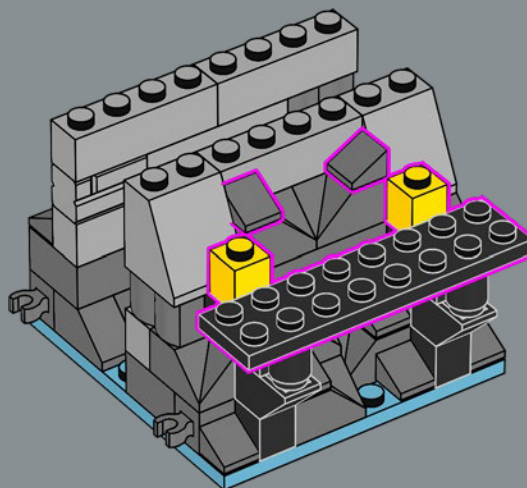



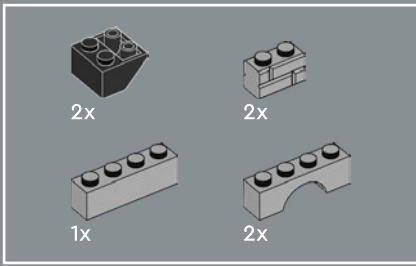

12

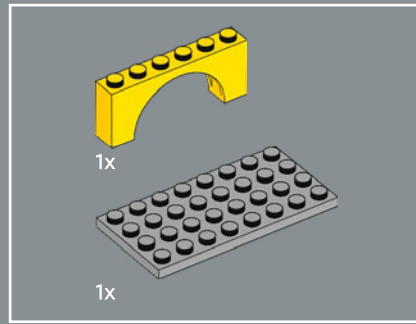
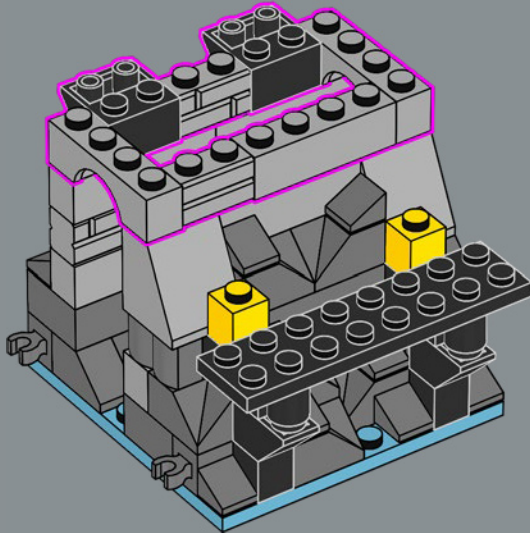

13

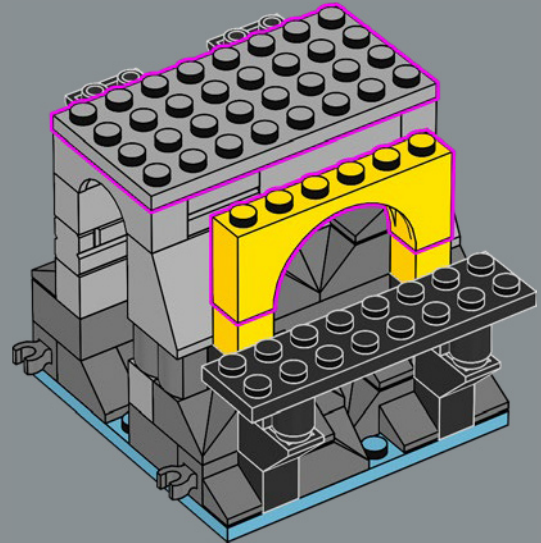

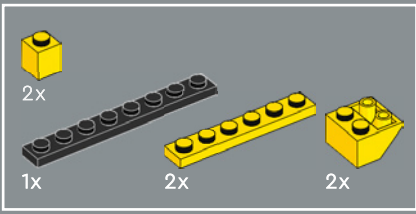

14

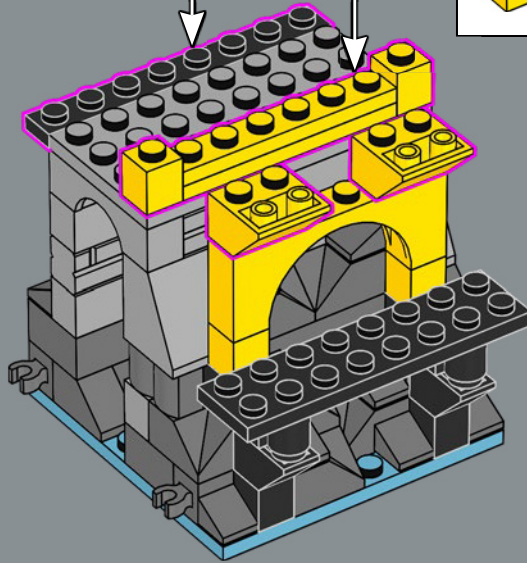
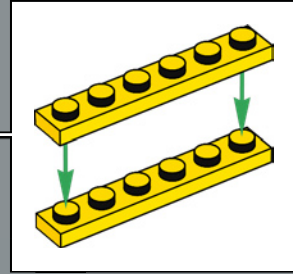
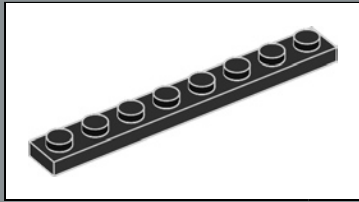

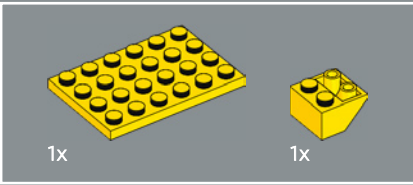
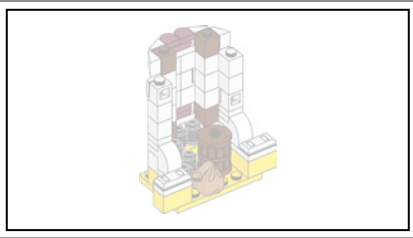

1x

1x

15

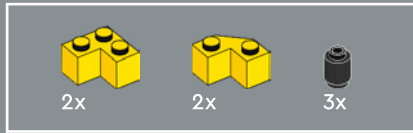
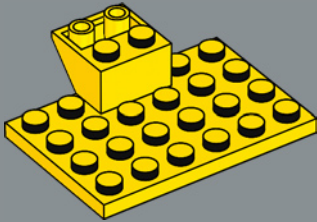

2x

2x

3x

16

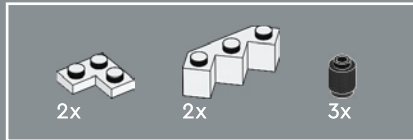
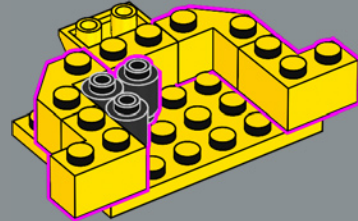

2x

2x

3x

17

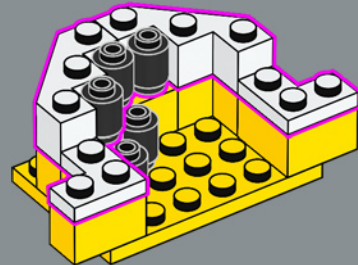

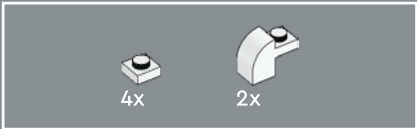

18

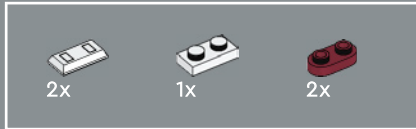
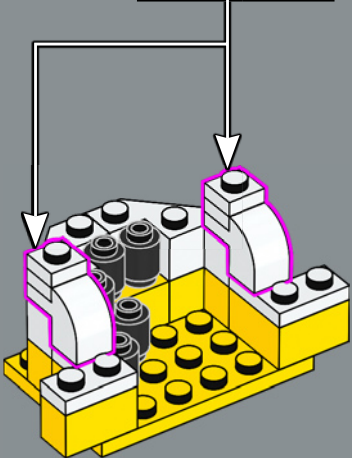
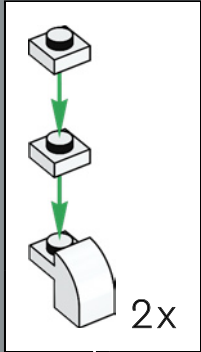

19

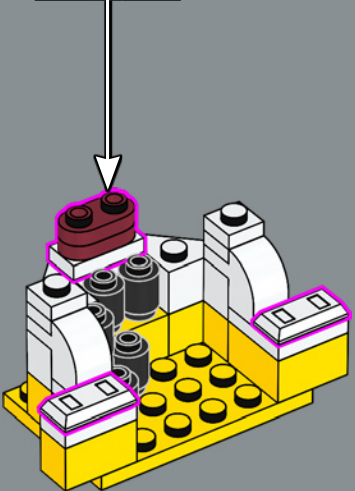
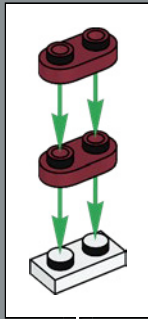

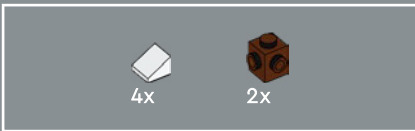

20

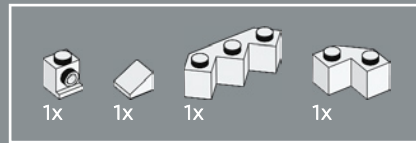
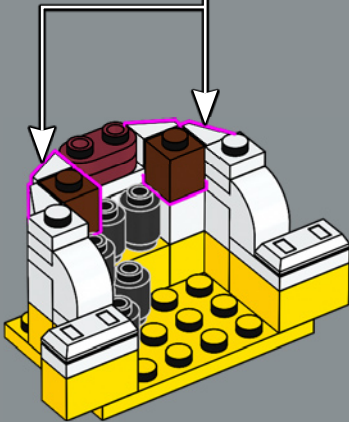
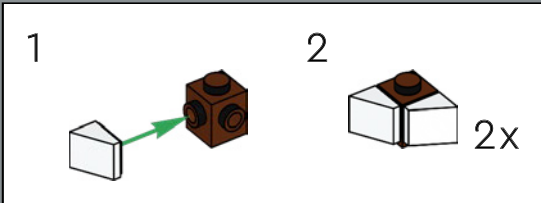

21

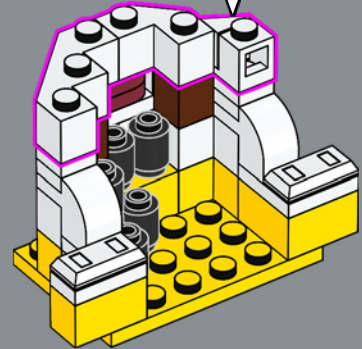
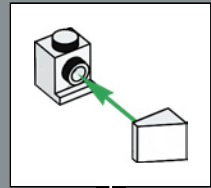

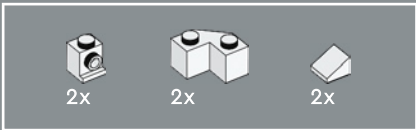

22

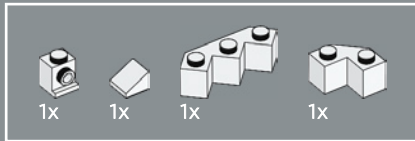
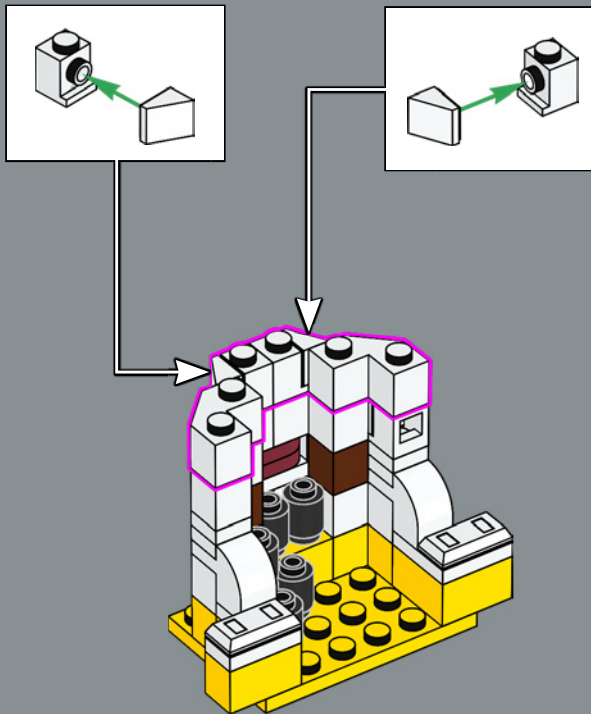

23

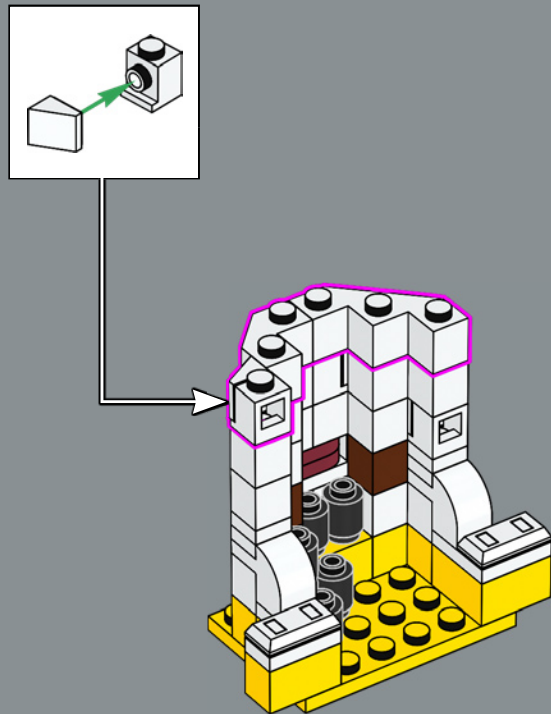



24

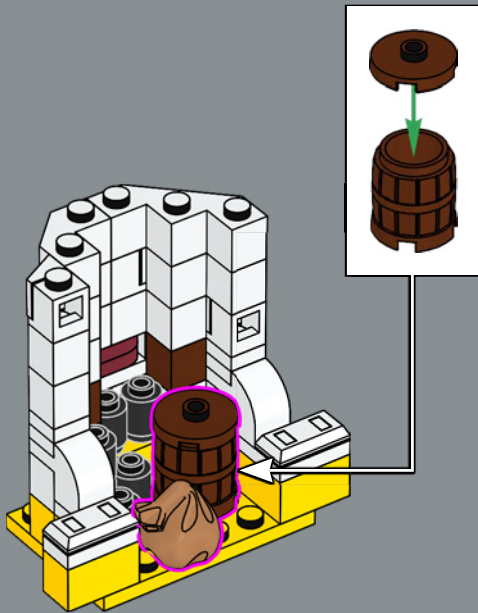

25

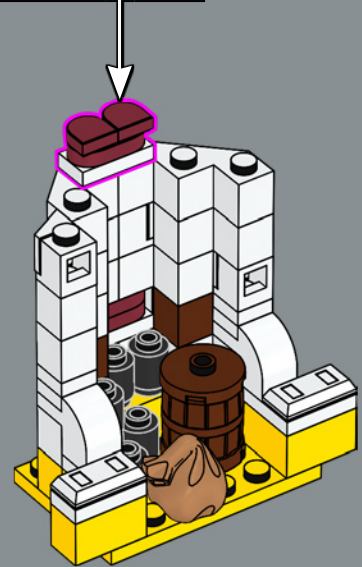
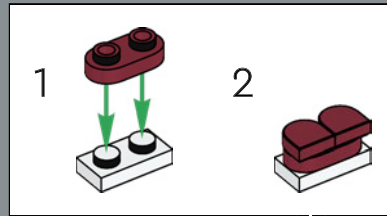



4x



2x

26

1



2



2x

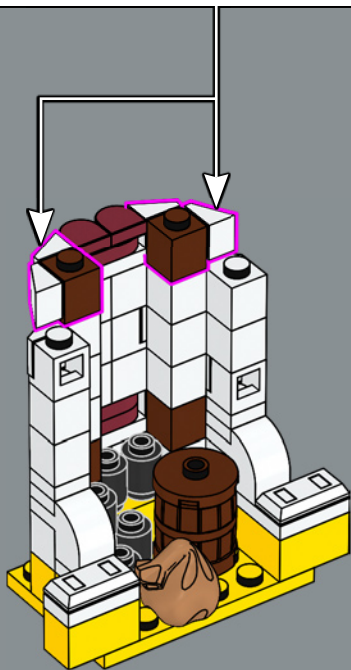

27

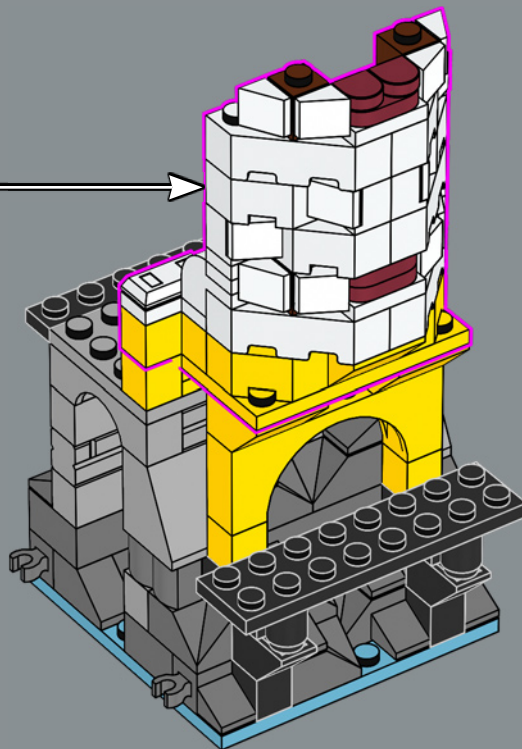



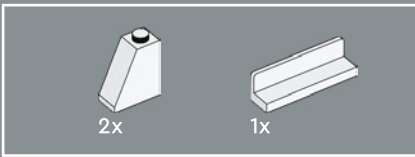

28

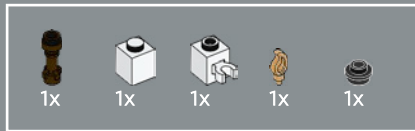
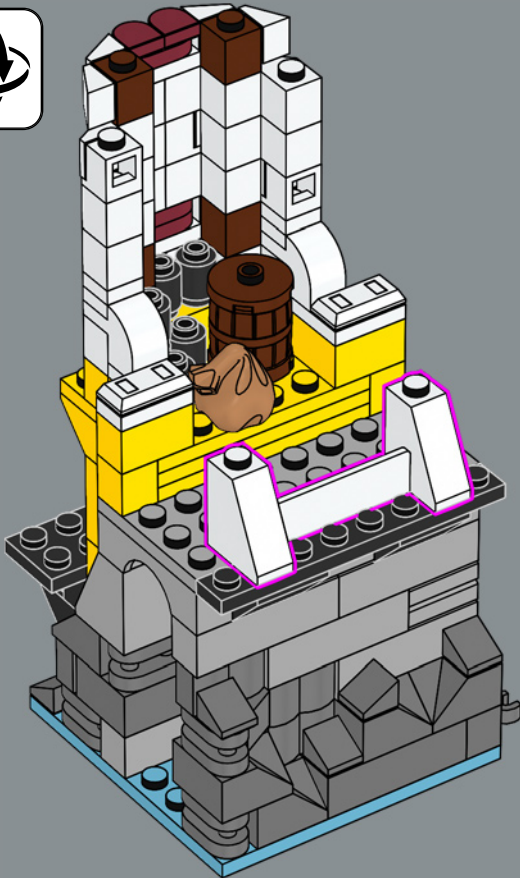

29

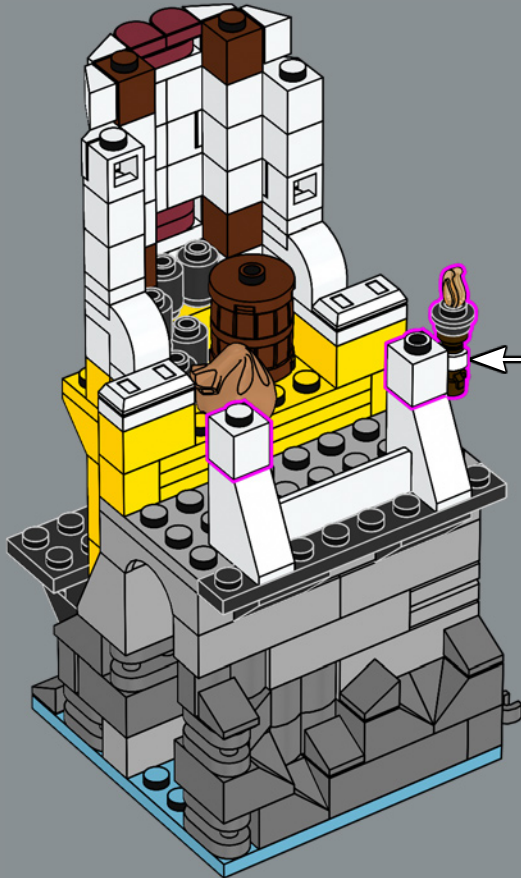



2x

30

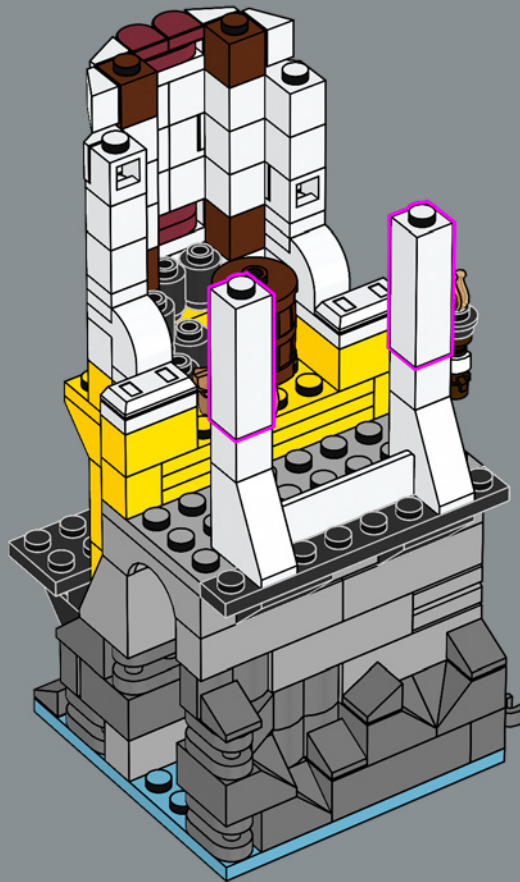



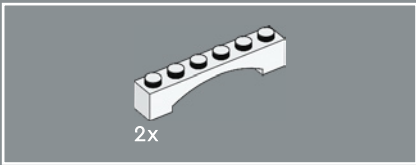

32

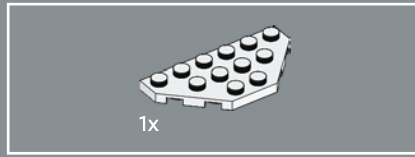
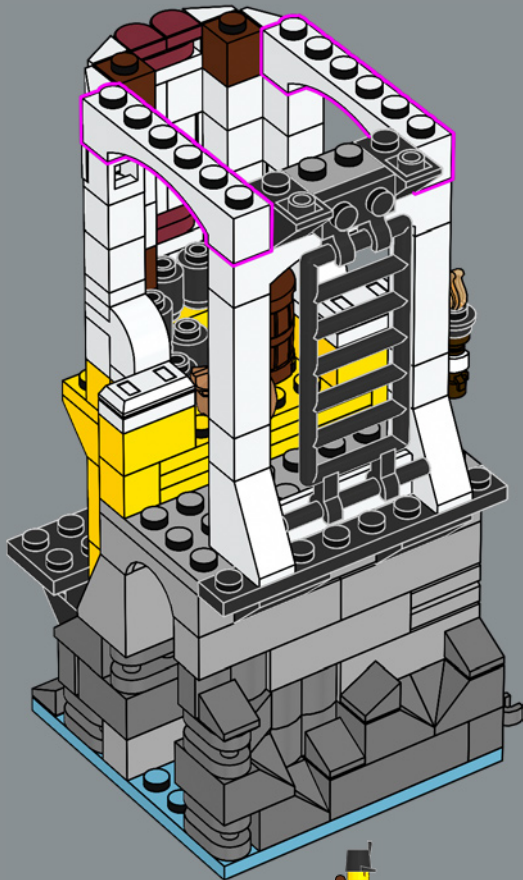

33

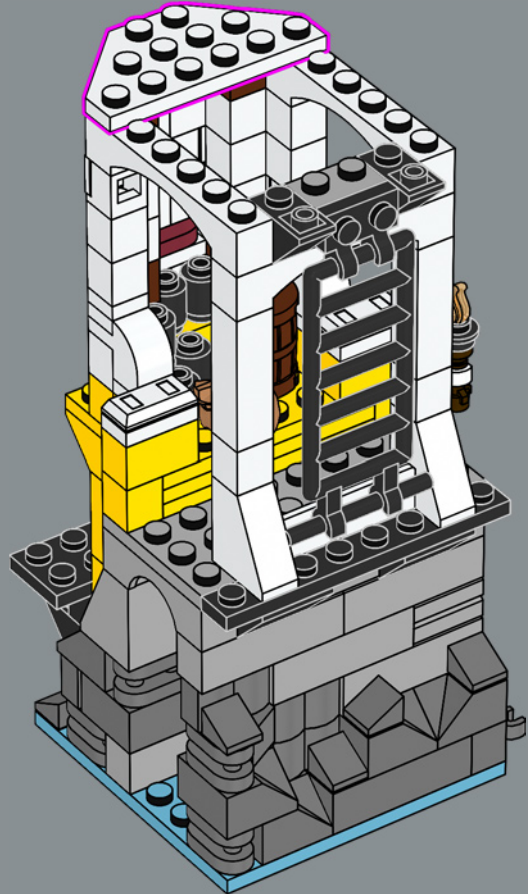

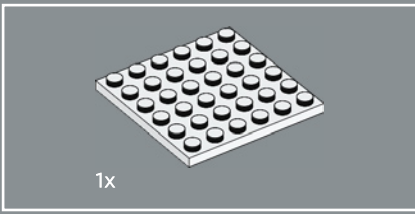

34

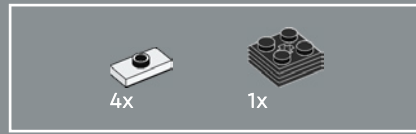
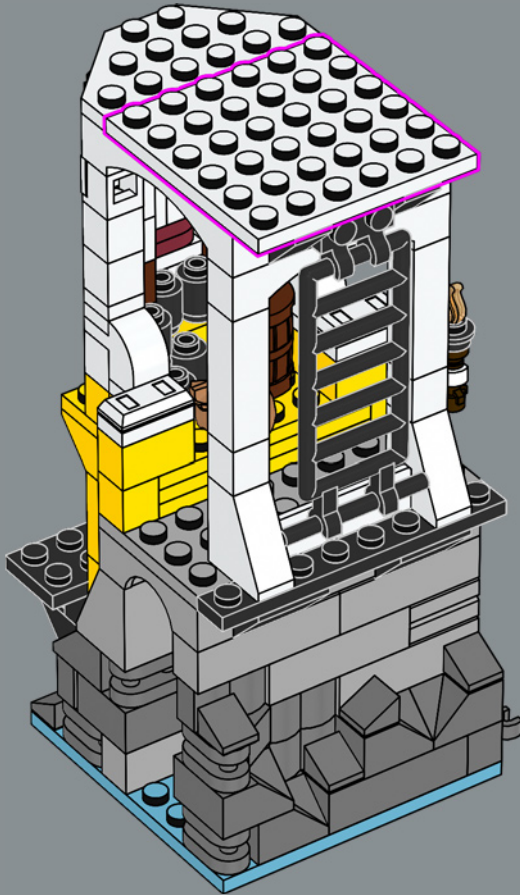

35

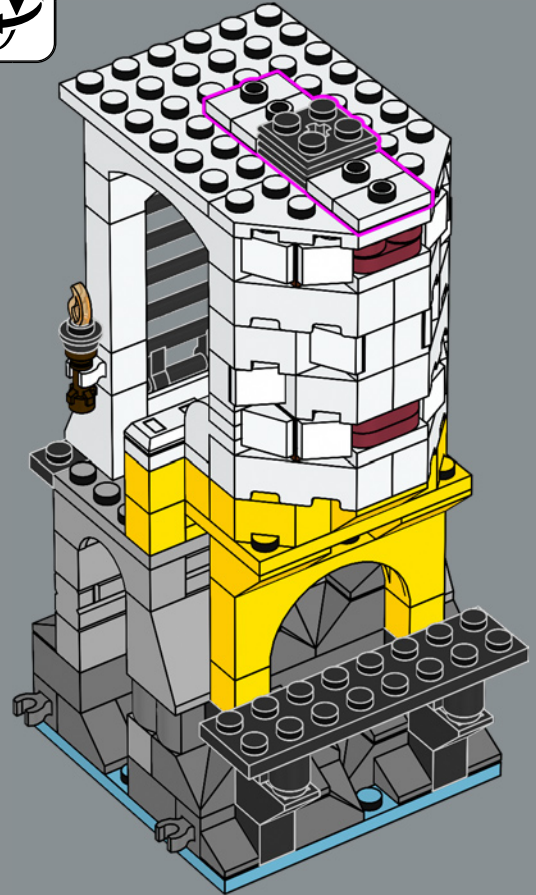

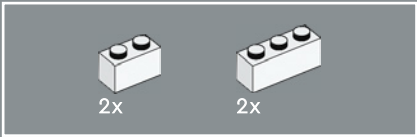

36

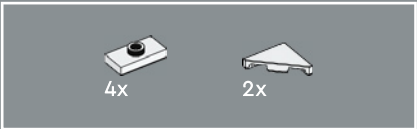
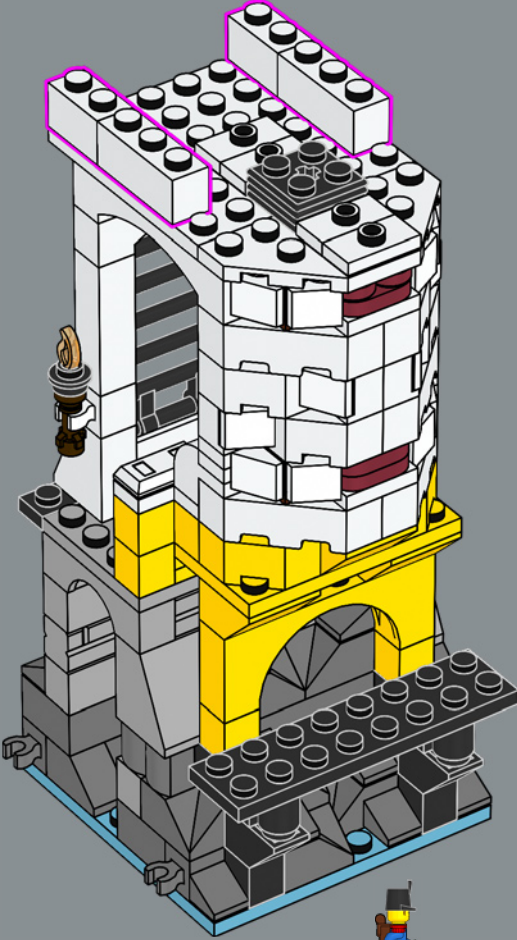

37

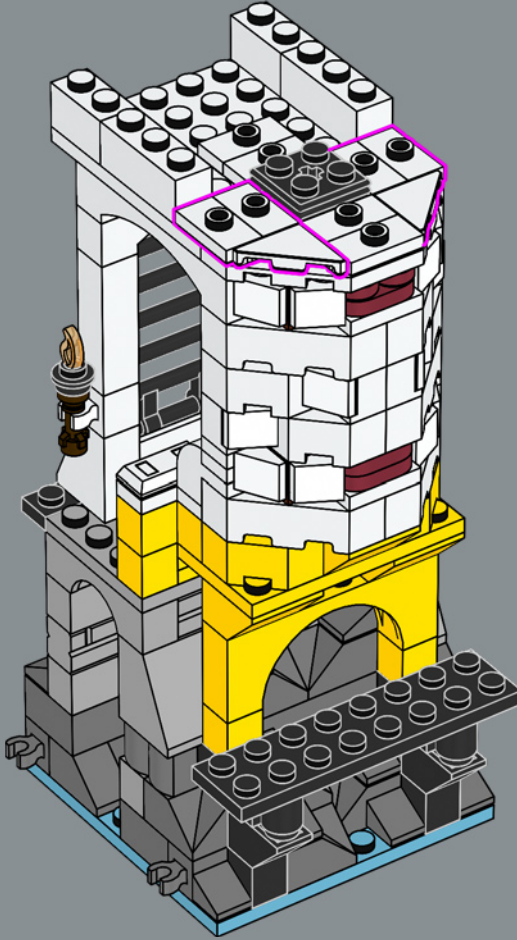

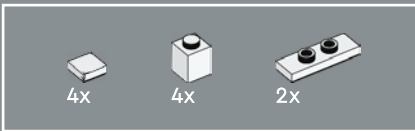

38

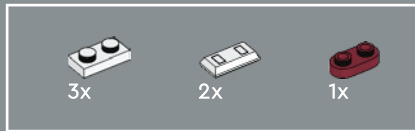
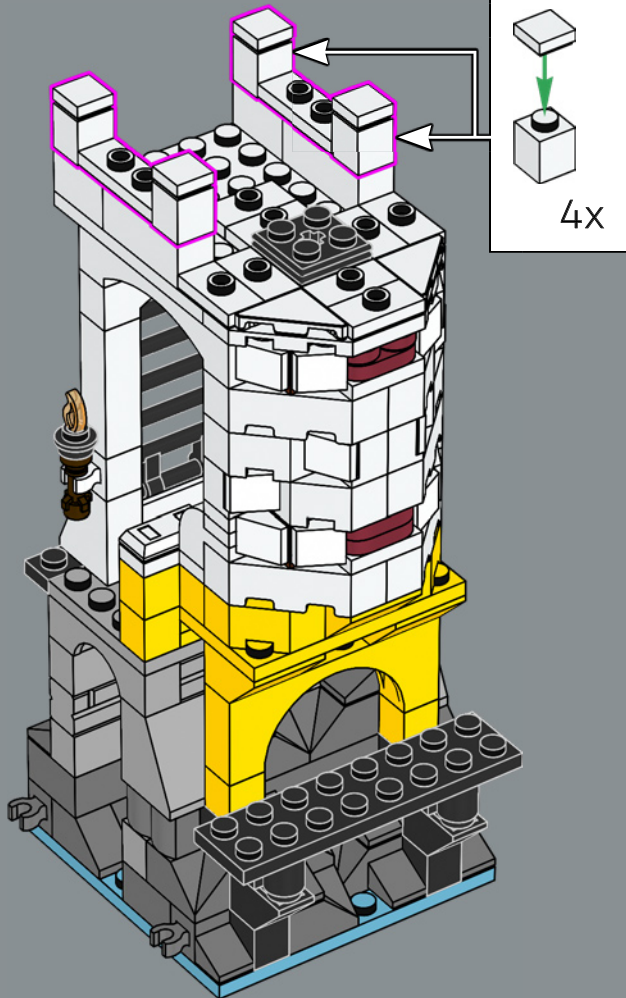

39

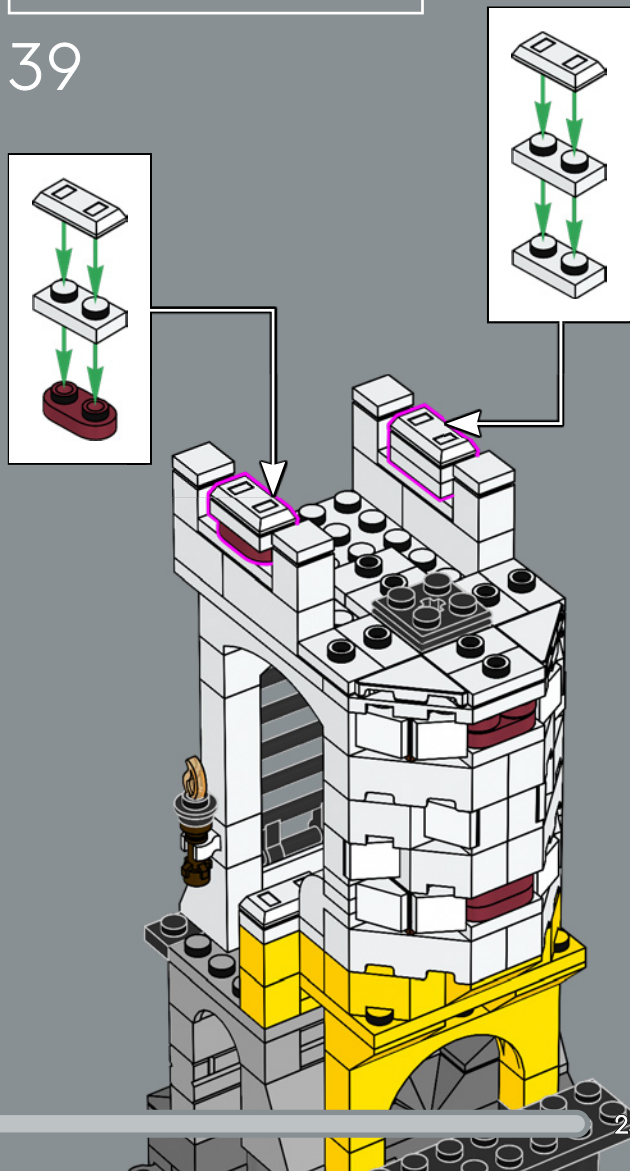

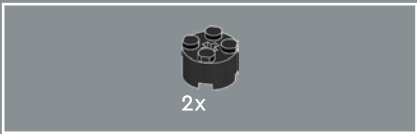

40

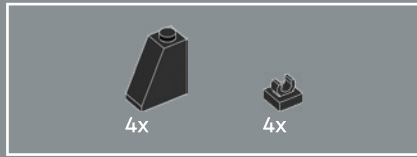
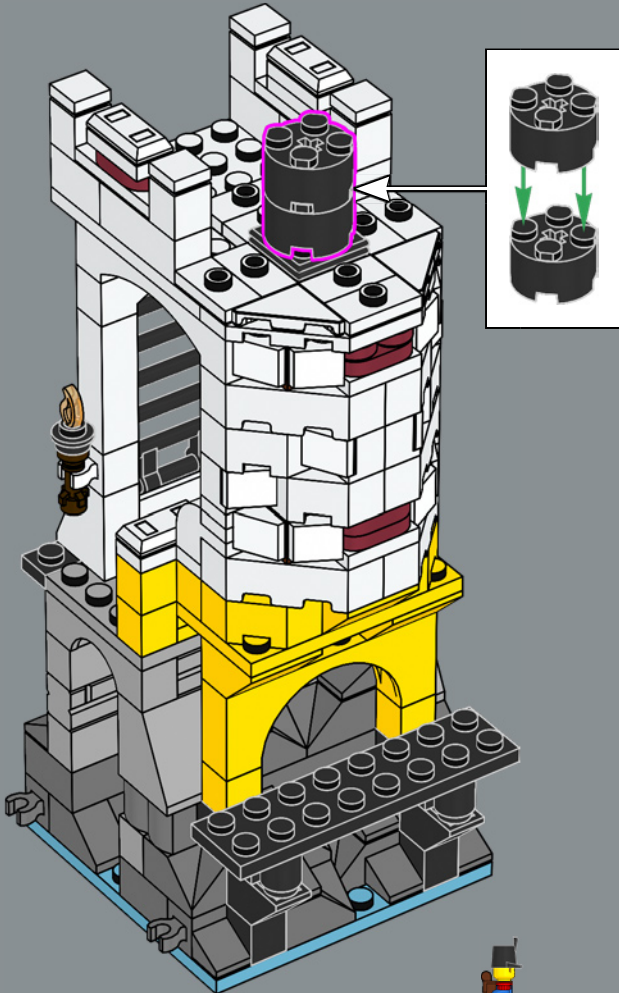

41

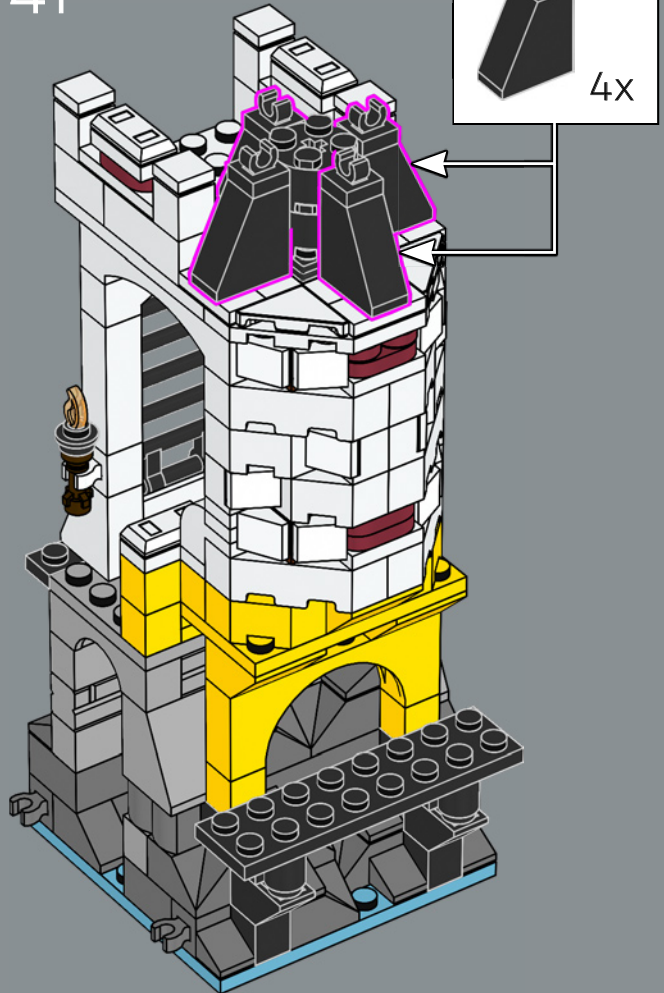





42

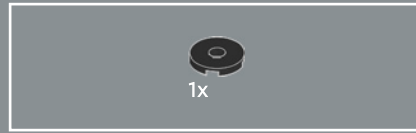
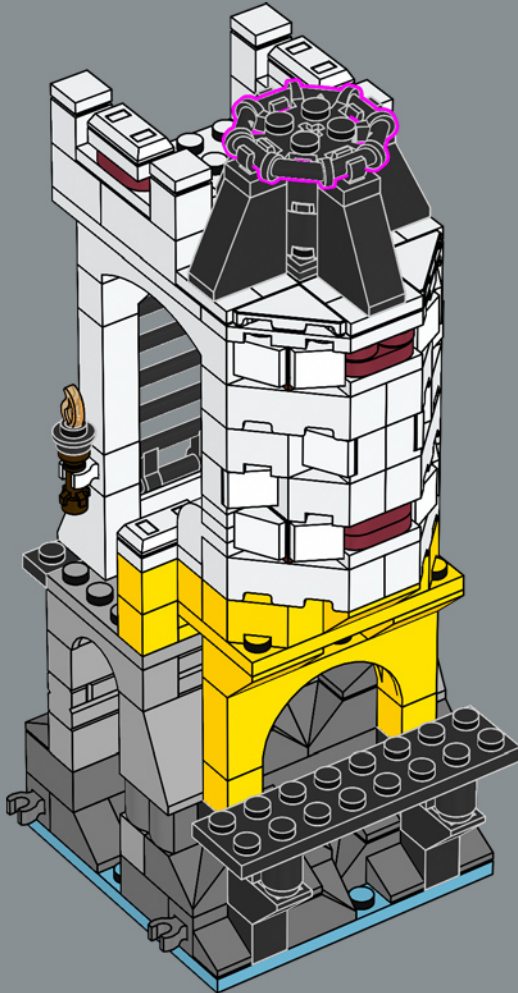

43

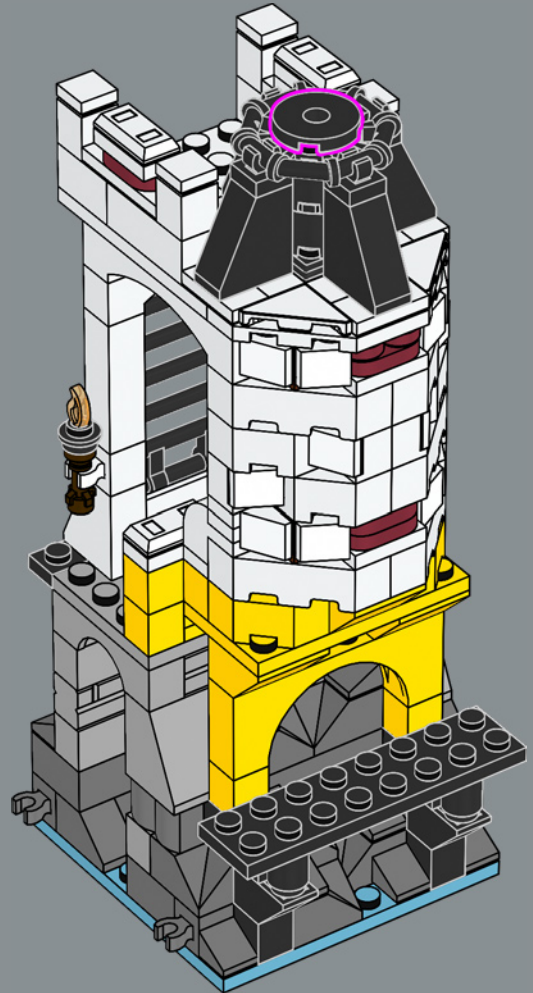

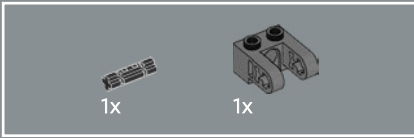
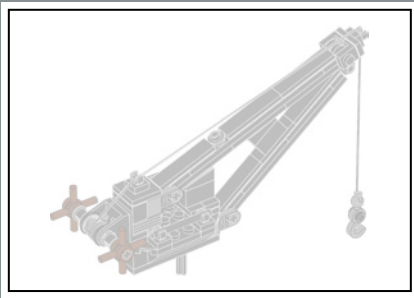

44

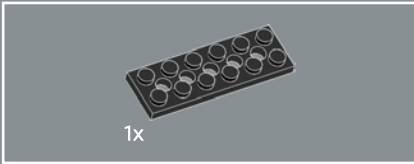
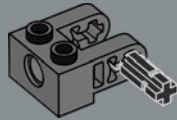

45

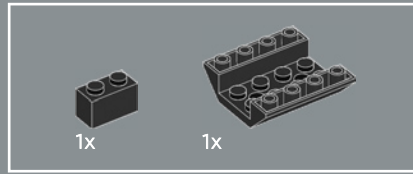
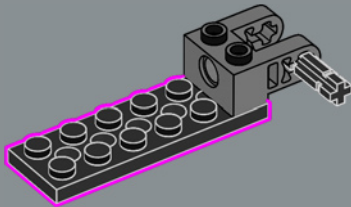

46

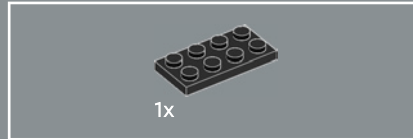
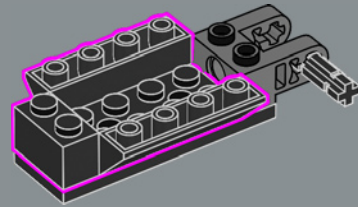

47

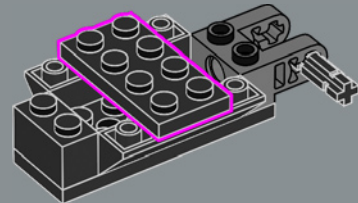

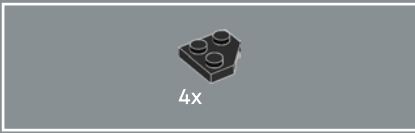

48

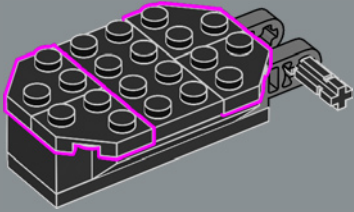

50

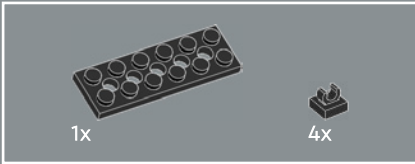
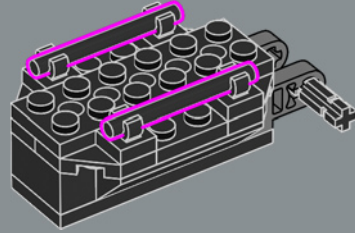

49

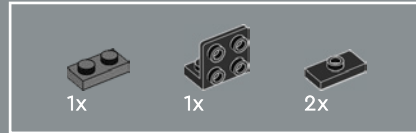
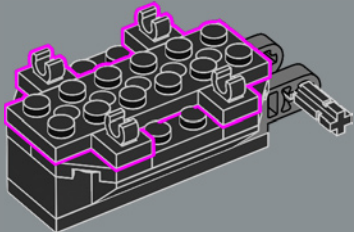

51

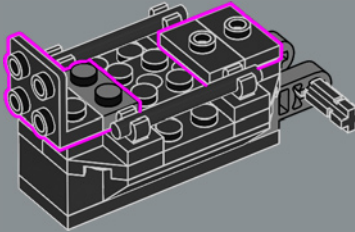

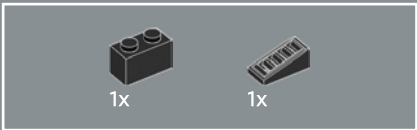

52

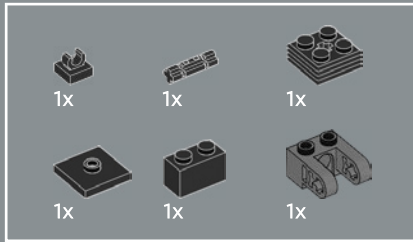
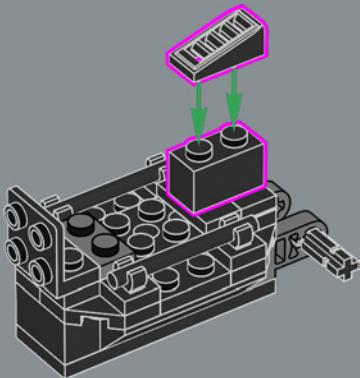

53

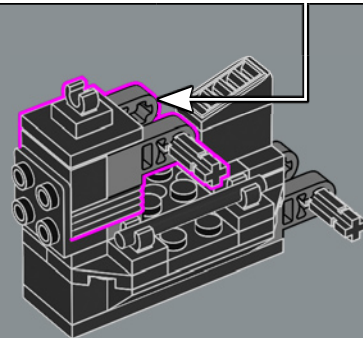
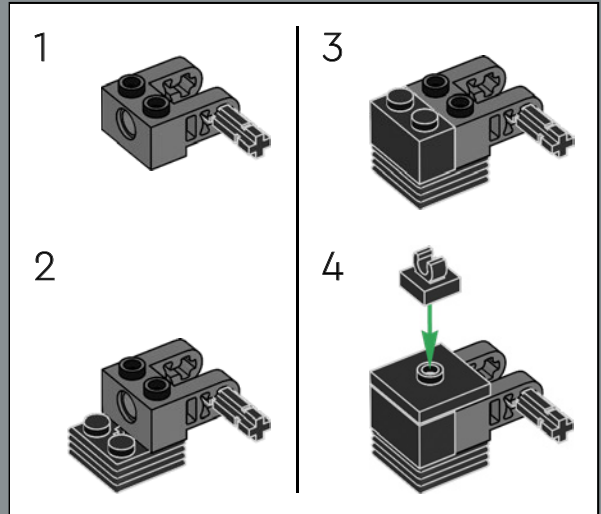



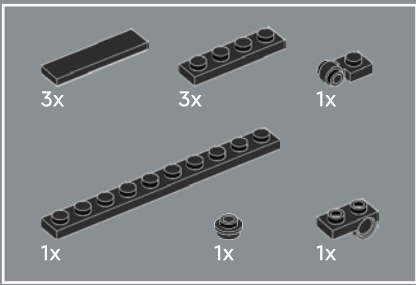

55

1

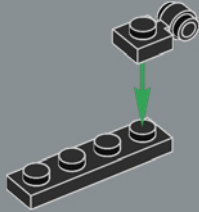

2

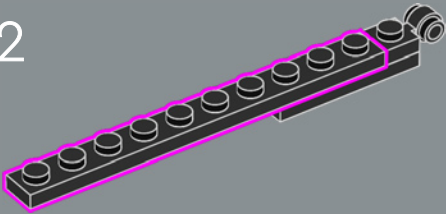

3

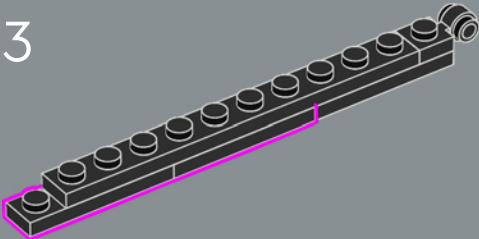

4

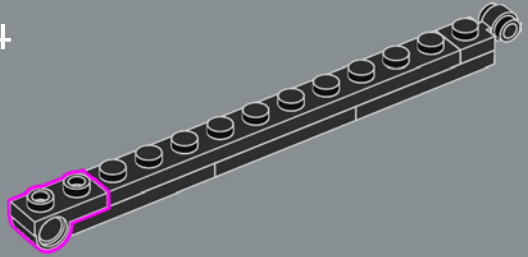

5

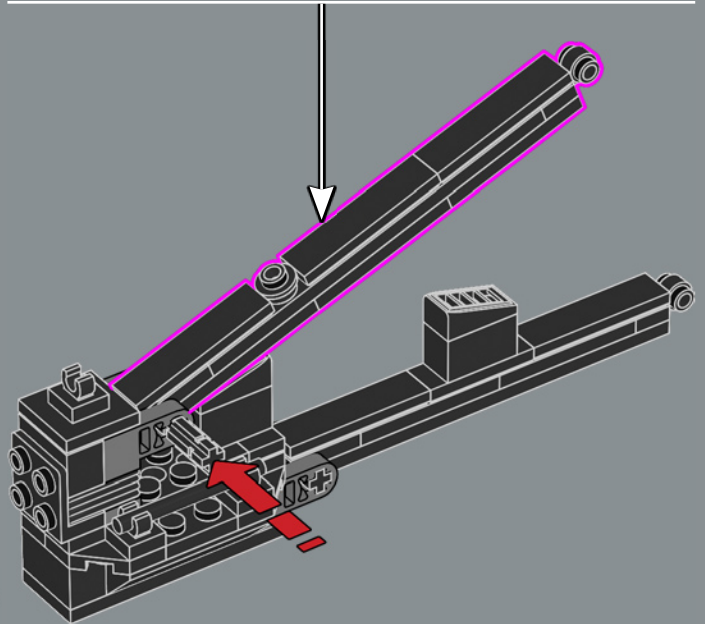
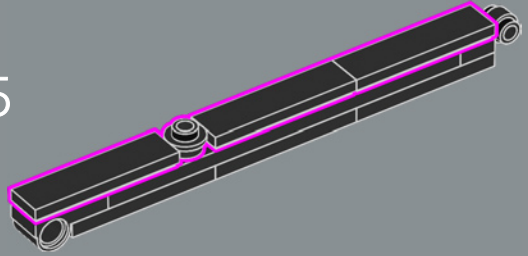



56

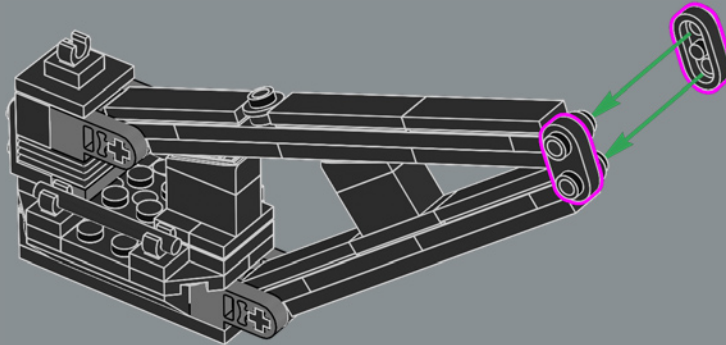

57

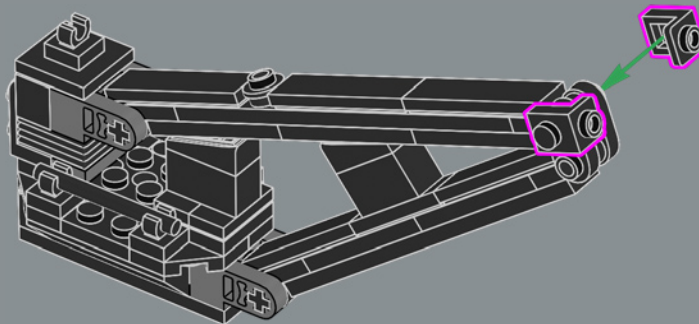

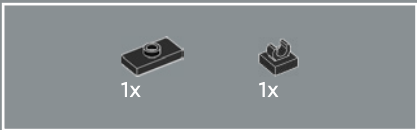

58

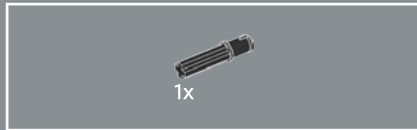
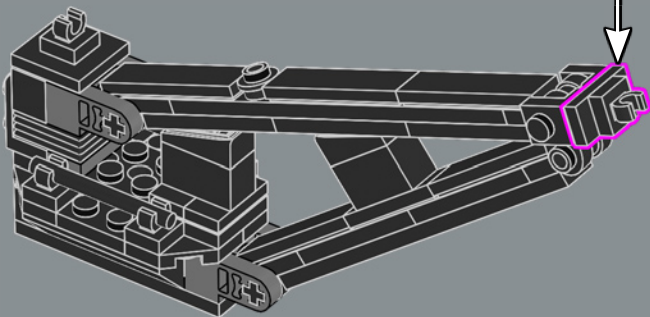
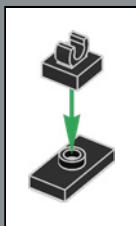

59

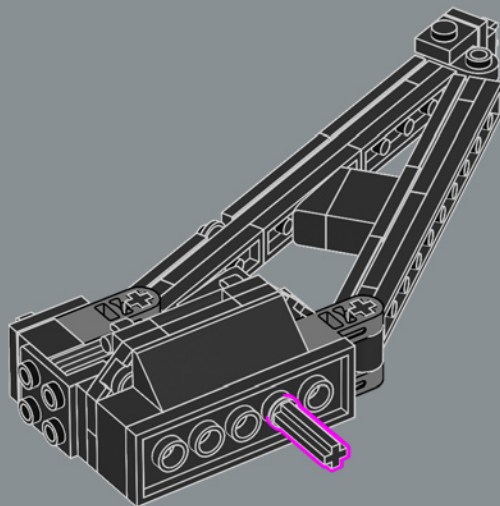



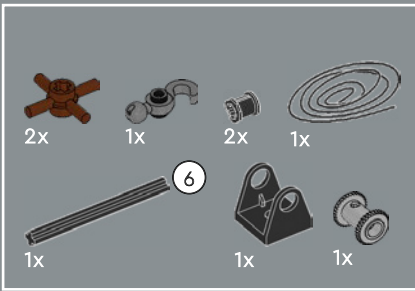

60

1

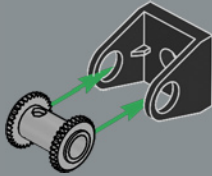

2

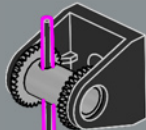

3

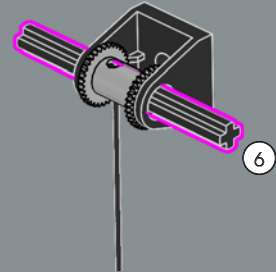

4

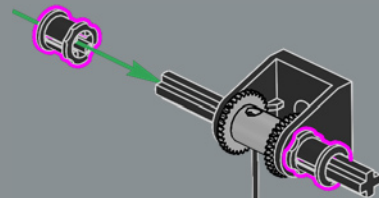

5

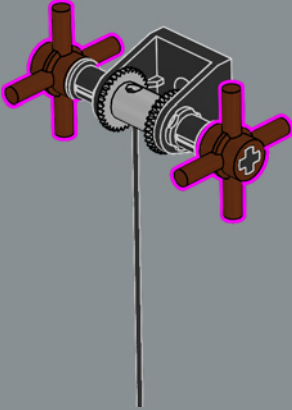

6

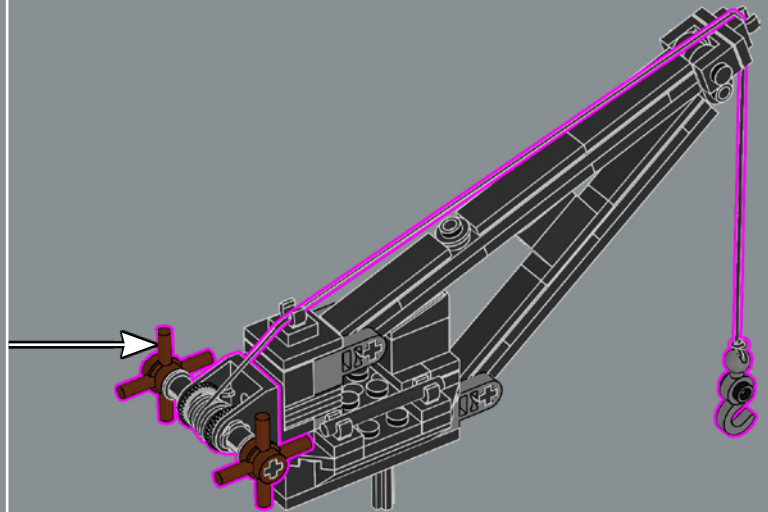
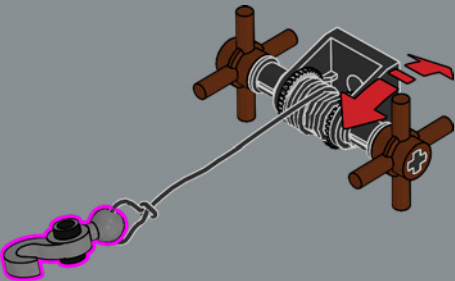

61



Grâce à la grande grue, le gouverneur  
et son équipage peuvent manipuler des  
marchandises encore plus lourdes.

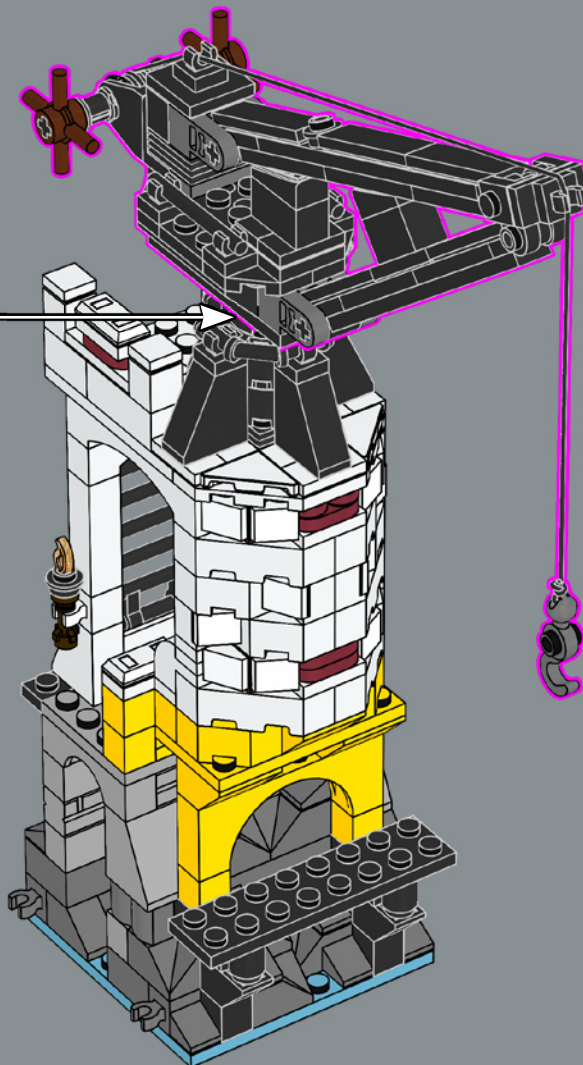

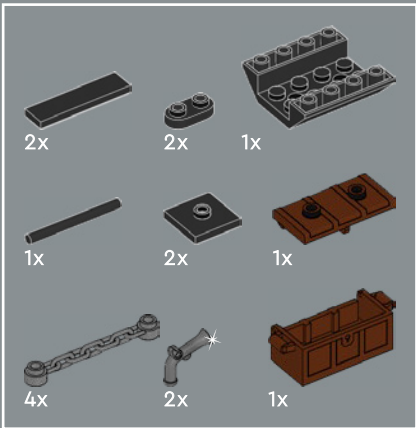

62

1

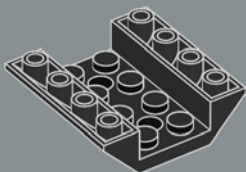

2

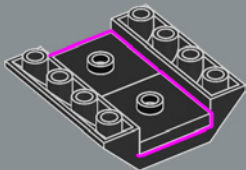

3

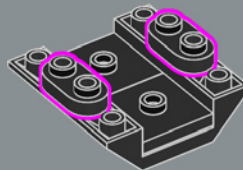

4

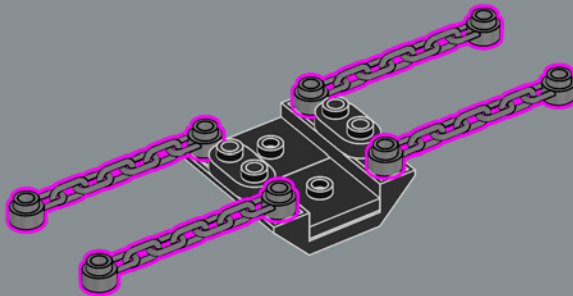

5

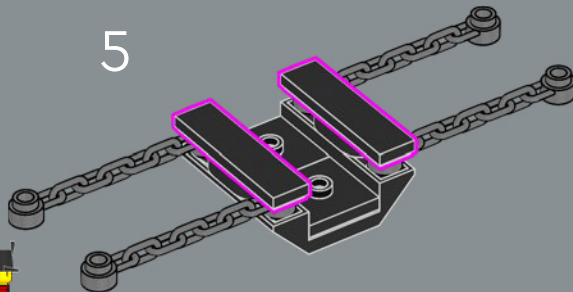

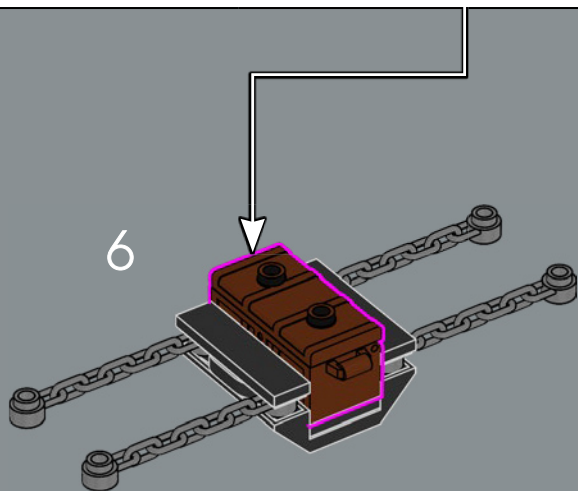
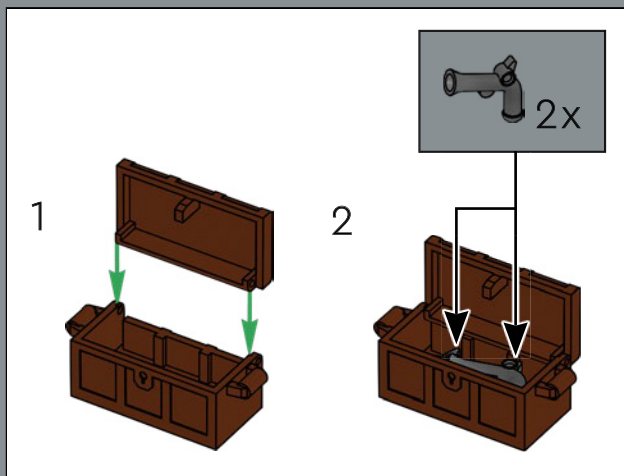

7

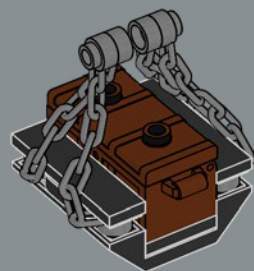

8

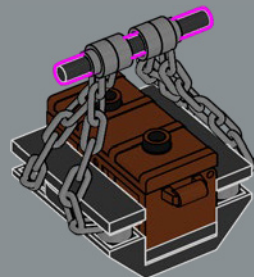

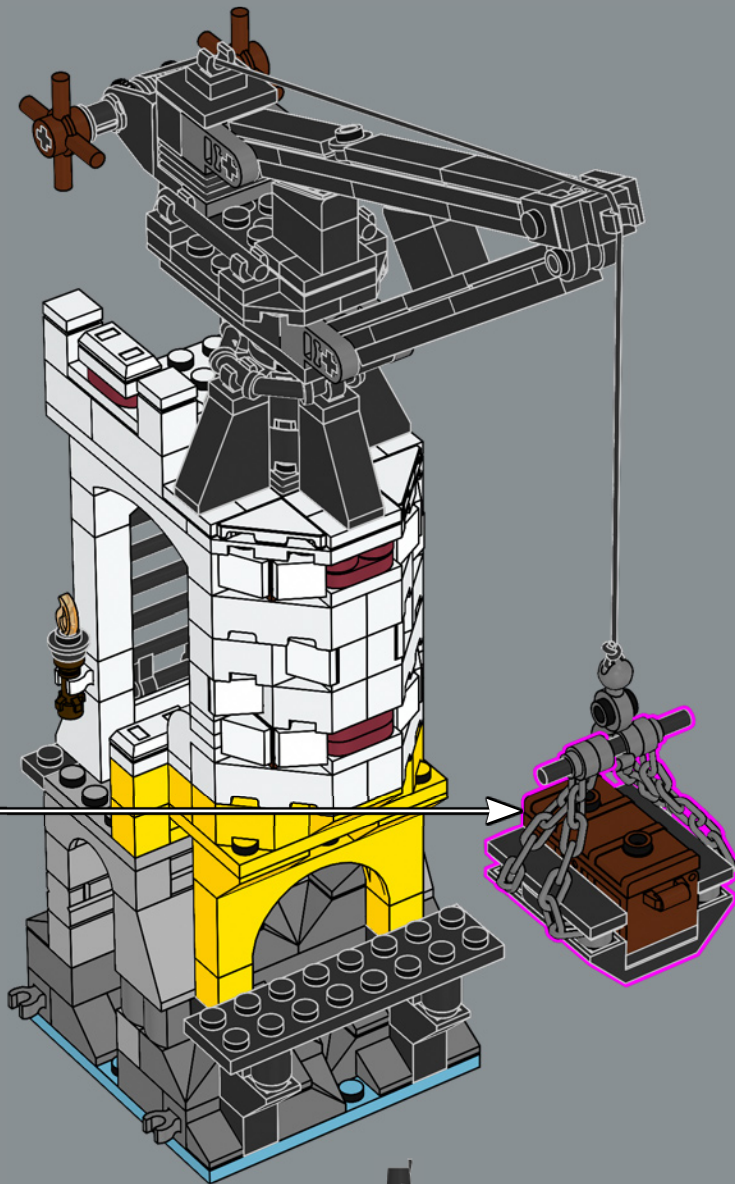



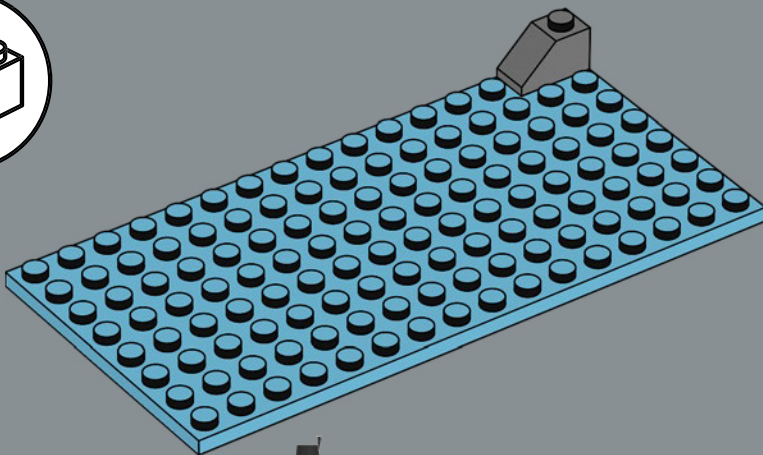
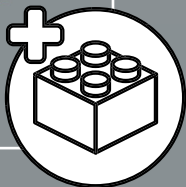
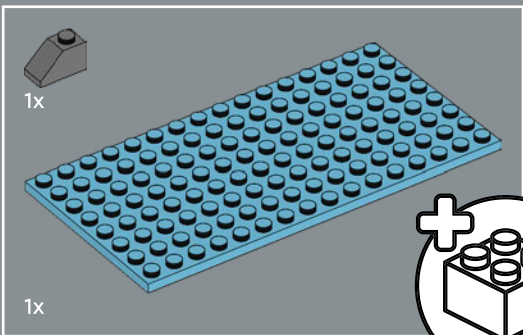
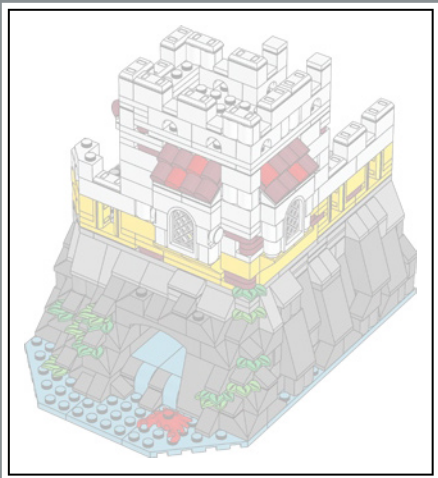

1





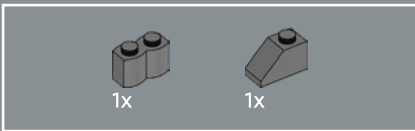

2

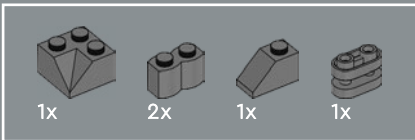
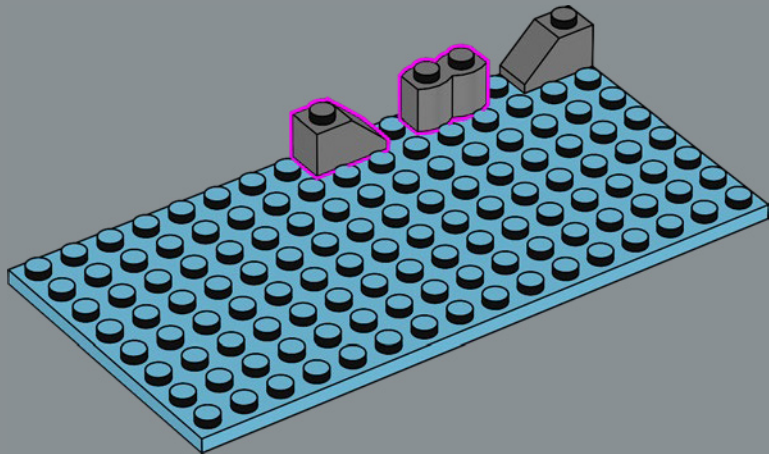

3

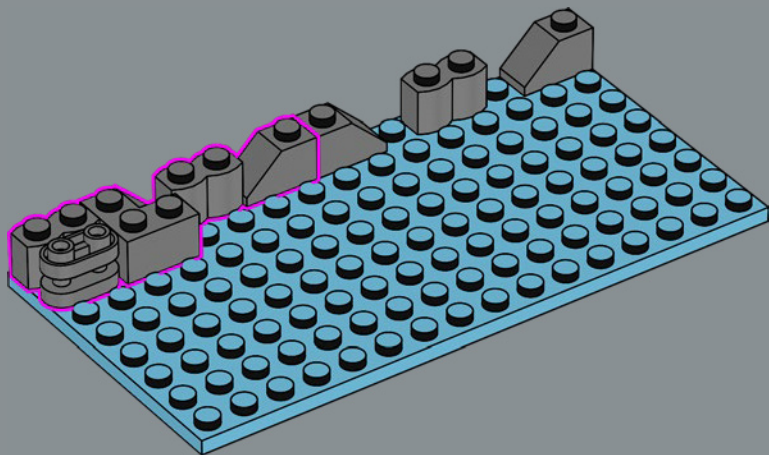

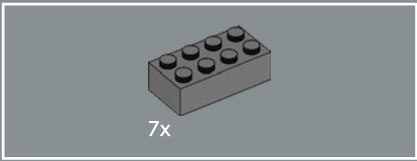

4

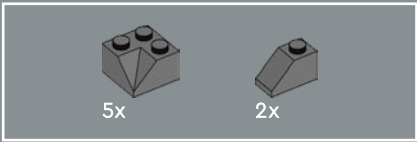
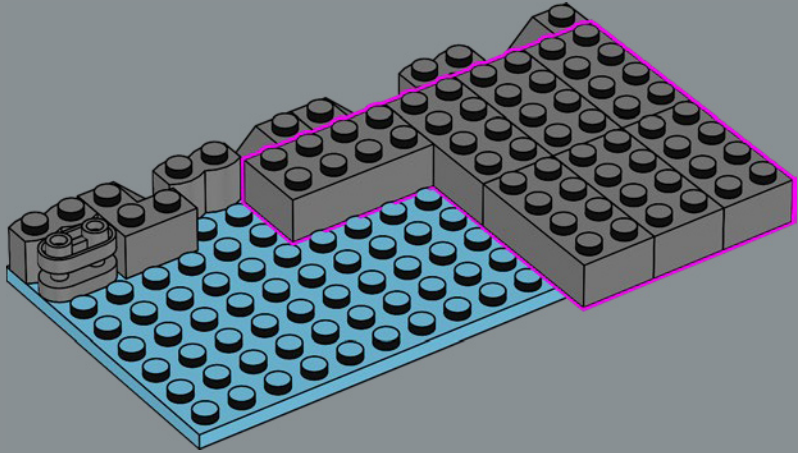

5

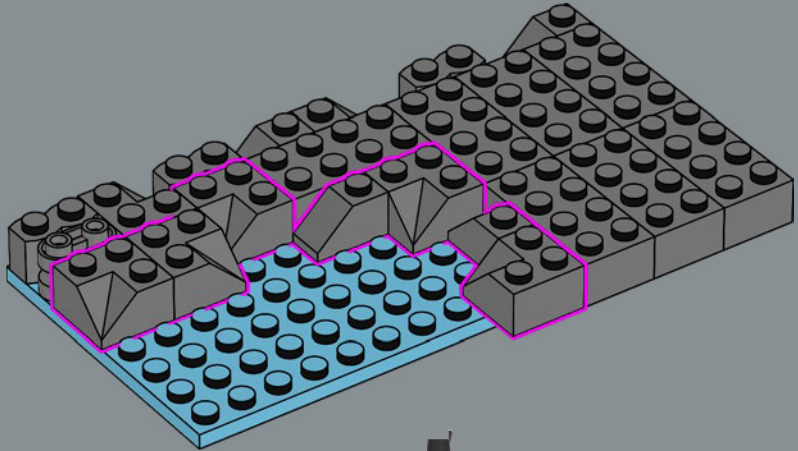

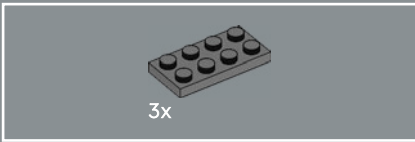

6

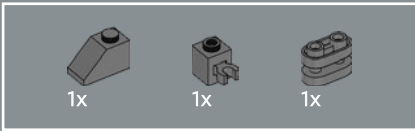
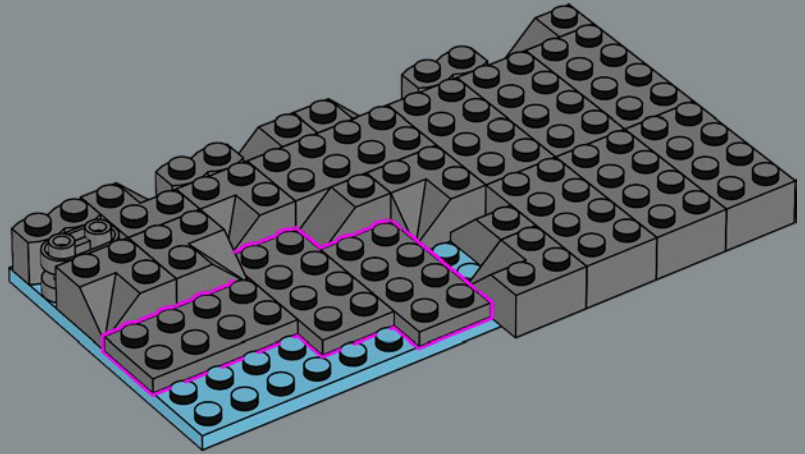

7

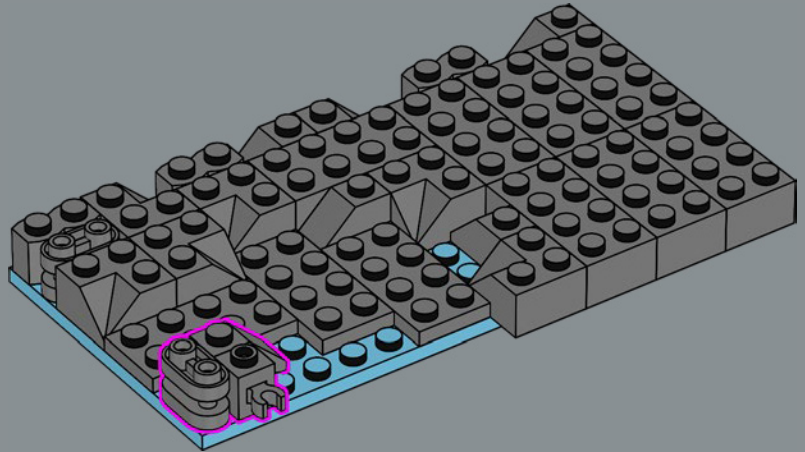

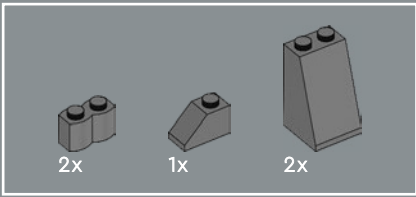

8

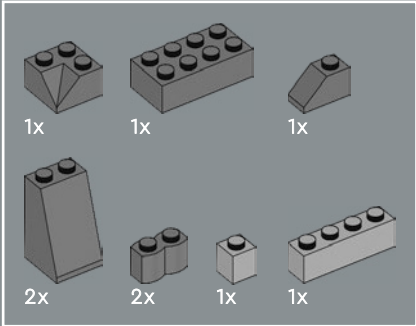
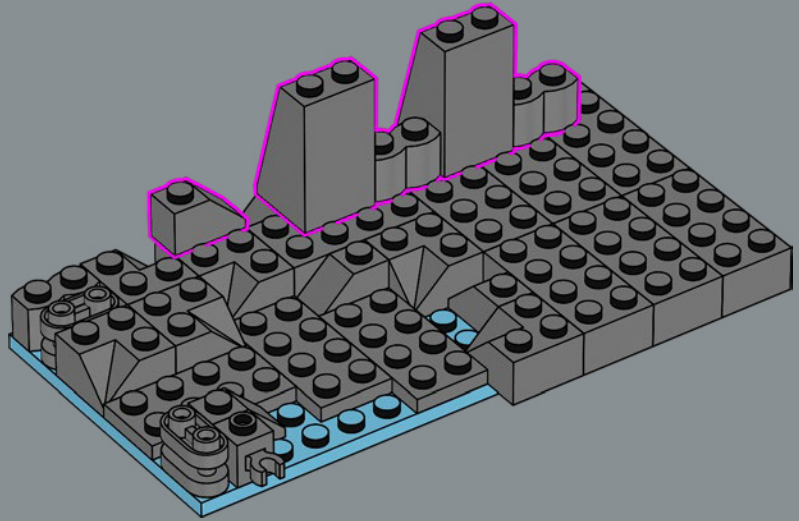

9

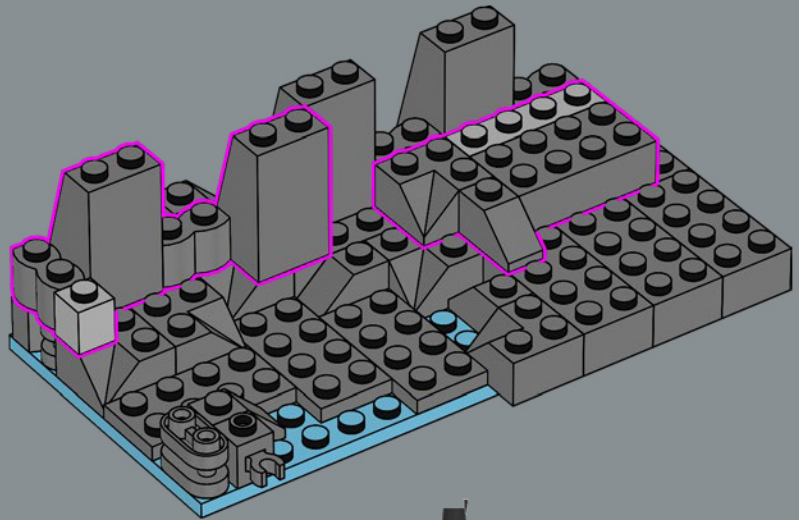

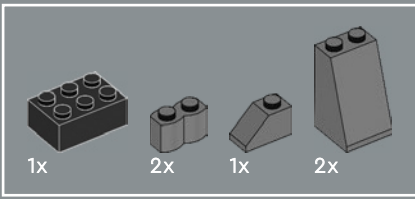

10

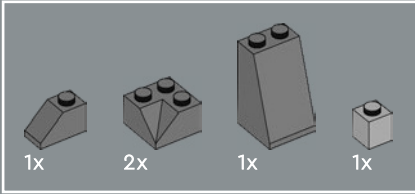
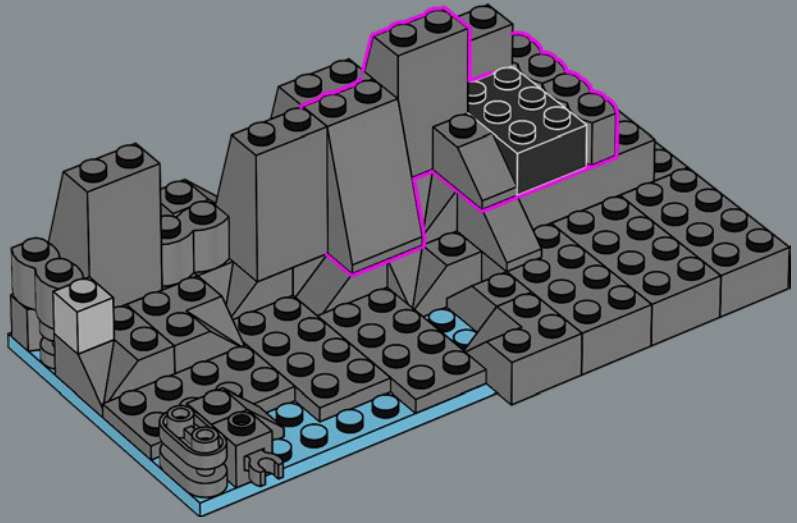

11

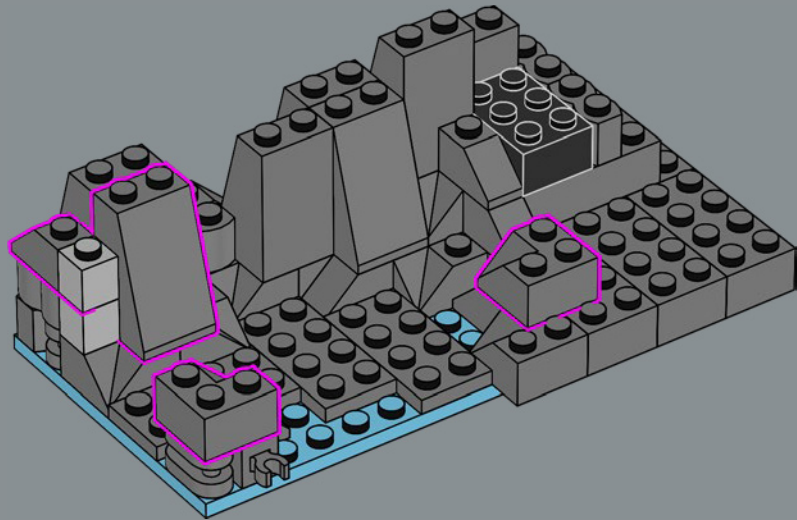

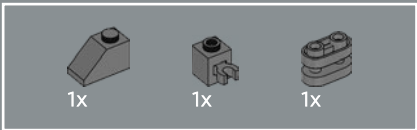

12

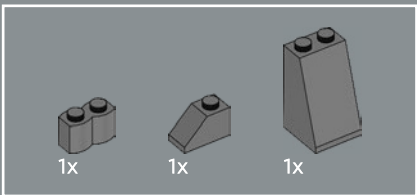
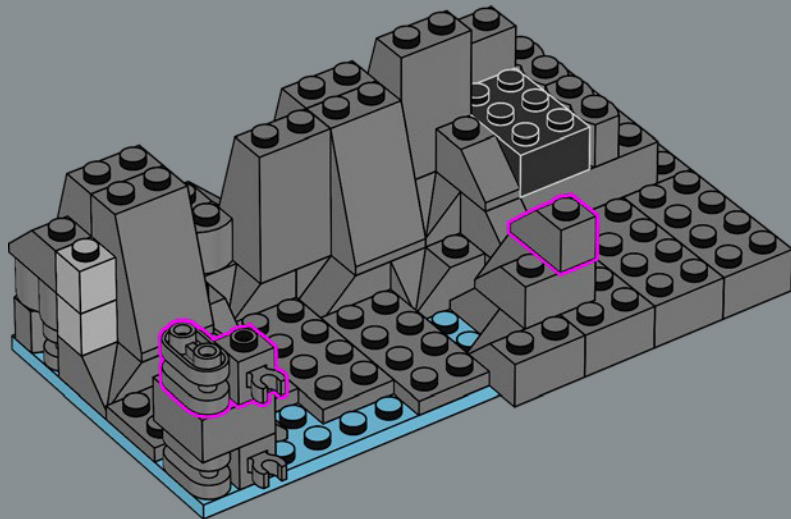

13

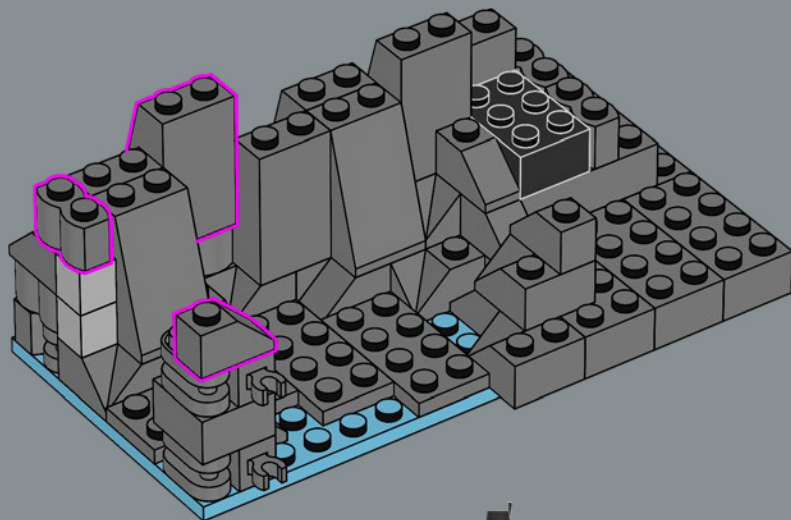

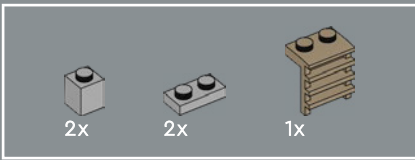

14

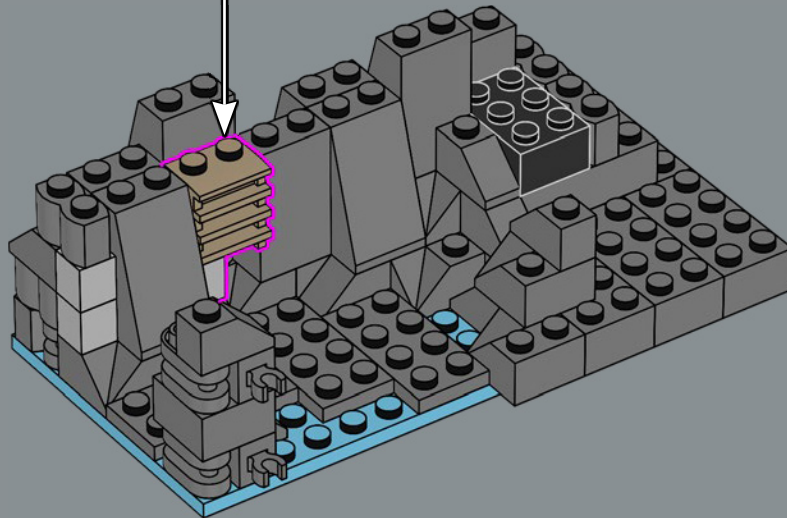
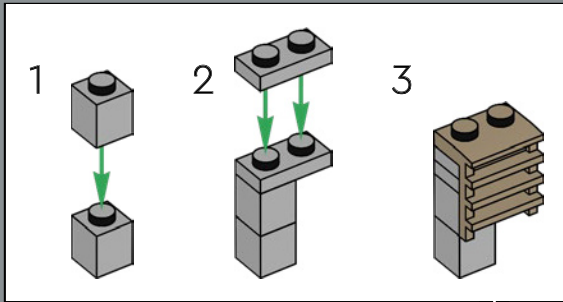

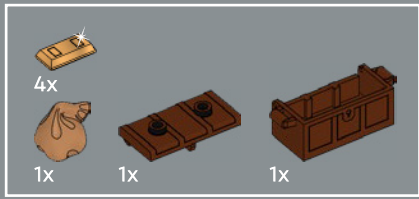

15

1

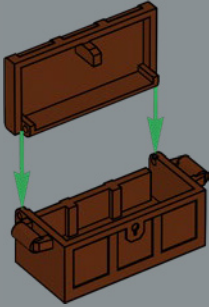

2

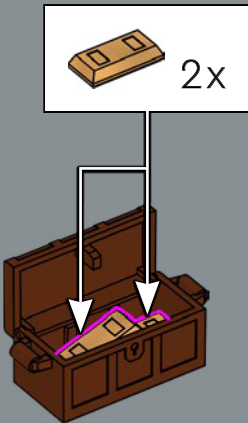

3

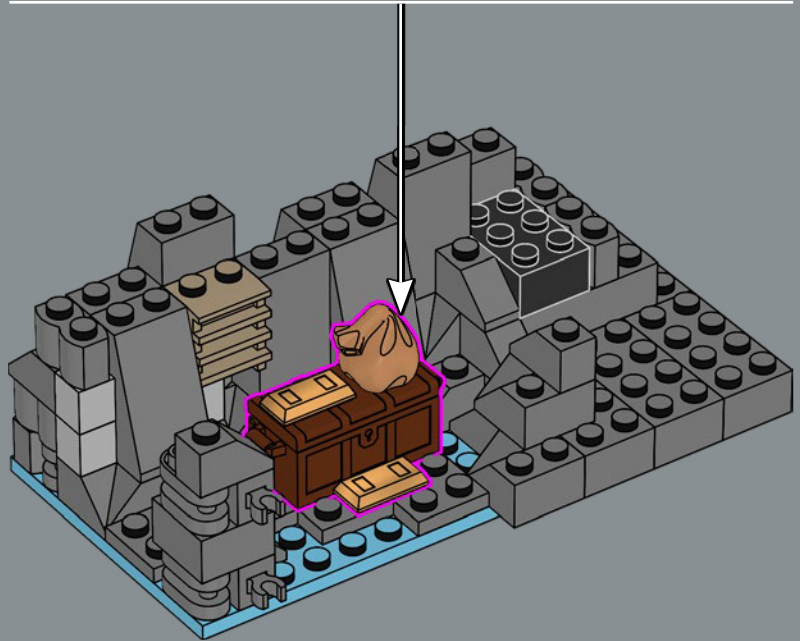
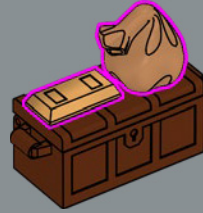



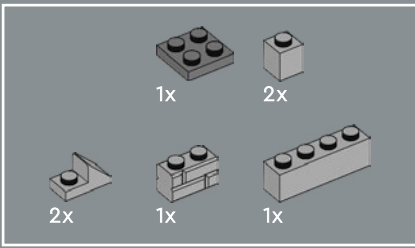

16

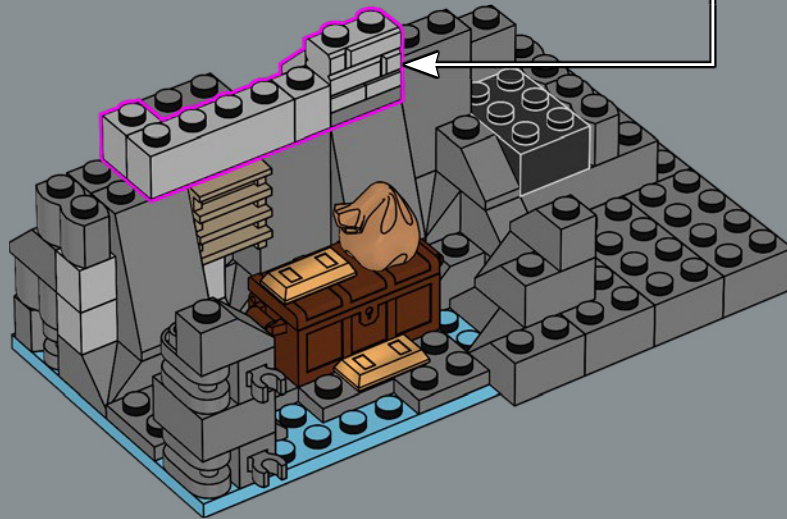
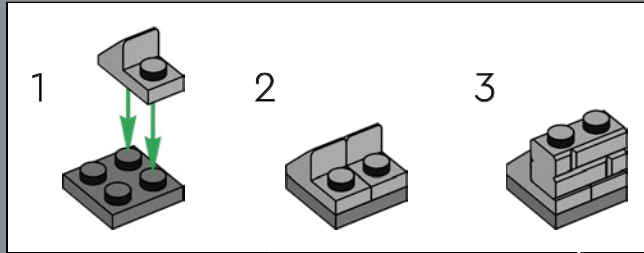

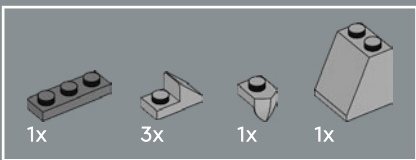

17

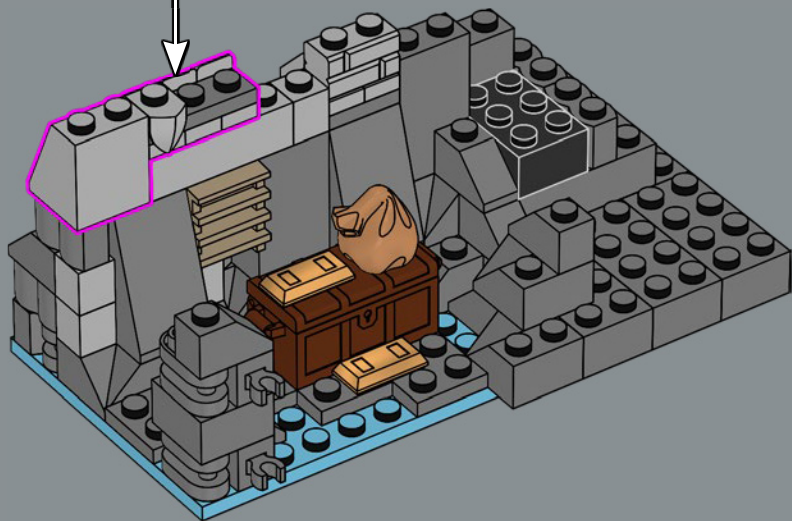
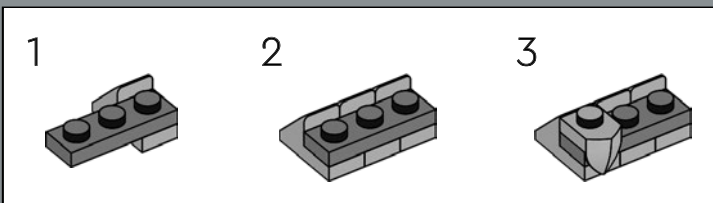

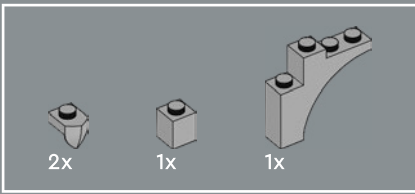

18

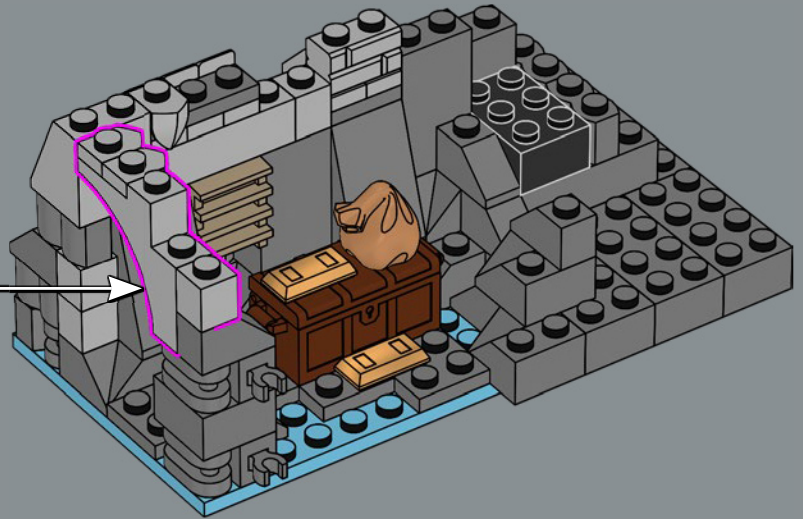
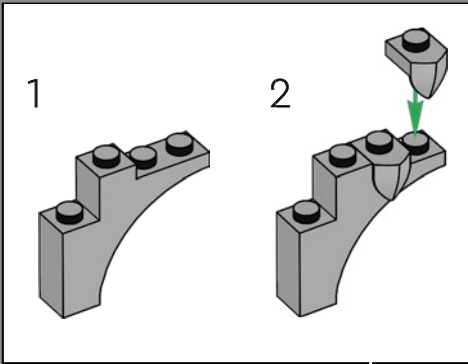

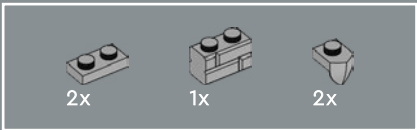

19

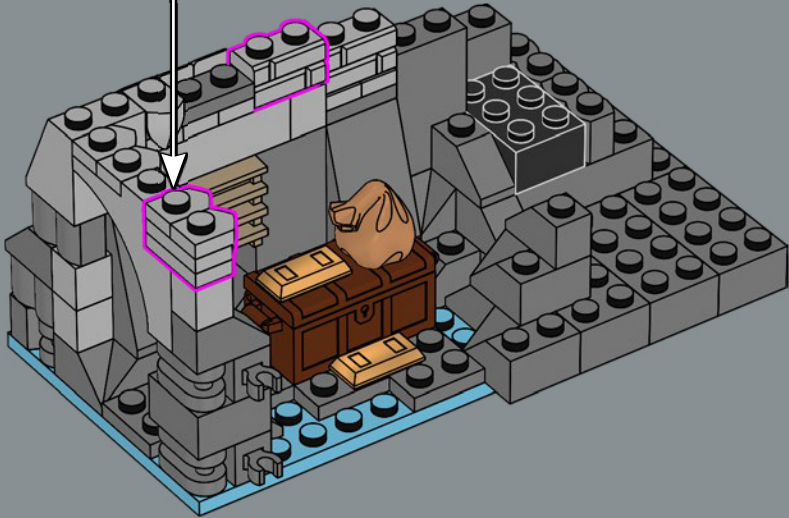
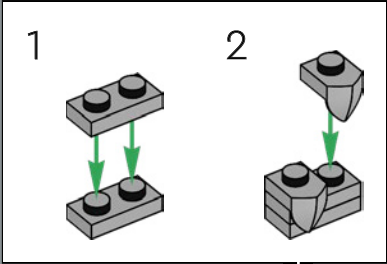

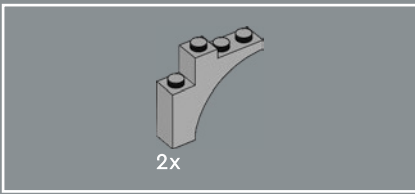

20

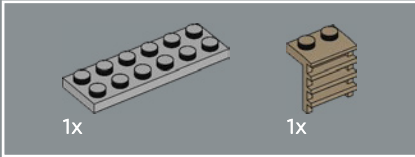
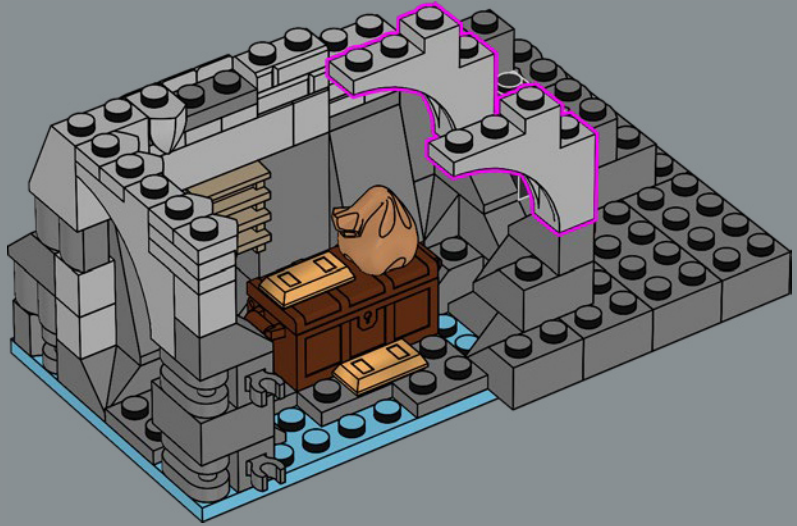

21

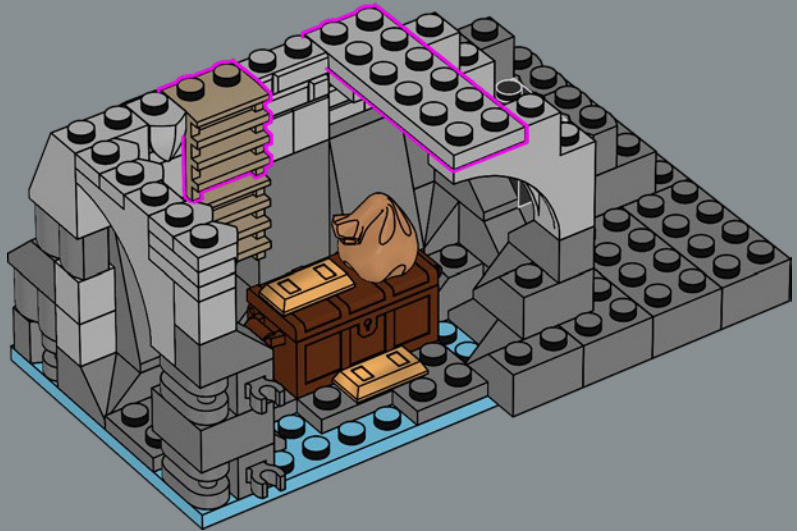

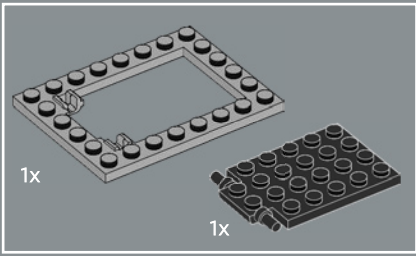

22

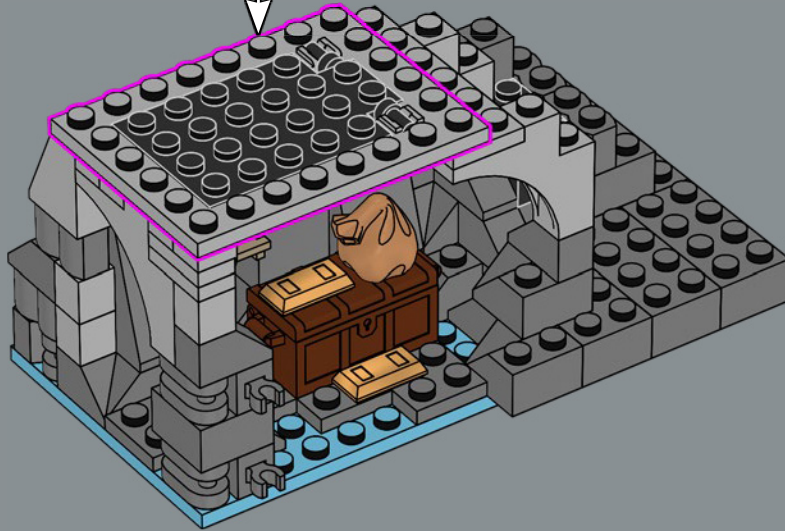
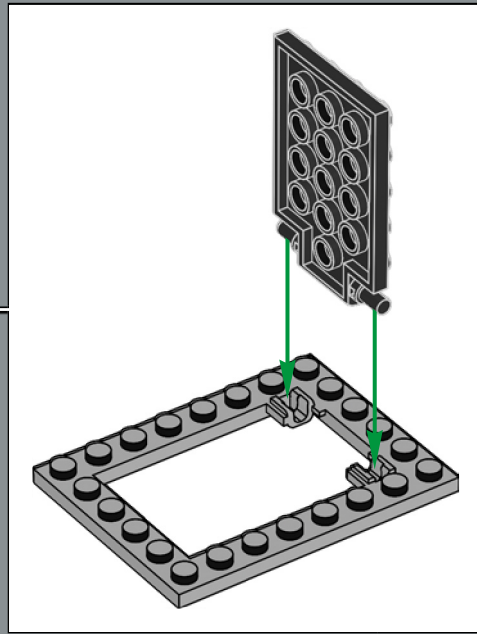

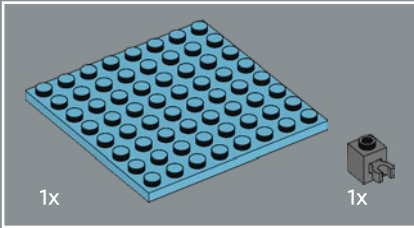
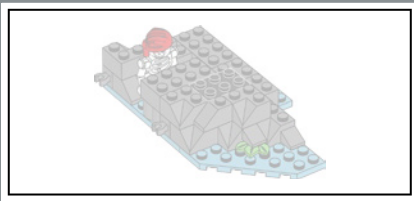

23

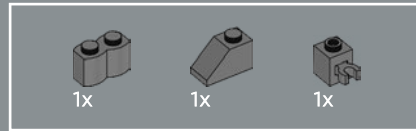
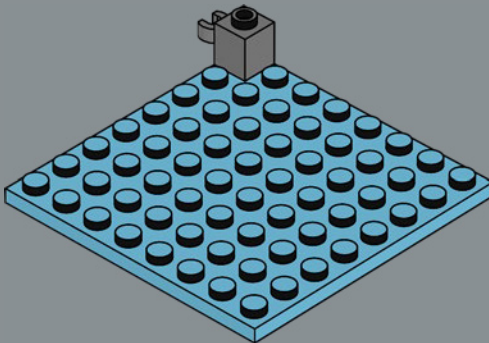

24

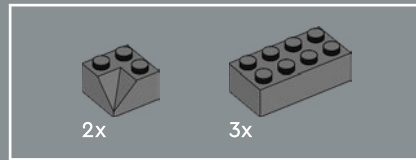
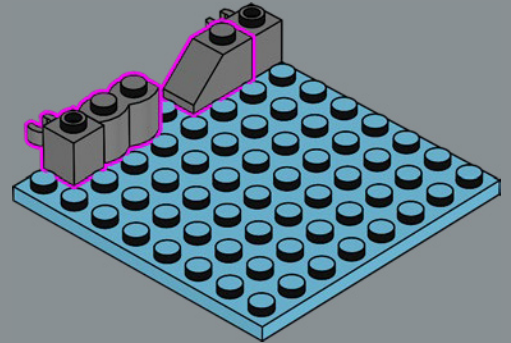

25

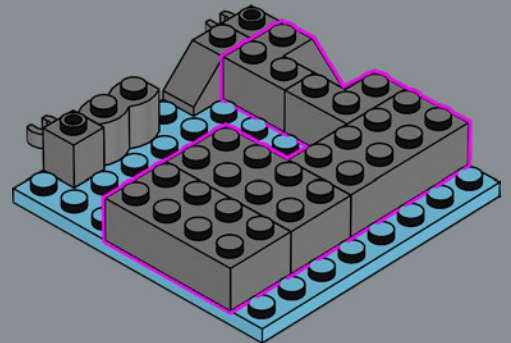

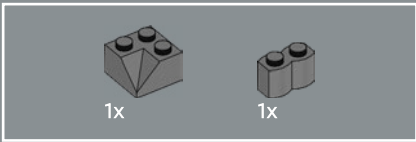

26



On ne sait pas quel a été le funeste destin de ce pauvre squelette. Peut-être essayait-il de s'échapper ? Ou était-il à la recherche de la lettre cachée ?

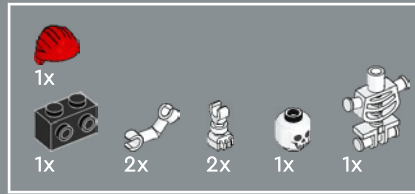

27

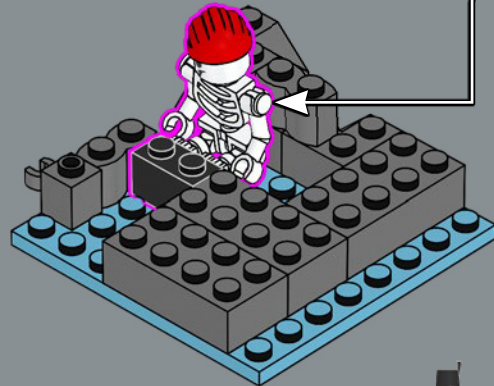
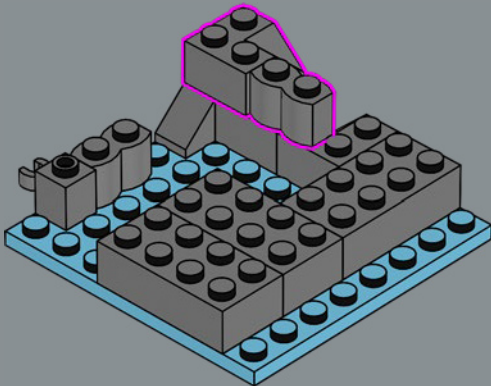
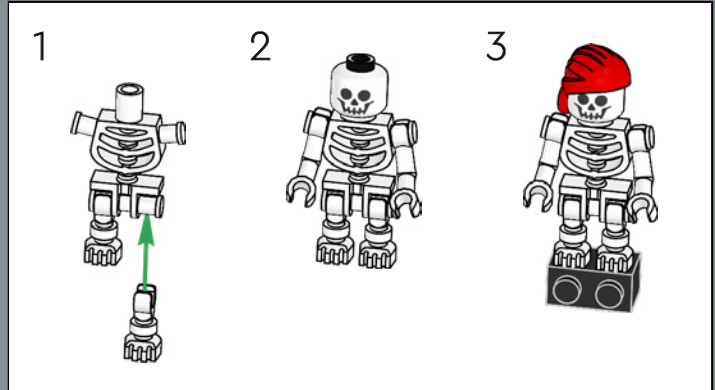



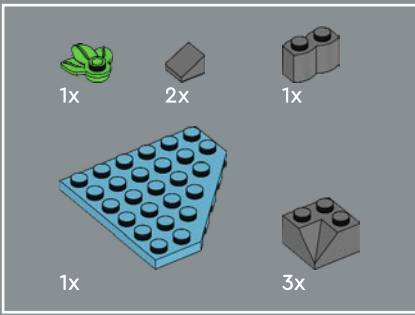

28

1

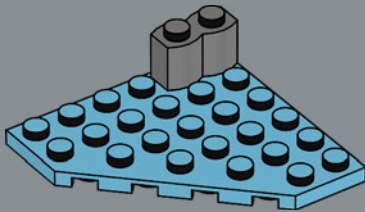

2

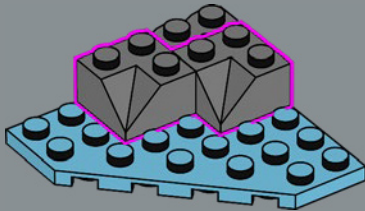

3

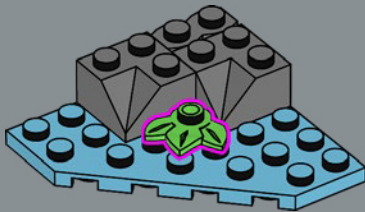

4

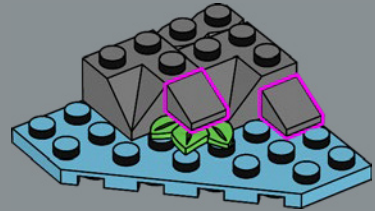

5

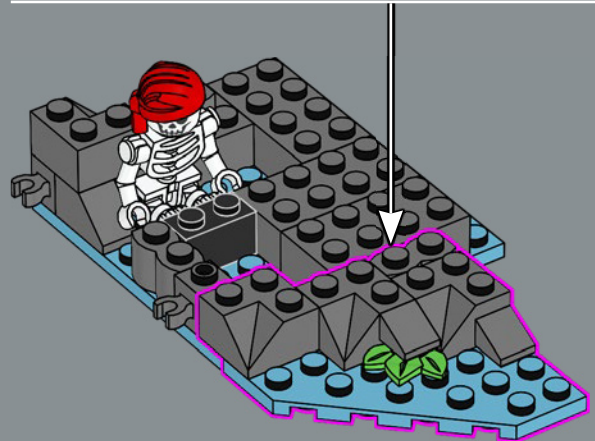
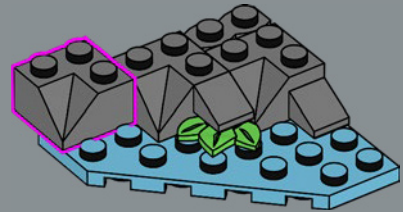

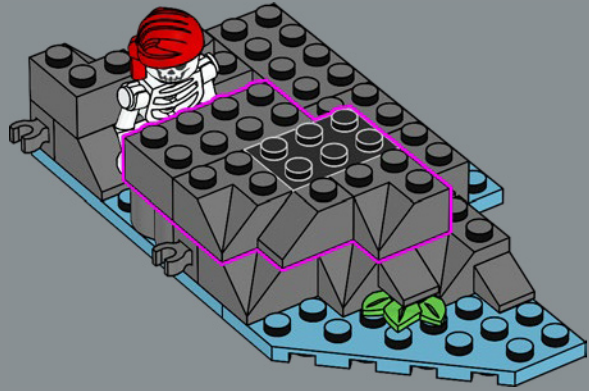
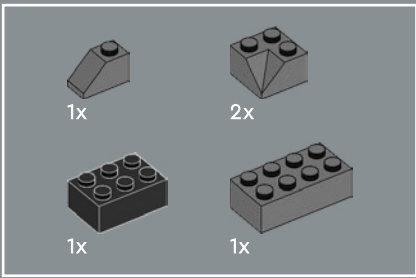

29

30

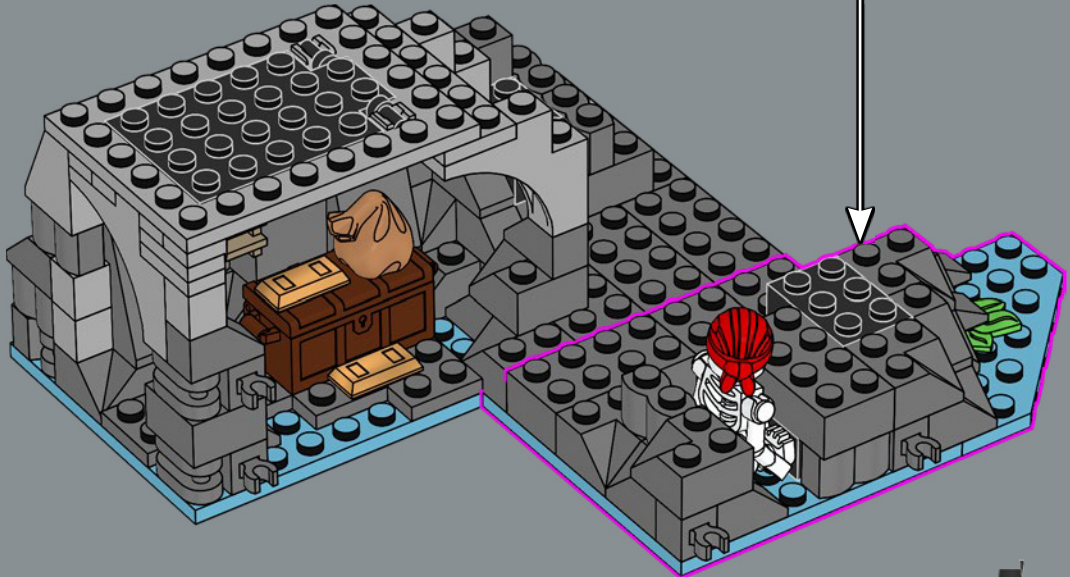

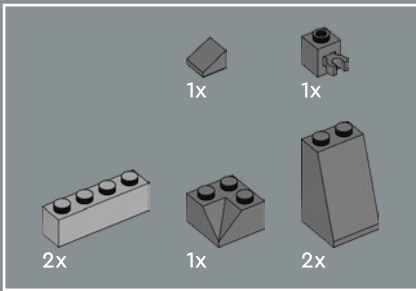

31

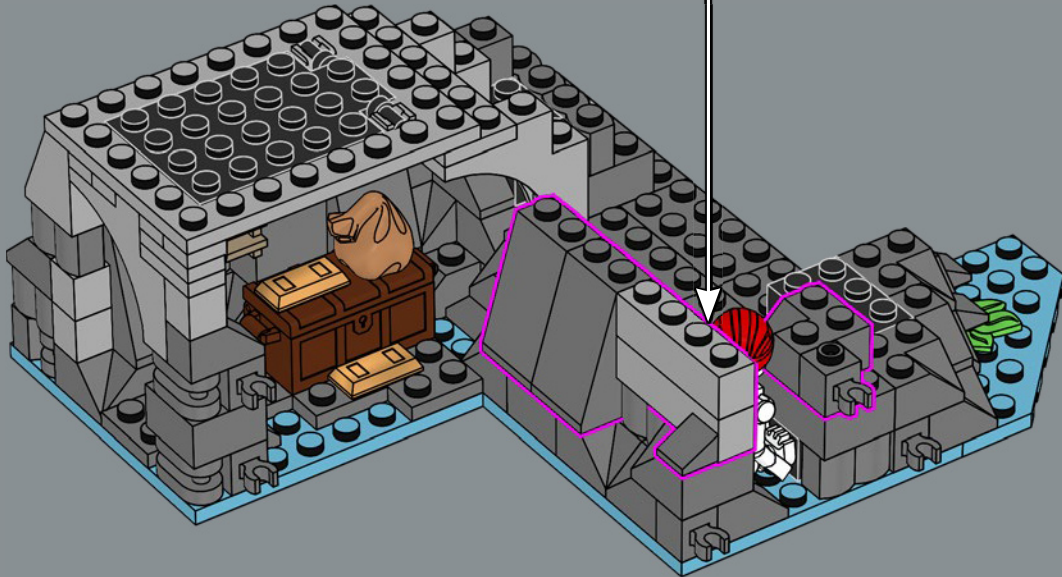
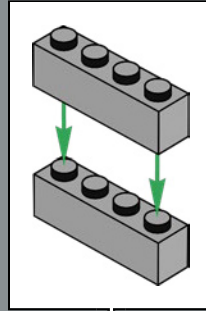

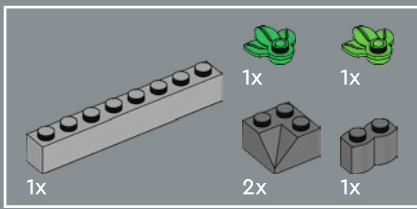

32

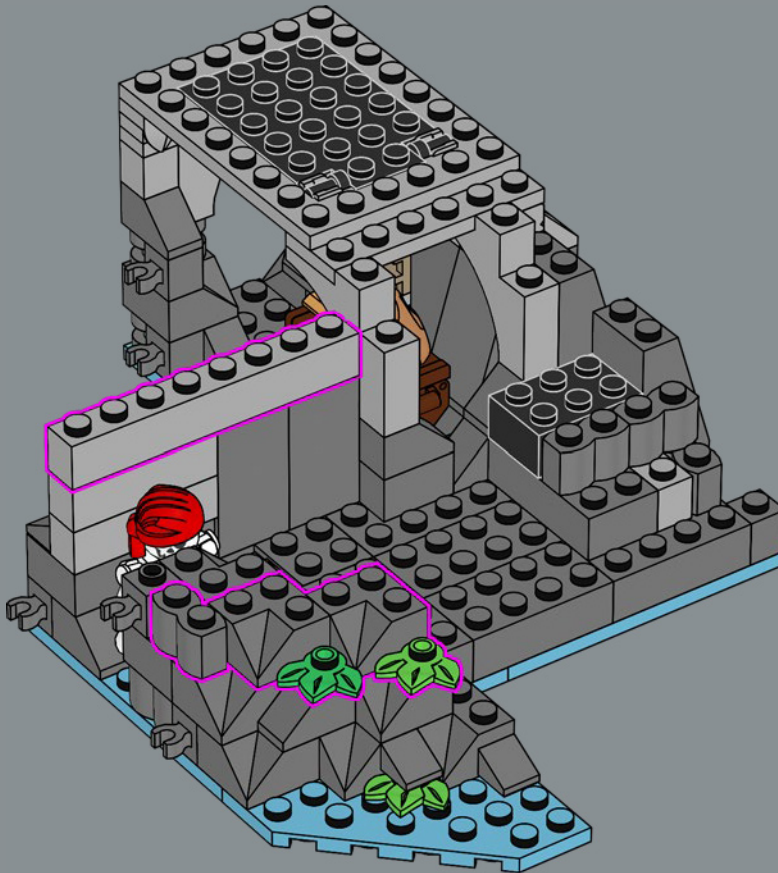

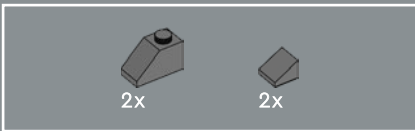

33

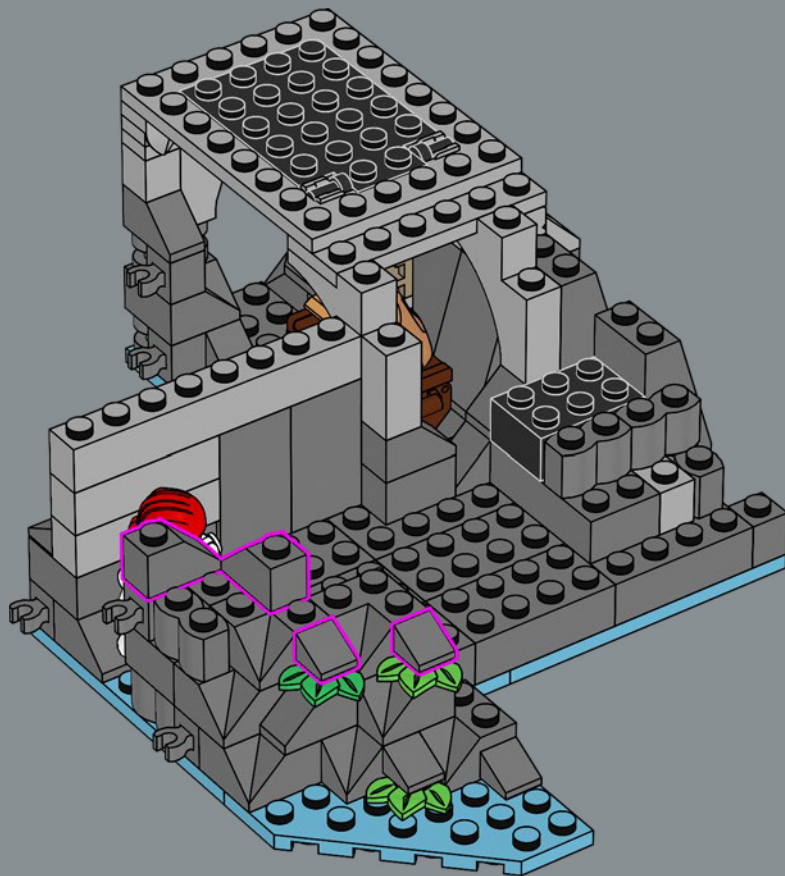

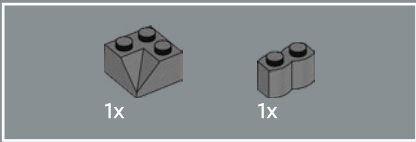

34

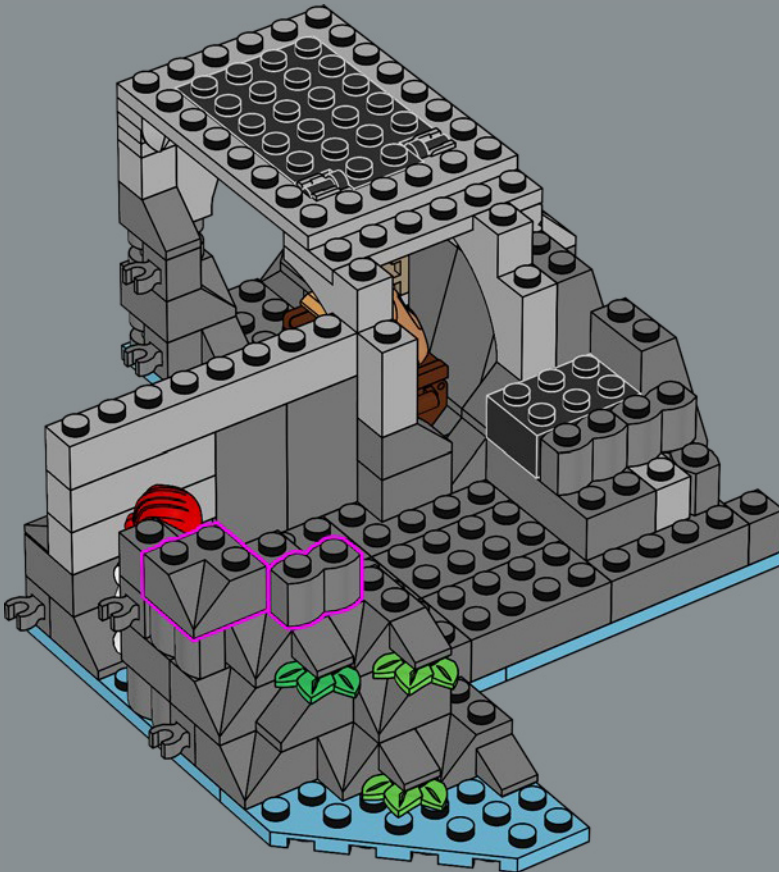

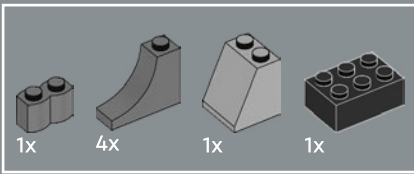

35

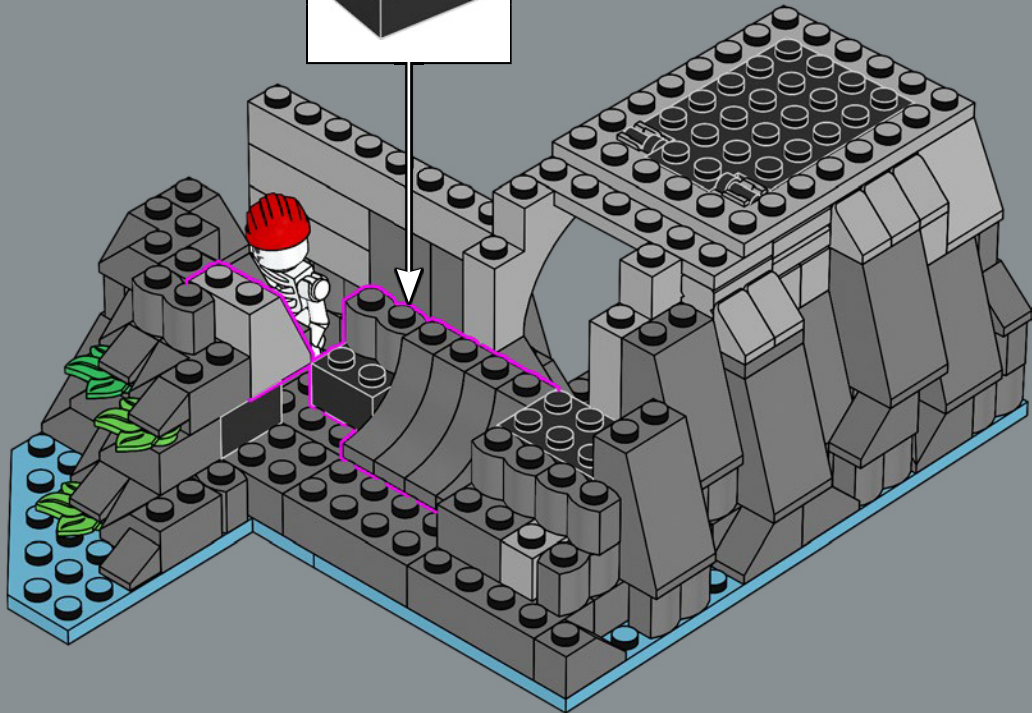
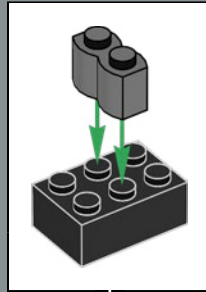

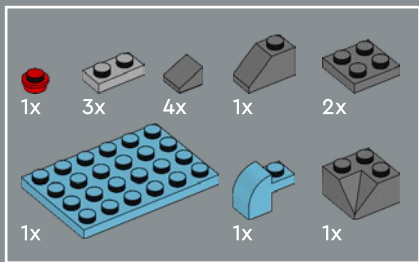

36

1

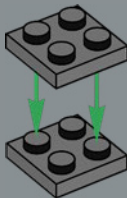

2

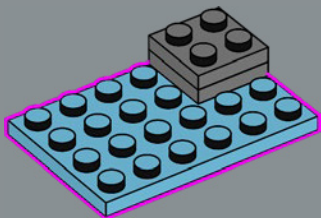

3

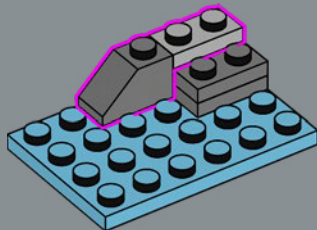

4

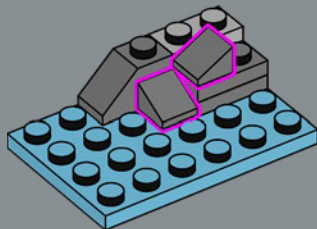

5

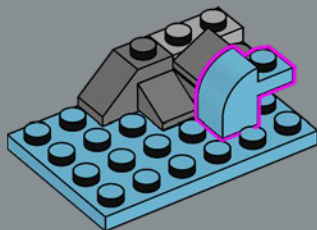

6

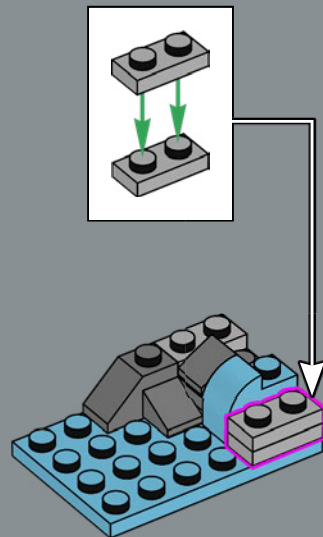

7

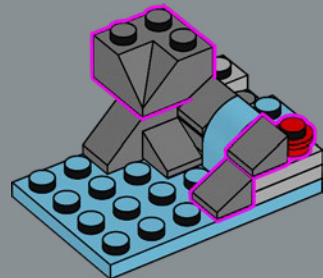



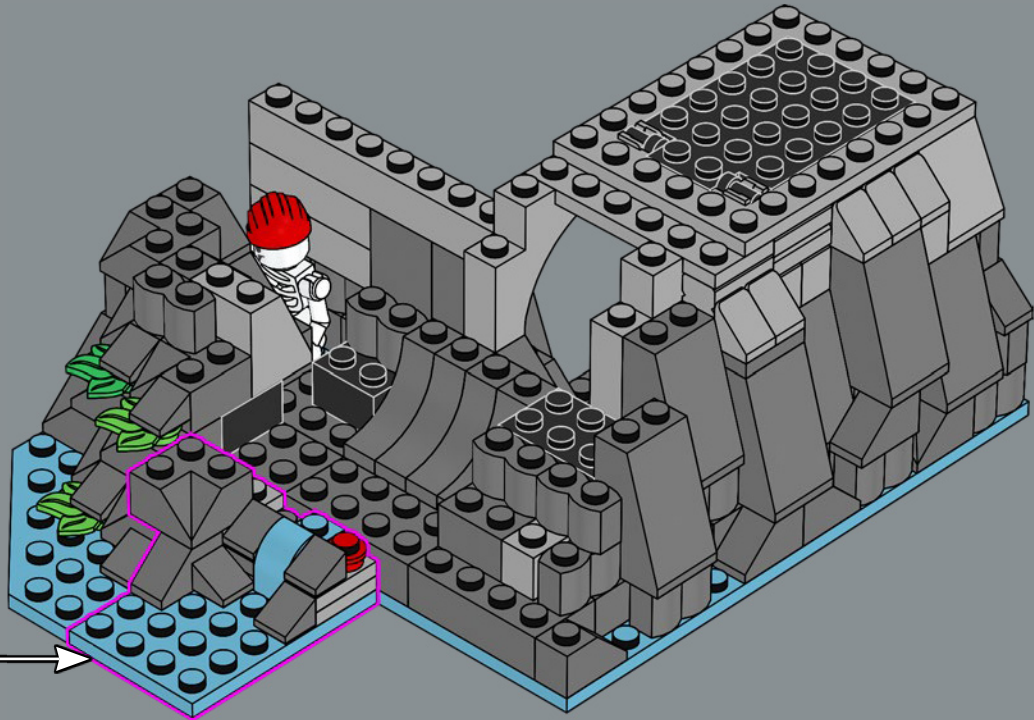

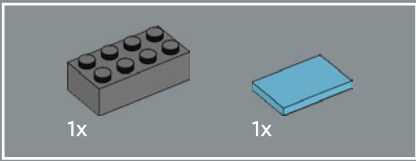

37

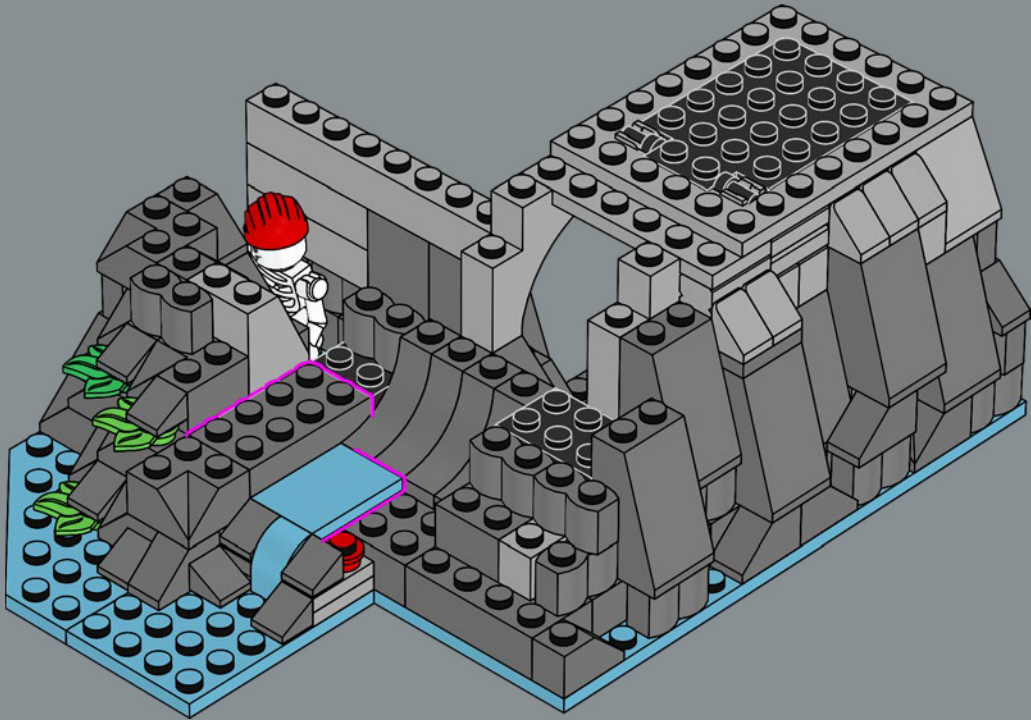

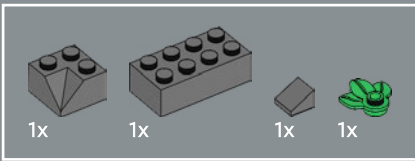

38

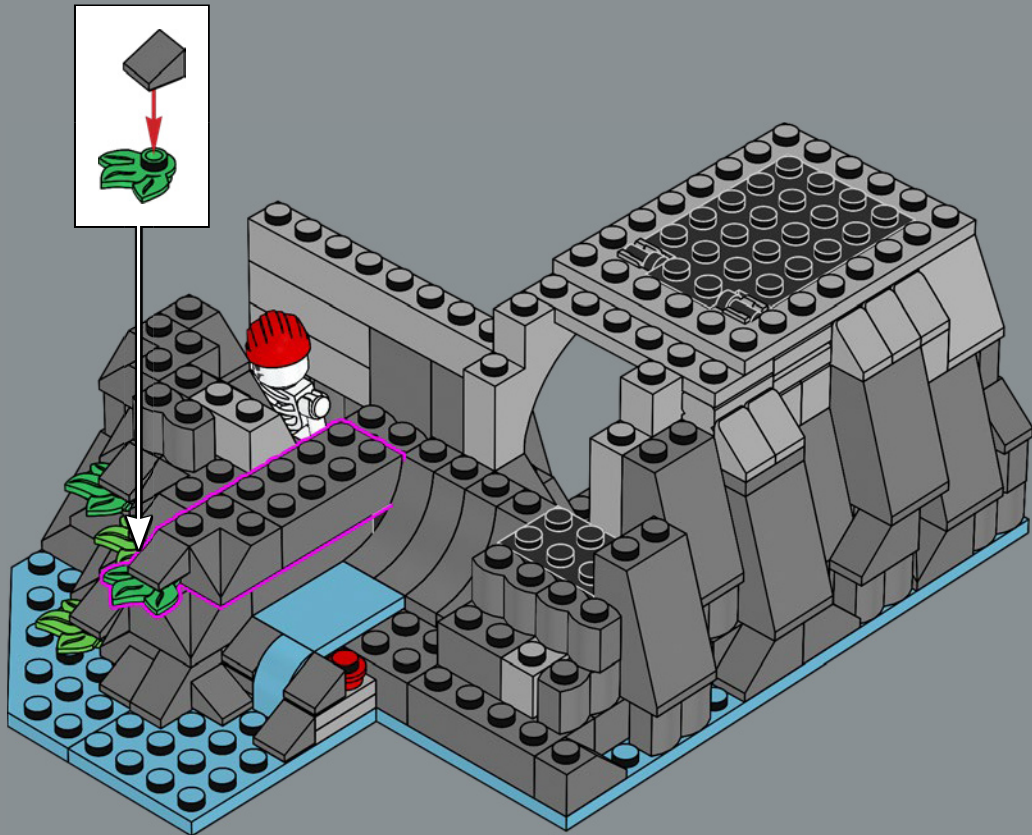

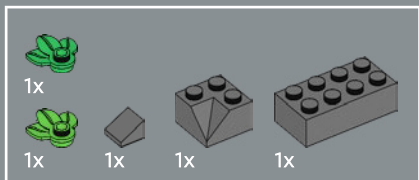

39

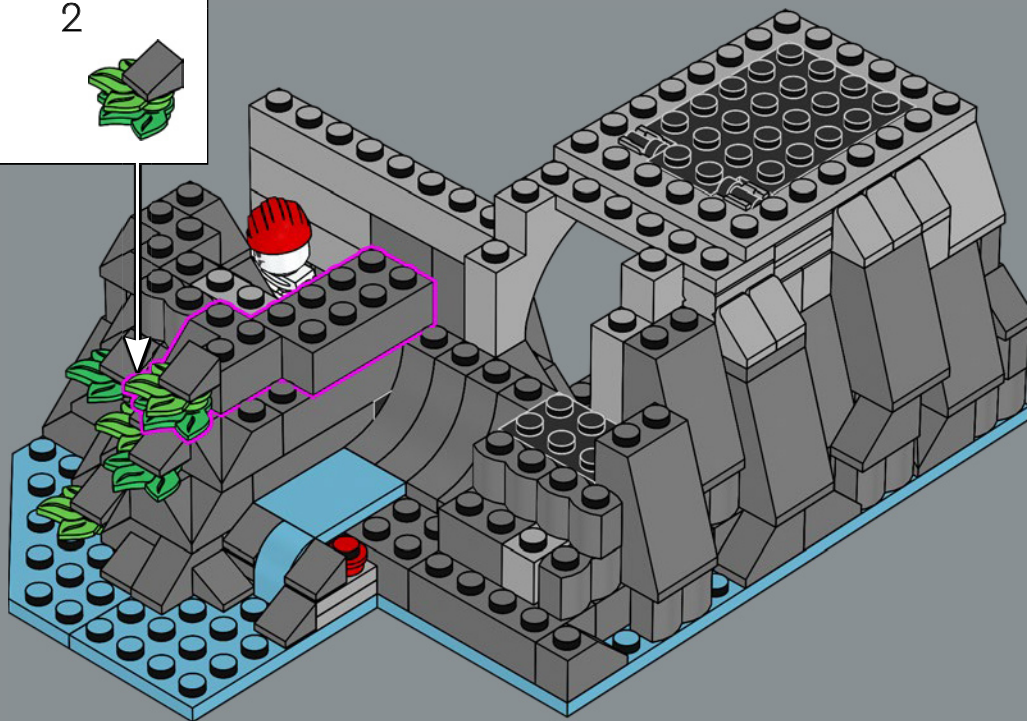
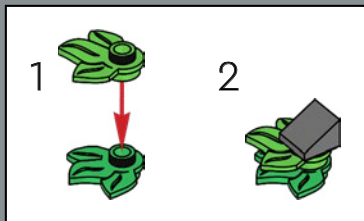

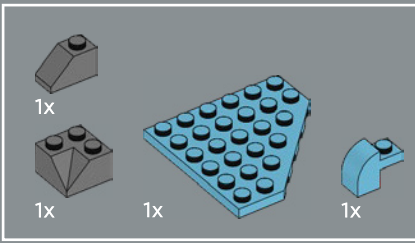

40

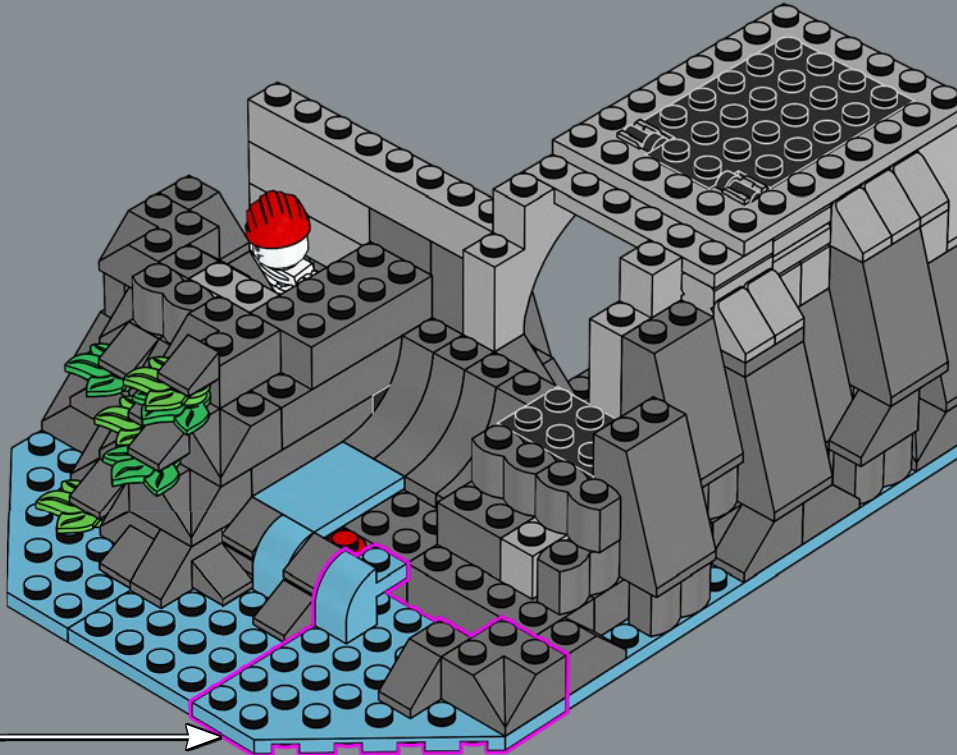
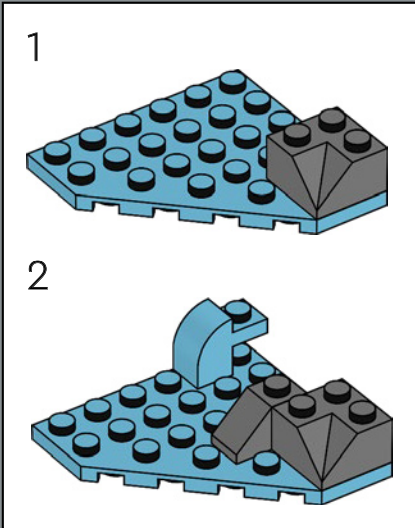

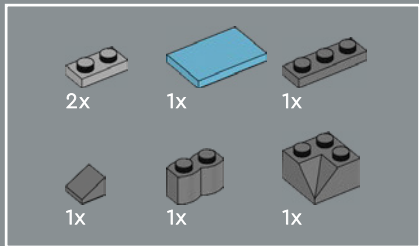

41

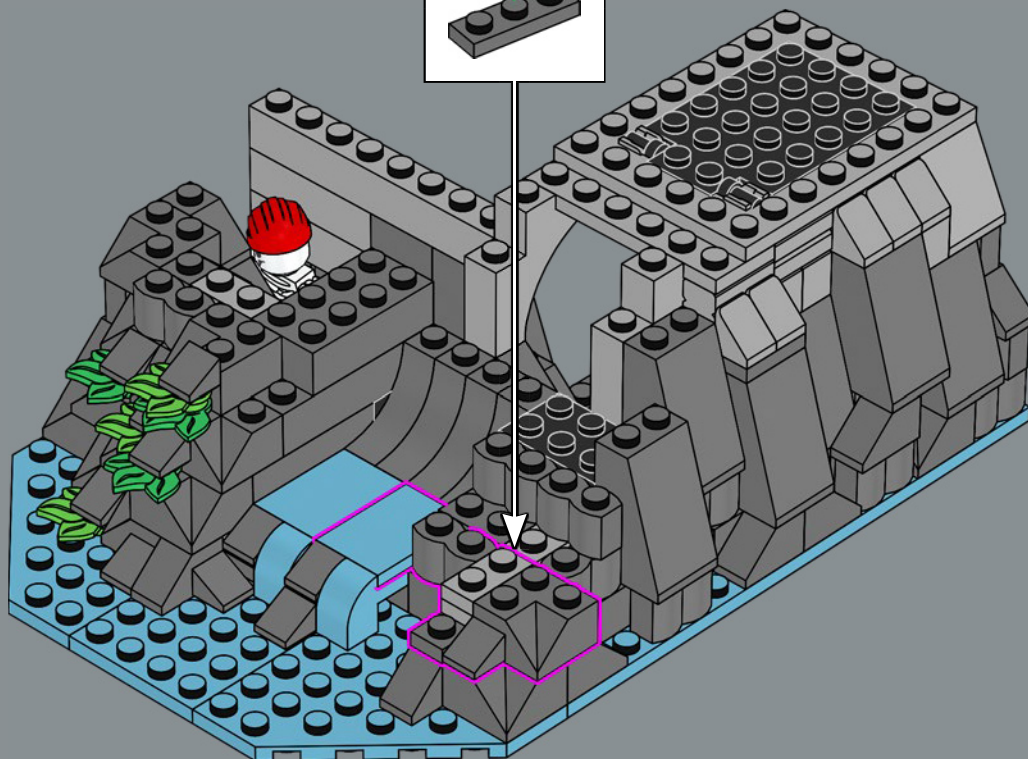
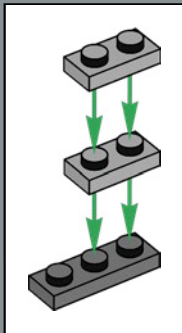

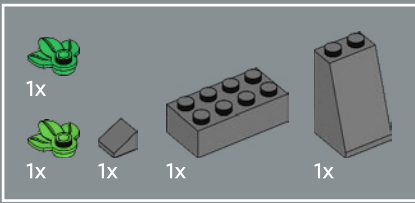

42

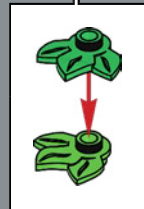
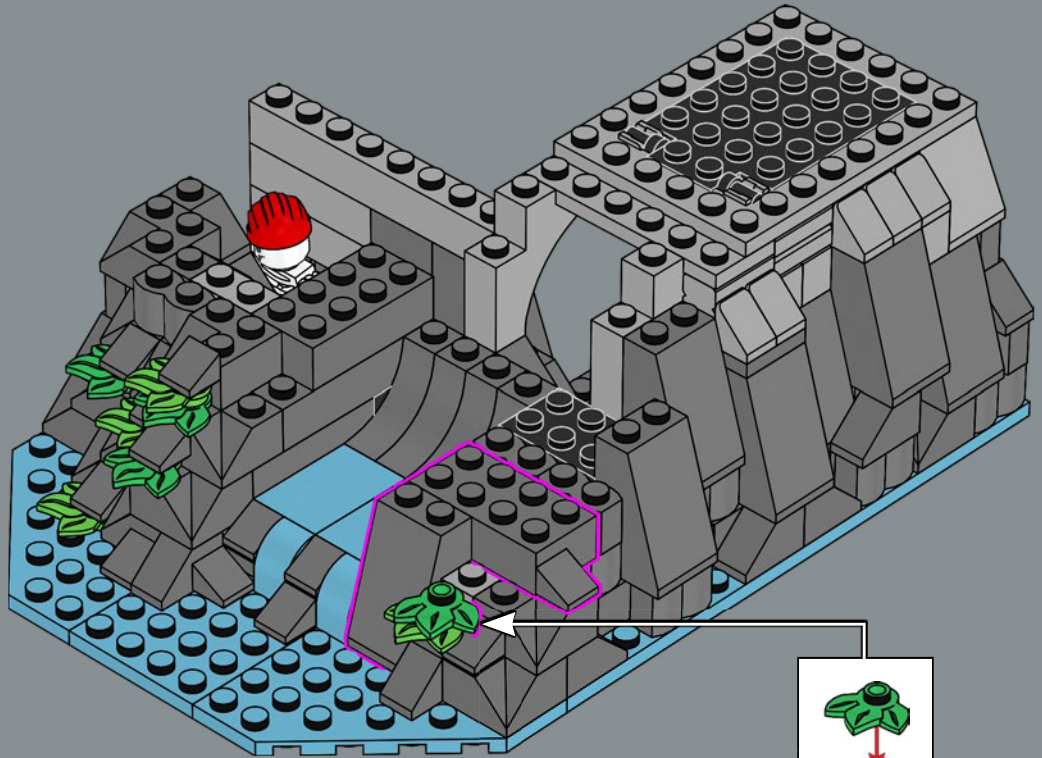

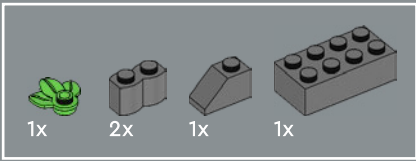

43

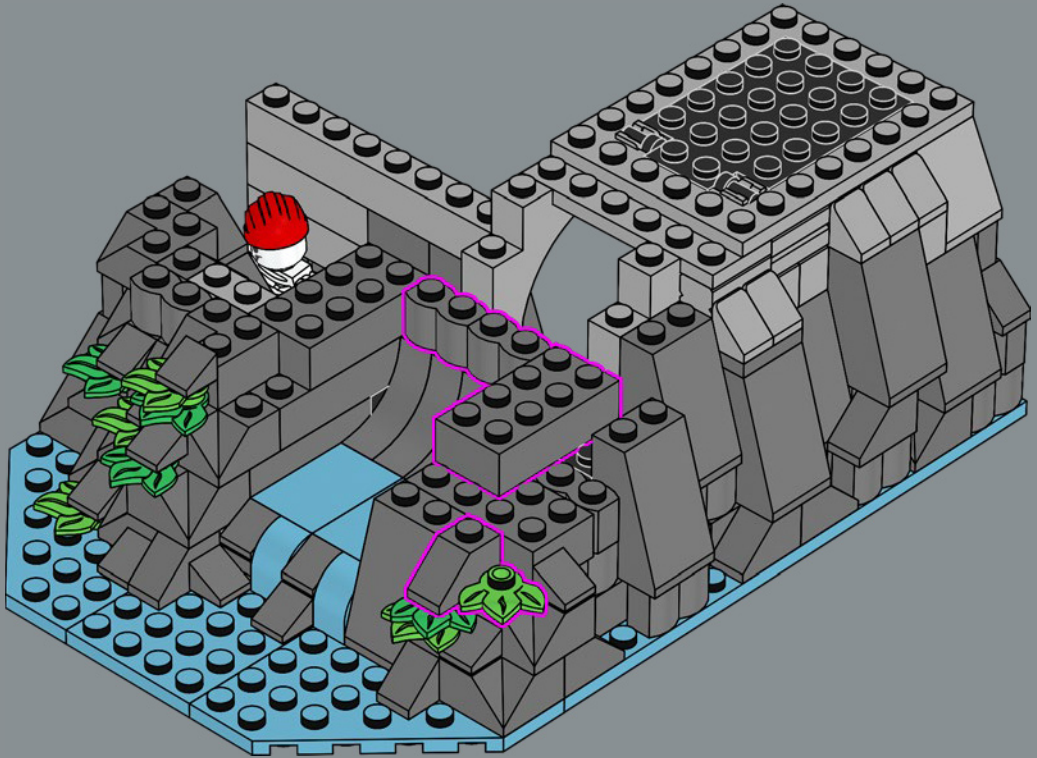



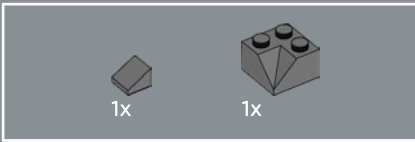

44

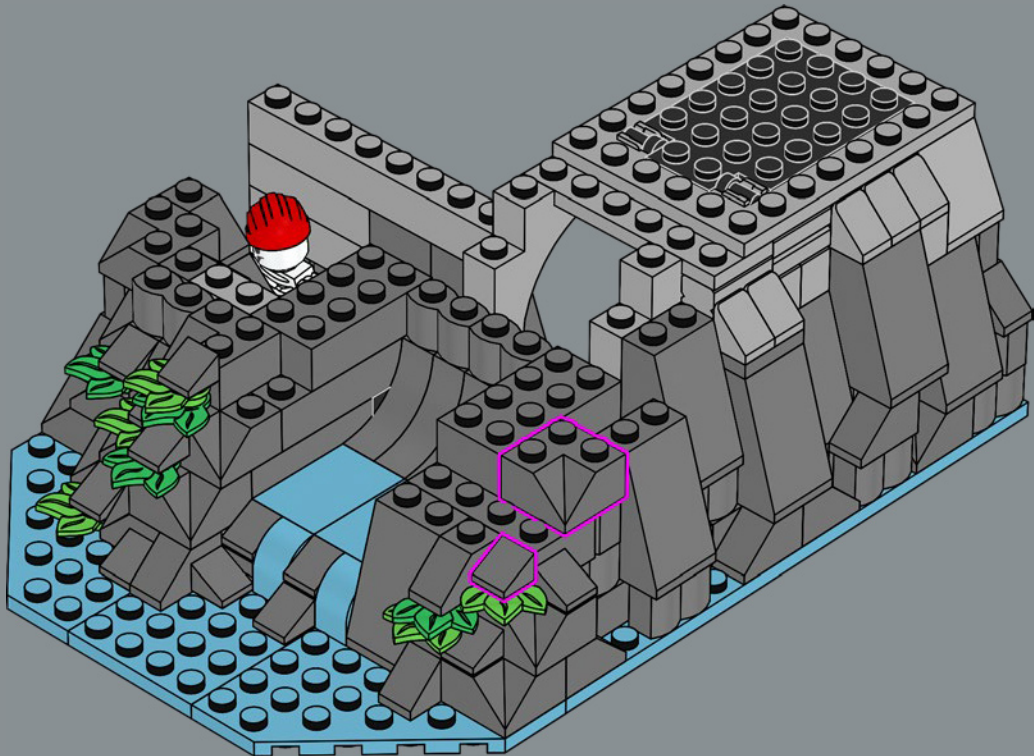

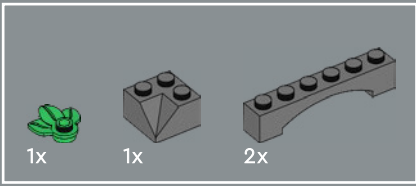

45

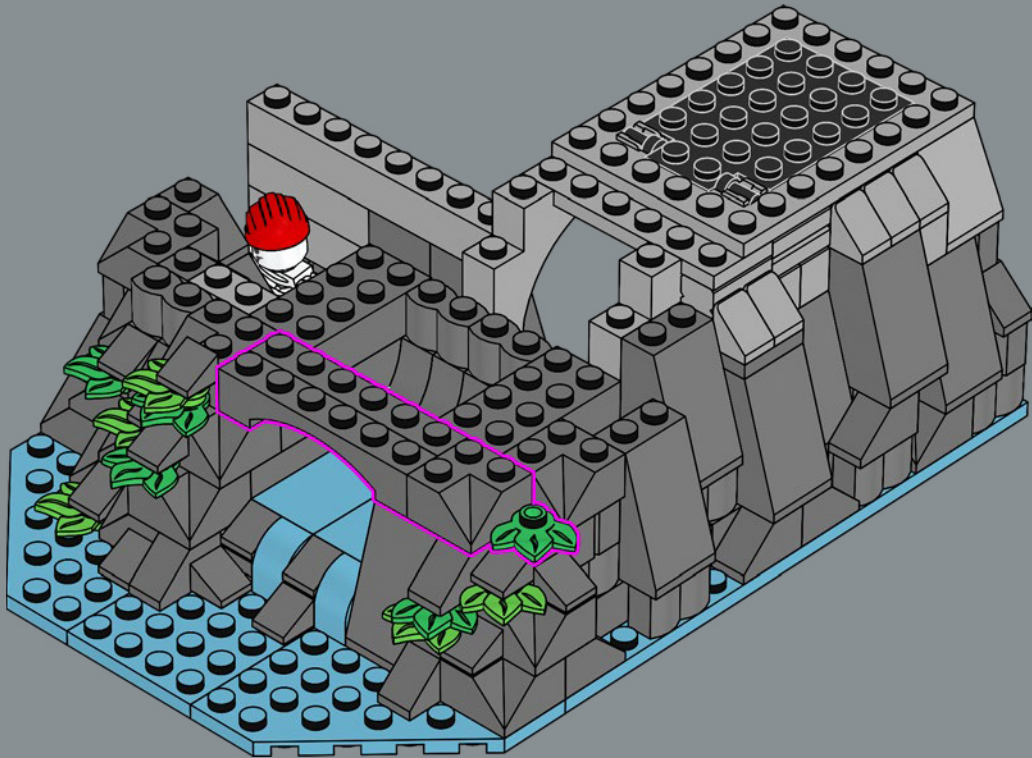

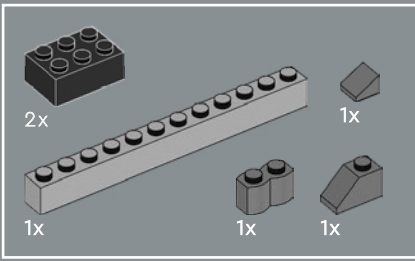

46

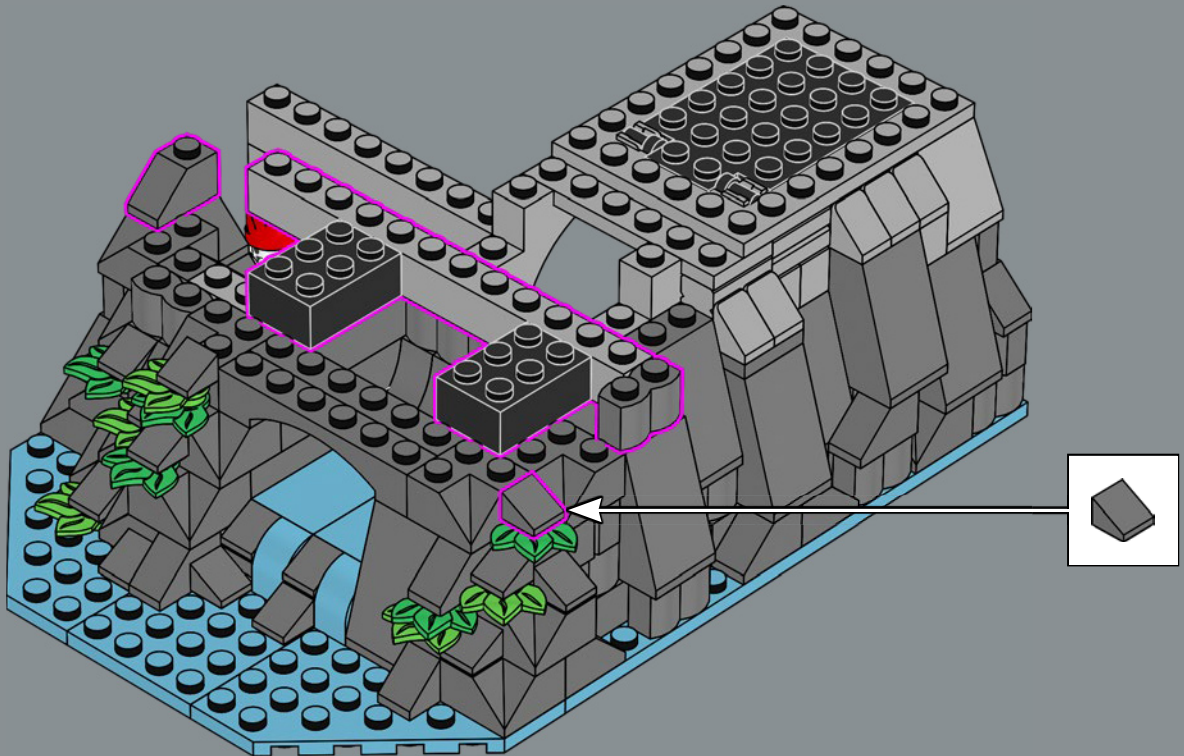

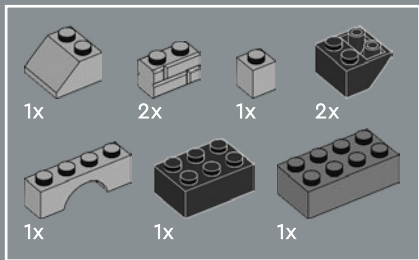

47

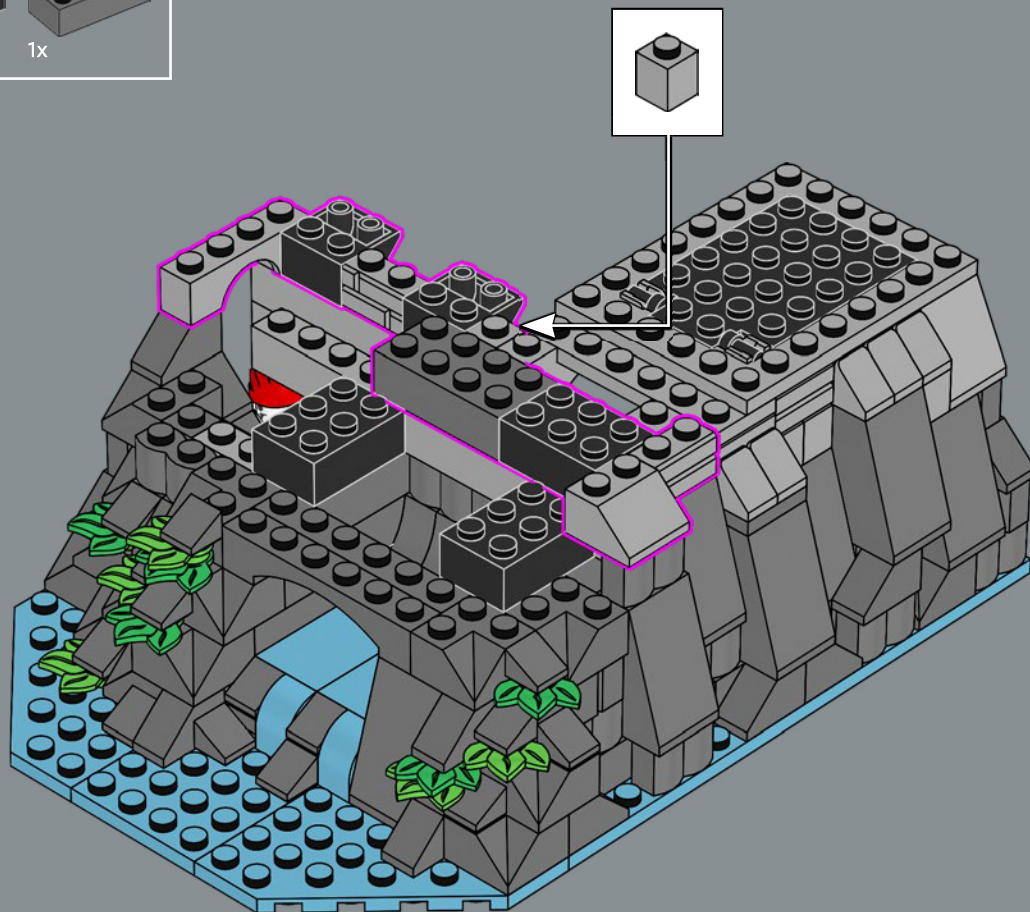

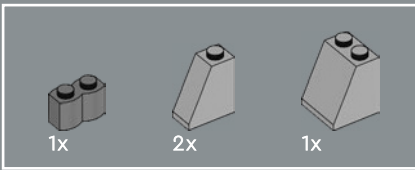

48

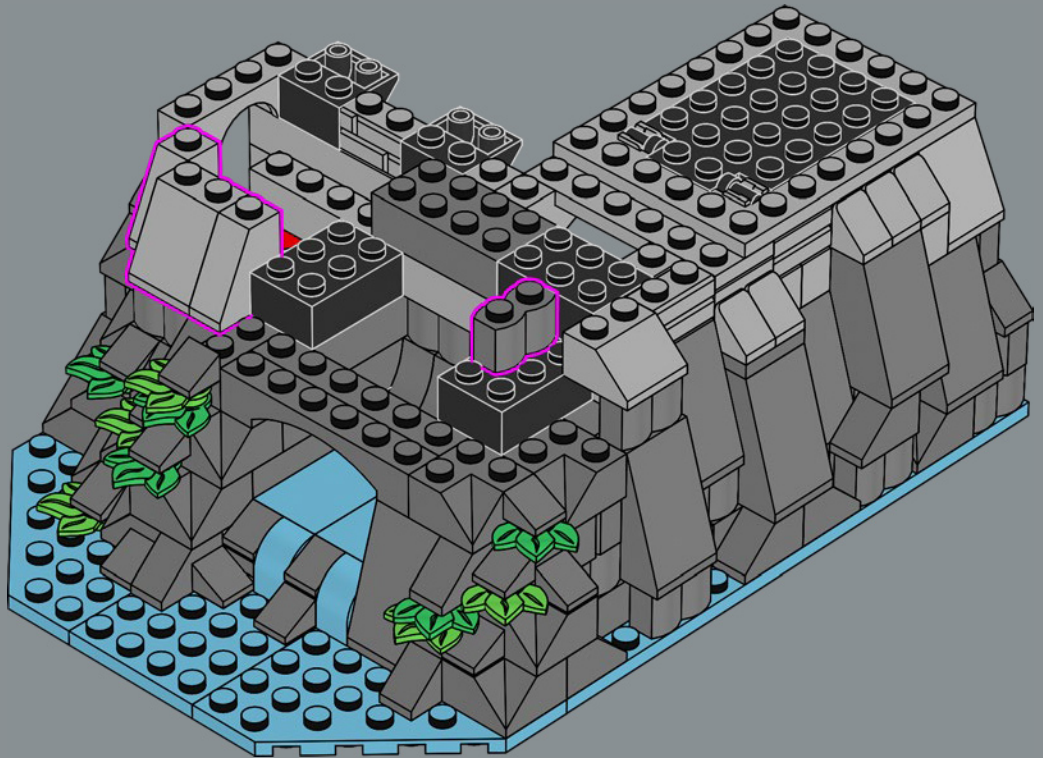

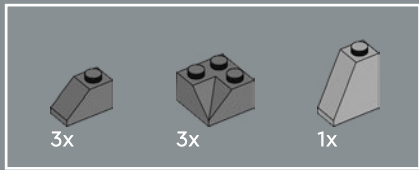

49

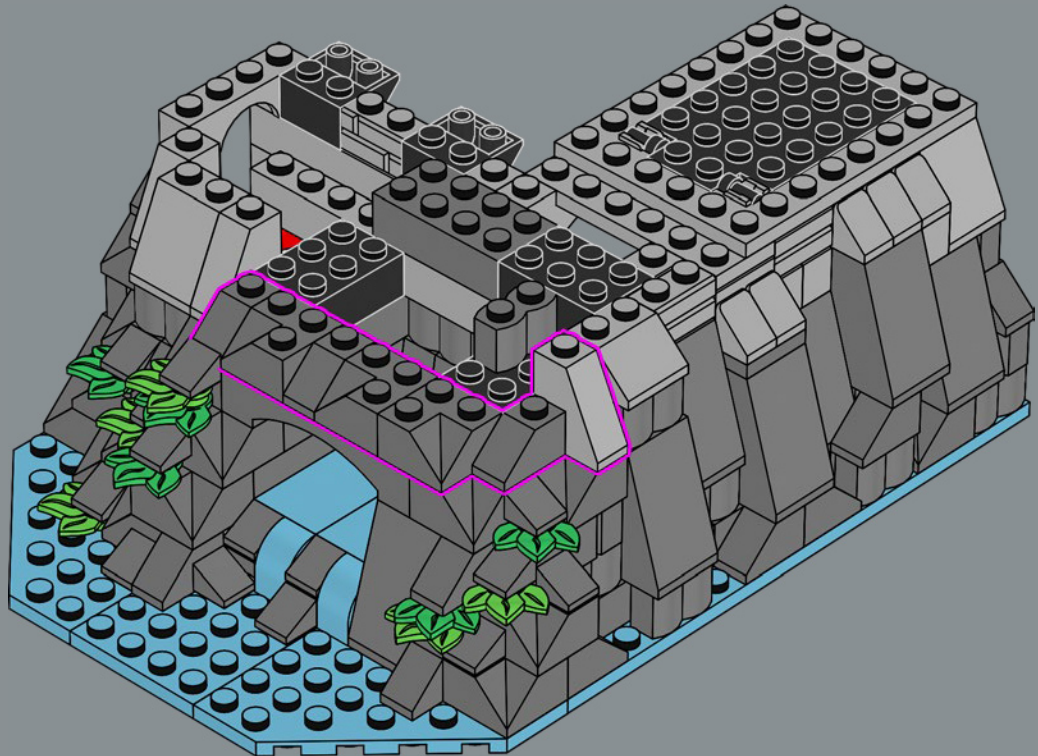

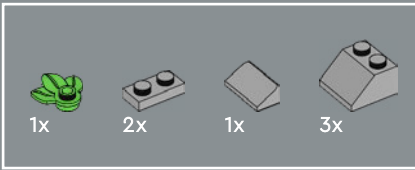

50

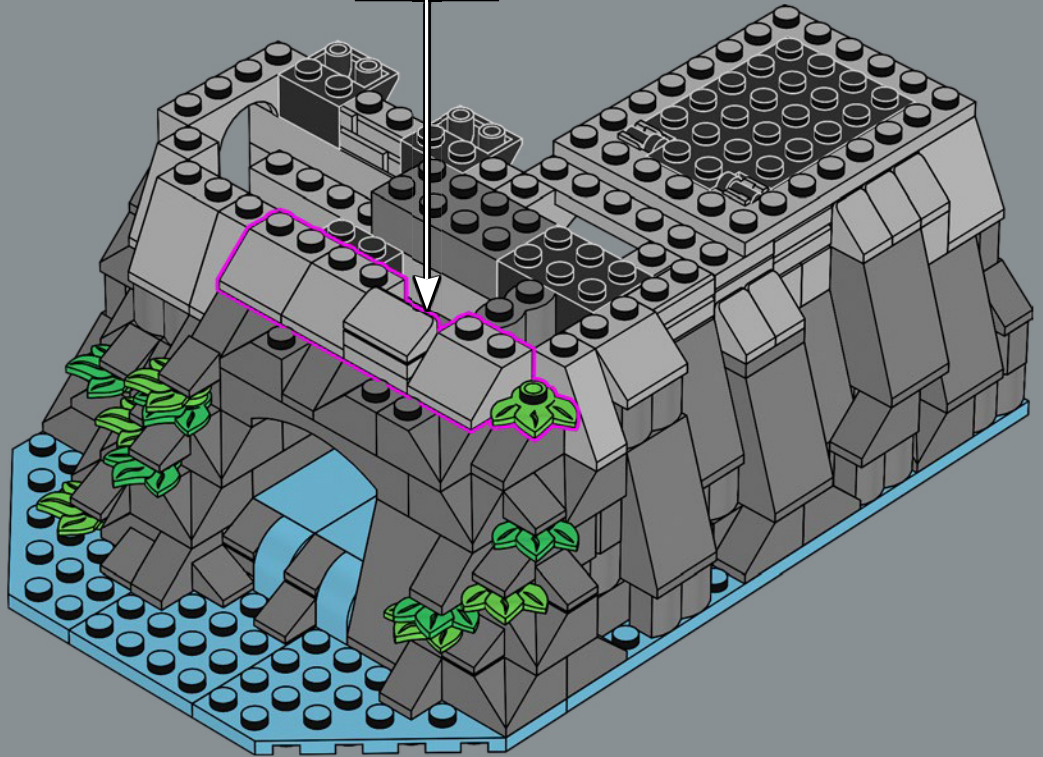
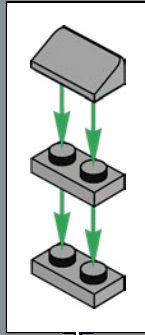

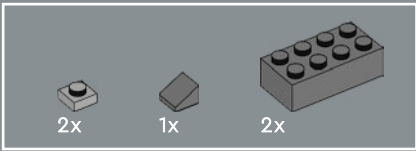

51

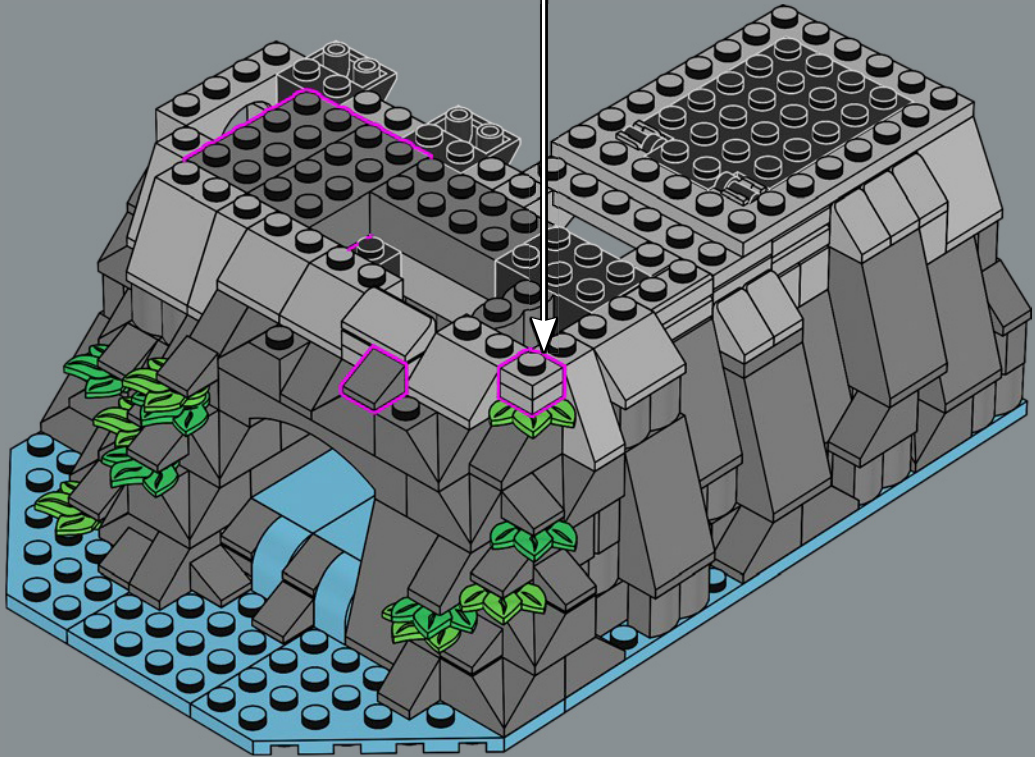
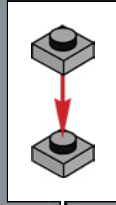



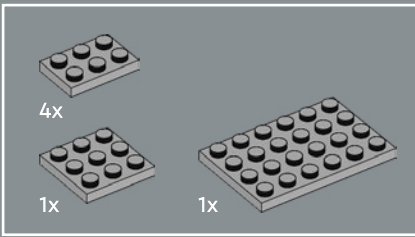

52

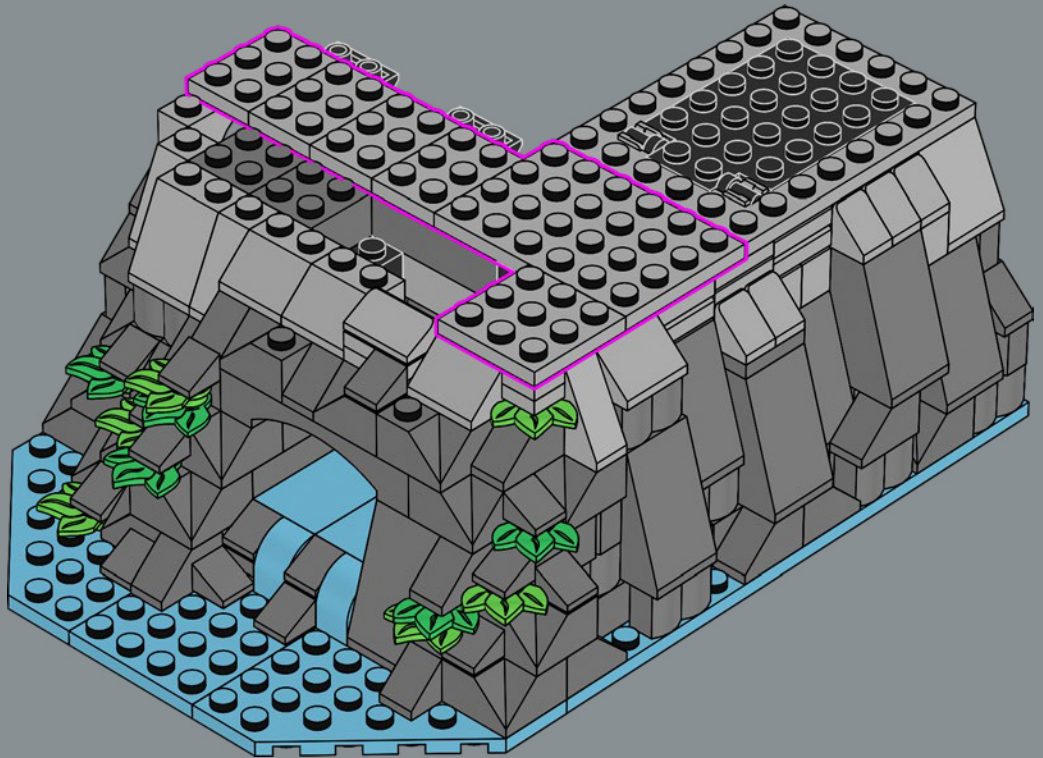



Une trappe astucieusement dissimulée permet aux pirates emprisonnés de s'échapper jusqu'à la plage où leurs amis flibustiers peuvent les récupérer.

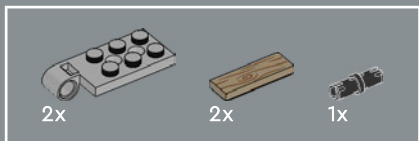

53

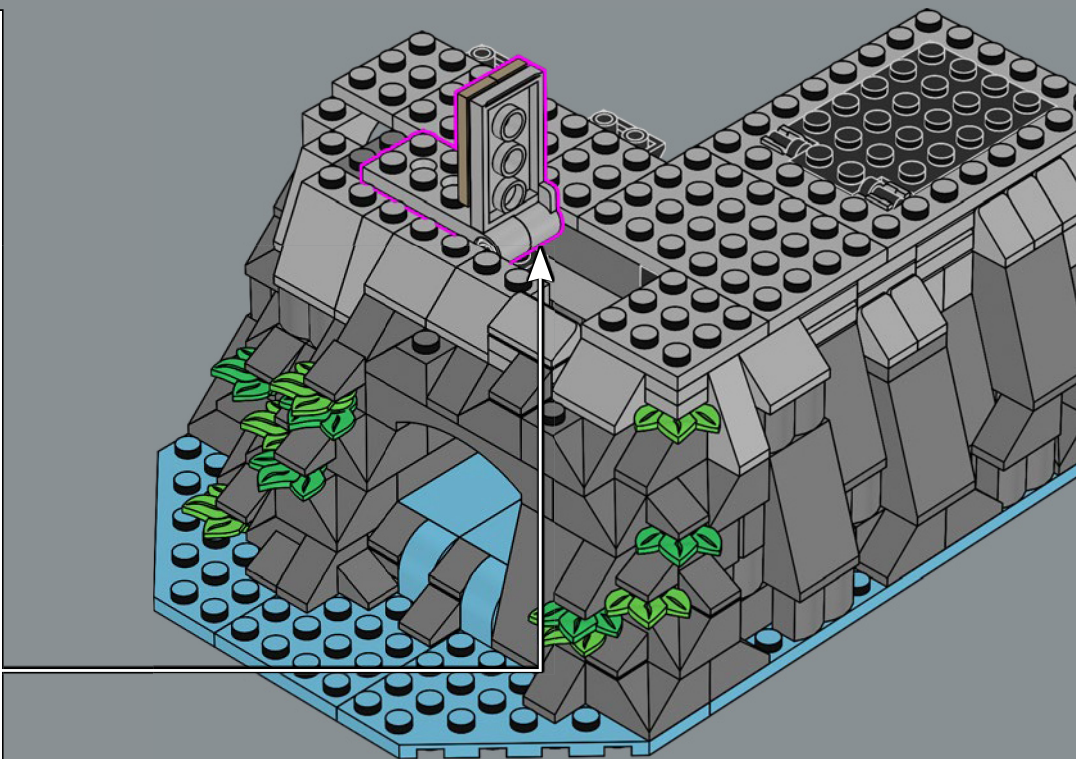
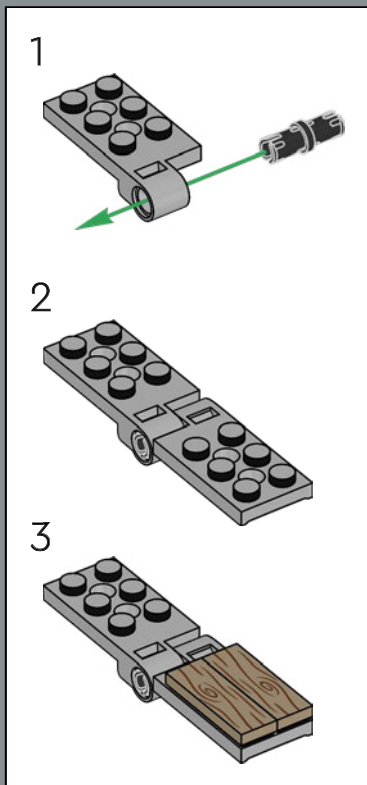

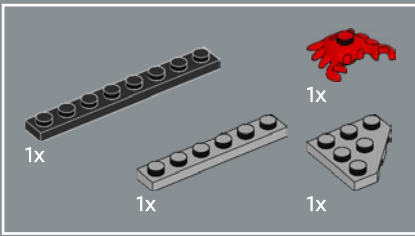

54

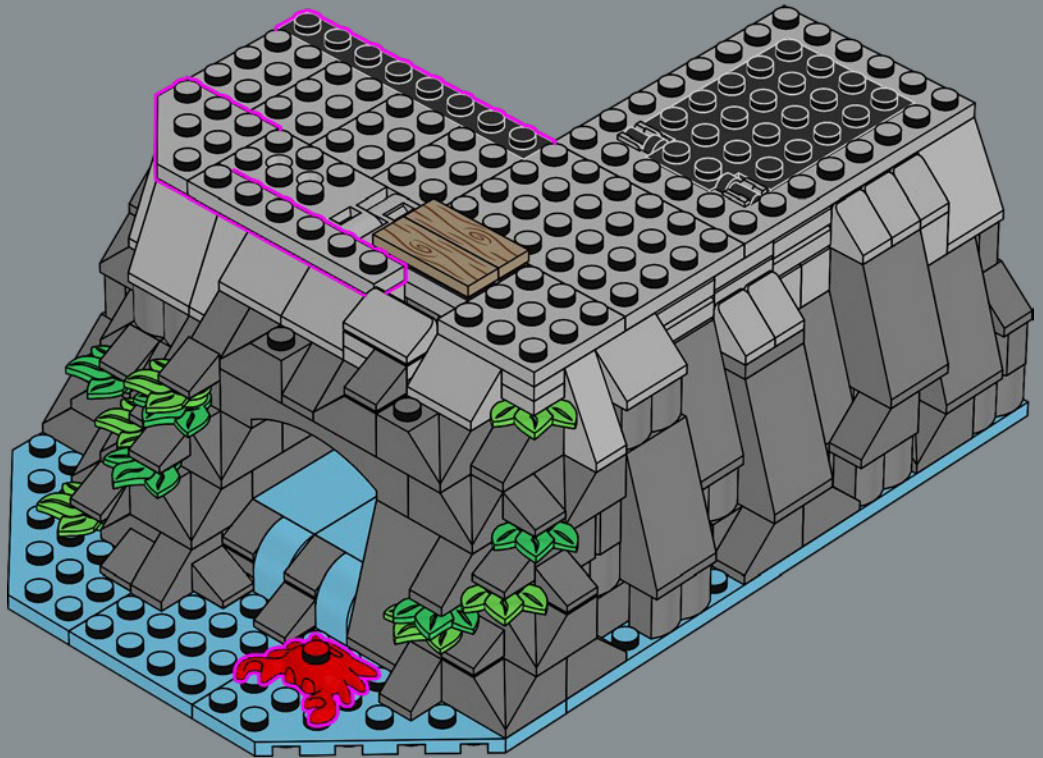



1

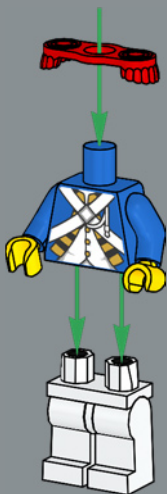

2



3



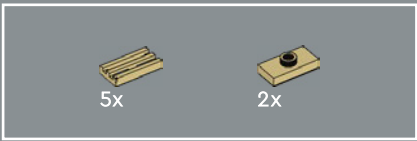

55

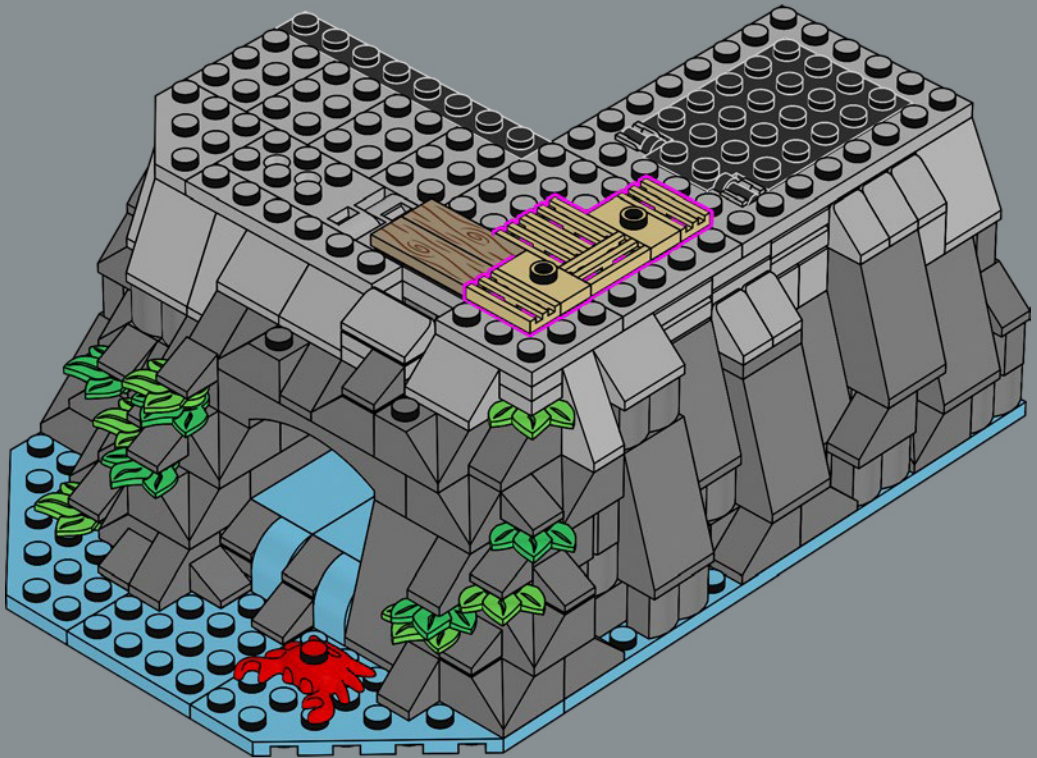

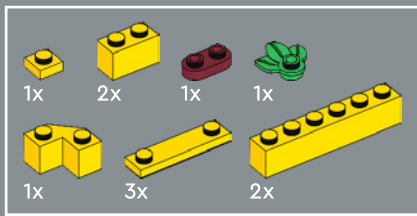

56

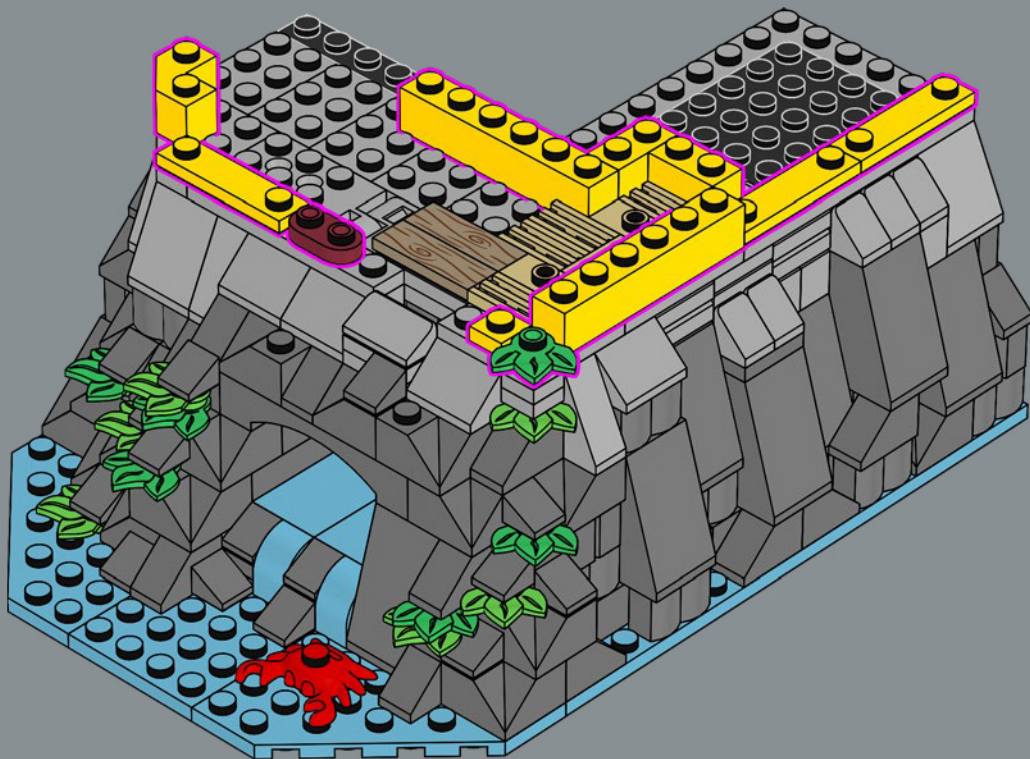



57

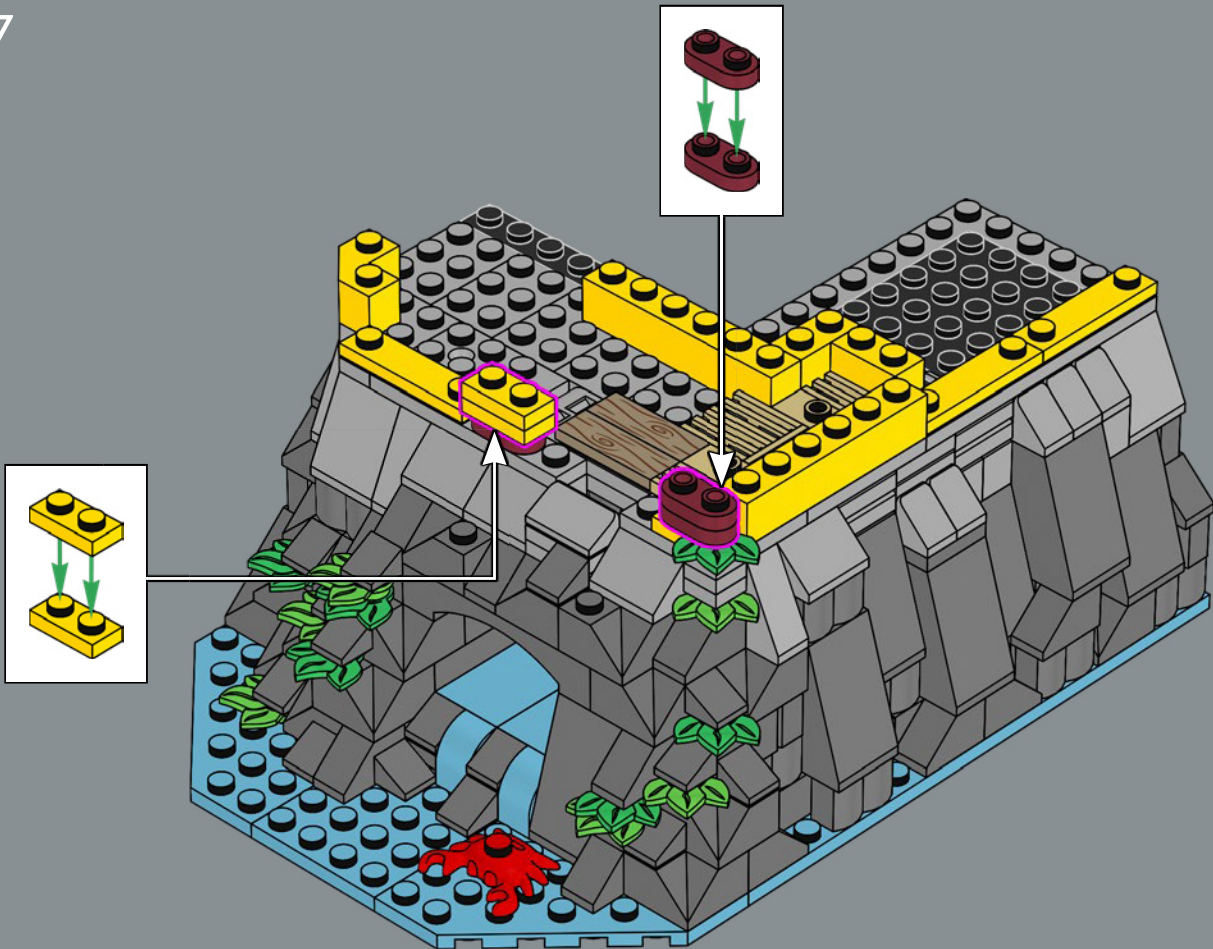

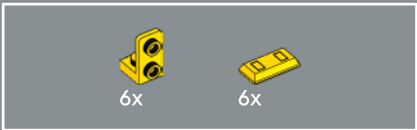

58

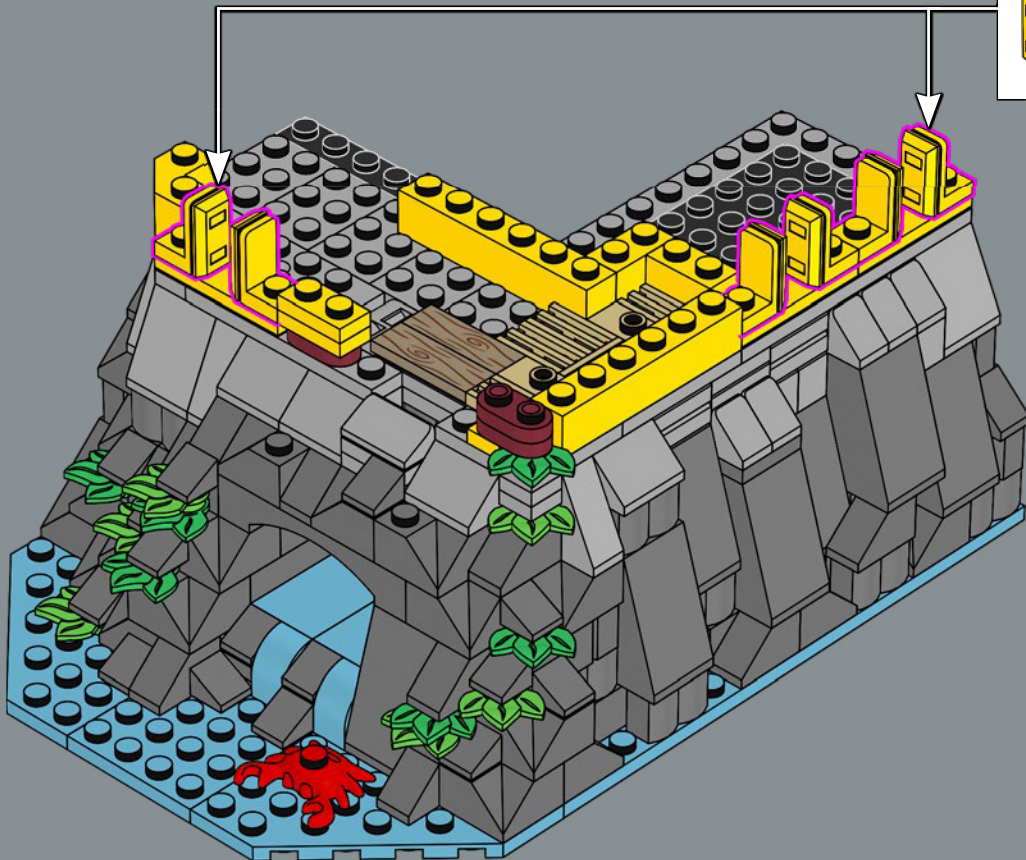
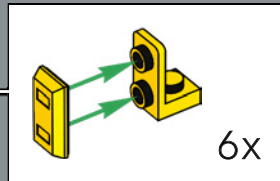





4x



1x

59

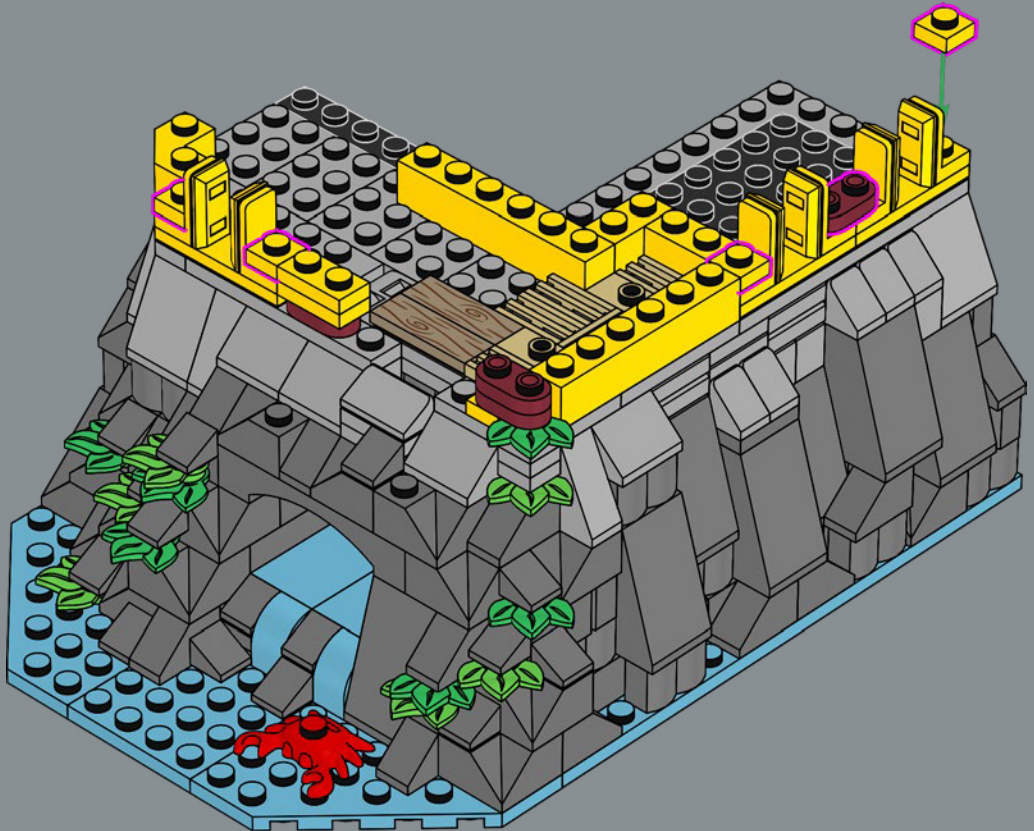



La situation s'est aussi améliorée pour les pirates faits prisonniers ! Ils peuvent maintenant se reposer confortablement sur des matelas de foin.



60

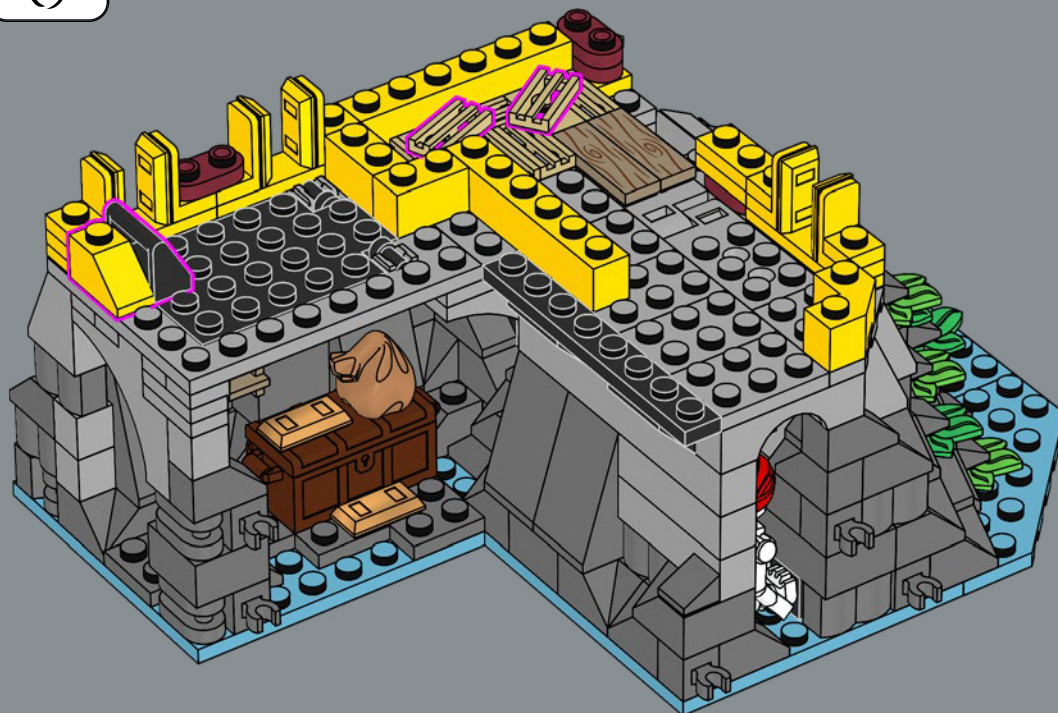



2x



2x



2x

61

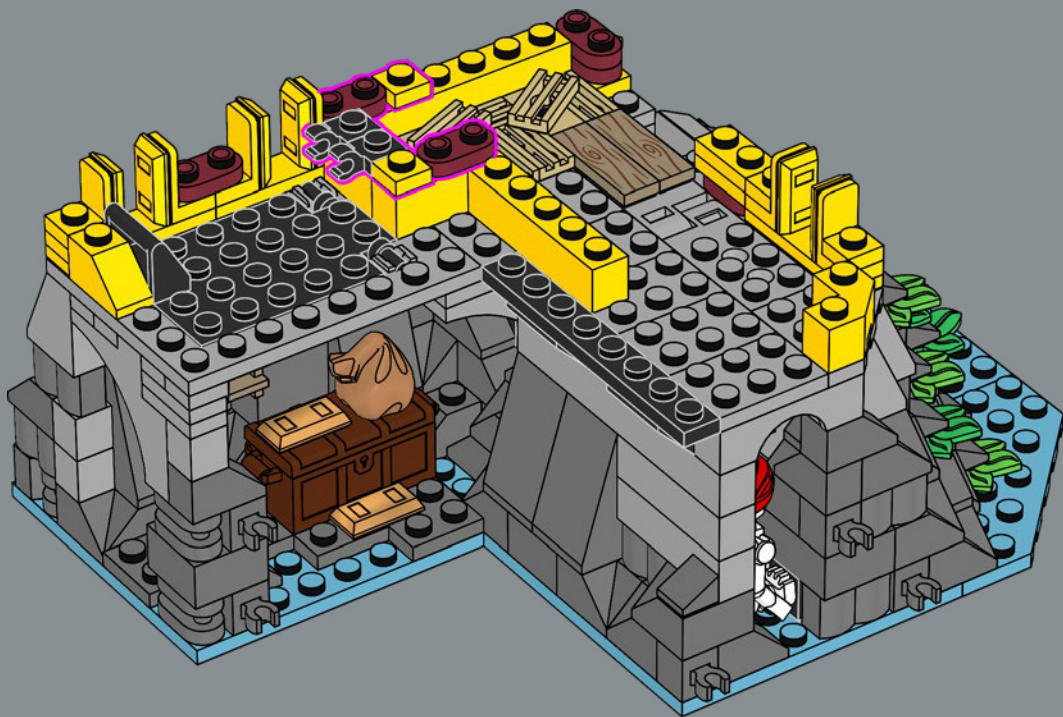



62

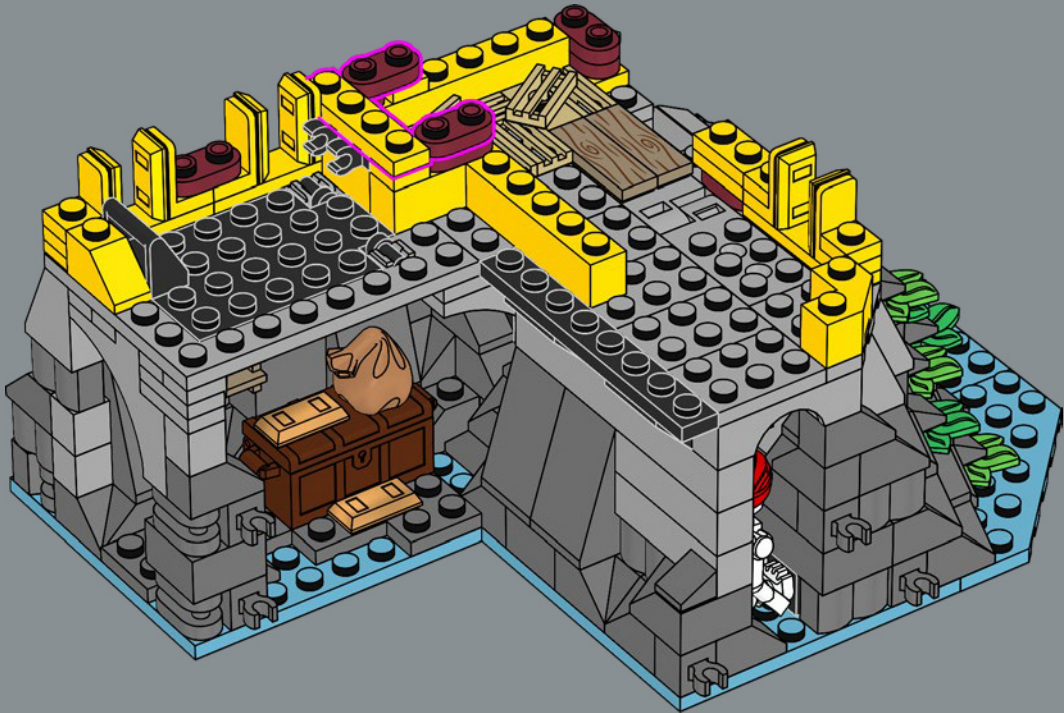

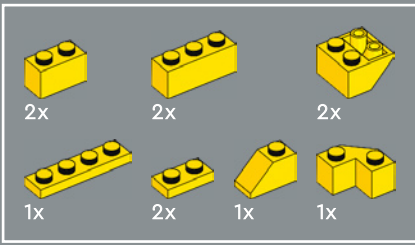

63

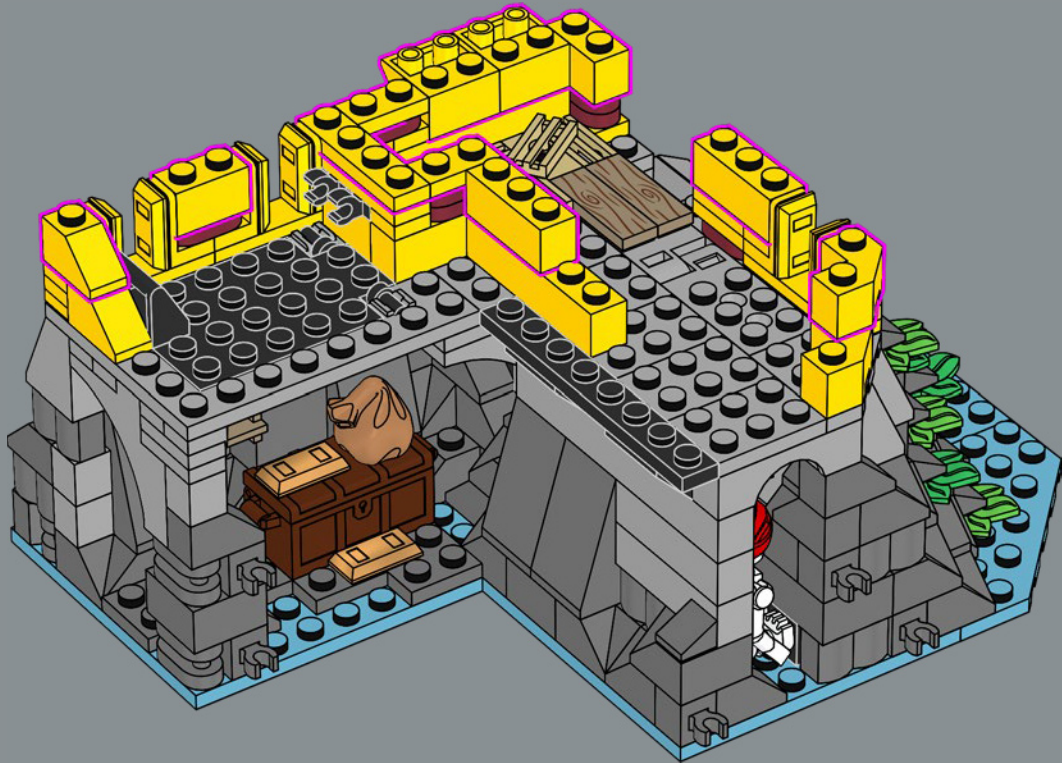



64

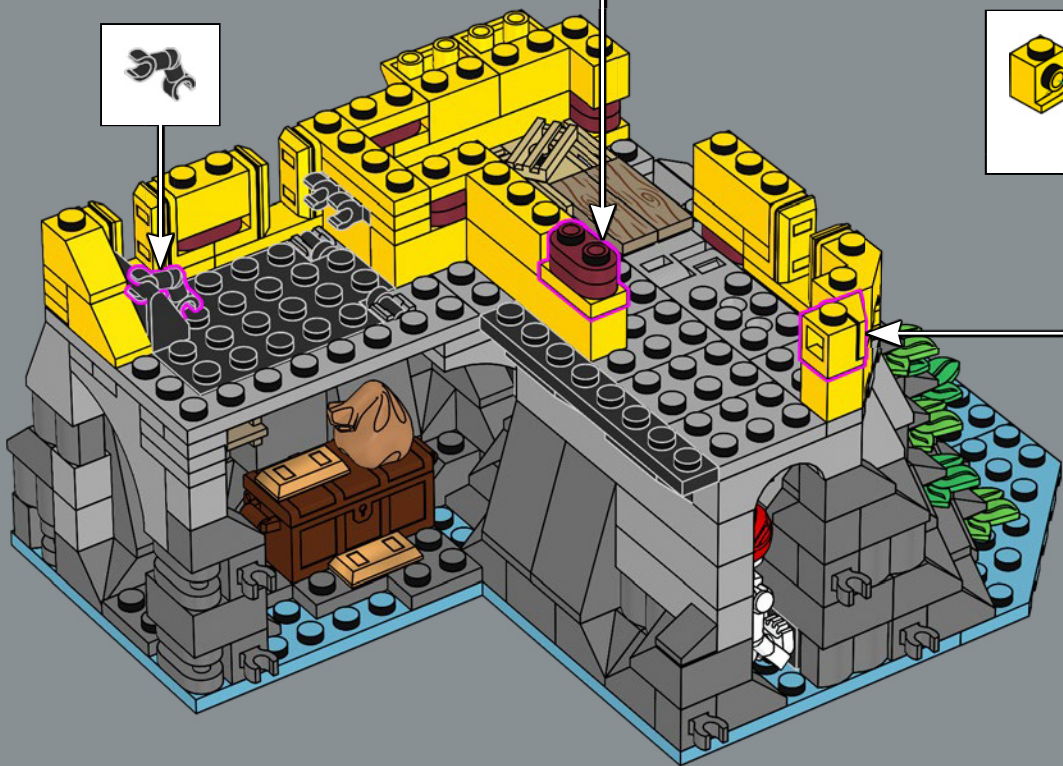
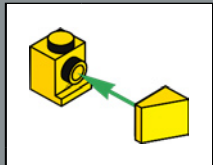
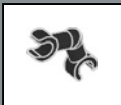
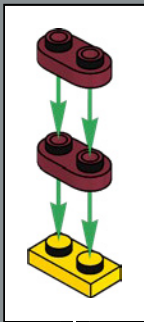

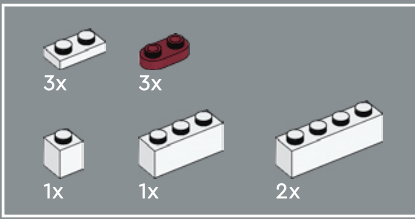

65

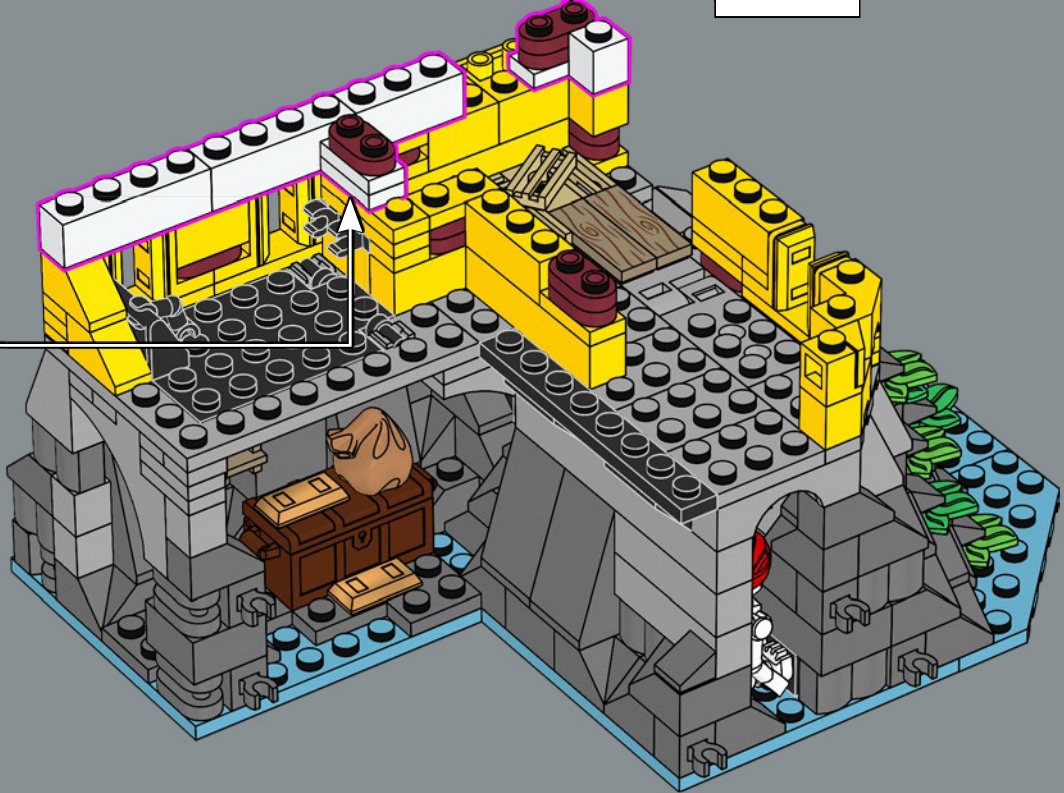
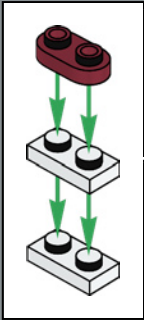
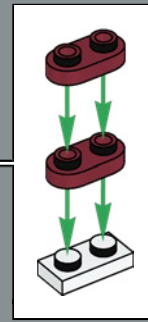

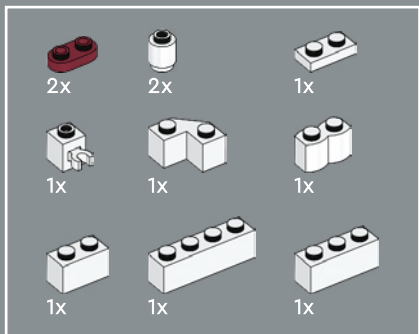

66

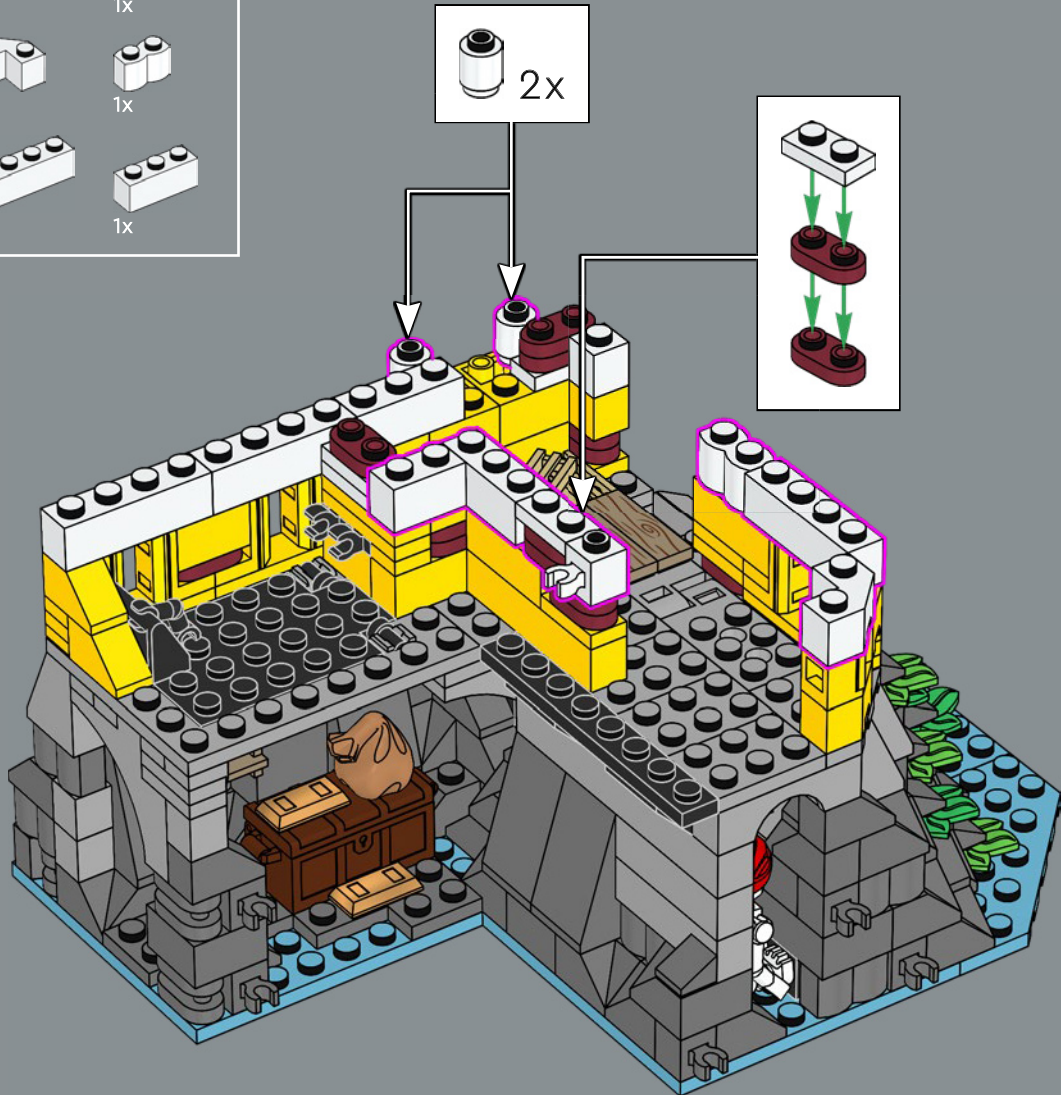
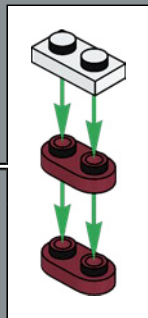
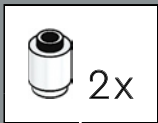



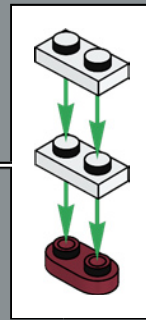
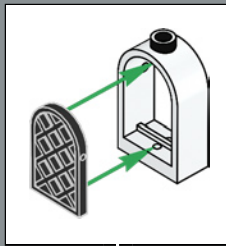
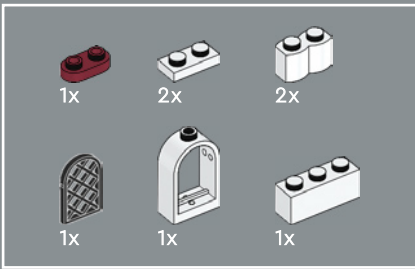

67

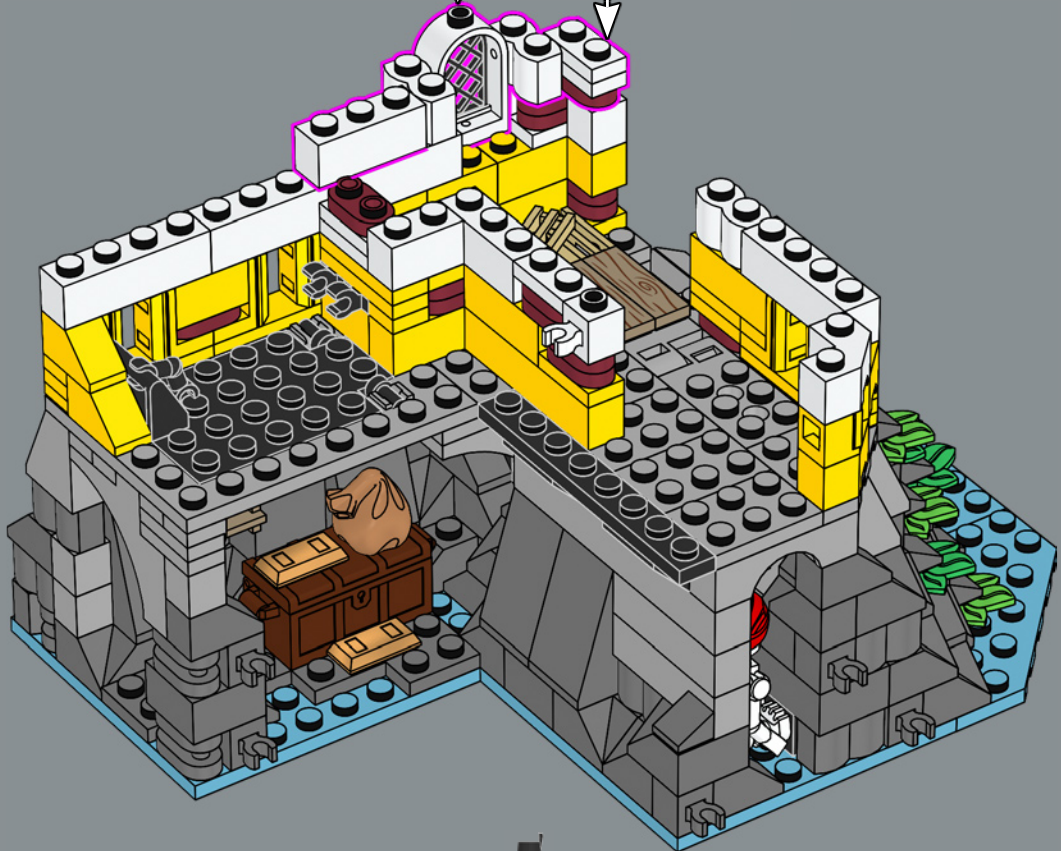

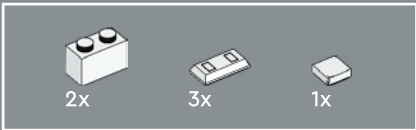

68

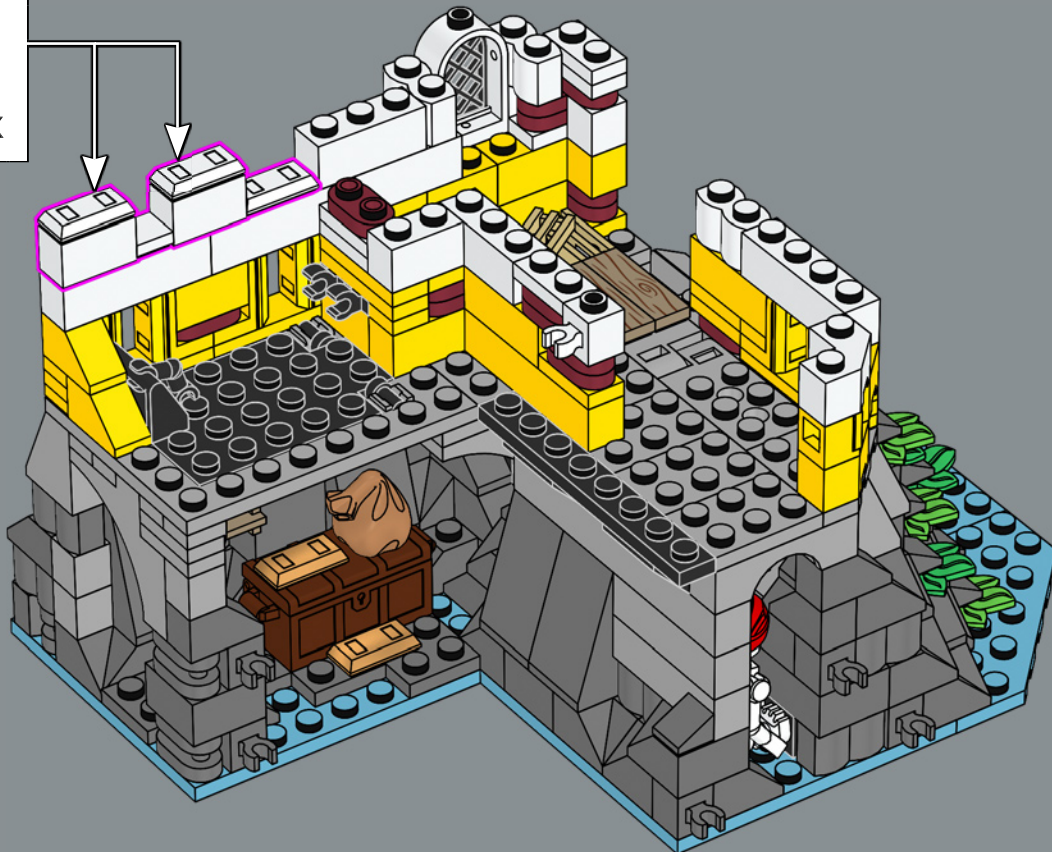
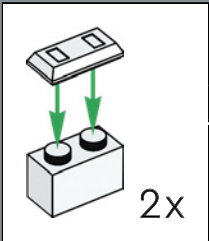

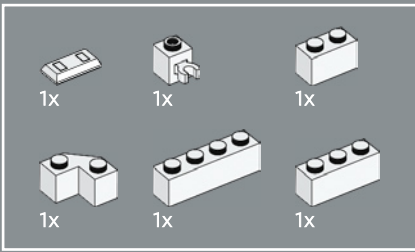

69

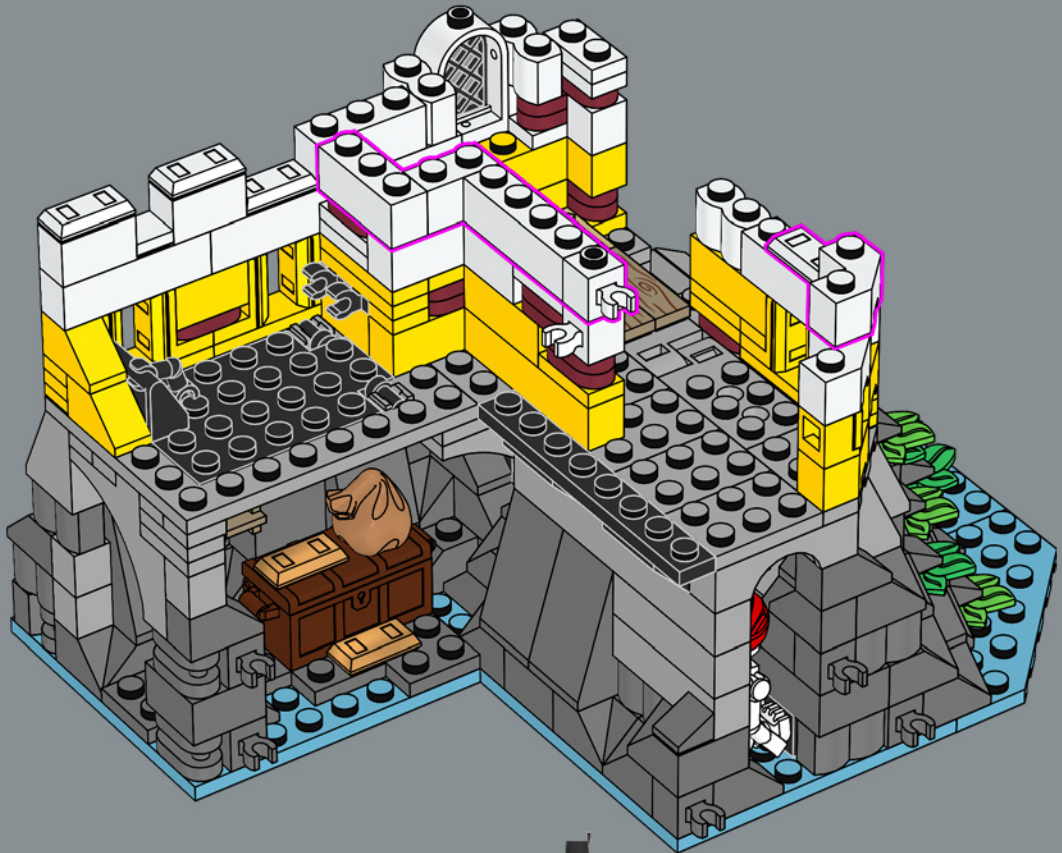

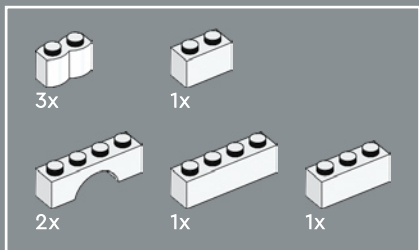

70



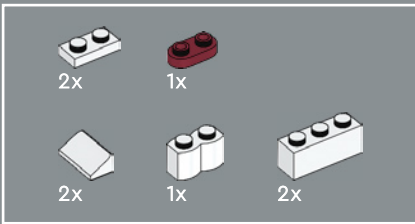

71

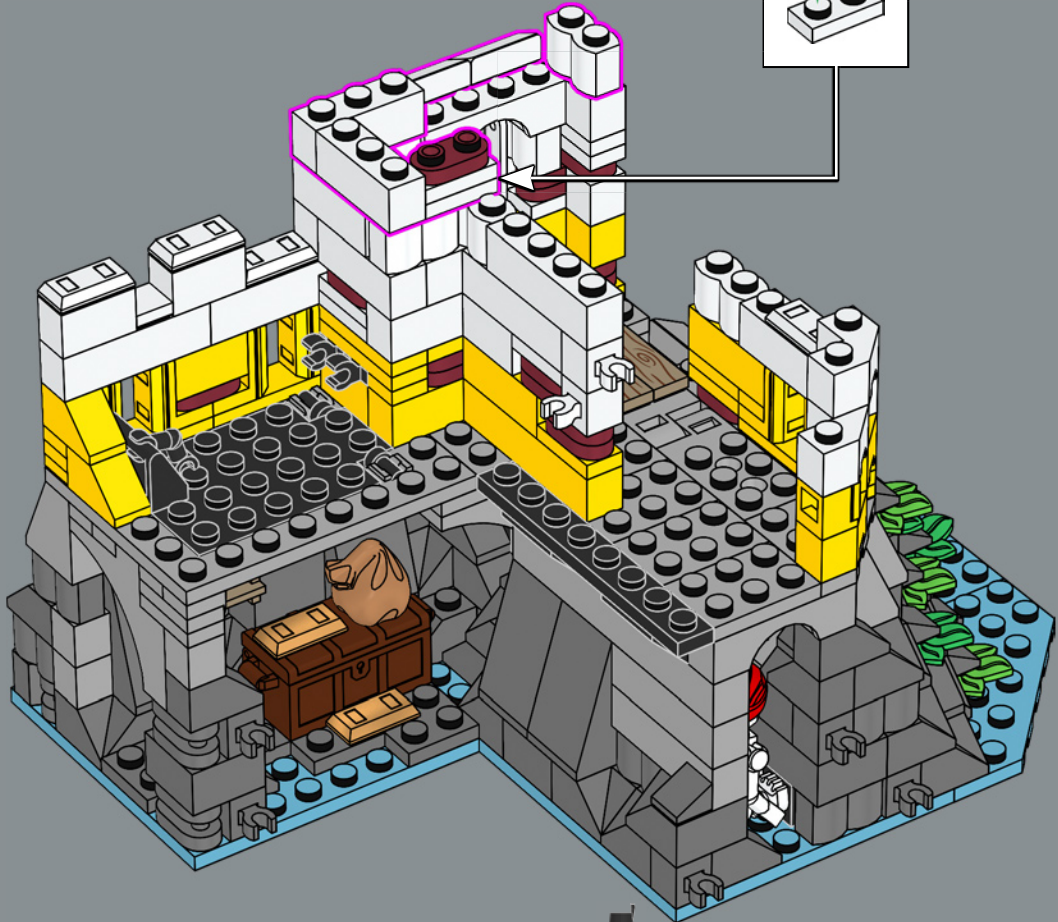
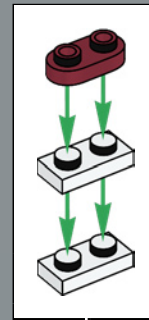

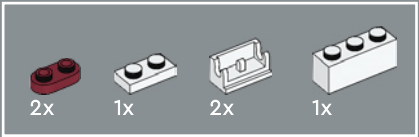

72

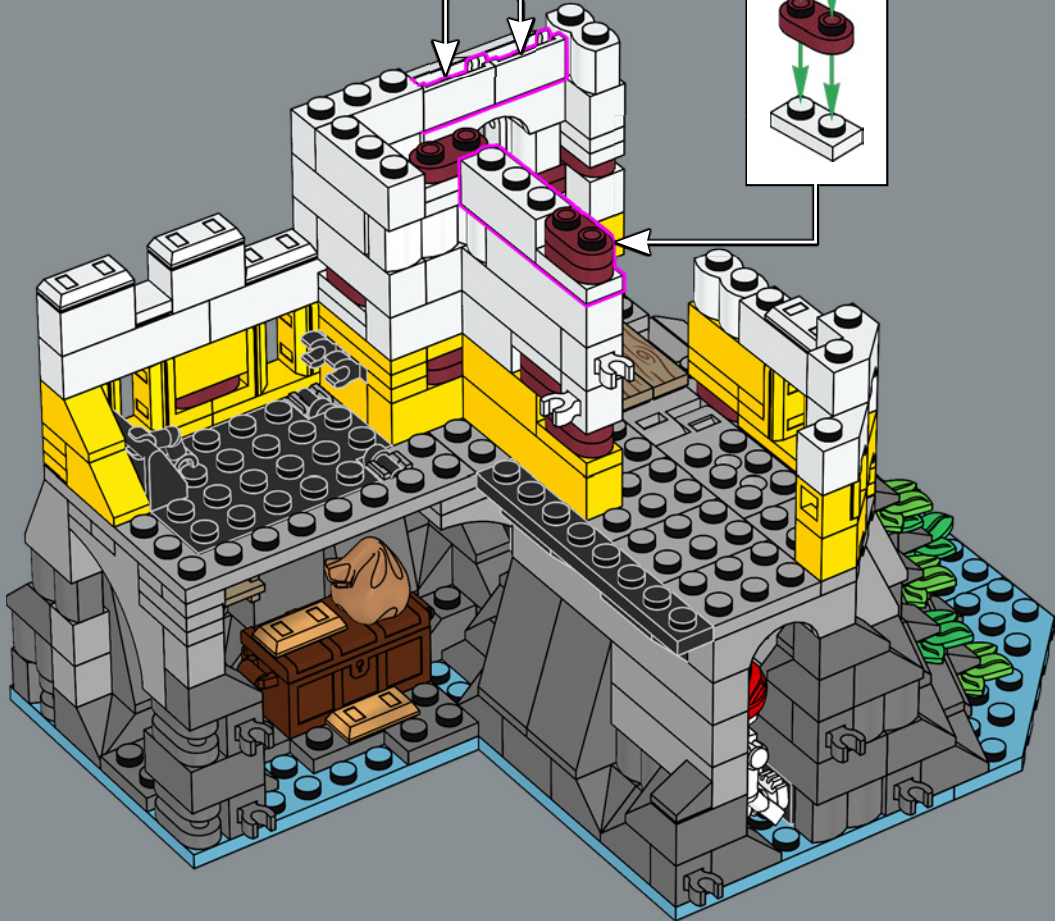
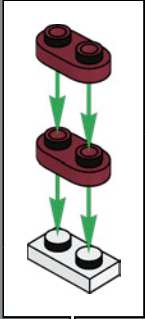
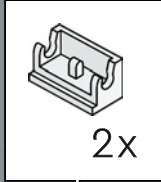

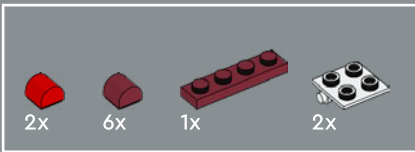

73

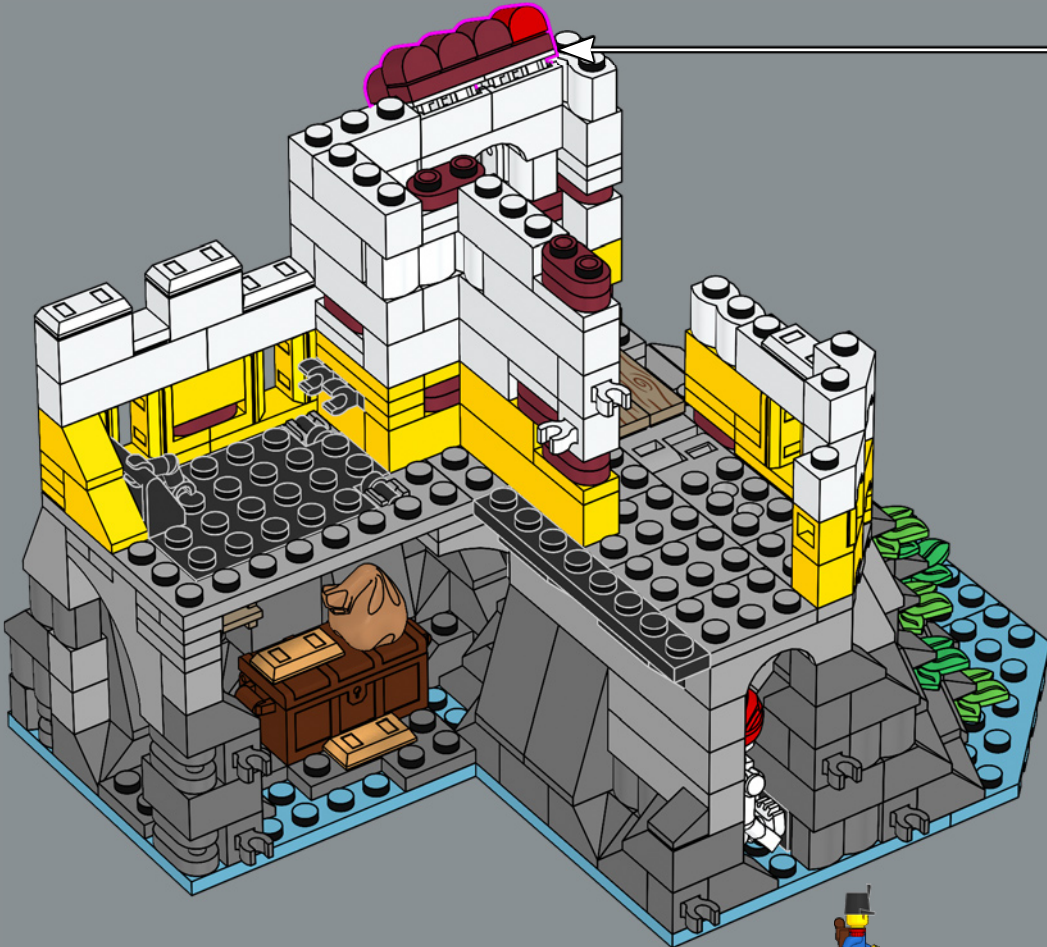
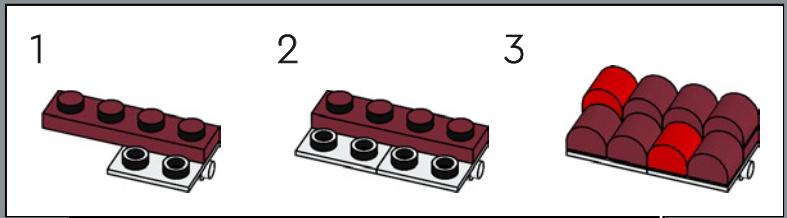

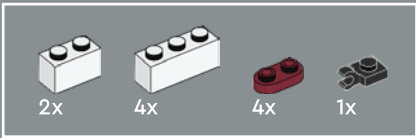

74

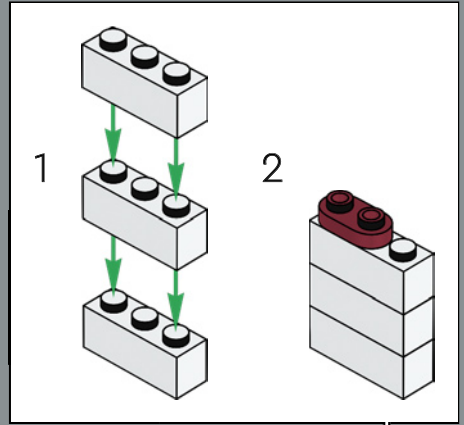
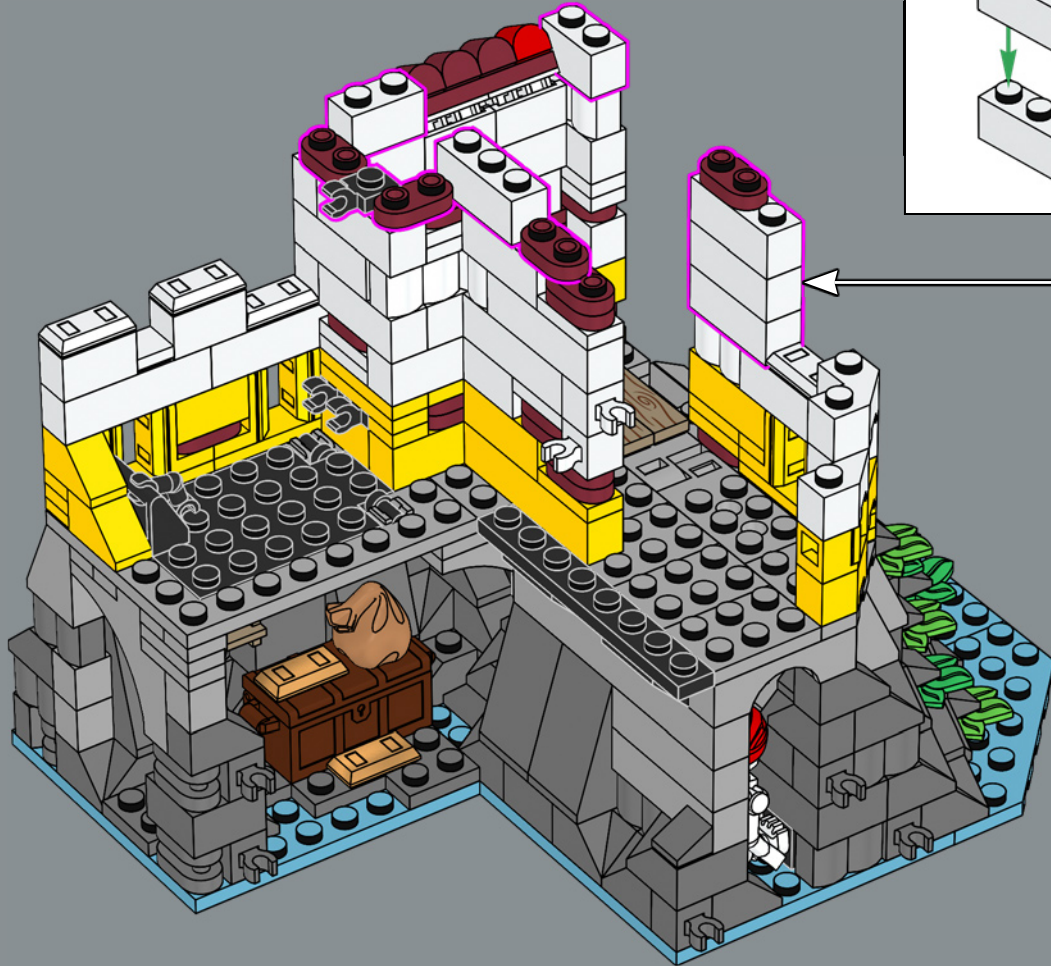



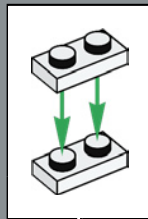
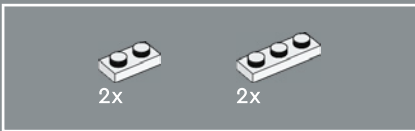

75

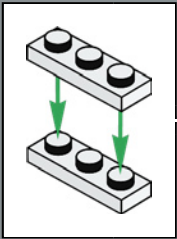

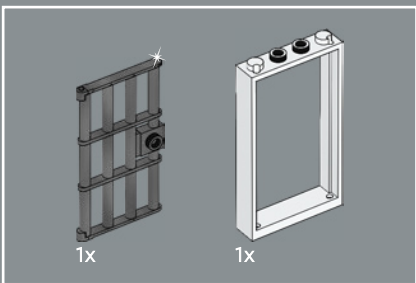

76

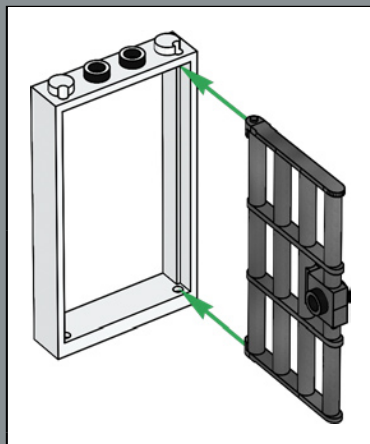

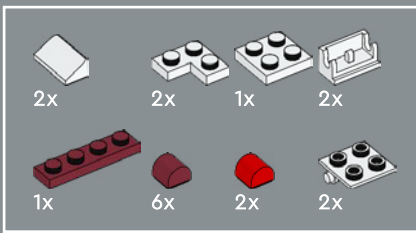

77

1



2

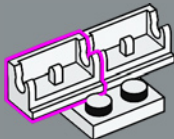

3

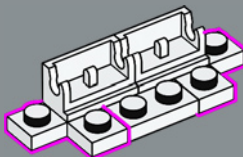

4

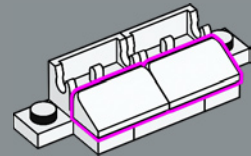

5

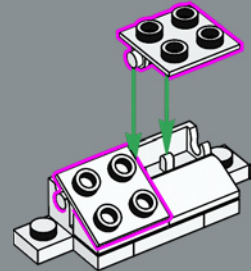

6

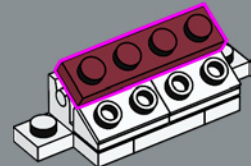

7

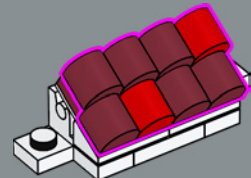

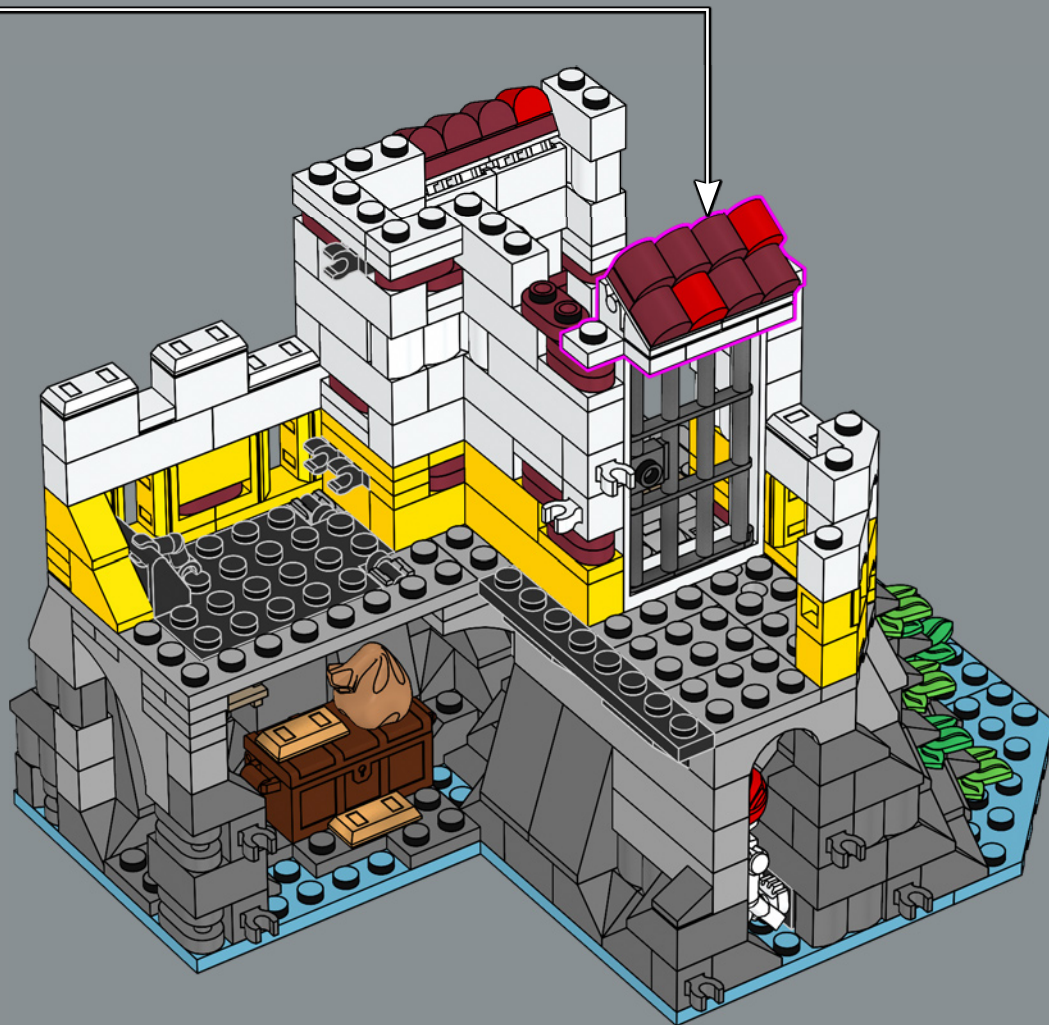

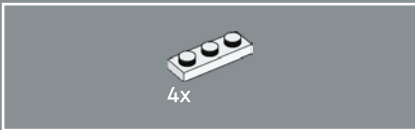

78

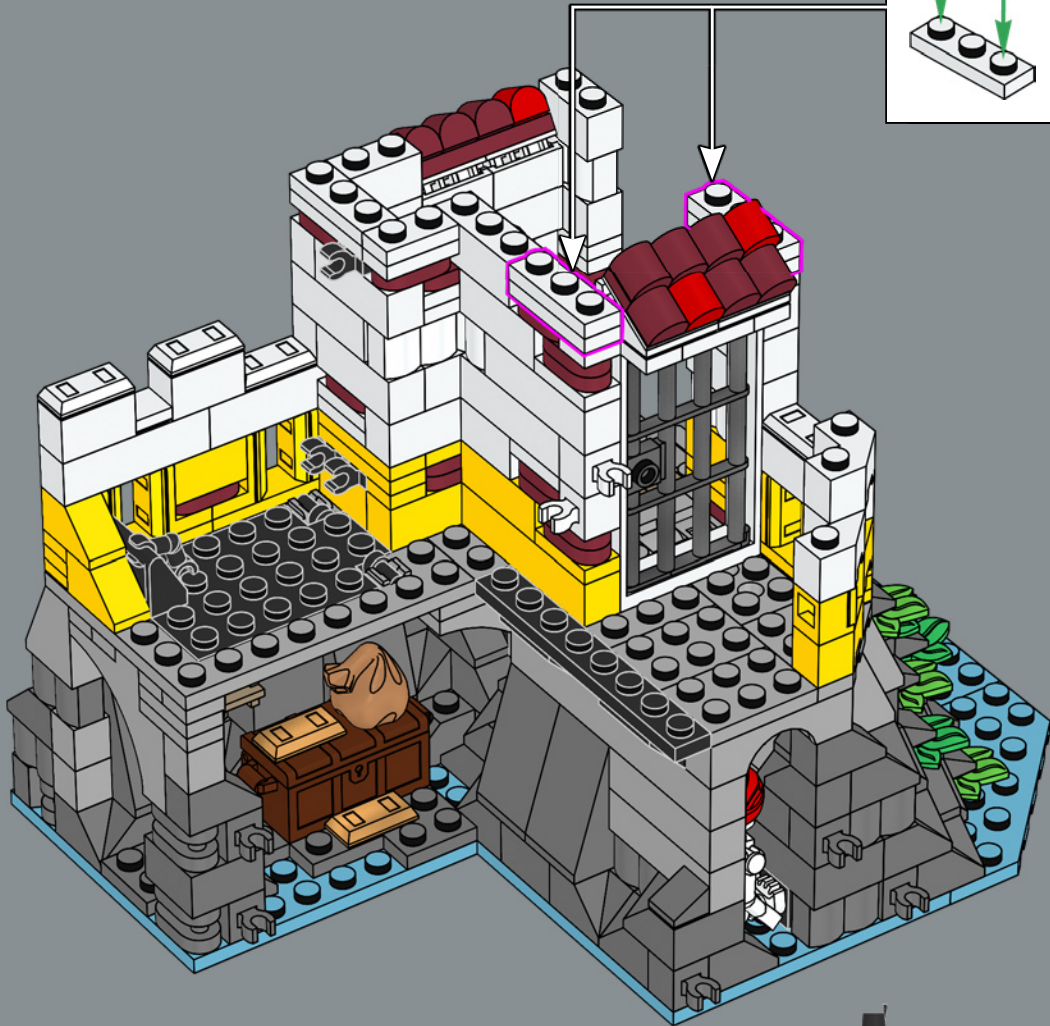
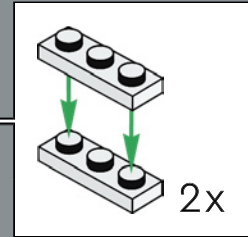

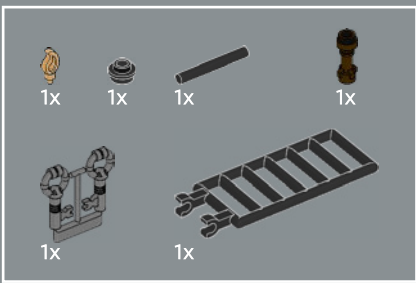

79

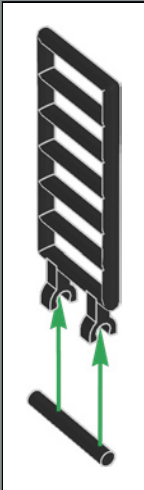
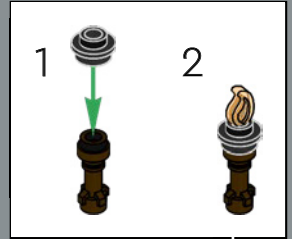

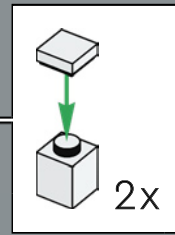
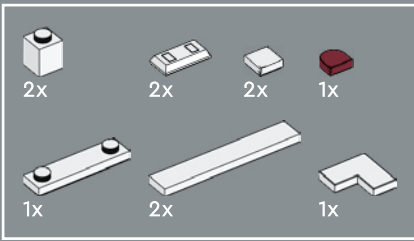

80

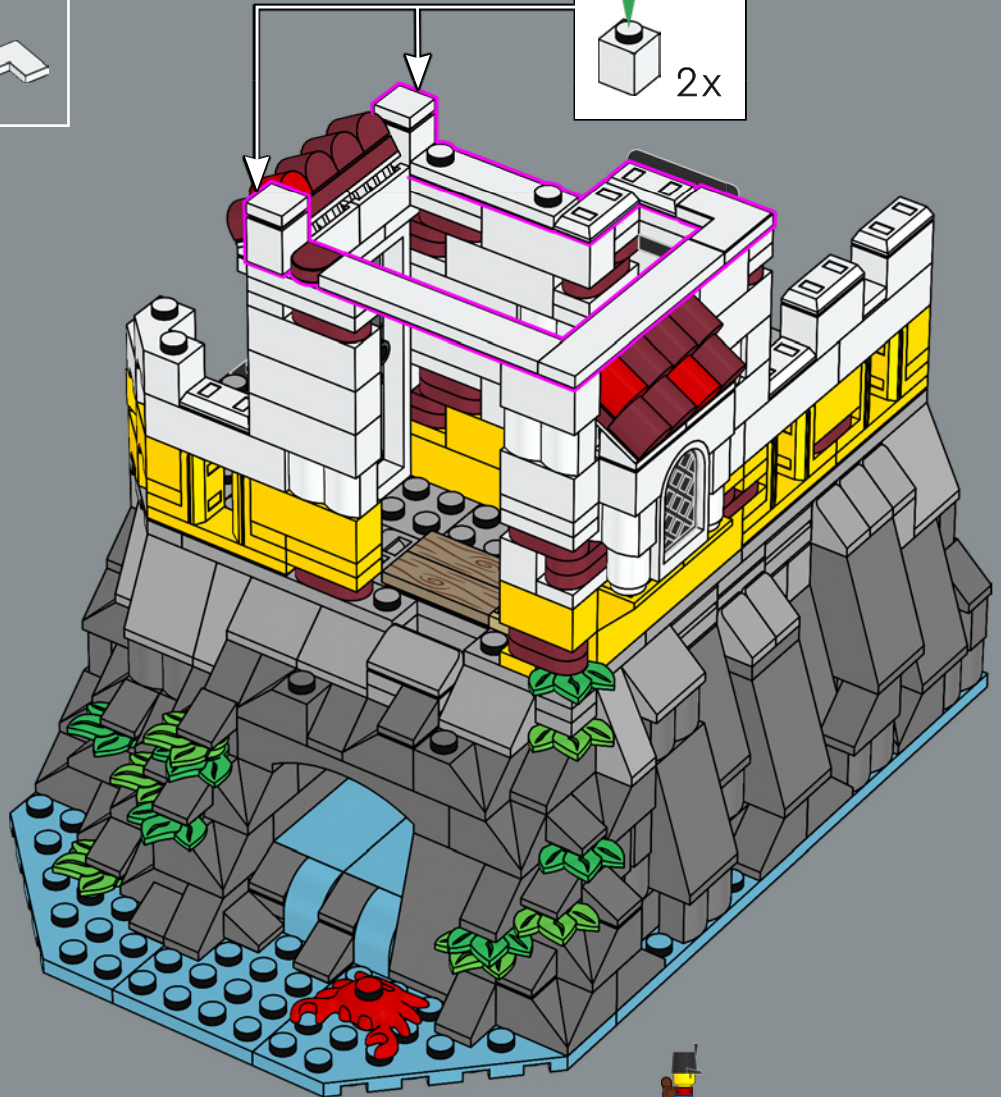

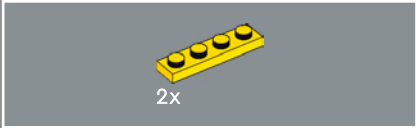
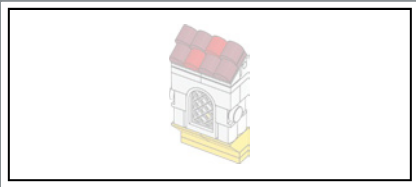

81

2x

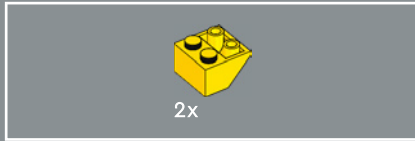
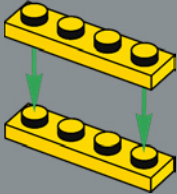

2x

82

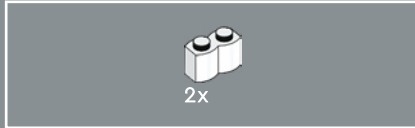
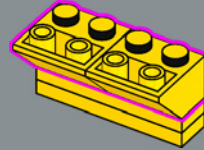

2x

83

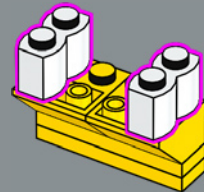



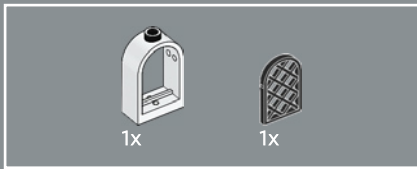

84

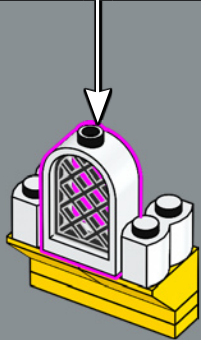
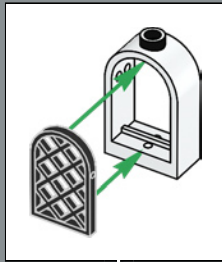

85

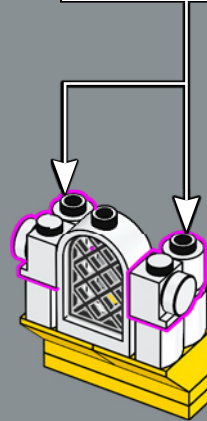
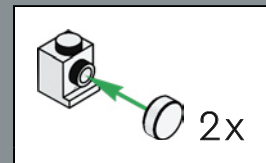

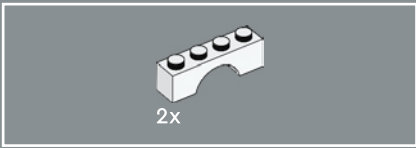

86

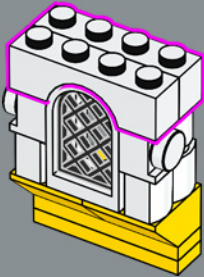

87

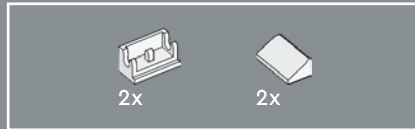
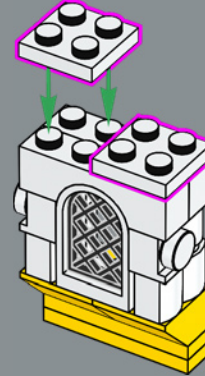

88

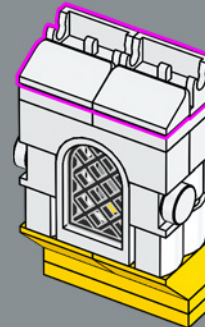



89

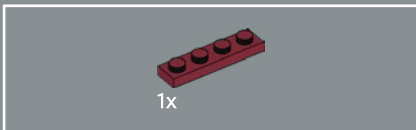
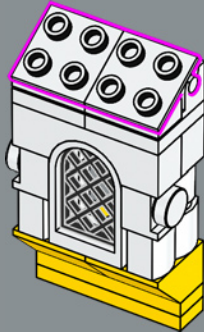

90



91





Vous pouvez retirer le toit et certaines  
fenêtres pour accéder aux pièces intérieures.

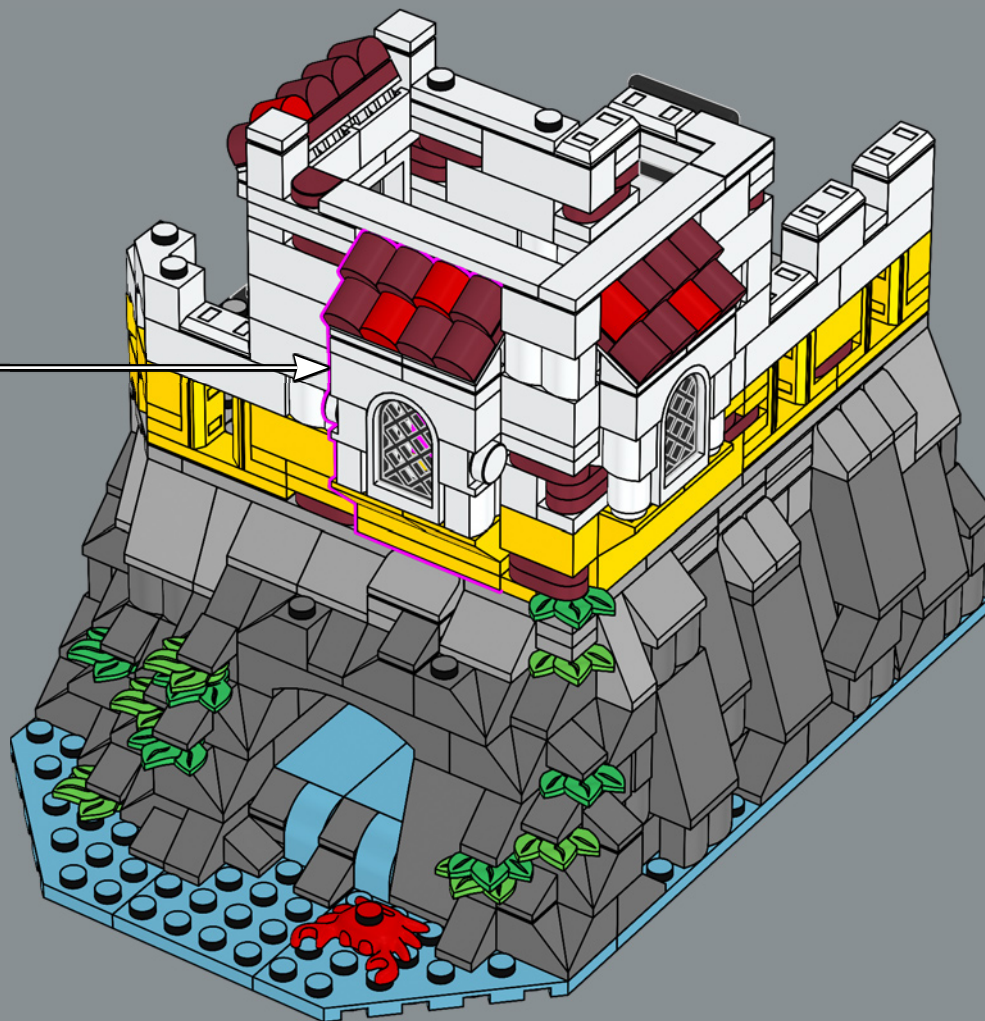

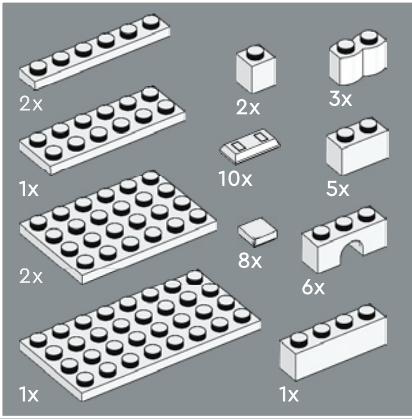
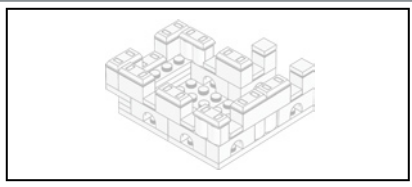

93

1

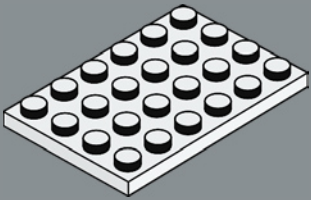

2

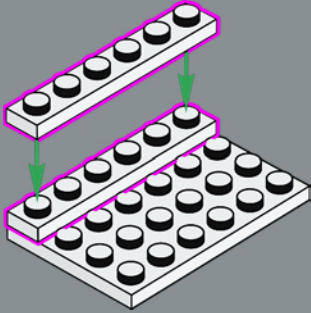

3

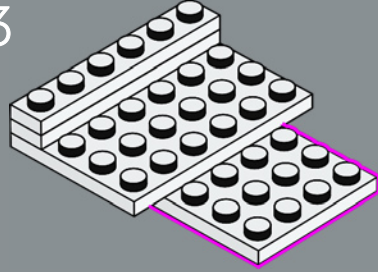

4

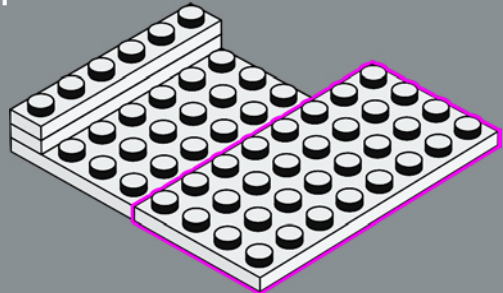

5

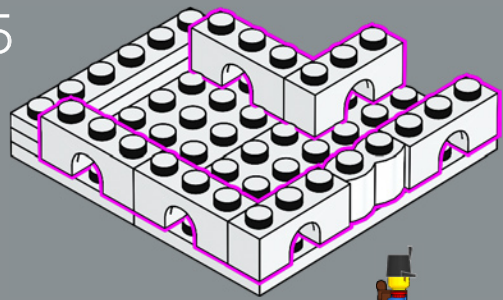

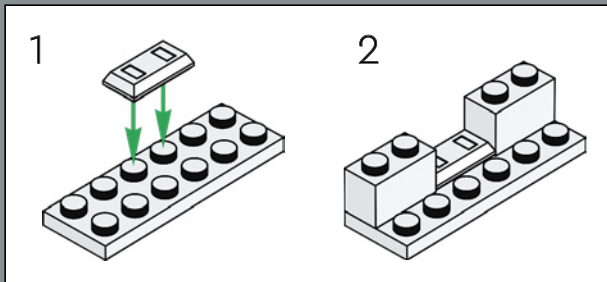

6

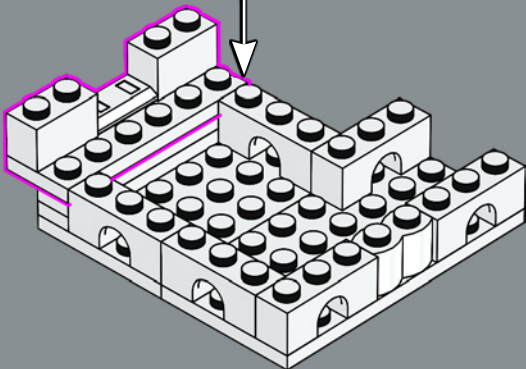

7

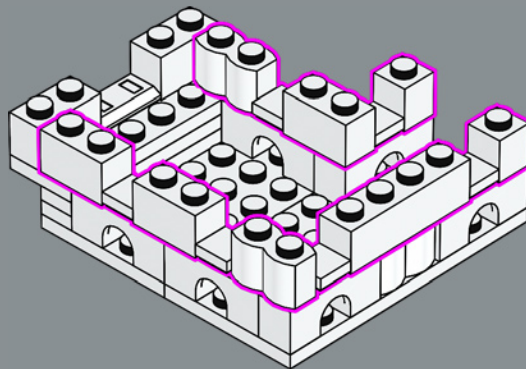

8

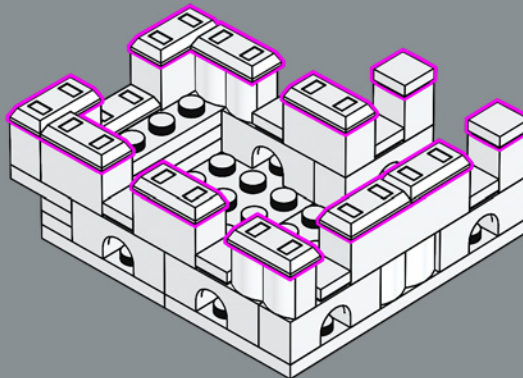

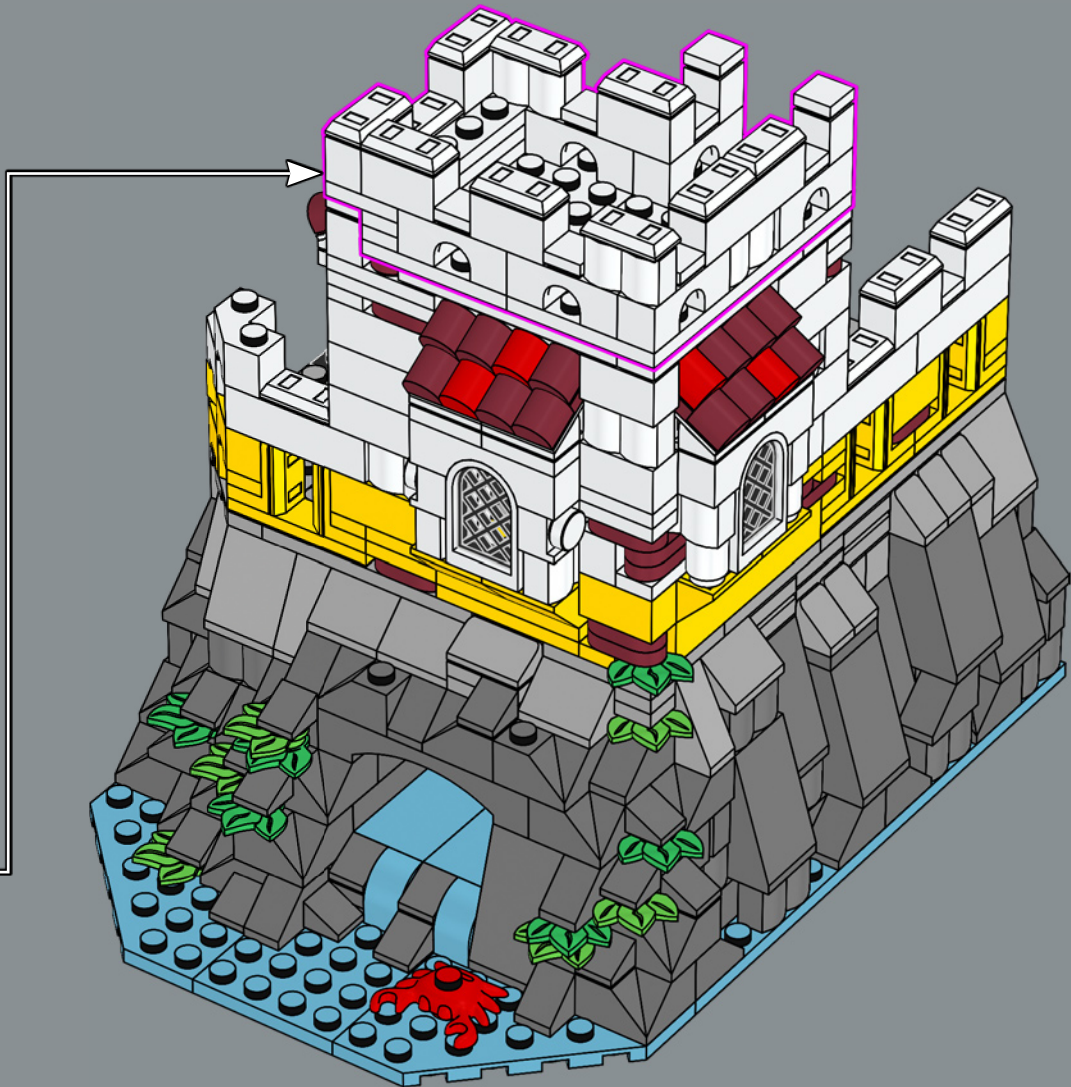



Déplié, le modèle est plus grand et permet d'exposer de façon plus détaillée les épreuves, tribulations et moments de joie de l'équipage (et de ses prisonniers).





1

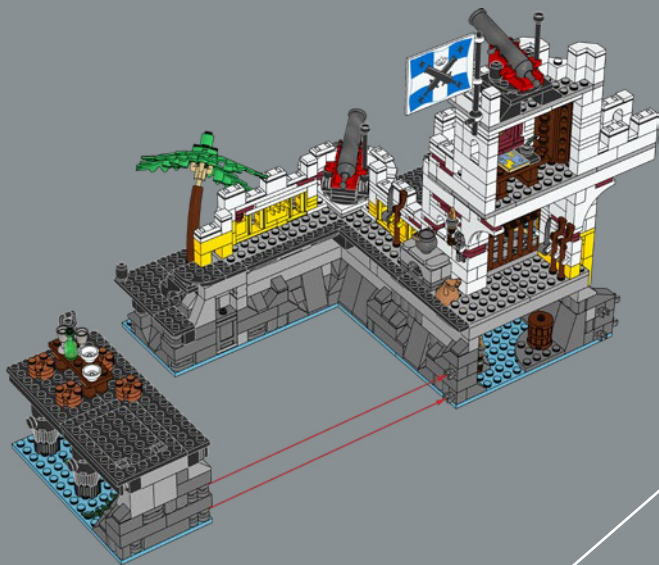

2

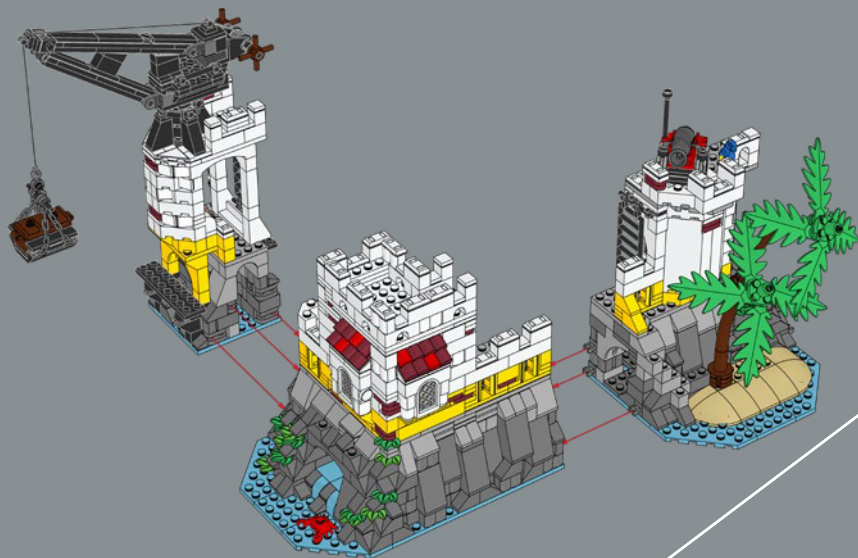

3

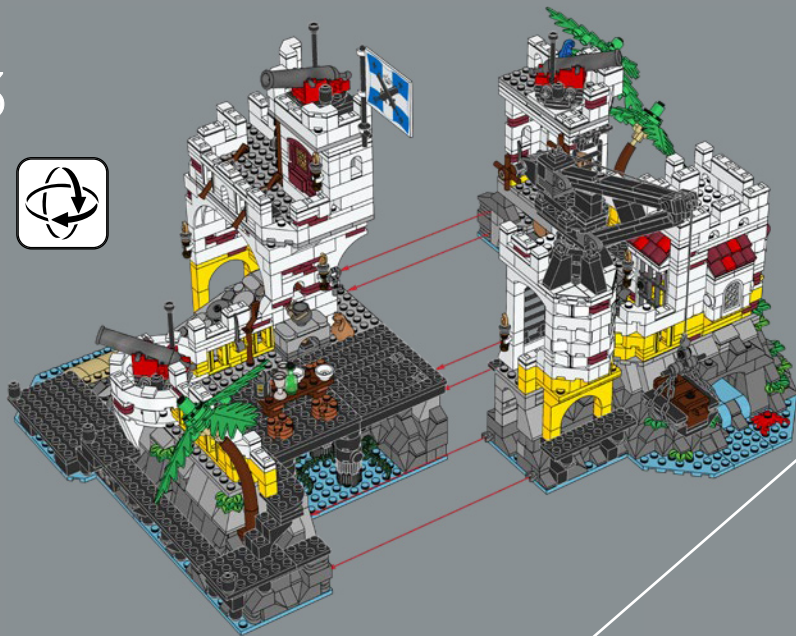



LEGO and the LEGO logo are trademarks of the LEGO Group.  
©2023 The LEGO Group.