

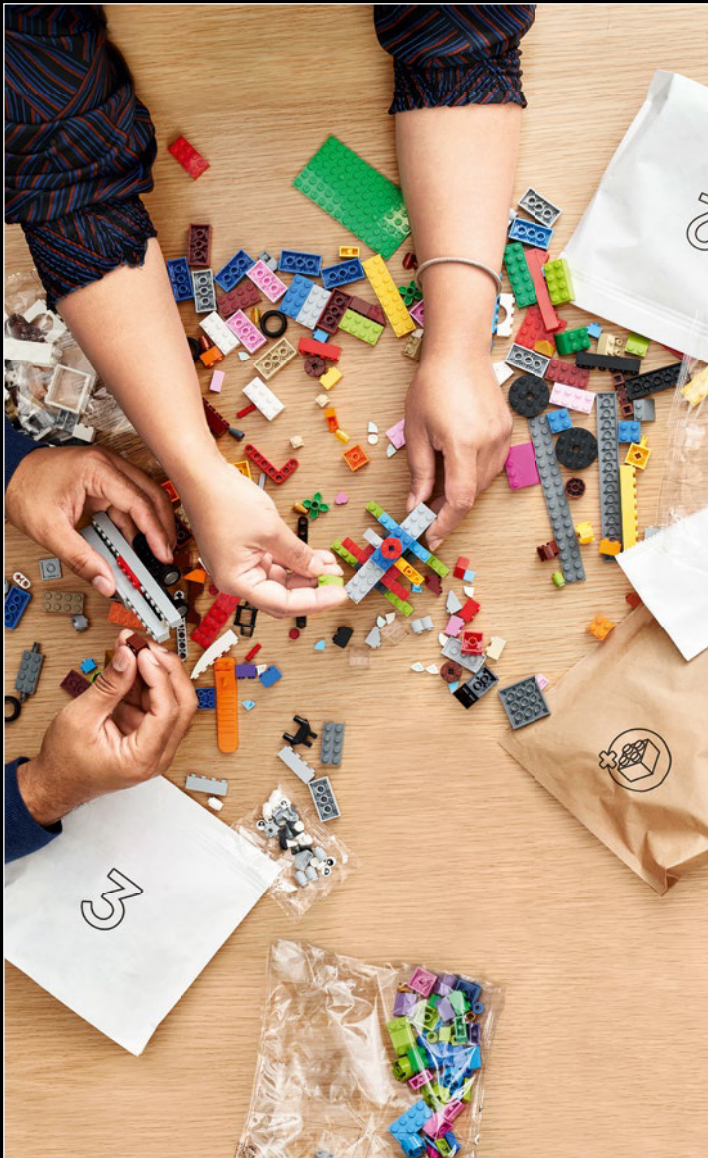

Booklet available in English on
Livret disponible en français sur
Folleto disponible en español en



WE'RE MAKING OUR PACKAGING MORE SUSTAINABLE

We're transitioning from single-use plastic to paper-based packaging. As we progress, you may find a mix of paper and plastic in our boxes.

NOUS RENDONS NOS EMBALLAGES PLUS DURABLES

Nous passons des emballages en plastique à usage unique aux emballages à base de papier. Durant la transition, vous pourriez trouver un mélange de papier et de plastique dans nos boîtes.

QUEREMOS HACER MÁS SUSTENTABLES NUESTROS MATERIALES DE EMBALAJE

Estamos cambiando las bolsas de plástico desechables por bolsas con base de papel. Conforme avanzamos en este propósito, puedes encontrar una mezcla de papel y de plástico en nuestras cajas.

LEGO.com/sustainable-packaging

DISPLAY YOUR WAY
EXPOSEZ VOTRE PASSION
EXHIBE A TU MANERA



Display your reconfigurable model as a table centerpiece or use the two mounting brackets to hang it on your wall.

Exposez votre modèle reconfigurable comme centre de table ou utilisez les deux supports de montage pour le suspendre à votre mur.

Exhibe tu modelo reconfigurable como centro de mesa o usa los dos soportes de montaje para colgarlo de una pared.



Combine two sets to create a four-spoked centerpiece, or three sets for a large six-spoke centerpiece (for table decoration only).

Combinez deux ensembles pour créer un centre de table à quatre tiges, ou trois ensembles pour un grand centre de table à six tiges (pour la décoration de table uniquement).

Combina dos sets para crear un centro de mesa de cuatro puntas, o tres sets para dar forma a un enorme centro de mesa de seis puntas (solo para decorar mesas).



DISCLAIMER:

The mounting brackets can support one set. Combined sets should not be mounted on walls.

AVERTISSEMENT :

Les supports de montage ne peuvent supporter qu'un seul ensemble. Les ensembles combinés ne doivent pas être fixés au mur.

DESCARGO DE RESPONSABILIDAD:

Los soportes de montaje pueden sostener un set. No deben montarse sets combinados en paredes.



EVERLASTING CREATIVITY UNE CRÉATIVITÉ ÉTERNELLE CREATIVIDAD IMPERECEDERA

Florists, interior designers and flower enthusiasts everywhere love getting creative with dried flowers. From delicate grasses to majestic petals, dried foliage makes such versatile décor for centerpieces, vase arrangements and wall art that can last for months, even years. With this latest addition to our LEGO® Botanical Collection, we hope you will feel inspired to turn your own 'LEGO everlastings' into a lush centerpiece in warm autumn colors.

Enjoy building!

Les fleuristes, les décorateurs d'intérieur et les amateurs de fleurs du monde entier adorent créer avec des fleurs séchées. Qu'il s'agisse d'herbes délicates ou de pétales majestueux, le feuillage séché constitue un décor polyvalent pour les centres de table, les décorations en vase et l'art mural, qui peut durer des mois, voire des années. Avec ce dernier ajout à notre collection botanique LEGO®, nous espérons que vous vous sentirez inspiré pour transformer vos propres fleurs vivaces LEGO en un centre de table luxuriant aux couleurs chaudes de l'automne.

Bonne construction !

En todas partes, a los floristas, diseñadores de interiores y entusiastas de las flores les encanta dar rienda suelta a su creatividad con flores desecadas. El follaje disecado, que contempla desde delicadas hierbas hasta los pétalos más majestuosos, es una decoración tan versátil que puede embellecer centros de mesa, jarrones y arte mural por meses e incluso años. Con esta incorporación a la colección LEGO® Botanical, la más reciente de todas, esperamos inspirarte para que conviertas tus ejemplares imperecederos LEGO en exuberantes piezas de exhibición en tonos otoñales.

¡Que disfrutes la construcción!



CHRIS McVEIGH

*Designer at the LEGO Group
concepteur chez le Groupe LEGO
diseñador de The LEGO Group*

PLANTS FROM PLANTS DES PLANTES FABRIQUÉES AVEC DES PLANTES PLANTAS CON PLANTAS

« Fresh flowers are nature's gifts. There is so much beauty in preserving them, giving them lasting life, and celebrating them as works of art. But did you know that your LEGO® dried flower art also has elements made from plant-based plastic? »

« Les fleurs fraîches sont un don de la nature. Il est merveilleux de les préserver, de leur donner une vie pérenne et de les célébrer comme des œuvres d'art. Mais saviez-vous que votre œuvre d'art en fleurs séchées LEGO® comporte également des éléments fabriqués à partir de plastique végétal ? »

« Las flores frescas son regalos de la naturaleza. Preservarlas, hacerlas duraderas y celebrarlas como verdaderas obras de arte es un proceso que conlleva una enorme belleza. ¿Pero sabías que tu obra de arte LEGO® de flores disecadas también tiene elementos hechos de plástico de origen vegetal? »

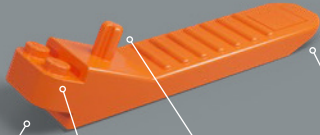

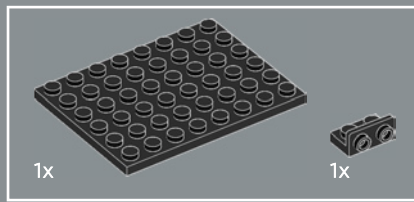

1

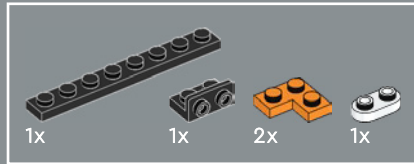
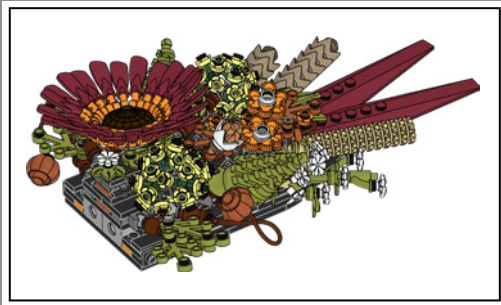
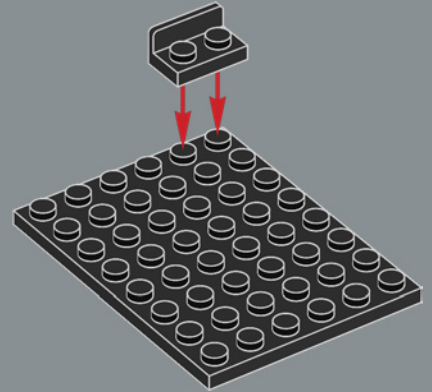

2

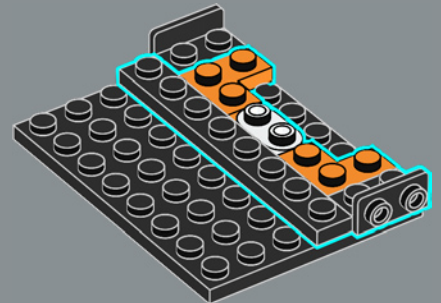

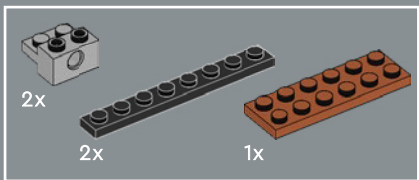

3

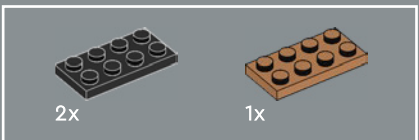
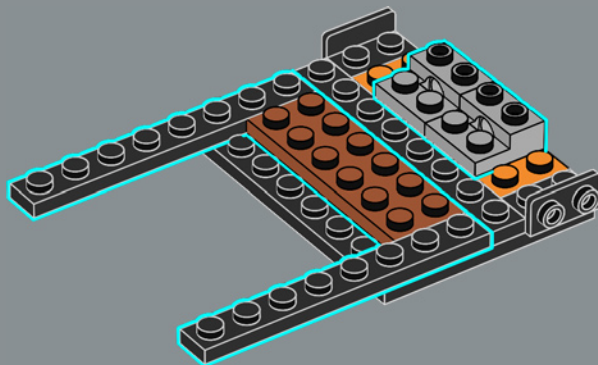

4

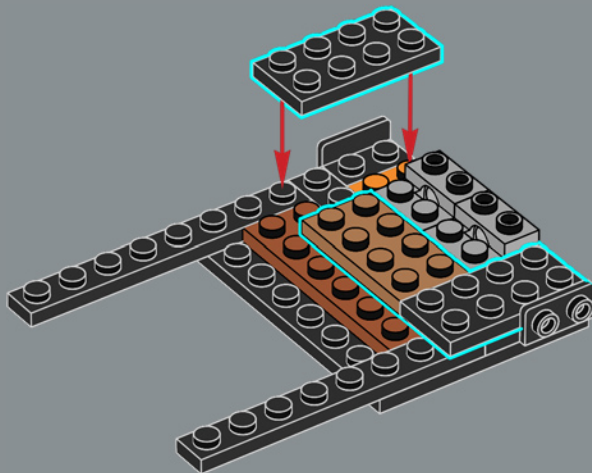

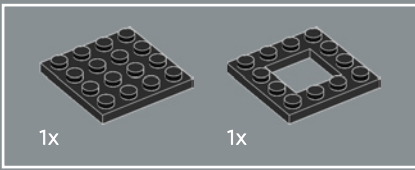

5

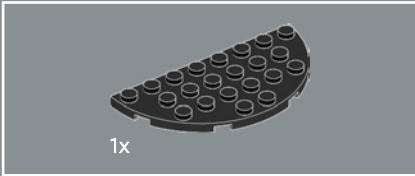
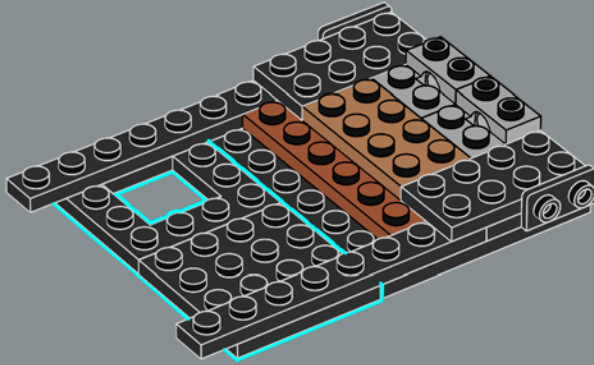

6

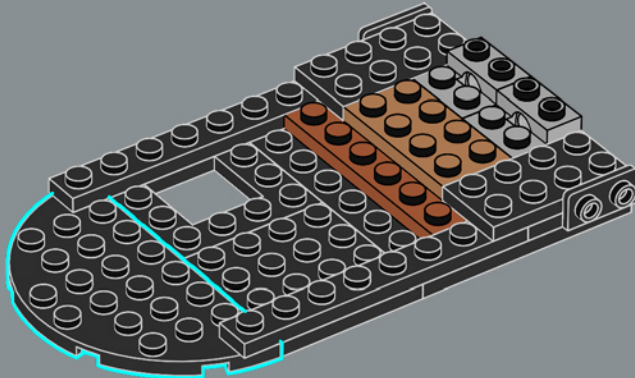

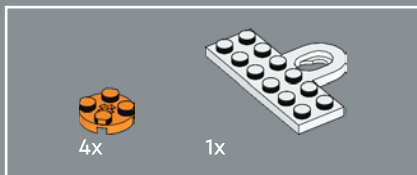

7



Built into each side of the model is a 2×6 plate with a mounting bracket so you can hang your decoration on a wall. This special element first appears in DOTS products.

De chaque côté du modèle se trouve une plaque 2×6 avec un support de montage pour vous permettre d'accrocher votre décoration sur un mur. Cet élément spécial est apparu pour la première fois dans les produits DOTS.

Cada lado del modelo cuenta con una placa 2×6 con soporte de montaje para que puedas colgar de una pared tu pieza decorativa. Este elemento especial apareció por primera vez en los productos DOTS.

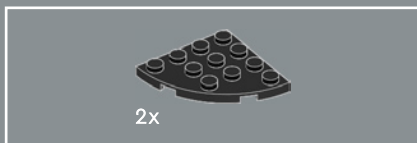
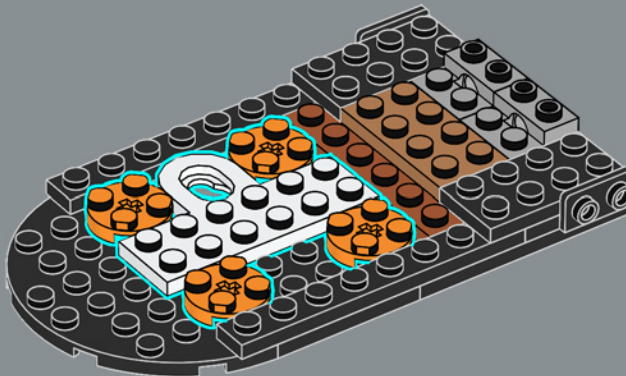

8

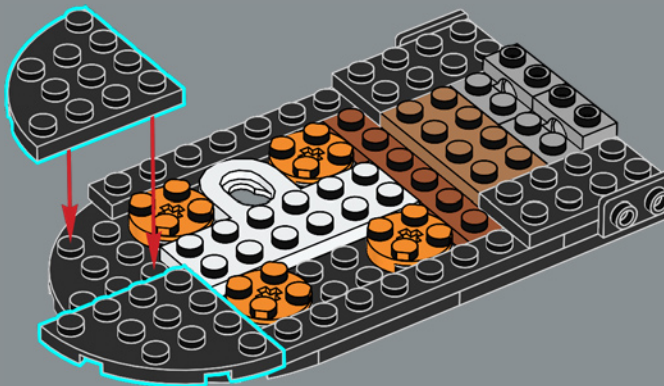

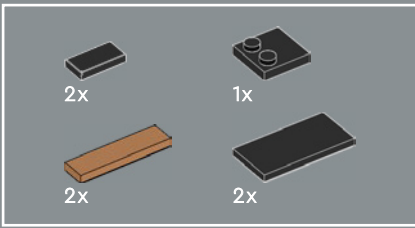

9

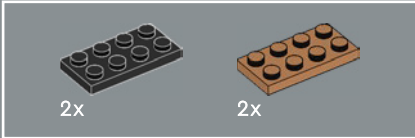
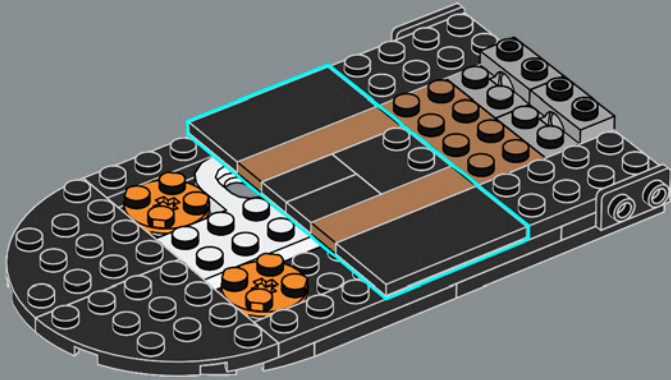

10

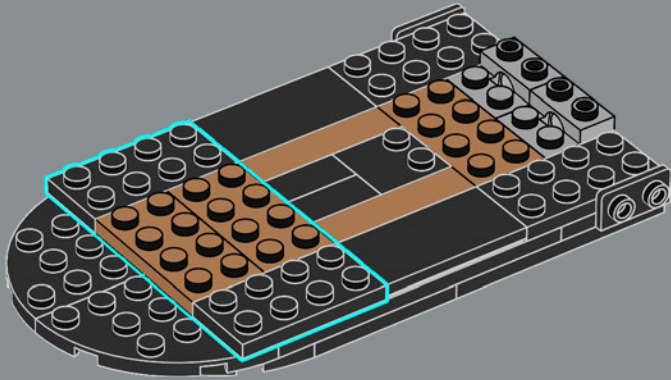

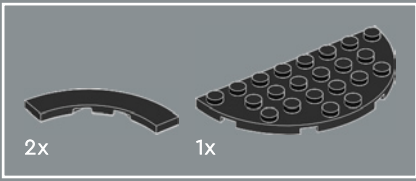

11

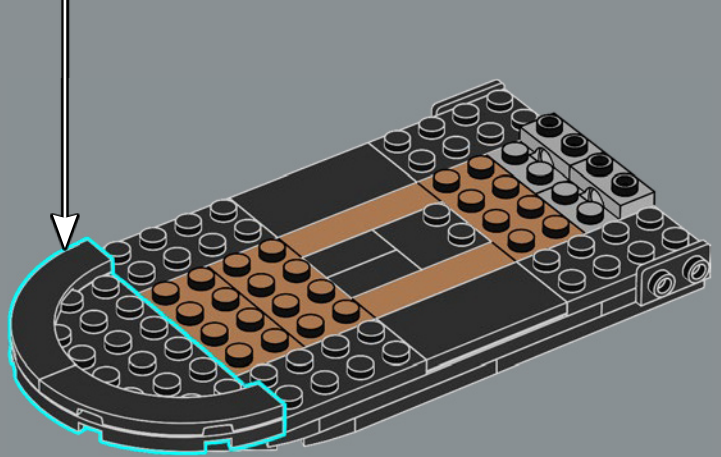
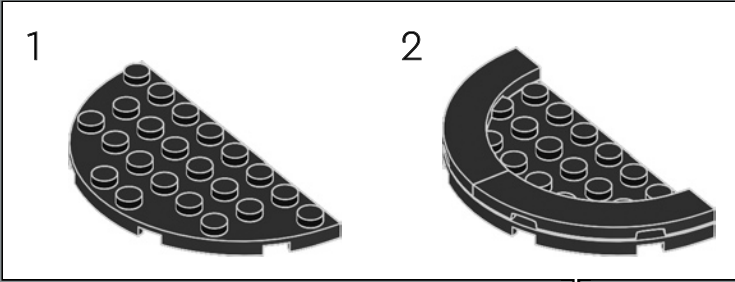

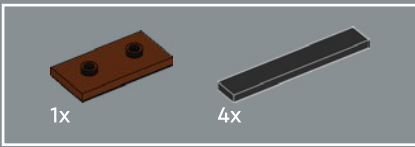

12

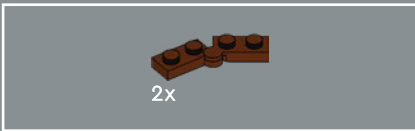
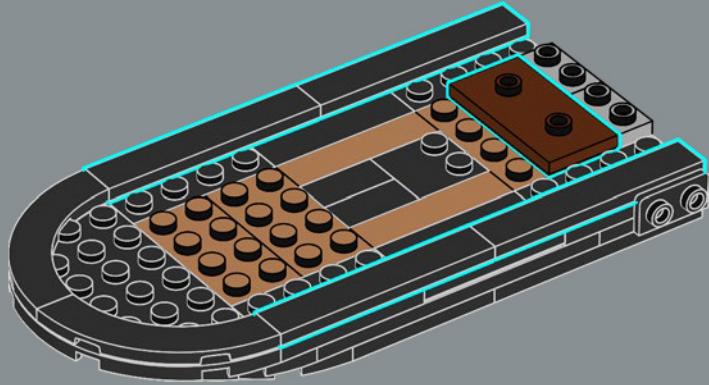

13

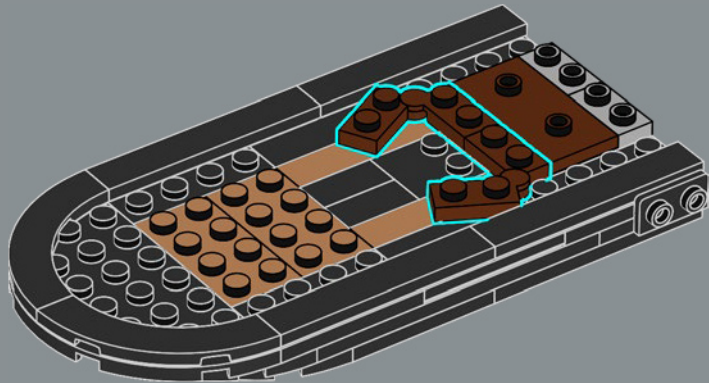

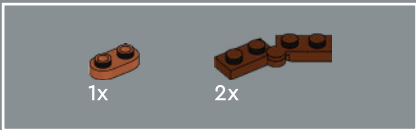

14

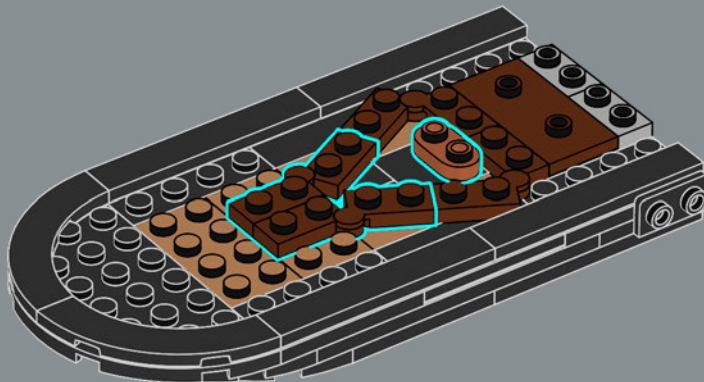

15

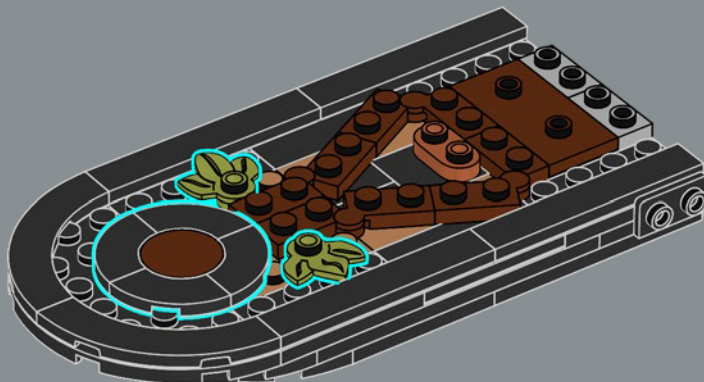

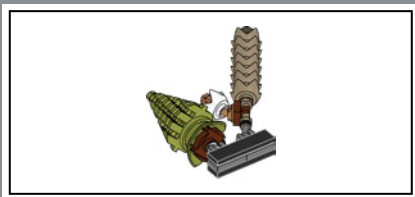

16

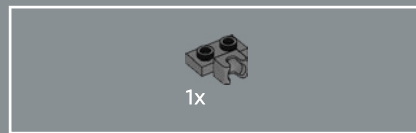
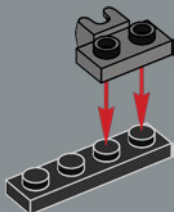

17

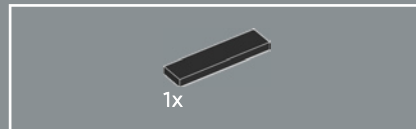
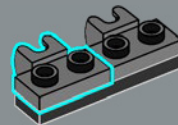

18

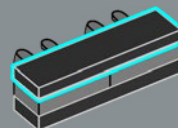



19

1



2



3

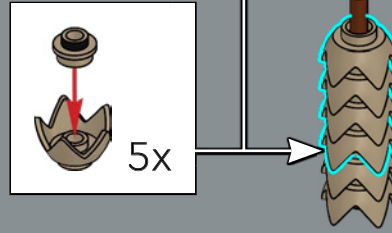

4





5

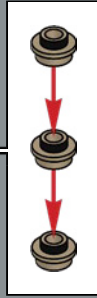

1x



1x



1x



1x

20

1



2



3

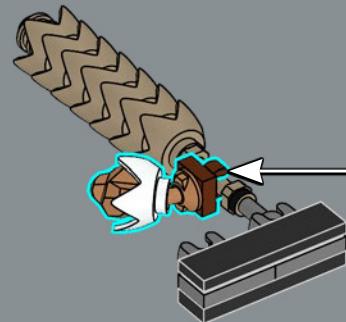
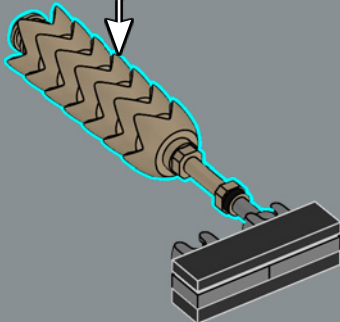

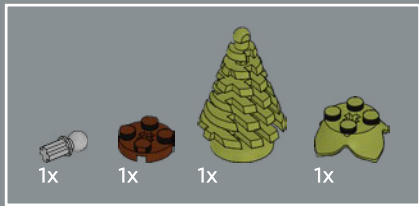

21

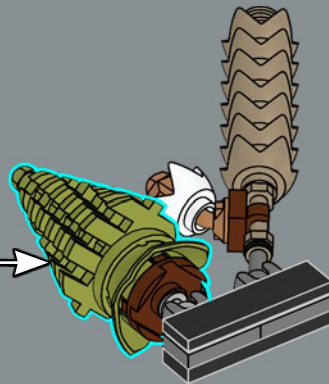
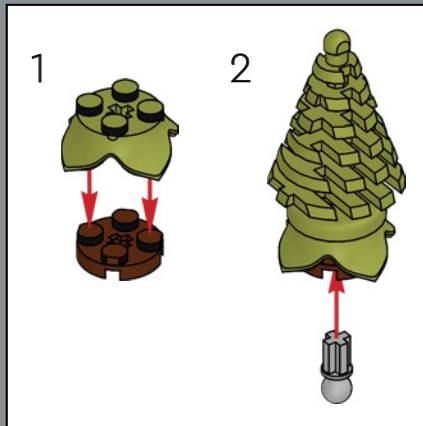

22

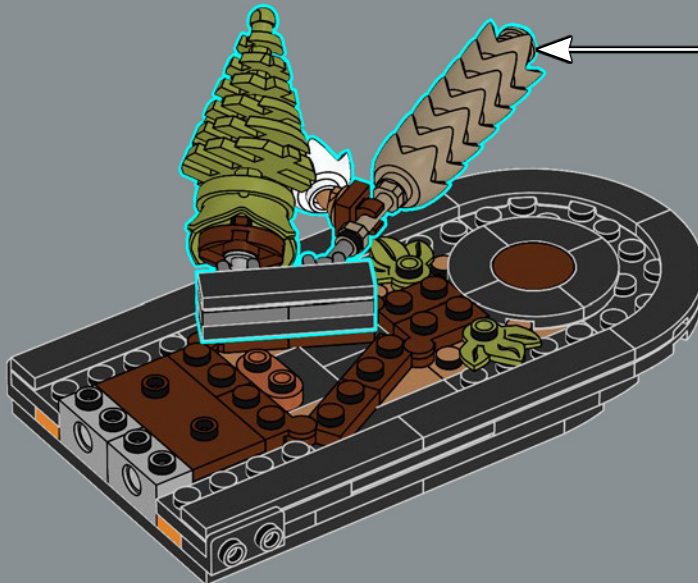

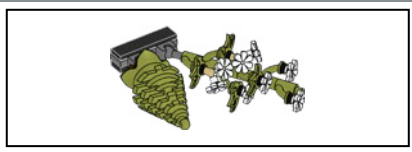

23

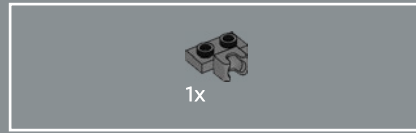
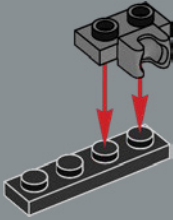

24

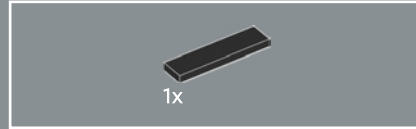
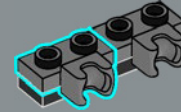

25

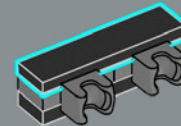



1x

2x

26



2x

27

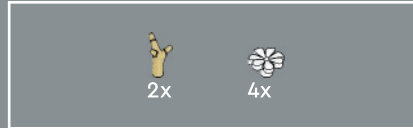
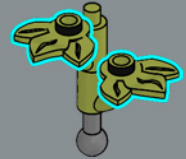

2x

4x

28

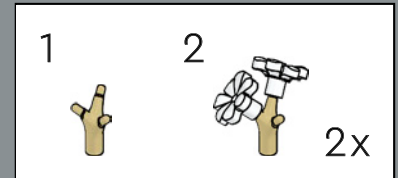

1

2

2x

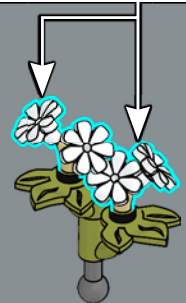



29

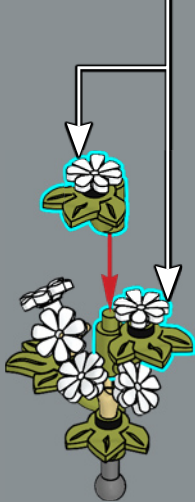
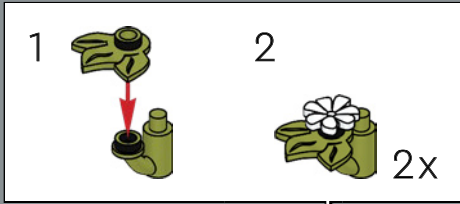

30

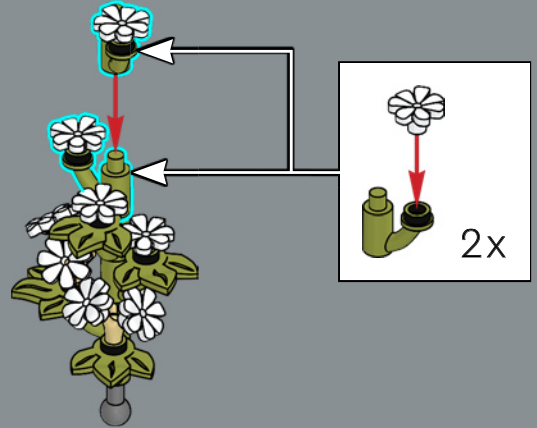

31

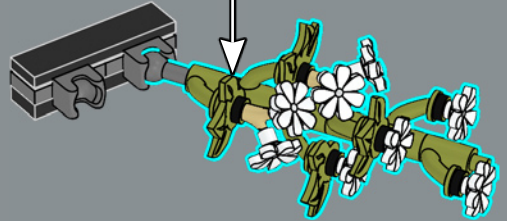

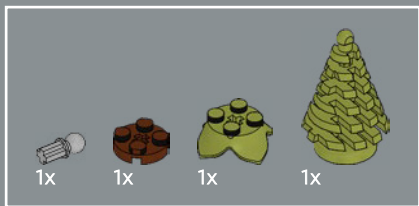

32

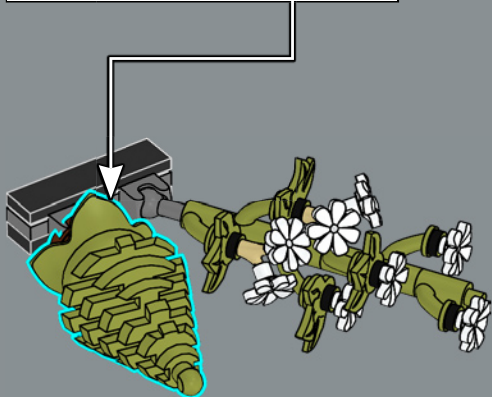
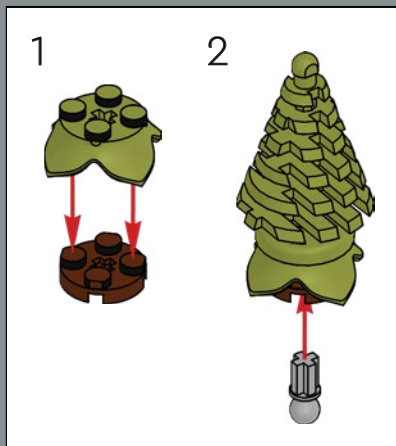

33

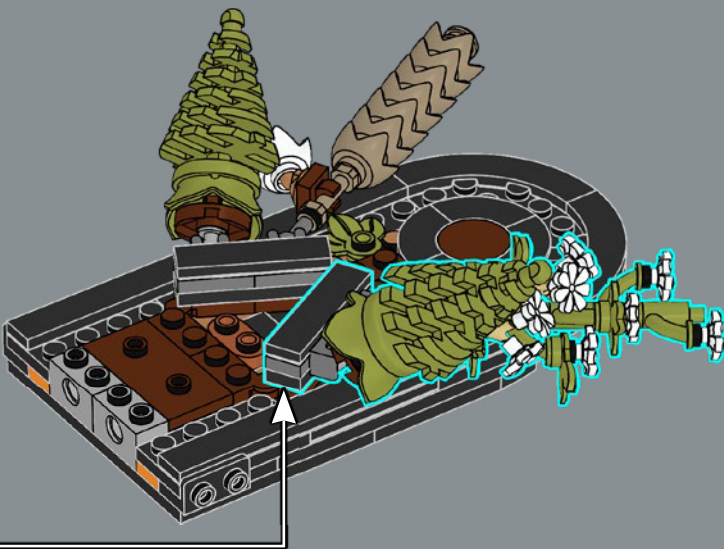

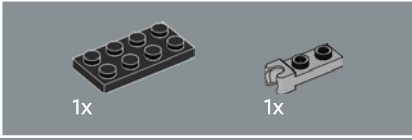
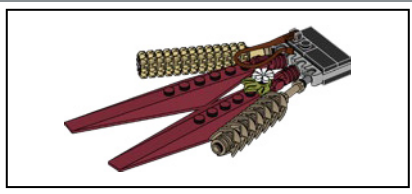

1x

1x

34

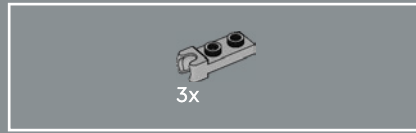
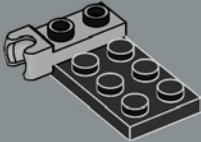

3x

35

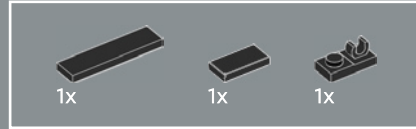
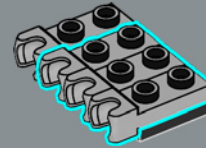

1x

1x

1x

36

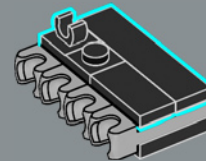

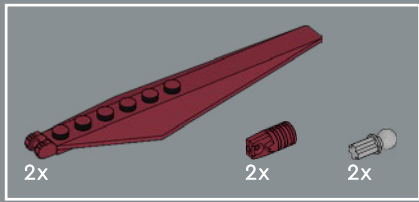

37

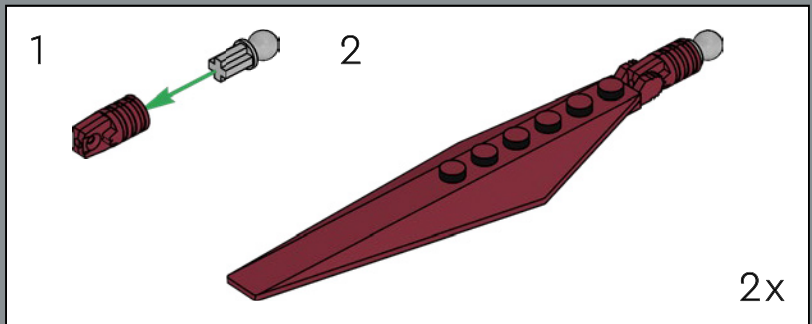

38

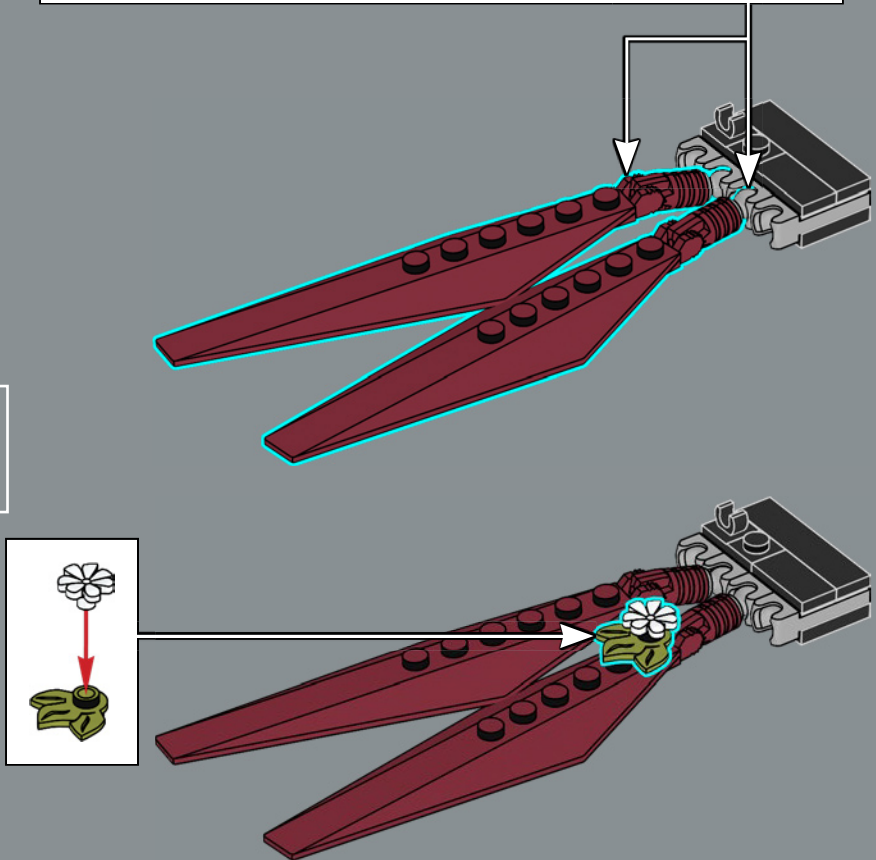

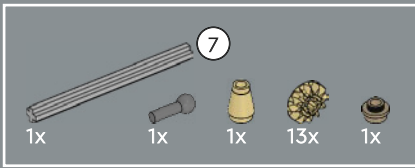

39

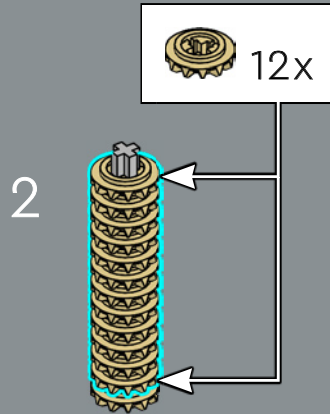
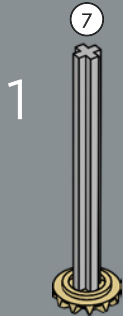

The detailed texture of the pearl millet stalks is created with a stack of conical wheels (gears).

La texture détaillée des tiges de millet perlé est créée par un empilement de roues coniques (engrenages).

La detallada textura de las espigas de mijo perla se crea apilando engranes cónicos.

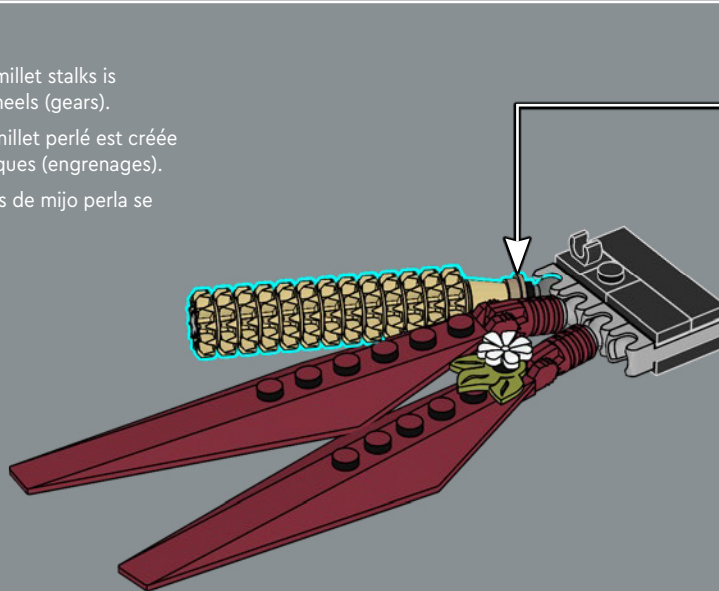



40

1



2



3



4



5

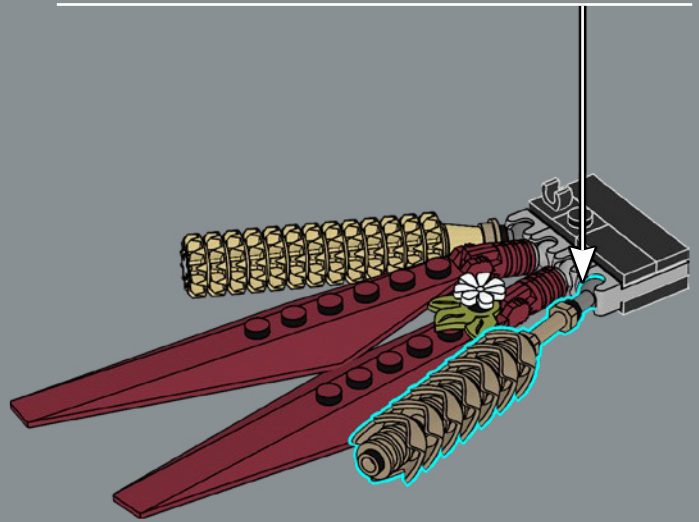
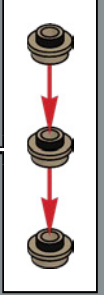



41

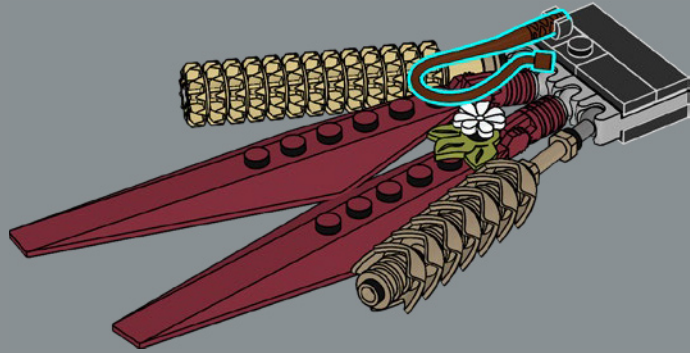

42

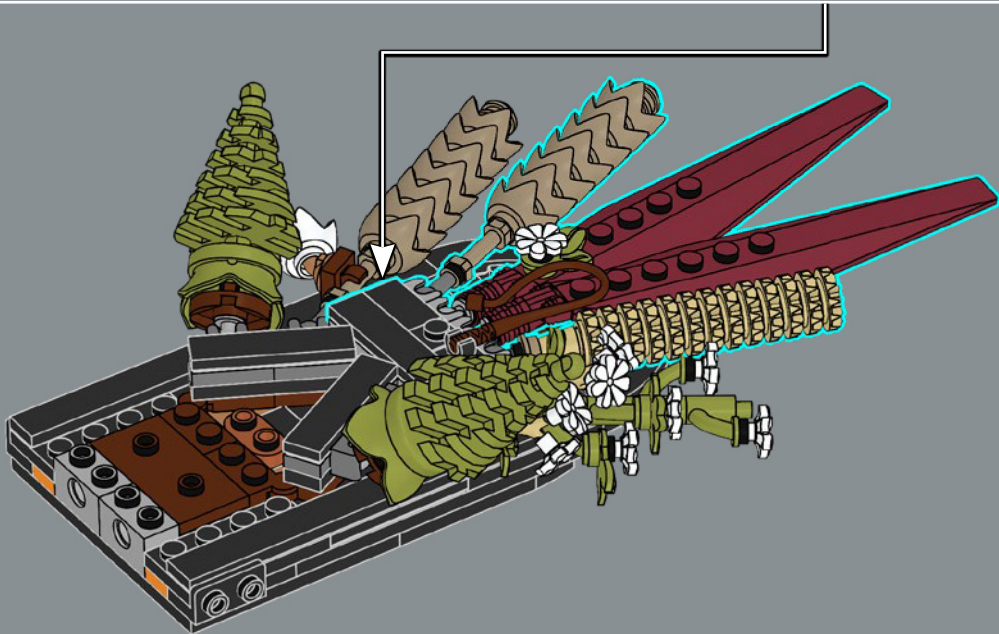

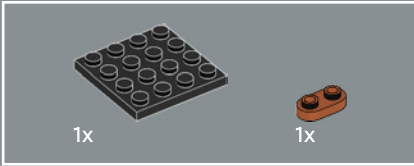
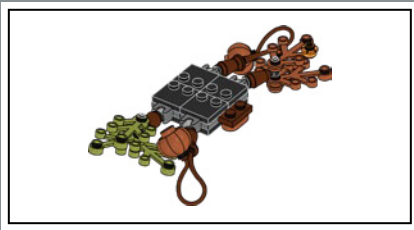

43

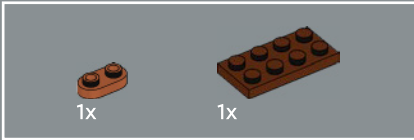
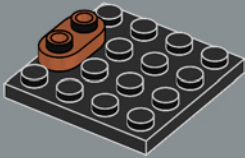

44

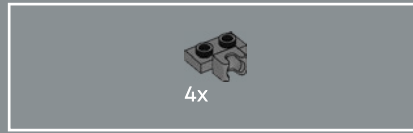
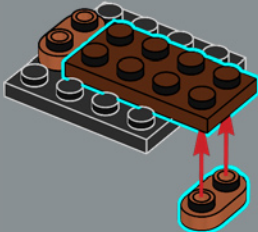

45

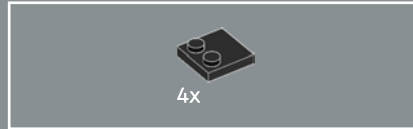
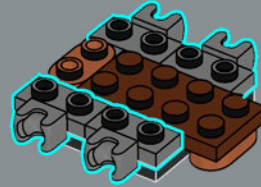

46

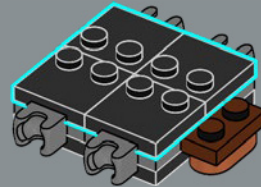



47

1

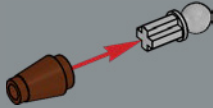

2

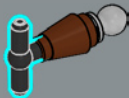

3

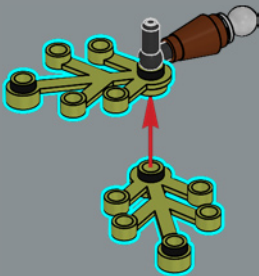

4

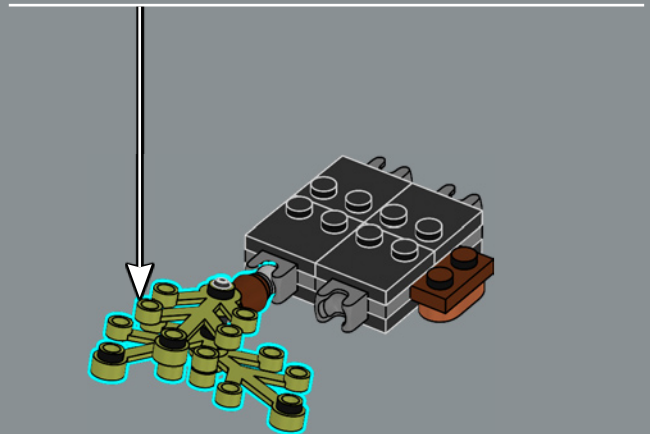
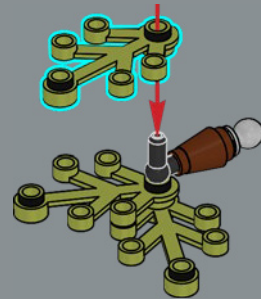

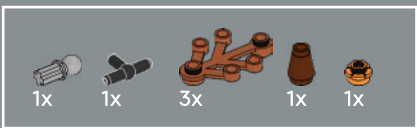

48

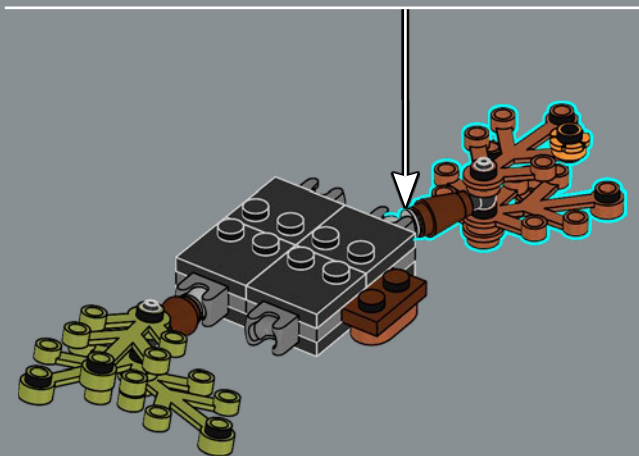
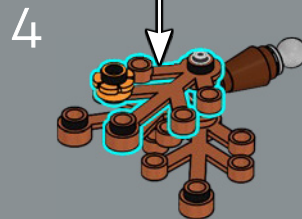
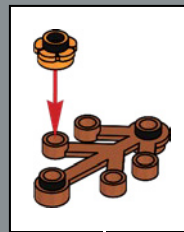
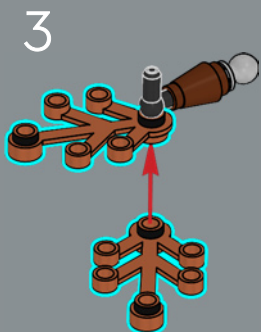
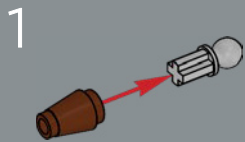



49

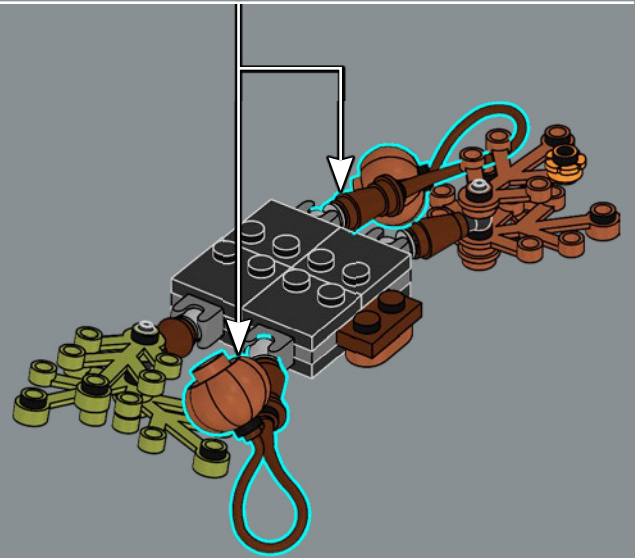
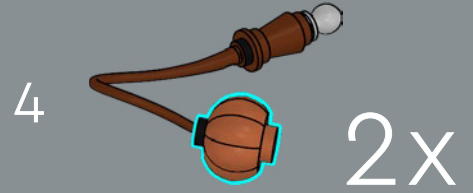
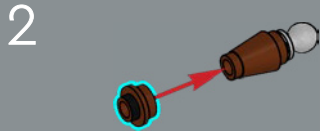
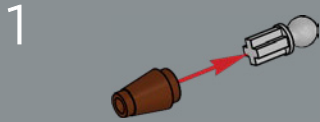

50

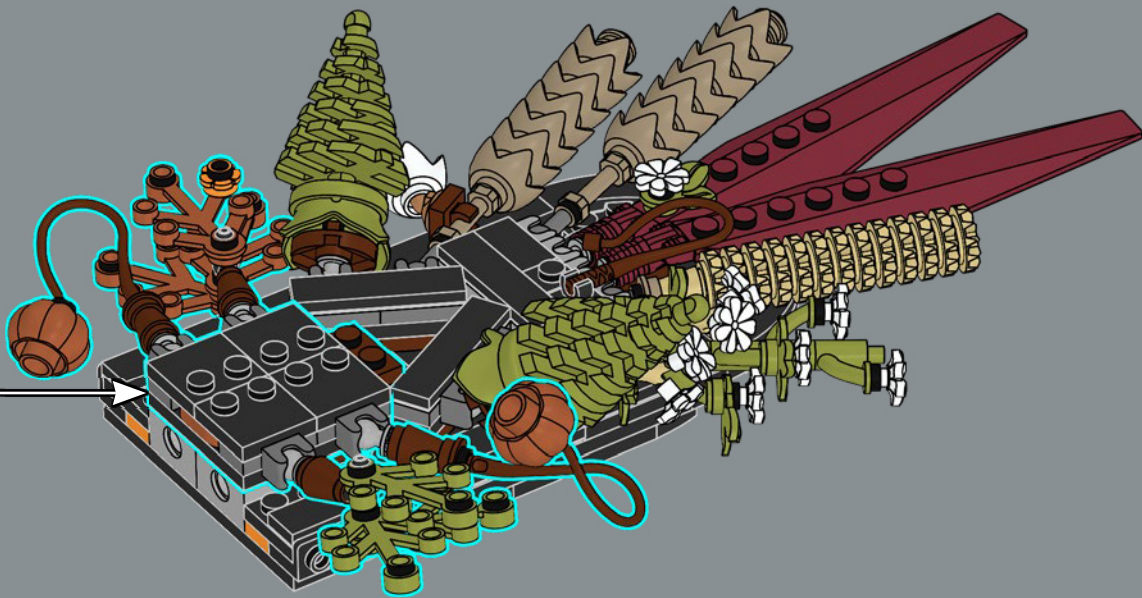

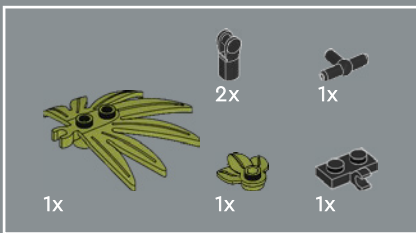

51

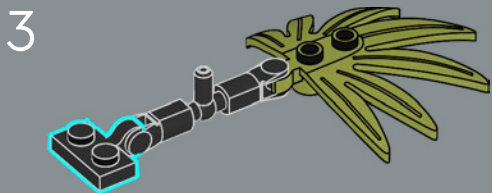
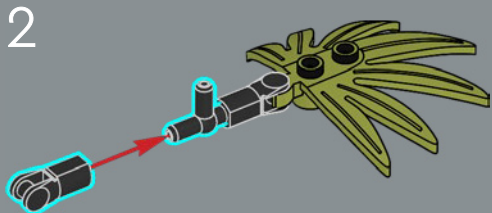
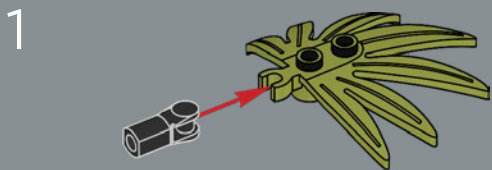

4

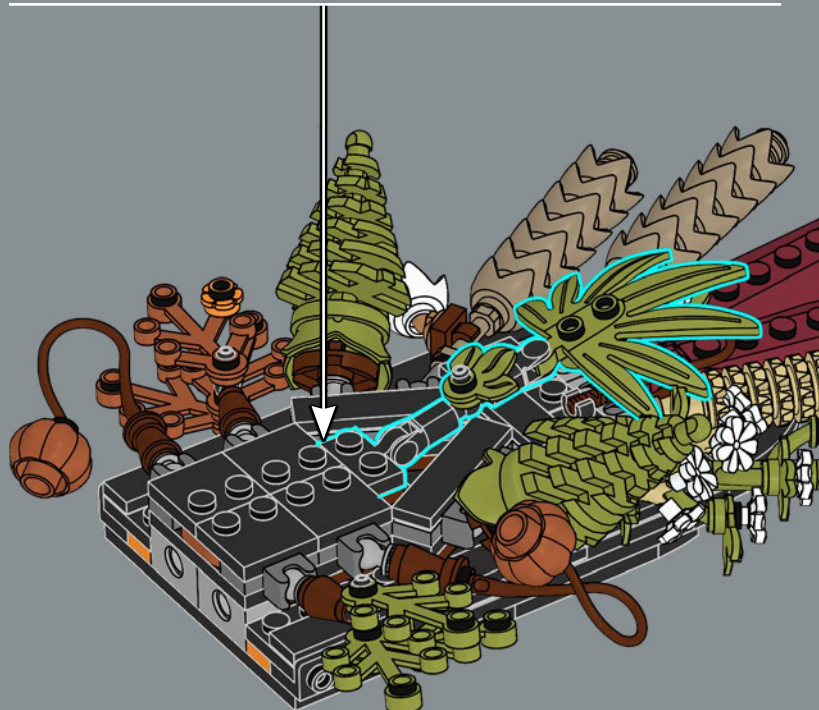
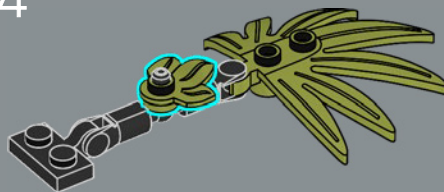



52

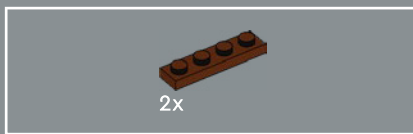
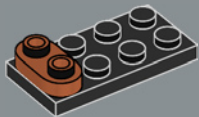

53

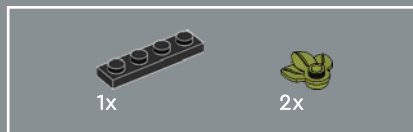
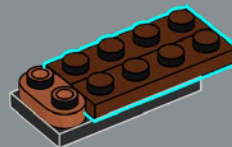

54

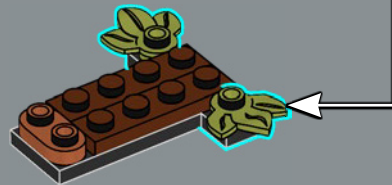
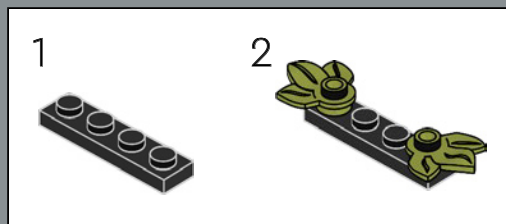

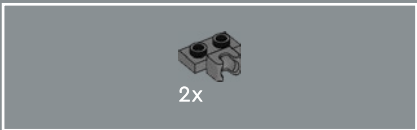

55

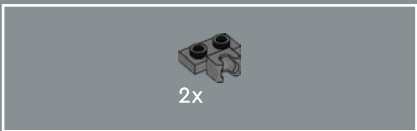
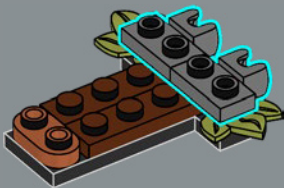

56

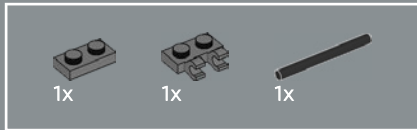
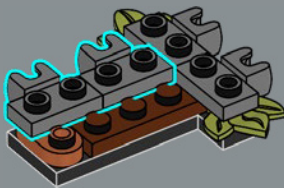

57

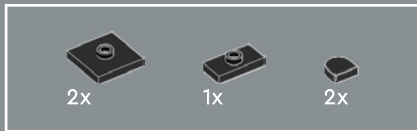
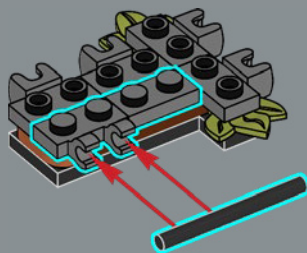

58

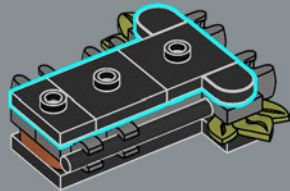

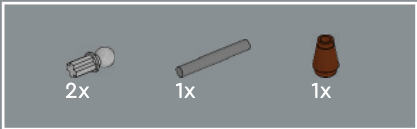

59

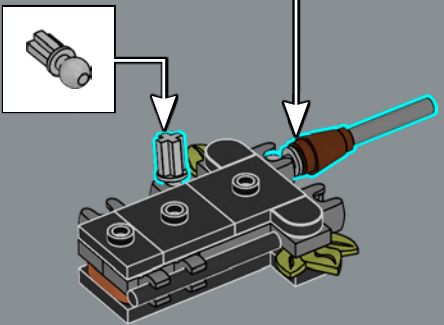
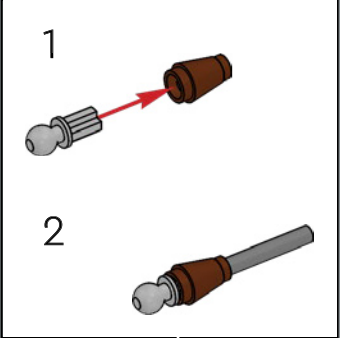

60

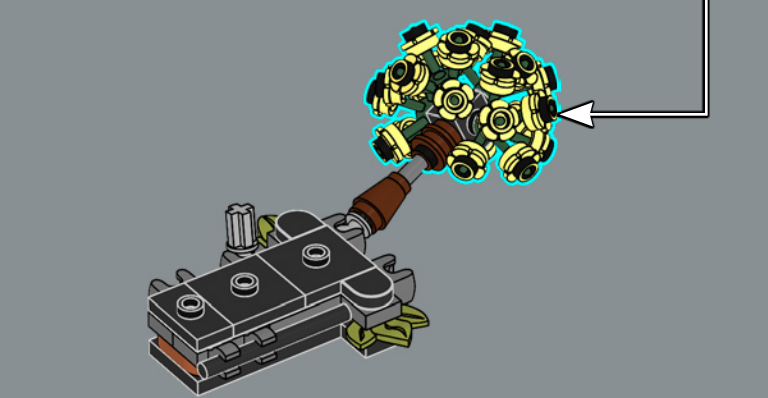
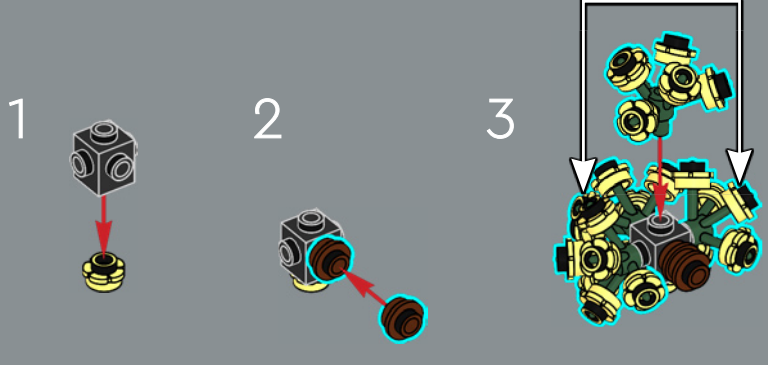
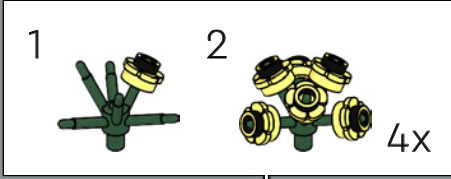

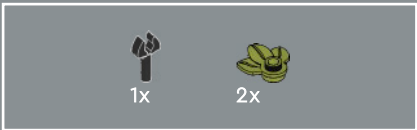

61

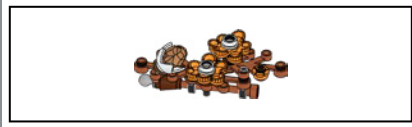
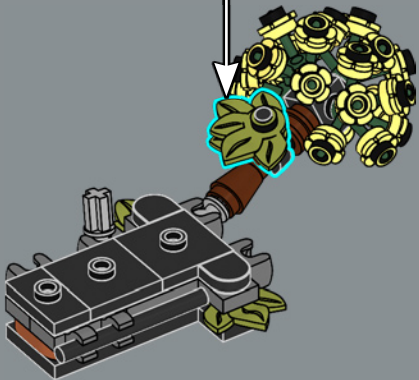
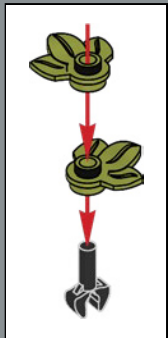

62

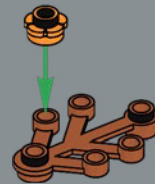

63

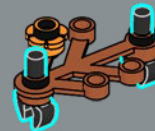



64

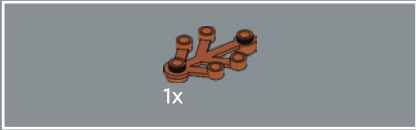
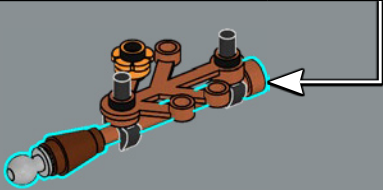
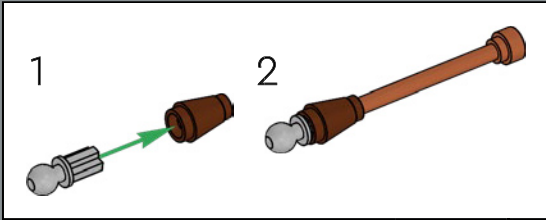

65

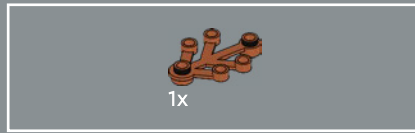
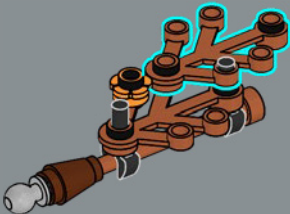

66

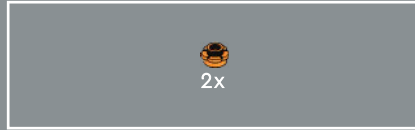
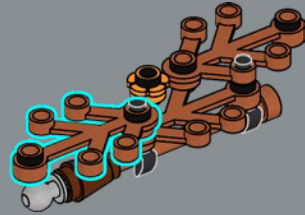

67

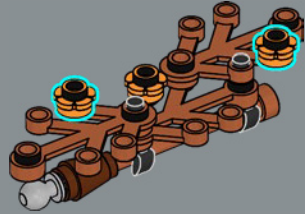



68

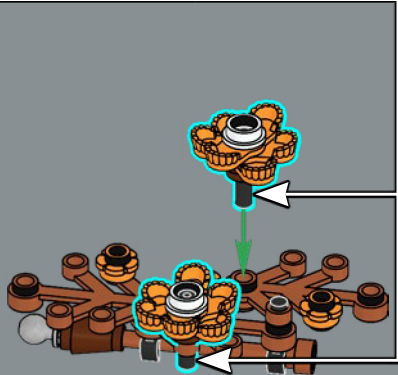
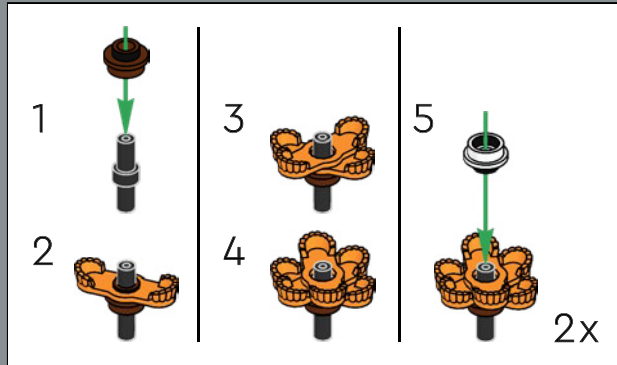

These small orange cosmos are made with a classic minifigure element: the epaulet, first used for Pirate theme Imperial Soldiers in 1989.

Ces petits cosmos orange sont fabriqués avec un élément classique des figurines : l'épaulette, utilisée pour la première fois pour les soldats impériaux du thème Pirate en 1989.

Este microcosmos naranja está hecho con un elemento clásico para minifiguras: las hombreras, usadas originalmente en los soldados imperiales del tema Pirates en 1989.



69

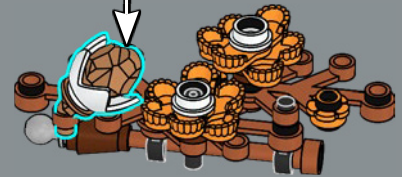
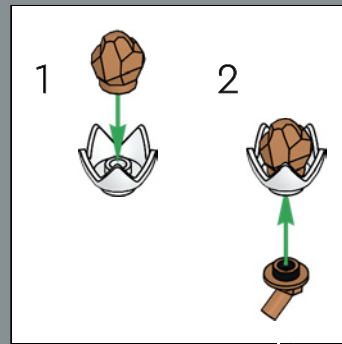

70

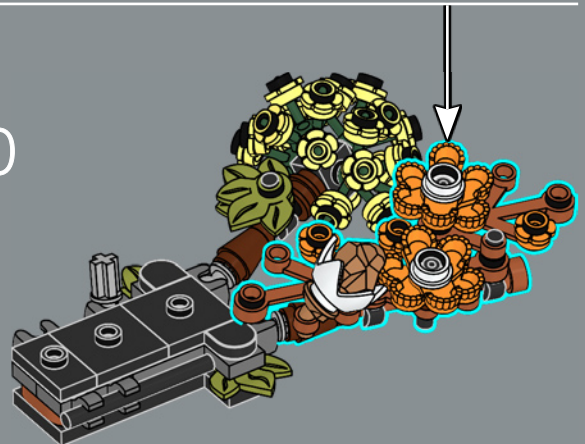



71

1

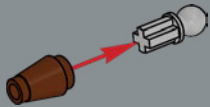

2



3

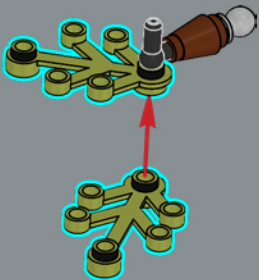

4

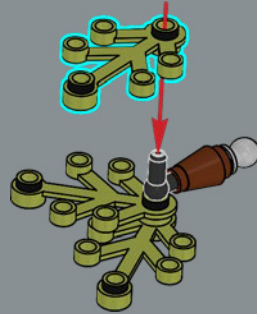

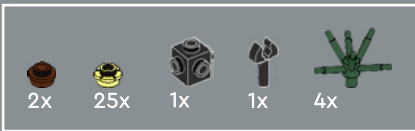

72

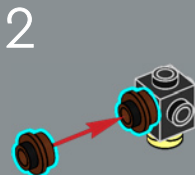
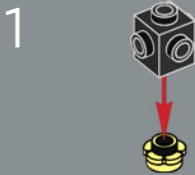

4

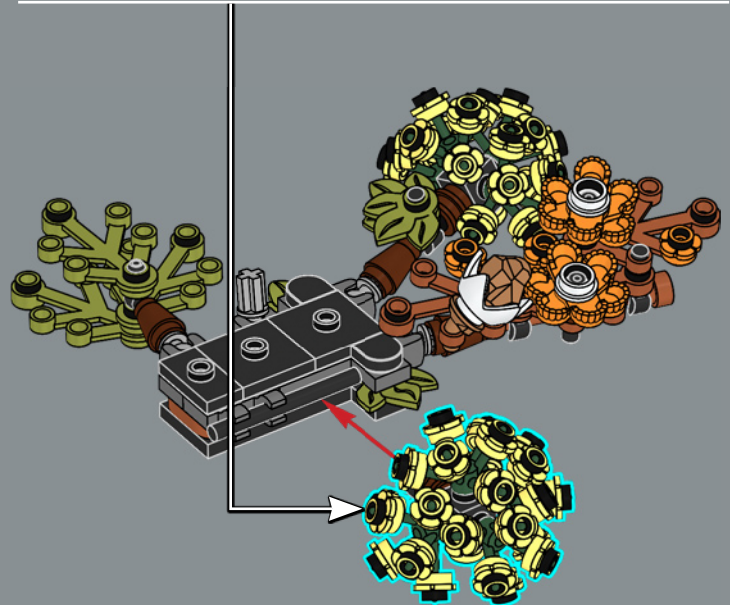
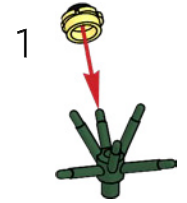
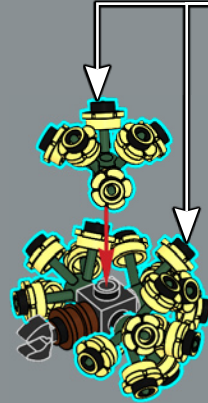

73

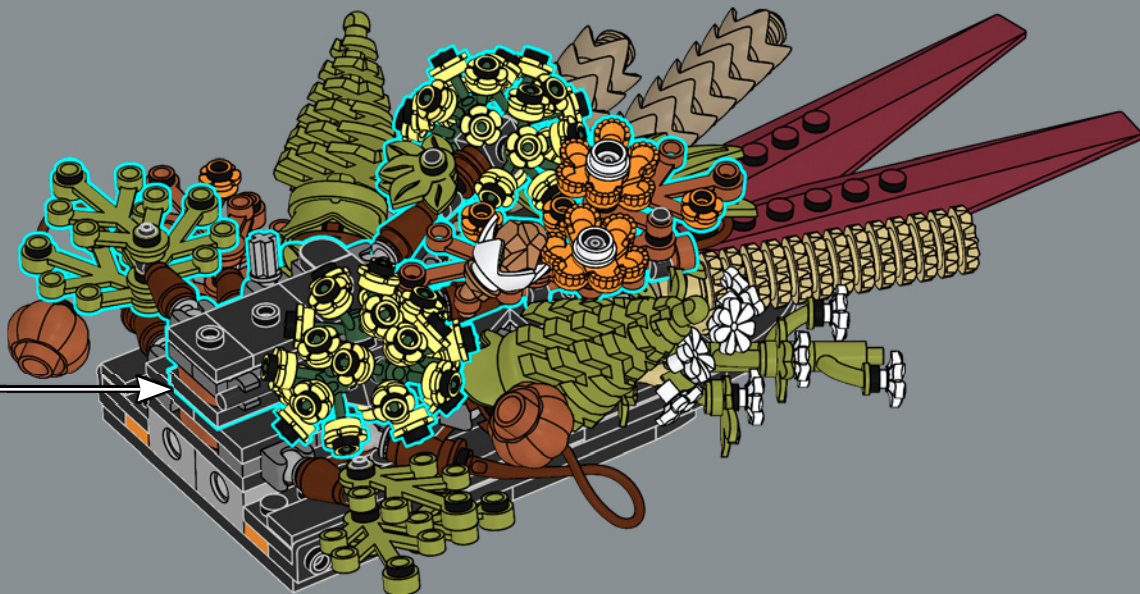



1x



3x

74

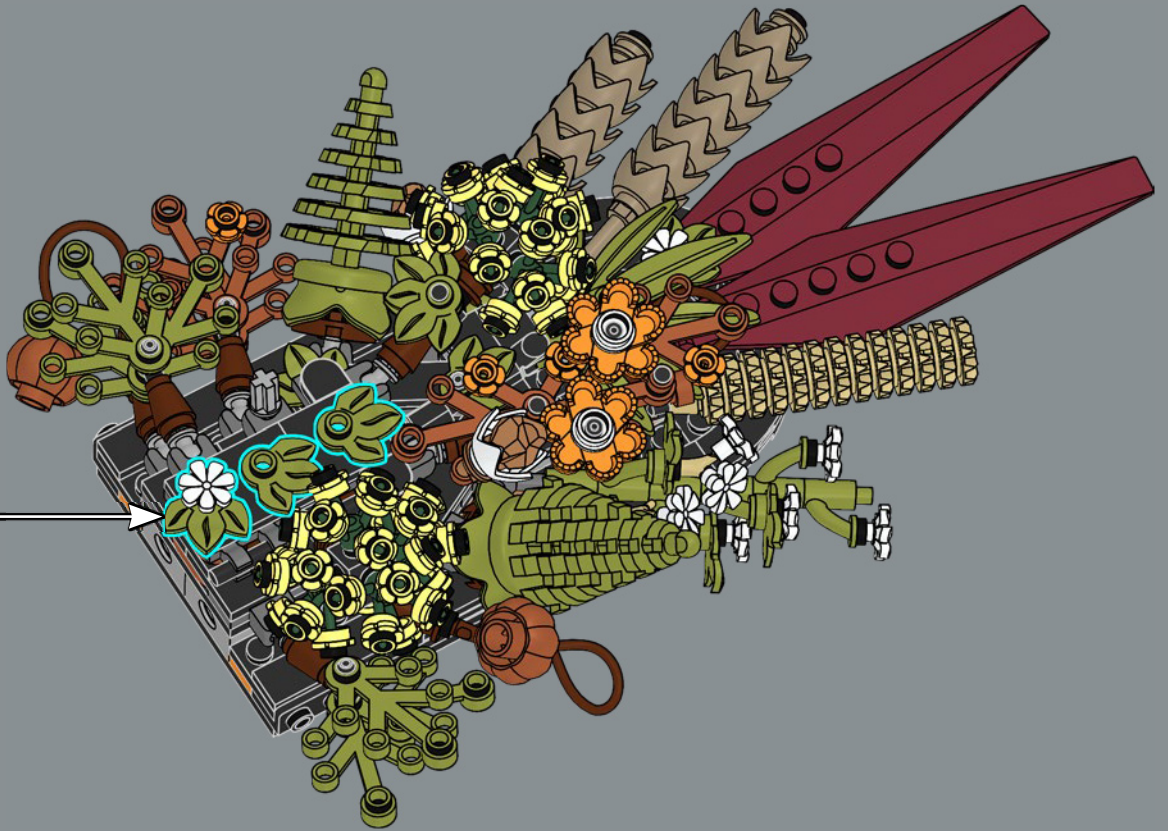
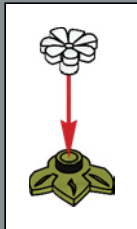

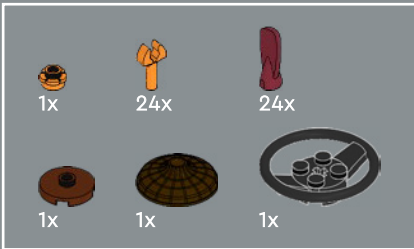
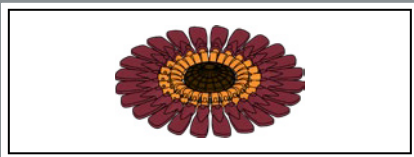

75

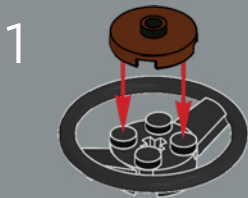

3

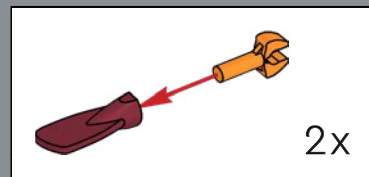
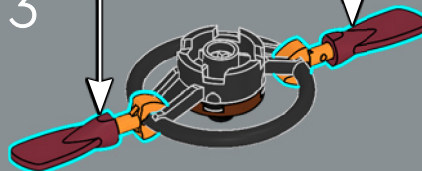

4

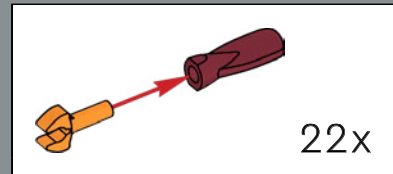



5

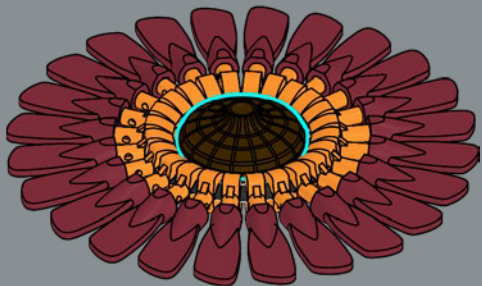

As you put together the dark red gerbera, notice that its petals are made of minifigure oar elements. It also uses a minifigure hat for the disc floret.

En assemblant la marguerite du Transvaal rouge foncé, vous remarquerez que les pétales sont faits d'éléments de rame de figurine. Elle utilise également un chapeau de figurine pour le fleuron à disque.

A medida que armes la gerbera en rojo oscuro, te darás cuenta de que sus pétalos están hechos a partir de remos para minifiguras. También hay un sombrero de minifigura en el centro de la flor.

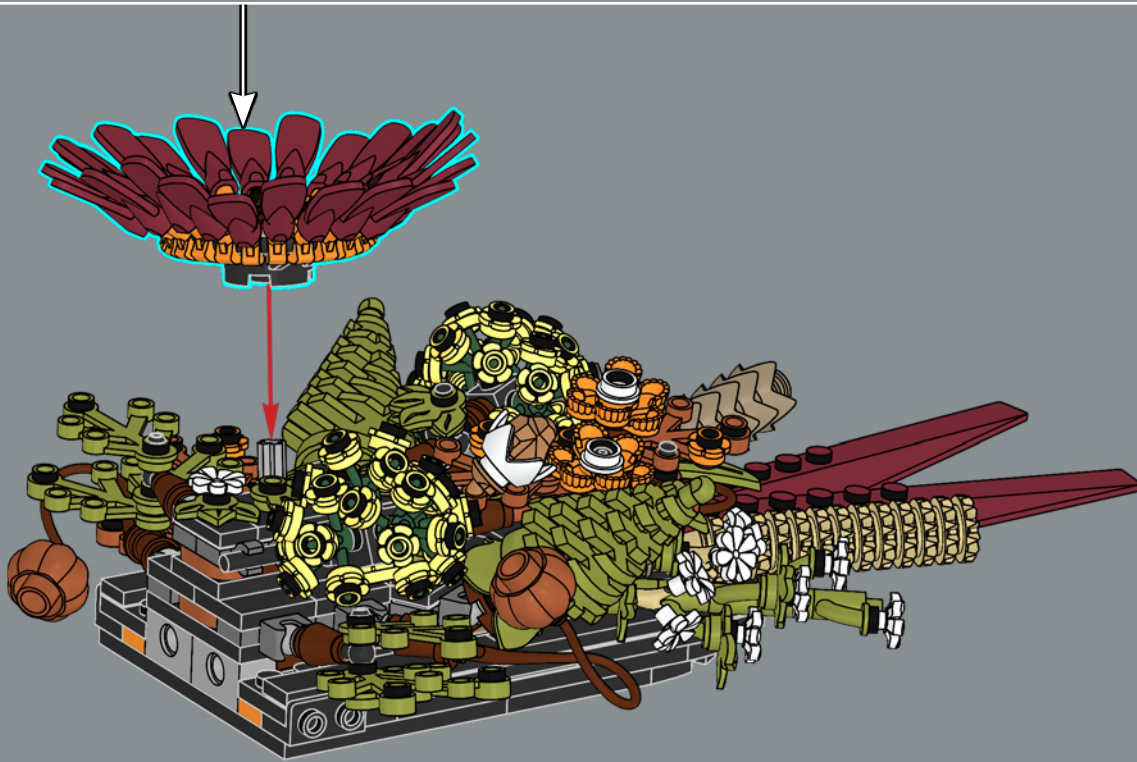

76

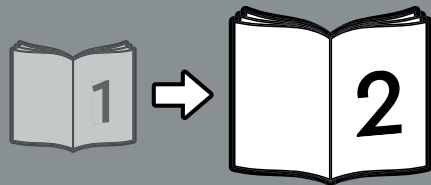
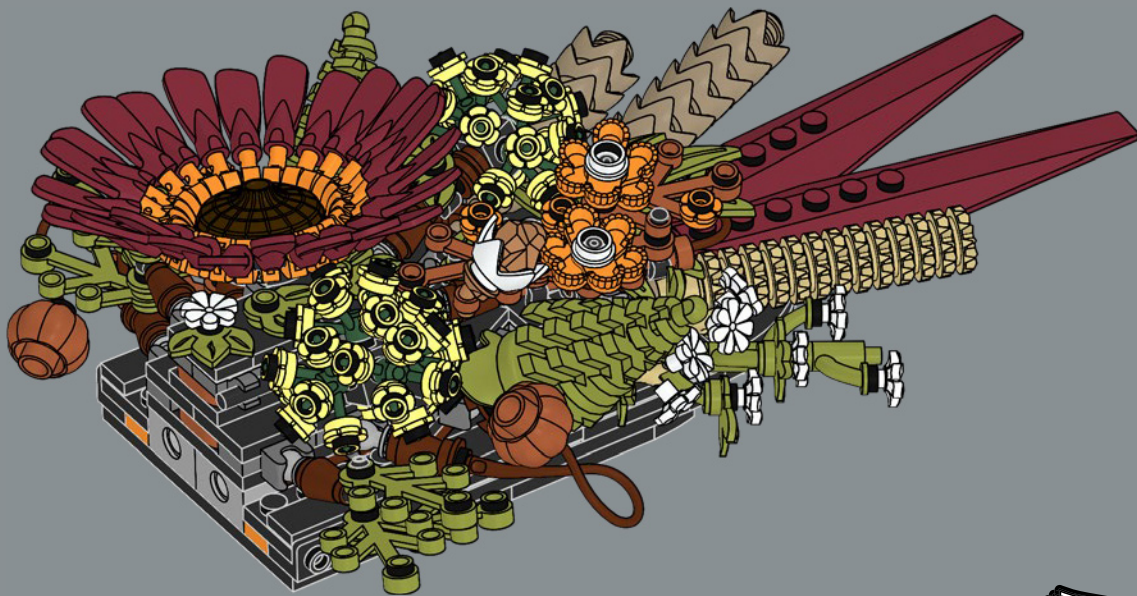



YOU COULD WIN



YOU COULD WIN

Your feedback will help shape the future development of this product series.

Visit:

DU KÖNNTEST GEWINNEN

Dein Feedback trägt zur Weiterentwicklung dieser Produktreihe bei.

Geh auf:

VOUS POURRIEZ GAGNER

Vos commentaires nous aideront à concevoir les futurs produits de cette gamme.

Visitez :

POTRESTI VINCERE TU

La tua opinione ci aiuterà a migliorare la creazione futura di questa linea di prodotti.

Visita:

PUEDES GANAR

Tu opinión contribuirá al futuro de esta serie de productos.

Visita:

轻松获奖

您的反馈将有助于我们在今后改进本产品系列。

请访问：

LEGO.com/productfeedback

You also have the chance to win a LEGO® set.

Terms and conditions apply.*

Außerdem hast du die Chance, ein LEGO® Set zu gewinnen.

Es gelten die Teilnahmebedingungen.*

Vous pourriez également gagner un ensemble LEGO®.

Des conditions s'appliquent.*

Hai anche la possibilità di vincere un set LEGO®.

Termini e condizioni sono applicabili.*

También tienes la oportunidad de ganar un set LEGO®.

Aplican términos y condiciones.*

您还有机会赢取乐高®套装。

条款和条件适用。*

*[LEGO.com/productfeedback-terms](https://www.lego.com/productfeedback-terms)

GROW YOUR COLLECTION OF
LEGO® BOTANICAL MODELS

AGRANDISSEZ VOTRE COLLECTION DE
MODÈLES BOTANIQUES LEGO®

HAZ CRECER TU
COLECCIÓN DE
MODELOS LEGO®
BOTANICAL



10280
Flower Bouquet
Le bouquet de fleurs
Ramo de Flores



10311
Orchid
L'orchidée
Orquídeas

10313
Wildflower Bouquet
Le bouquet de fleurs sauvages
Ramo de Flores Silvestres



10281
Bonsai tree
Le bonsaï
Bonsái



6x
6168642



2x
6210272



24x
6338913



4x
6259700



2x
6378415



2x
4529237



4x
6347292



6x
6324176



26x
4565452



4x
6431730



4x
6330588

50



1x
6391341



2x
370126



2x
6267487



6x
306926



2x
302326



2x
6092585



10x
6192346



2x
4565323



2x
6133722



6x
243126



6x
371026



4x
4560182



12x
302026



2x
6350415



4x
6347310



2x
6313116



4x
6020193



1x
6350725



4x
6256435



4x
6210270



12x
663626



2x
6058118

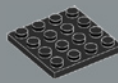

4x
4243819



7x
346026

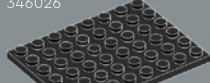

2x
303626



2x
4514845



4x
287726



4x
473326



6x
6371584



2x
6116604



6x
6321194



8x
6278152



4x
6279875



8x
6104209



8x
6191630



3x
6325190



1x
6299938



4x
6171264



4x
6101857



4x
6133200



8x
6369194



13x
6022079



2x
6400293



3x
6426472



1x
6074892



2x
6219673



2x
4177932



4x
6106027



8x
6030521



8x
6214234



18x
6426228



24x
6278159



1x
6149656



1x
6240515

15x
6426470

4x
6285465

31x
6398008

4x
6426468

4x
6426464

10x
6268815

2x
6313102

2x
6348057

4x
6313124

14x
4529242

4x
6172922

1x
6257604

3x
4211190

2x
6307618

2x
4211186

17x
6215659

2x
6075213

4x
4211159

1x
6102360

4x
6170468

5x
6359864

8x
6416695

2x
4211440

4x
6326478

8x
6043639

22x
4211375

2x
4211805

1x
4211063

2x
6388119

23x
6146792

2x
6350292

2x
6310596

9x
6364352

100x
6426463

1x
6384238

1x
6384589

1x
6416732

4x
6431549

16x
6398343

4x
6102998

6x
6093494

2x
6347304

1x
6177189

4x
6400315

4x
6432504

2x
6299413

34x
6300322

28x
6431686

24x
6426473

4x
6431687

4x
6426471

7

 [LEGO.com/service](https://www.LEGO.com/service)

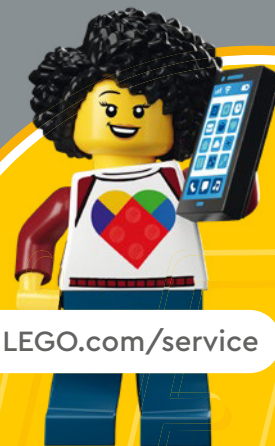



6452568