

77

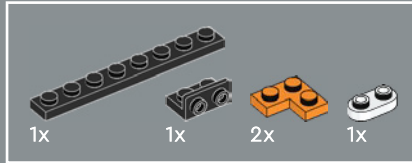

78

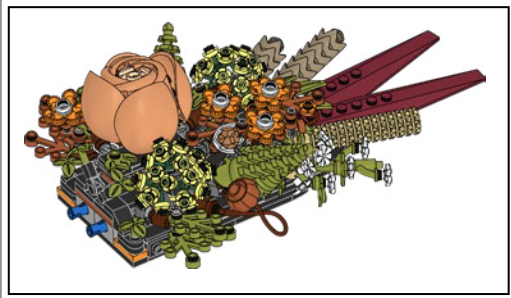

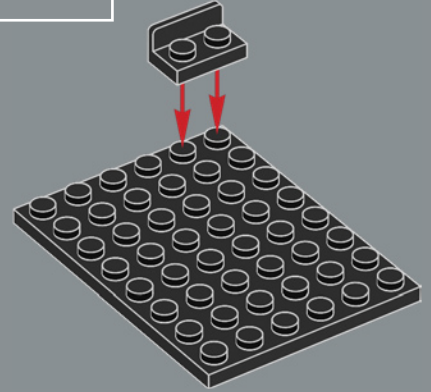
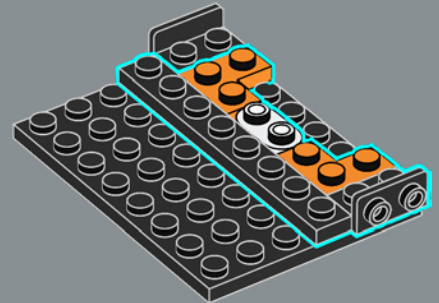
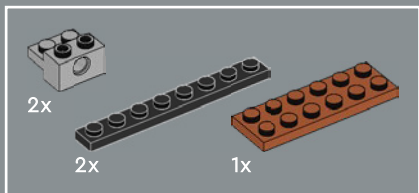

79

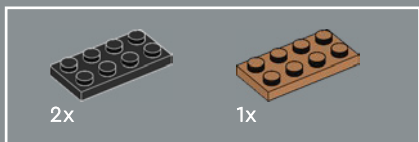
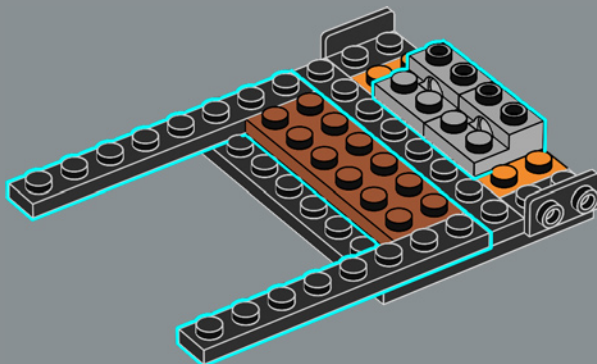

80

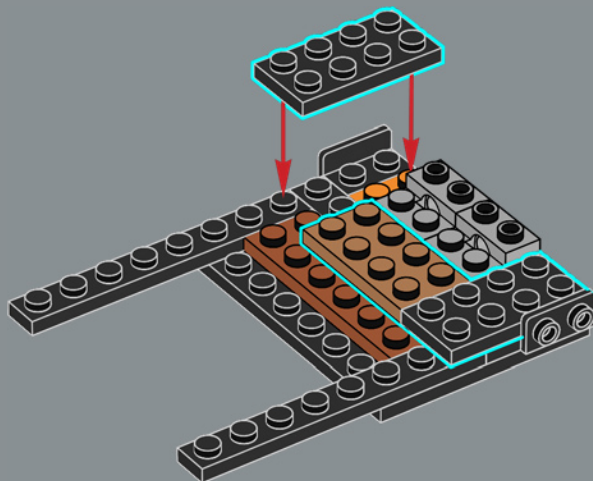

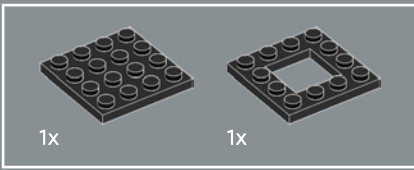

81

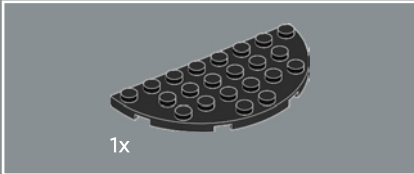
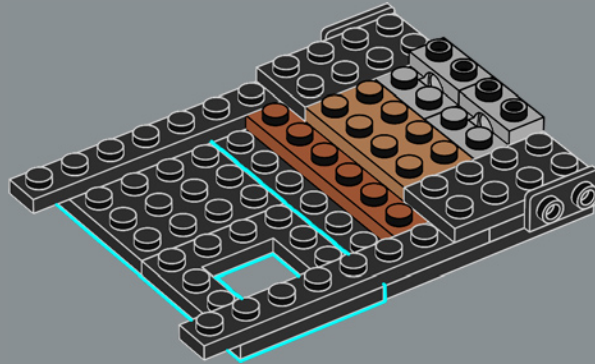

82

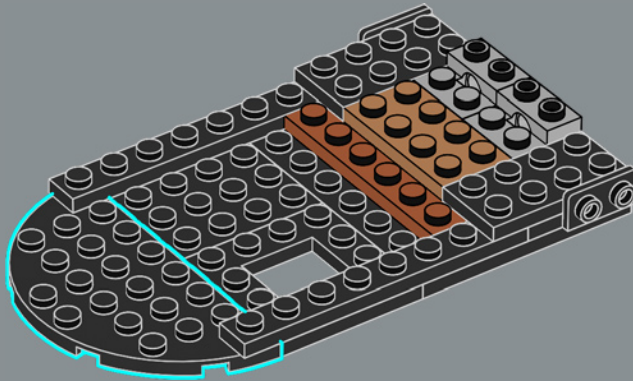

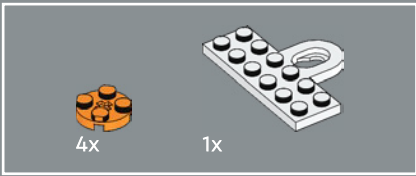

83

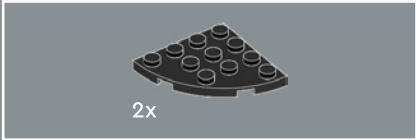
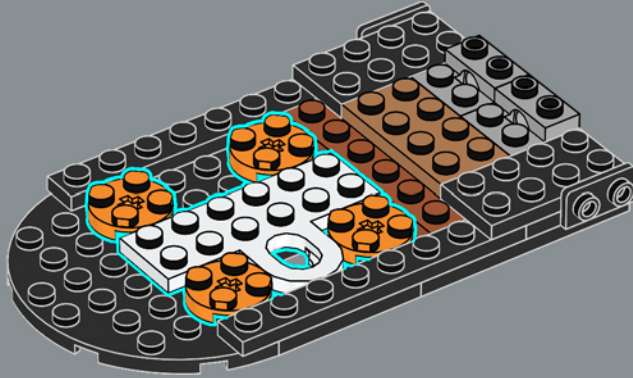

84

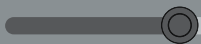
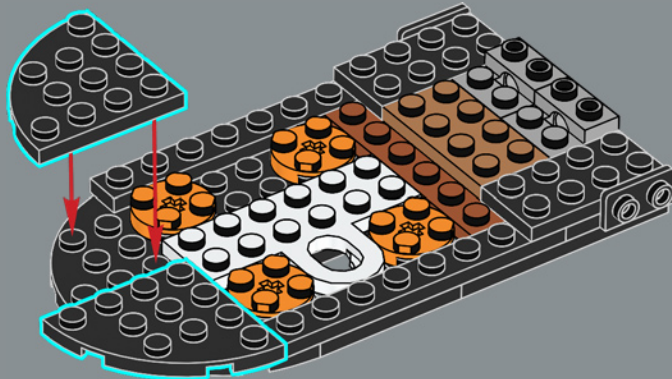

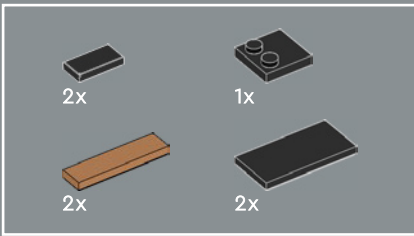

85

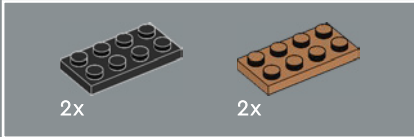
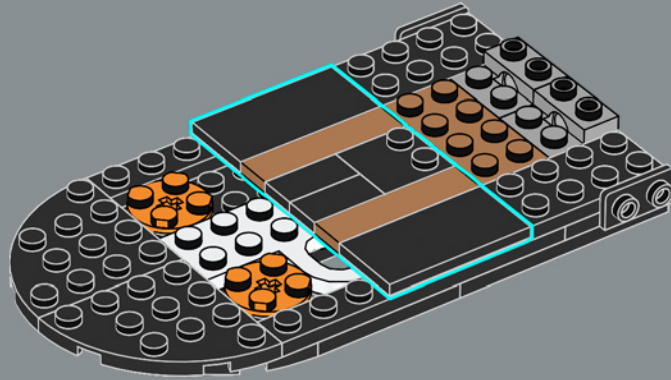

86

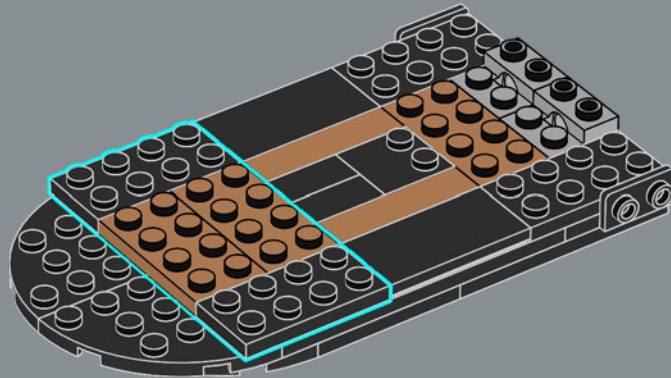

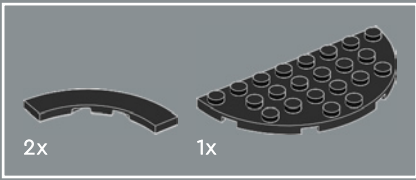

87

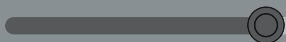
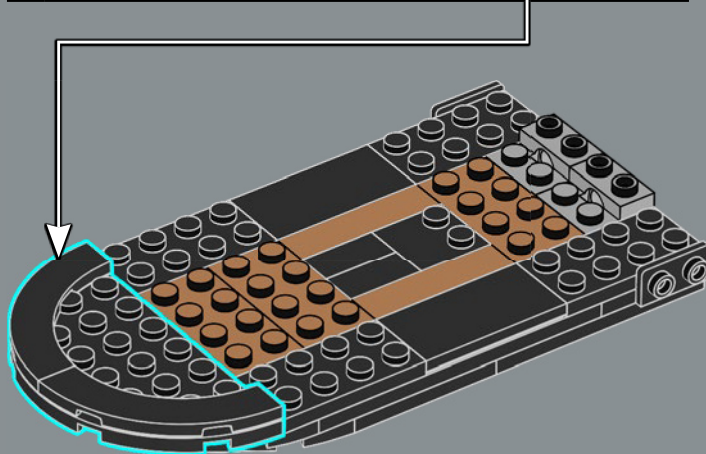
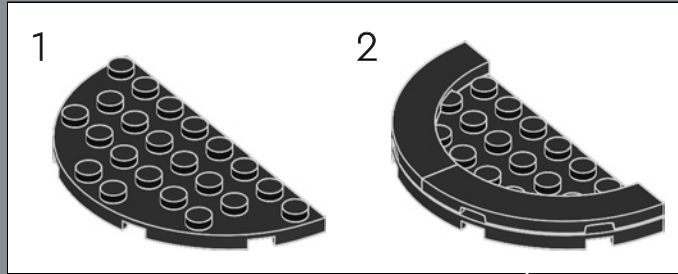

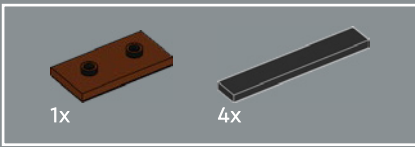

88

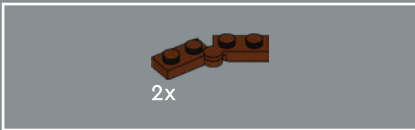
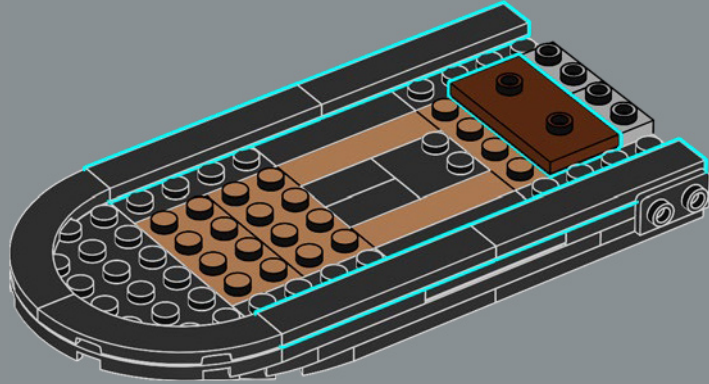

89

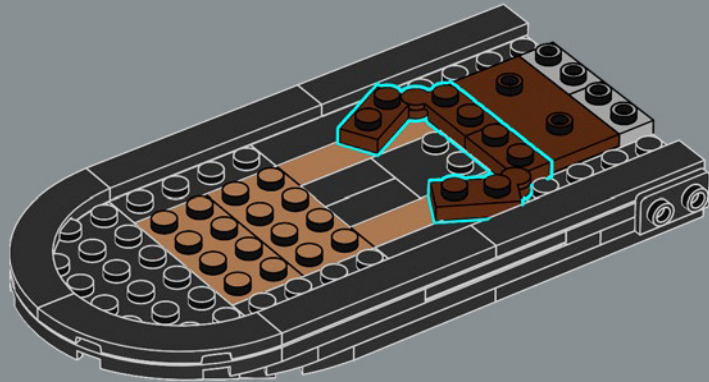

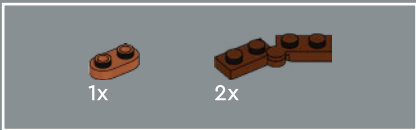

90

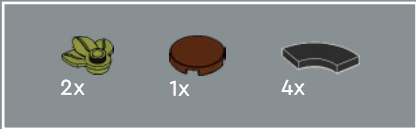
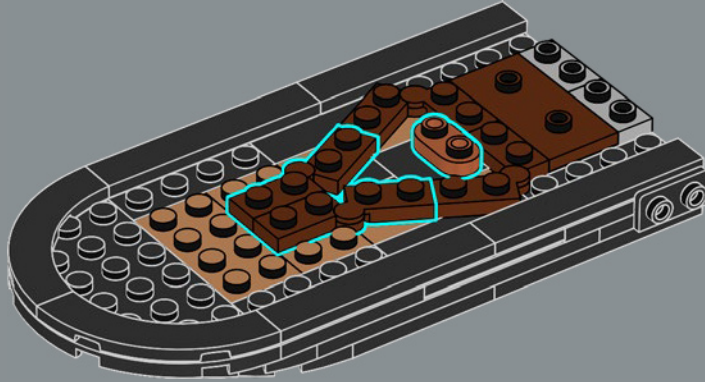

91



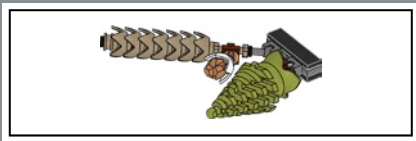

92

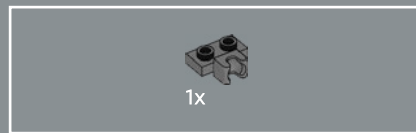
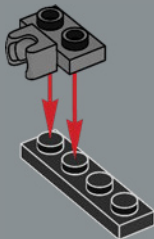

93

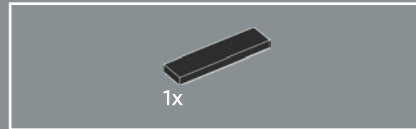
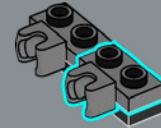

94

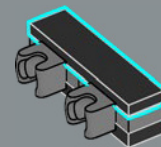



95

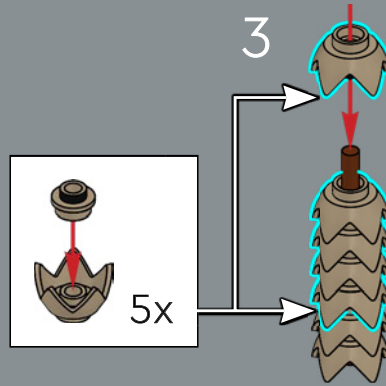
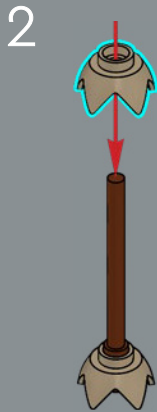
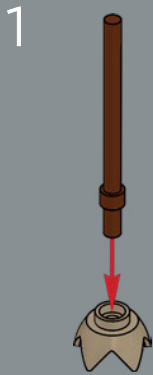



5



1x



1x



1x



1x

96

1



2



3

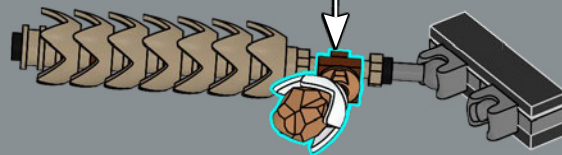

The stalks of wheat use nested crown elements to give the wheat its corrugated appearance.

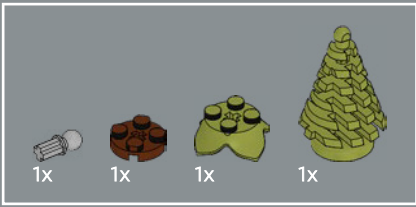

97

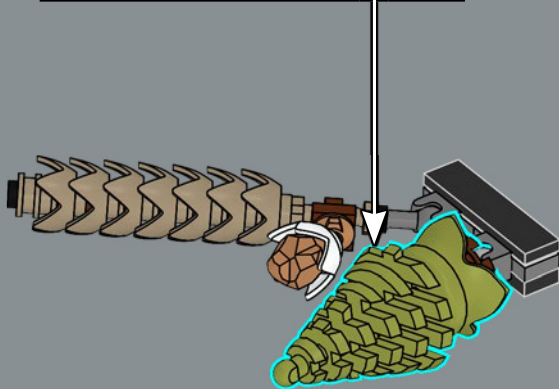
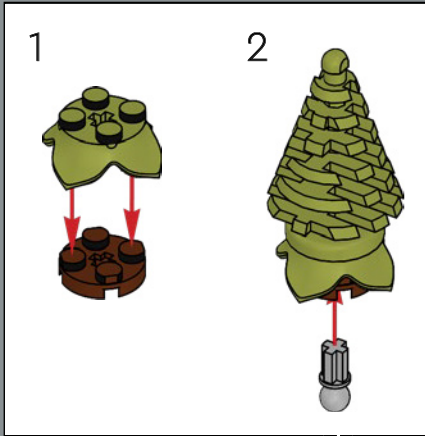

98

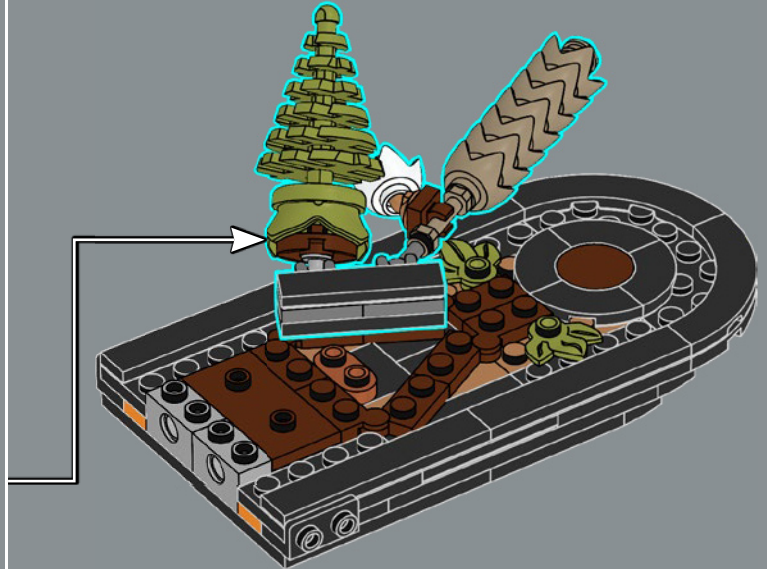

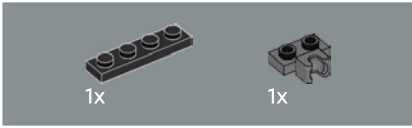
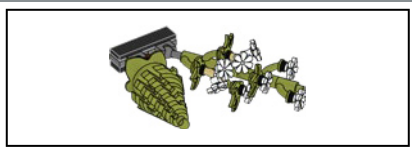

99

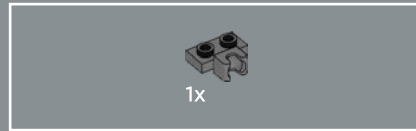
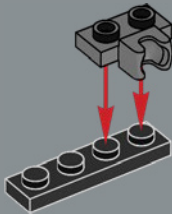

100

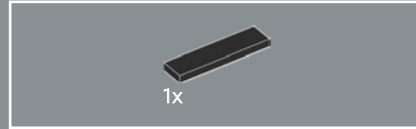
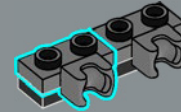

101

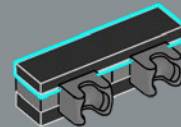

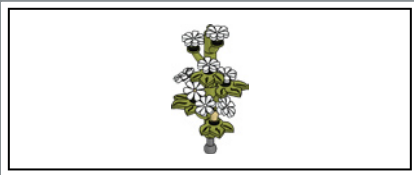

1x

2x

102



2x

103

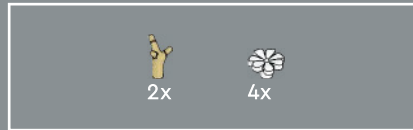
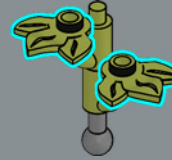

2x

4x

104

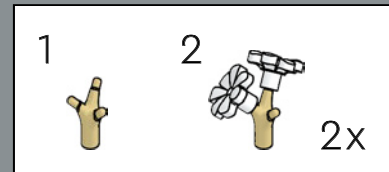

1

2

2x

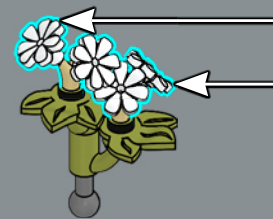



105

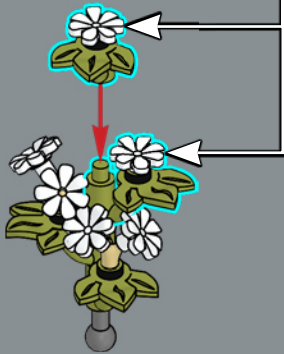
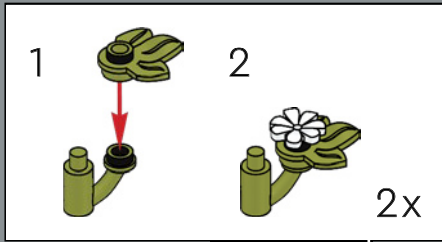

106

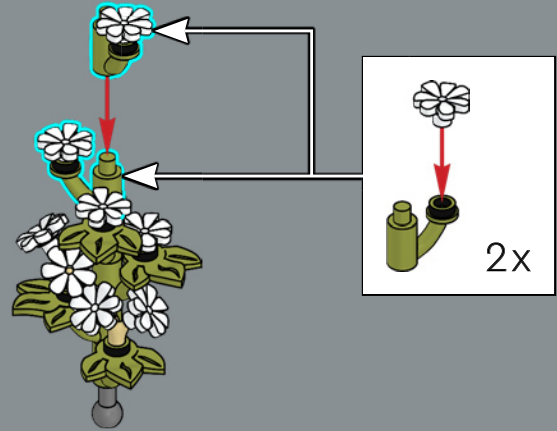

107

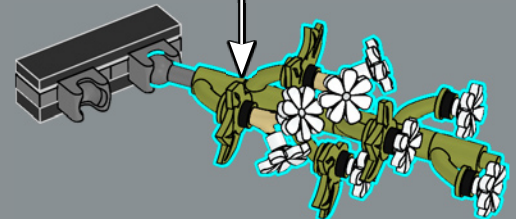

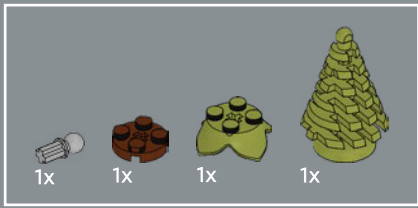

108

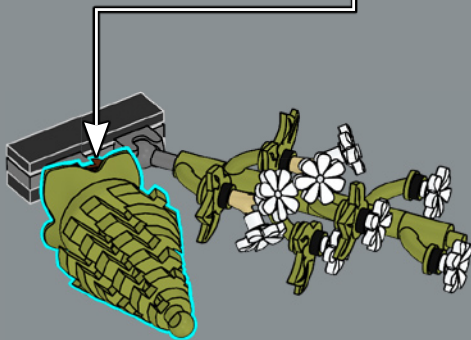
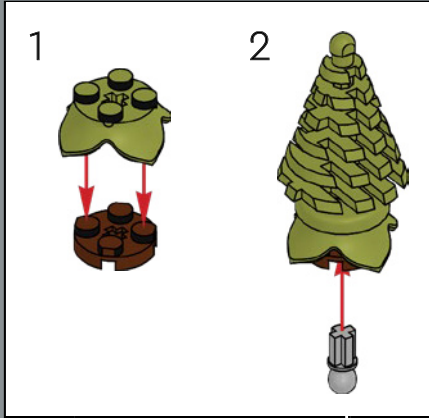

109

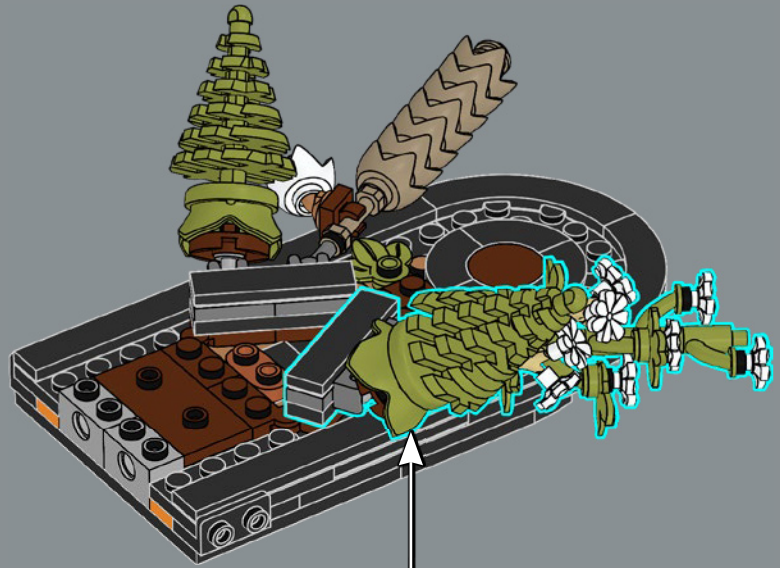

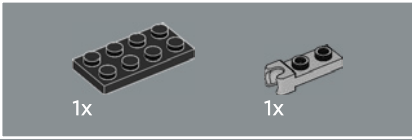
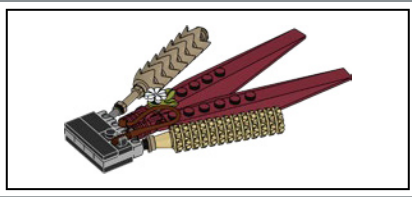

110

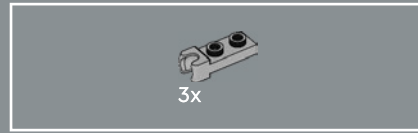

111

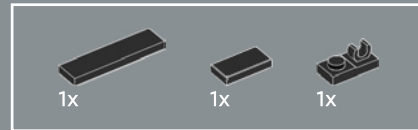
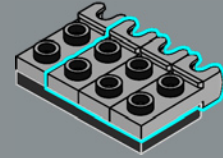

112

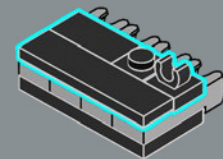

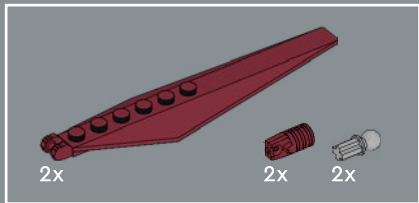

113

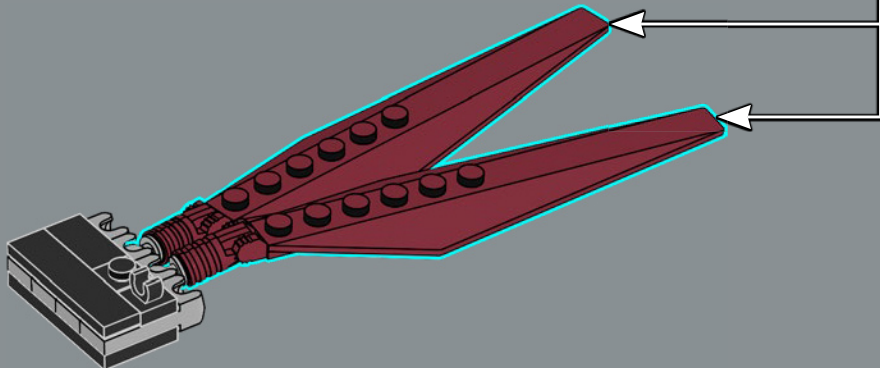
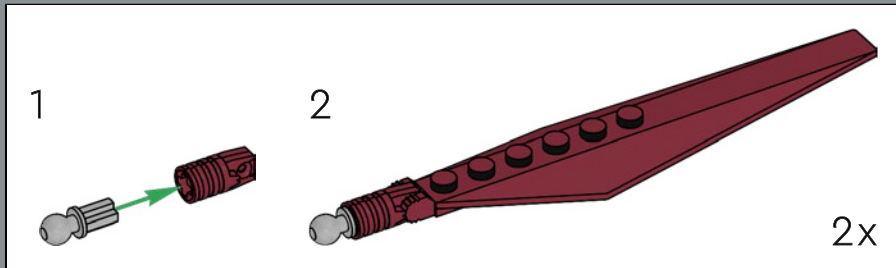

114

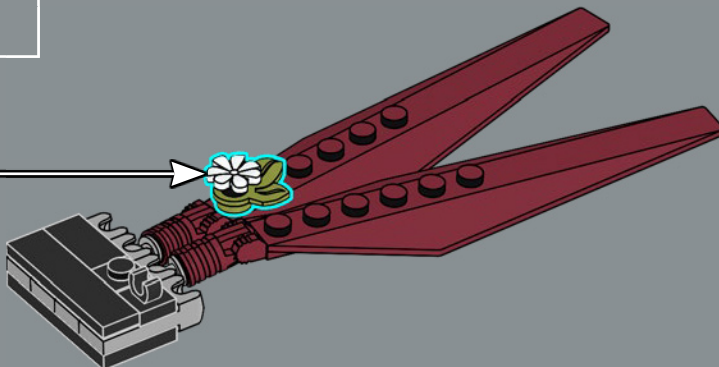
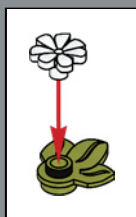



115

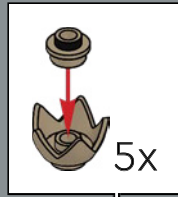
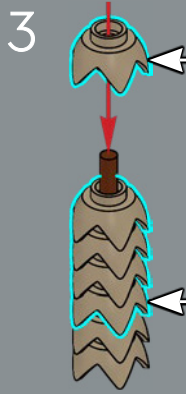
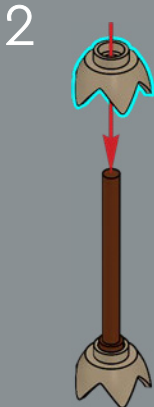
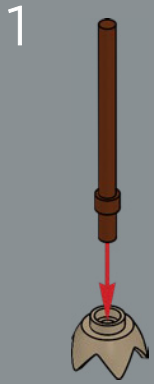

5

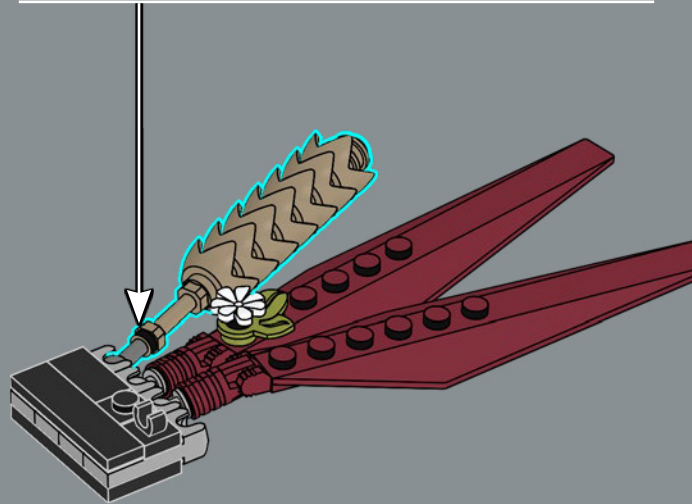

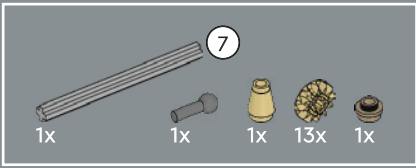

116

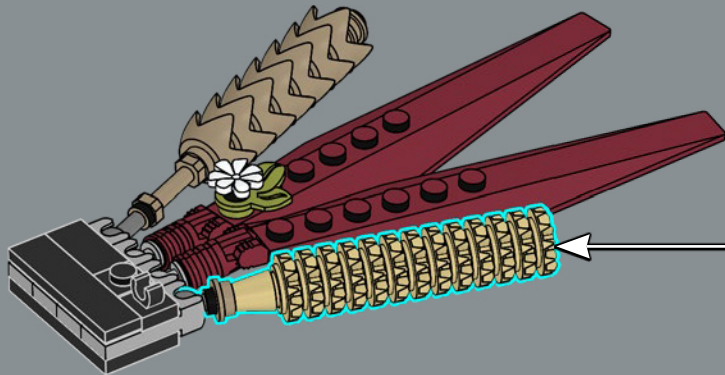
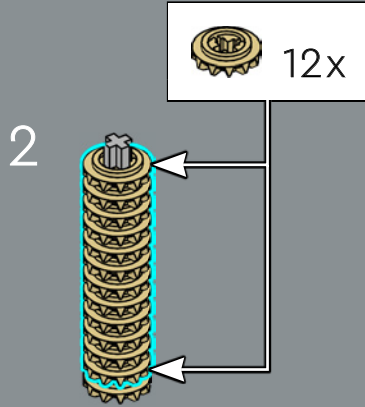



117

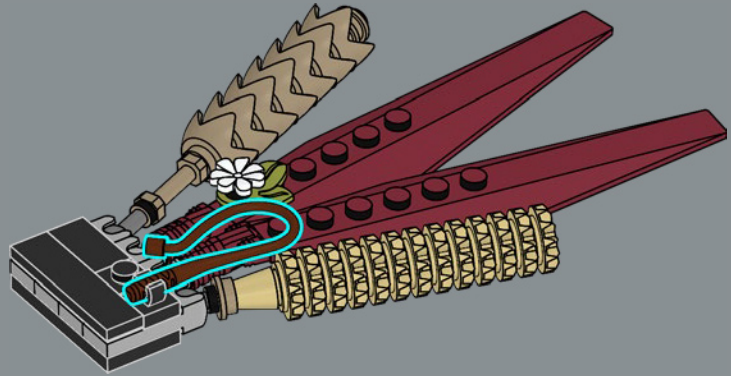

118

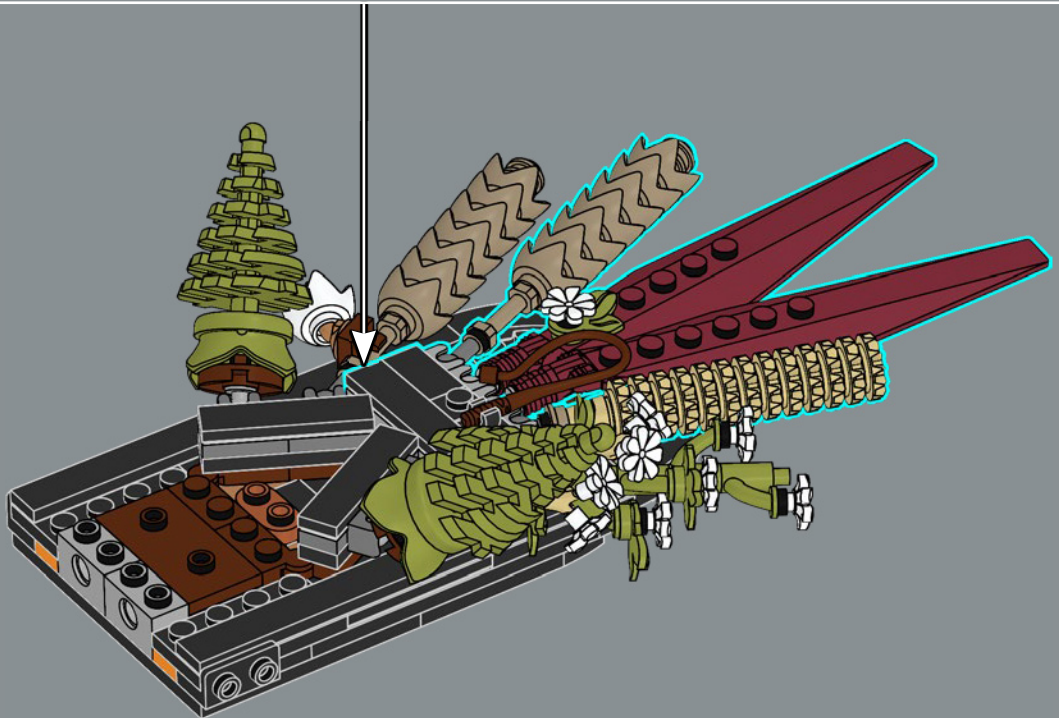

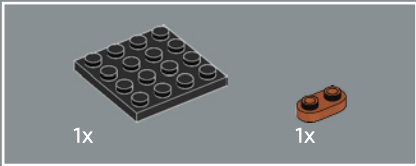
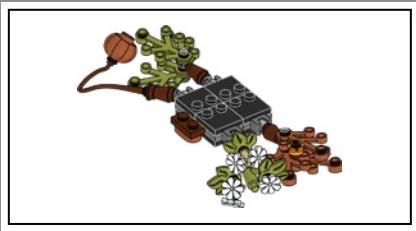

119

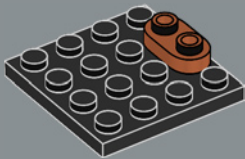

120

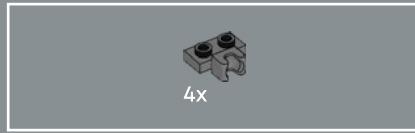
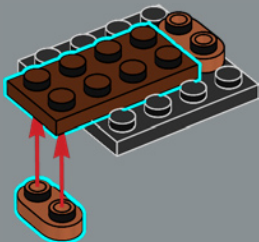

121



4x

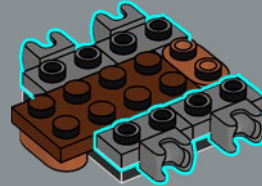

122



4x

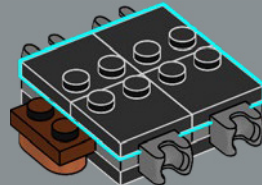



123

1

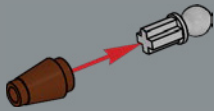

2



3

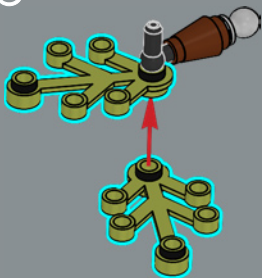

4

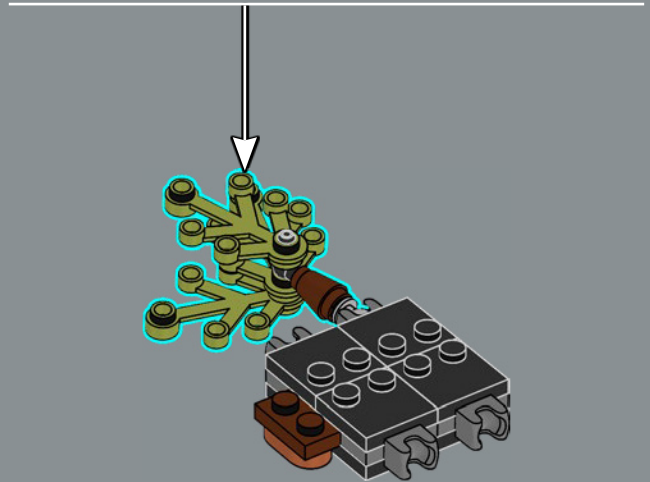
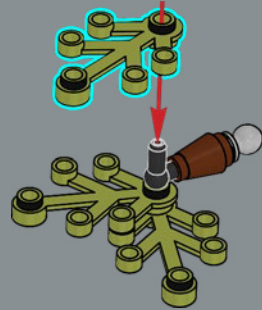



124

1

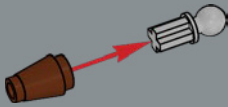

2

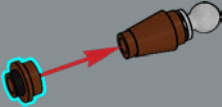

3

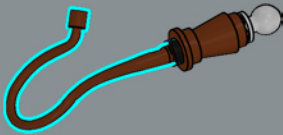

4

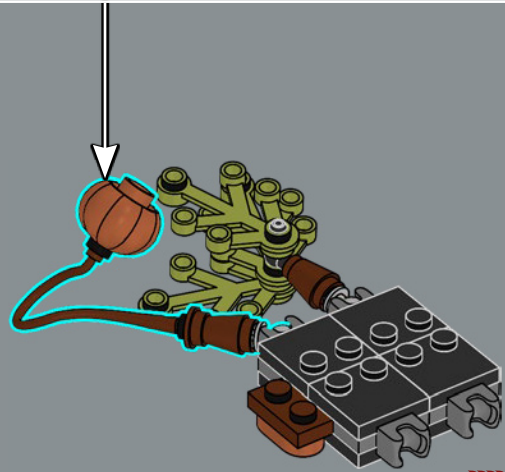

The peculiarly named bladder cherry is built with a LEGO® element that is usually used as vegetables, (like pumpkins or lanterns) and a flexible brown whip element.





125

1

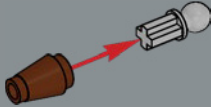

2



3

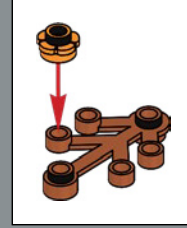
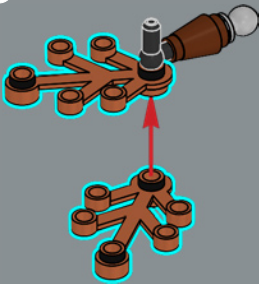

4

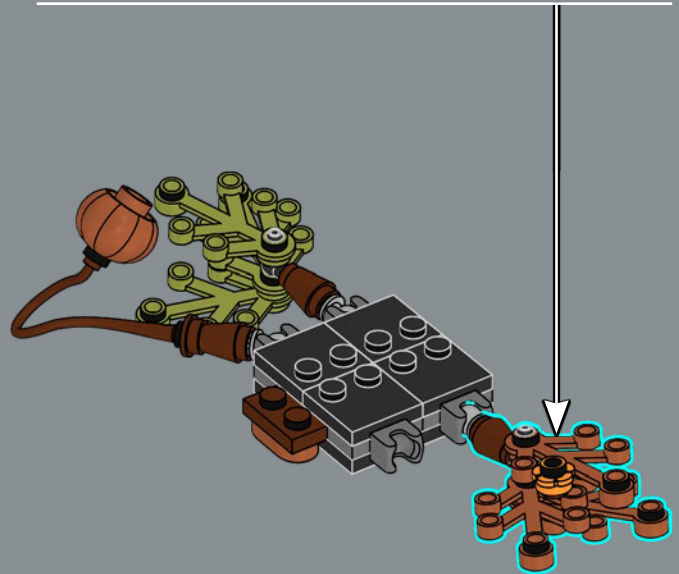
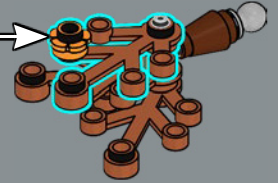

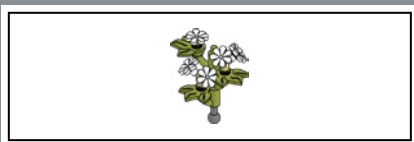

126



127



128

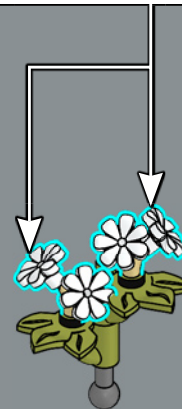
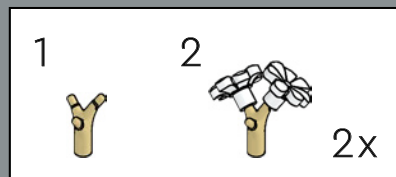



129

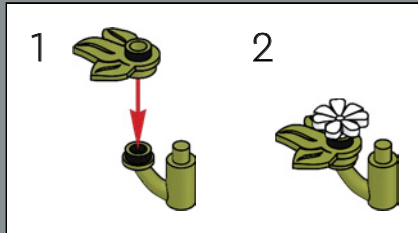

130

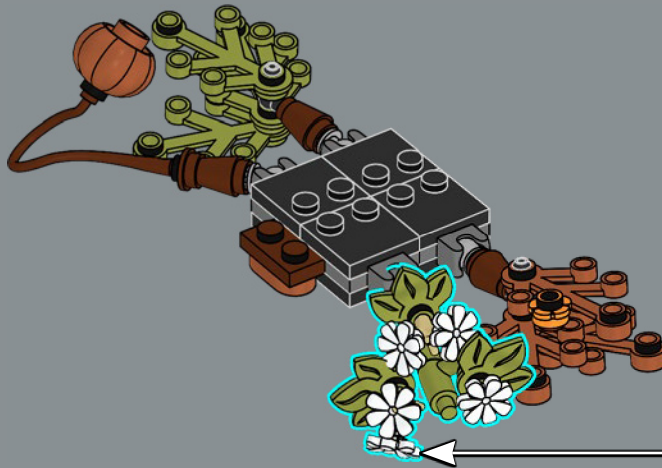

131

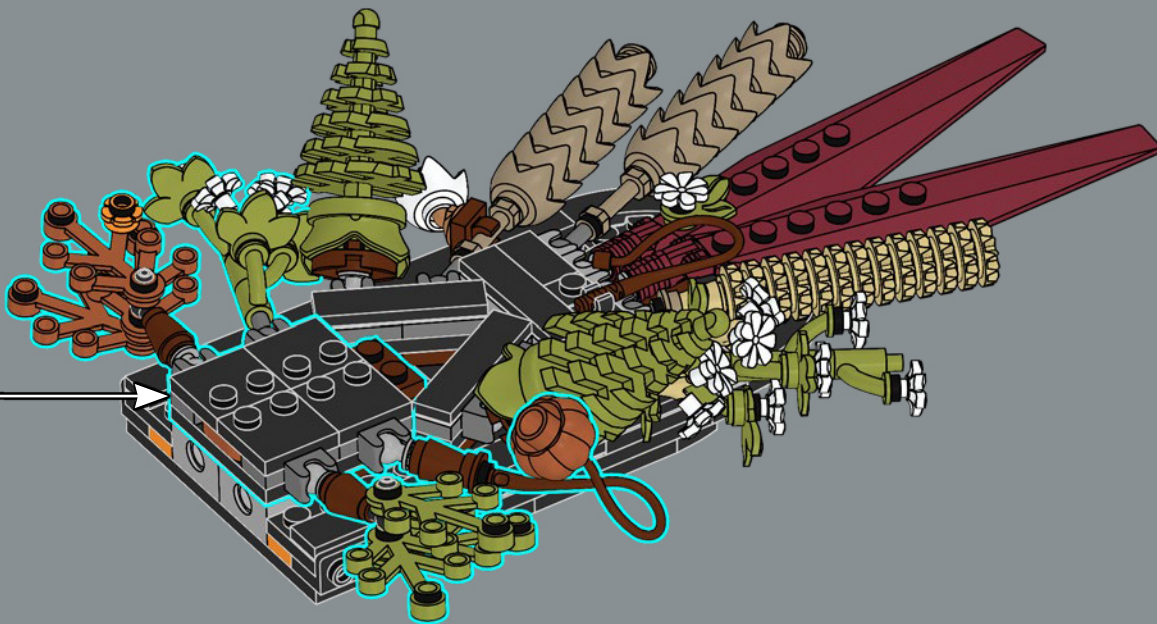

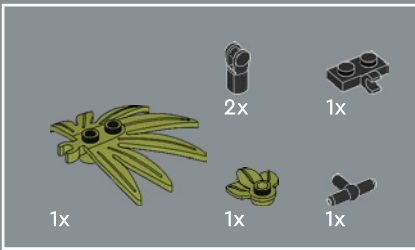

132

1

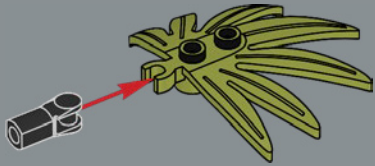

2

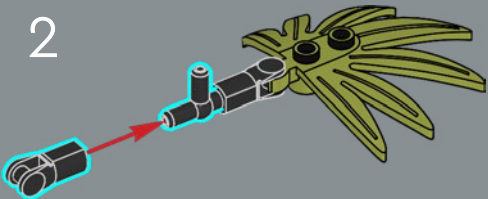

3

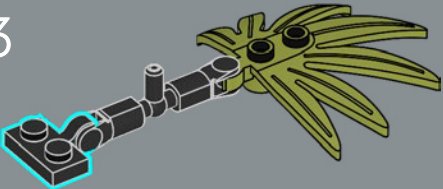

4

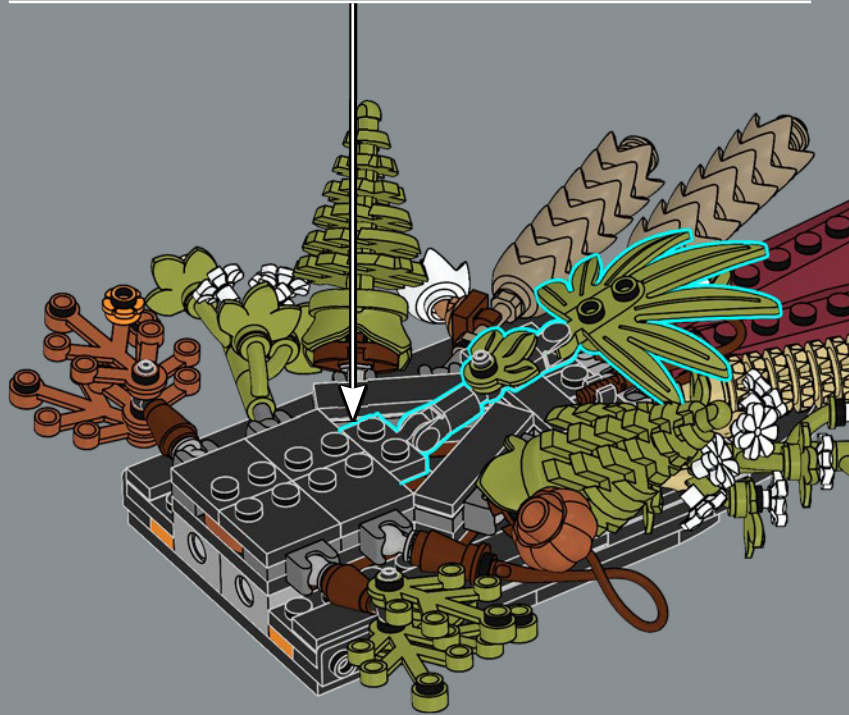
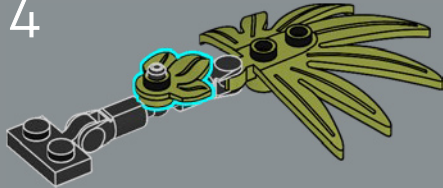

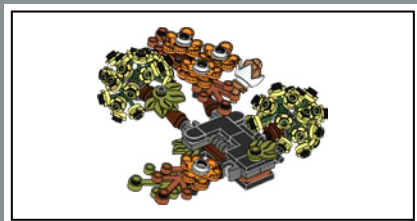

133

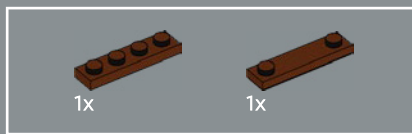

134

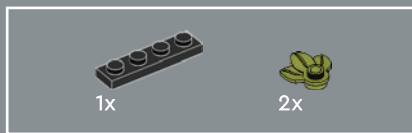
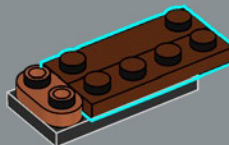

135

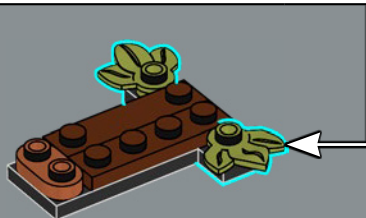
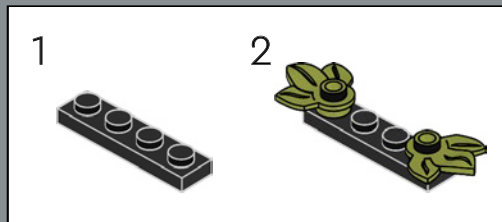

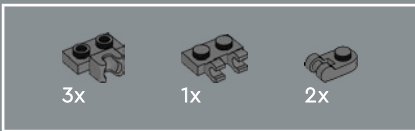

136

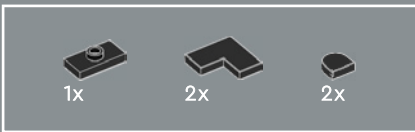
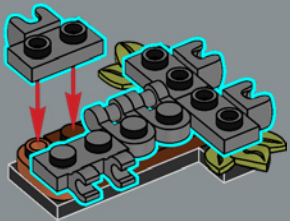

137

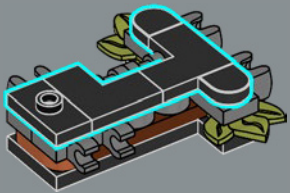

138

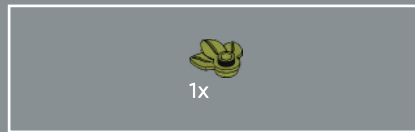
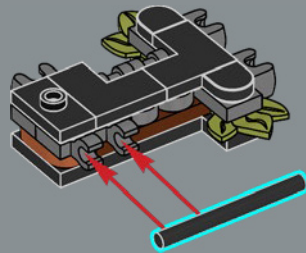

139

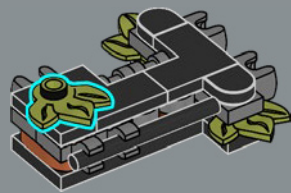

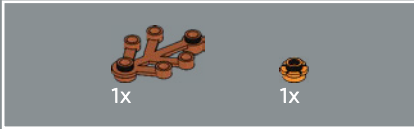

140

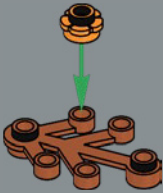

141

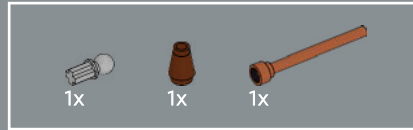

142

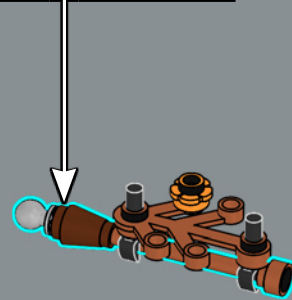
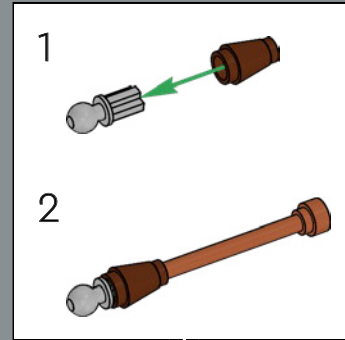

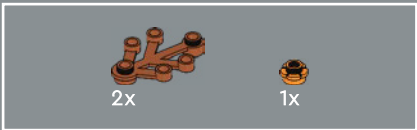

143

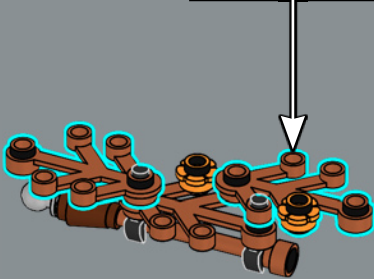
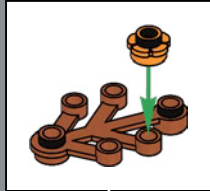

144

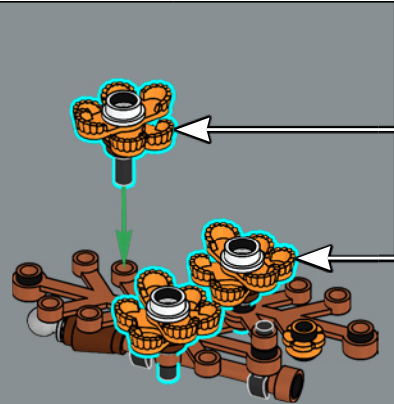
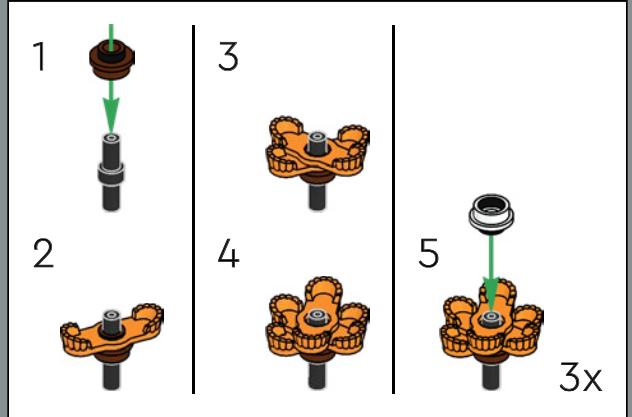



1x



1x



1x

145

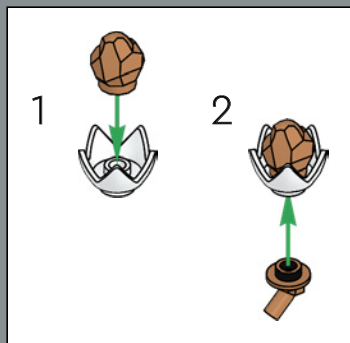

The dried daisy heads are constructed with a white crown element and a rare rock element first used as a gold nugget.

146

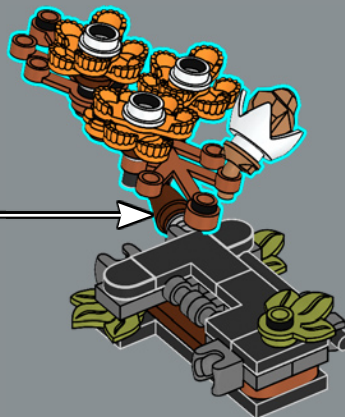

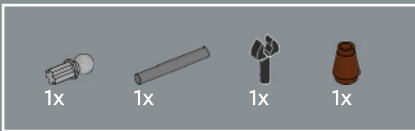

147

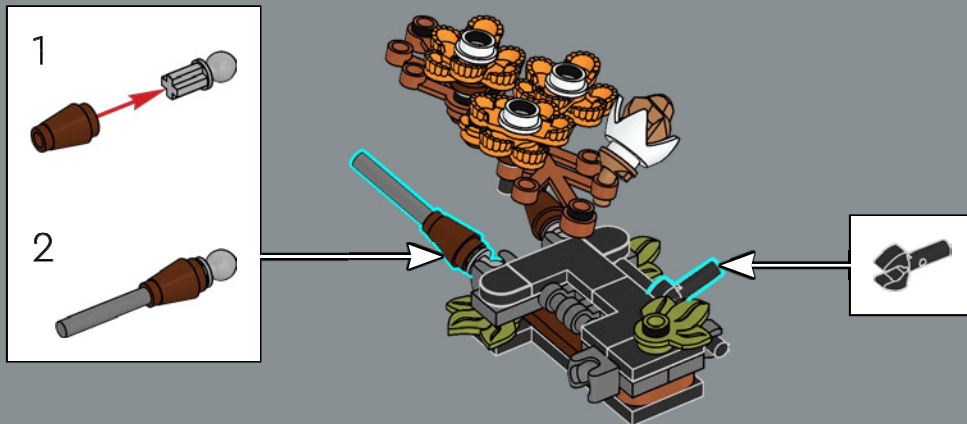



148

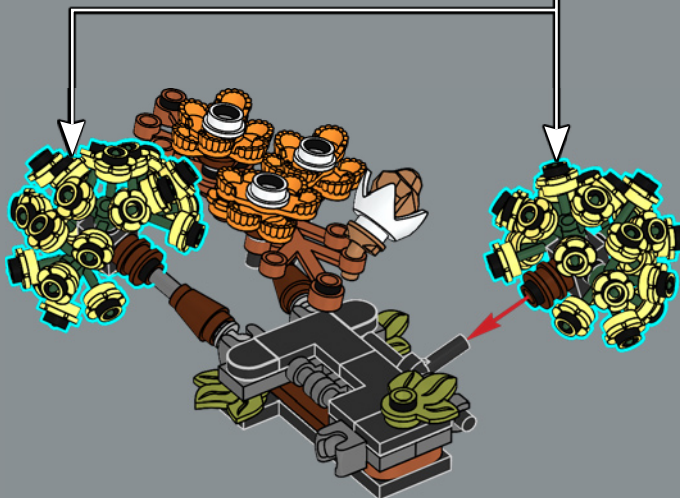
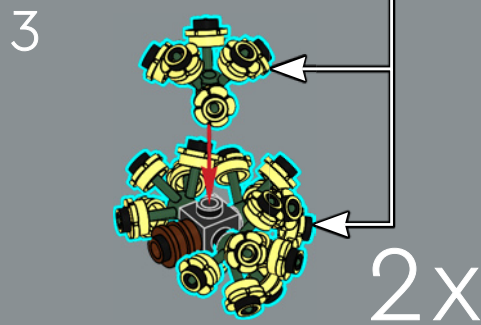
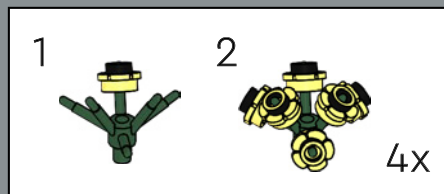
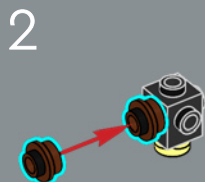
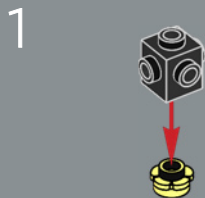



1x



2x

149

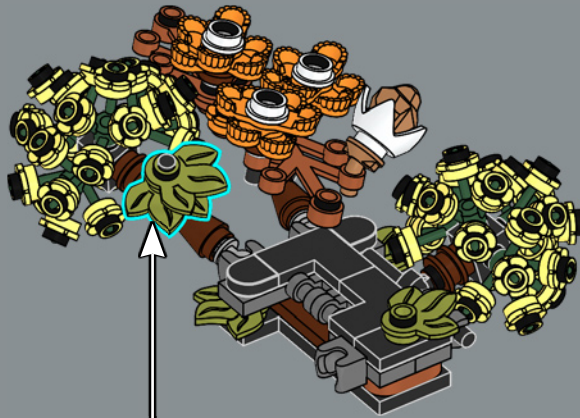

1

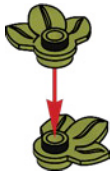

2





150

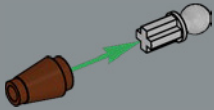

151

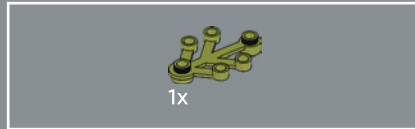
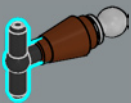

152

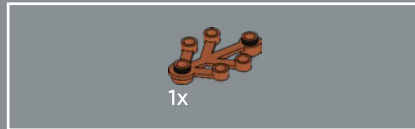
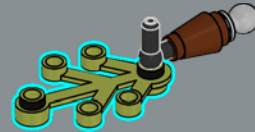

153





154

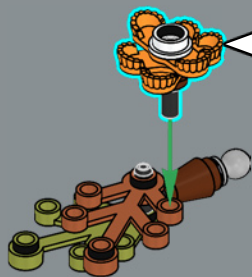
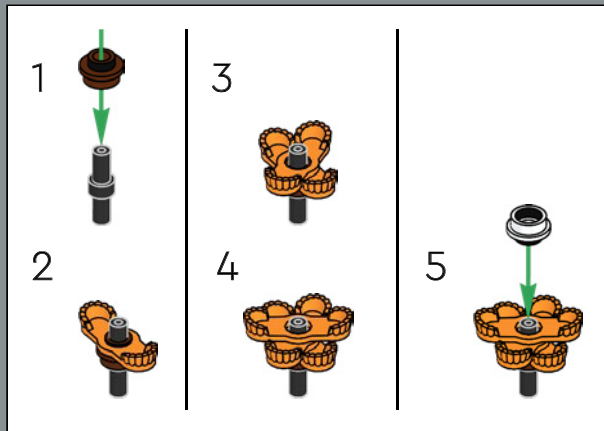

155

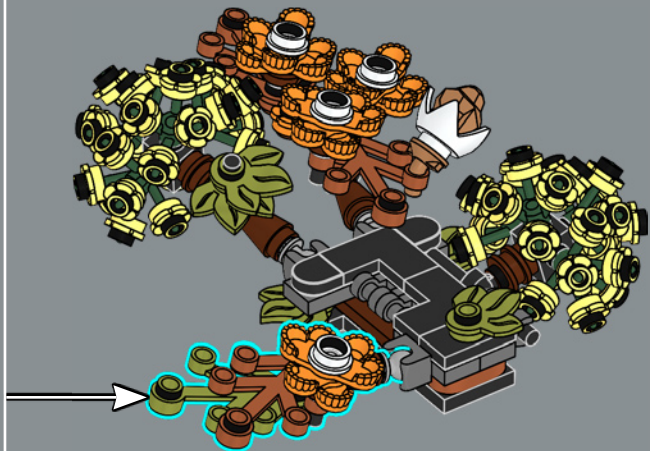

156

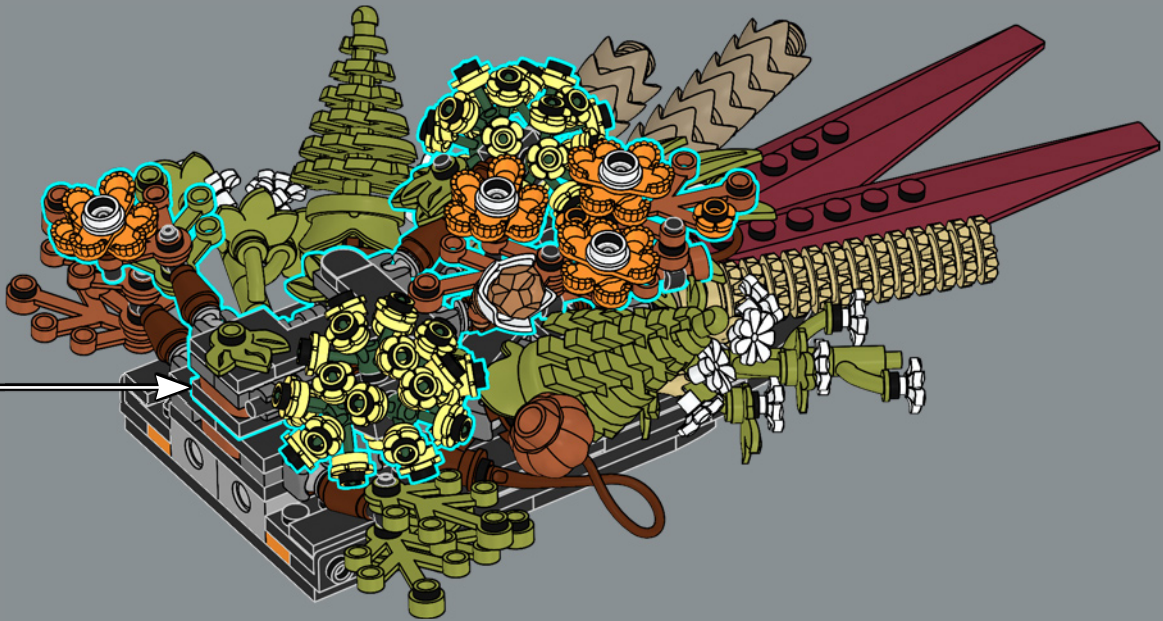

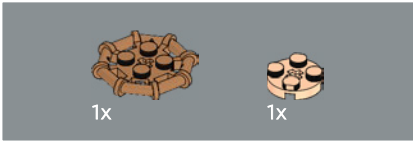
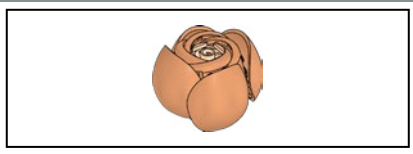

157

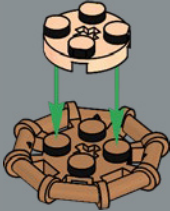

158



159

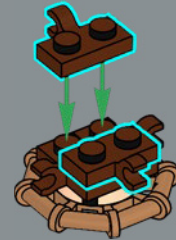



160

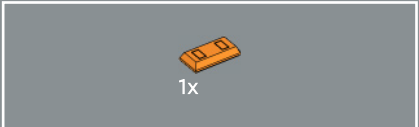

161

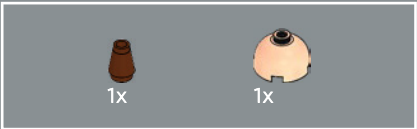

162

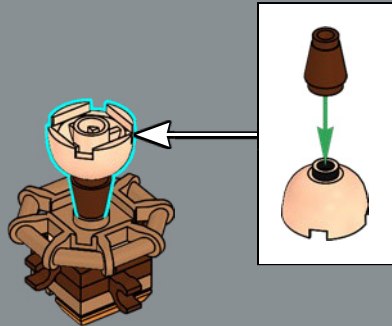

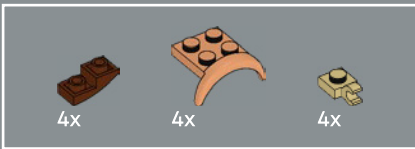

163

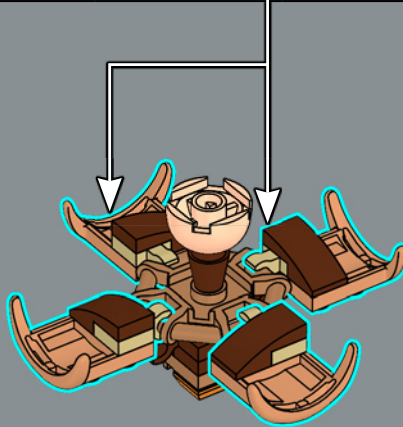
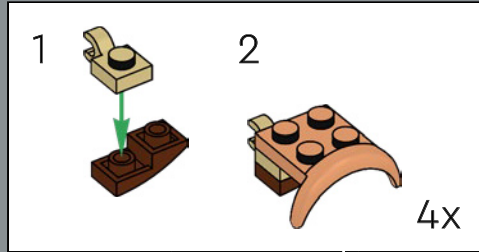

164

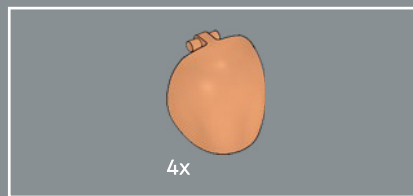
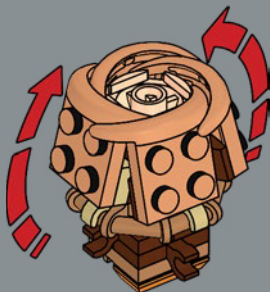

165

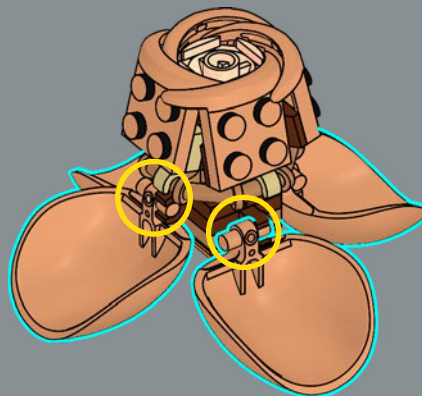

166

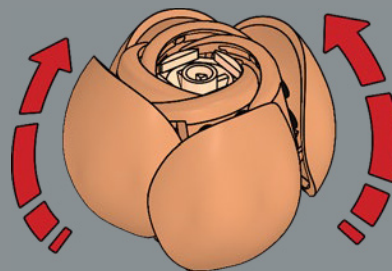



The intricate rose construction uses new mud guard elements for the inner petals and a new shell element for the outer petals.

167

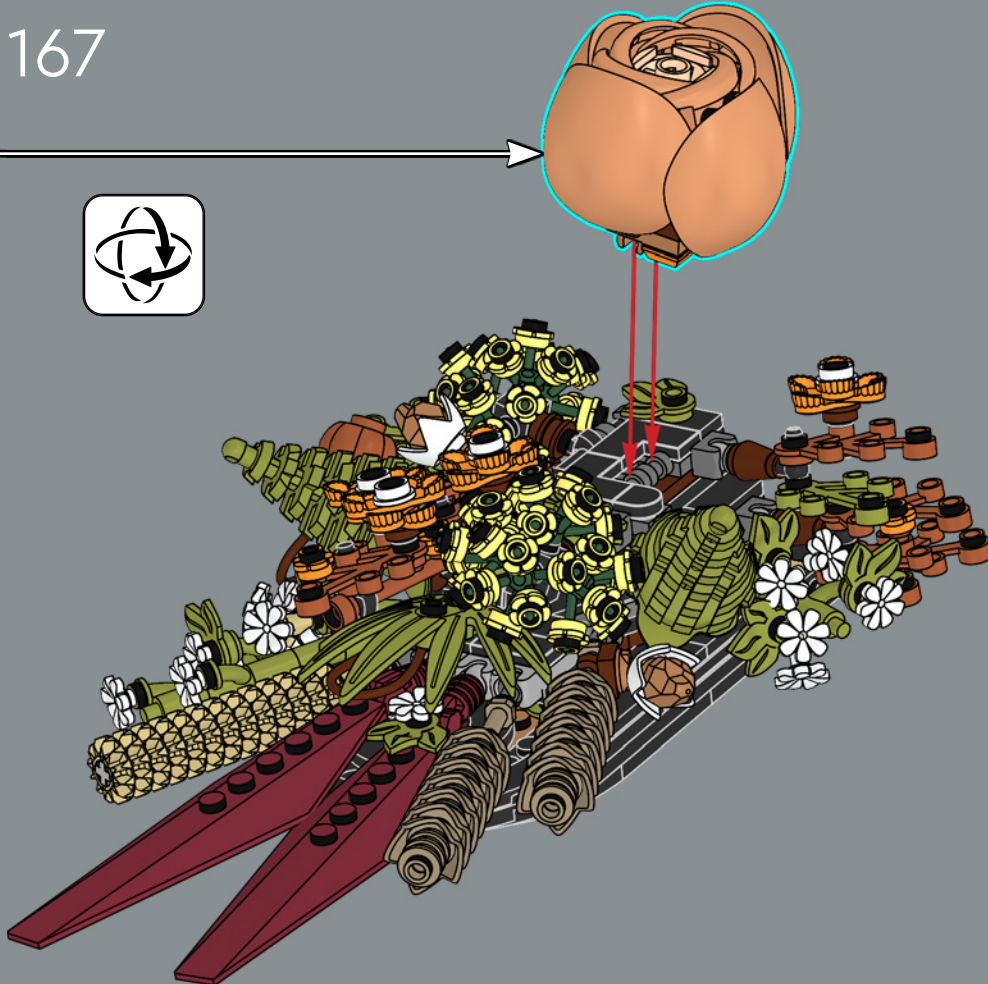



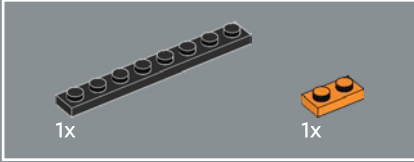
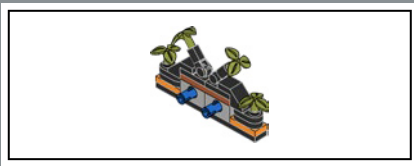

168

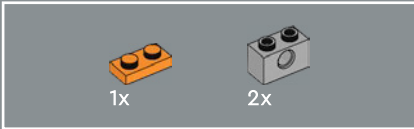
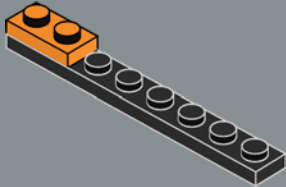

169

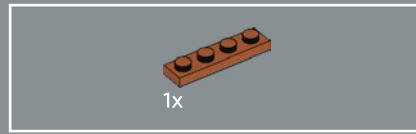
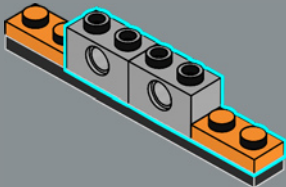

170

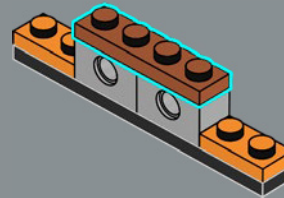

171

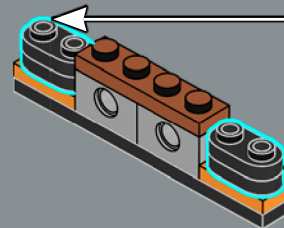
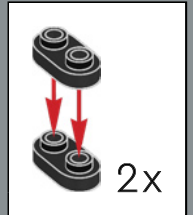



172

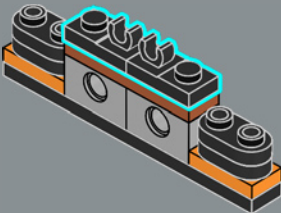

173

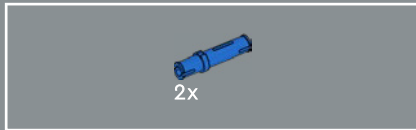
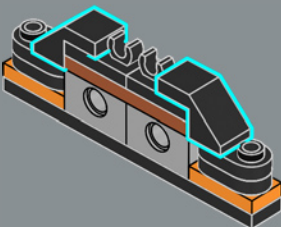

174

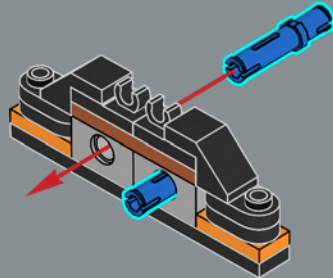



175

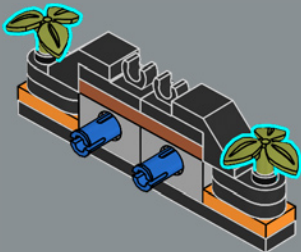

176

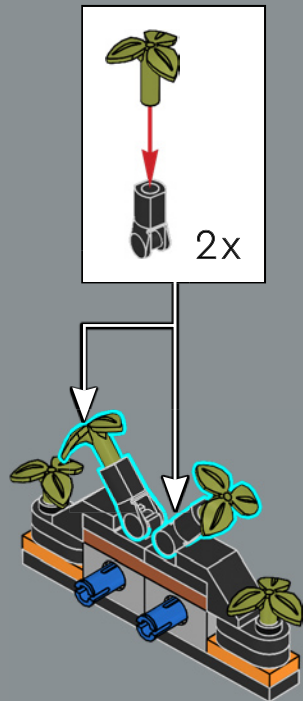

177

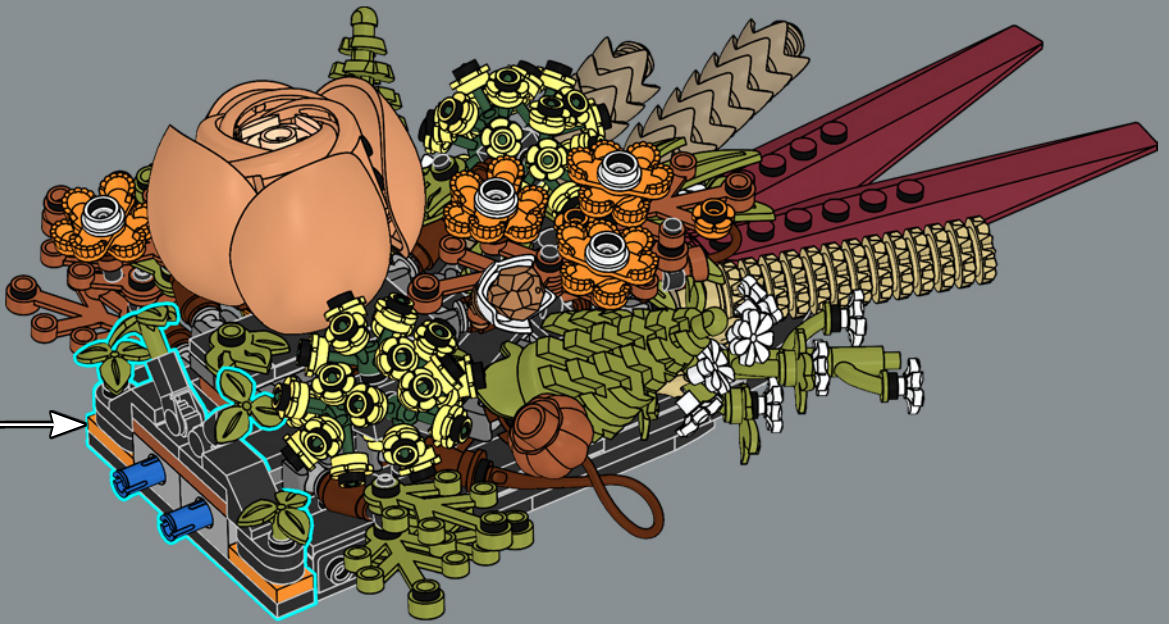



Dried flowers are sometimes preserved using a thin wax. The shiny elements in this set were chosen to replicate that wax look.

178

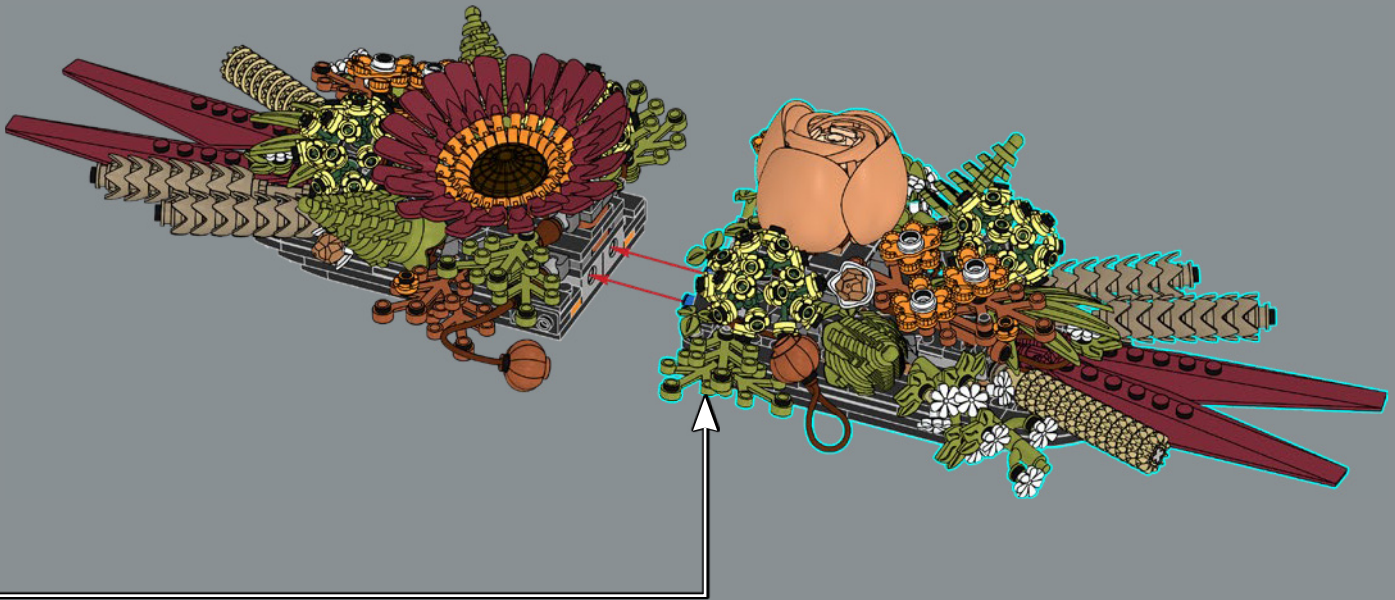

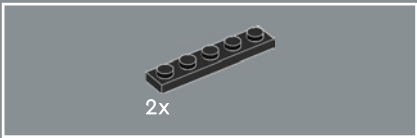

179

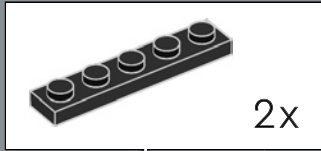

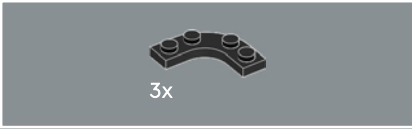
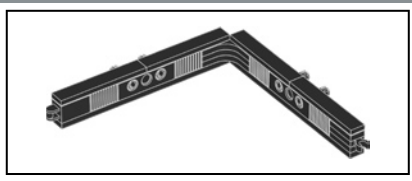

180

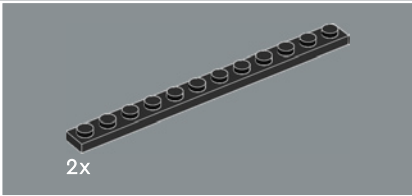
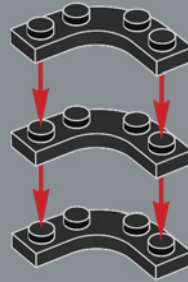

181

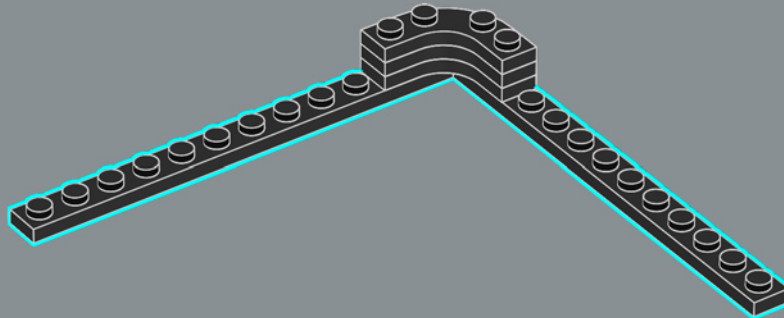

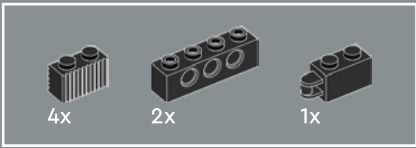

182

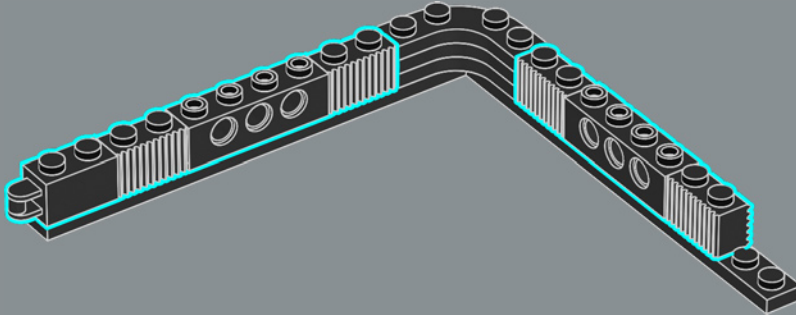

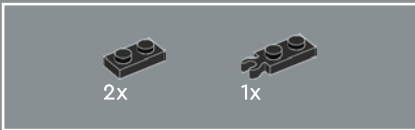

183

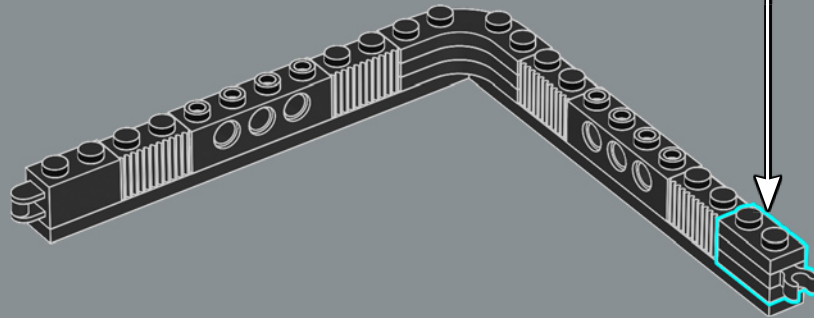
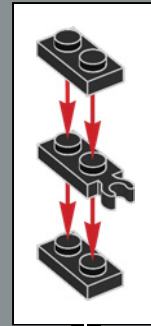

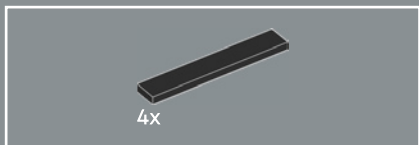

184

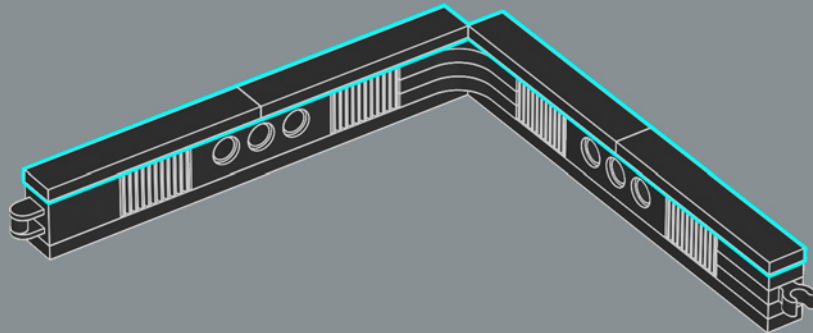

185

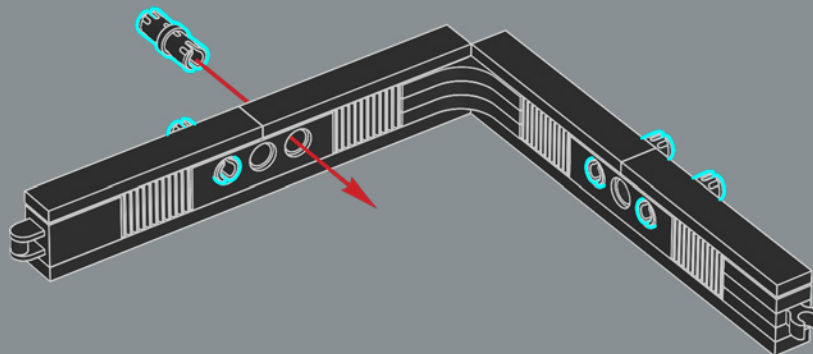

186

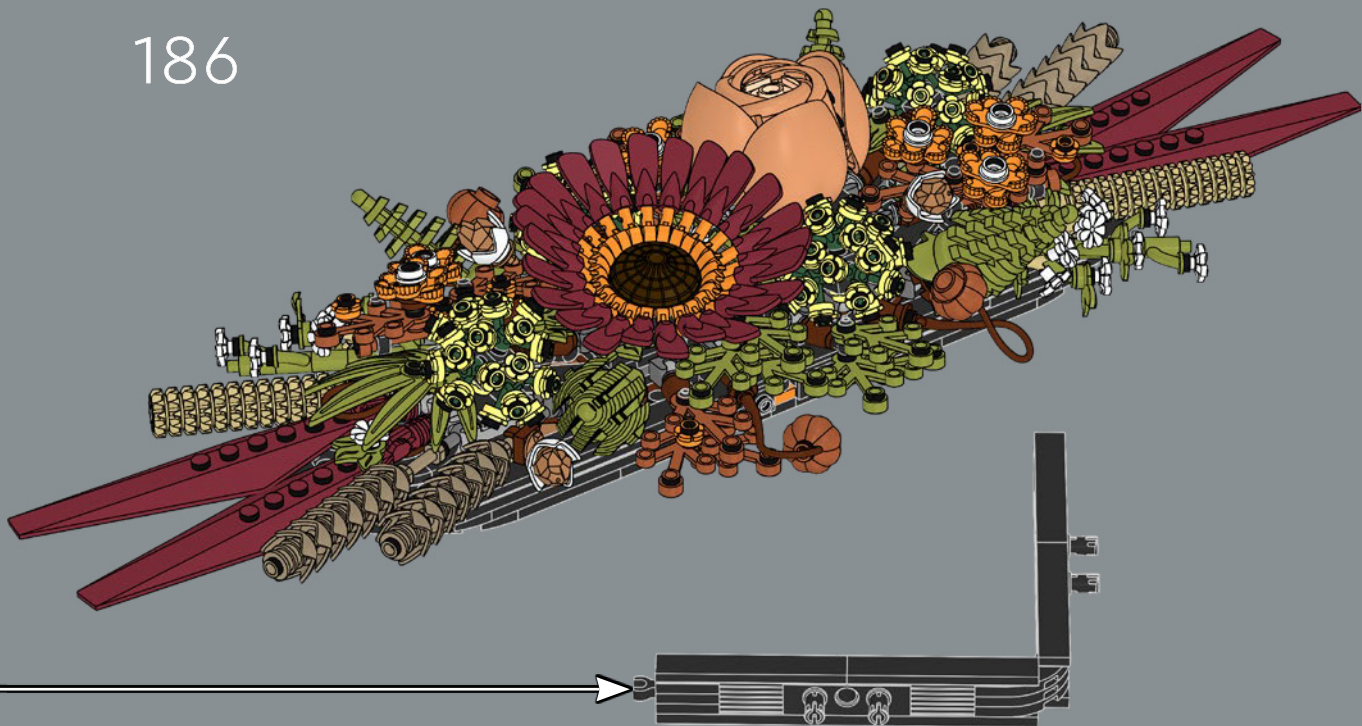





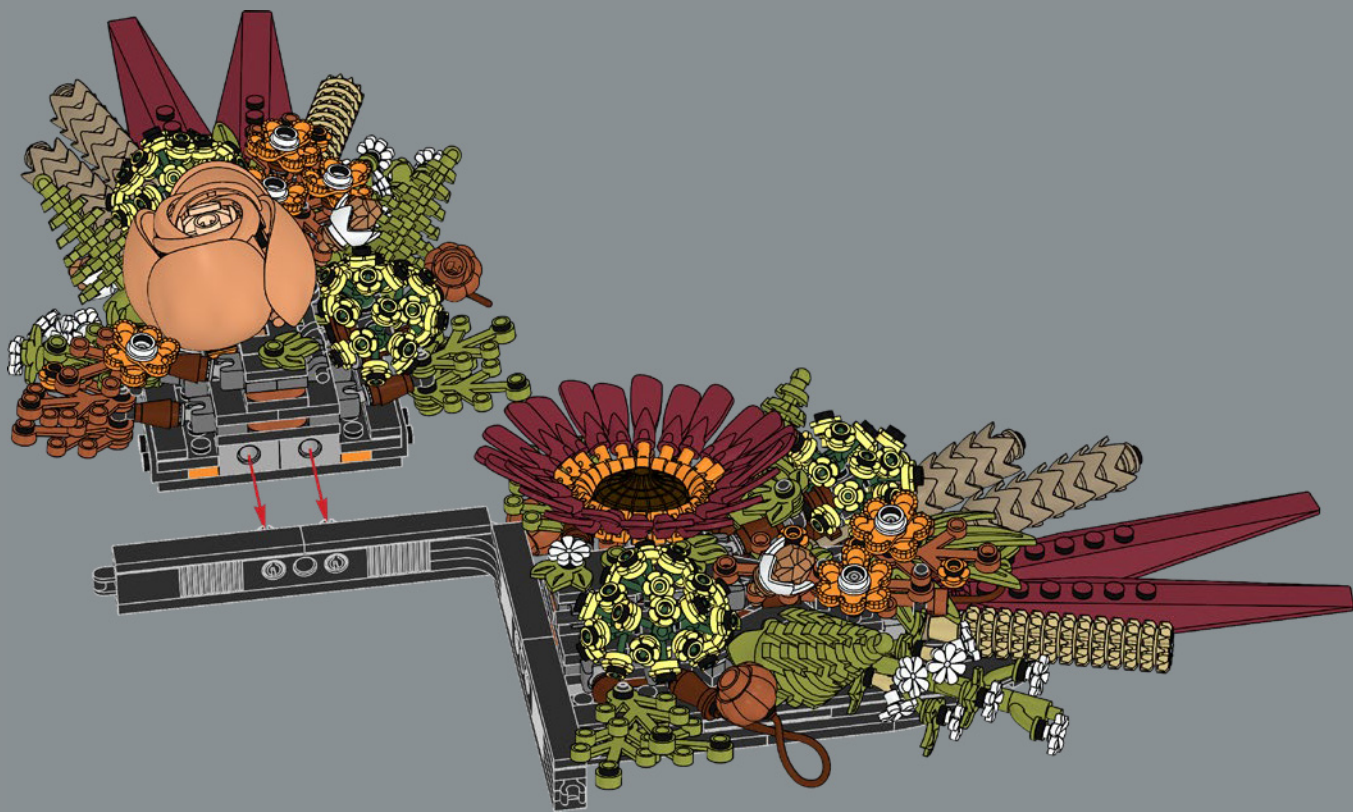



3 x 10314

