

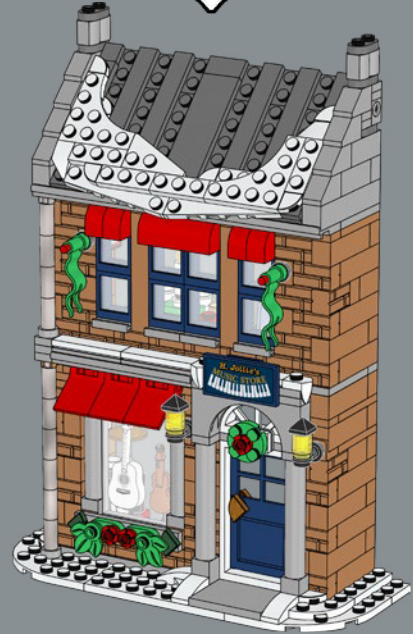



BUILD TOGETHER

★ There's no better way to get into the holiday spirit than by sitting down with friends and family and building a LEGO® model together. This Holiday Main Street set is the latest addition to our Winter Village Collection and is made up of individual models with their own separate Building Instructions that allow up to four people to enjoy this festive LEGO building experience.



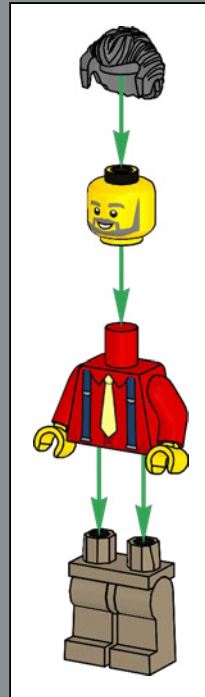

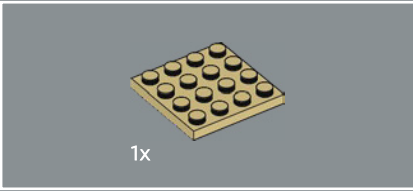
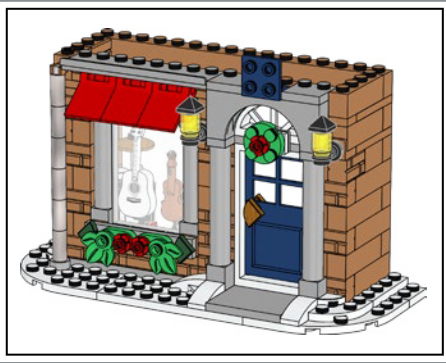

1

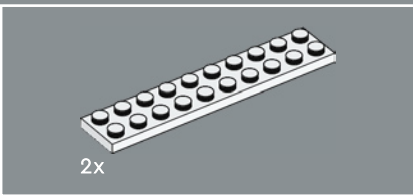
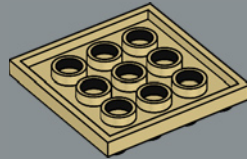

2

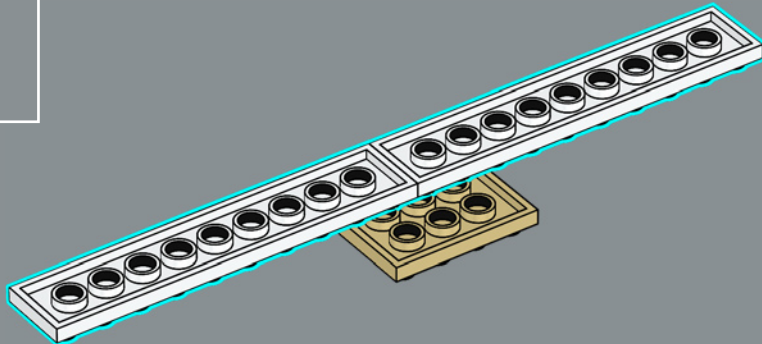

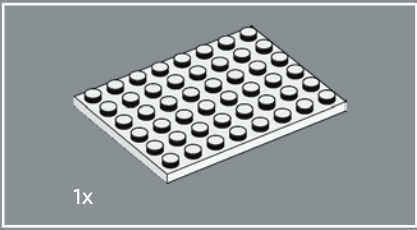

3

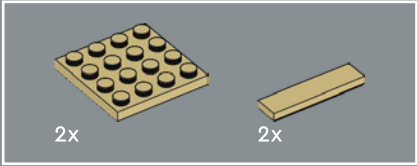
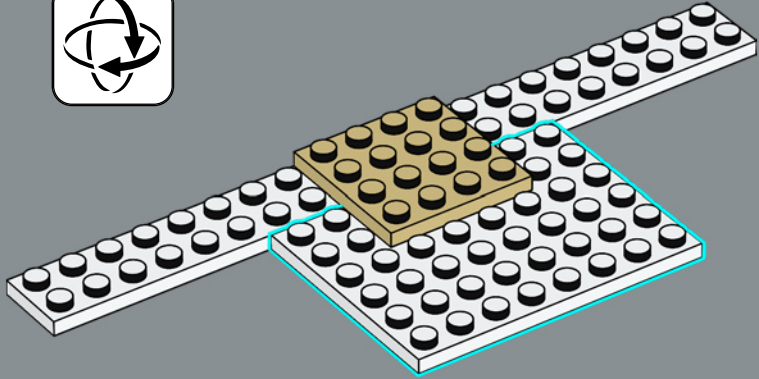

4

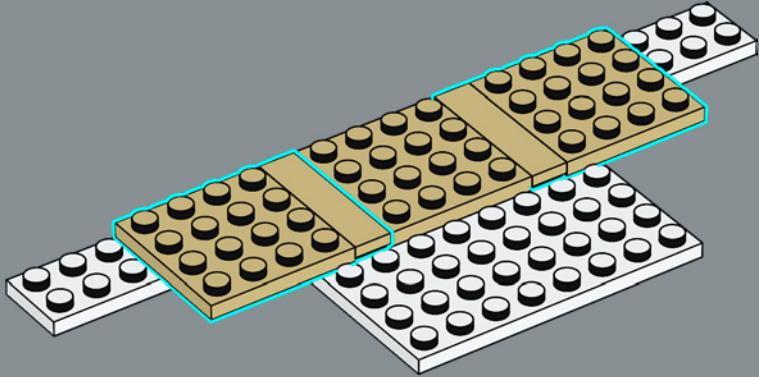

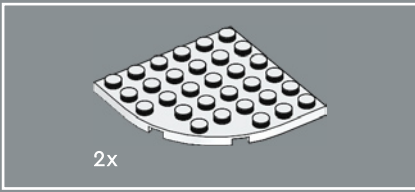

5

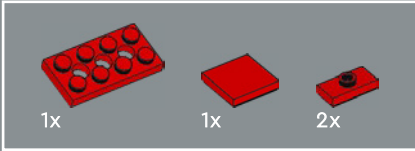
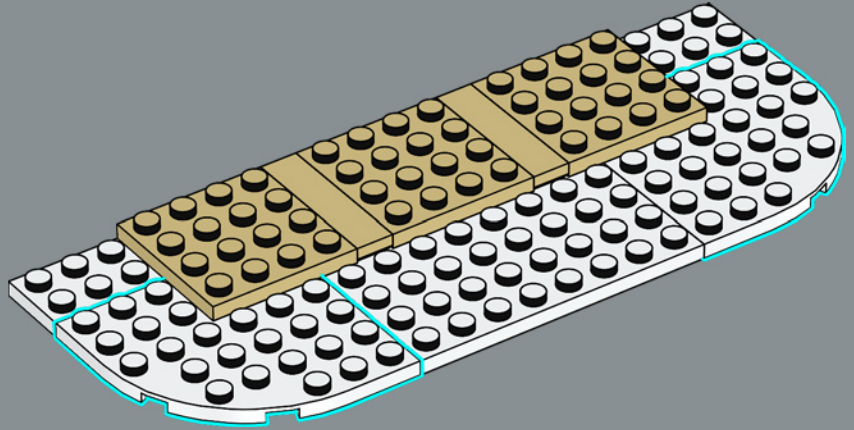

6

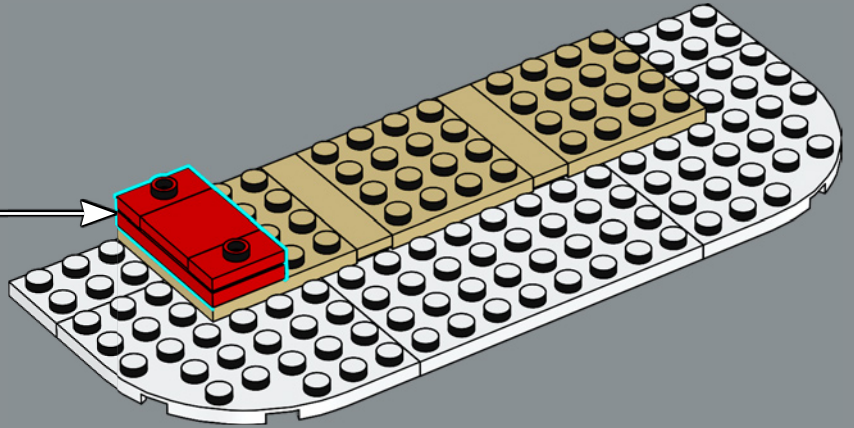
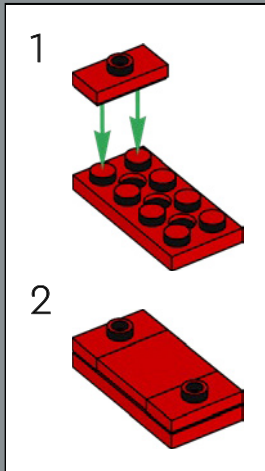

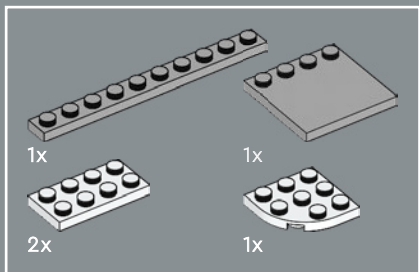

7

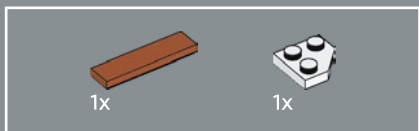
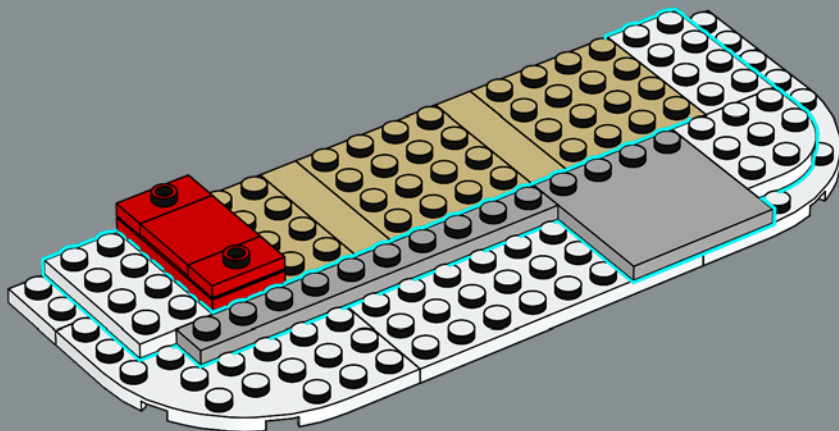

8

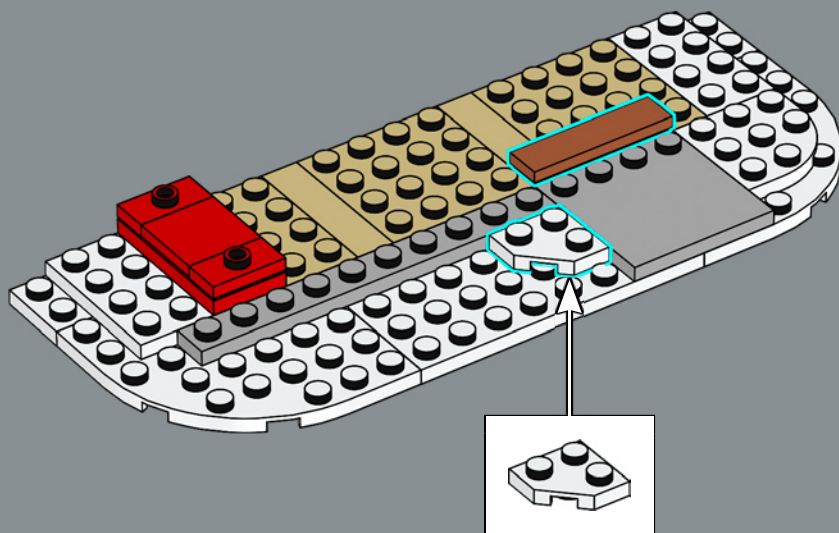



9

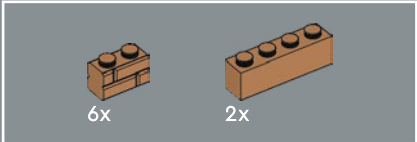
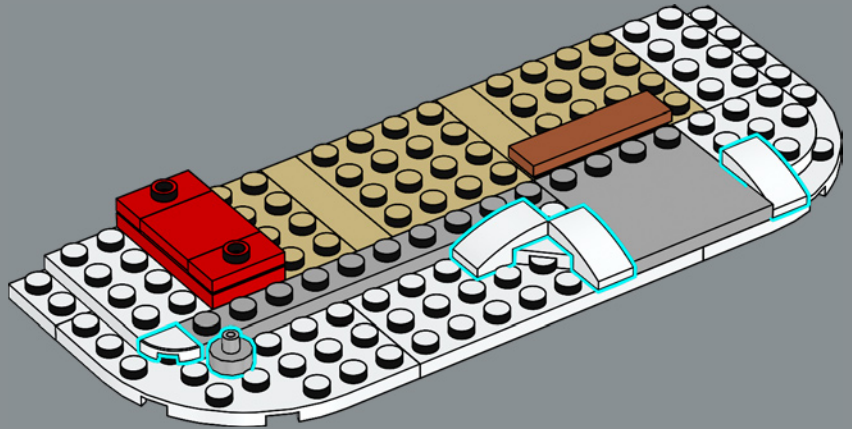

10

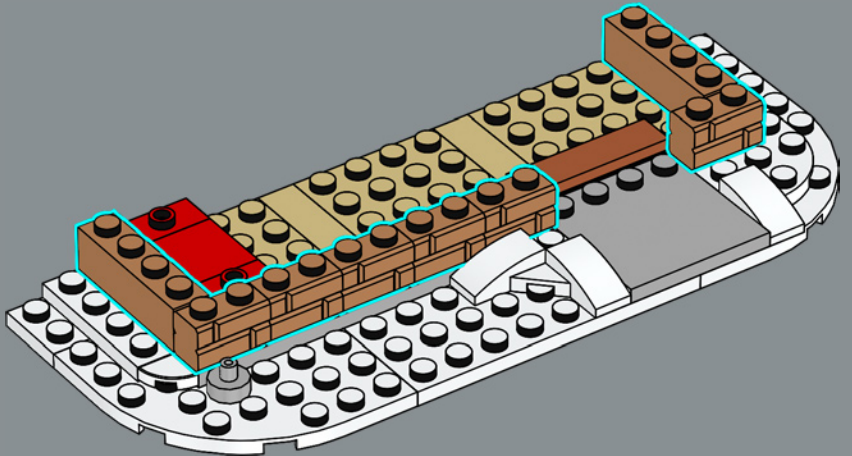

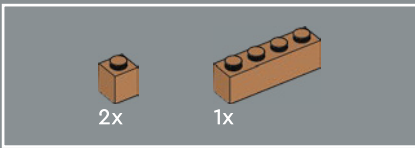

13

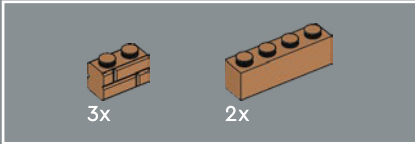
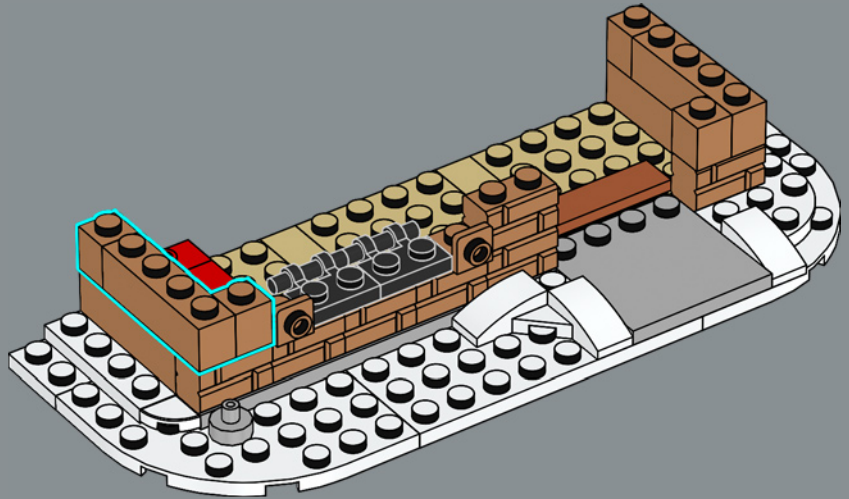

14

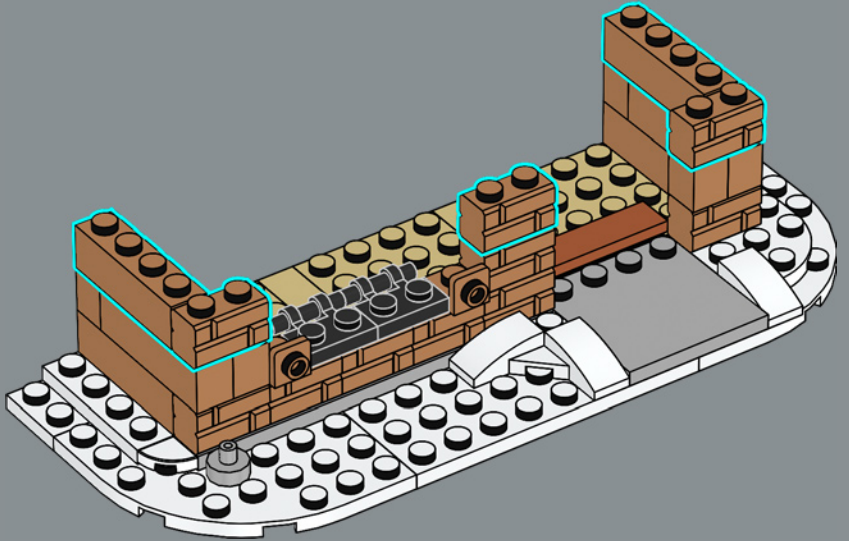

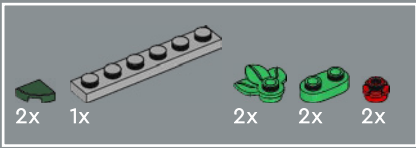

15

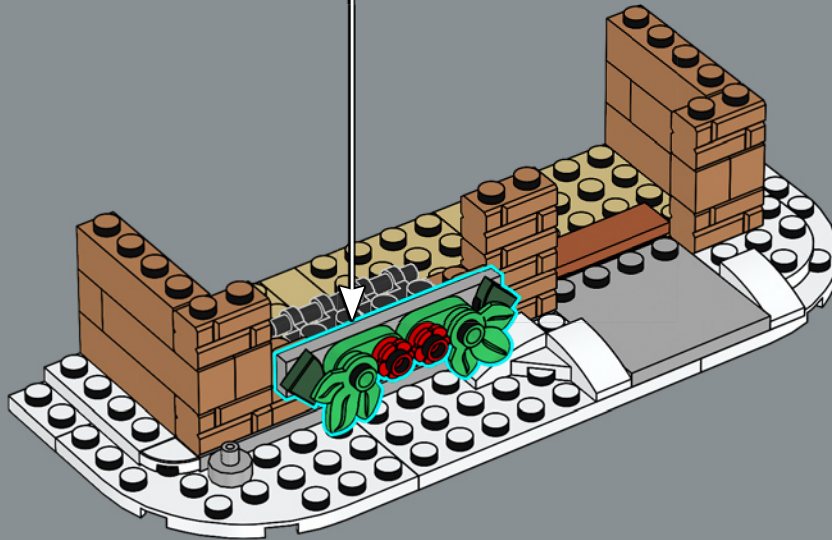
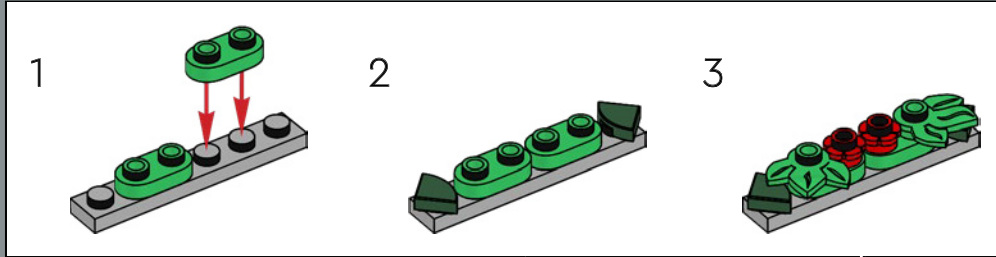

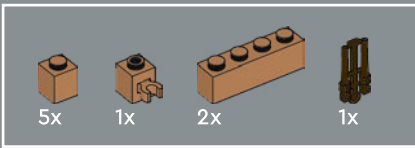

16

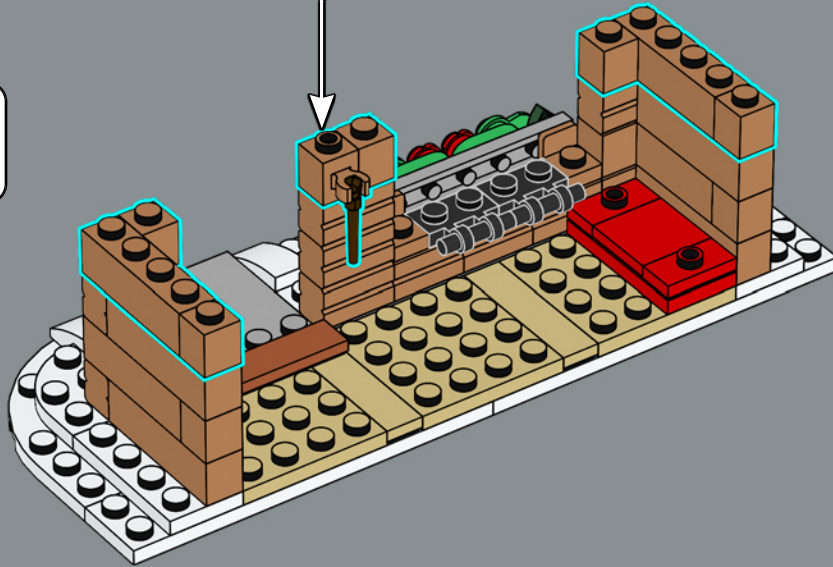
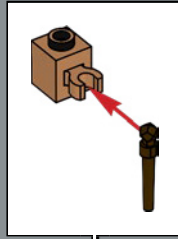

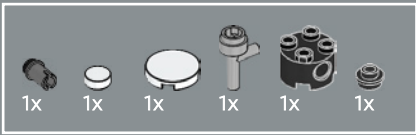

17

1

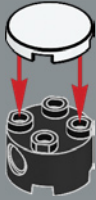

2

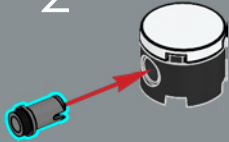

3

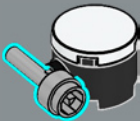

4

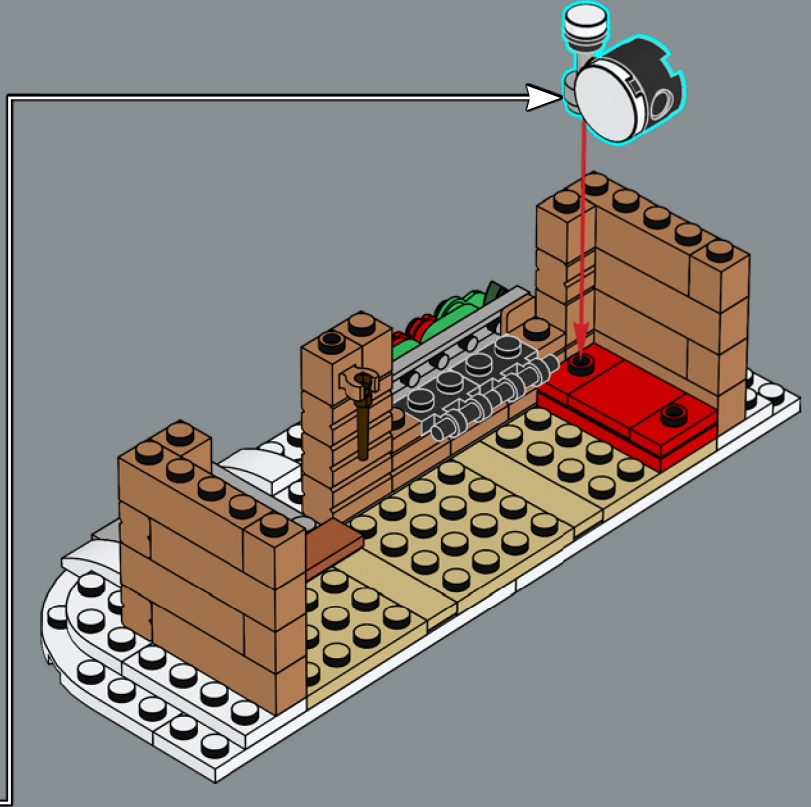
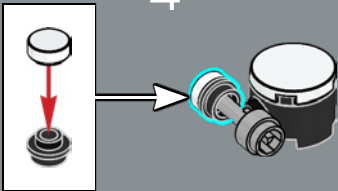



18

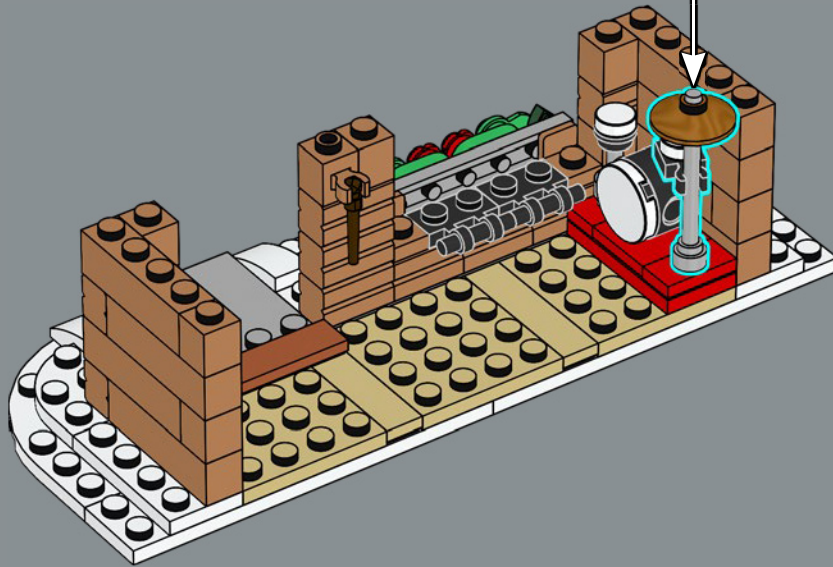
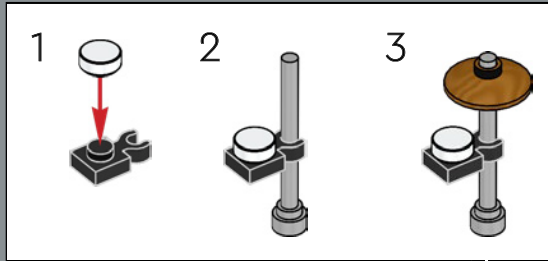

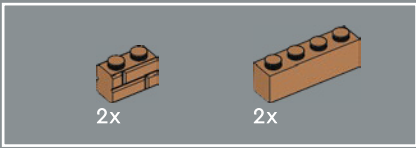

19

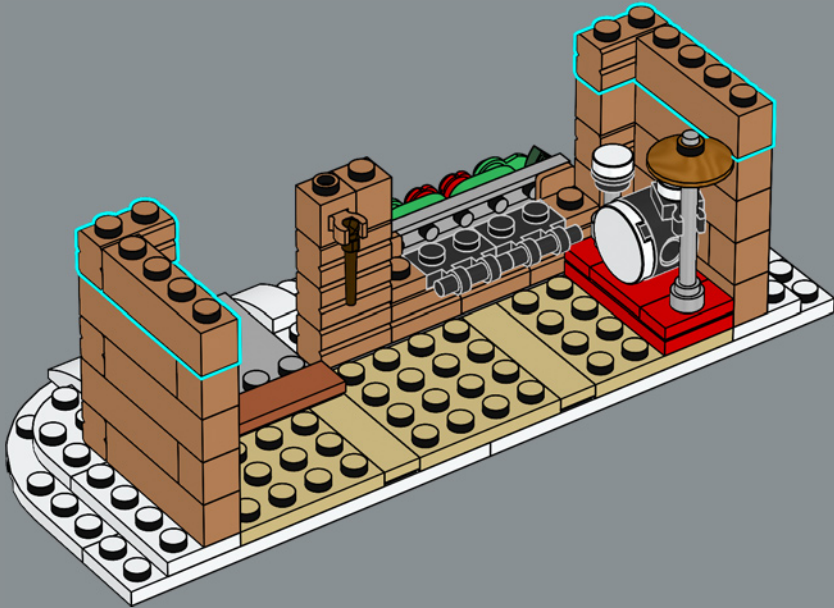

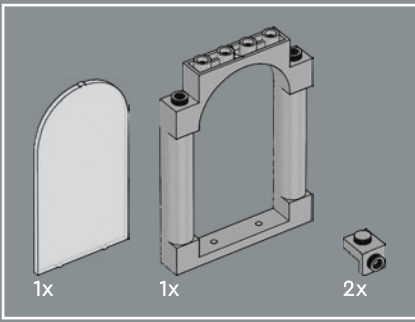

20

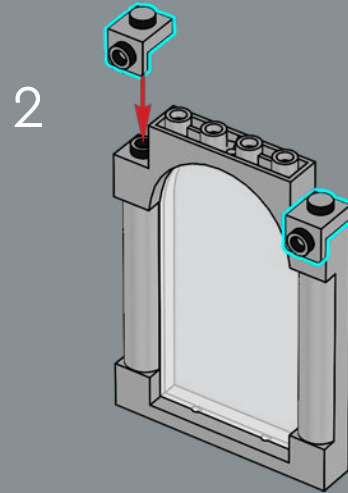
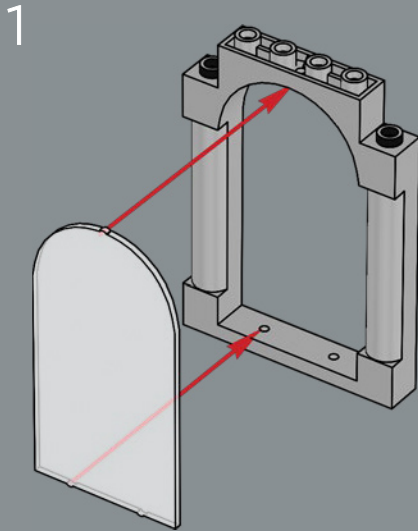

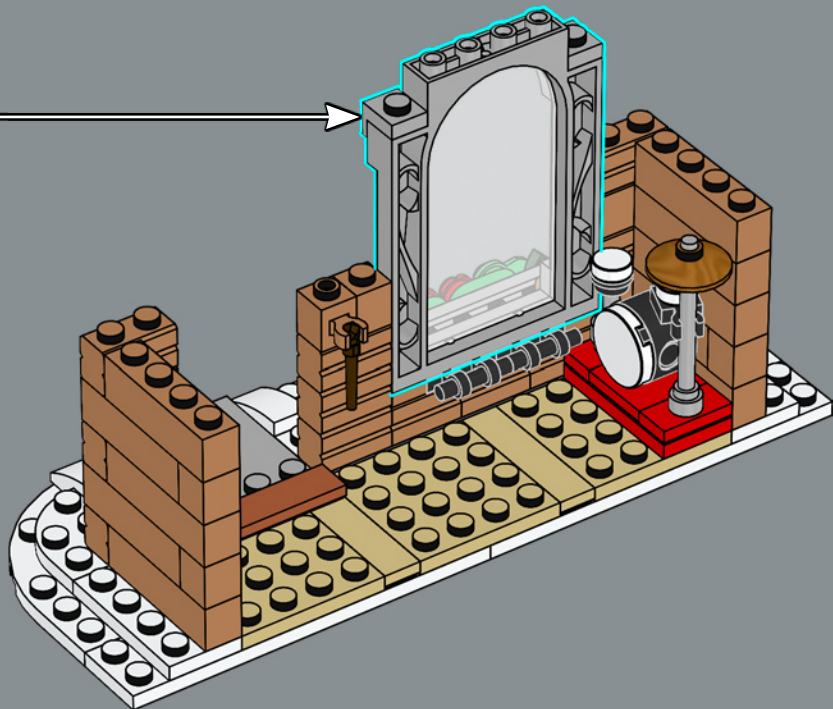

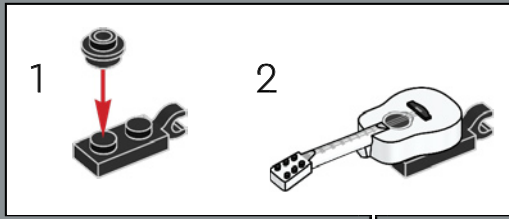
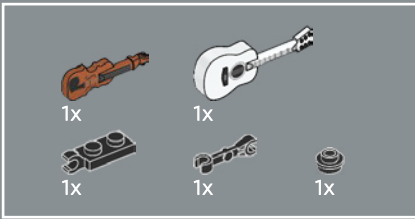

21

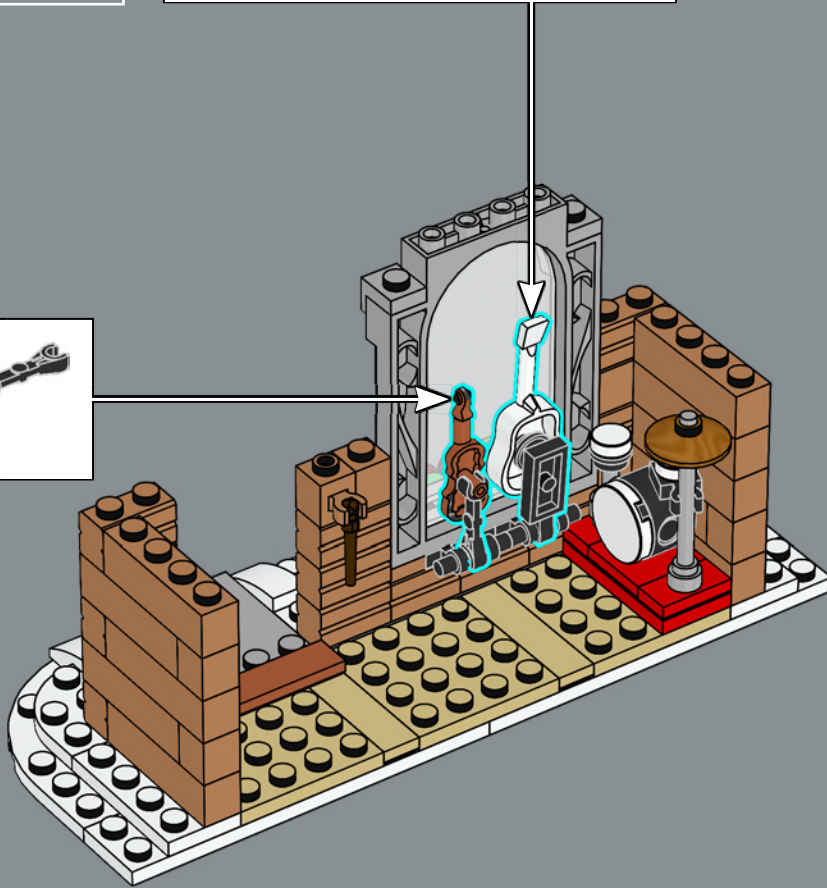
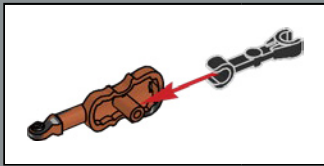

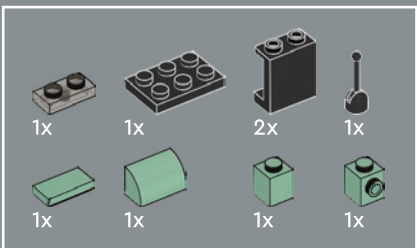

22

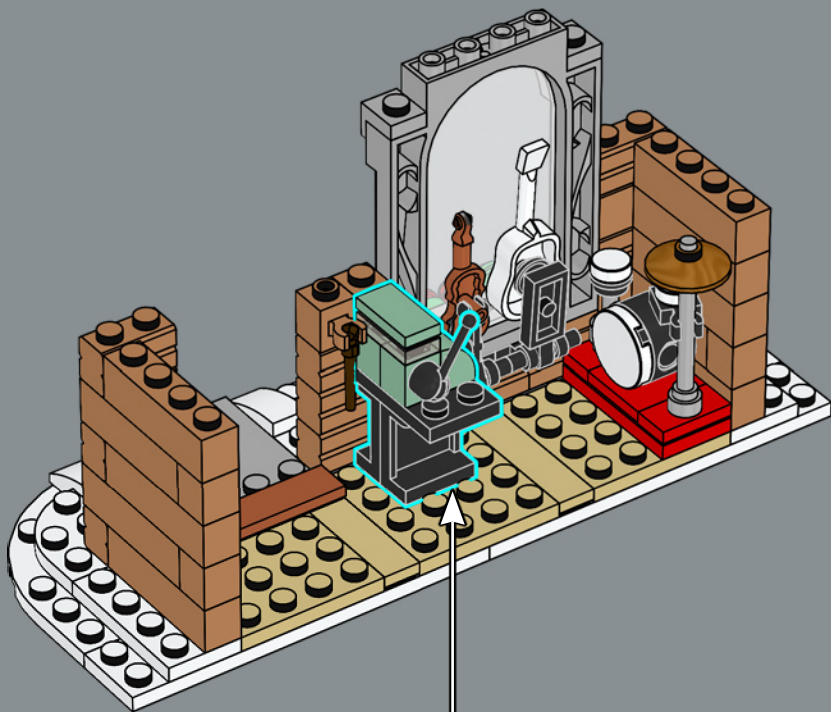
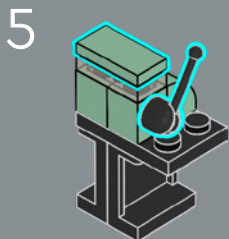
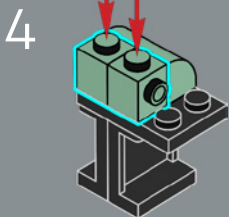
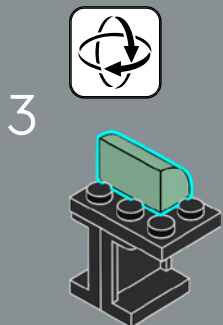
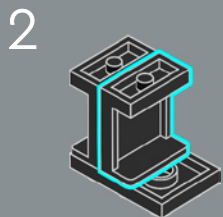
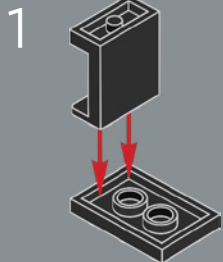

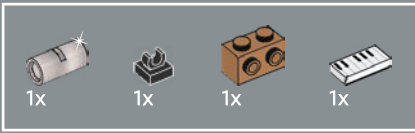

23

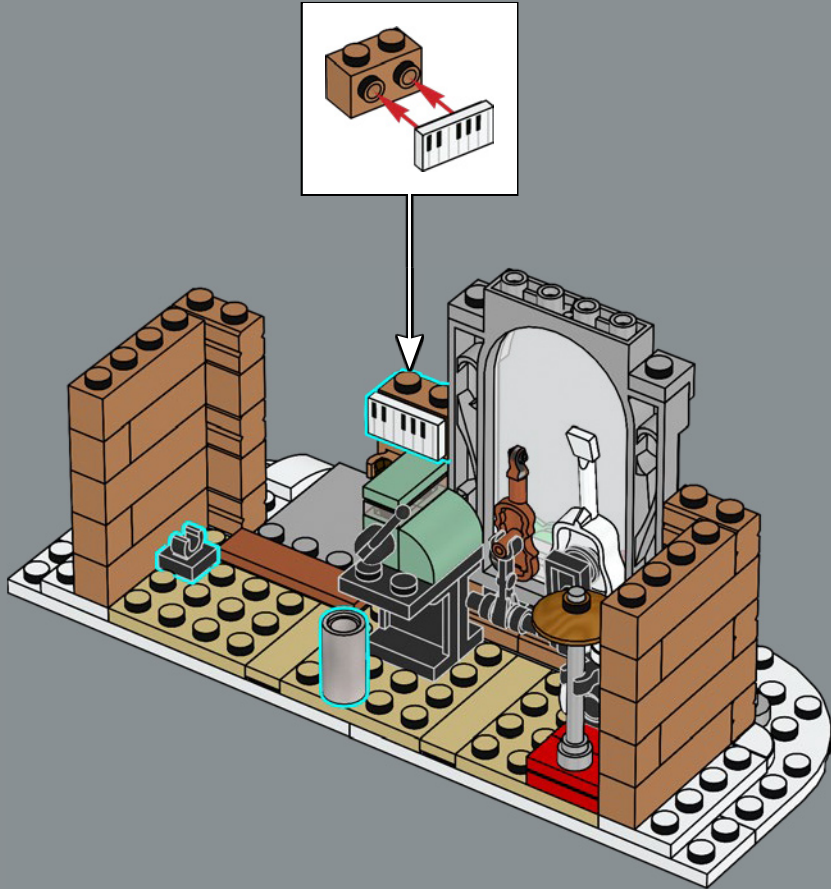



24

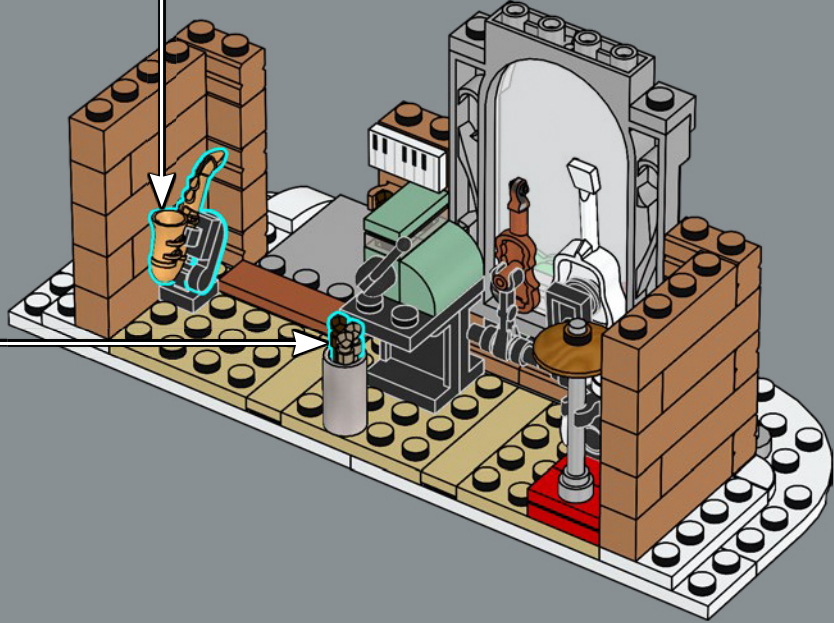
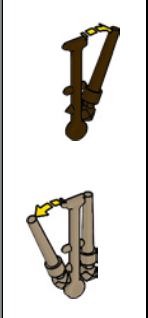
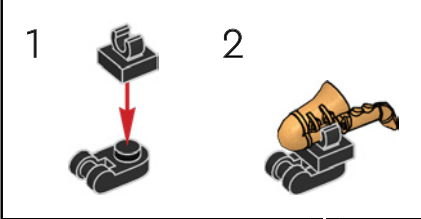



3x



2x

25

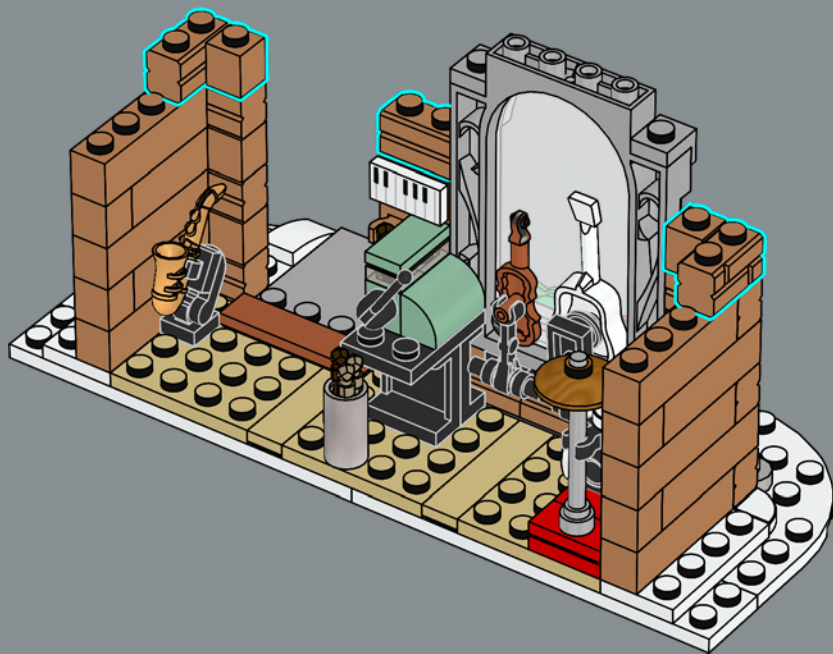

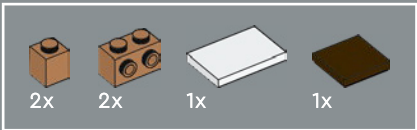

26

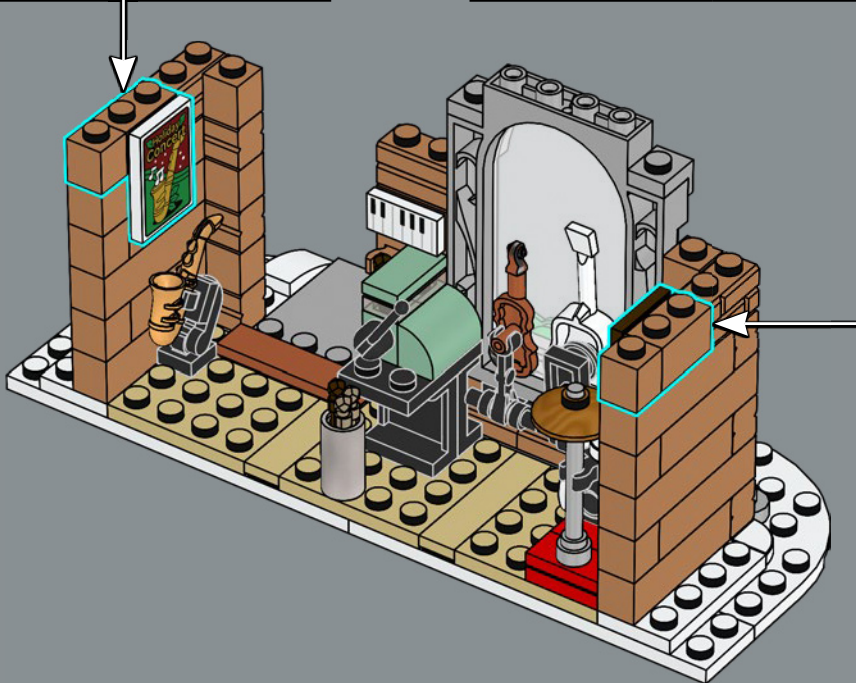
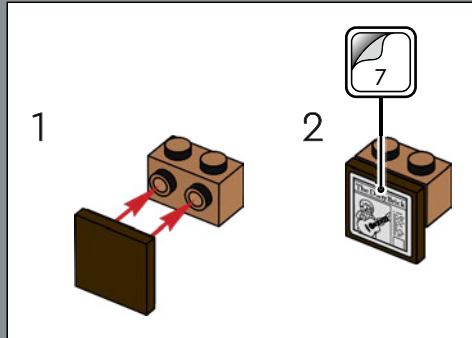
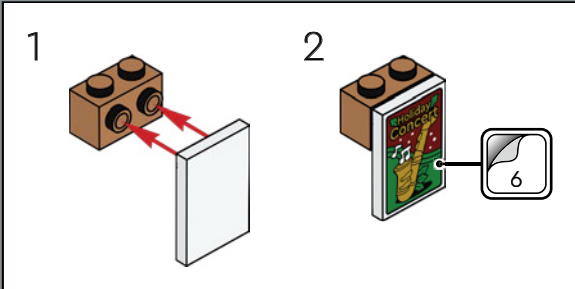

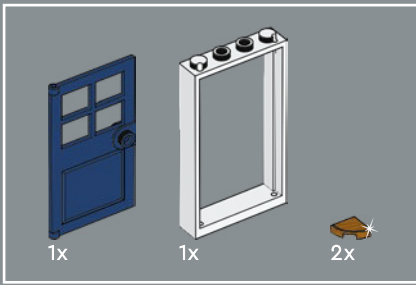

27

1



2



3

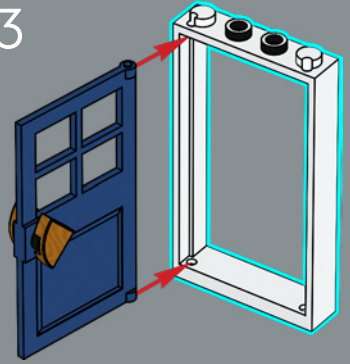

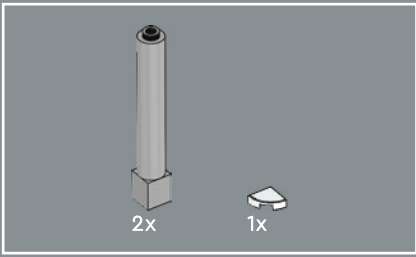

28

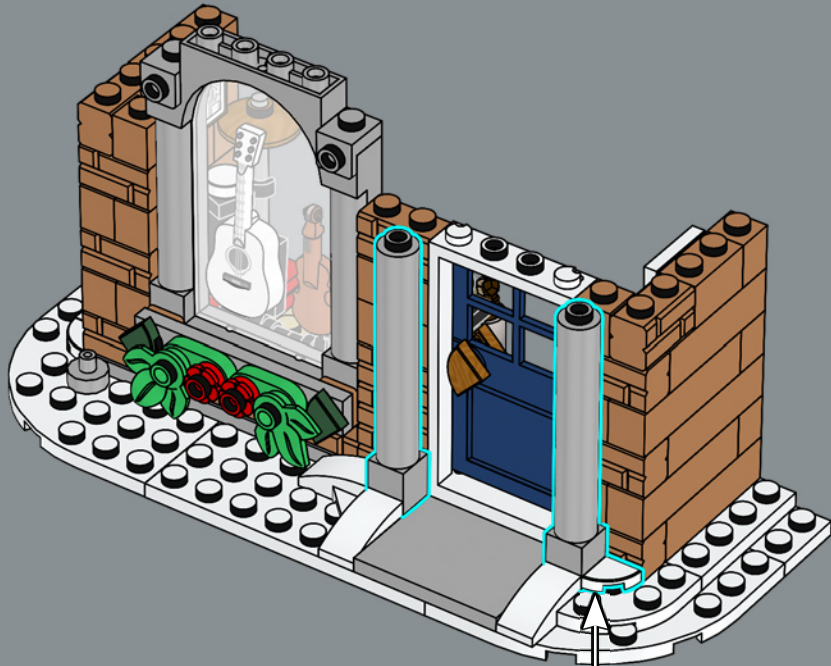



2x



1x

29



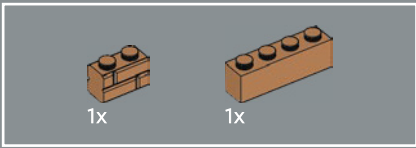

30



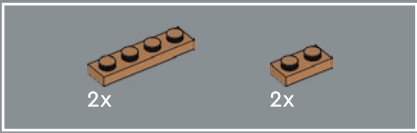

31

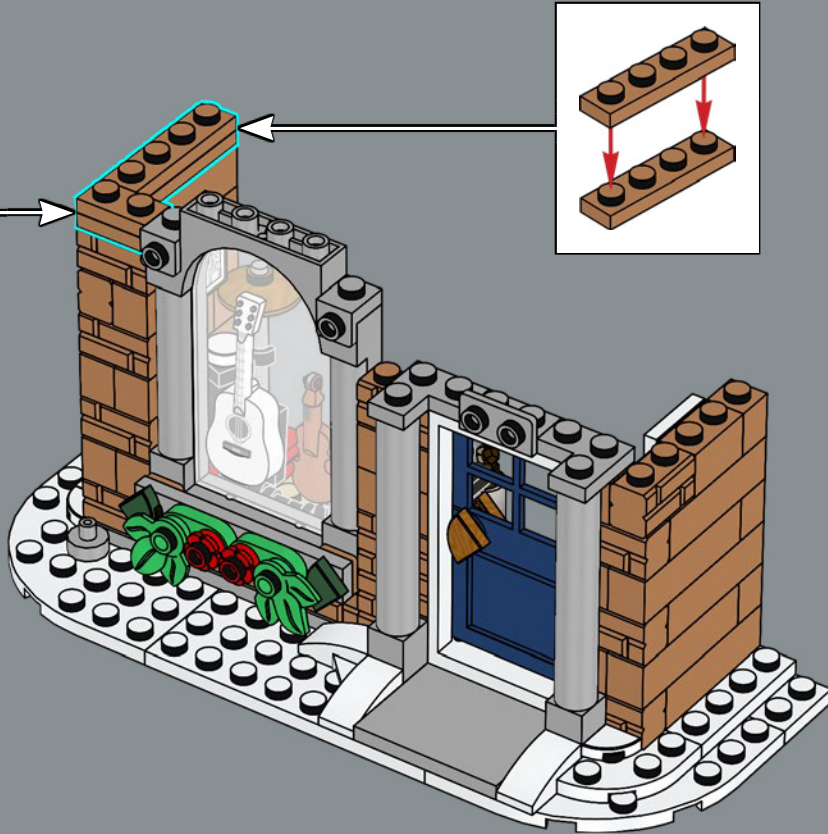
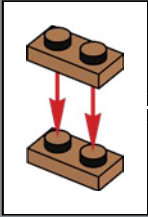

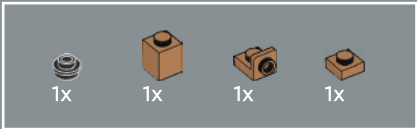

32

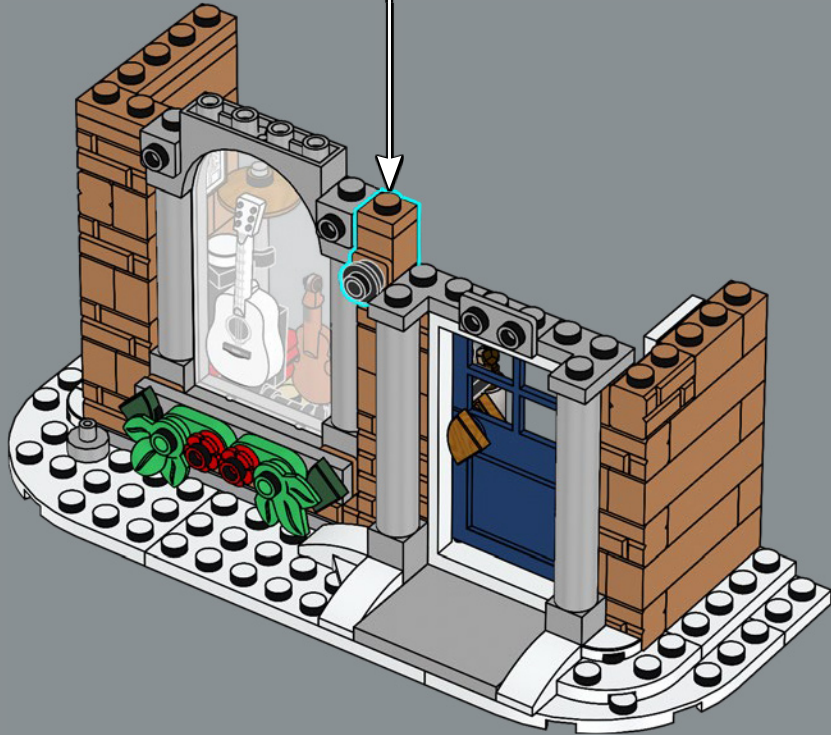
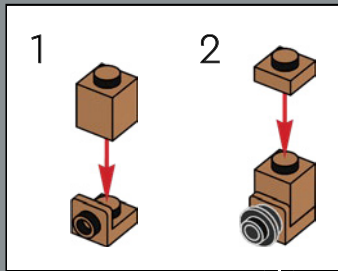

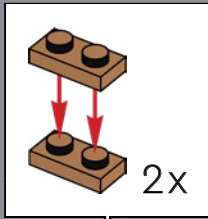
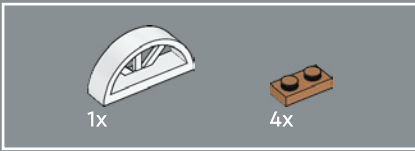

33

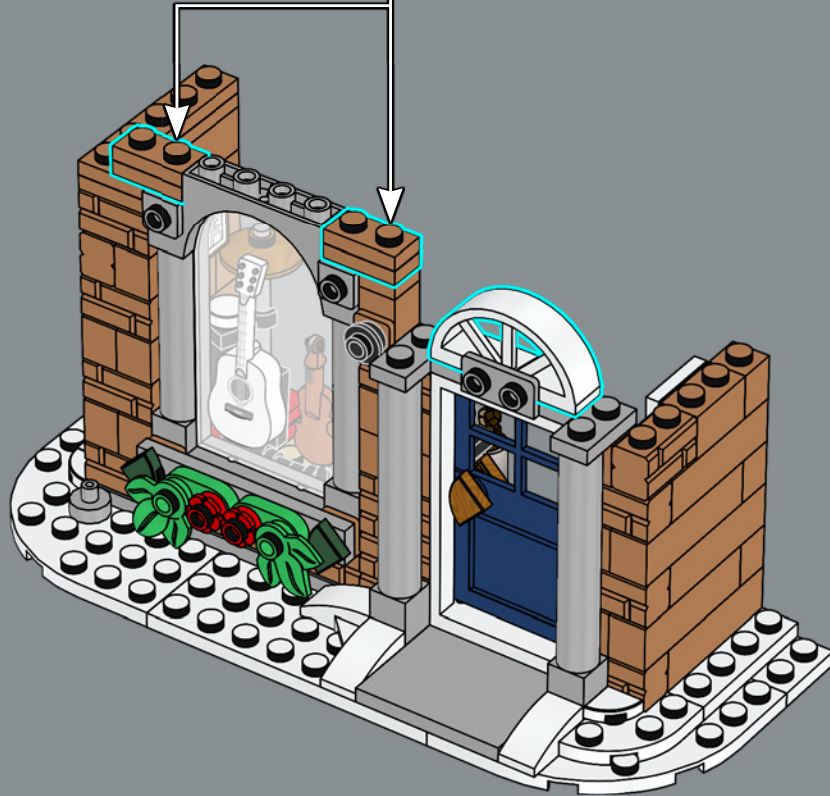

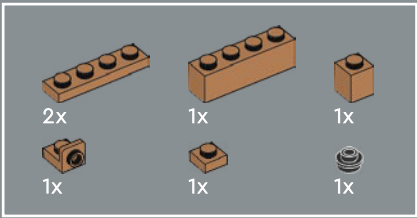

34

1

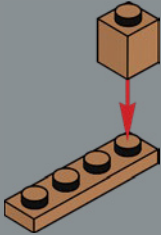

2

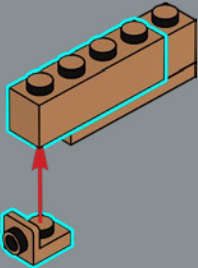

3

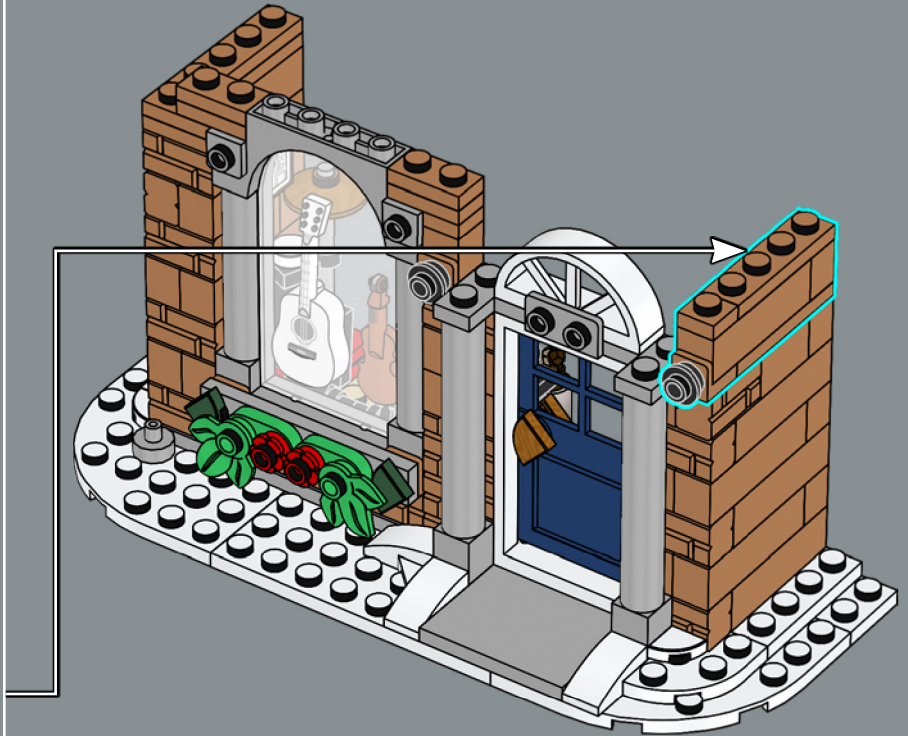
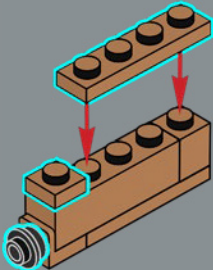

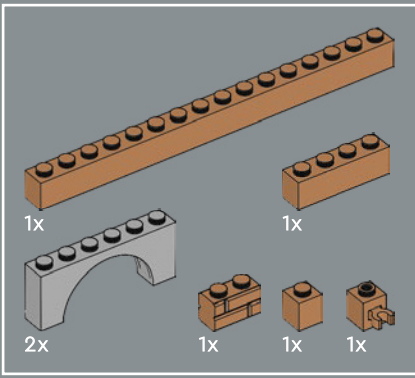

35

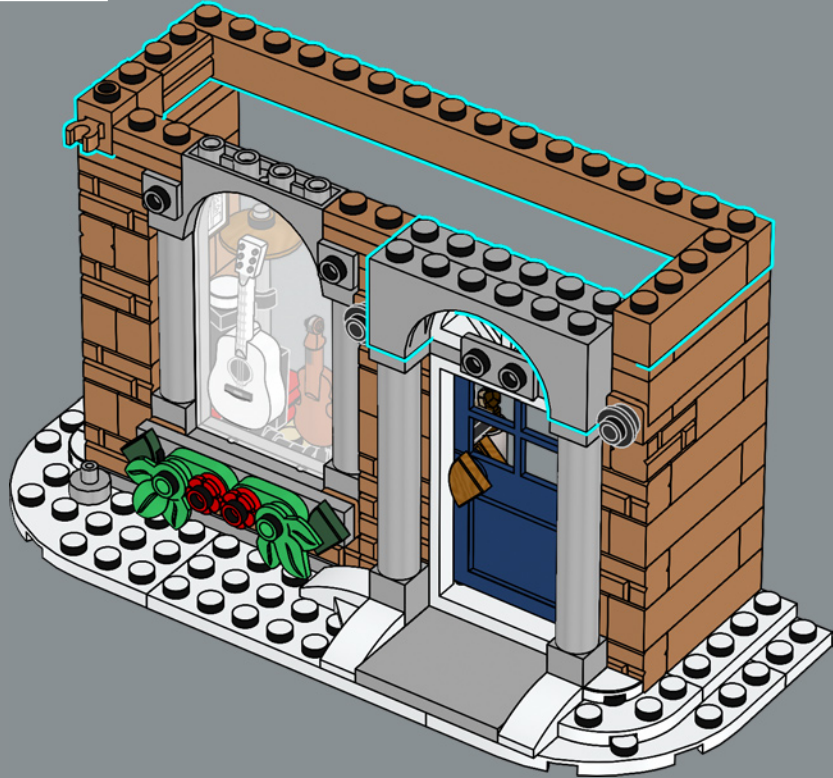

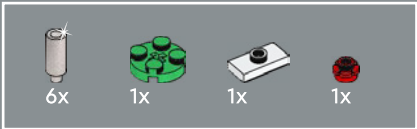

36

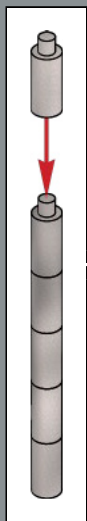
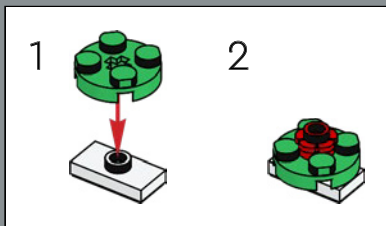

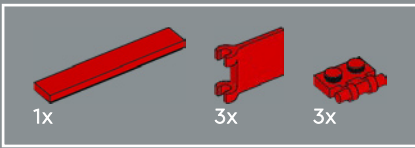

37

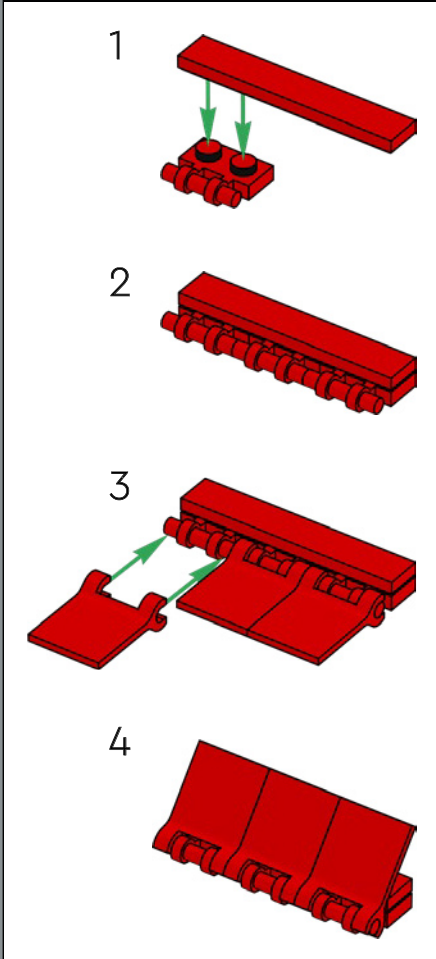

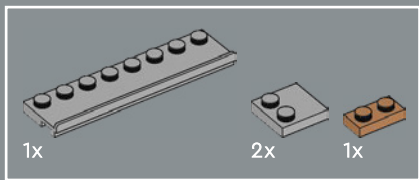

38

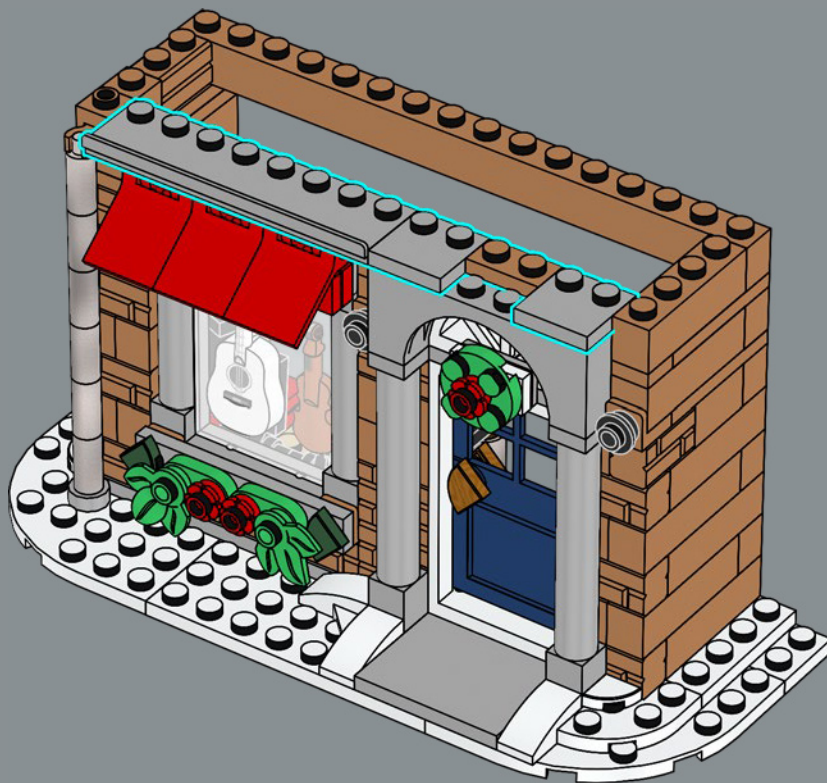



39

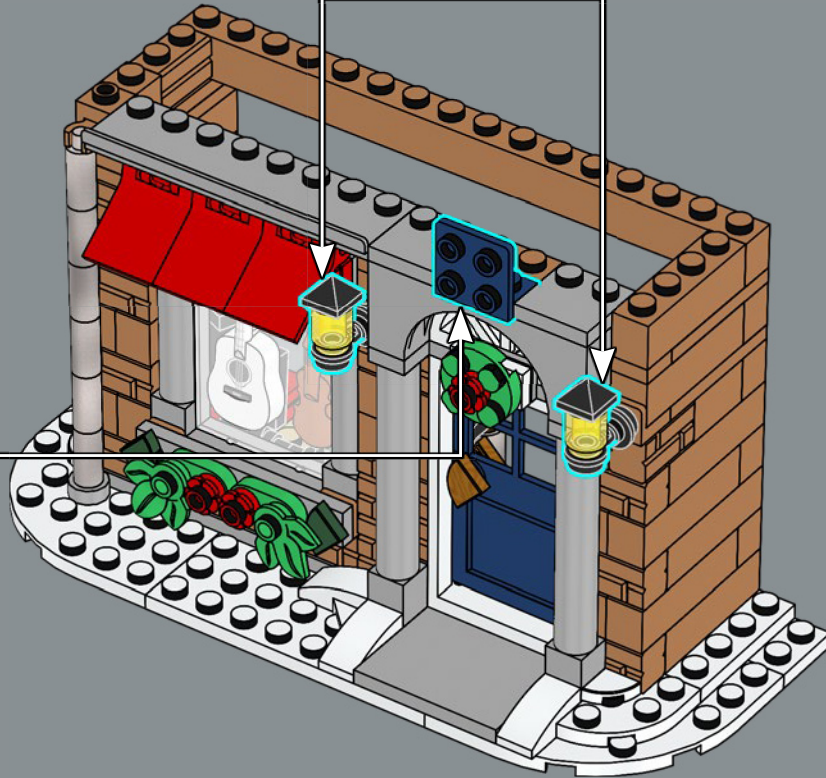
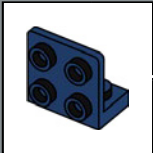
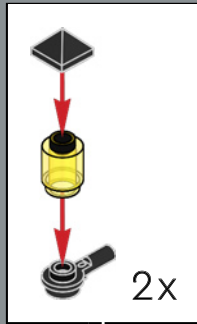

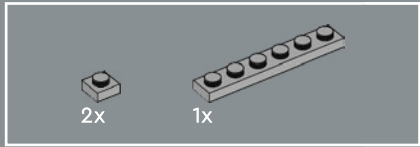

40

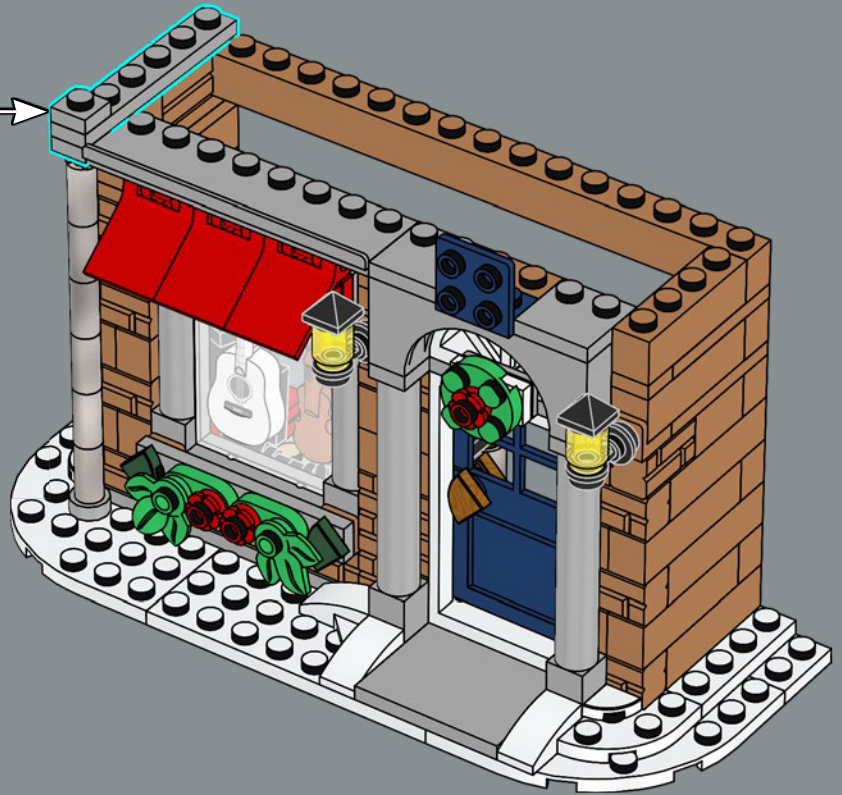
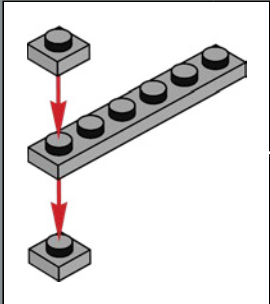

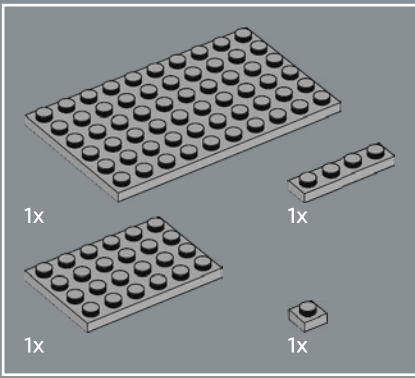

41

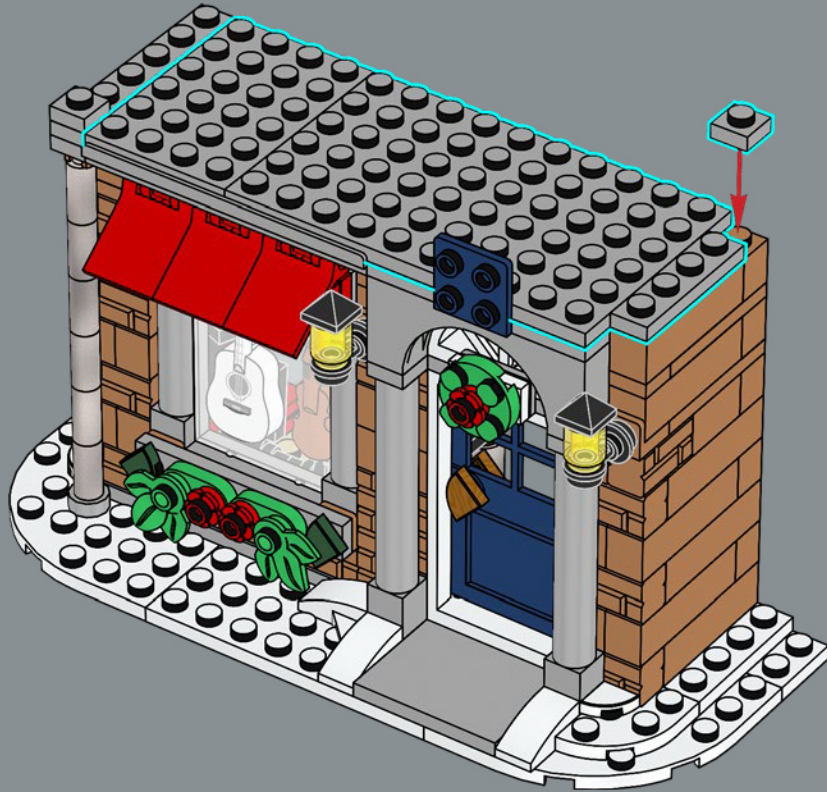



42

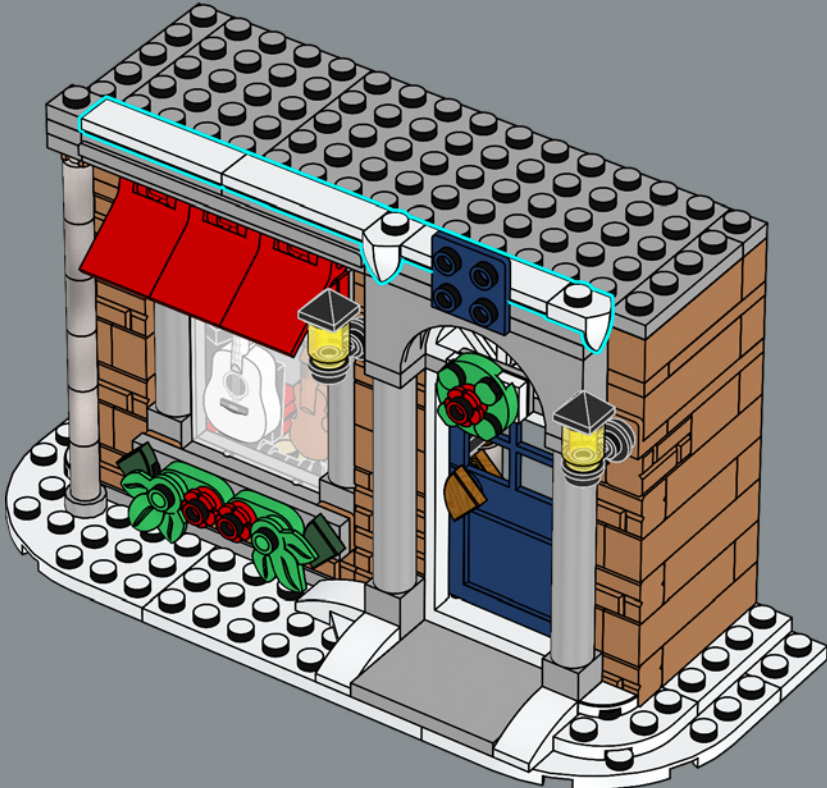

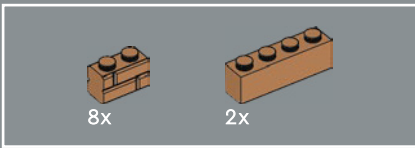

43

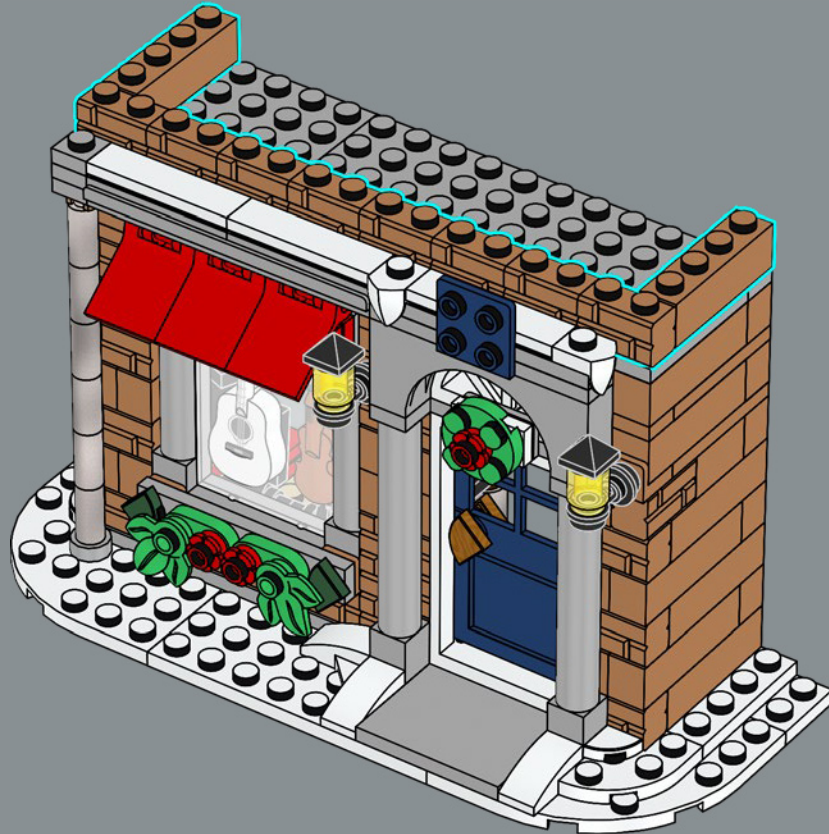

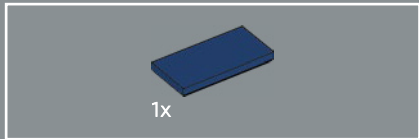

44

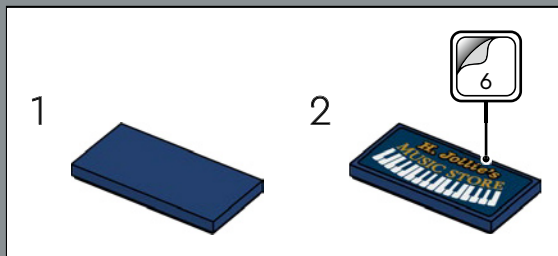

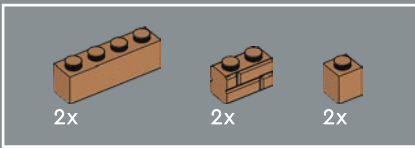

45



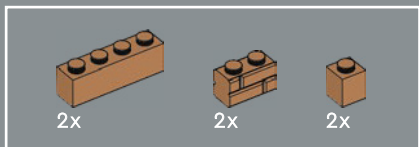

46



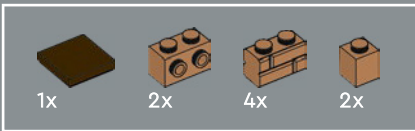

47

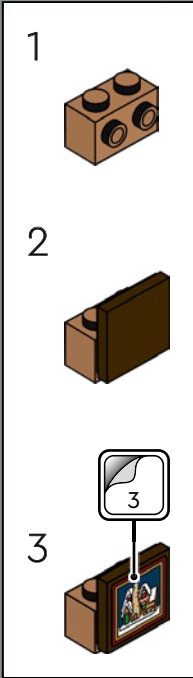

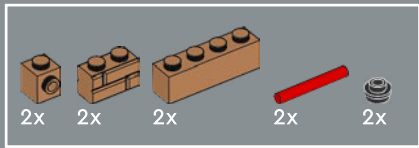

48

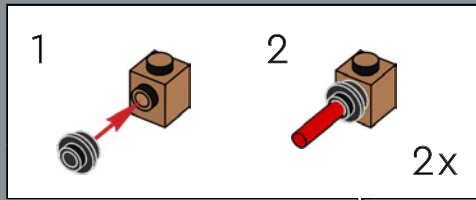

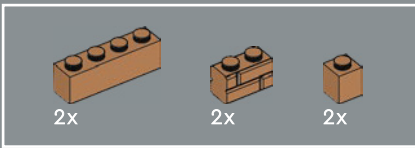

49



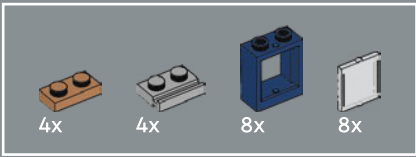

50

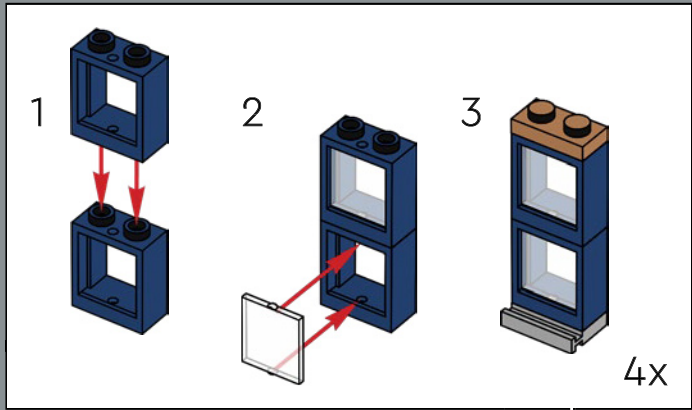

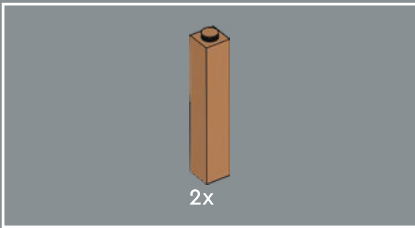

51



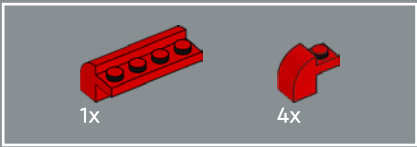

52



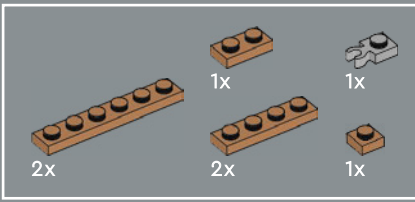

53



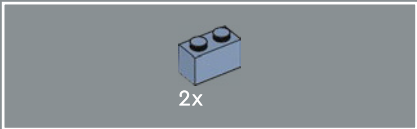

54

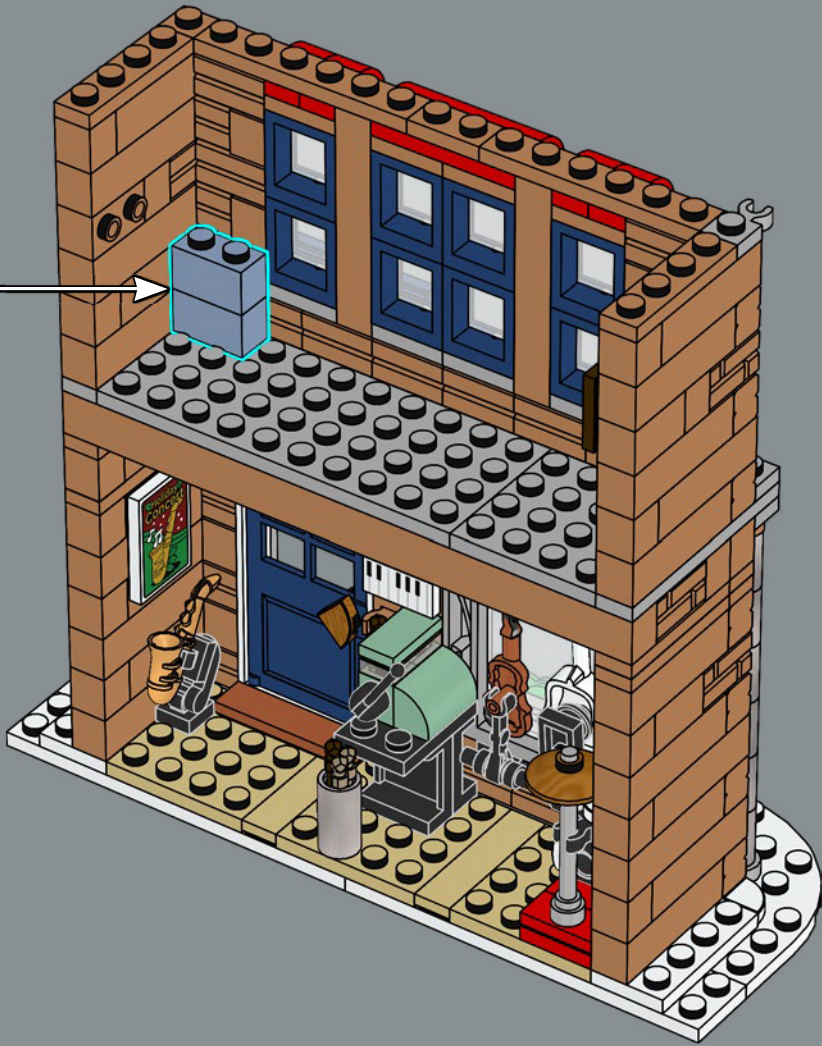
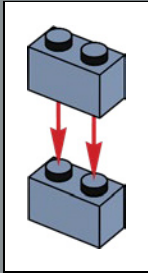

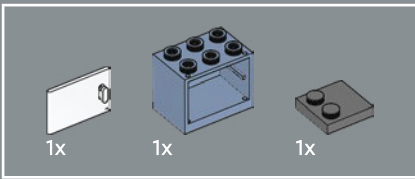

55

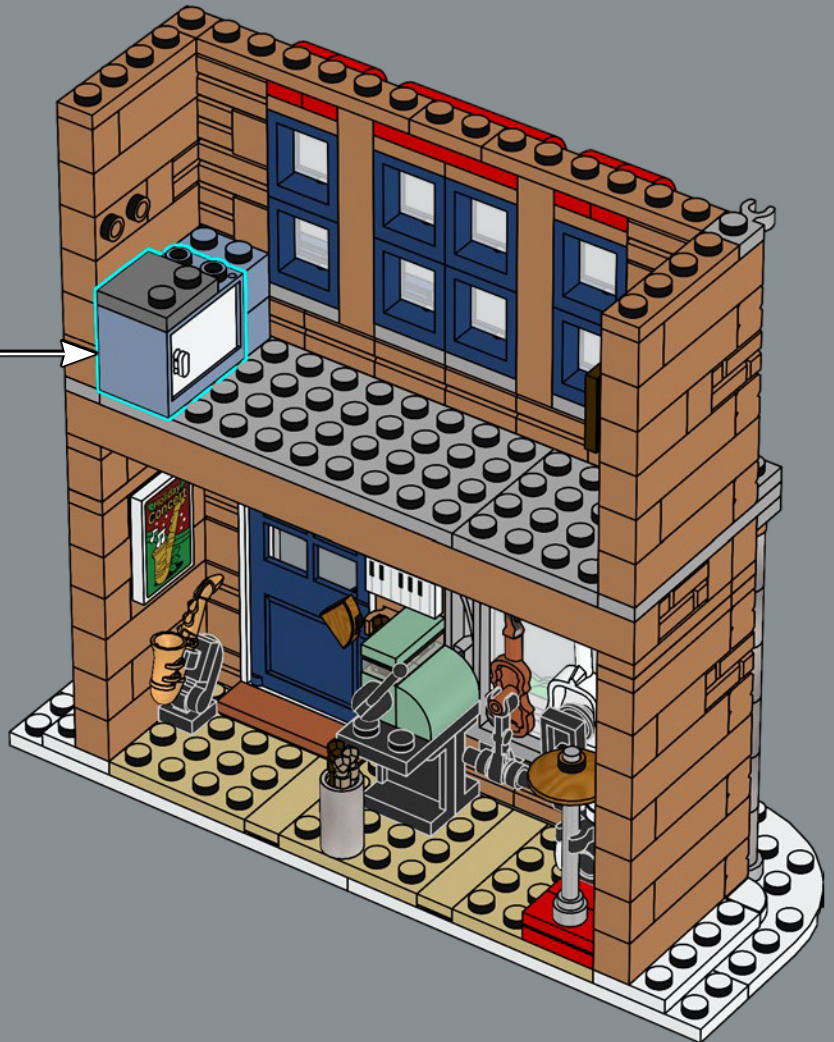
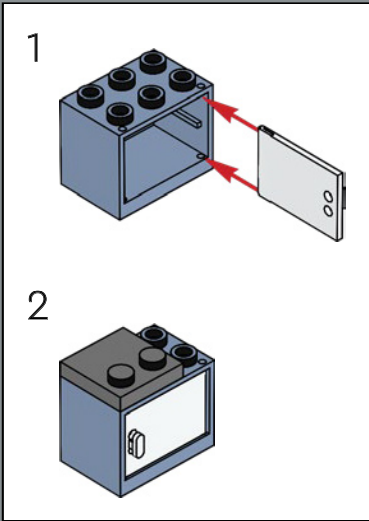



56

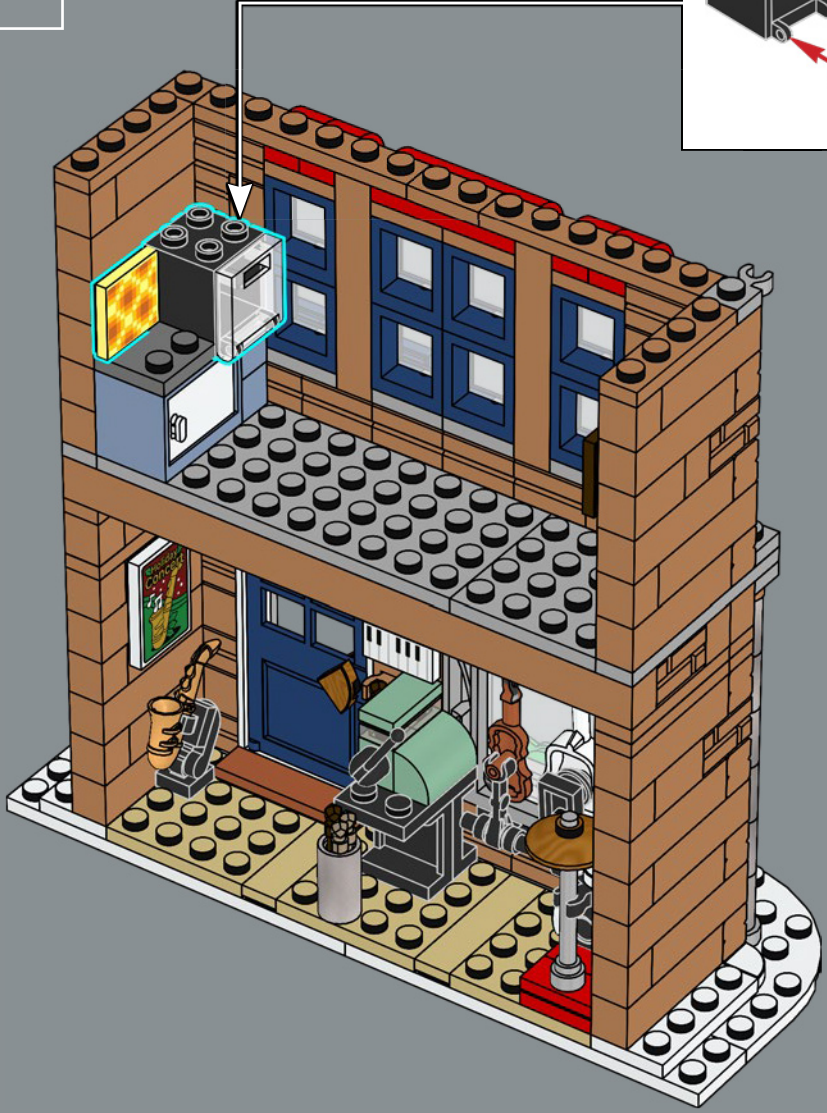
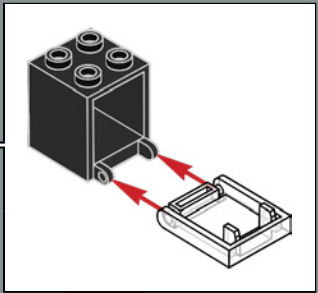



1x

57

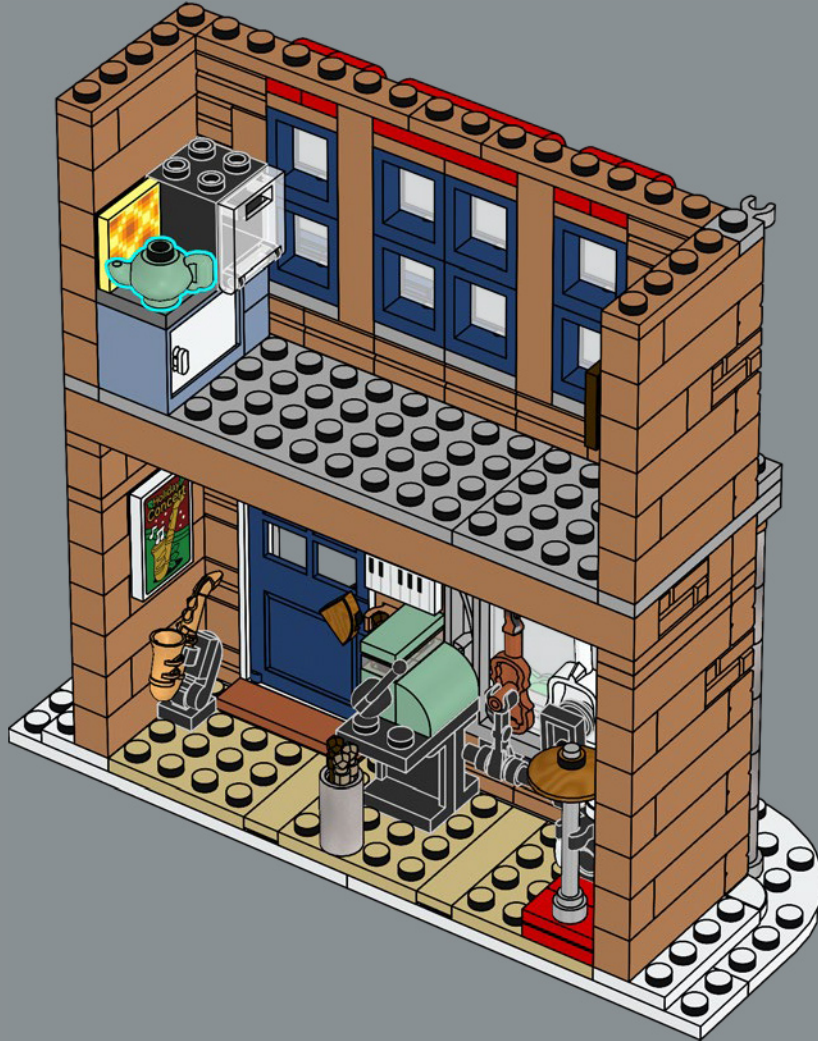

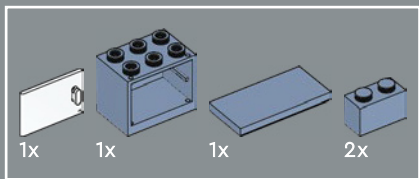

58

1

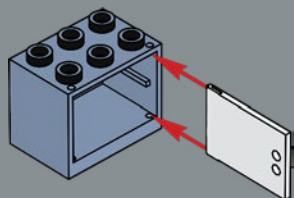

2

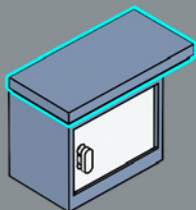

3

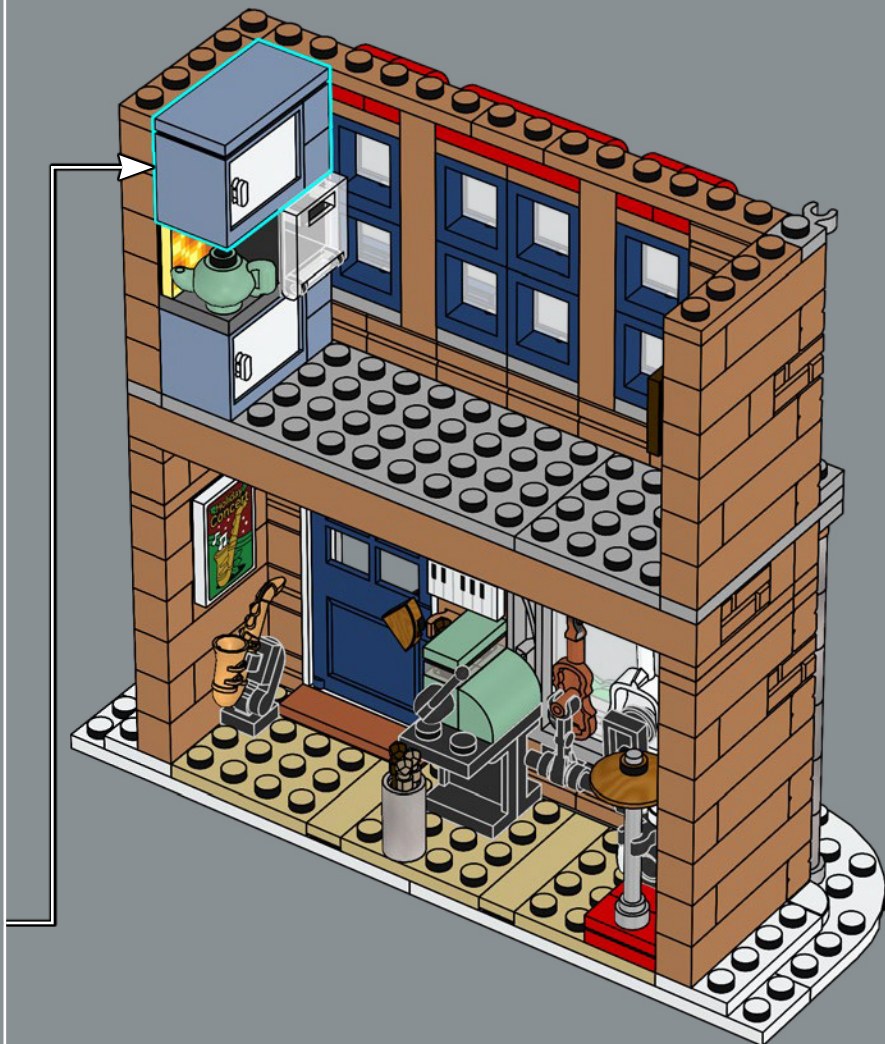
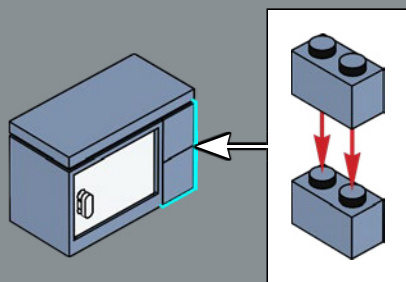

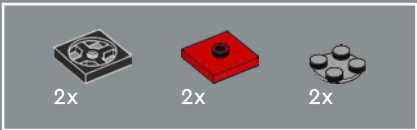

59

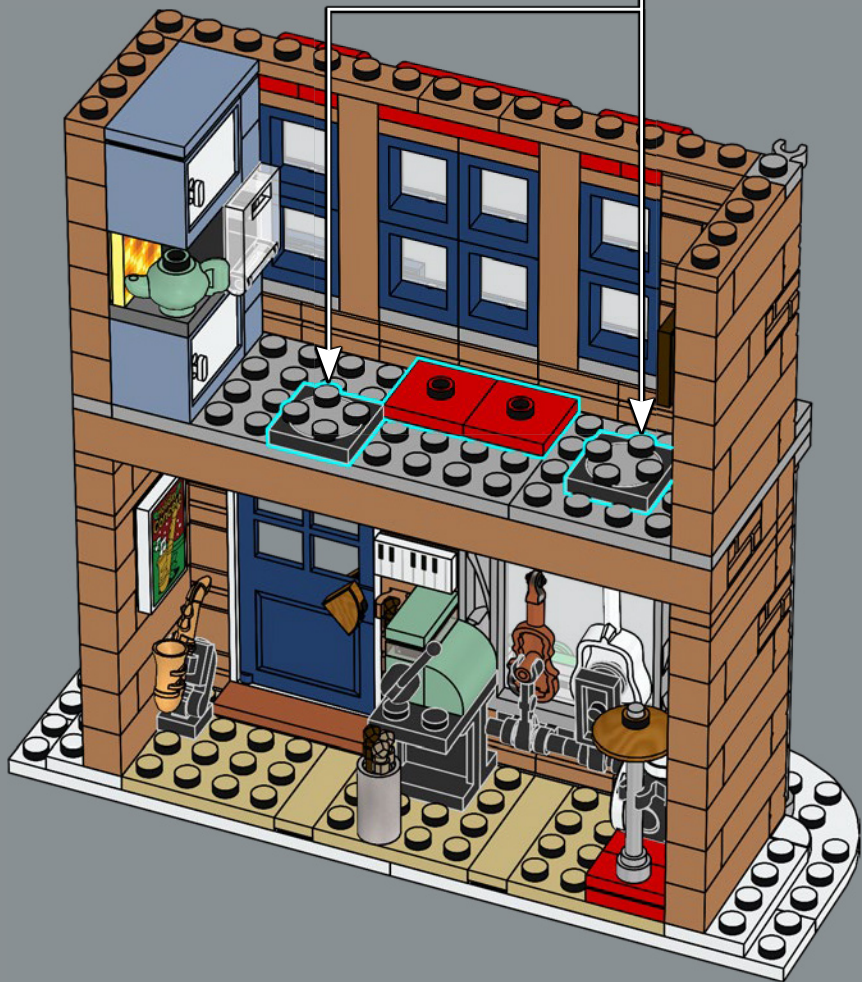
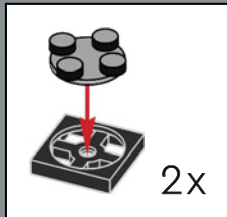

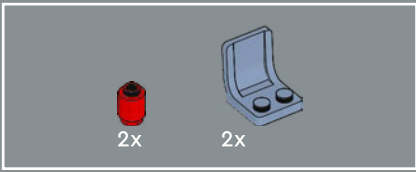

60

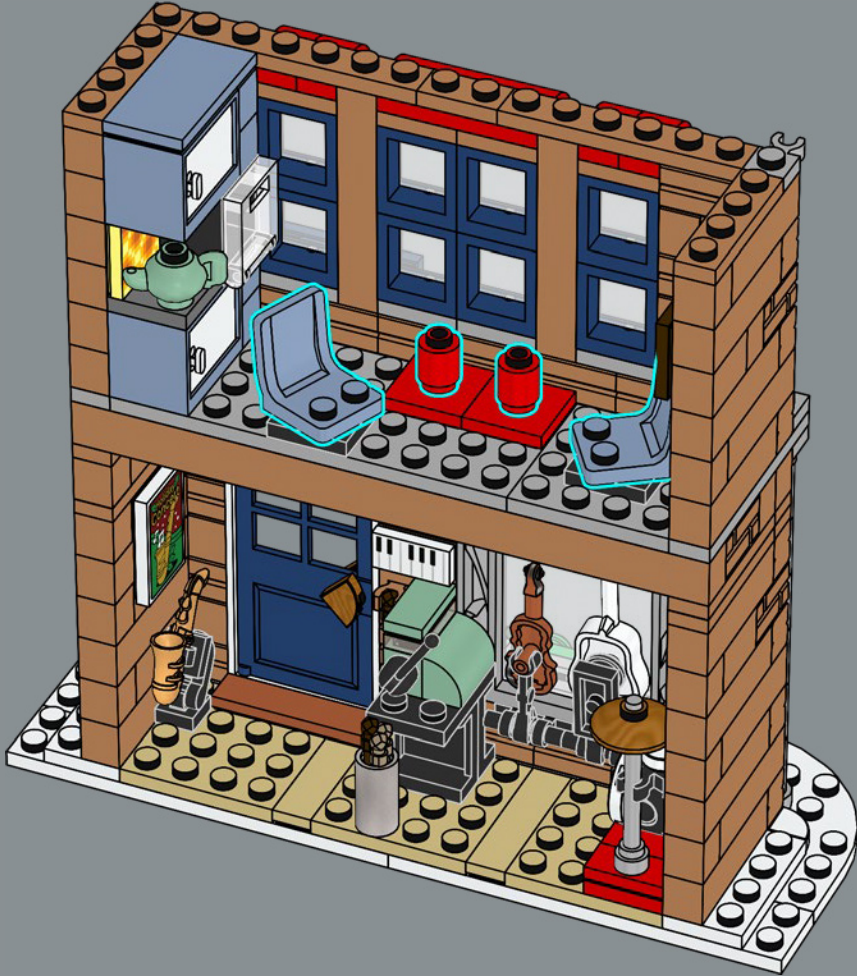

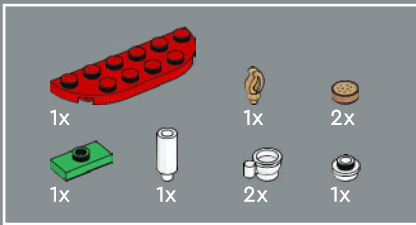

61

1



2

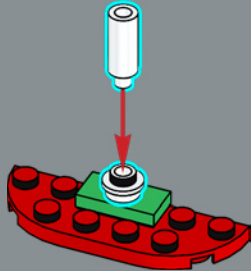

3

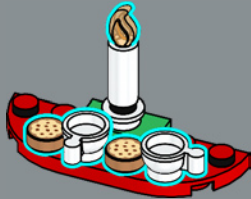

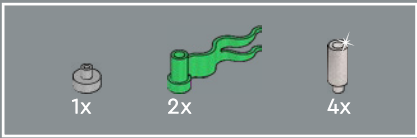

62

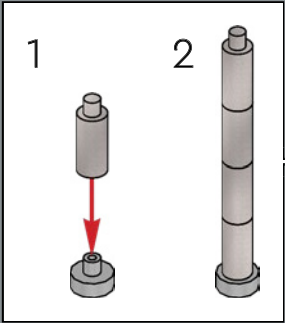

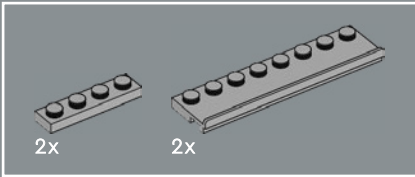

63



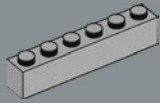

2x

64



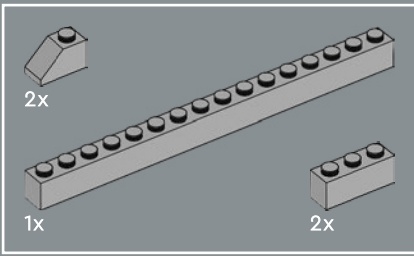

65





2x



2x

66





67

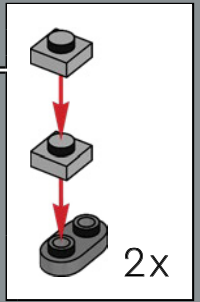

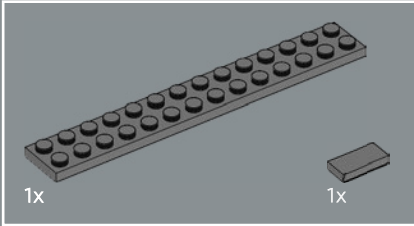
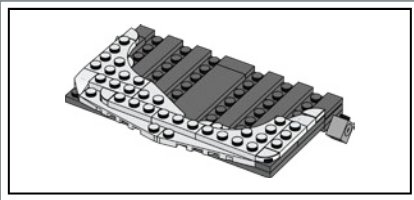

68

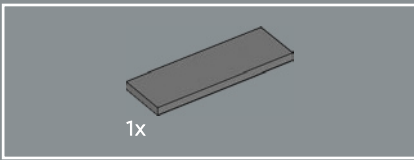
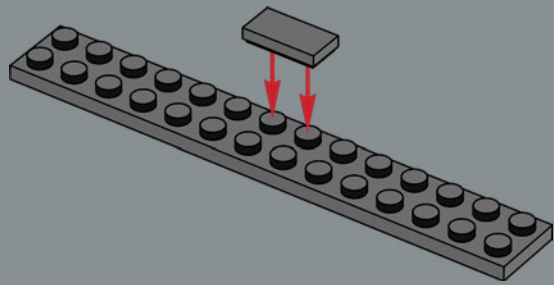

69

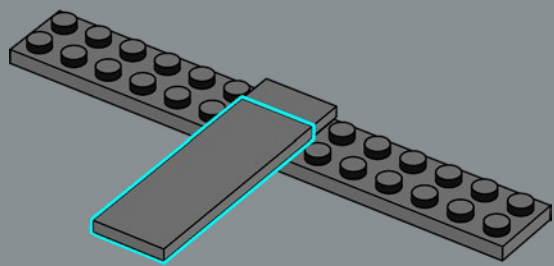

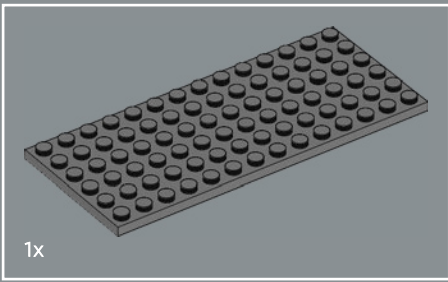

70

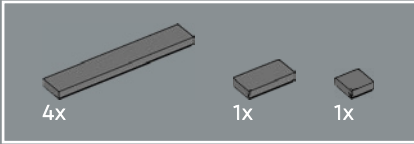
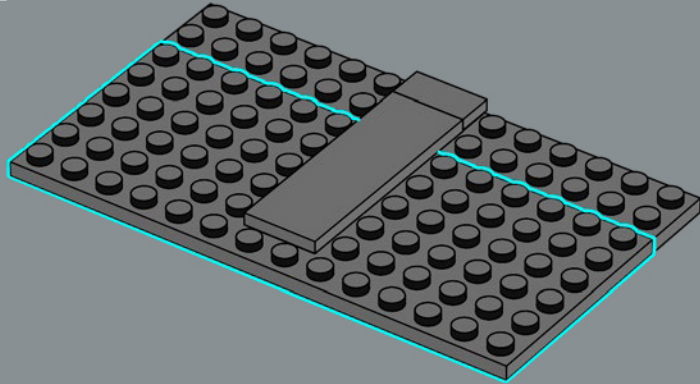

71

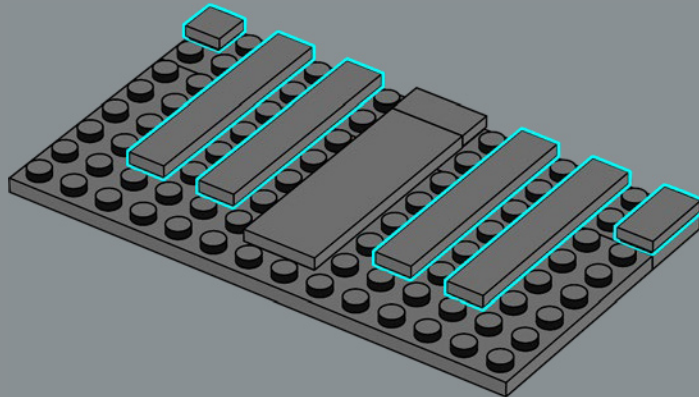

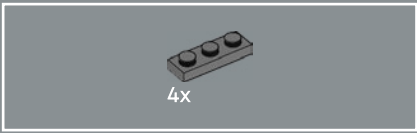

72

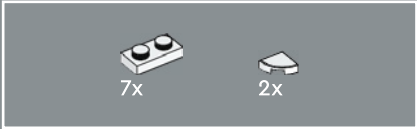
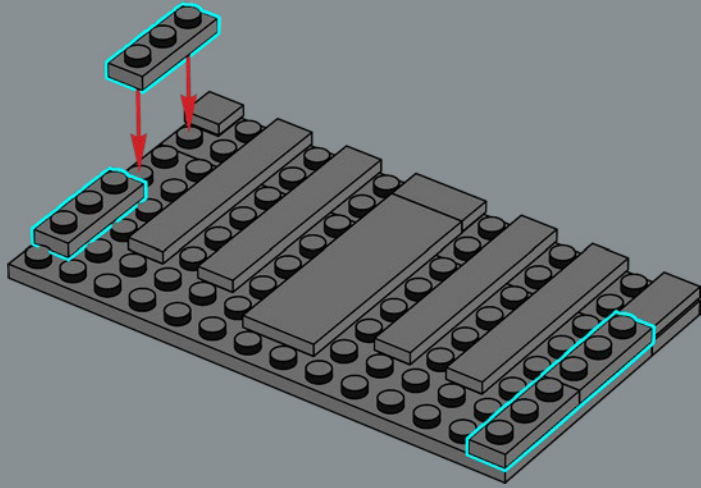

73

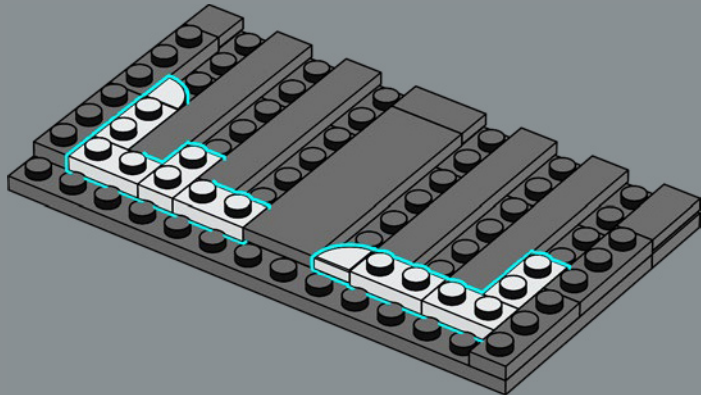

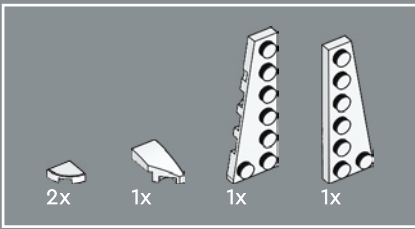

74

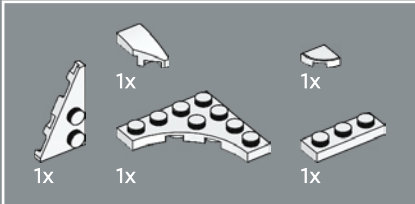
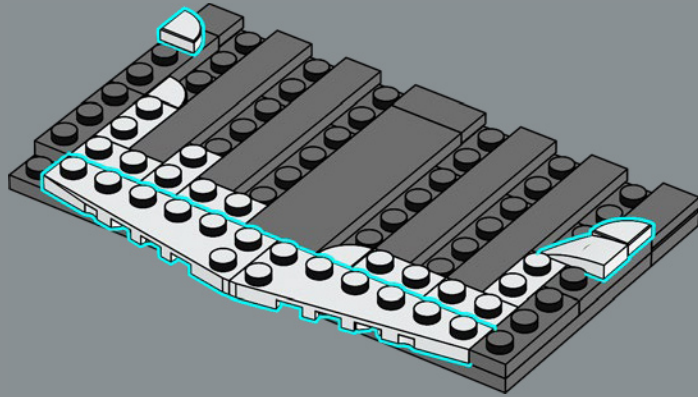

75

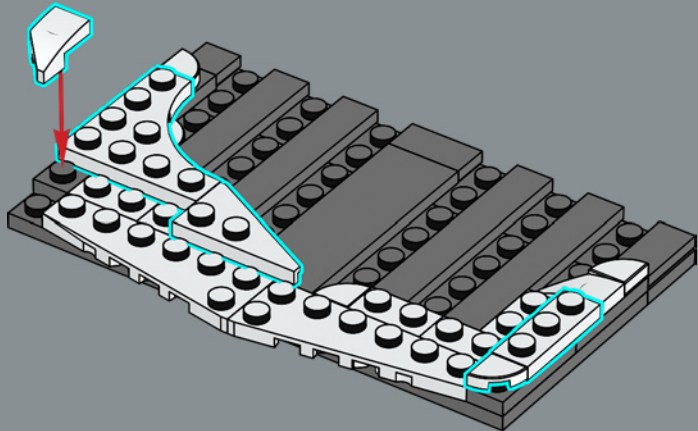

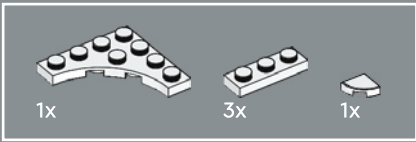

76

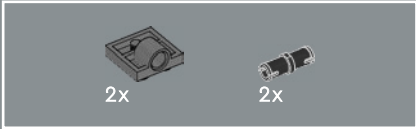
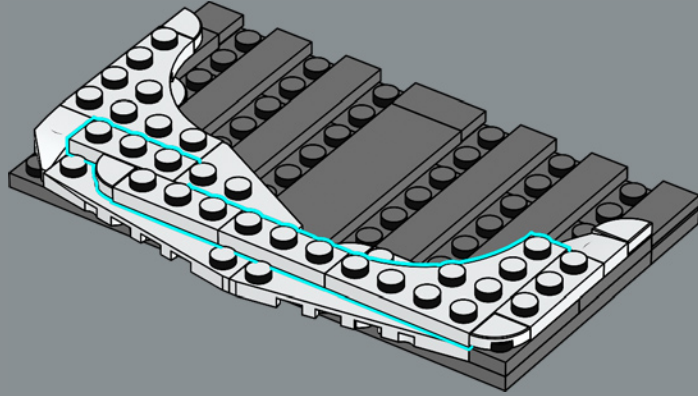

77

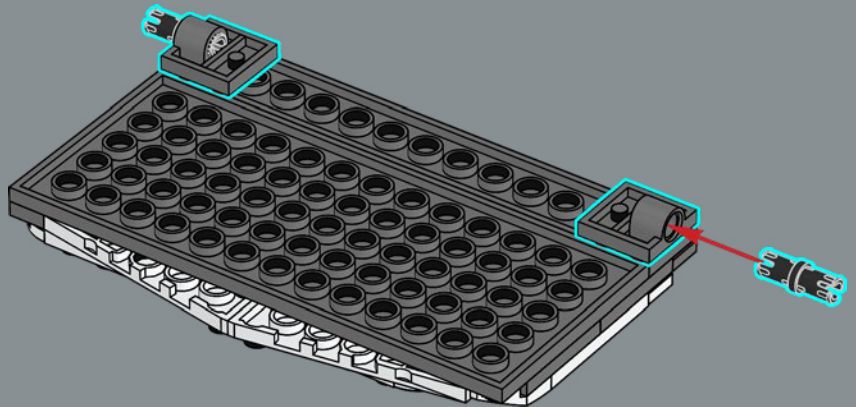

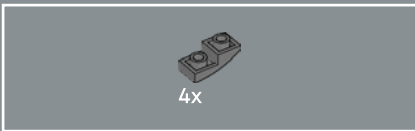

78

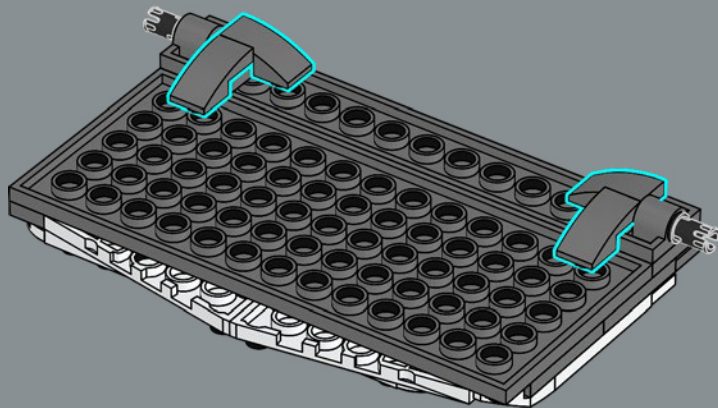

79

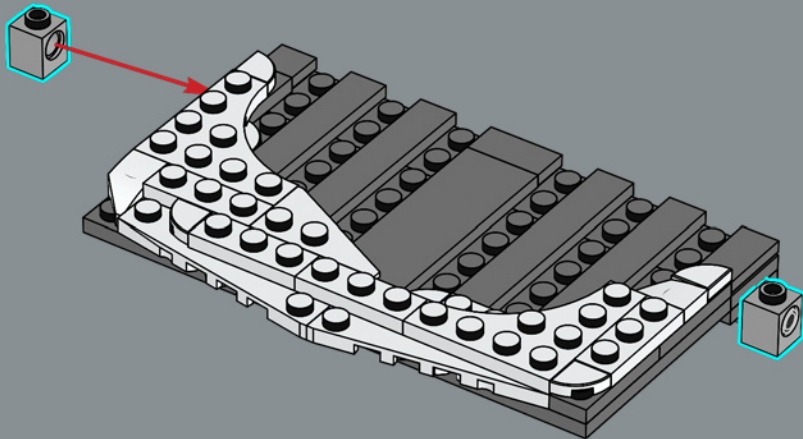

80

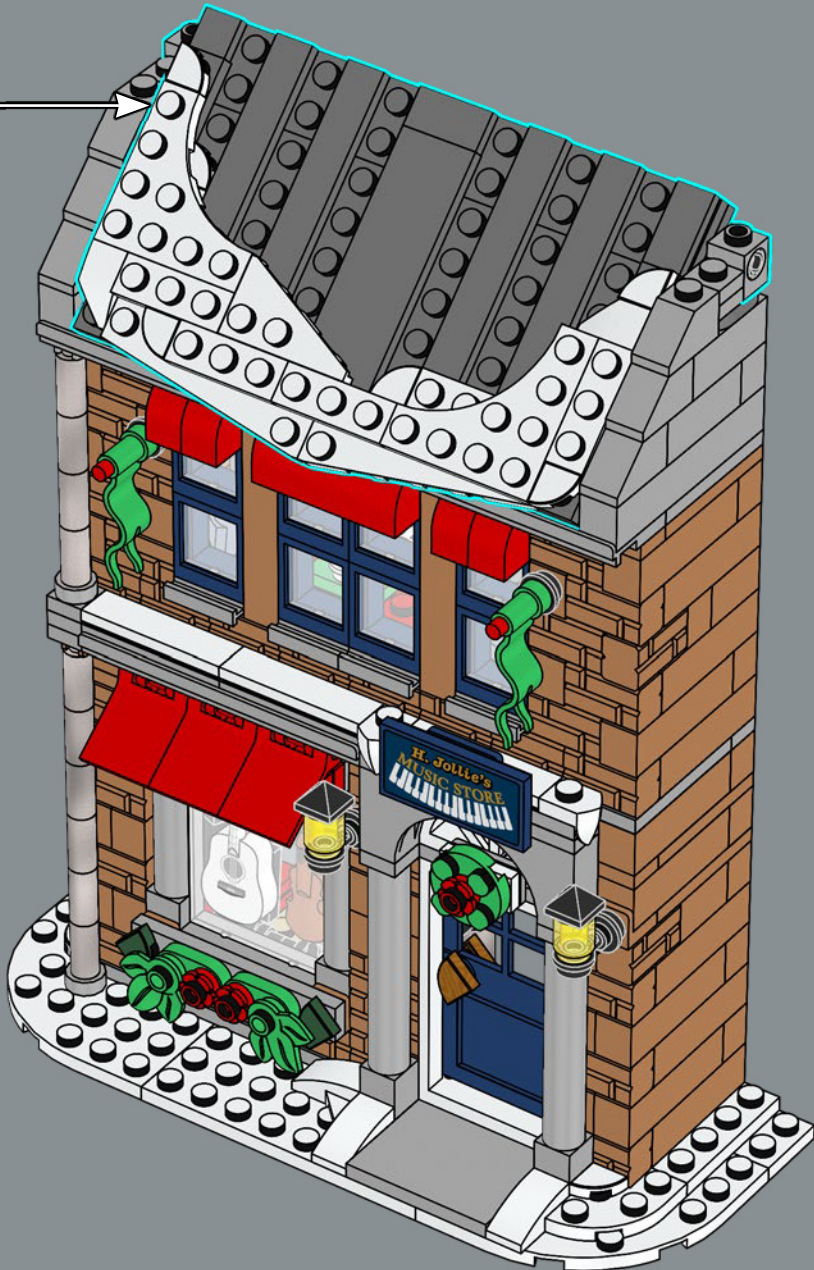

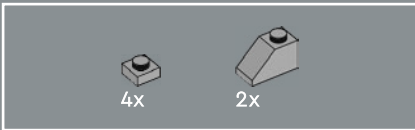

81

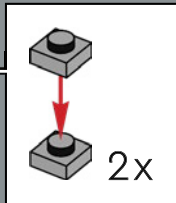

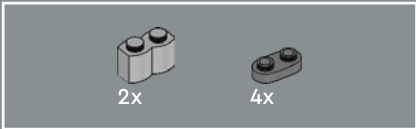

82

