



10219





MAERSK

1650

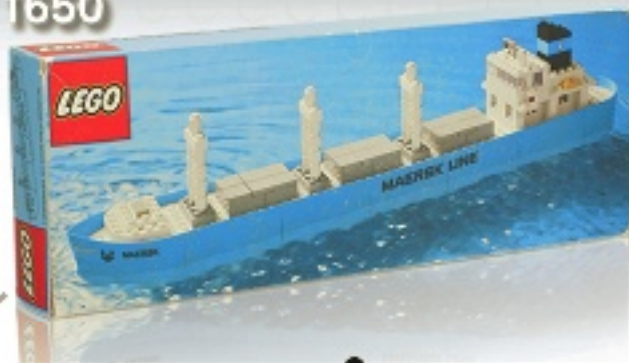

1970

1980

19



1651



1552

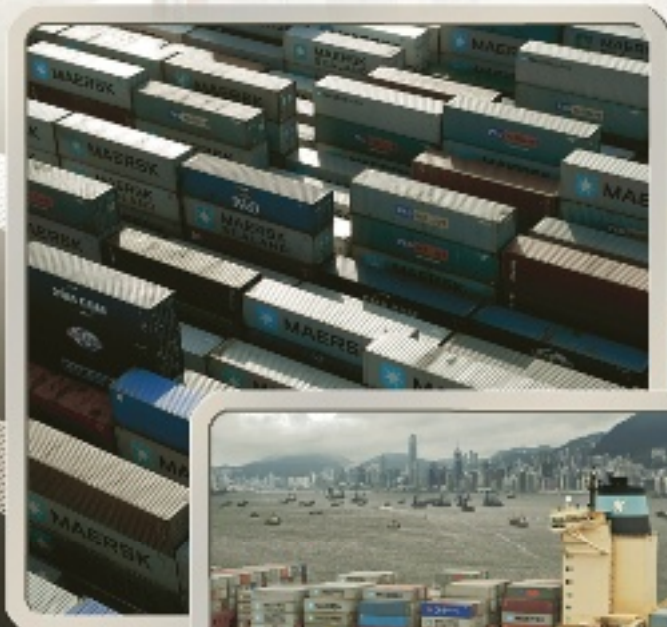

10152



10219



90

2000

2010



1831



10155



A.P. MOLLER – MAERSK GROUP - The LEGO Group History

The relationship between The LEGO Group and A.P. MOLLER – MAERSK GROUP was founded on a personal relationship between Godtfred Kirk Christiansen and Mærsk Mc-Kinney Møller. The first Maersk promotional set was a Maersk Line container ship released in 1974. Now, more than 37 years later, 10219 Maersk Train is inspired by an actual train that transported containers across the United States.

2 million Maersk containers are currently in circulation worldwide. The white containers, or 'reefers', are different from the gray containers because they are refrigerated. One of the longest container trains ever was pulled by nine locomotives and stretched almost 3.5 miles in length!



Geschichte A.P. MOLLER – MAERSK GROUP - der LEGO™ Gruppe

Die Kooperation zwischen der LEGO™ Gruppe und A.P. MOLLER – MAERSK GROUP gründet auf der Freundschaft zwischen Godtfred Kirk Christiansen und Mærsk Mc-Kinney Møller. Das erste Maersk Promotionset war ein Maersk Line Containerschiff, das 1974 auf den Markt kam. Heute, über 37 Jahre später, ist es der 10219 Maersk Zug von einem echten Zug inspiriert, der Container quer durch die Vereinigten Staaten transportierte.

2 Millionen Maersk Container sind derzeit weltweit auf Schienen unterwegs. Der Unterschied zwischen den weißen und den grauen Containern ist, dass die weißen gekühlt sind. Einer der längsten Containerzüge, den es jemals gab, wurde von neun Lokomotiven gezogen und war 5,6 km lang!



MAERSK

1650



1970

1980

19



1651



1552



A A.P. MOLLER – MAERSK GROUP - LEGO Csoport története

A LEGO Csoport és a A.P. MOLLER – MAERSK GROUP közötti kapcsolatot két ember, Godtfred Kirk Christiansen és Mærsk Mc-Kinney Møller személyes kapcsolatával kezdődött. Az első Maersk promóciós készlet egy Maersk Line konténerhajó volt, amely 1974-ben jelent meg. Most, több mint 37 évvel később, a 10219-es Maersk Train ötletét egy létező vonat adta, amely konténereket szállított az Egyesült Államokon keresztül.

Jelenleg 2 millió Maersk konténer van úton világszerte. A fehér konténerek vagy 'reefer'-ek mások, mint a szürkék, mert ezek hűtőkonténerek. A valaha volt egyik leghosszabb konténervonatot kilenc mozdony húzta, és több mint 5,6 kilométer hosszú volt!



História da A.P. MOLLER – MAERSK GROUP - LEGO Group

A relação entre a LEGO Group e a A.P. MOLLER – MAERSK GROUP foi fundada com base numa relação pessoal entre Godtfred Kirk Christiansen e Mærsk Mc-Kinney Møller. O primeiro conjunto promocional Maersk foi um navio porta-contentores lançado em 1974. Agora, 37 anos mais tarde, o Comboio Maersk, modelo 10219, inspira-se num comboio autêntico que transportava contentores nos Estados Unidos.

2 milhões de contentores Maersk circulam actualmente no mundo. Os contentores brancos são diferentes dos contentores cinzentos porque são refrigerados. Um dos mais compridos comboios porta-contentores de sempre foi puxado por nove locomotivas e prolongava-se ao longo de quase 5,6 Km!

10152



10219



90

2000

2010



1831



10155



Les origines de l'association entre A.P. MOLLER – MAERSK GROUP et le Groupe LEGO

L'association entre le Groupe LEGO et A.P. MOLLER – MAERSK GROUP est née de la relation personnelle entre Godtfred Kirk Christiansen et Mærsk Mc-Kinney Møller. Le premier ensemble promotionnel Maersk était un navire porte-conteneurs Maersk lancé en 1974. Aujourd'hui, 37 ans plus tard, le train Maersk, le modèle 10219, est inspiré d'un vrai train qui transportait des conteneurs aux États-Unis.

Deux millions de conteneurs Maersk sont actuellement en circulation dans le monde. Les conteneurs blancs sont différents des conteneurs gris car ils sont réfrigérés. L'un des trains transporteurs de conteneurs les plus longs était tiré par neuf locomotives et mesurait plus de 5,6 km de long !



Historia de la relación entre A.P. MOLLER – MAERSK GROUP y el Grupo LEGO

La relación entre el Grupo LEGO y A.P. MOLLER – MAERSK GROUP tiene su origen en la amistad que mantenían Godtfred Kirk Christiansen y Mærsk Mc-Kinney Møller. El primer set promocional dedicado a Maersk fue un barco de mercancías de Maersk Line comercializado en 1974. Hoy, más de 37 años después, presentamos el set número 10219, Tren de Maersk, inspirado en un tren auténtico que transportaba contenedores a lo largo de Estados Unidos.

En la actualidad circulan alrededor del mundo un total de 2 millones de contenedores de Maersk. Los contenedores de color blanco se diferencian de los de color gris en que son de tipo refrigerado. ¡Uno de los trenes dedicados al transporte de contenedores más largo que ha existido contaba con nueve locomotoras y tenía una longitud de 5,6 kilómetros!

1

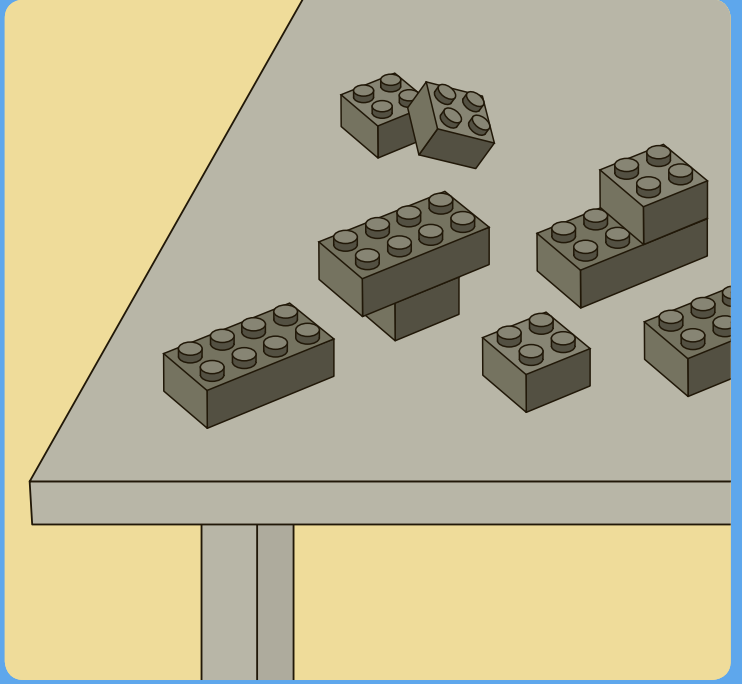
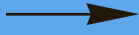

2





+

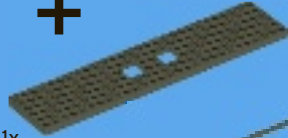

1x



4x



2x





2x

1



2x

2

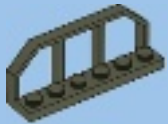

1x

3





4

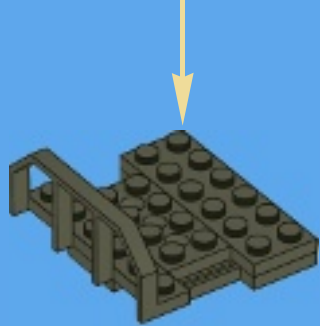
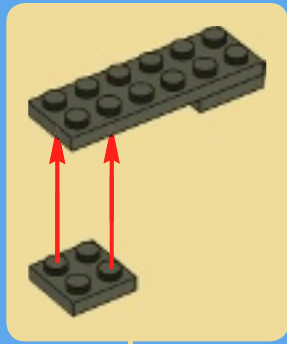

5





2x



2x

6

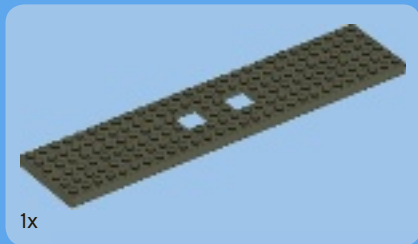
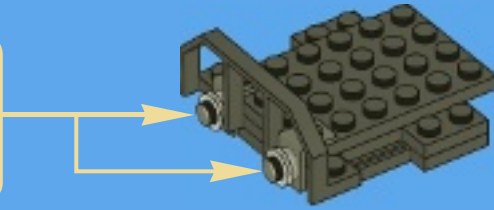

7

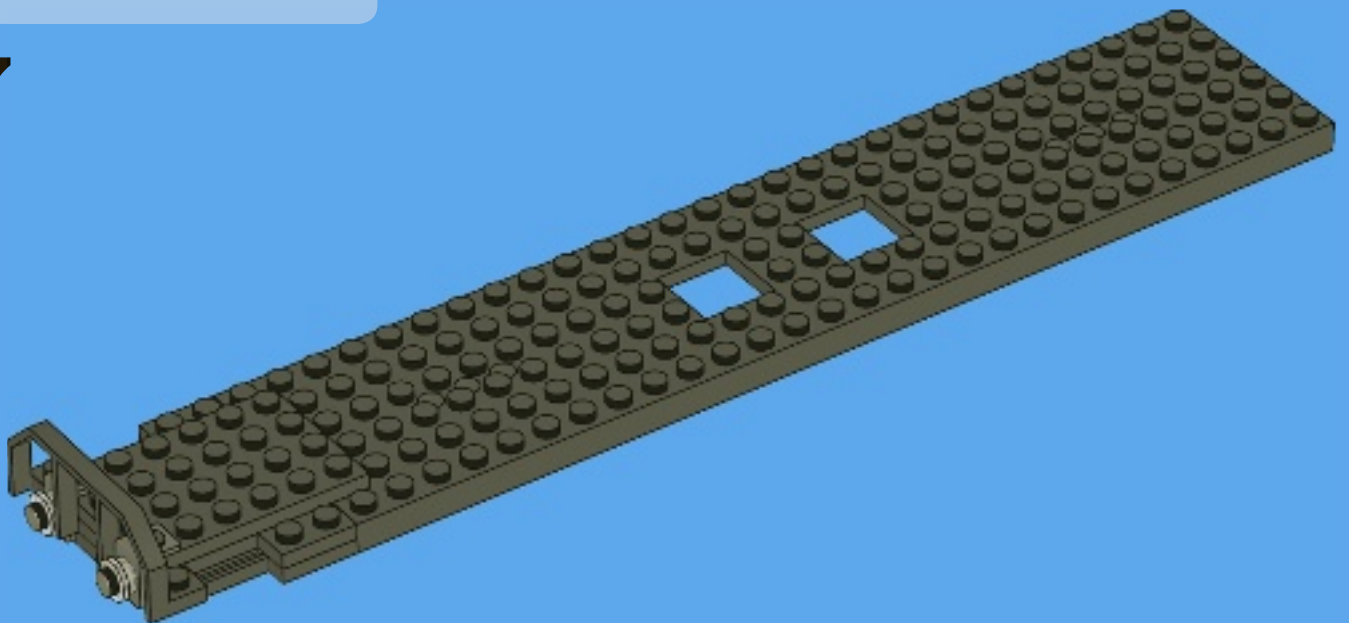



2x

1

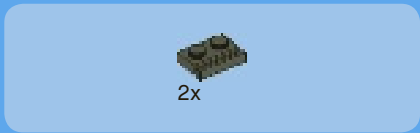

2x

2

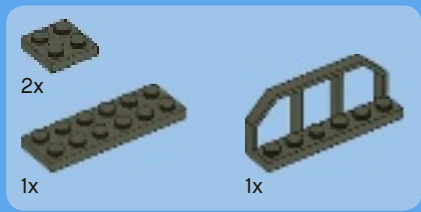

2x

1x

1x

3

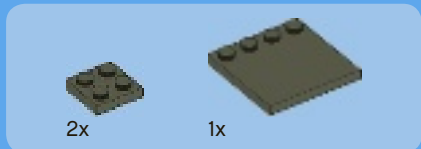
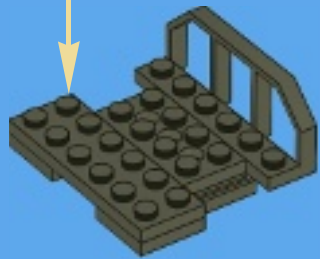
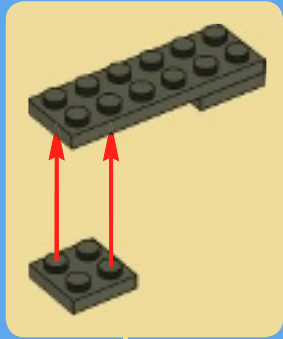

2x

1x

4

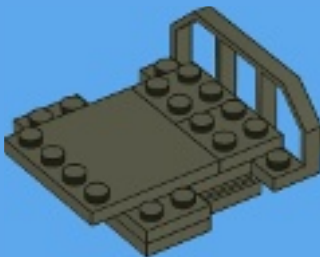



2x



2x

5

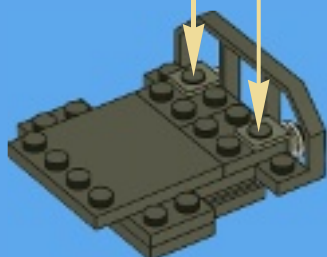

8

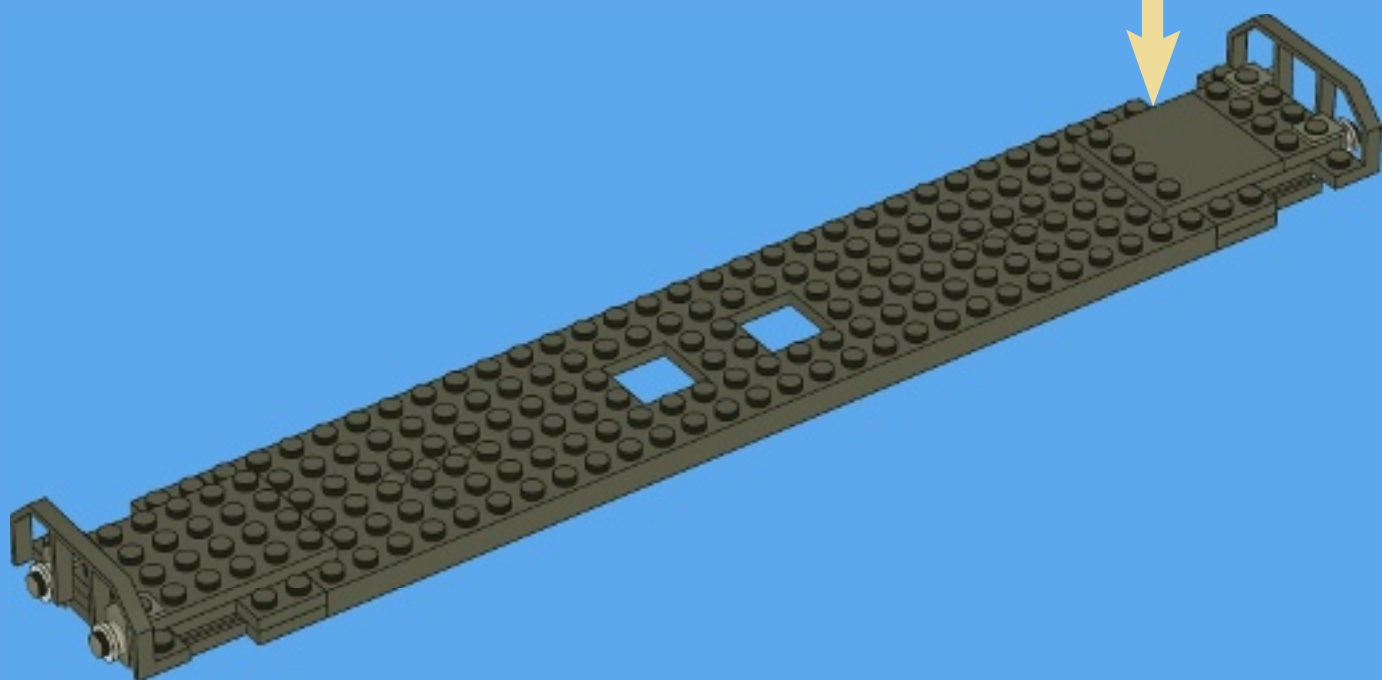

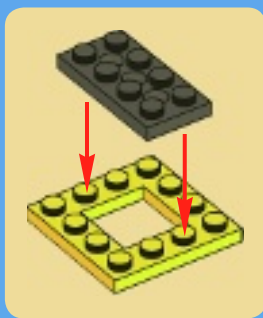

9

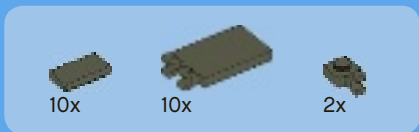
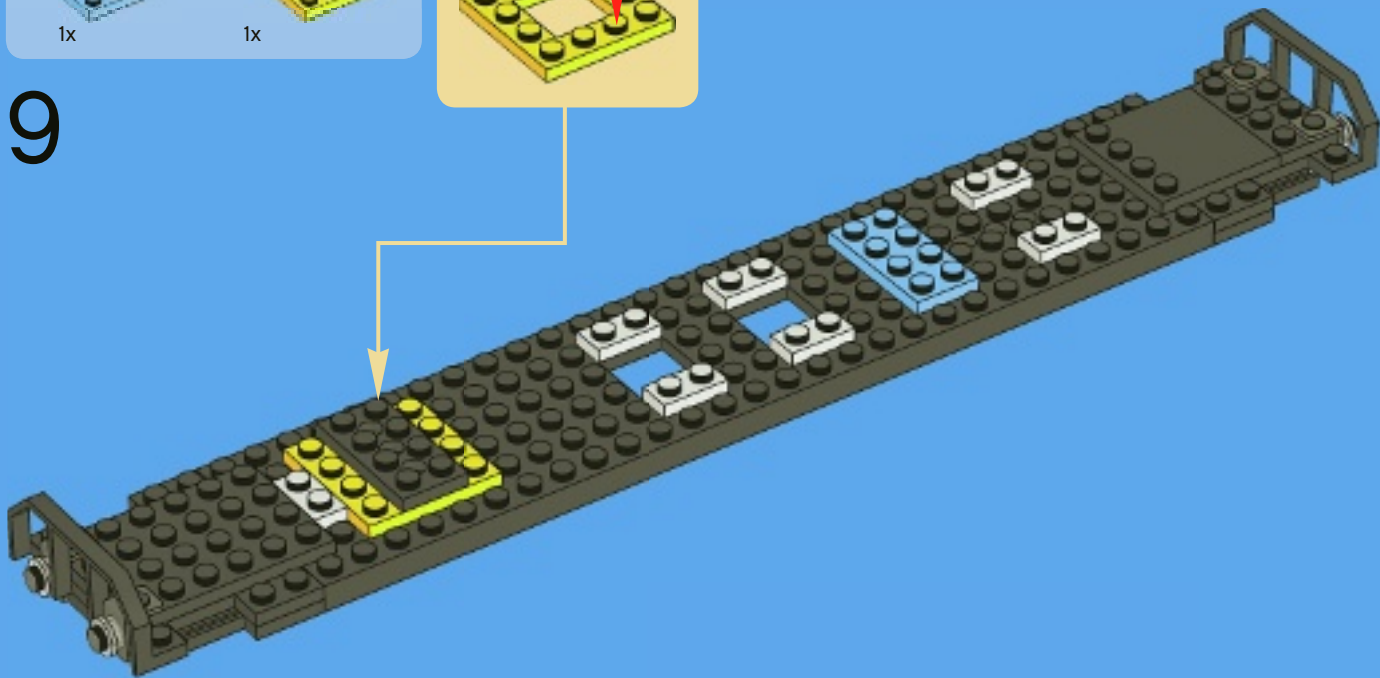

10

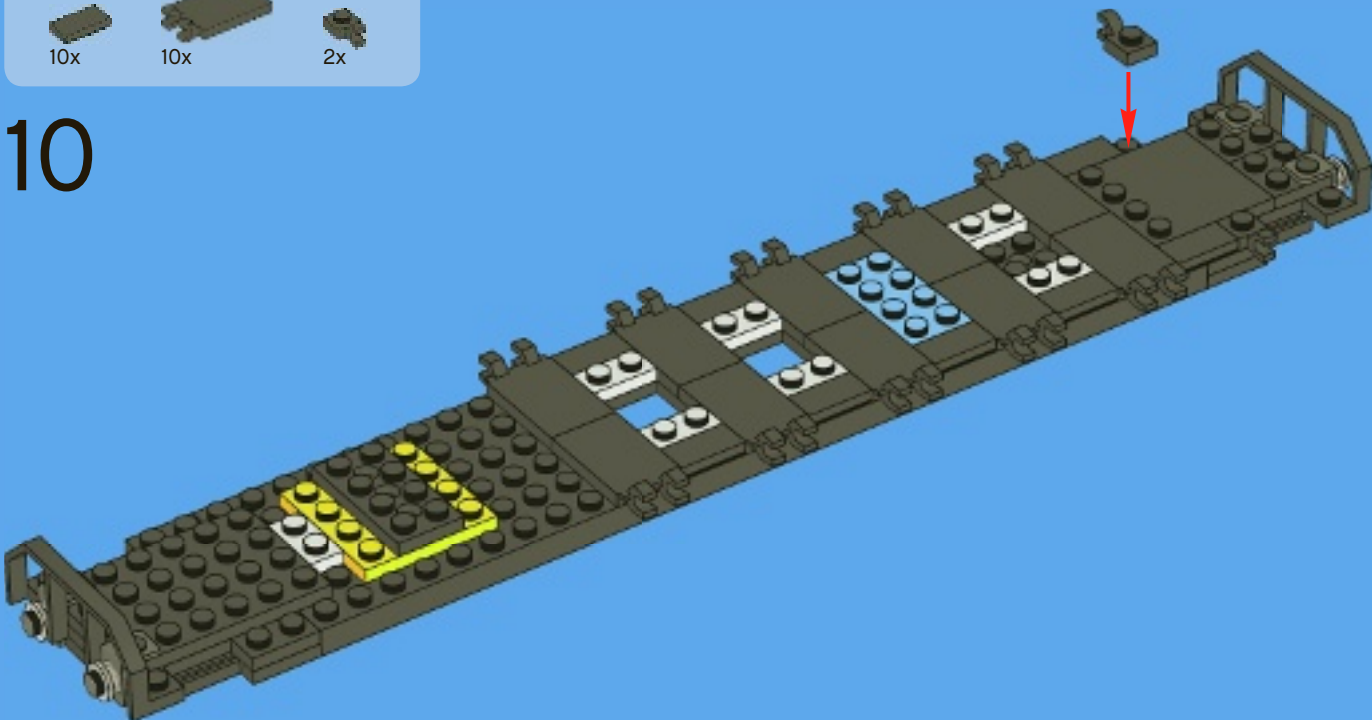

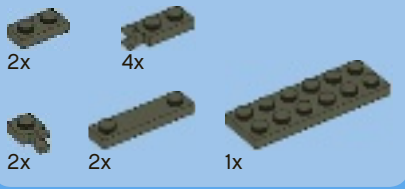

11

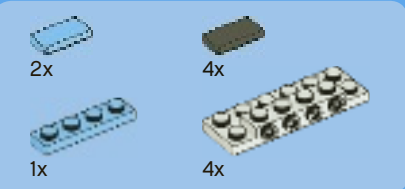
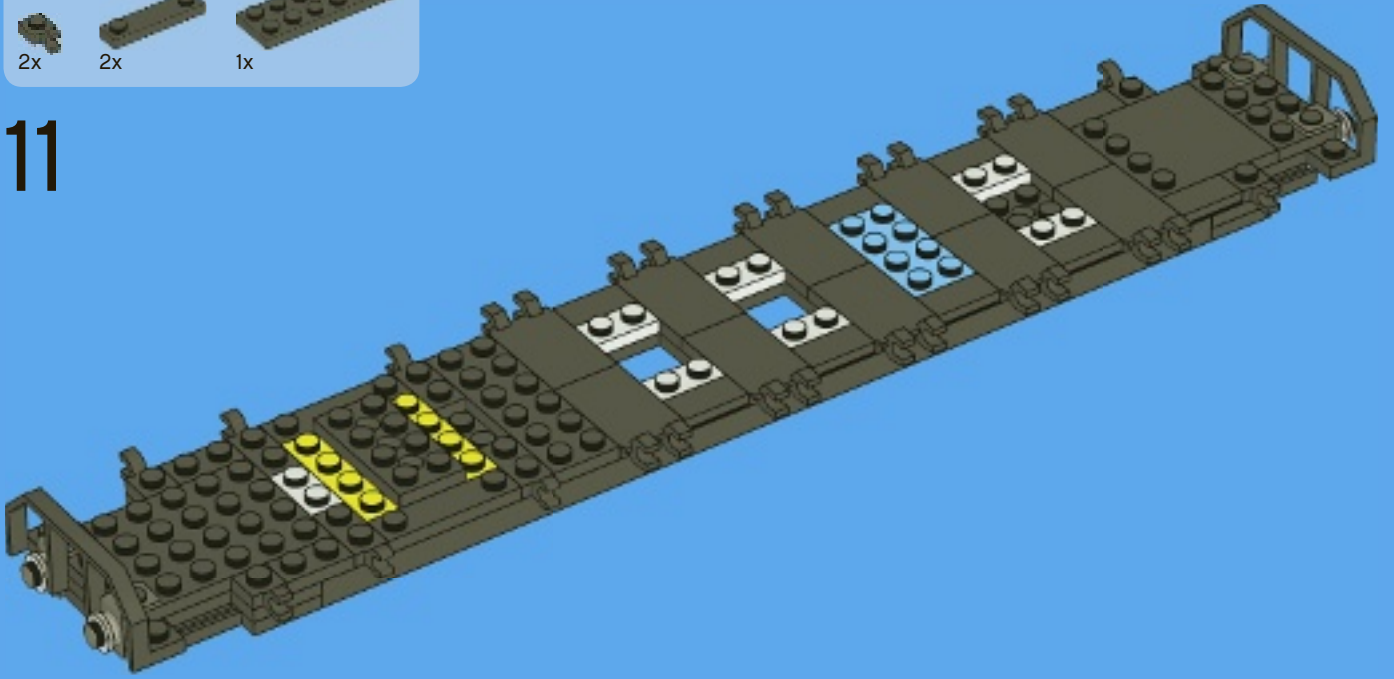

12

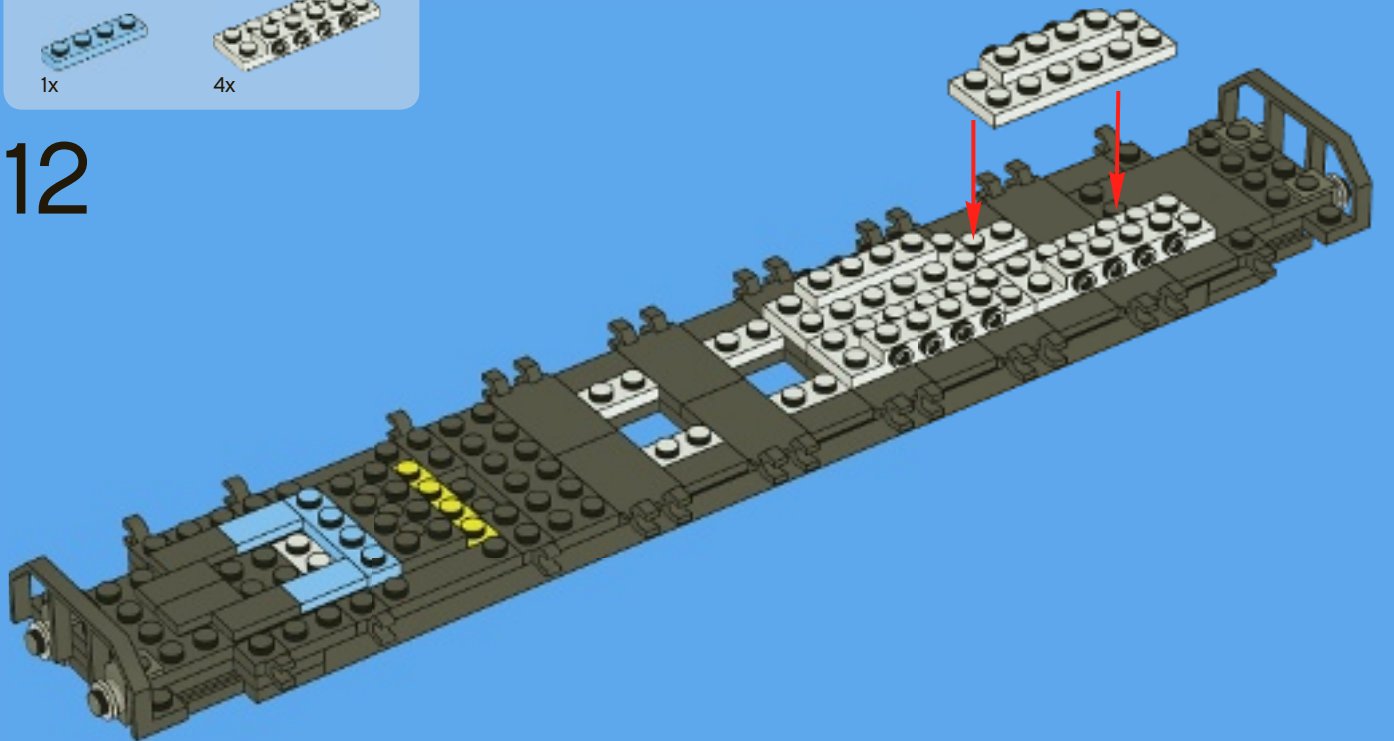



13

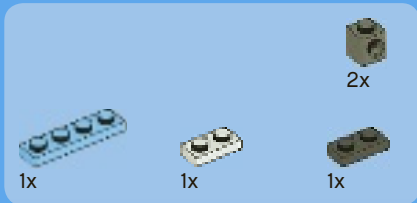
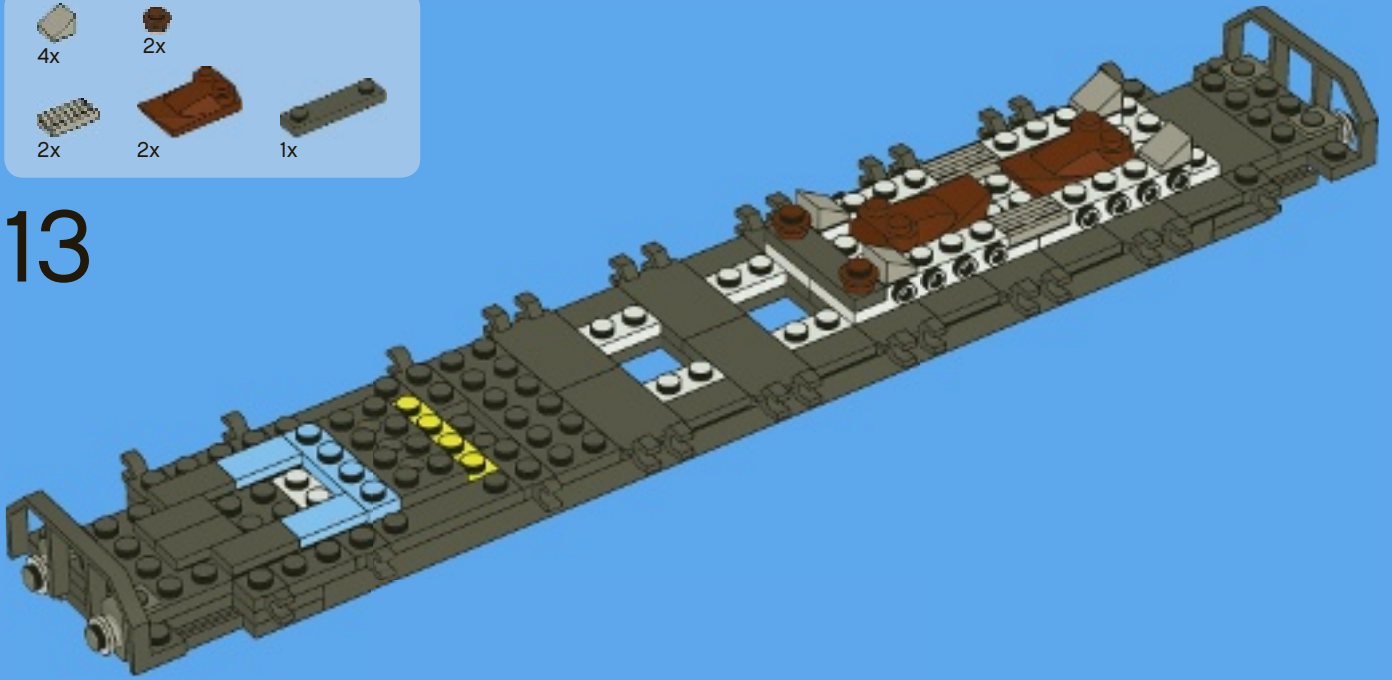

14

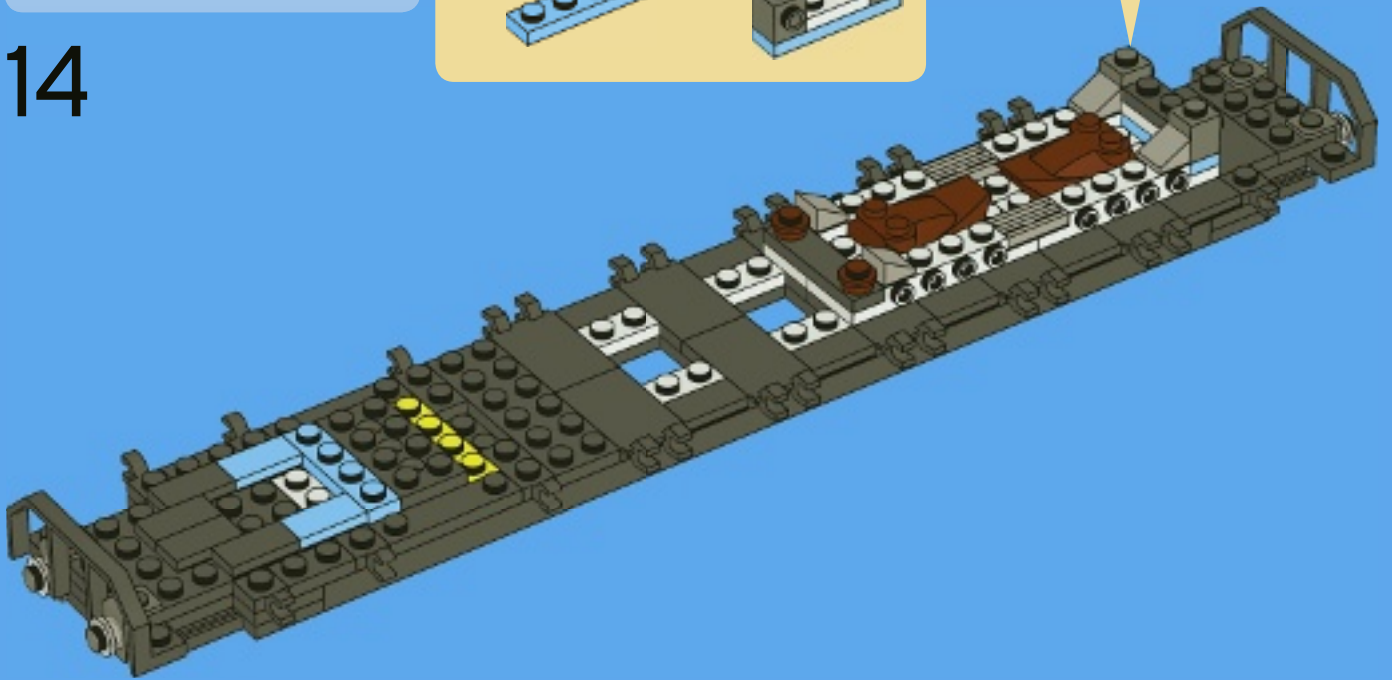
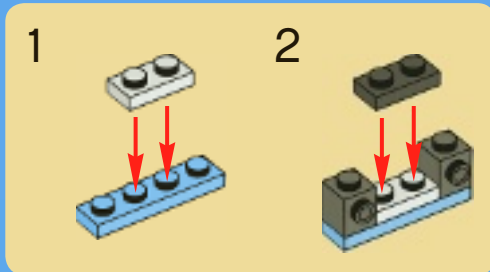

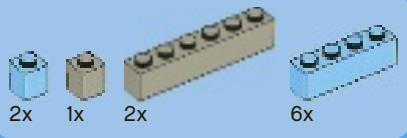

15

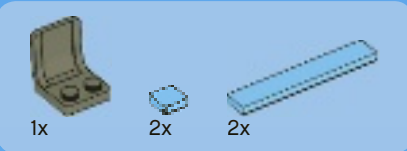
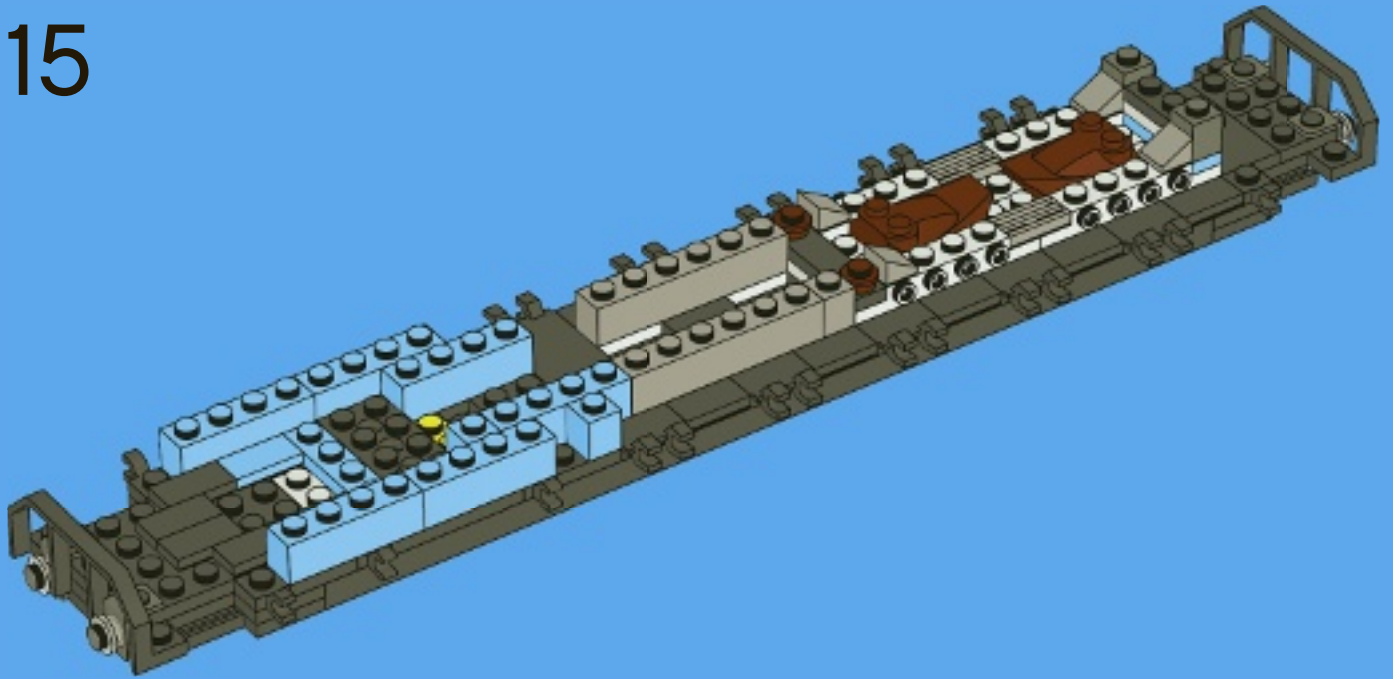

16

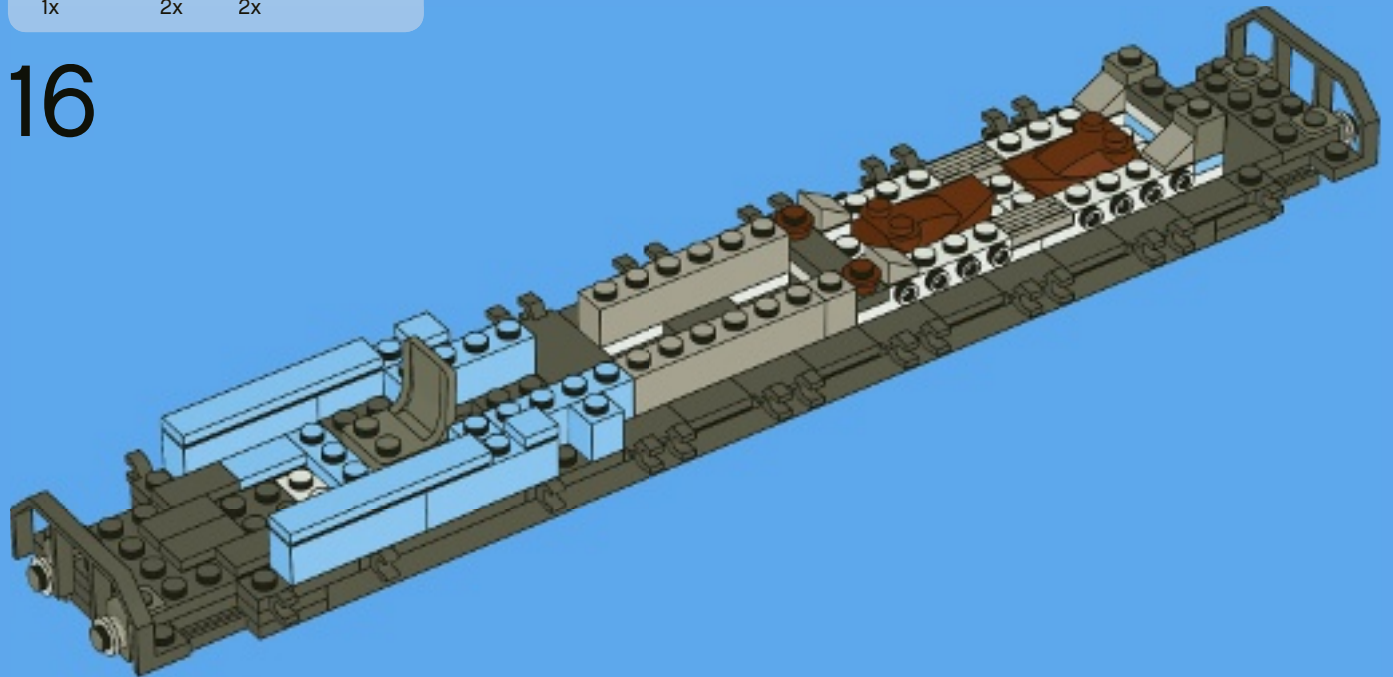

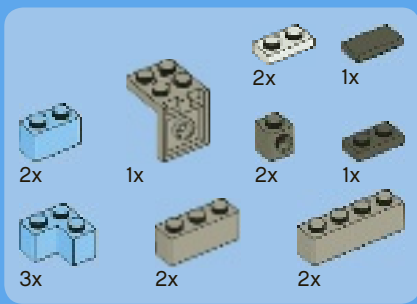

17

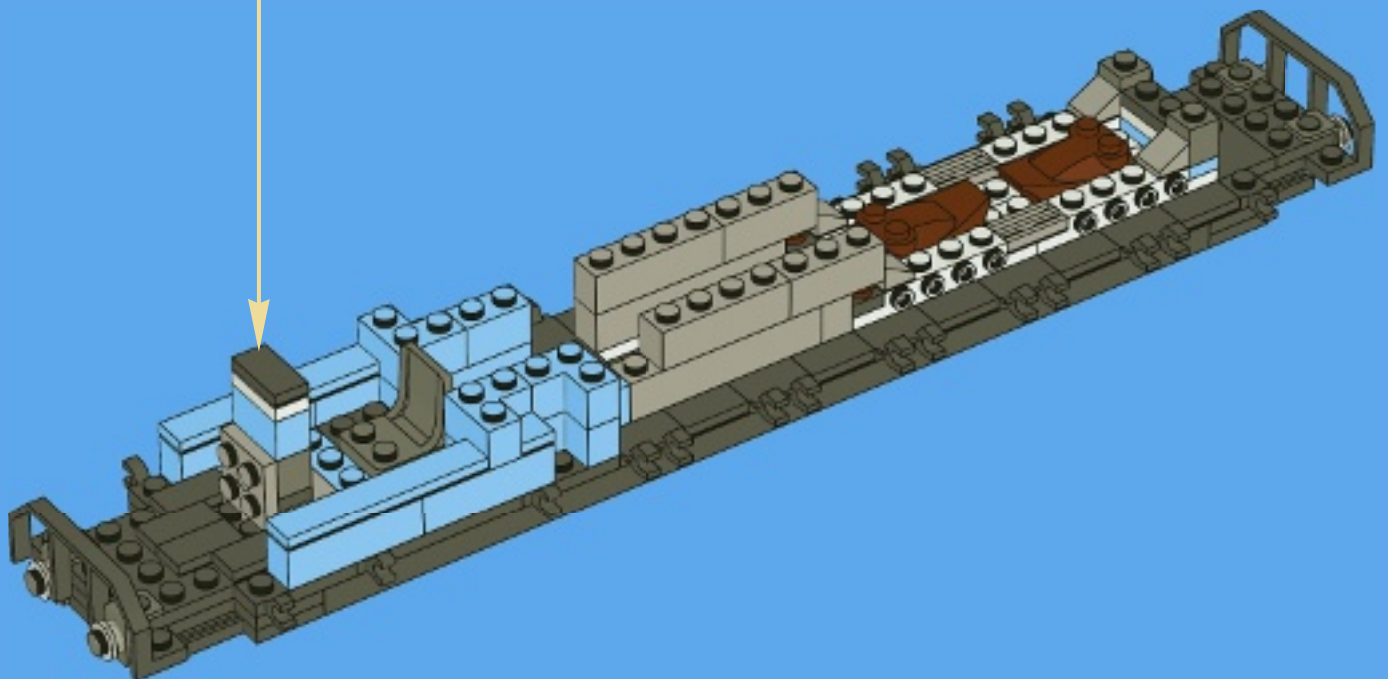
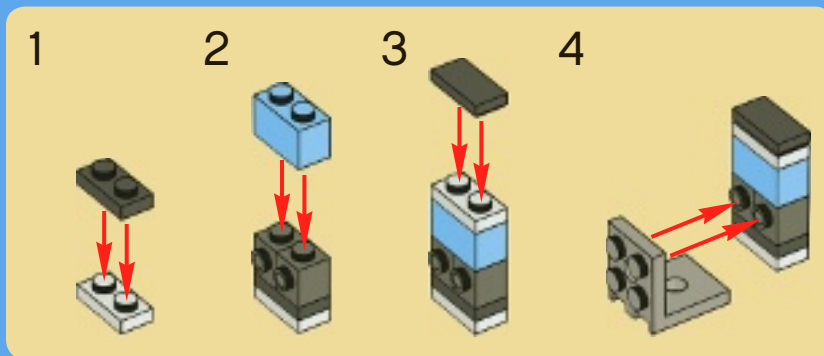

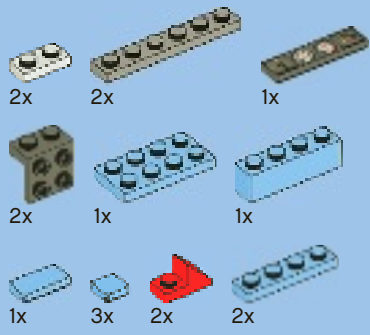

18

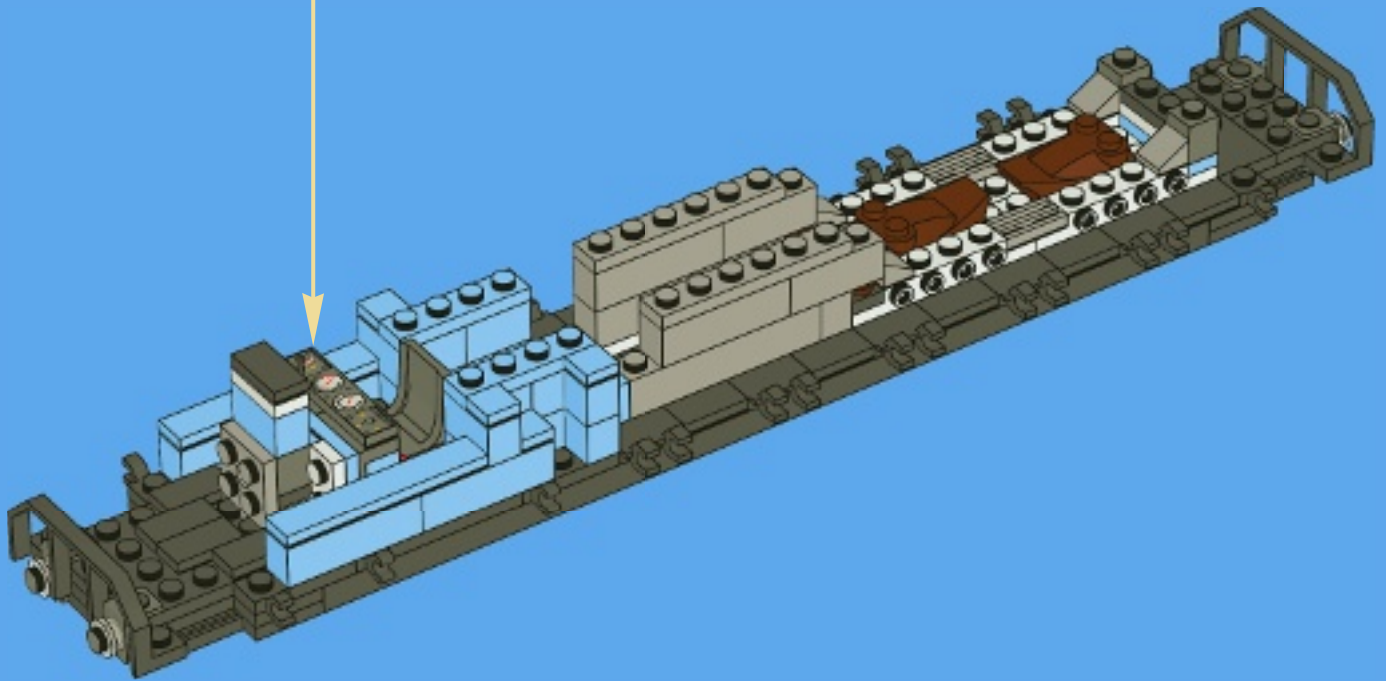
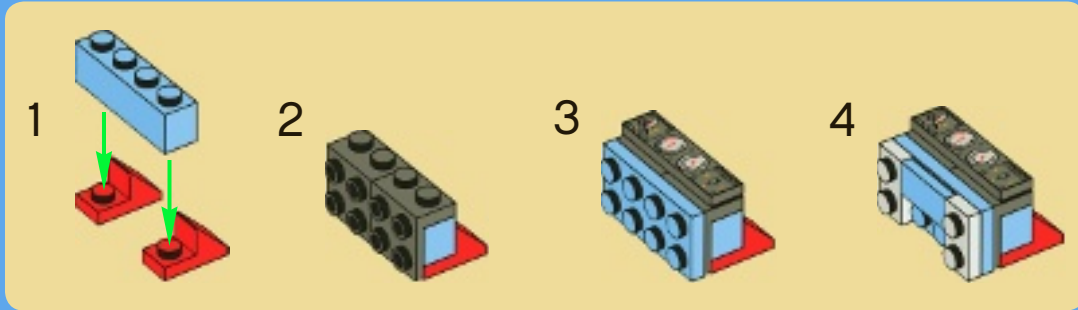

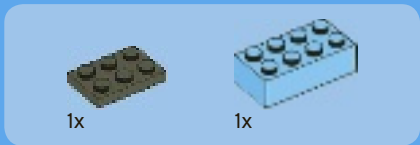

1



2

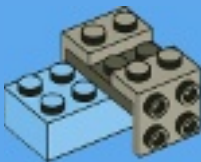

3

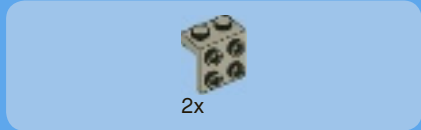
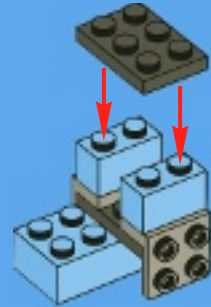

4

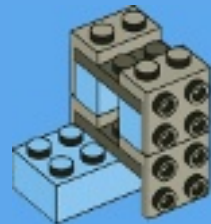



5

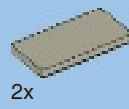
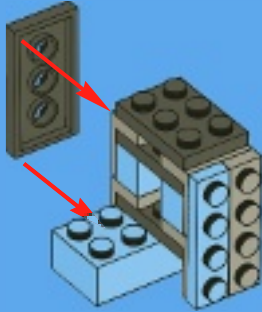

6

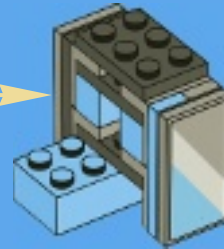
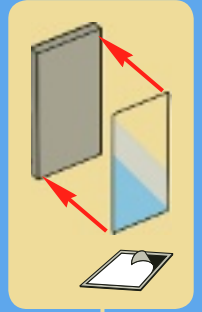
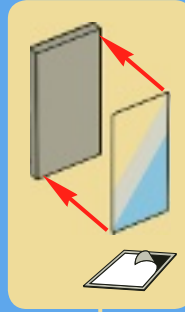

19

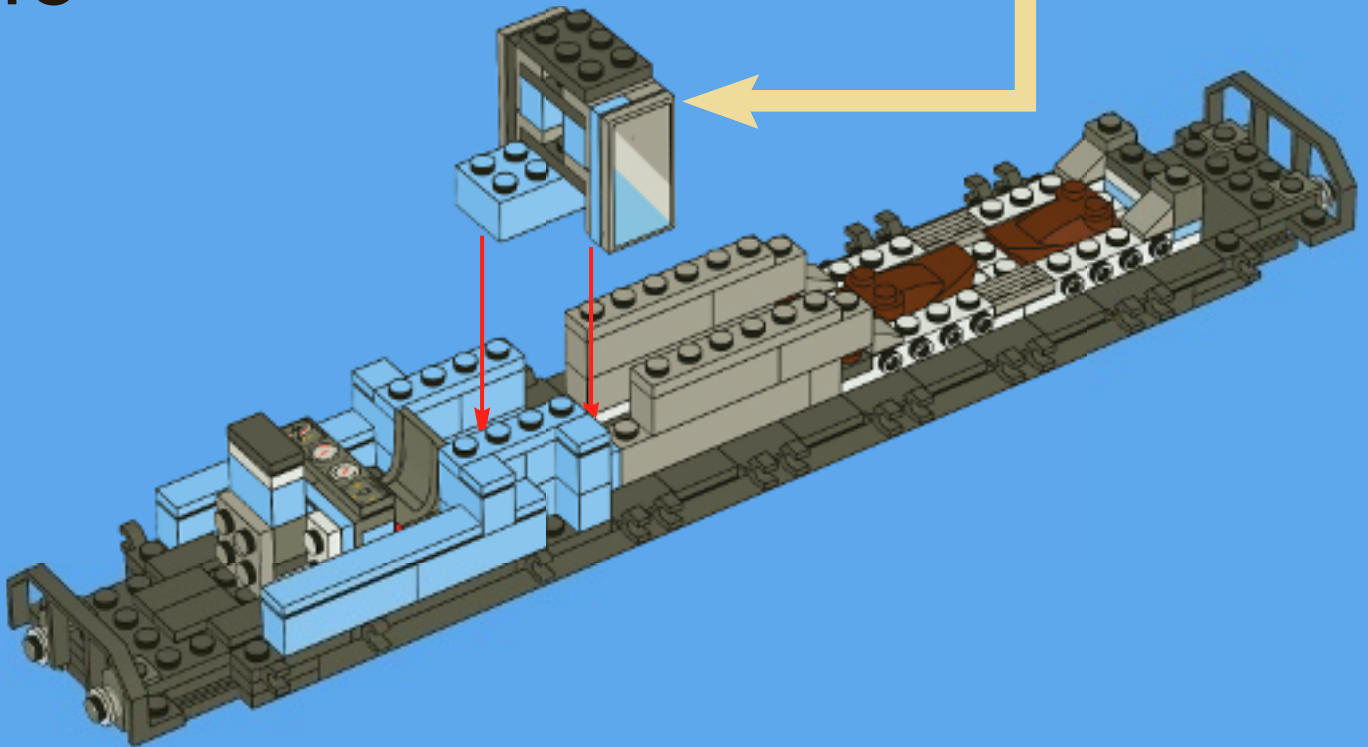

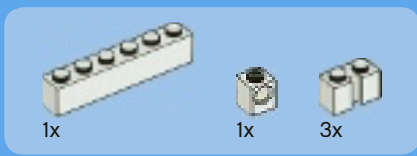

20

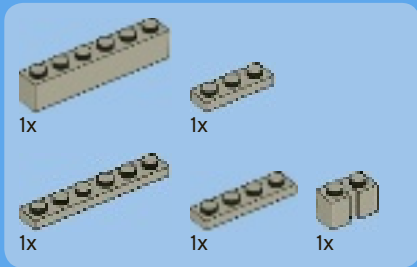
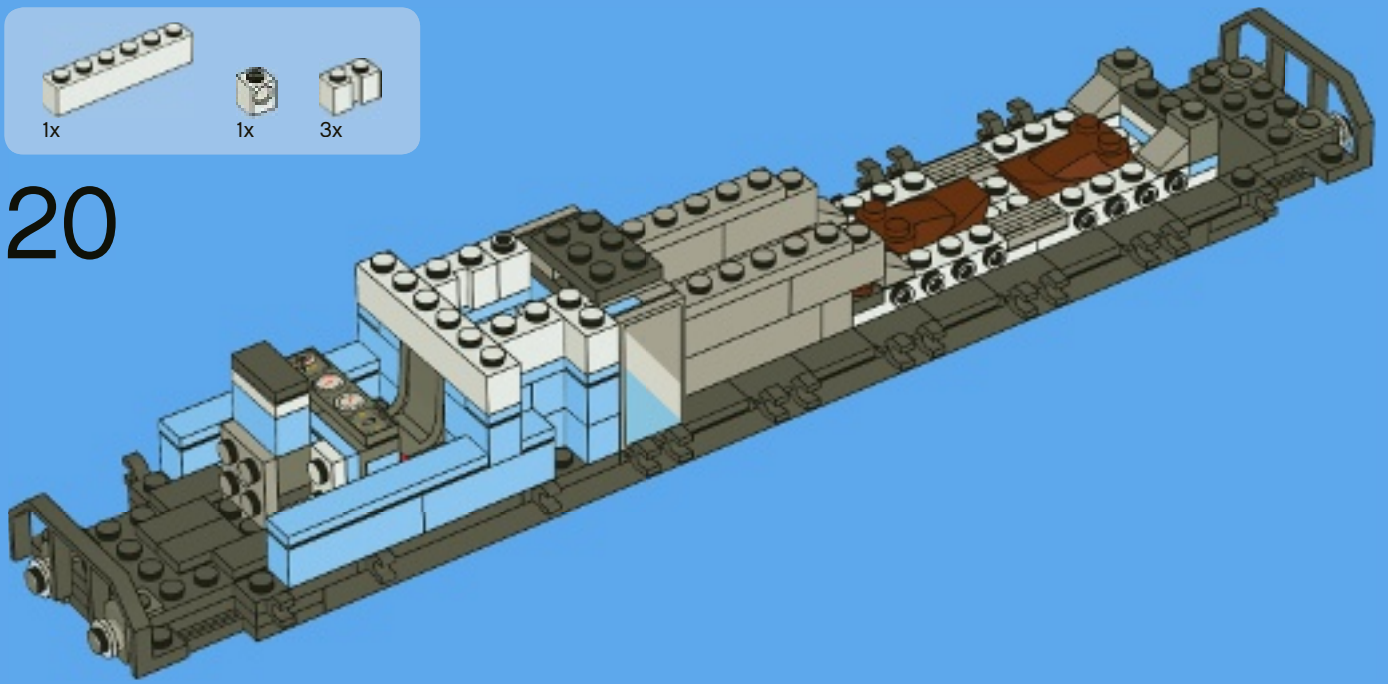

21

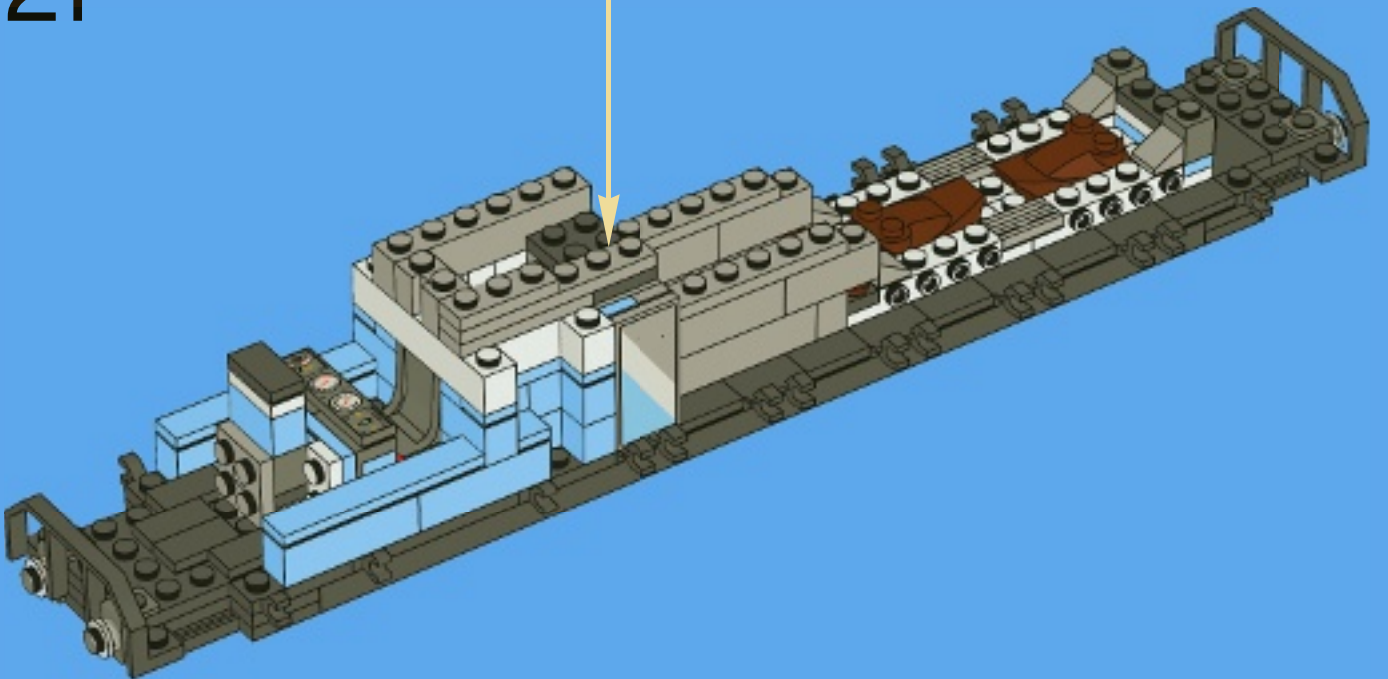
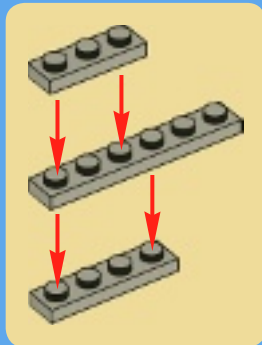



22

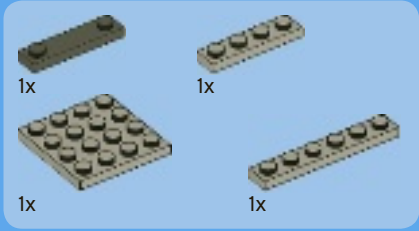
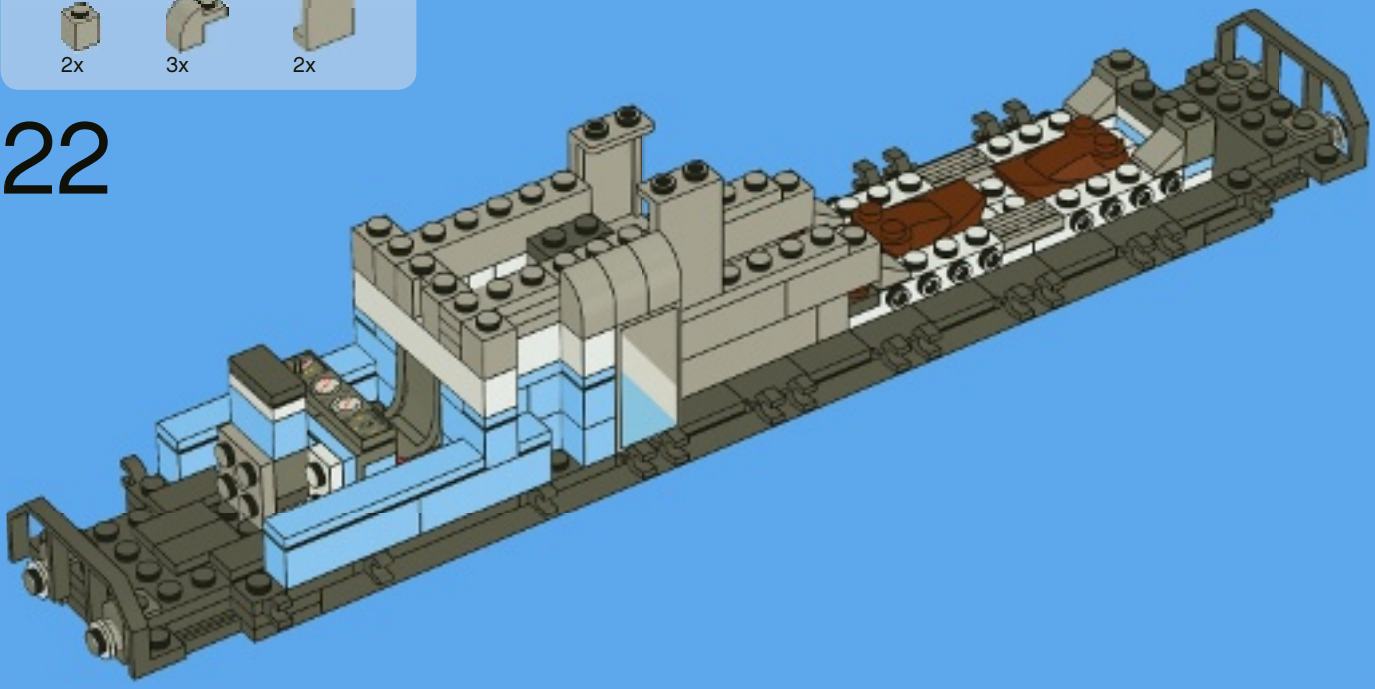

23

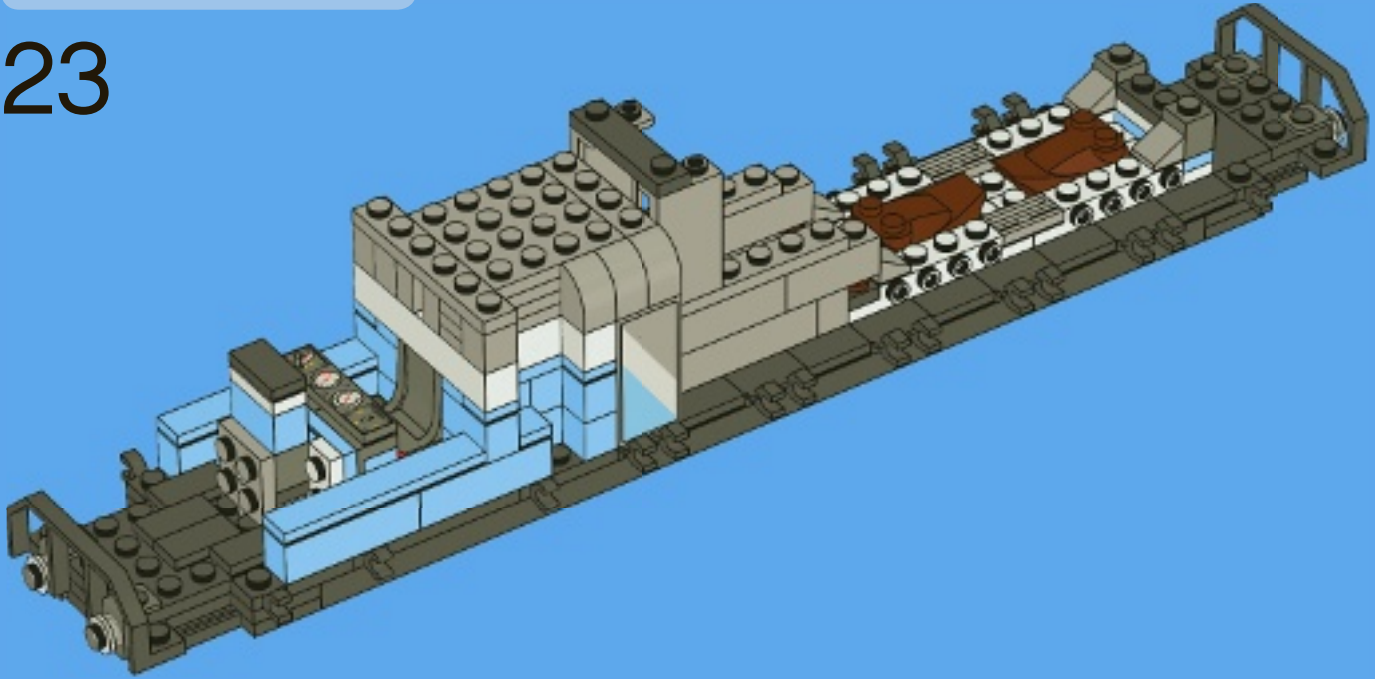



1x



1x

24

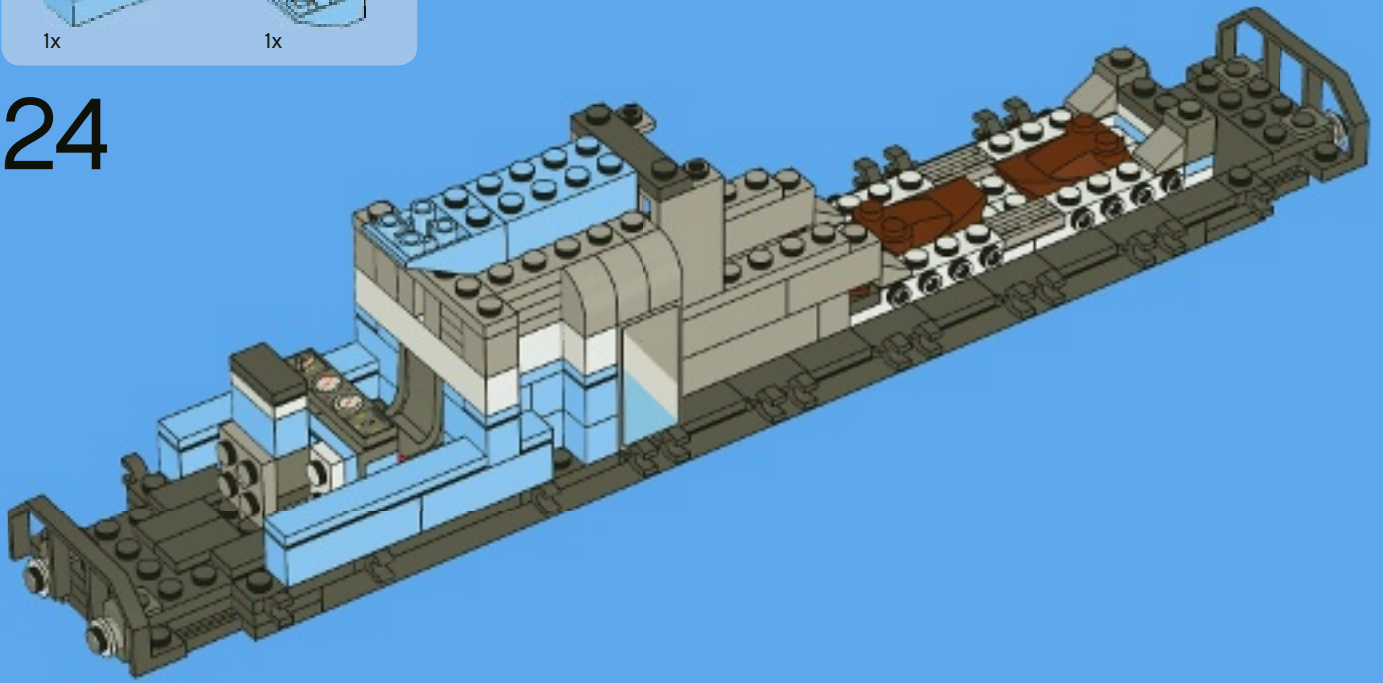

4x



2x



2x

25

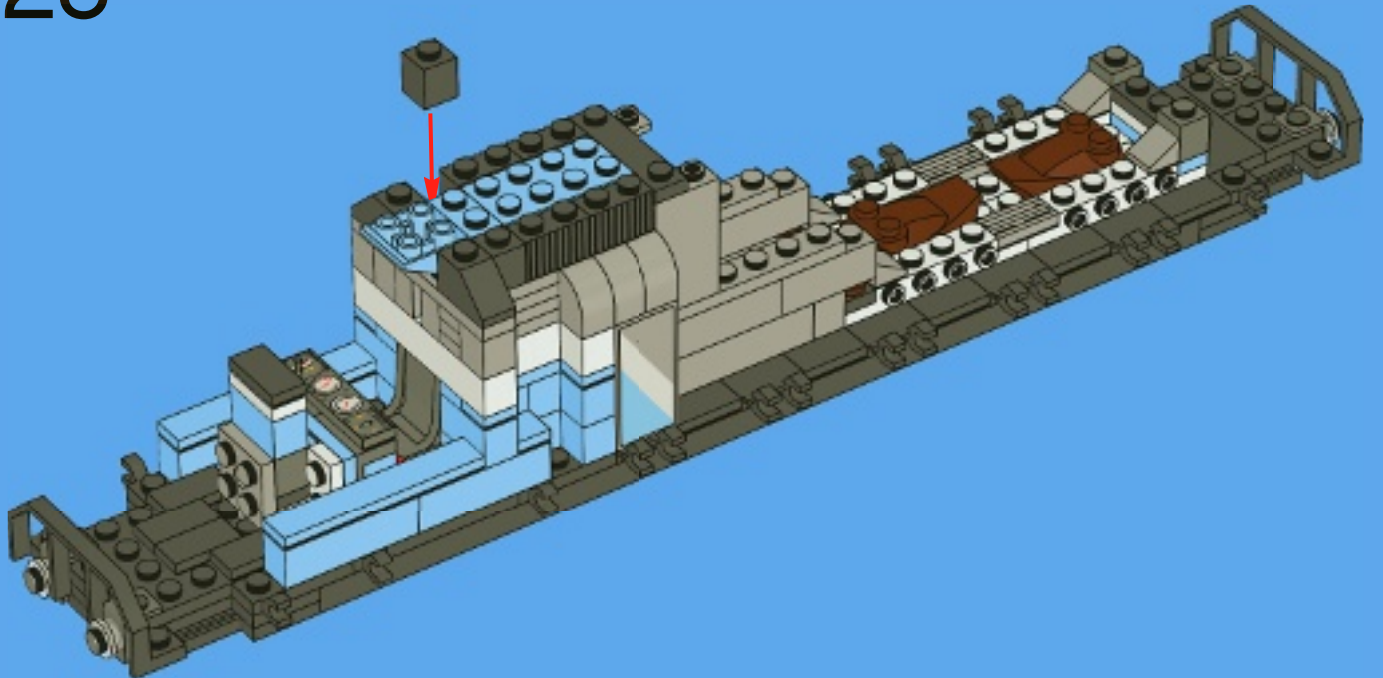

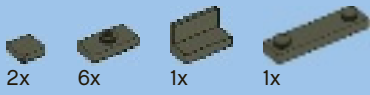

26

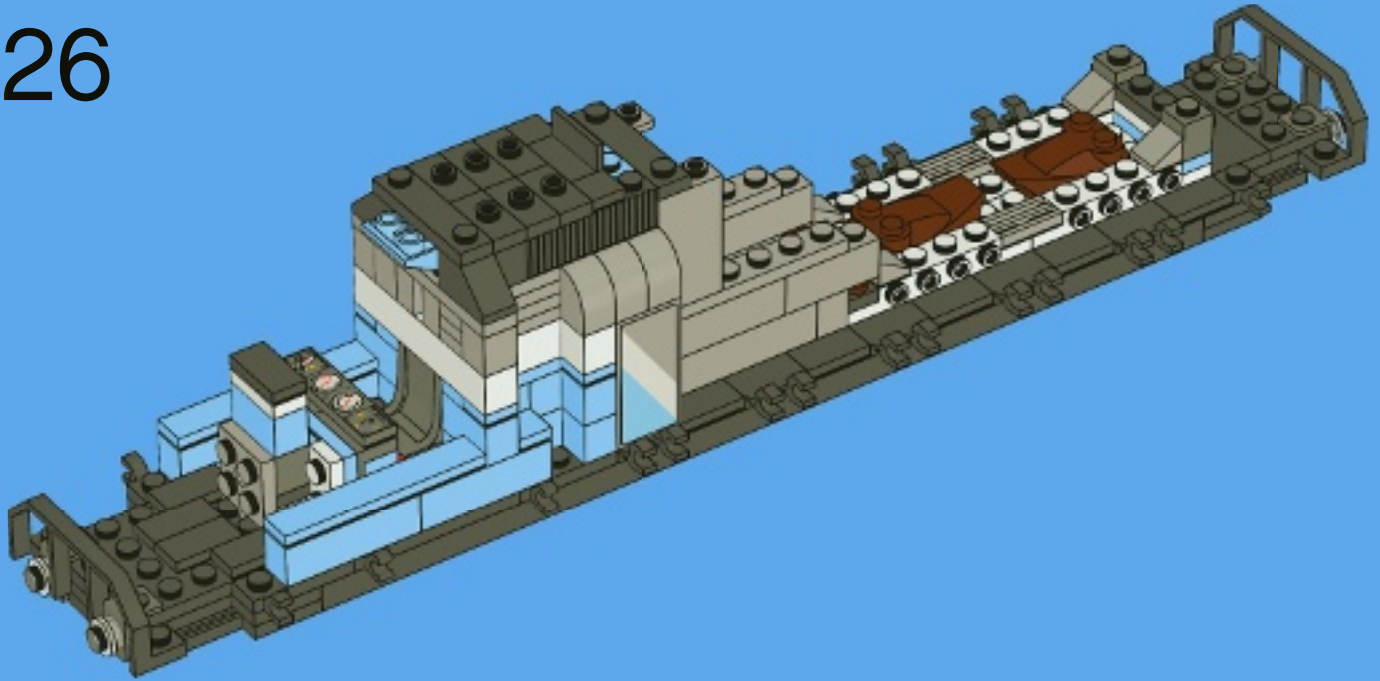

27

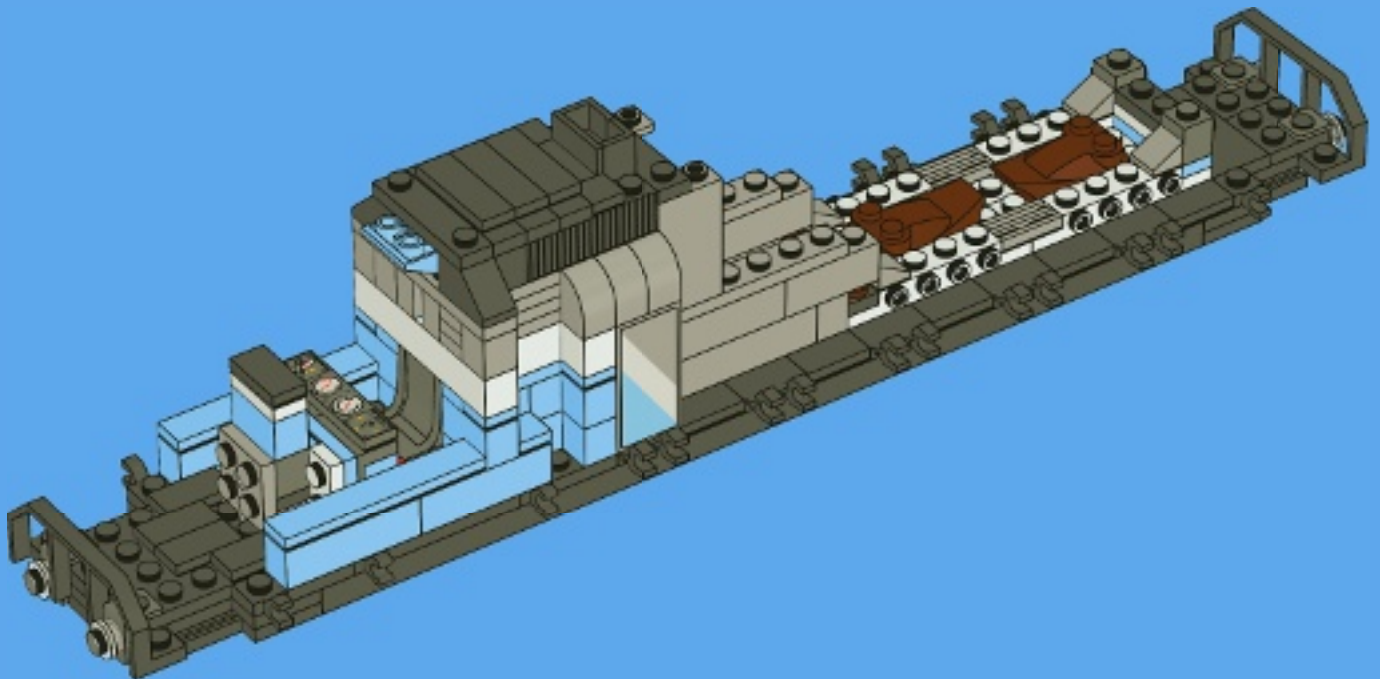



28

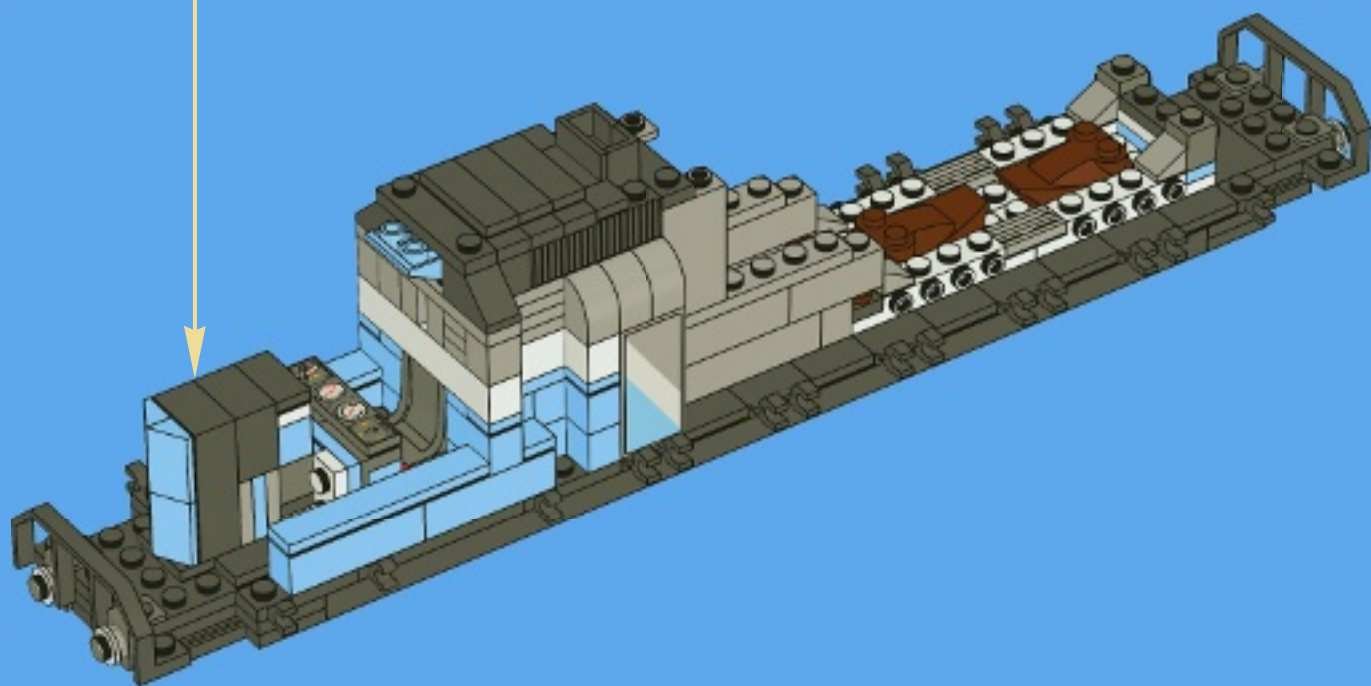
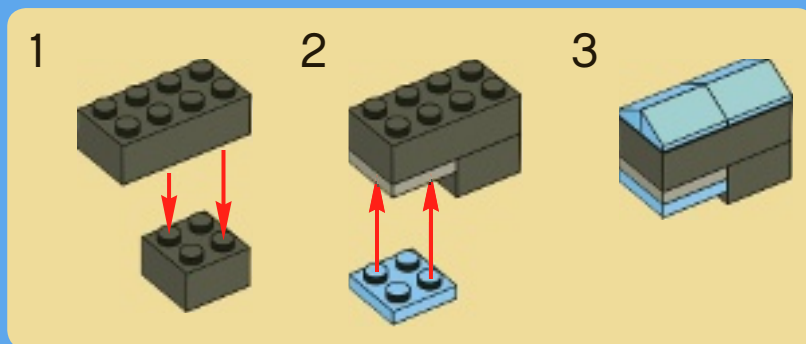

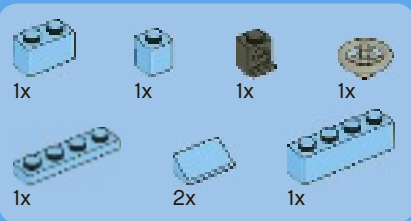

29

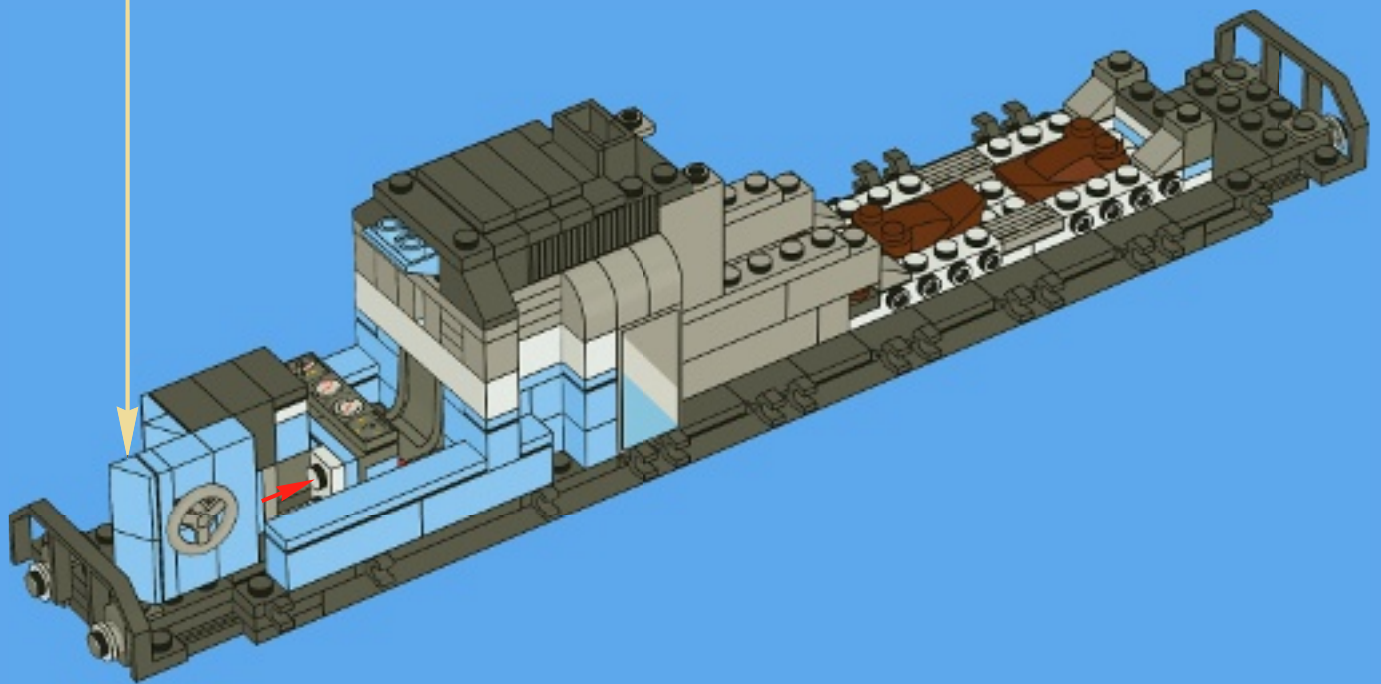
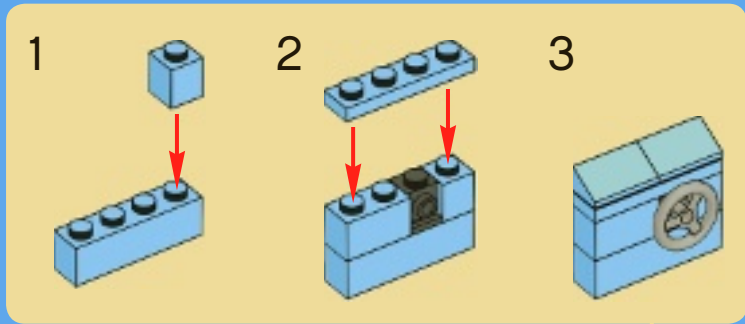

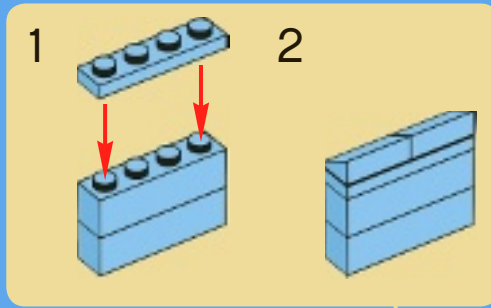
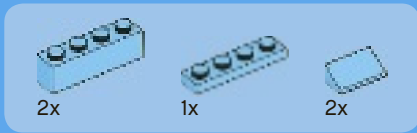

30

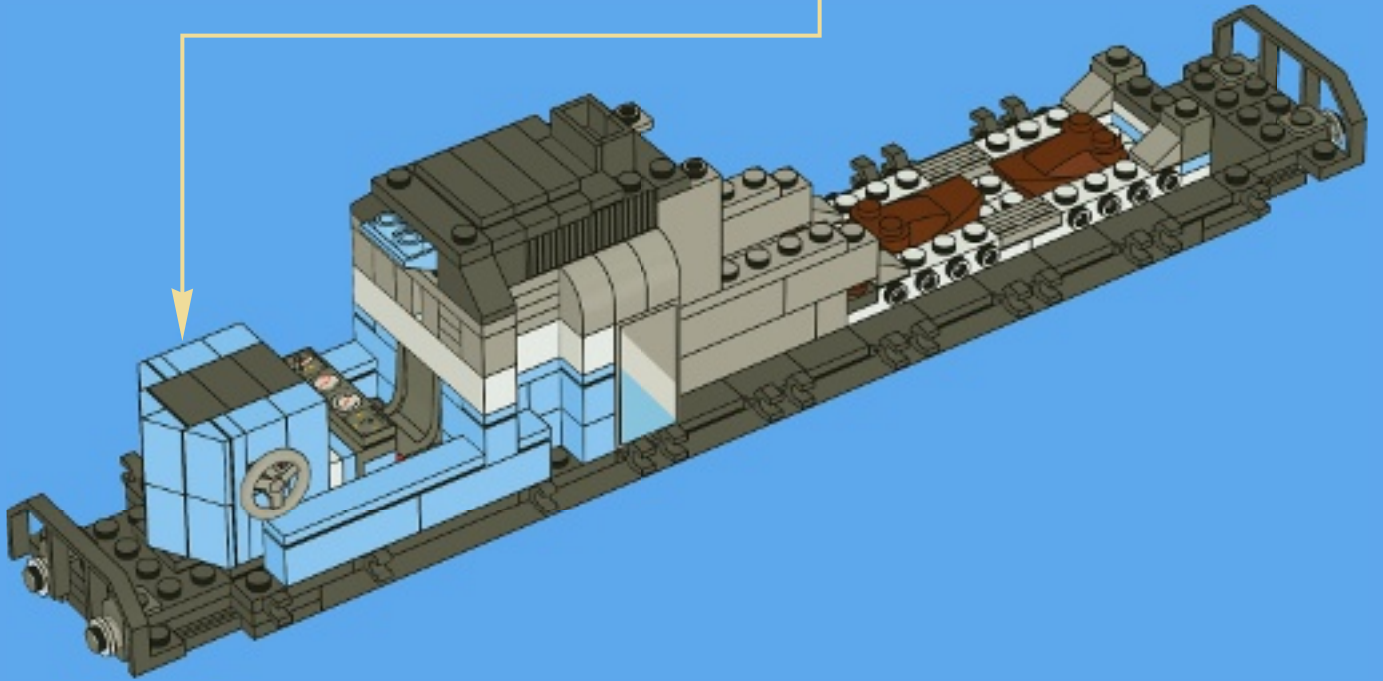

31

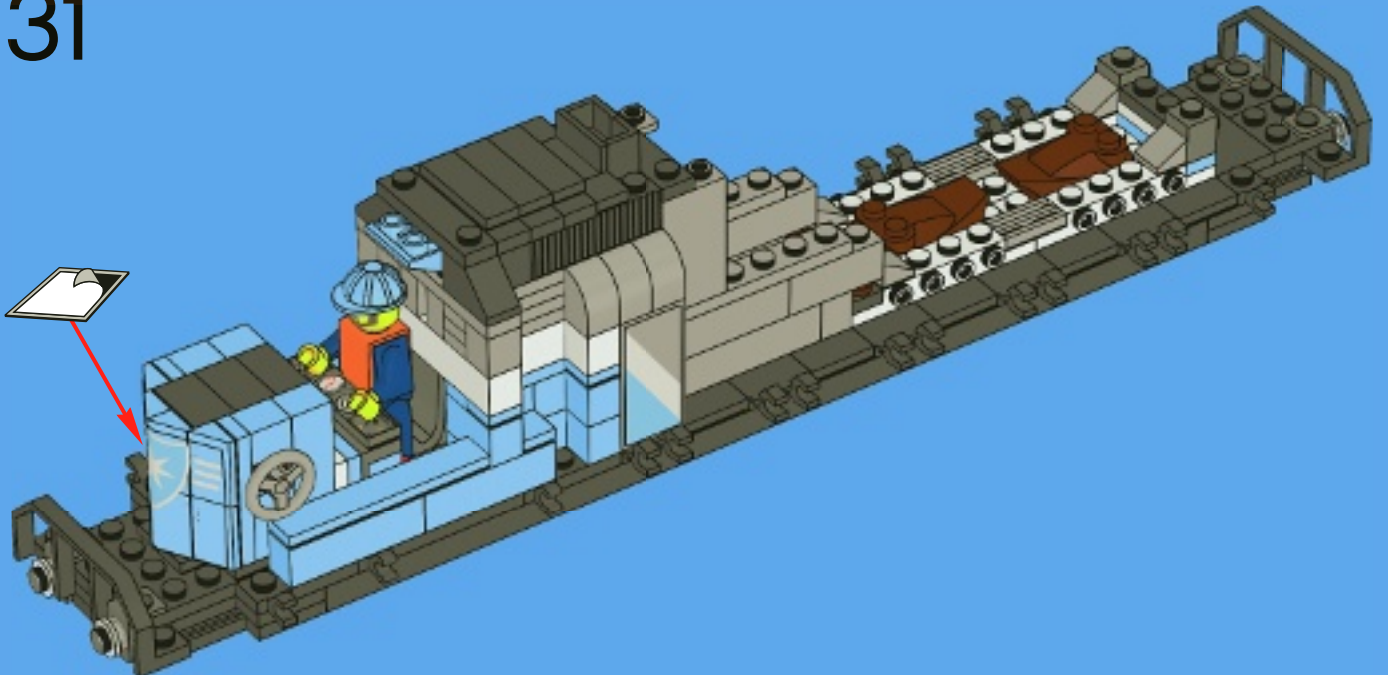

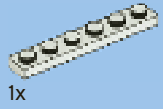

1x



1x

1

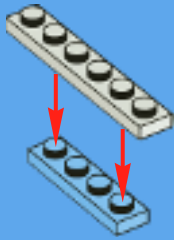

2x

2

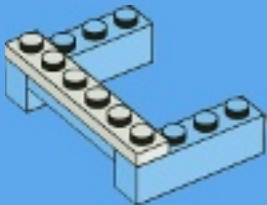

2x

3

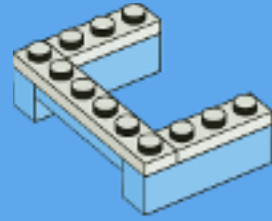

6x

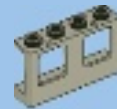

3x

4

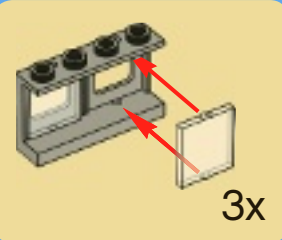

3x

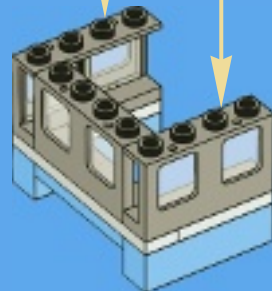



5

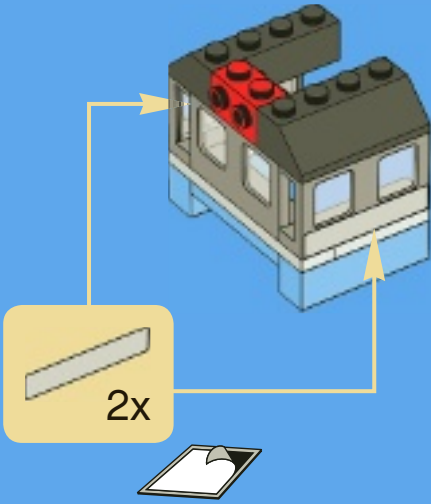

2x

1x

6

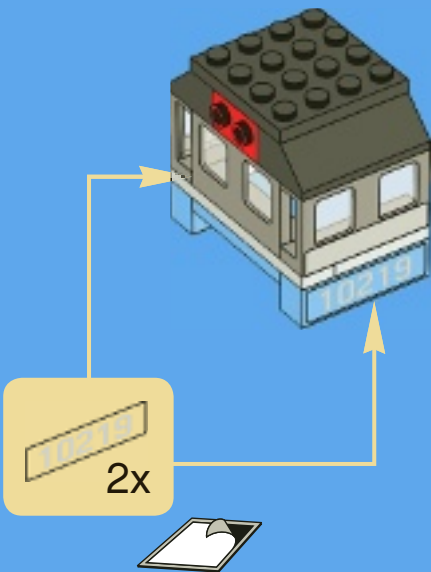

2x

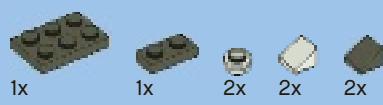

7

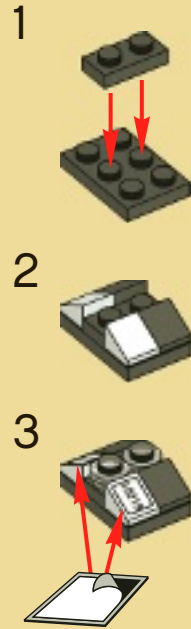

1

2

3

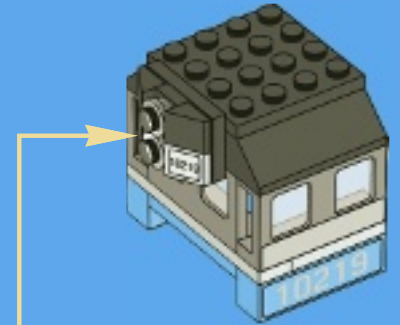

2x

2x

8

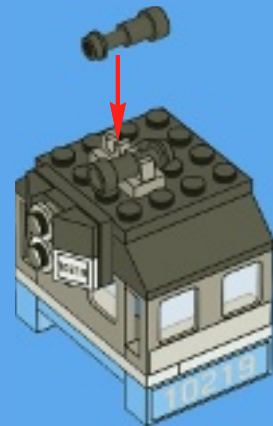

32

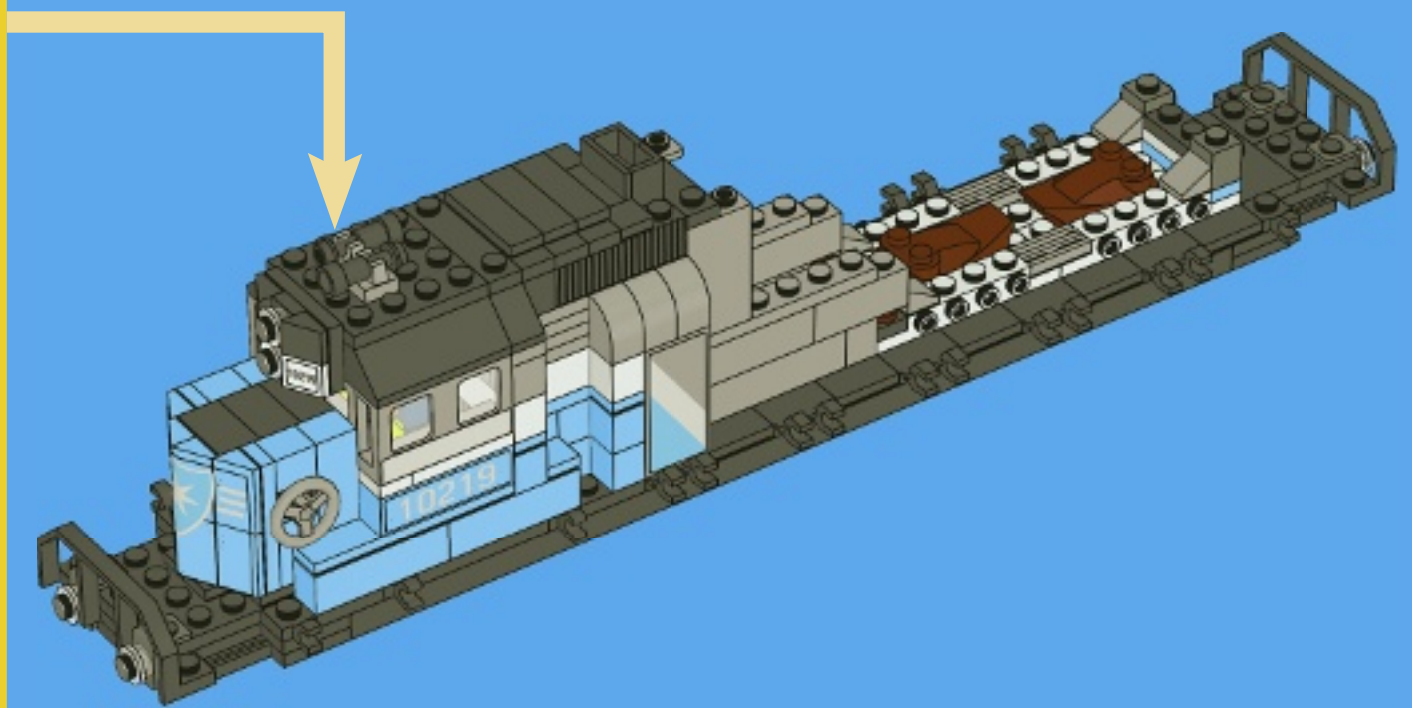

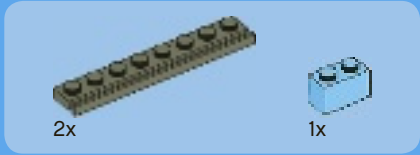
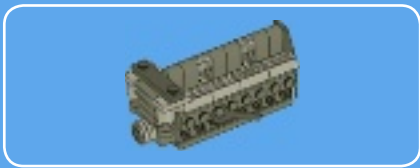

1

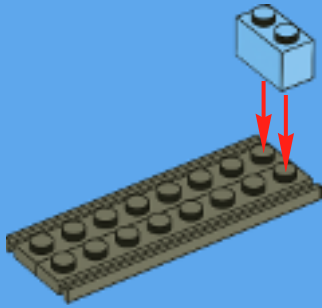

2

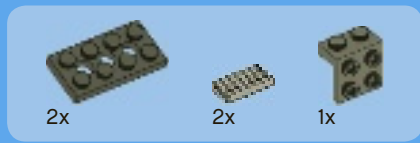
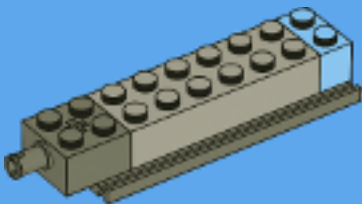

3

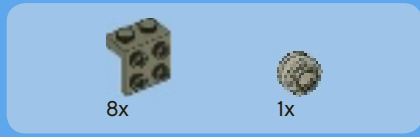
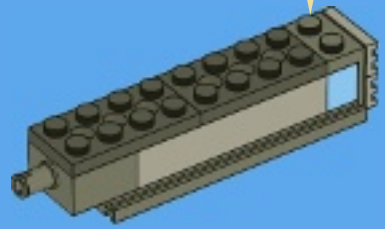
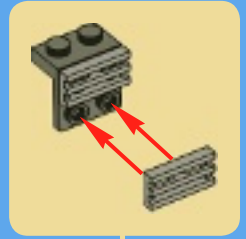

4

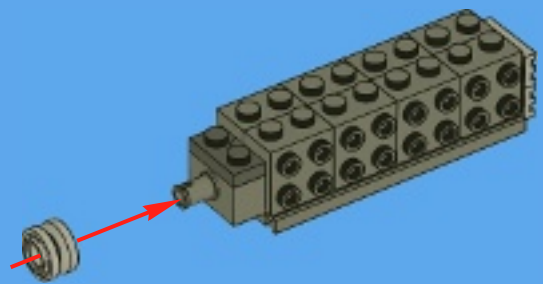



5

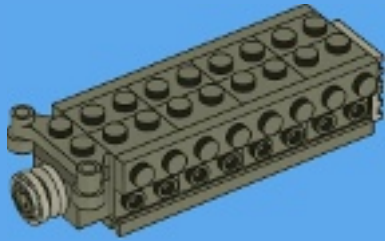

7

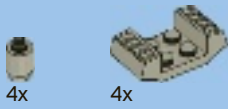
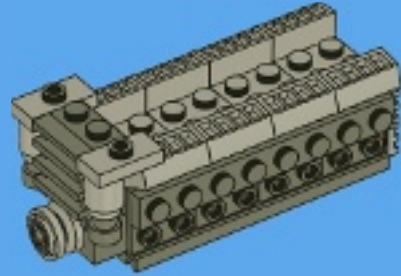

6

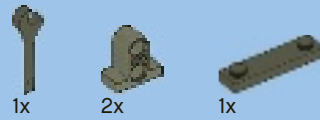
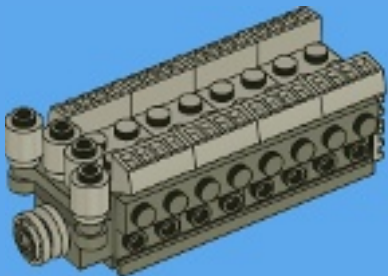

8

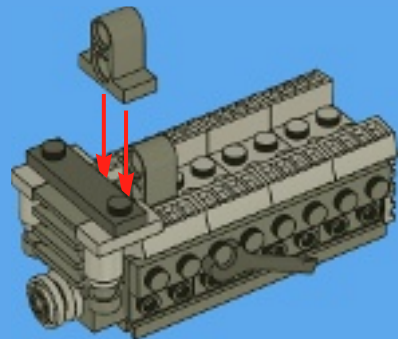



2x



4x



1x

9

1



2

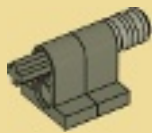

3

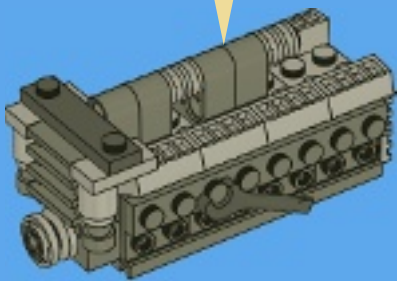
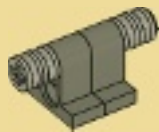

1x

10

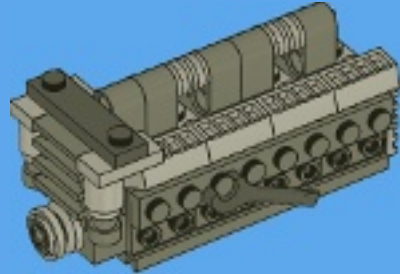

1x



2x



1x

11

1

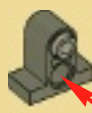

2

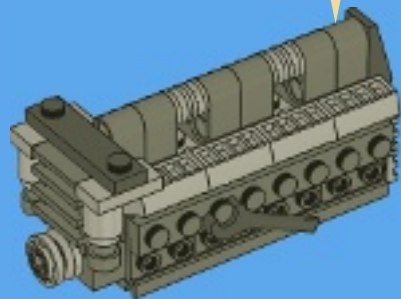

33

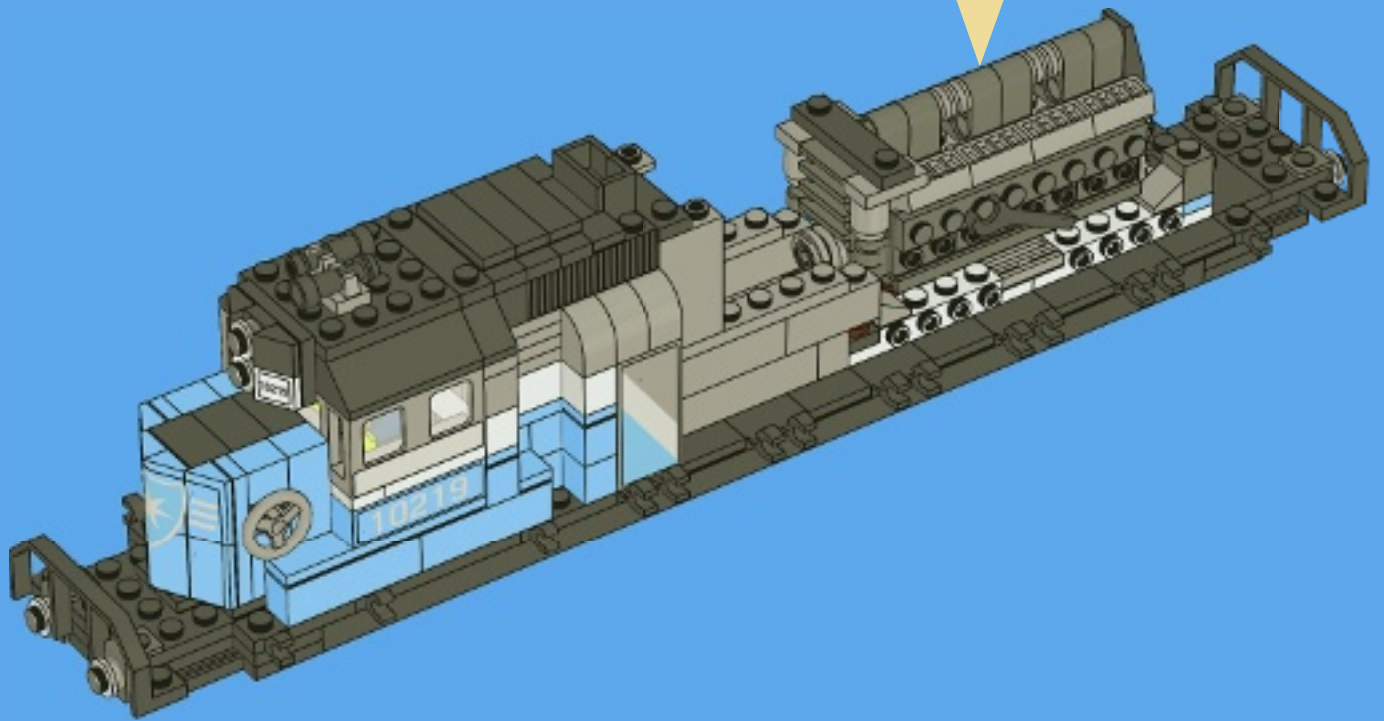

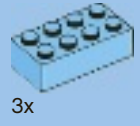
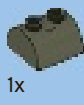

2x

1x

3x

34

1

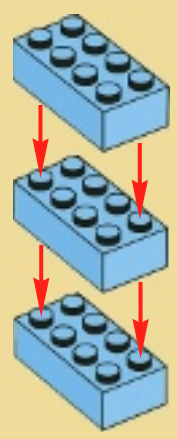

2

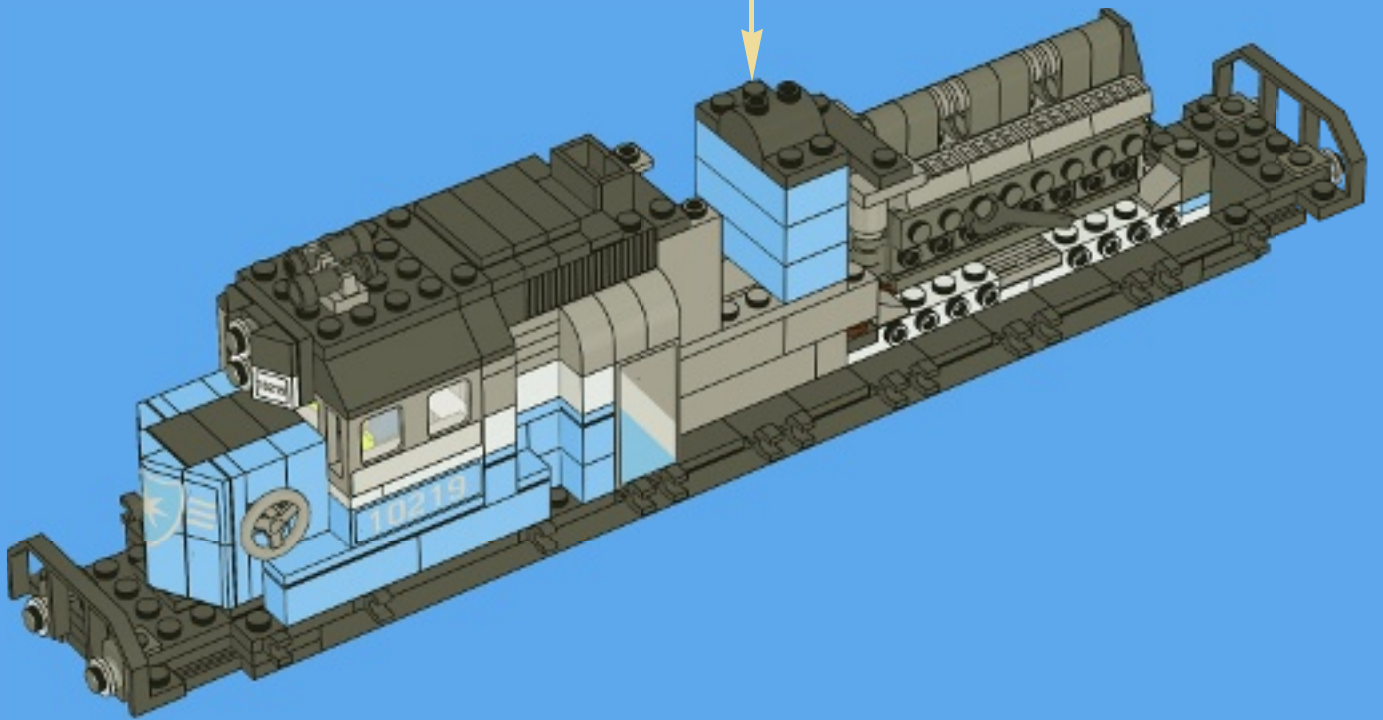
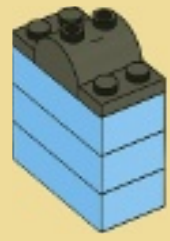



2x



3x

35

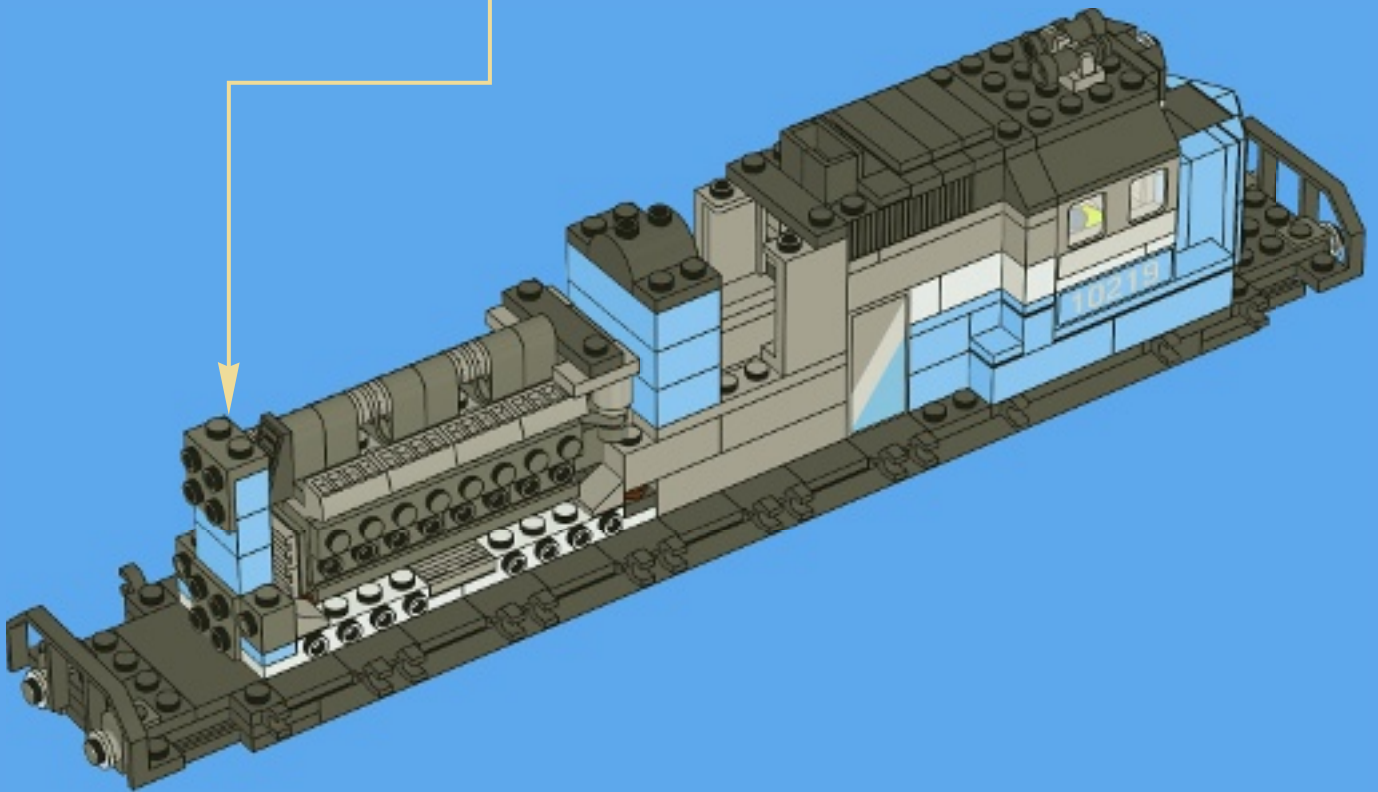
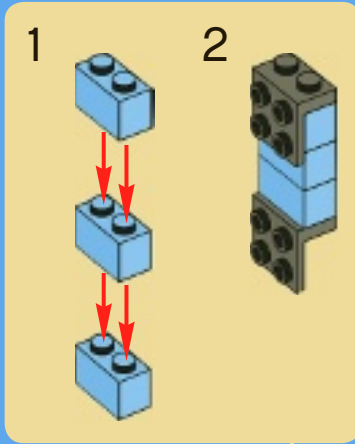



4x



4x

36

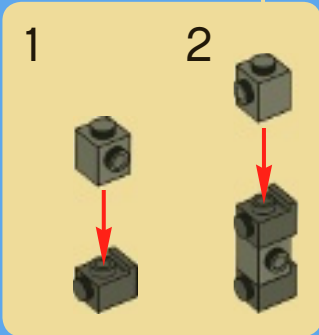
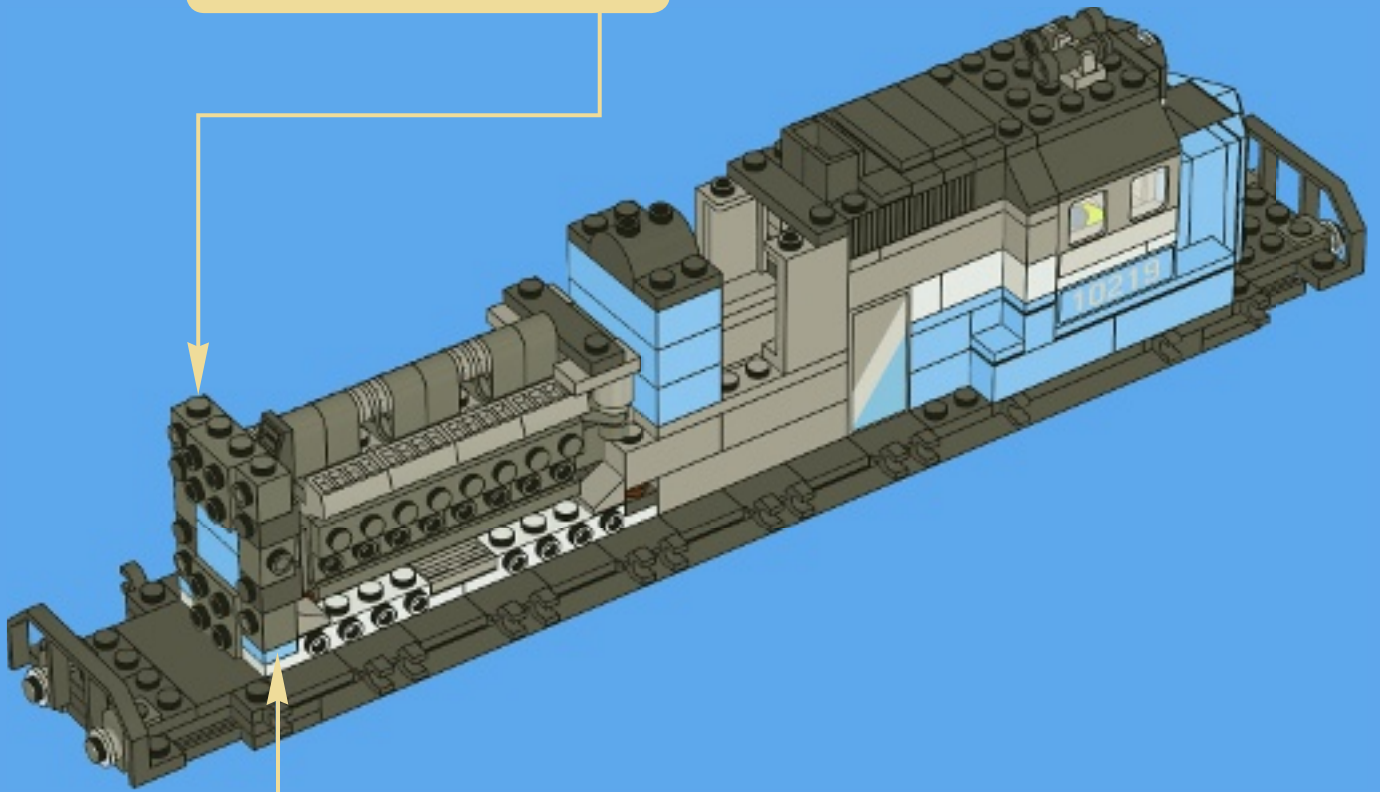
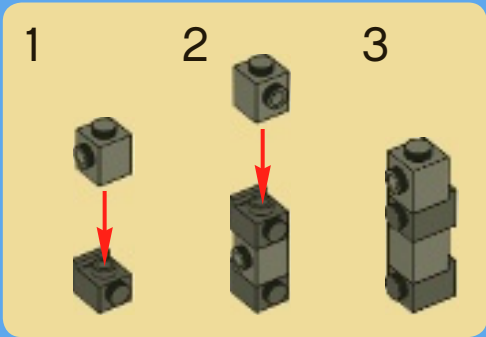



2x



1x

37

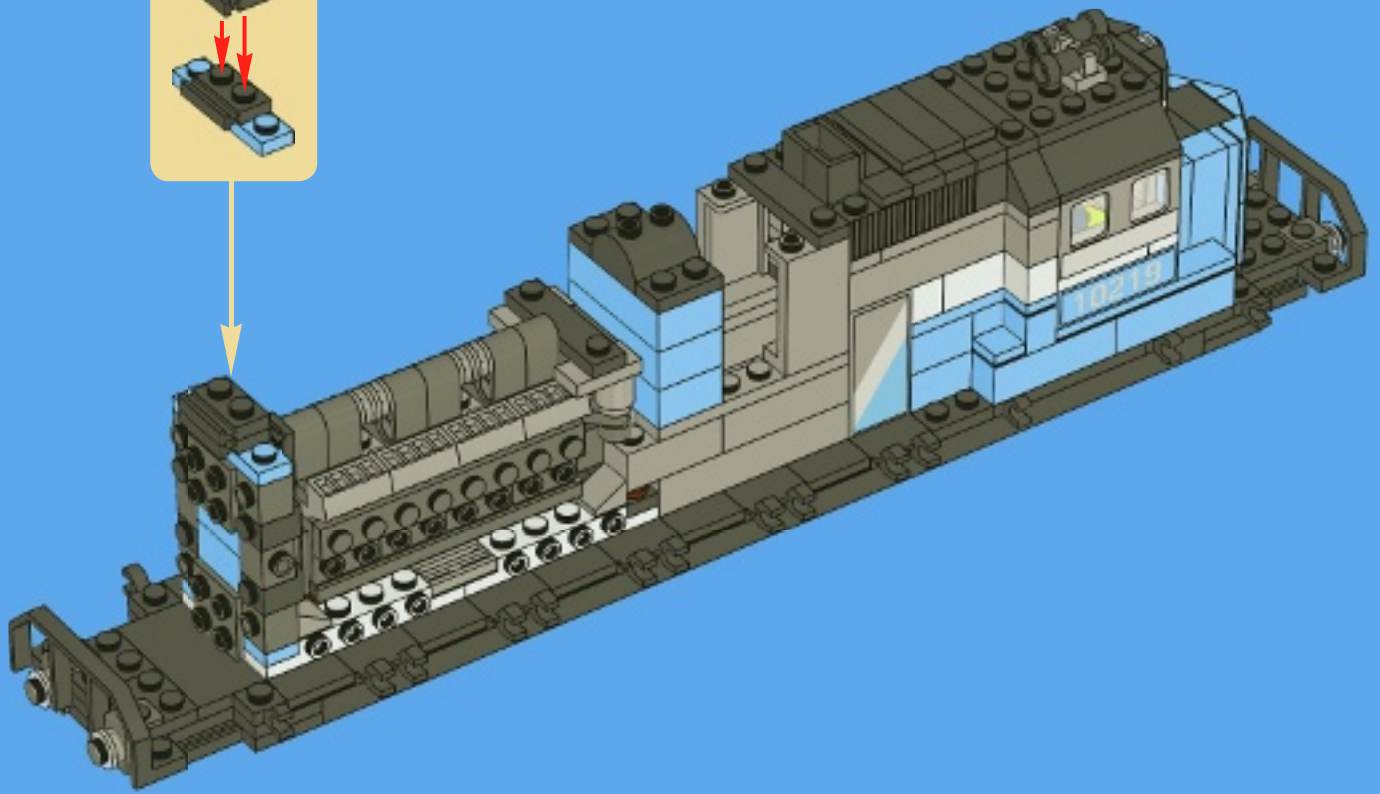
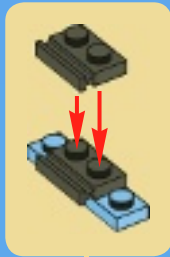

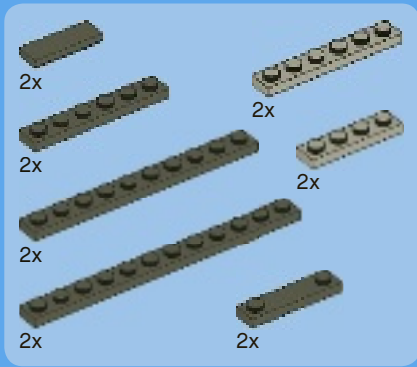

38

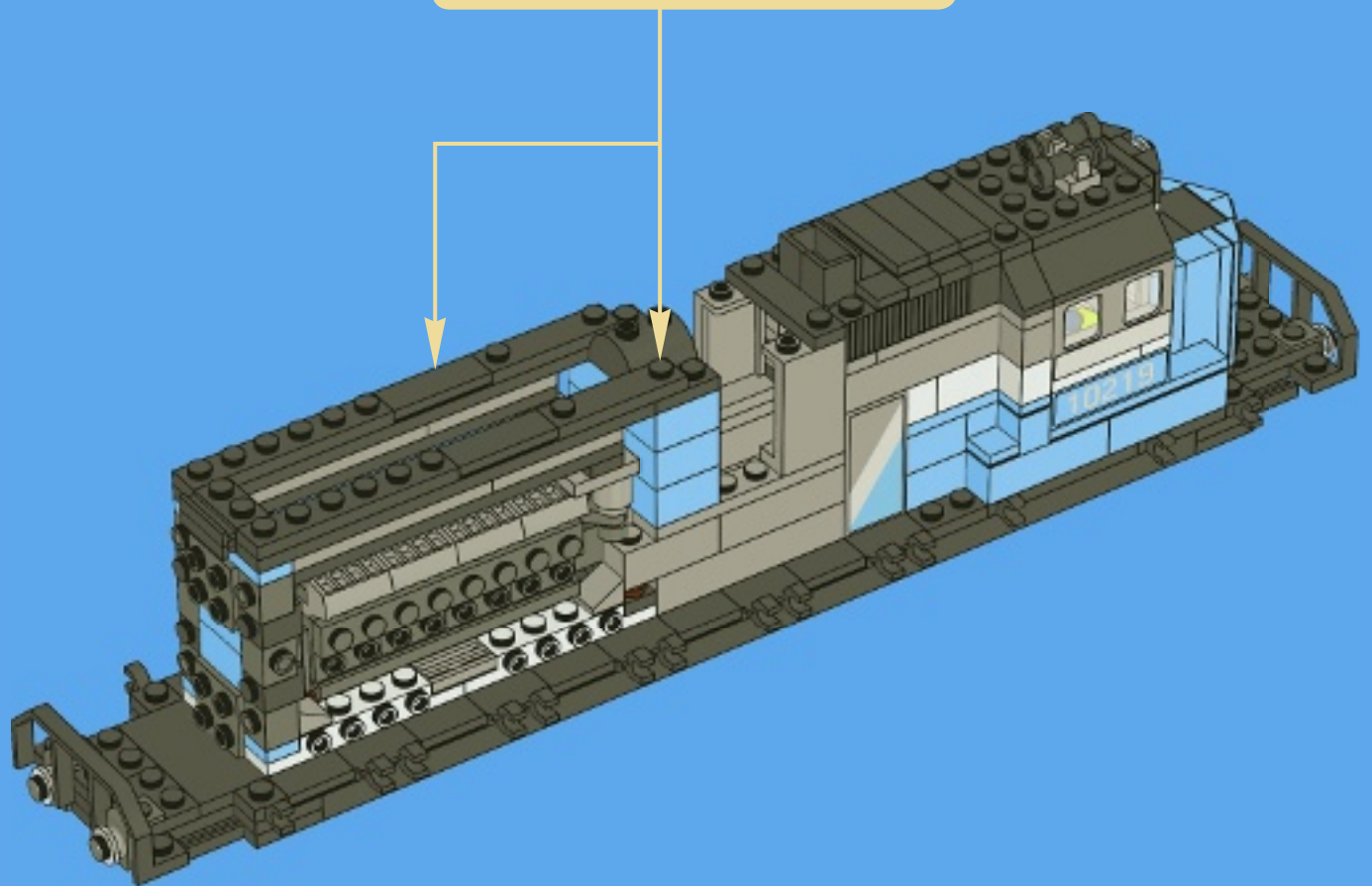
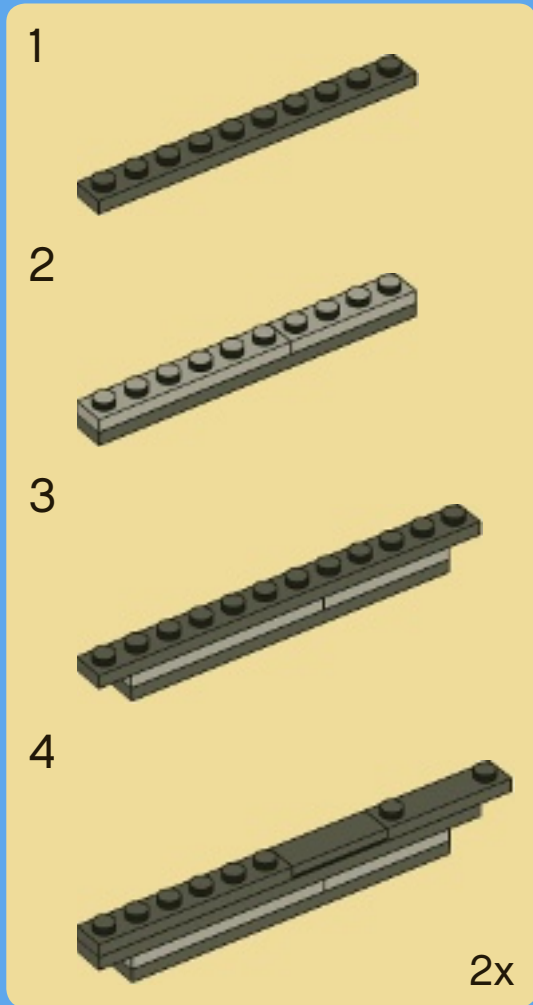

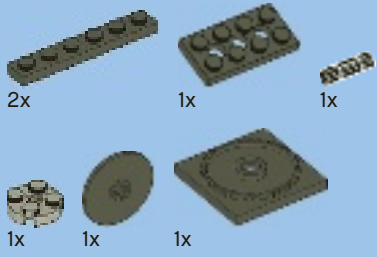

39

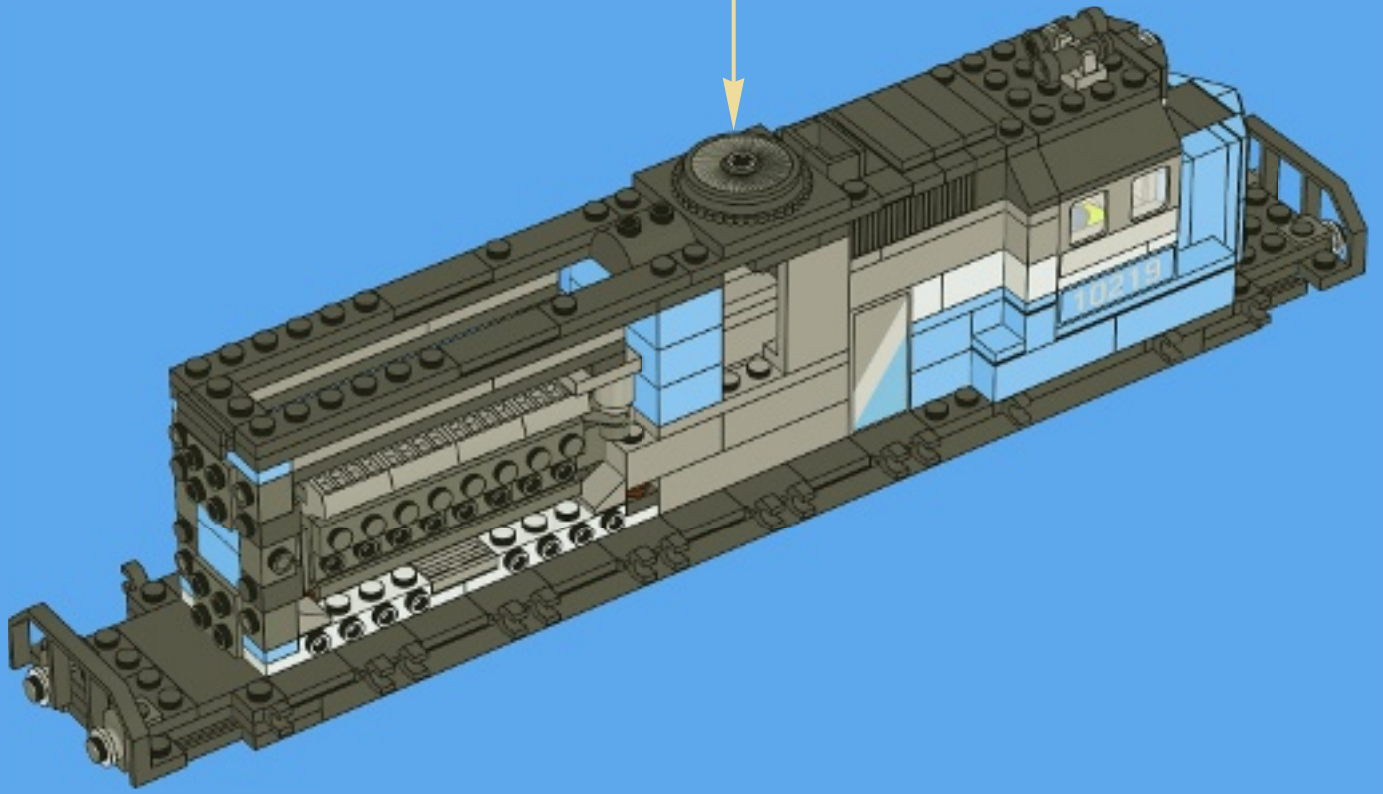
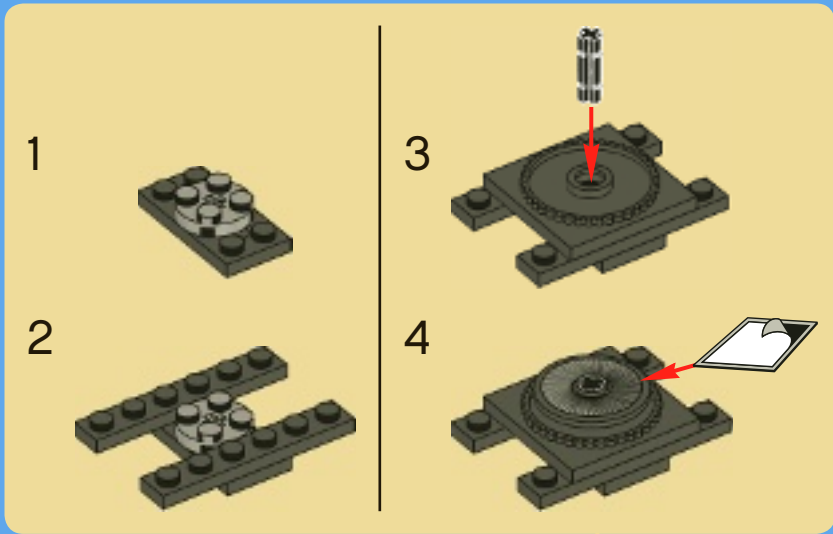

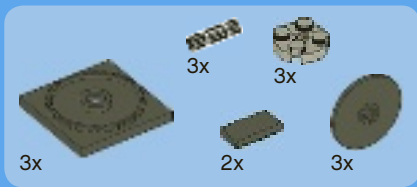

40

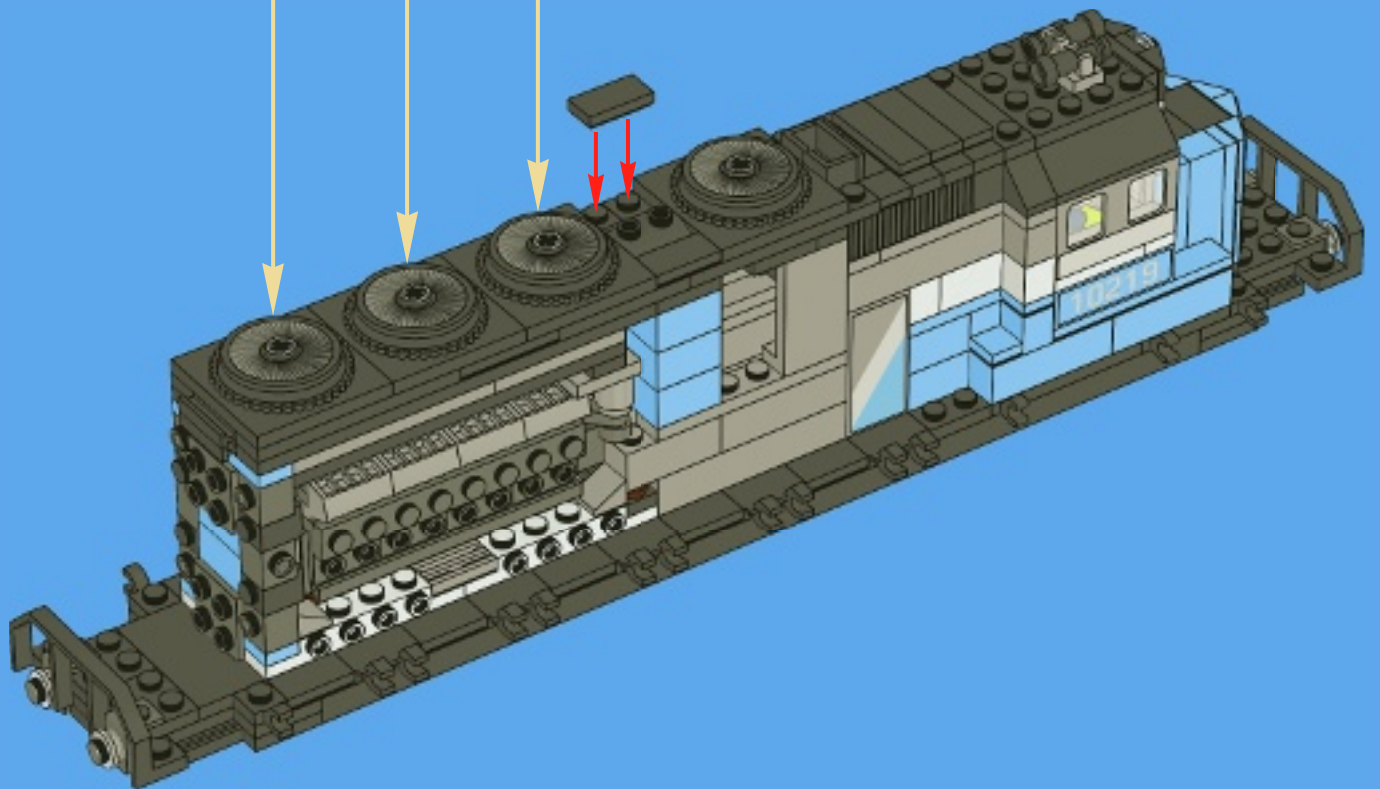
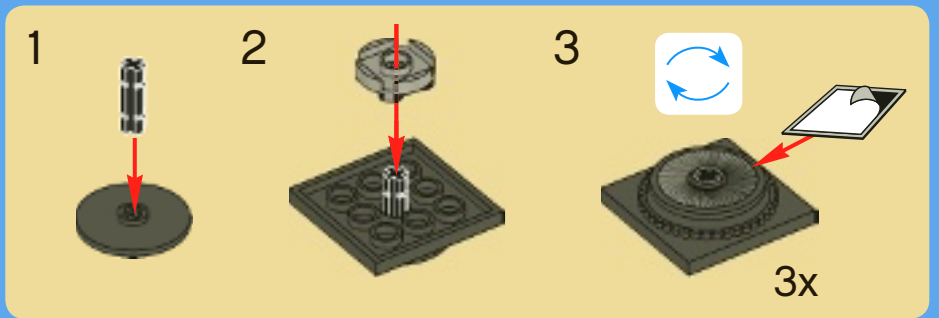

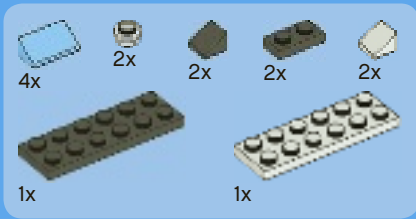

41

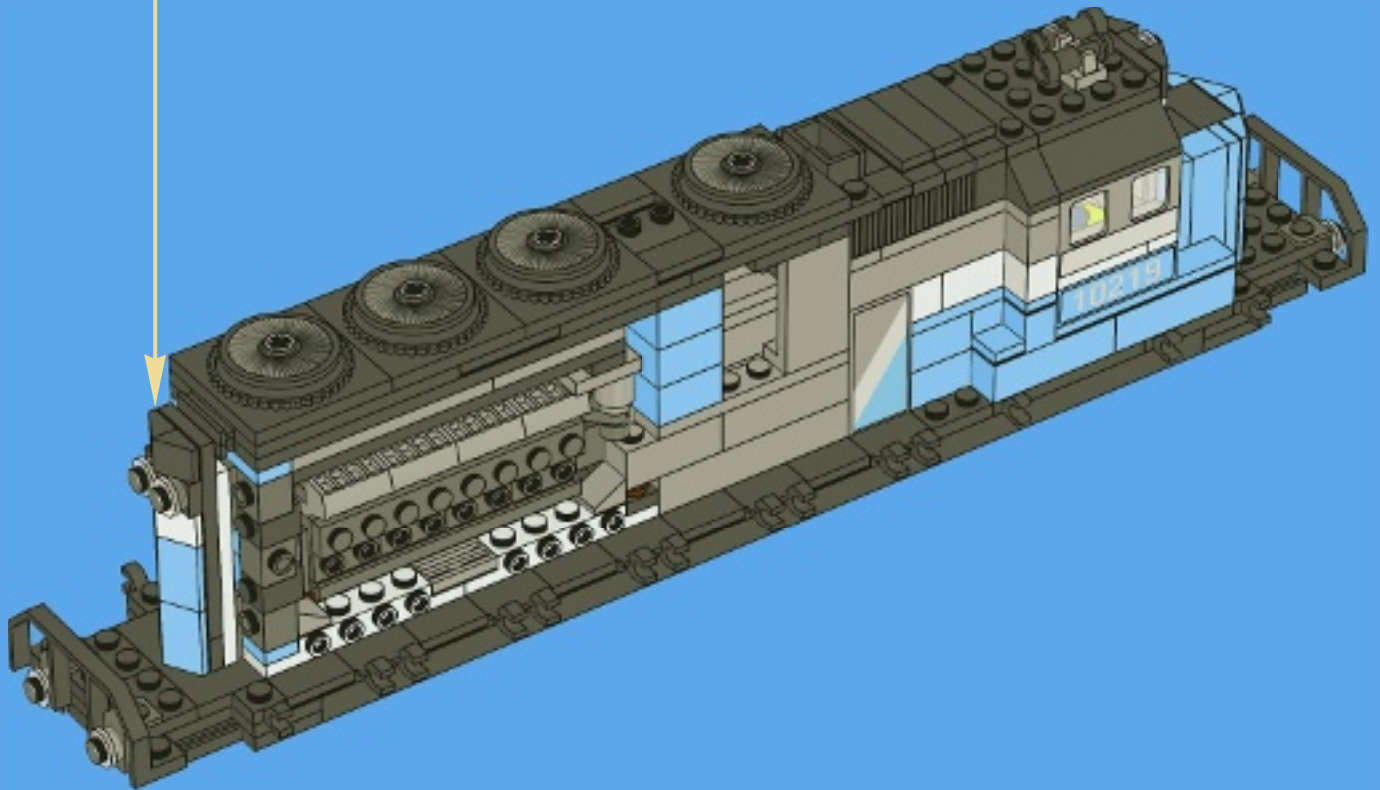
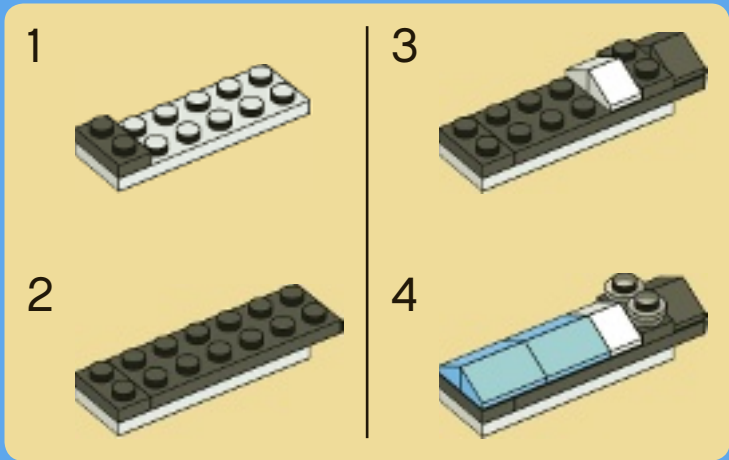



2x



4x

42

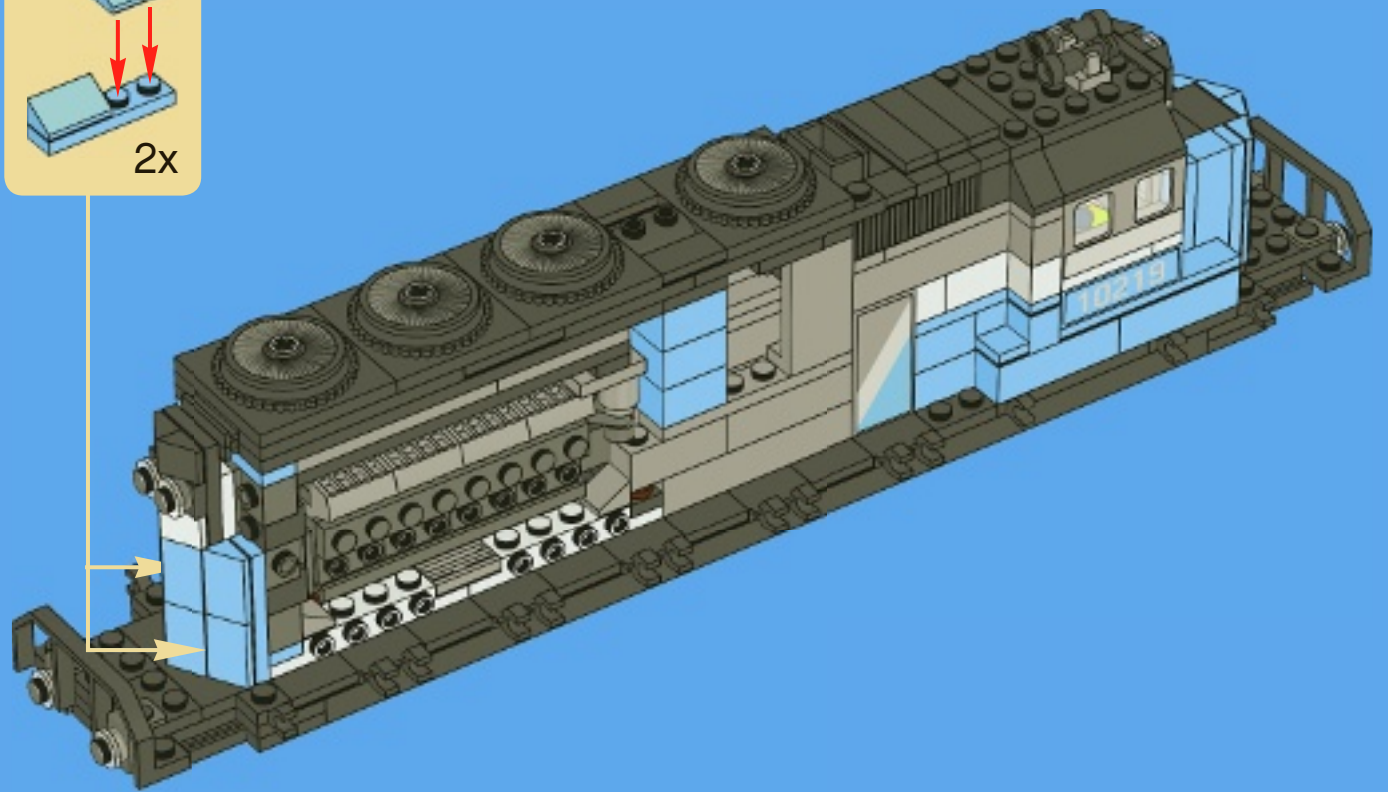
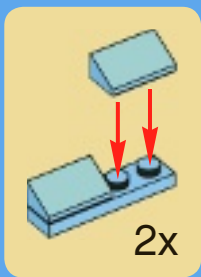



2x



2x



2x

43

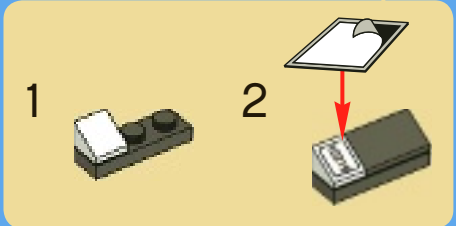
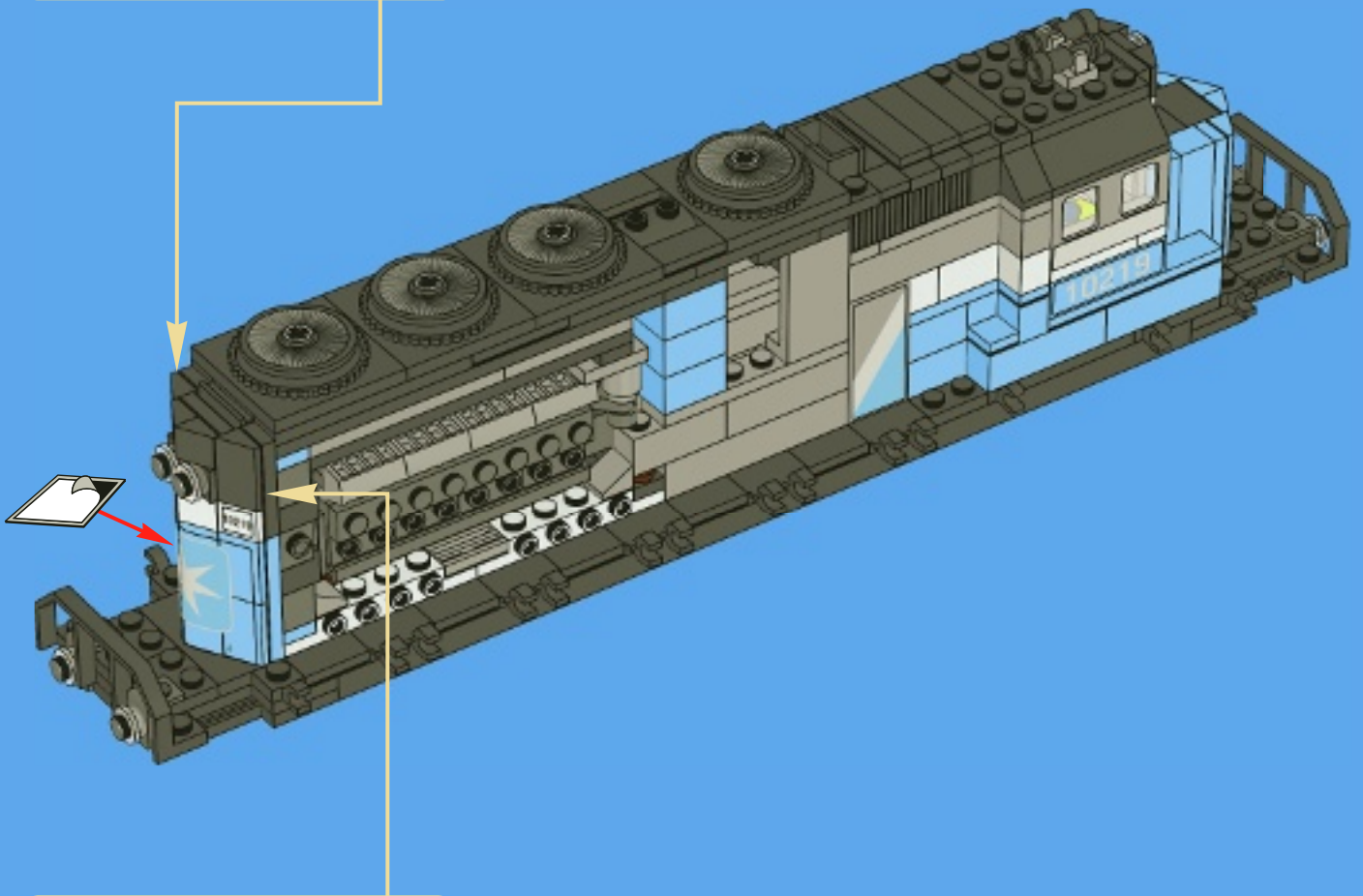
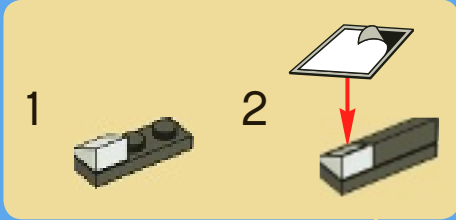

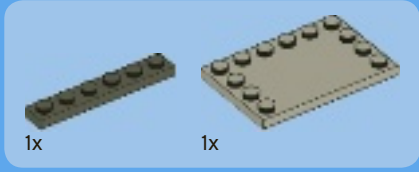
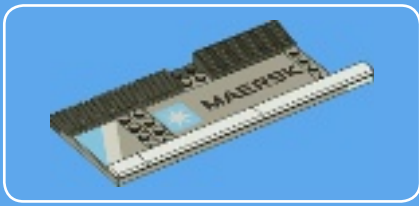

1

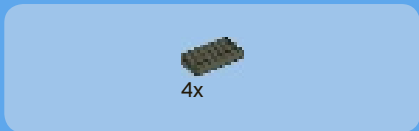

2

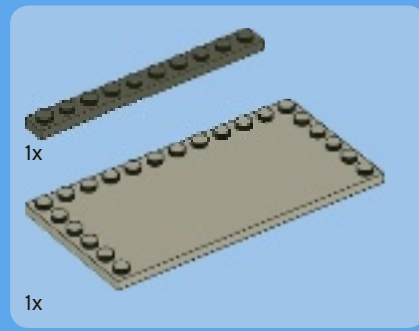

3

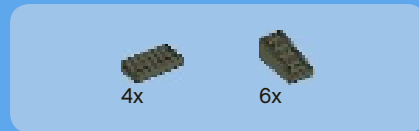
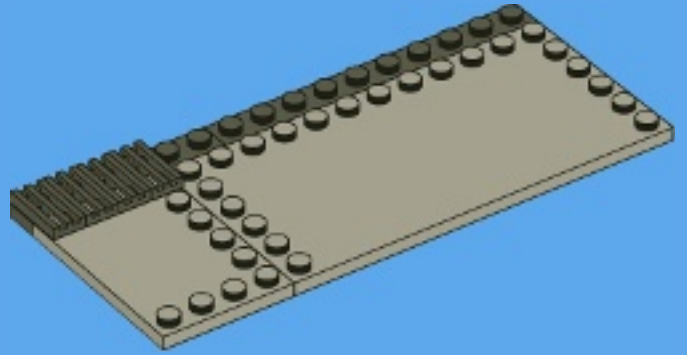

4

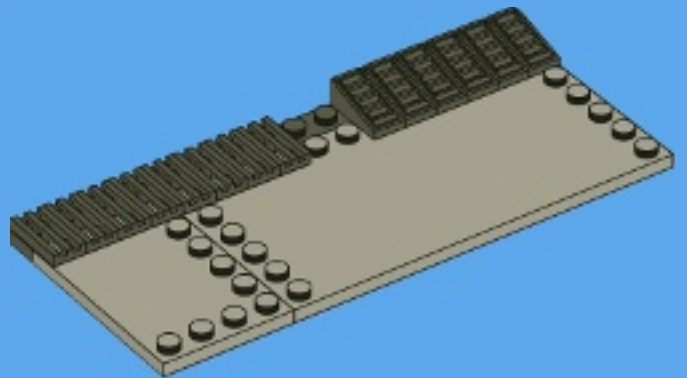

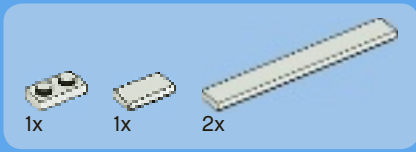

5

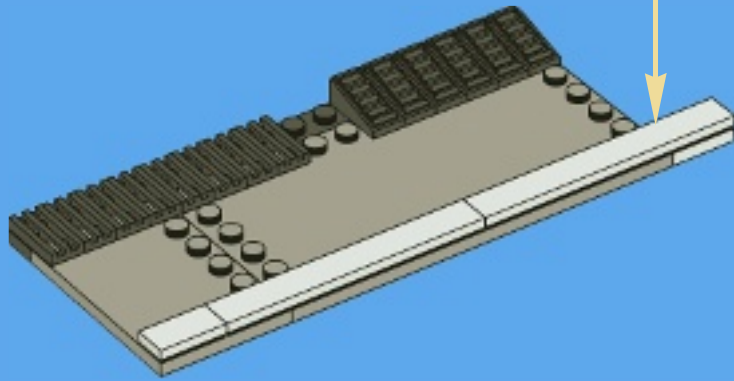
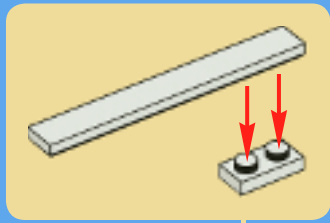

6

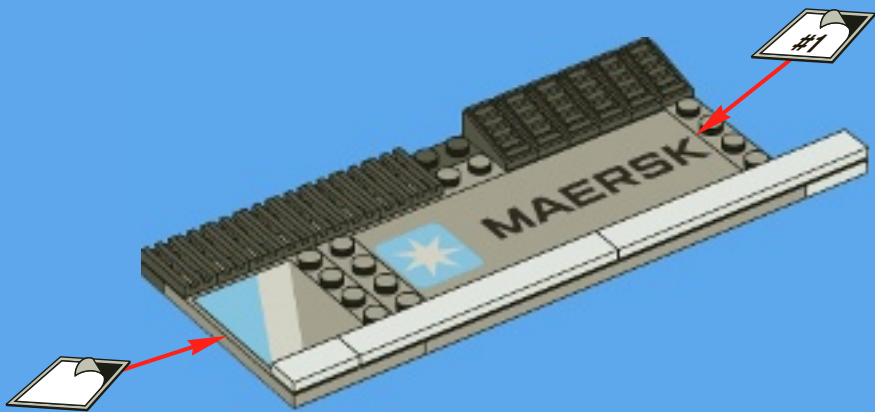

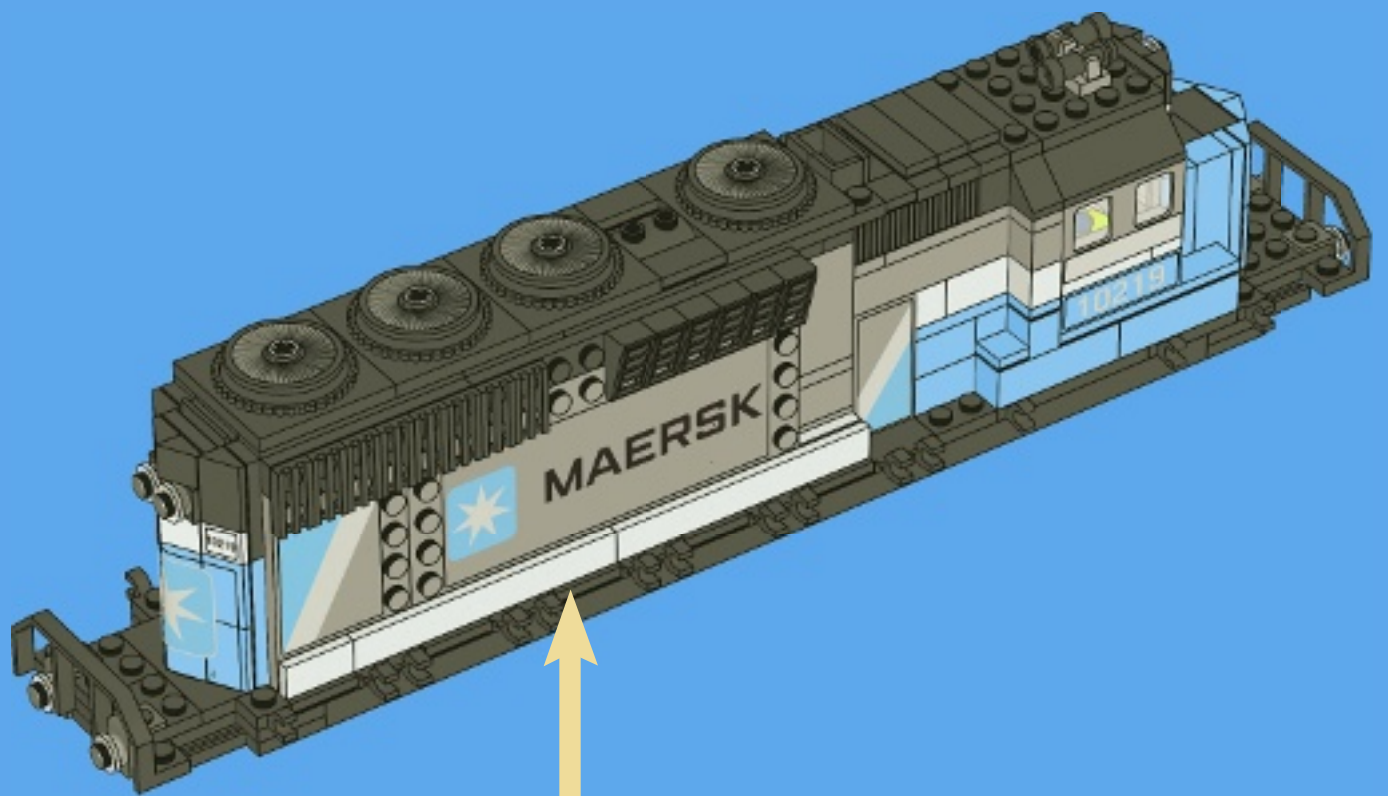



45

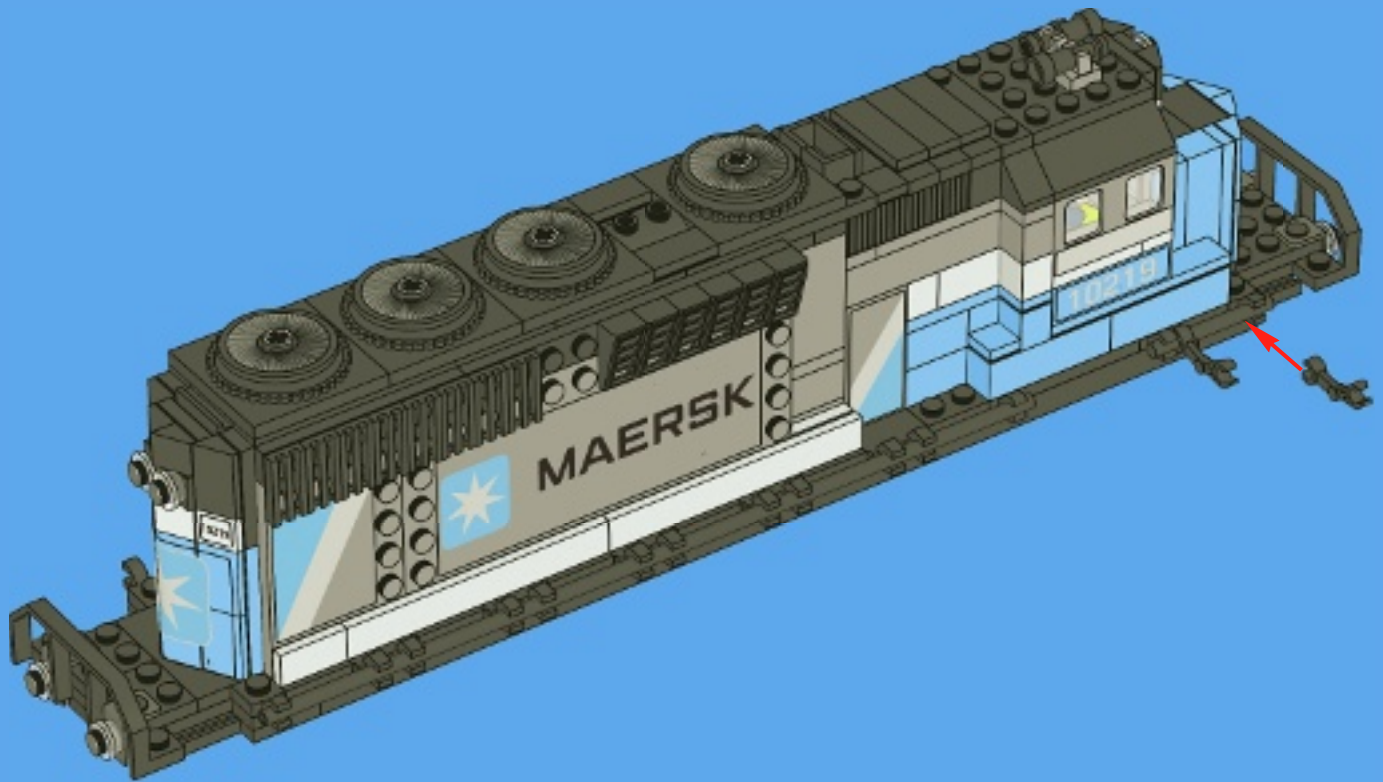



46

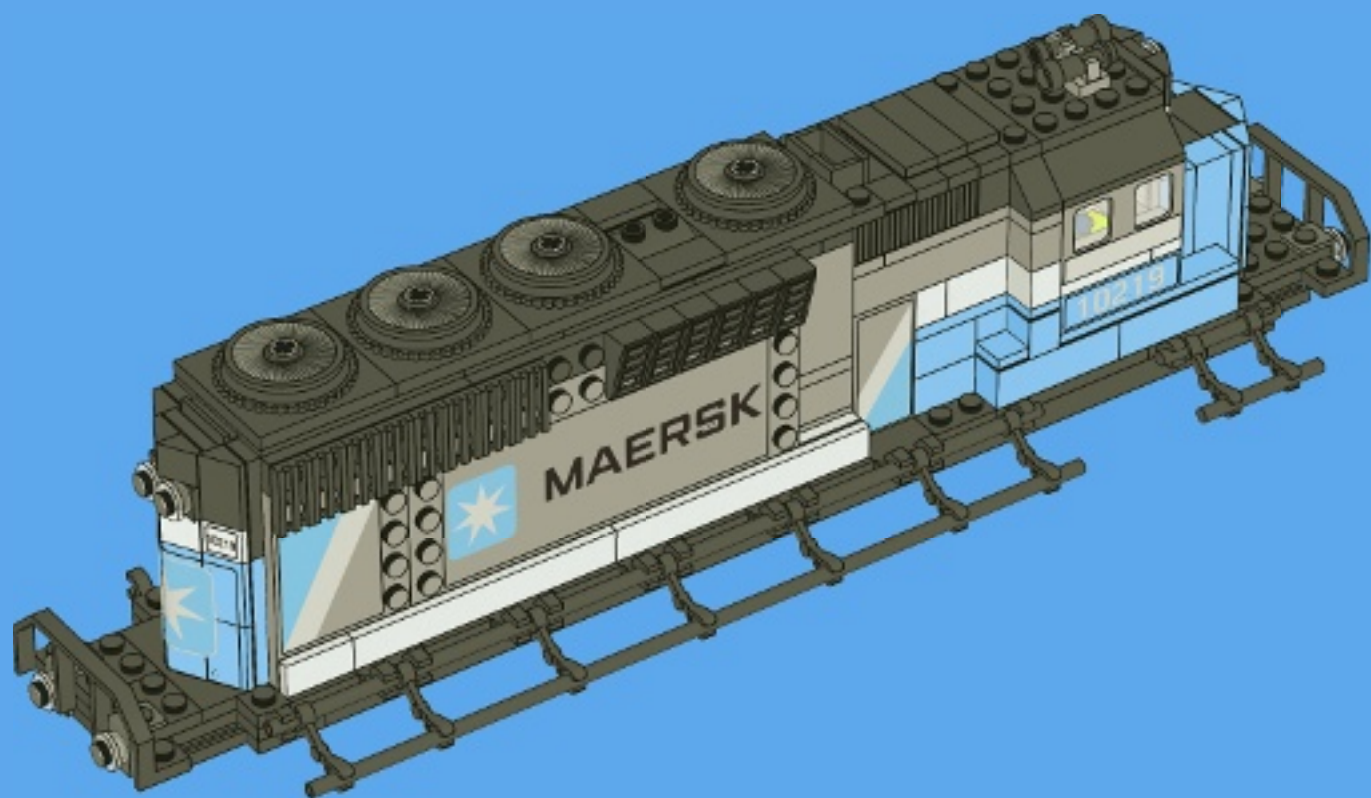

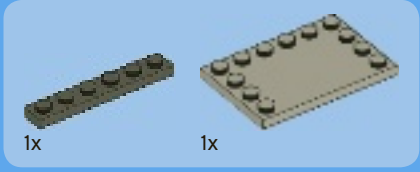
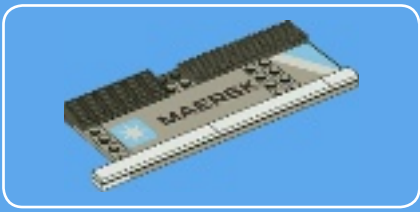

1



2

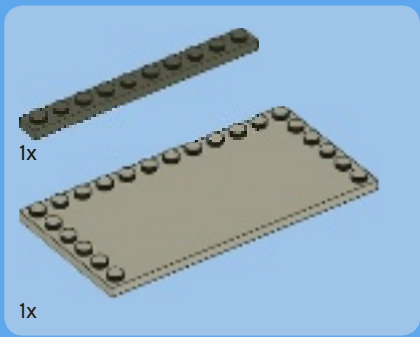
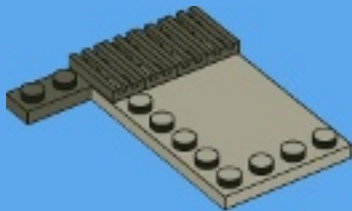

3

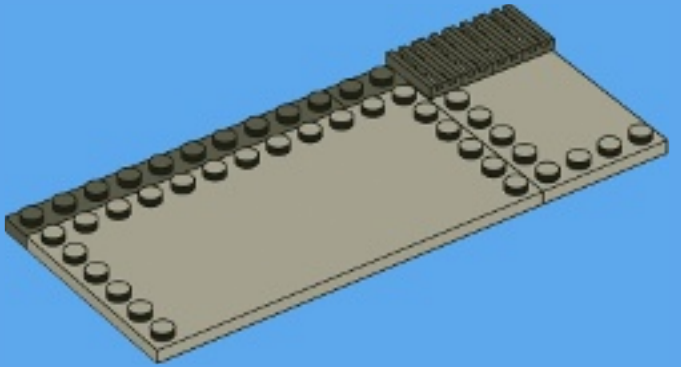

4

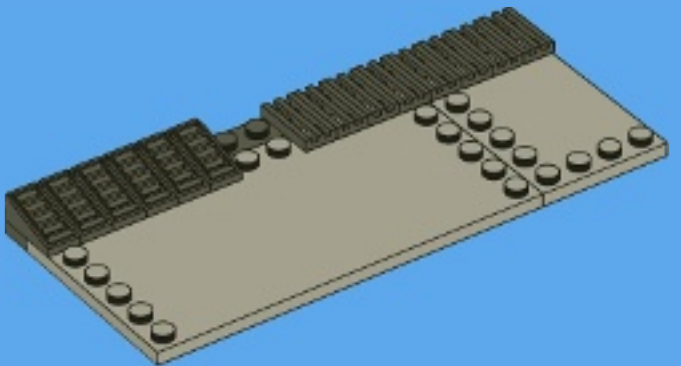

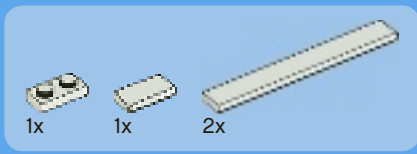

5

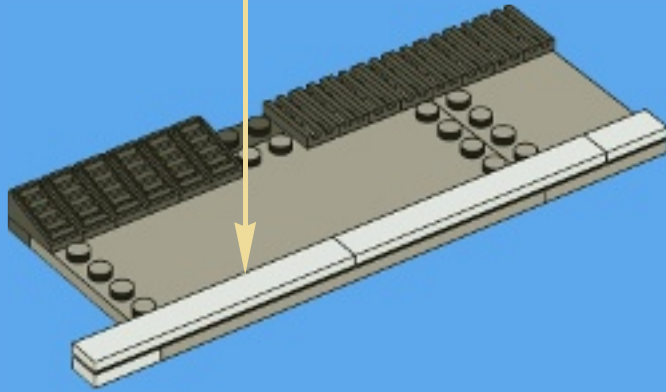
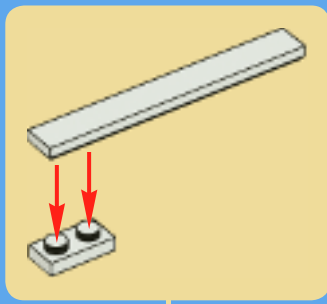

6

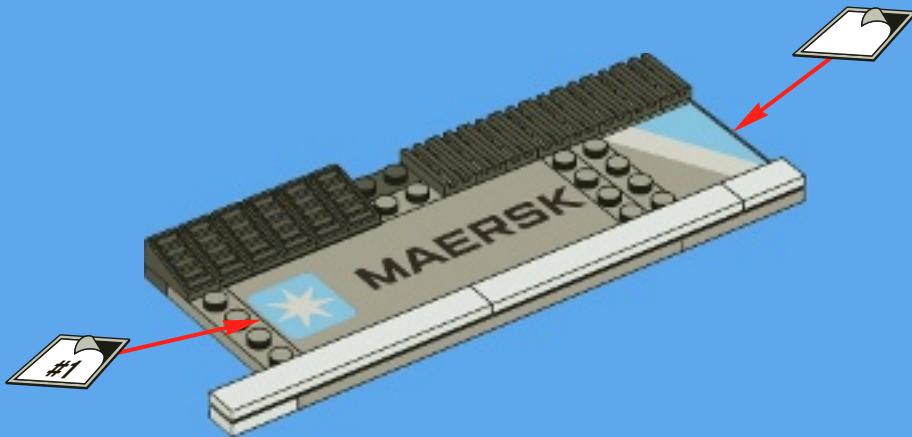

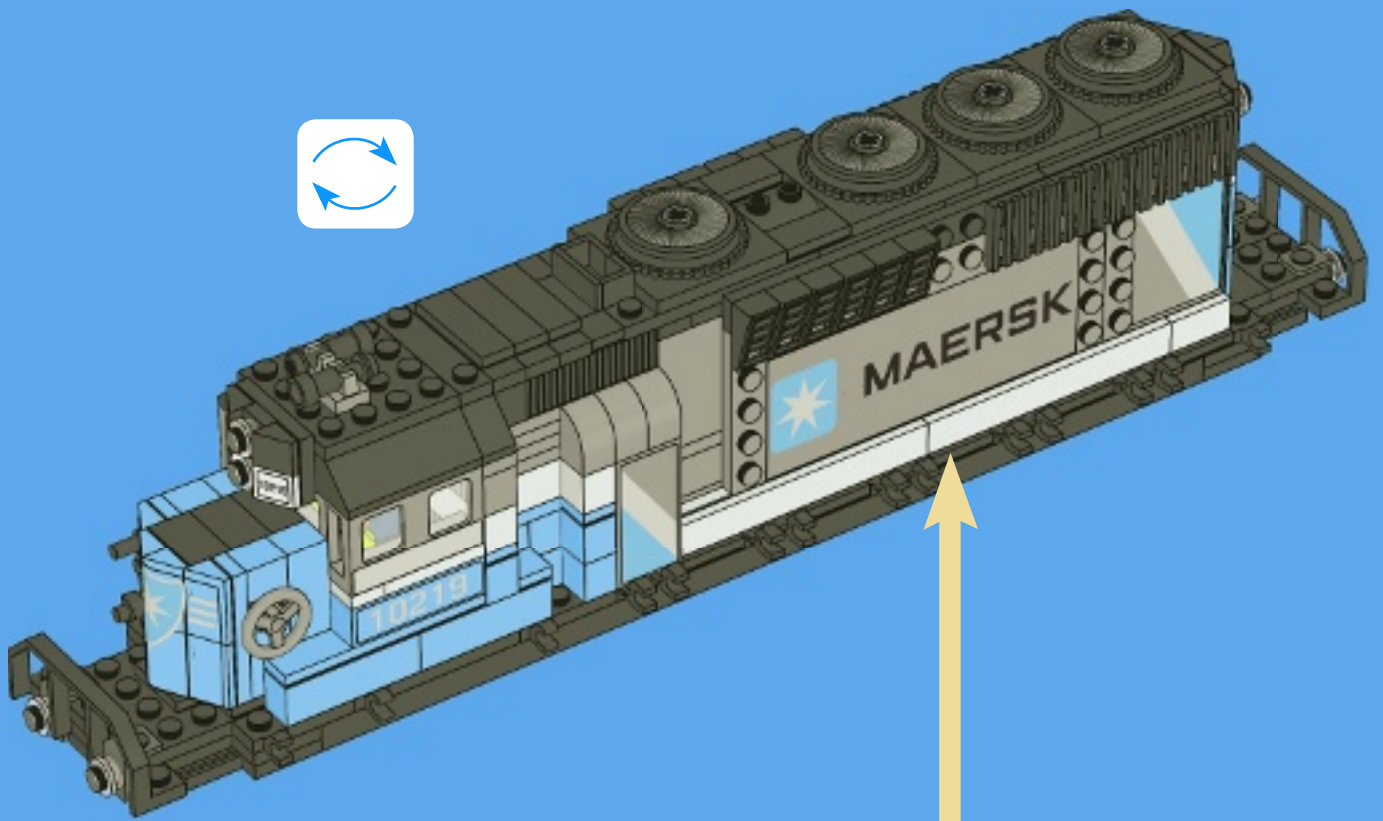



48

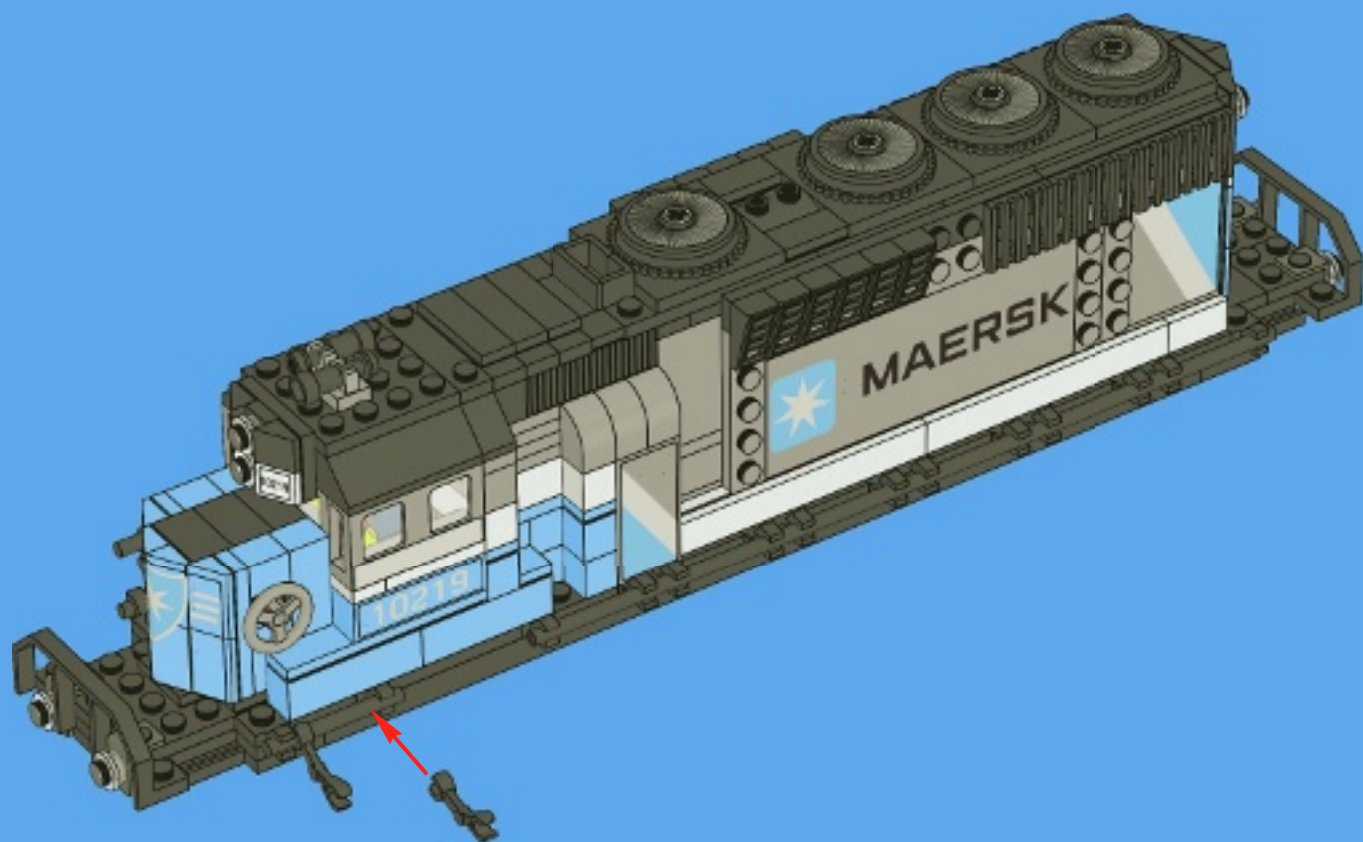



1x

7x

1x

49

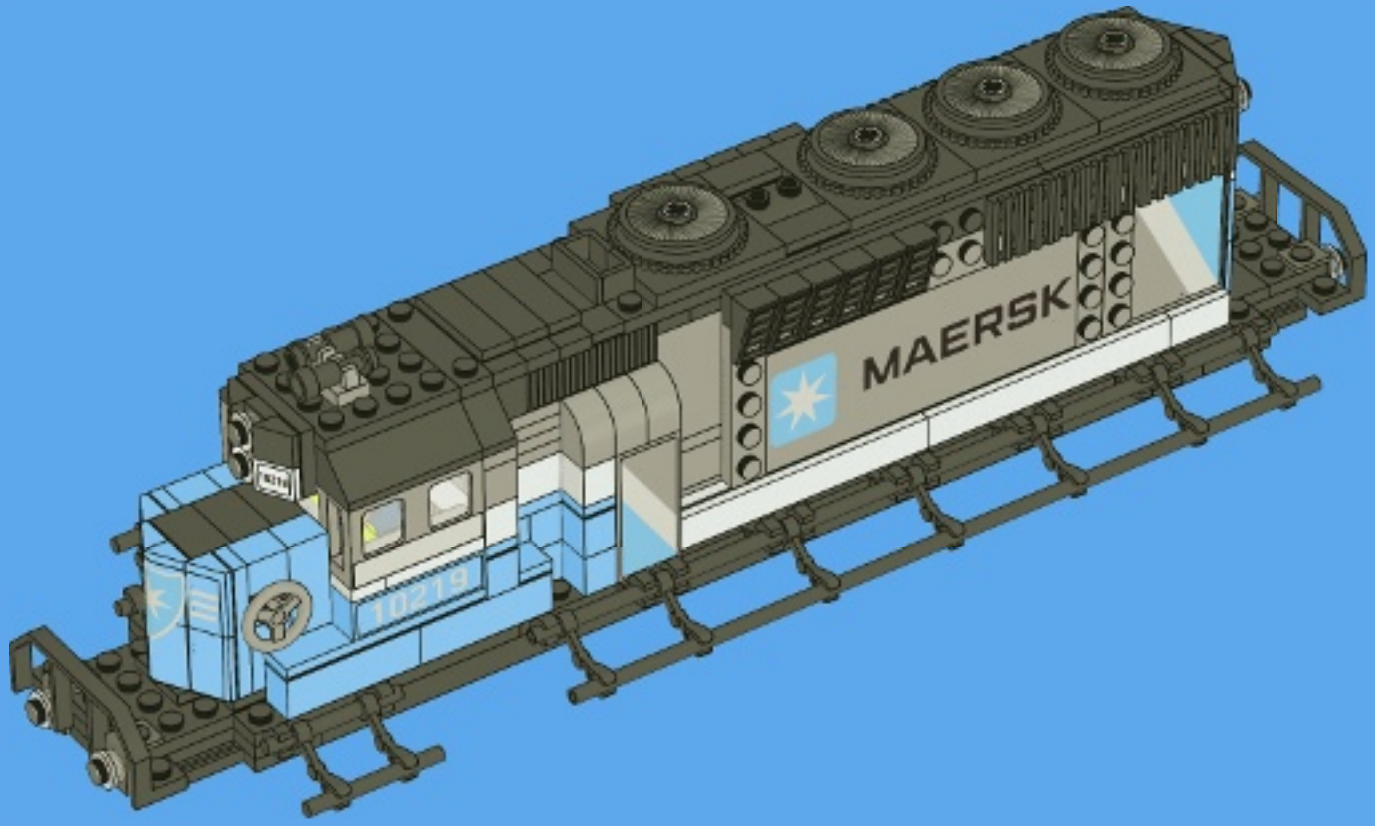

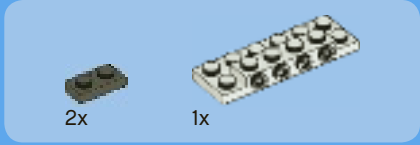

1

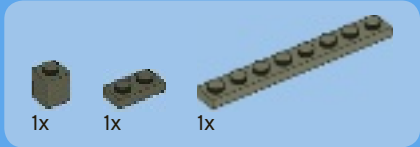

2

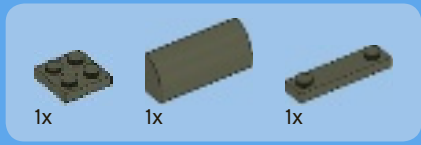

3

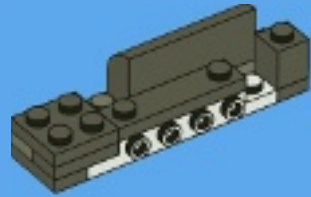

4

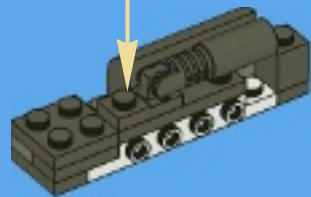
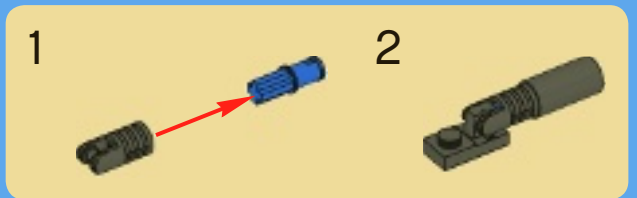



2x



1x

5

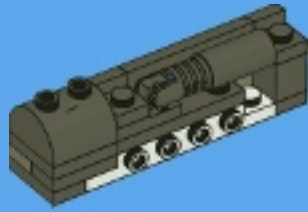

1x



1x



1x

6



2x



1x



4x

7

1

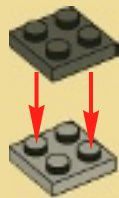

2

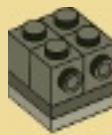

3

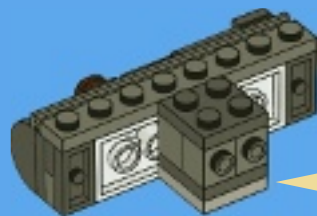

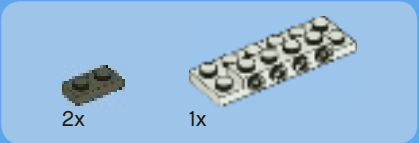

1

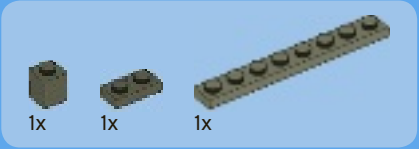

2

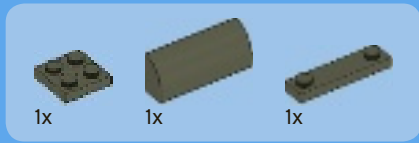

3

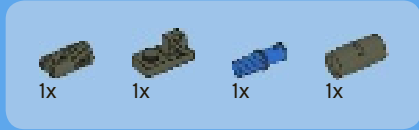
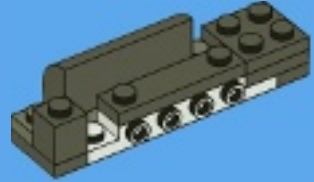

4





2x



1x

5

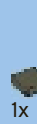
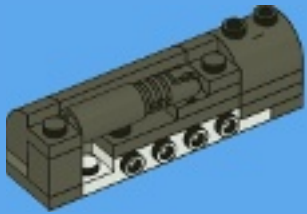

1x



1x



1x

6

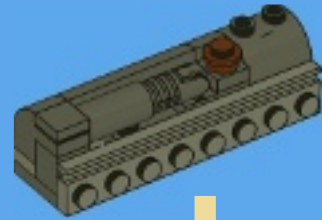

8





4x



1x

9



50

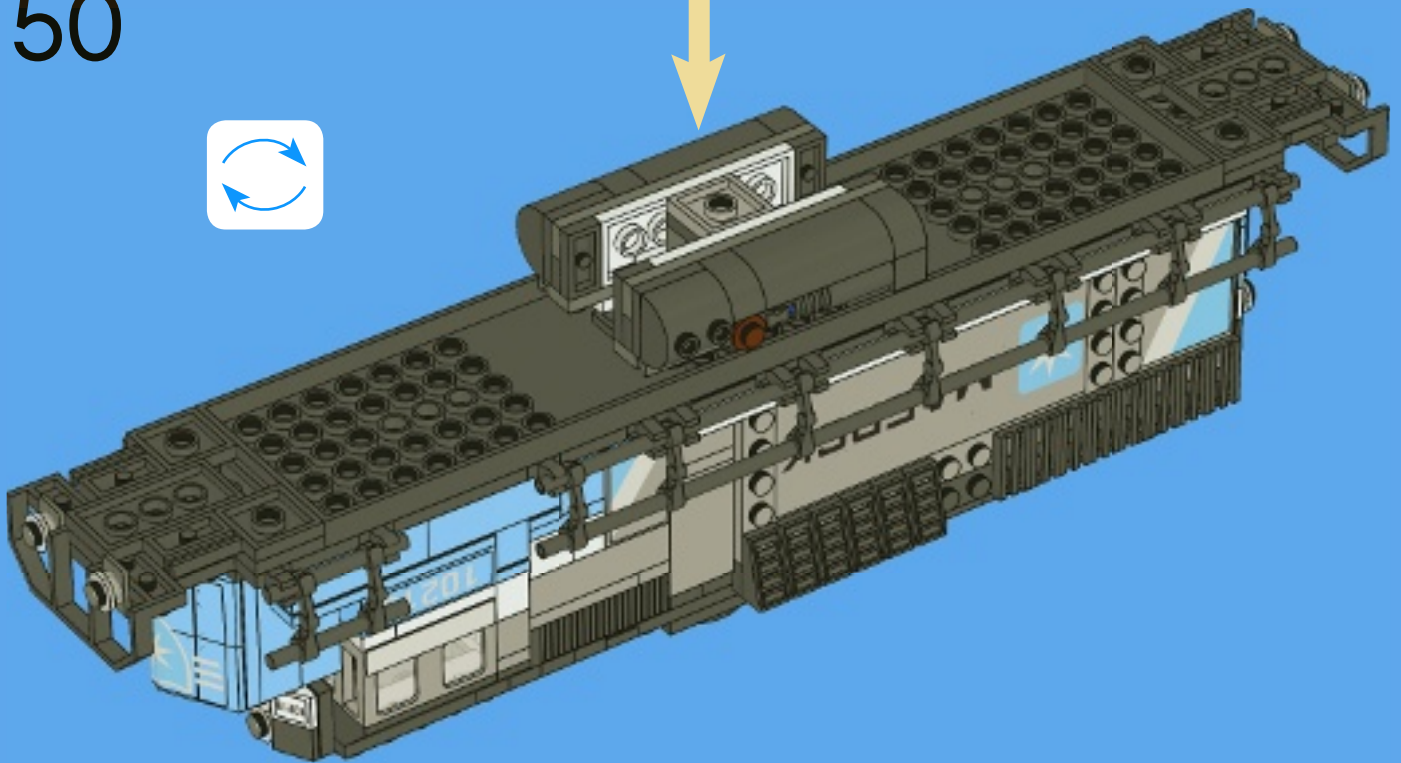

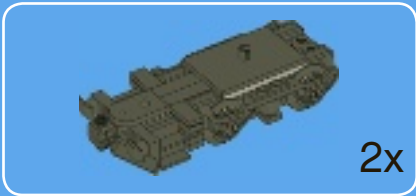

1

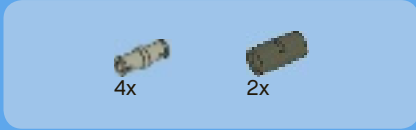
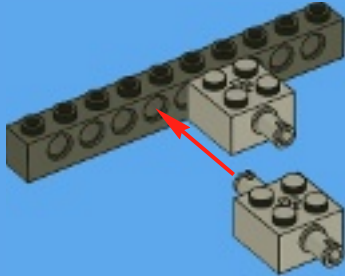

2

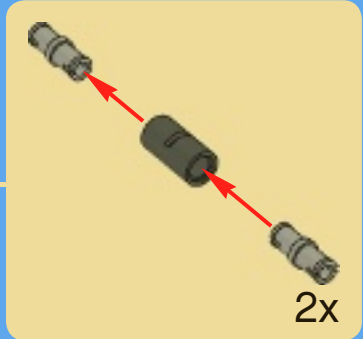
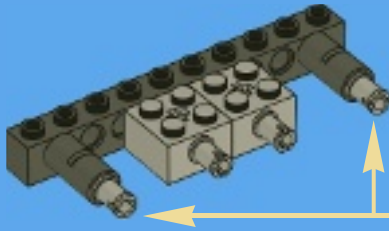

3



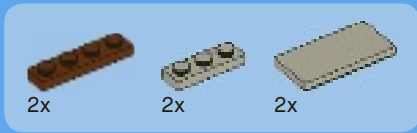

4

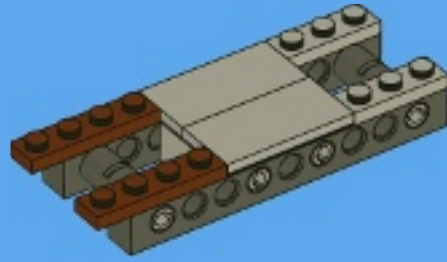

5



6

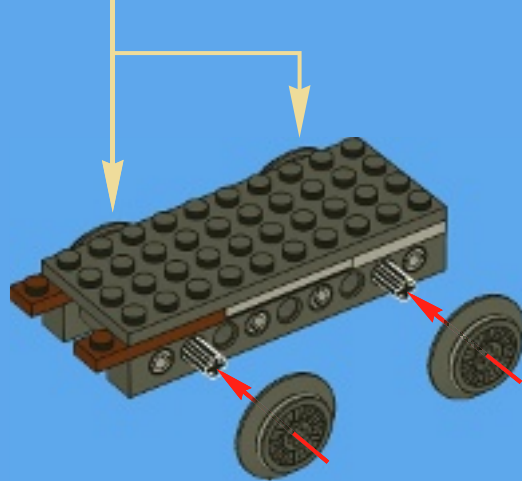
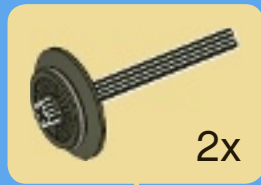

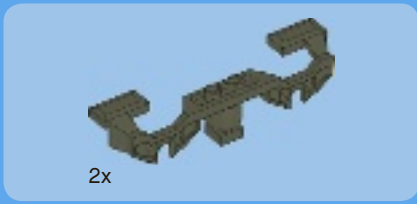

7

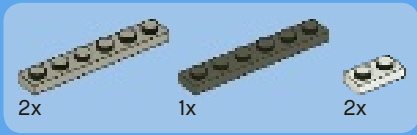

8

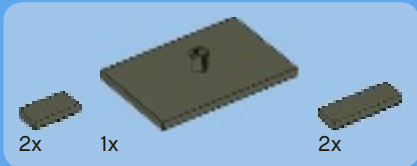

9



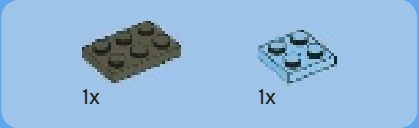

1

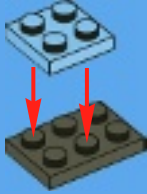

2



3

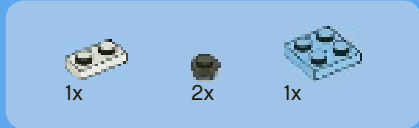

4



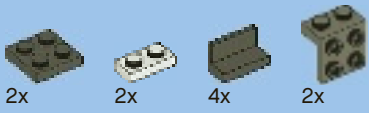

5

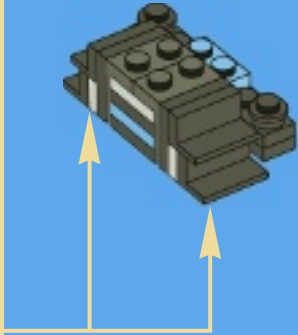
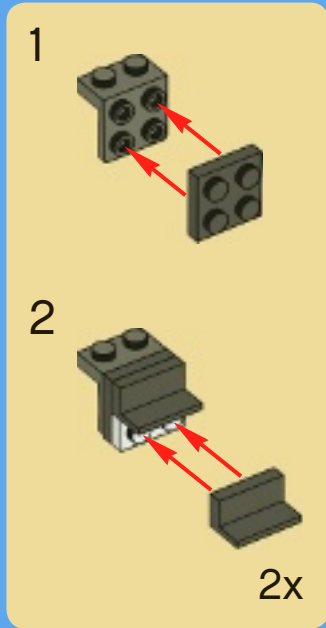

1x

6



10

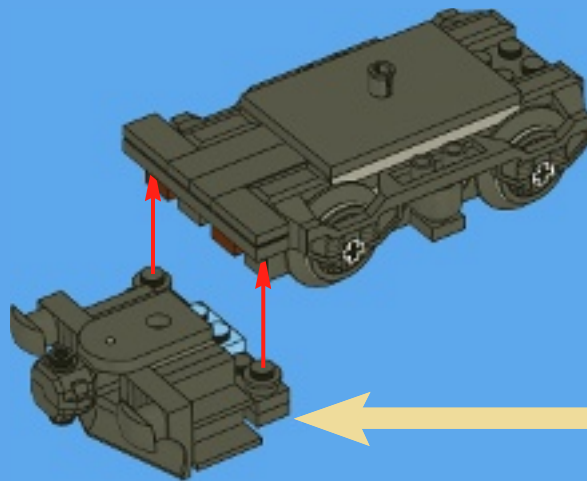

2x

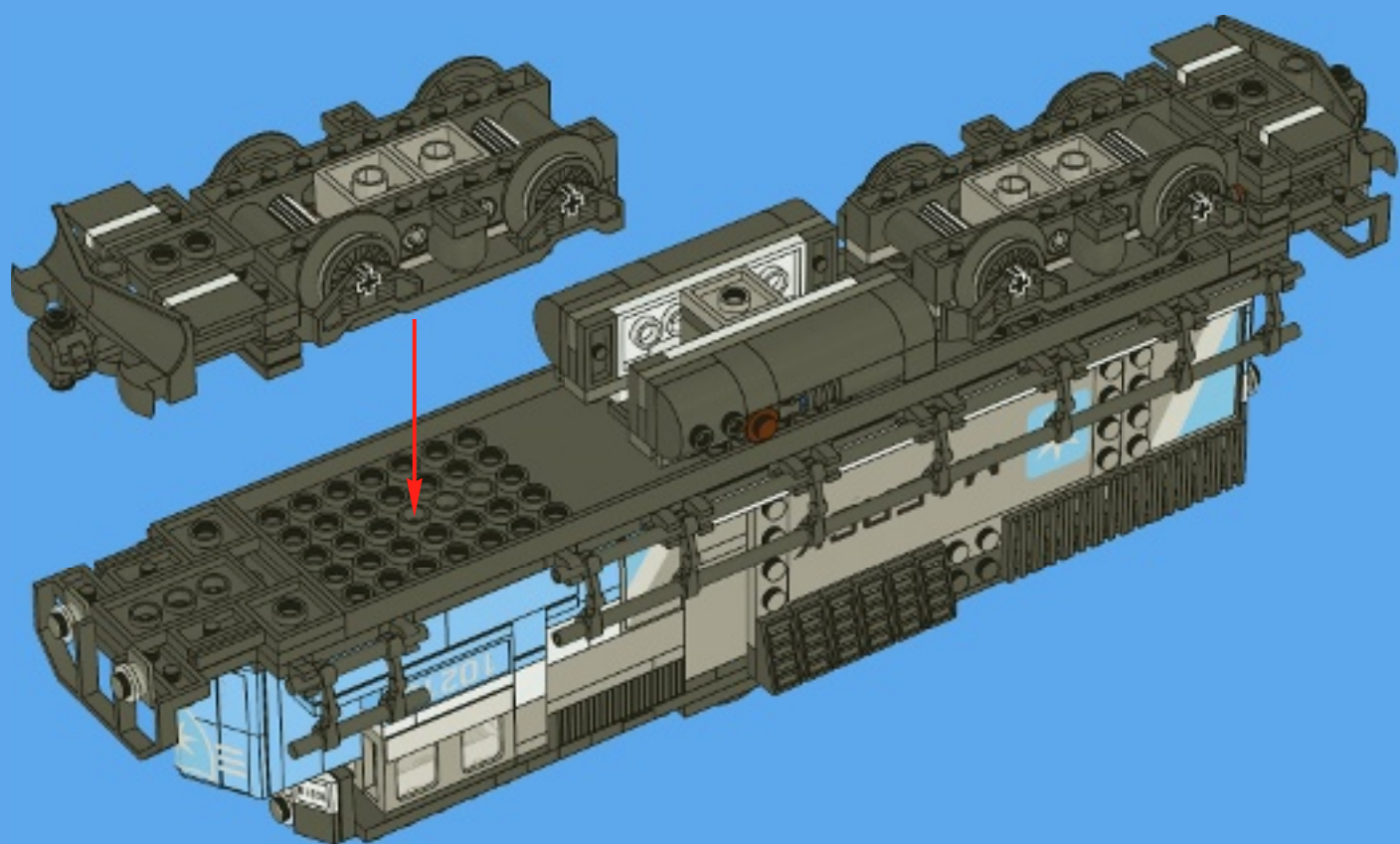



10211



10214



www.LEGO.com

LEGO and the LEGO logo are trademarks of the LEGO Group. ©2011 The LEGO Group.
©2011 Lucasfilm Ltd. & TM. All rights reserved. 4654998