



VODAFONE McLAREN MERCEDES

3236

Vodafone McLaren Mercedes MP4-22



- 2x AM07223ACK
- 1x AM07223X
- 4x AM09393ACM
- 32x AM09393ACK
- 5x AM09393RH
- 4x AM022501MM
- 4x AM022501ACK
- 1x AM07590RH
- 1x AM07590ACK
- 4x AM0910RH
- 10x AM07629MM
- 8x AM07629ACK
- 2x AM07629RH
- 16x AM01086ACK
- 4x AM01086ACM
- 2x AM01314RH
- 4x AM01314ACK
- 17x AM09593ACK
- 1x AM03773ACM
- 3x AM03773RH
- 4x AM03773ACK
- 1x AM03772RH
- 2x AM03772ACM
- 6x AM03772ACK

- 26x AM07659ACK
- 1x AM09013RH
- 2x AM09013ACM
- 10x AM09013ACK
- 2x AM03019RH
- 4x AM03019ACK
- 2x AM01417ACM
- 10x AM01417ACK
- 6x AM01322ACK
- 2x AM08480ACK
- 4x AM08480ACM
- 2x AM04218ACK
- 1x M11101KJ
- 10x AM07228ACK
- 3x AM03018ACK
- 1x AM03329ACK
- 9x M0948ACK
- 3x M1146ACK
- 2x AM01418ACK
- 6x AM01154ACK
- 6x AM01154ACM

- 7x AM09023ACK
- 4x AM02212ACK
- 6x AM01323ACK
- 4x AM10273ACK
- 12x AM04497ACK
- 3x AM01139RH
- 1x AM09487ACK
- 1x AM09488ACK
- 1x AM03323ACK
- 1x AM03324ACK
- 2x AM09493RH
- 3x AM09493ACM
- 28x AM09493ACK
- 12x AM01480ACK
- 3x AM01480ACM
- 3x AM01480ACK
- 1x AM08483RH
- 1x M1172ACK
- 3x M1172F

- 9x AM01087ACK
- 4x AM01087RH
- 6x AM01087ACM
- 2x AM04513ACK
- 2x AM04512ACK
- 2x AM03873ACK
- 11x AM09033ACM
- 3x AM09033RH
- 5x AM09033ACK
- 6x AM01313ACK
- 2x M10233ACK
- 3x AM04983ACK
- 3x AM04983ACM
- 3x AM04985ACM
- 3x AM04985ACK
- 1x AM04985RH

- 1x AM03771RH
- 1x AM03770RH
- 1x AM03771ACK
- 1x AM03770ACK
- 1x AM03015ACK
- 1x AM07646ACK
- 5x AM02237RH
- 2x AM07229ACM
- 2x AM07229ACK
- 1x AS0323608
- 1x AM04514ACK
- 1x AM01530ACK

- 1x AS0323603
- 1x AS0323604
- 1x AS0323602
- 1x AS0323601
- 3x AM07230ACK
- 2x AM08481ACK
- 1x AS0323609
- 1x AS0323610
- 1x AM07224ACK
- 1x AM07225ACK
- 1x AM07226ACK
- 1x AM07227ACK
- 1x AS0323611
- 1x AS0323612
- 1x AM02763ACK
- 1x AM02764ACK

- 2x AM04511MM
- 1x AM04510MM
- 1x AM04509MM
- 1x AM04508MM
- 4x AS0323613
- 2x AS0323605
- 1x AM03188RH
- 1x AS0323606
- 1x AS0323607
- 1x AS0323614
- 1x AS0323615

Vodafone McLaren Mercedes MP4-22

Manufactured under licence from McLaren Racing Limited. McLaren and the McLaren logo are trademarks of McLaren Racing Limited.

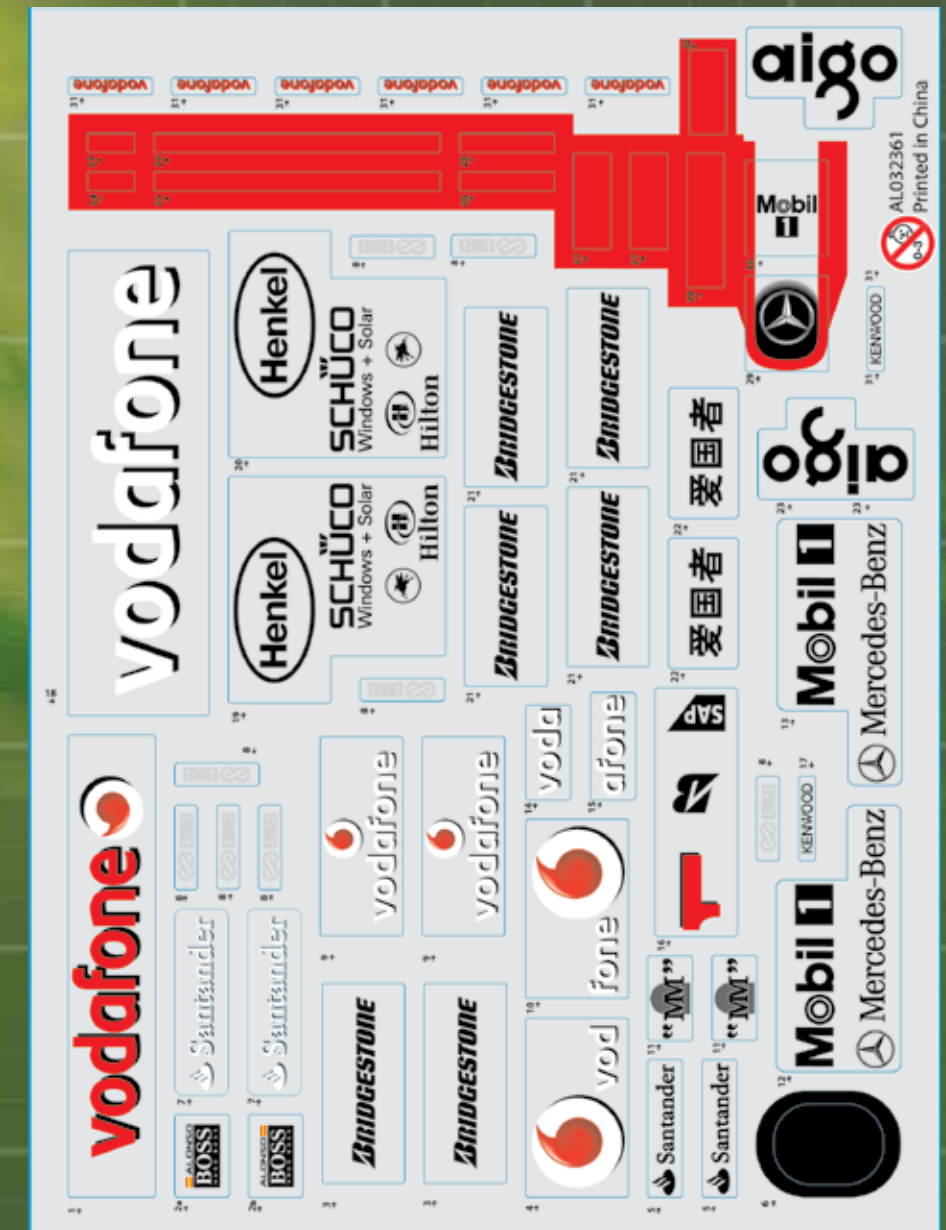
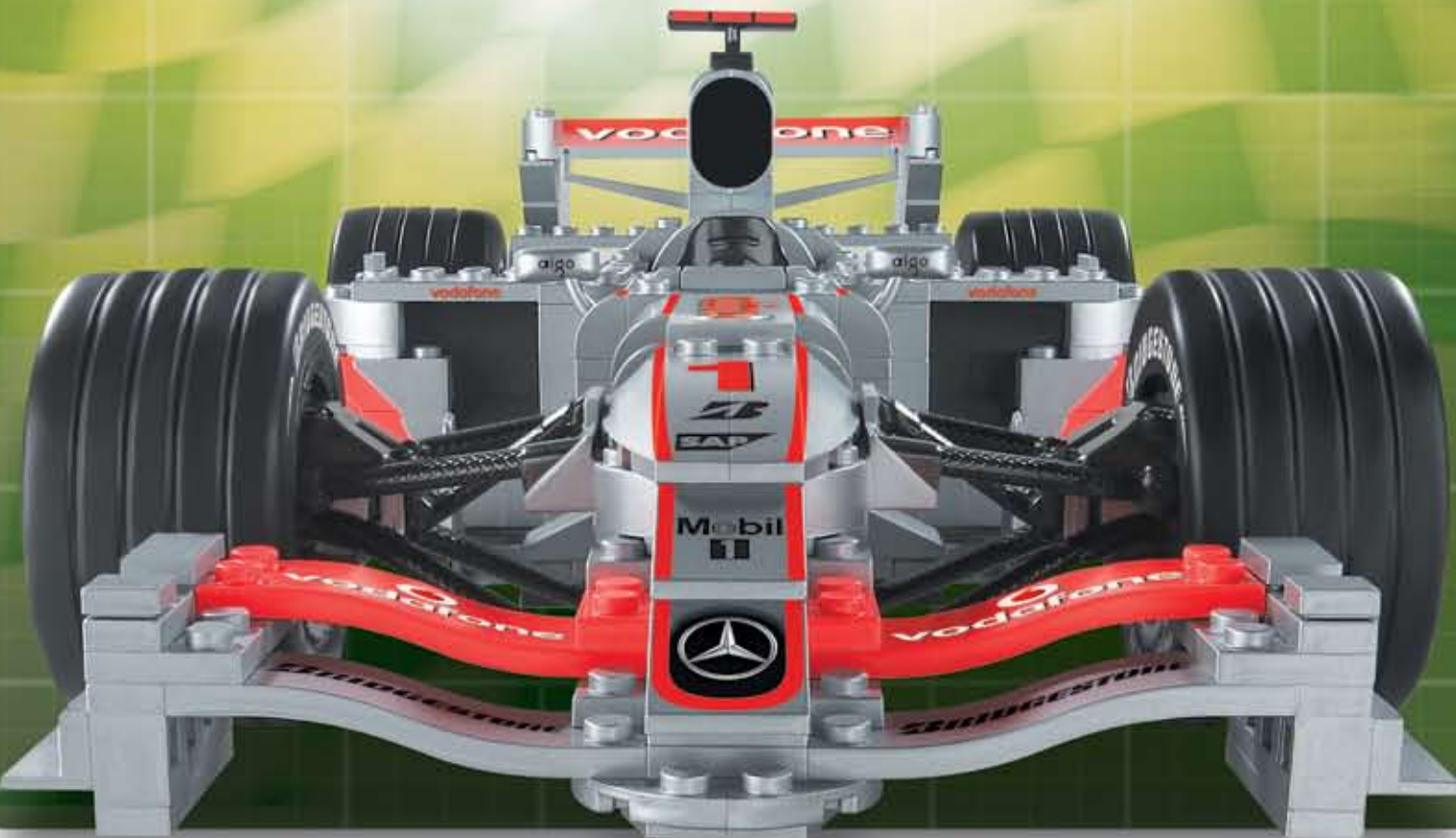

AL032361

EN Please read these instructions carefully before first use and keep them for future reference. / **ES** Leer estas instrucciones cuidadosamente antes de la primera utilización y guardarlas para referencia futura. / **DE** Il est recommandé de lire attentivement ce feuillet avant la première utilisation et de le conserver pour référence future. / **FR** Die Gebrauchsanleitung bitte durchlesen und aufbewahren. / **NL** Wij raden u aan deze handleiding zorgvuldig te lezen en te bewaren voor eventuele raadpleging op een later tijdstip. / **IT** Leggere le istruzioni prima di cominciare ad usare il gioco e conservarle per referenze future. / **PT** Leia as instruções antes do primeiro uso e guarde-as para futura referência.

EN ⚠ **WARNING:**
CHOKING HAZARD. - Small parts.
Not for children under 3 years.

ES ⚠ **ADVERTENCIA:**
PELIGRO DE ASFIXIA. - Contiene piezas pequeñas.
No recomendado para niños menores de 3 años.

FR ⚠ **AVERTISSEMENT:**
RISQUE DE SUFFOCATION. - Présence de petits éléments.
Ne convient pas aux enfants de moins de 3 ans.

DE ⚠ **WARNUNG:**
ERSTICKUNGSGEFAHR. - Enthält kleine Teile.
Nicht für Kinder unter 3 Jahren geeignet.

NL ⚠ **WAARSCHUWING:**
VERSTIKKINGSGEVAAR. - Bevat kleine onderdelen.
Niet geschikt voor kinderen onder de 3 jaar.

DA ⚠ **ADVARSEL:**
KVÆLNINGSFARE. - Indeholder smådele.
Ikke til børn under 3 år.

EL ⚠ **ΠΡΟΕΙΔΟΠΟΙΗΣΗ:**
ΚΙΝΔΥΝΟΣ ΠΝΕΙΜΑΤΟΣ. - Περιέχει μικρά αντικείμενα.
Όχι για παιδιά κάτω των 3 ετών.

FI ⚠ **VAROITUS:**
TUKEHTUMISVAARA. - Sisältää pieniä osia.
Ei alle 3-vuotiaille lapsille.

IT ⚠ **ATTENZIONE:**
PERICOLO DI SOFFOCAMENTO. - Contiene piccole parti.
Non indicato per bambini sotto i 3 anni.

NO ⚠ **ADVARSEL:**
KVELNINGSFARE. - Inneholder små deler.
Kun for barn over 3 år.

PT ⚠ **ATENÇÃO:**
PERIGO DE ASFIXIA. - Contém peças pequenas.
Não é concebido para crianças de menos de 3 anos.

SV ⚠ **WARNING:**
KVÄVNINGSRISK. - Innehåller små delar.
Inte för barn under 3 år.

JA ⚠ **警告:**
窒息の危険性 小さな部品が含まれています
3歳以下の子供には与えないで下さい。

ZH ⚠ **警告:**
有窒息危險。包含有小部件
不适合3岁以下的小孩玩。

AR ⚠ **تحذير:**
خطر اختناق - قطع صغيرة.
غير صالحة للأطفال أقل من 3 سنوات.



LIFETIME GUARANTEE / GARANTIZADO DE POR VIDA / GARANTIE À VIE / LEBENSBLANDE GARANTIE / LEVENSLANGE GARANTIE / GARANZIA A VITA / TEM GARANTIA VITALÍCIA

COMMENTS, QUESTIONS ? / ¿COMENTARIOS, PREGUNTAS ? / COMMENTAIRES, QUESTIONS ? / KOMMENTARE, FRAGEN ? / COMMENTAAR, VRAGEN ? / COMMENT? / DOMANDE? / PERGUNTAS?, COMENTÁRIOS?

1-800-465-MEGA

U.S. & Canada only / Solamente en EEUU y Canadá / É.U. et Canada seulement / Nur für U.S. und Kanada / Uitsluitend in de V.S. en Canada / USA e Canada solamente / Somente EE.UU. e Canadá

www.megabrands.com

1



x1



x2

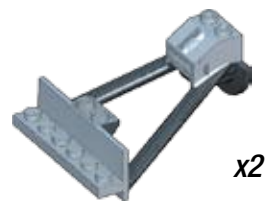

x2

VODAFONE McLAREN MERCEDES

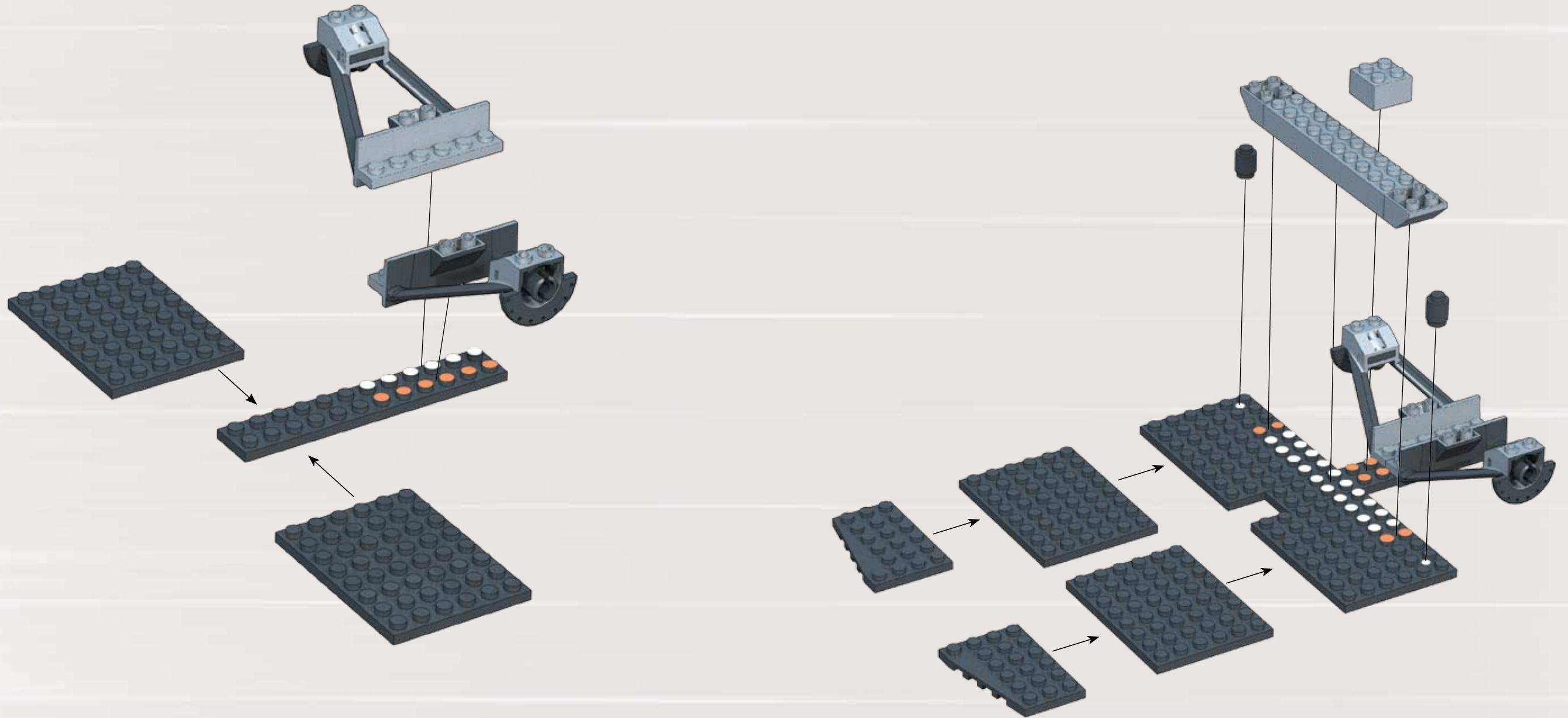

Probuilder® Advanced Building Set 8+™

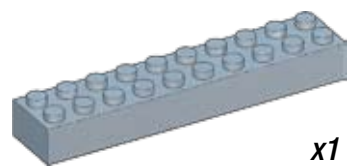

x1



x2



x1



x1



x2



x1



x2

2

3

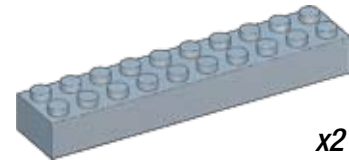

VODAFONE McLAREN MERCEDES

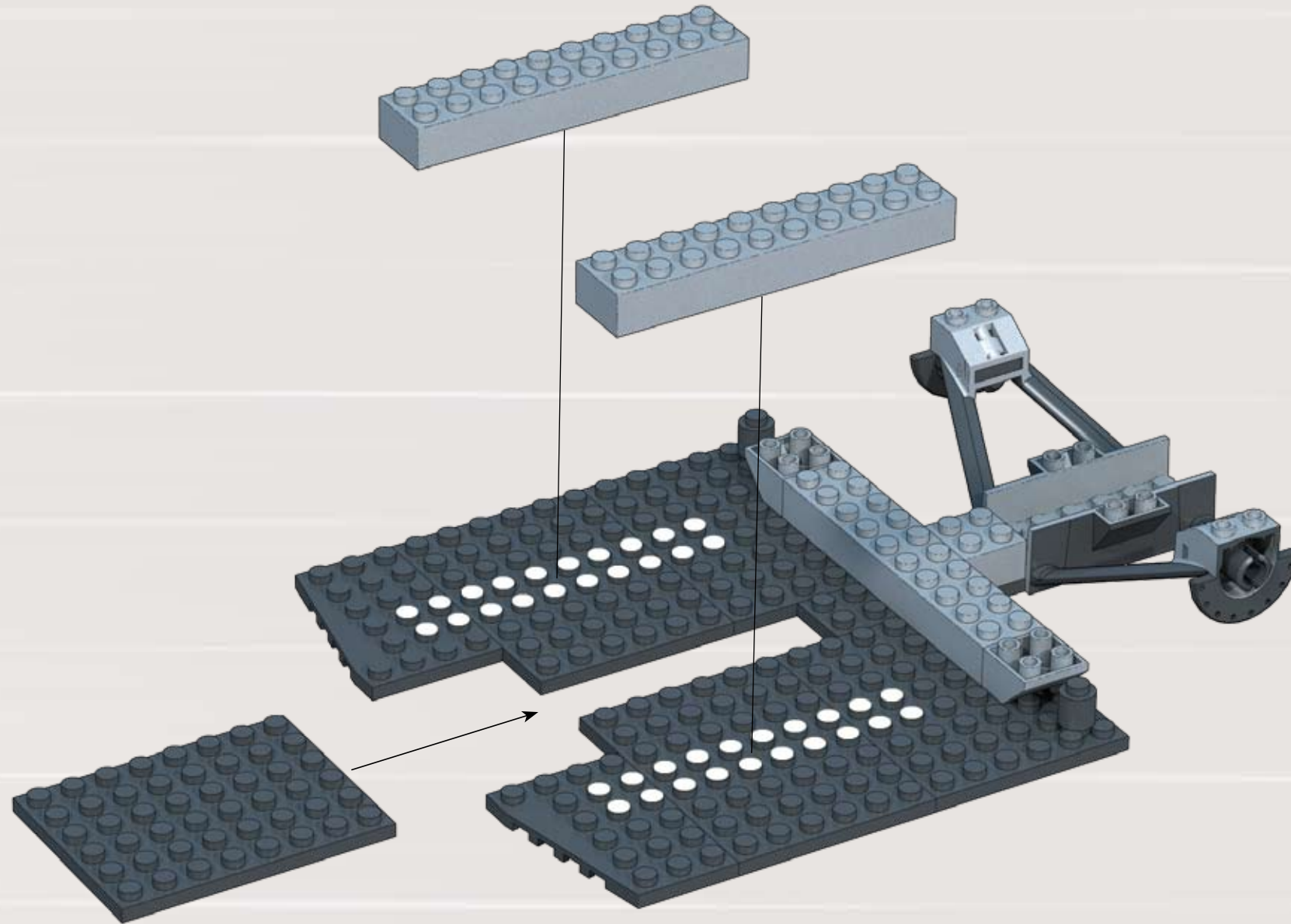

Probuilder® Advanced Building Set 8+™

5

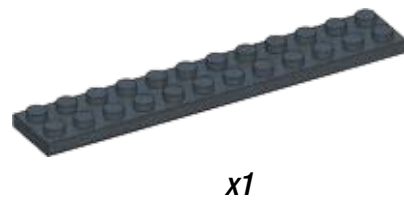
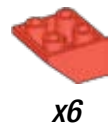

VODAFONE McLAREN MERCEDES

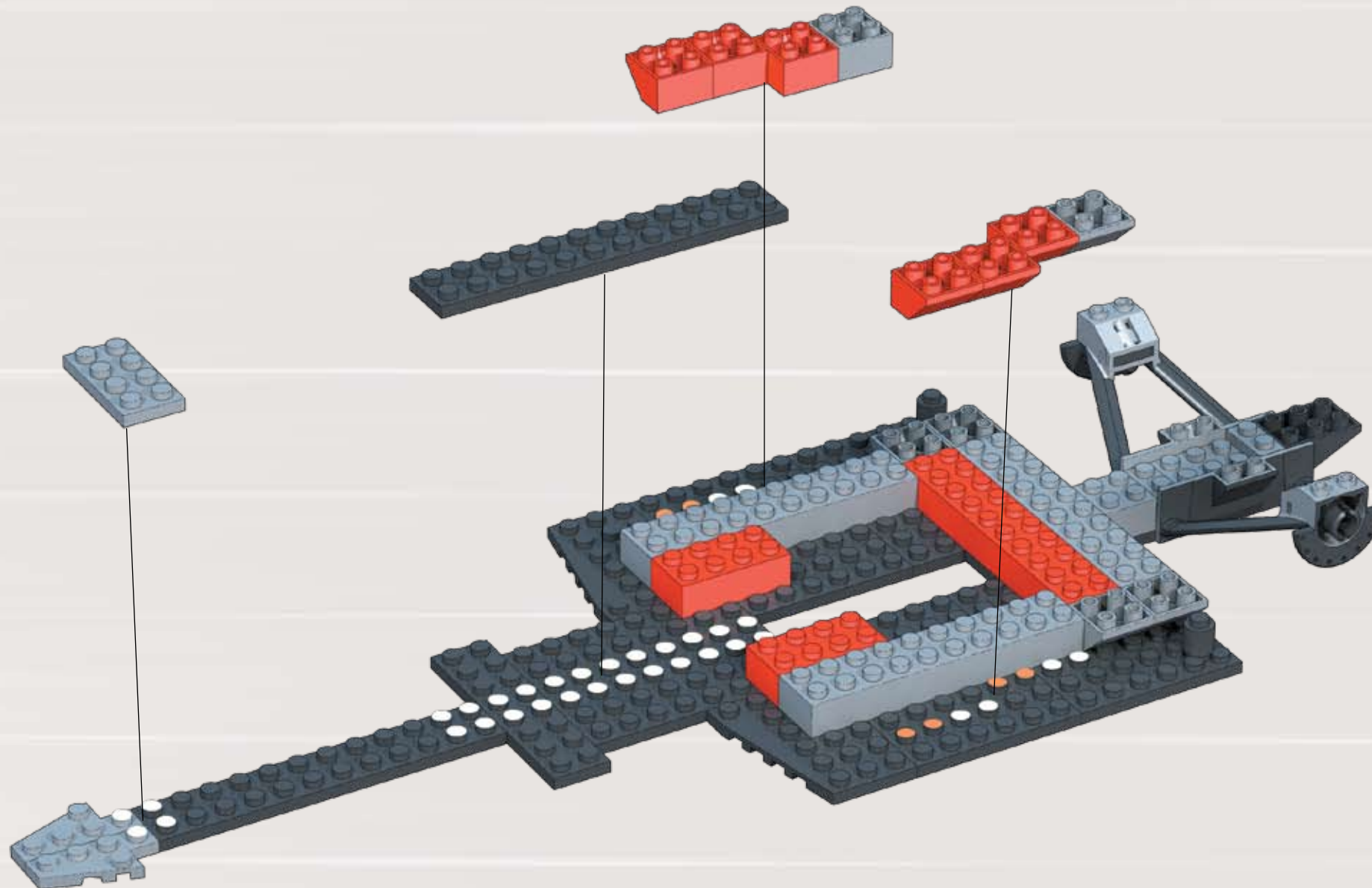

Probuilder® Advanced Building Set 8+™

8

VODAFONE McLAREN MERCEDES

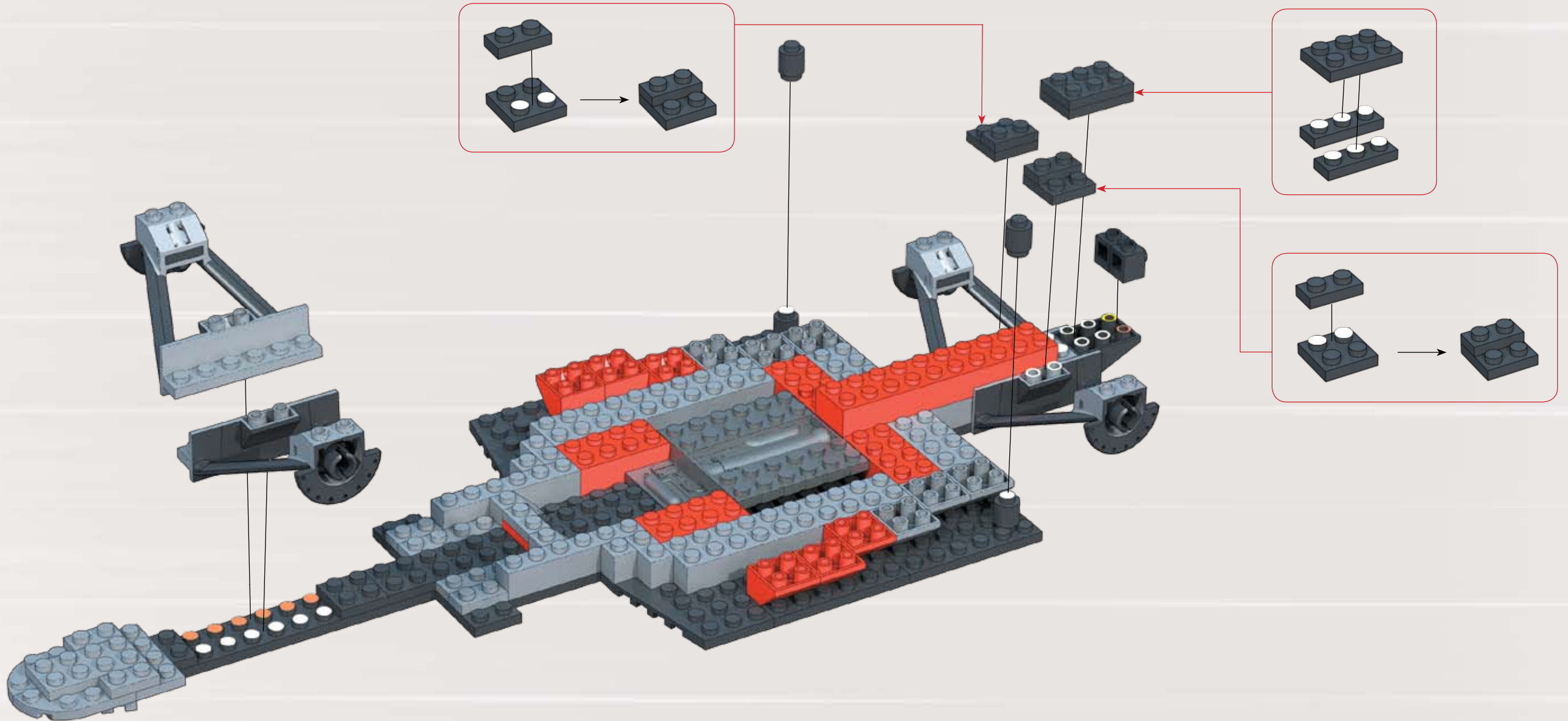
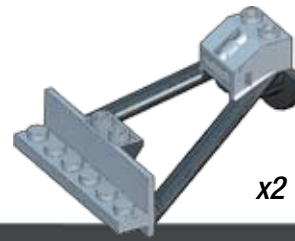

Probuilder® Advanced Building Set 8+™

9

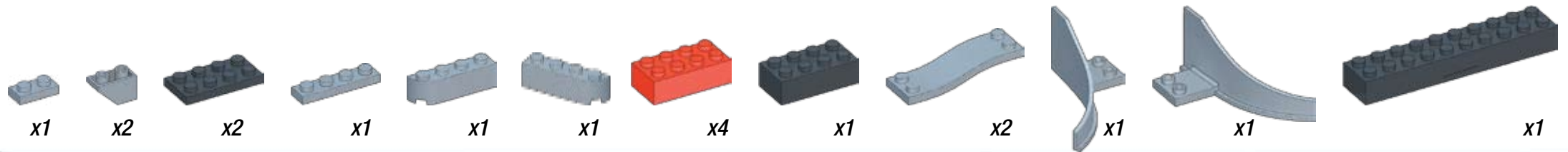

VODAFONE McLAREN MERCEDES

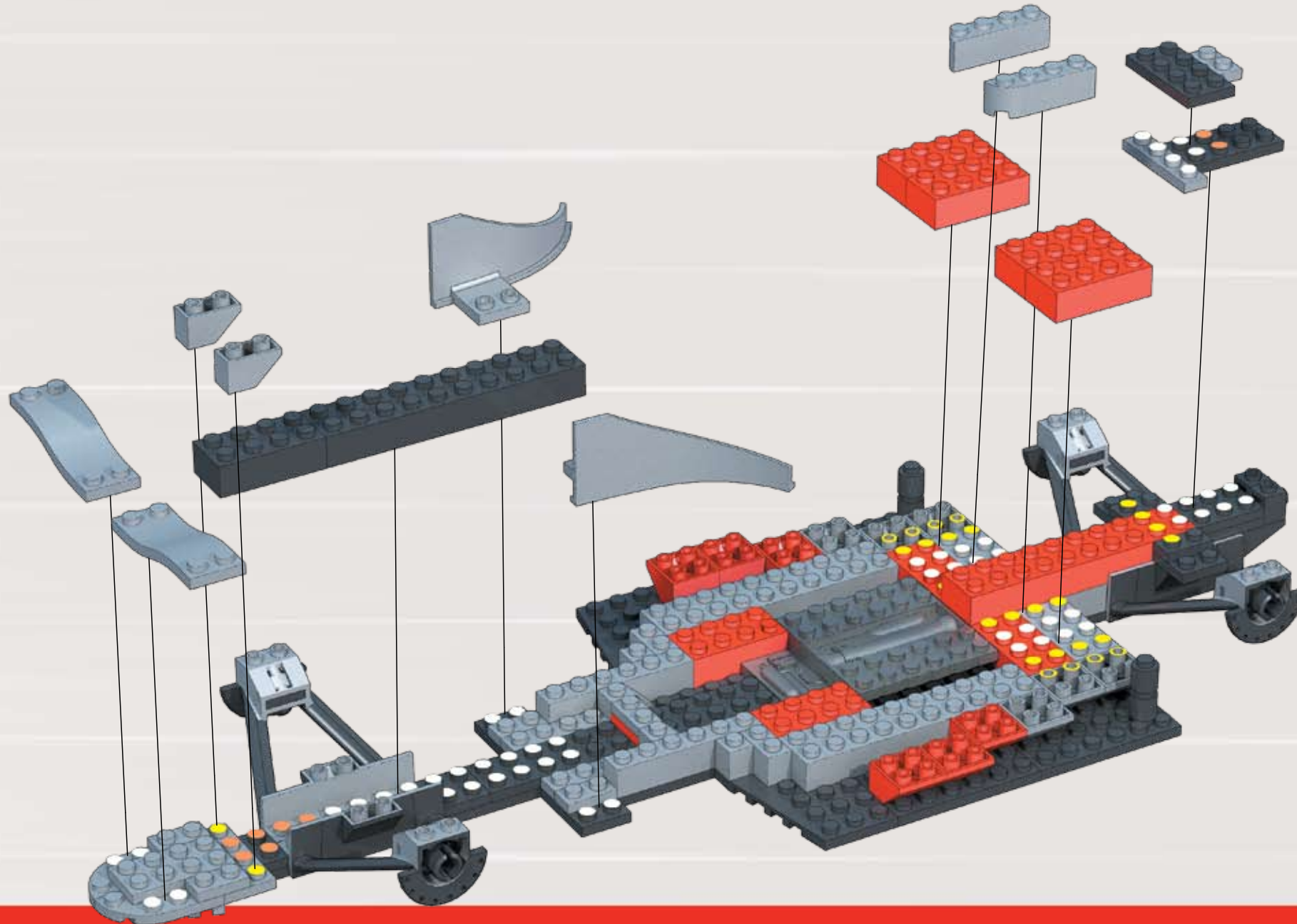

Probuilder® Advanced Building Set 8+™

10

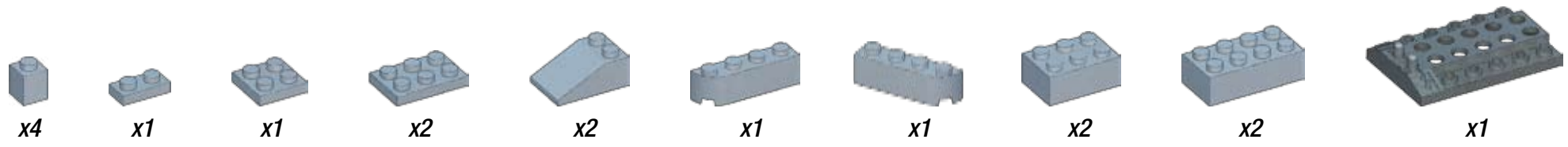

VODAFONE McLAREN MERCEDES

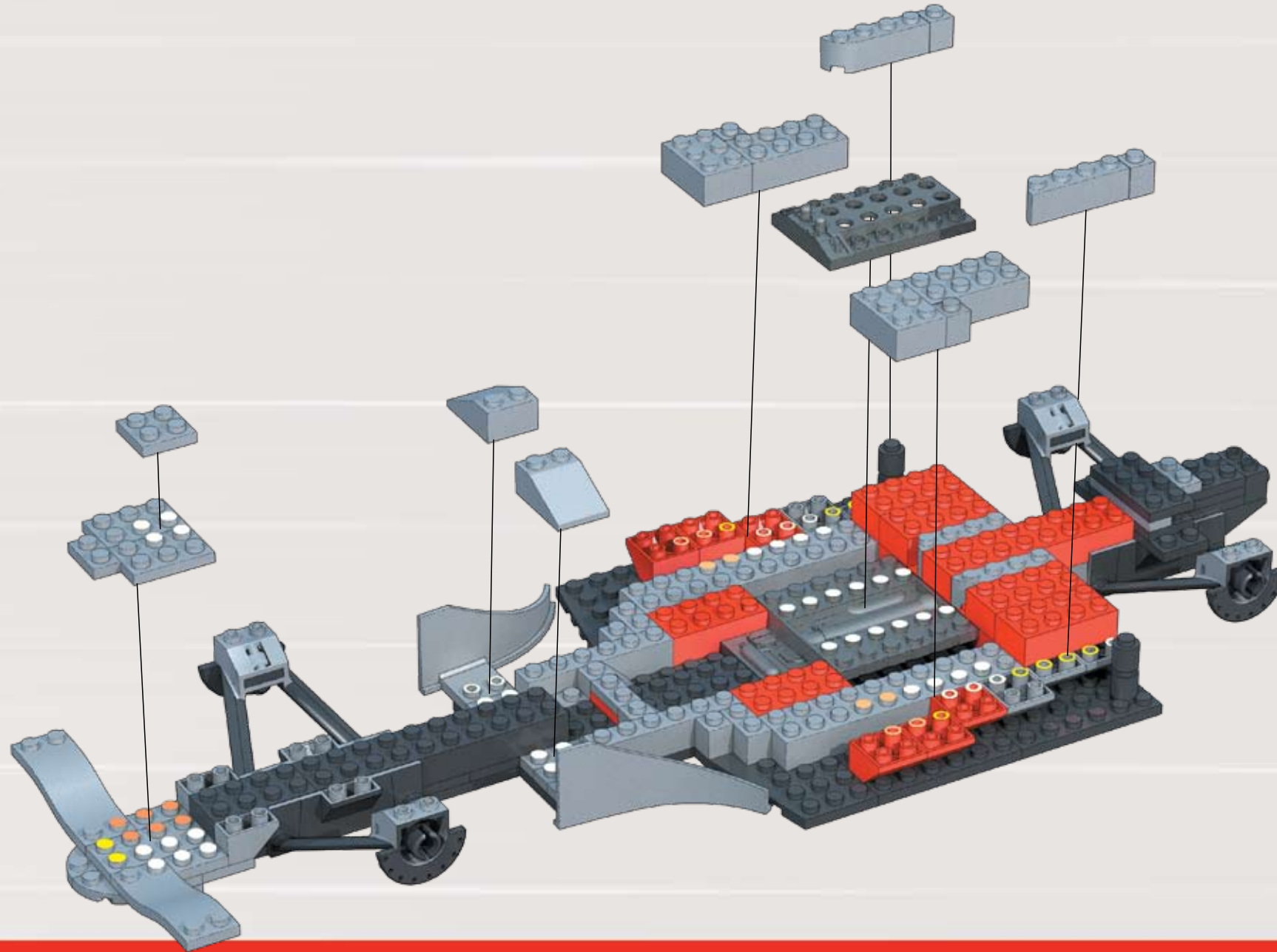

Probuilder® Advanced Building Set 8+™

11

-  x4
-  x10
-  x2
-  x4
-  x2

VODAFONE McLAREN MERCEDES

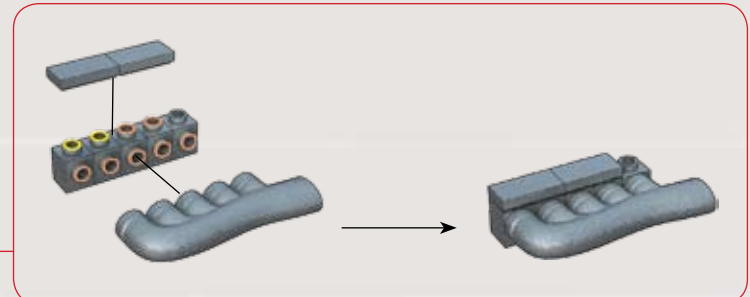
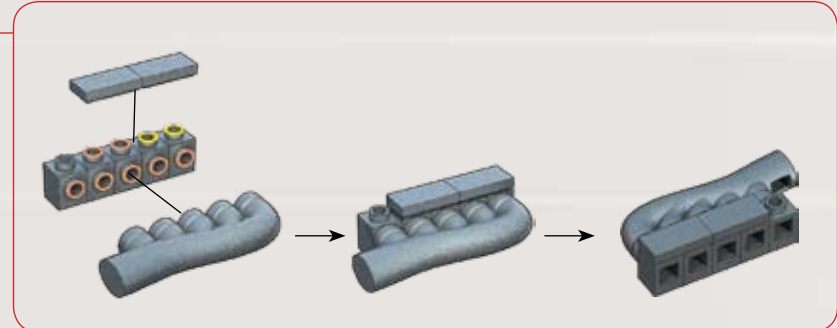
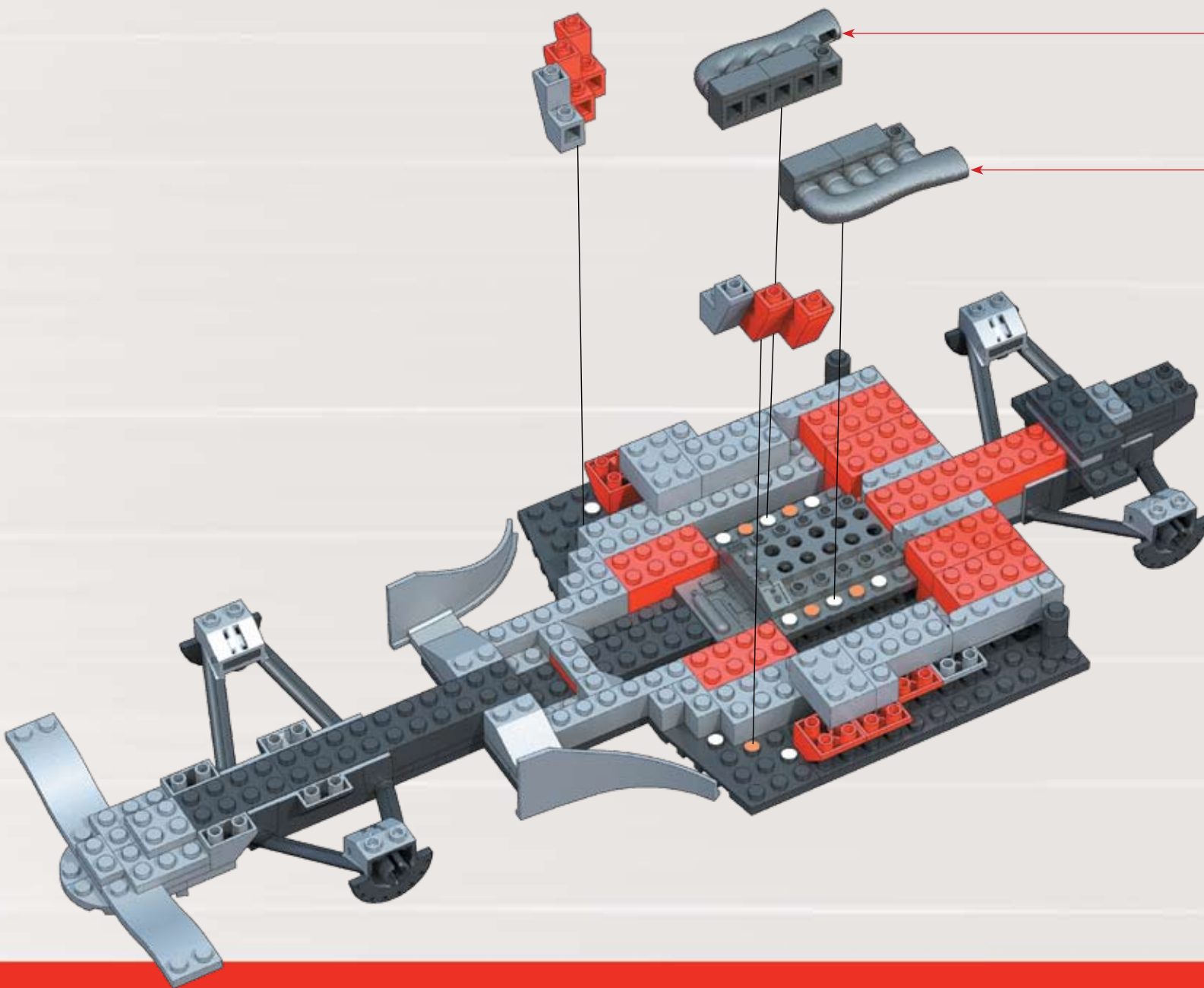

Probuilder® Advanced Building Set 8+™

12

-  x2
-  x2
-  x8
-  x2
-  x2
-  x4
-  x6
-  x2
-  x1

VODAFONE McLAREN MERCEDES

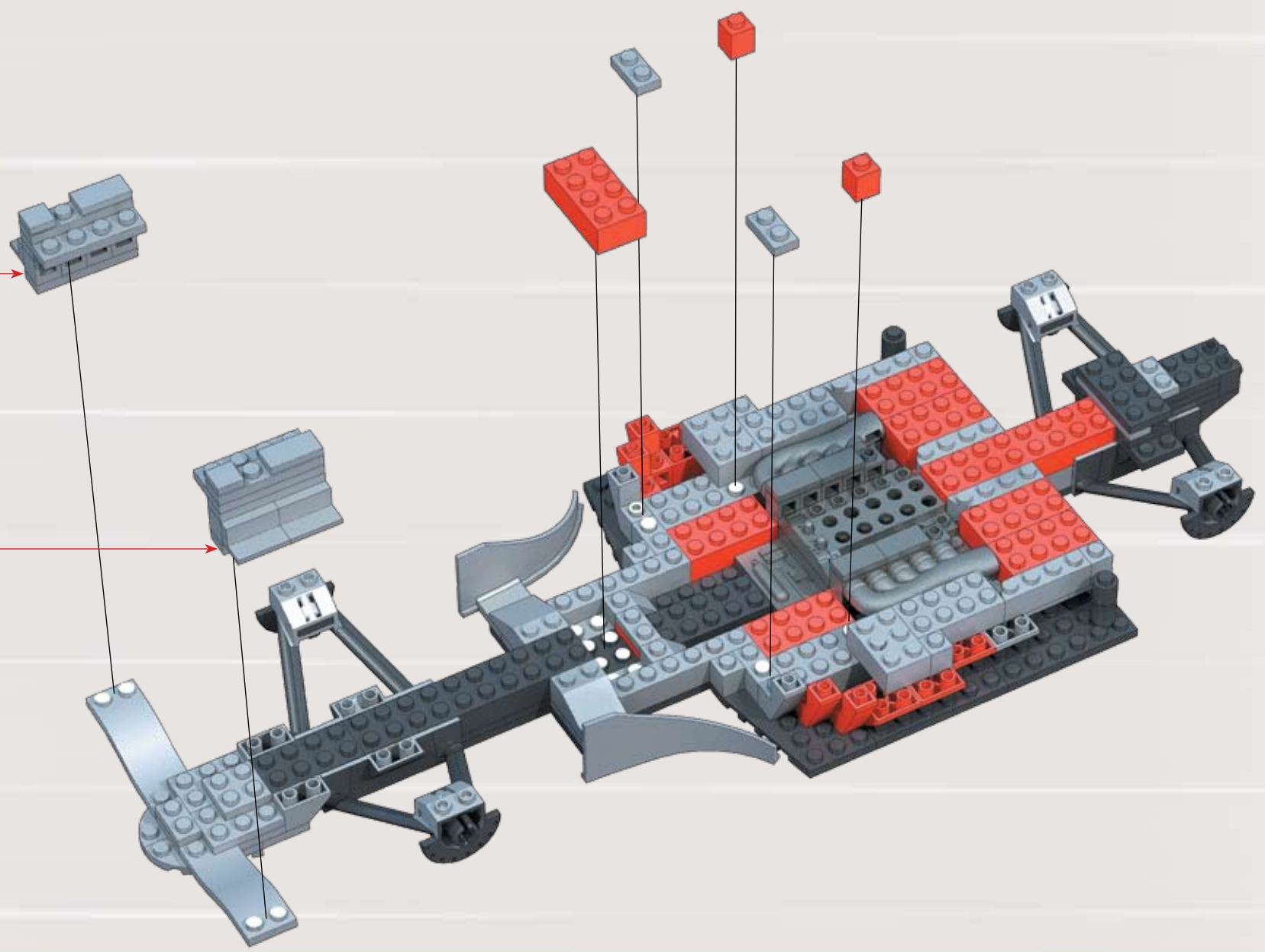
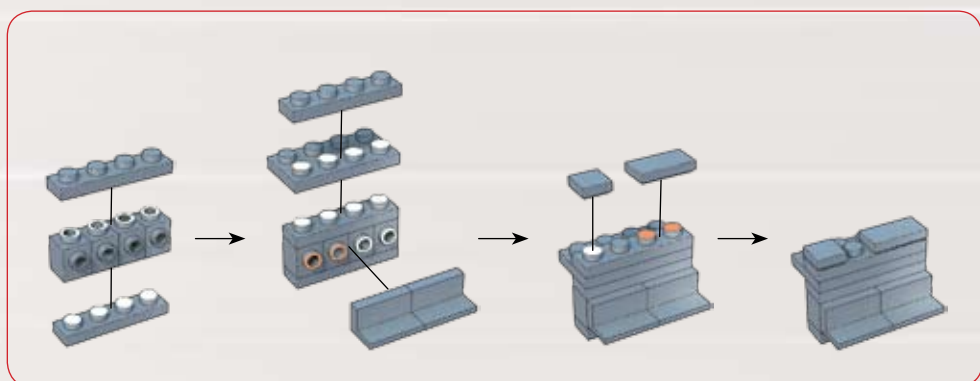
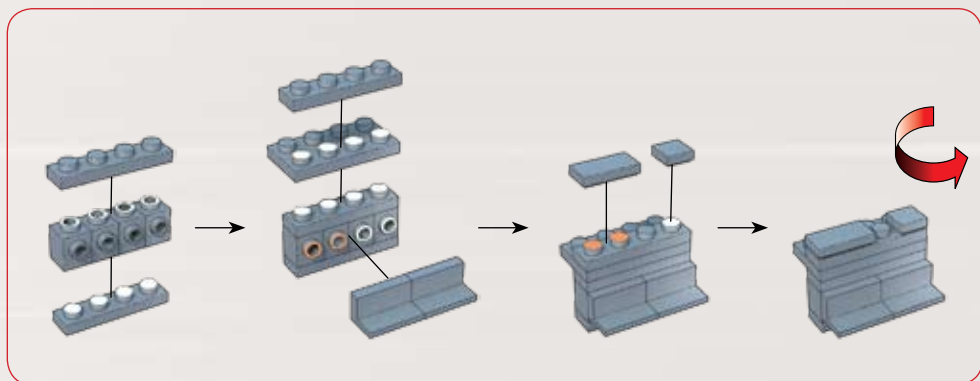

13

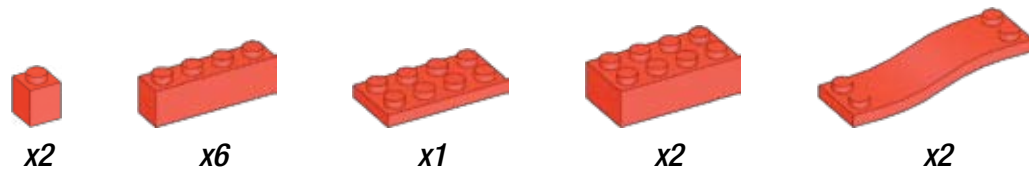

VODAFONE McLAREN MERCEDES

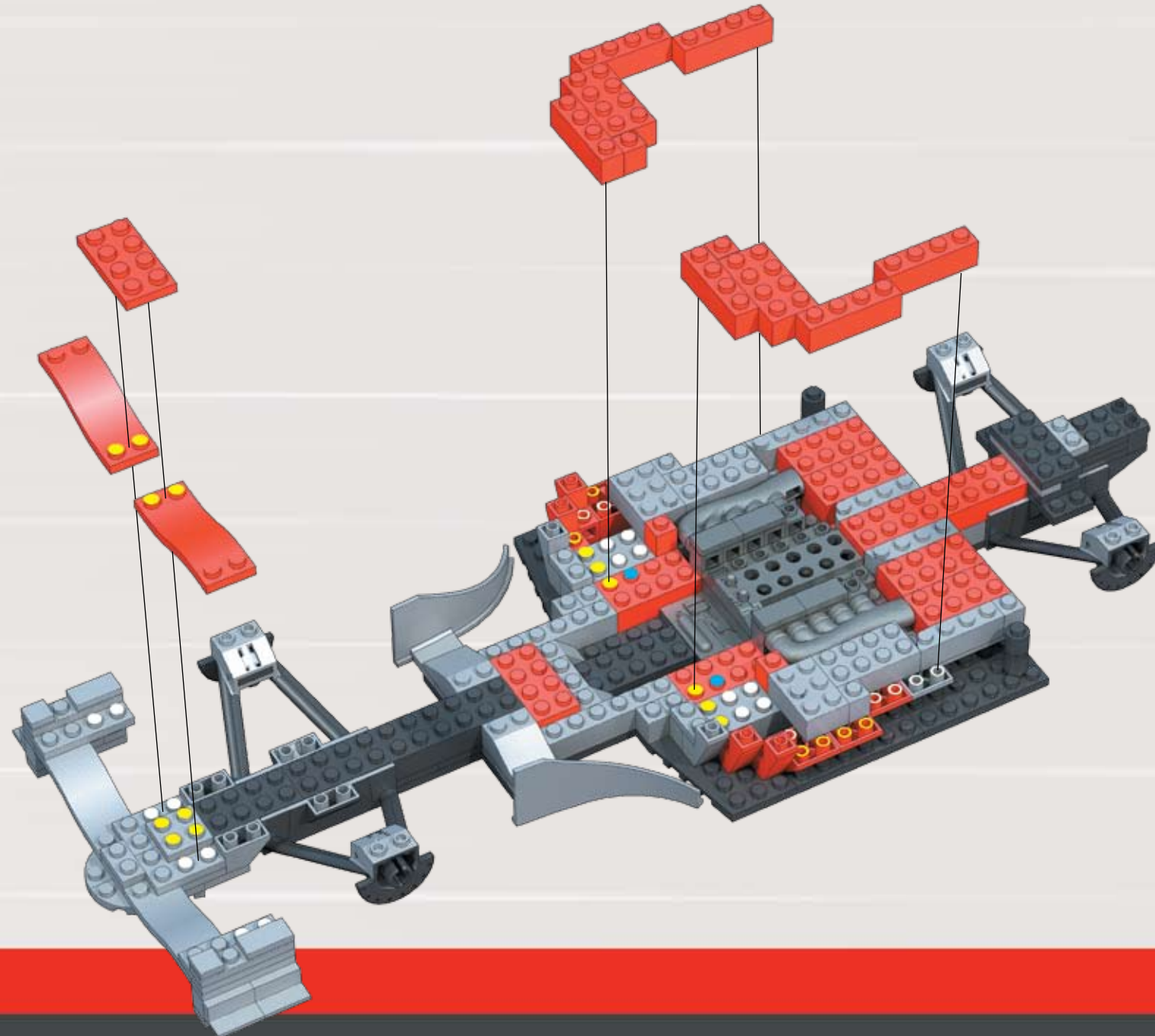

Probuilder® Advanced Building Set 8+™

14

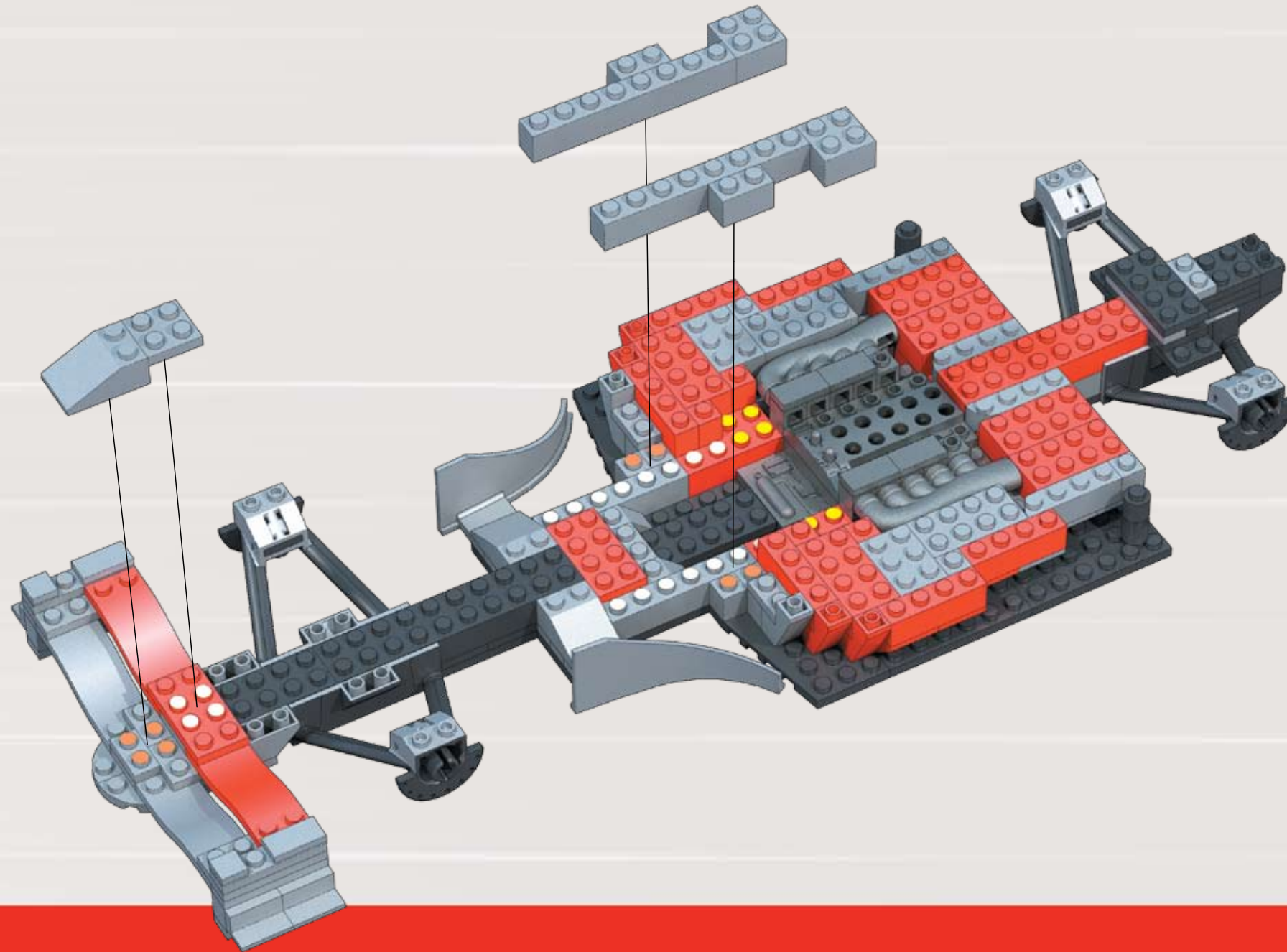
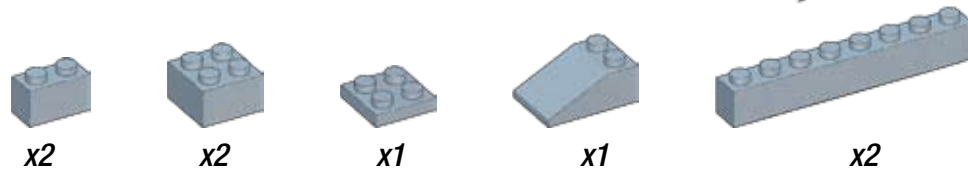

Probuilder® Advanced Building Set 8+™

16



x2



x2

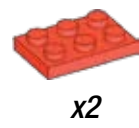

x2

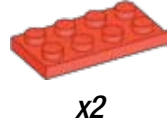

x2

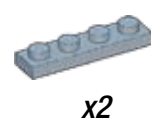

x2

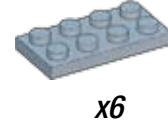

x6

VODAFONE McLAREN MERCEDES

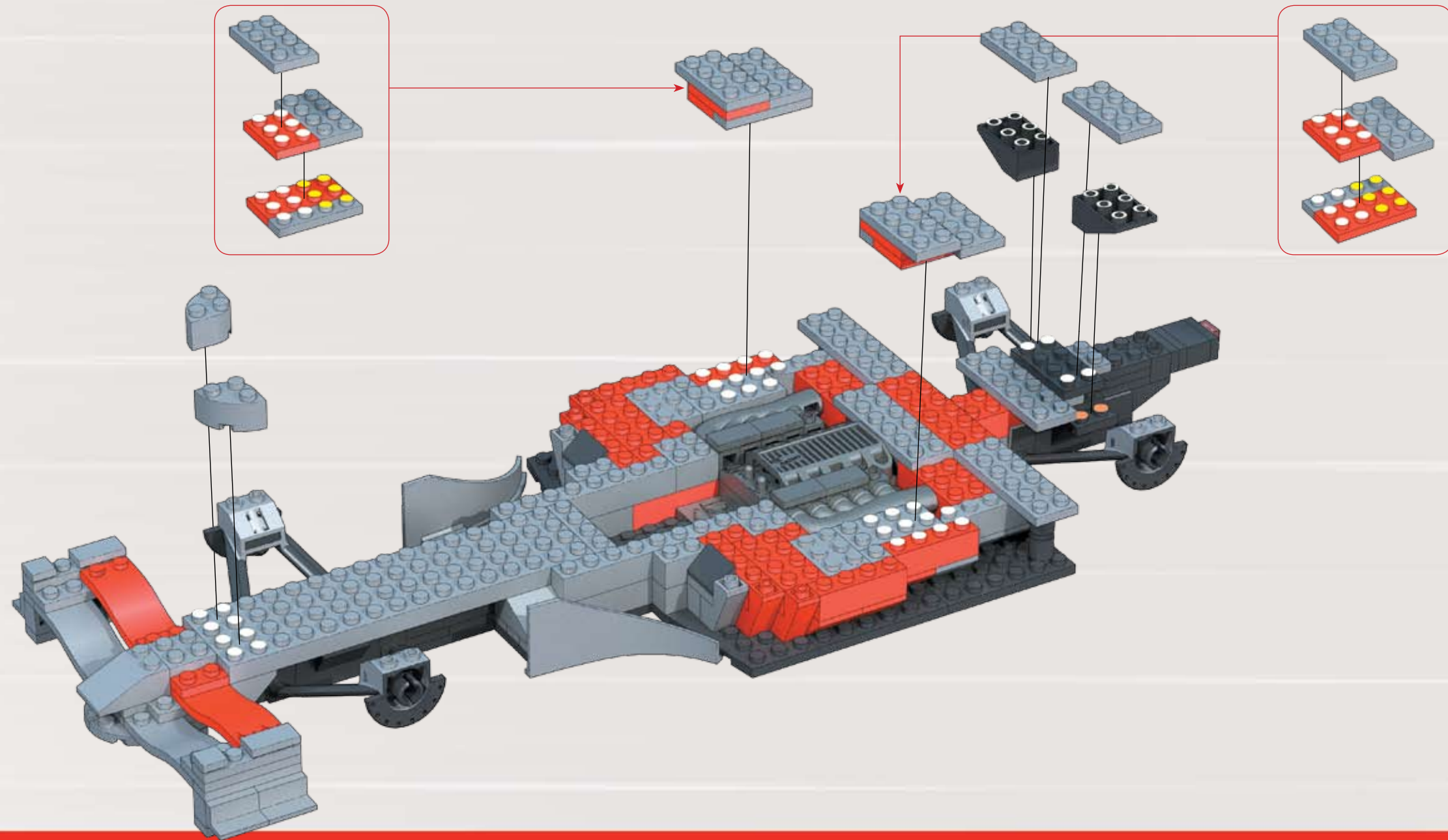

Probuilder® Advanced Building Set 8+™

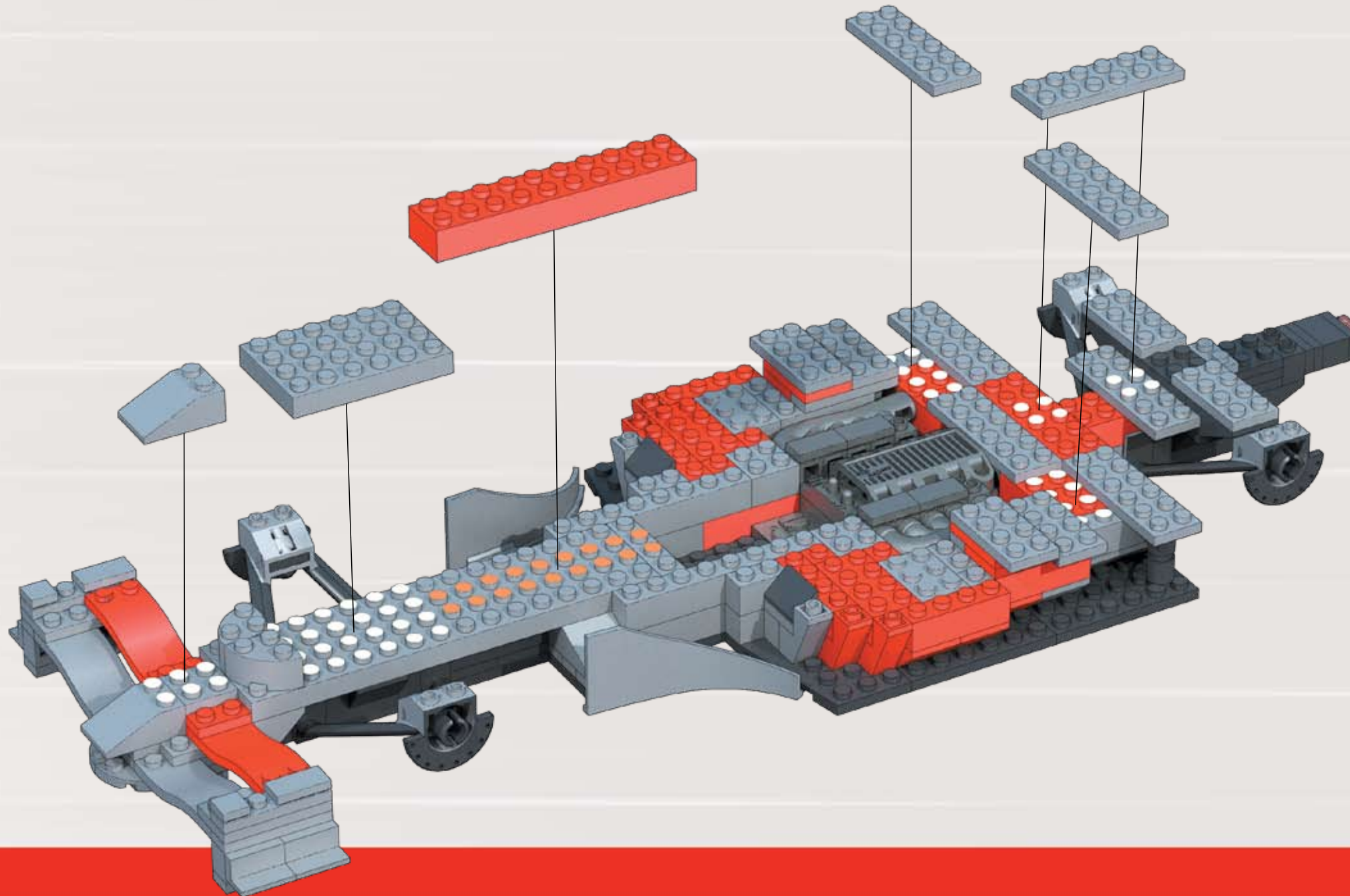
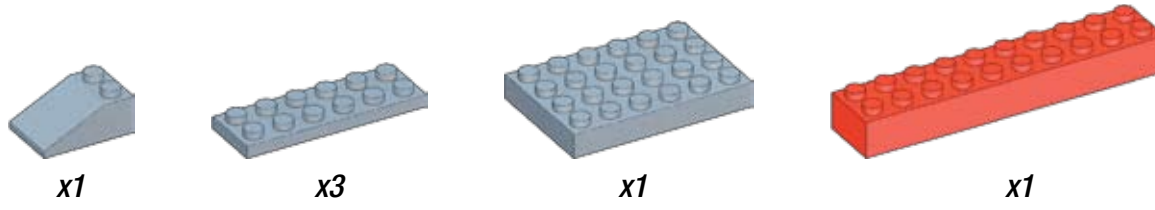

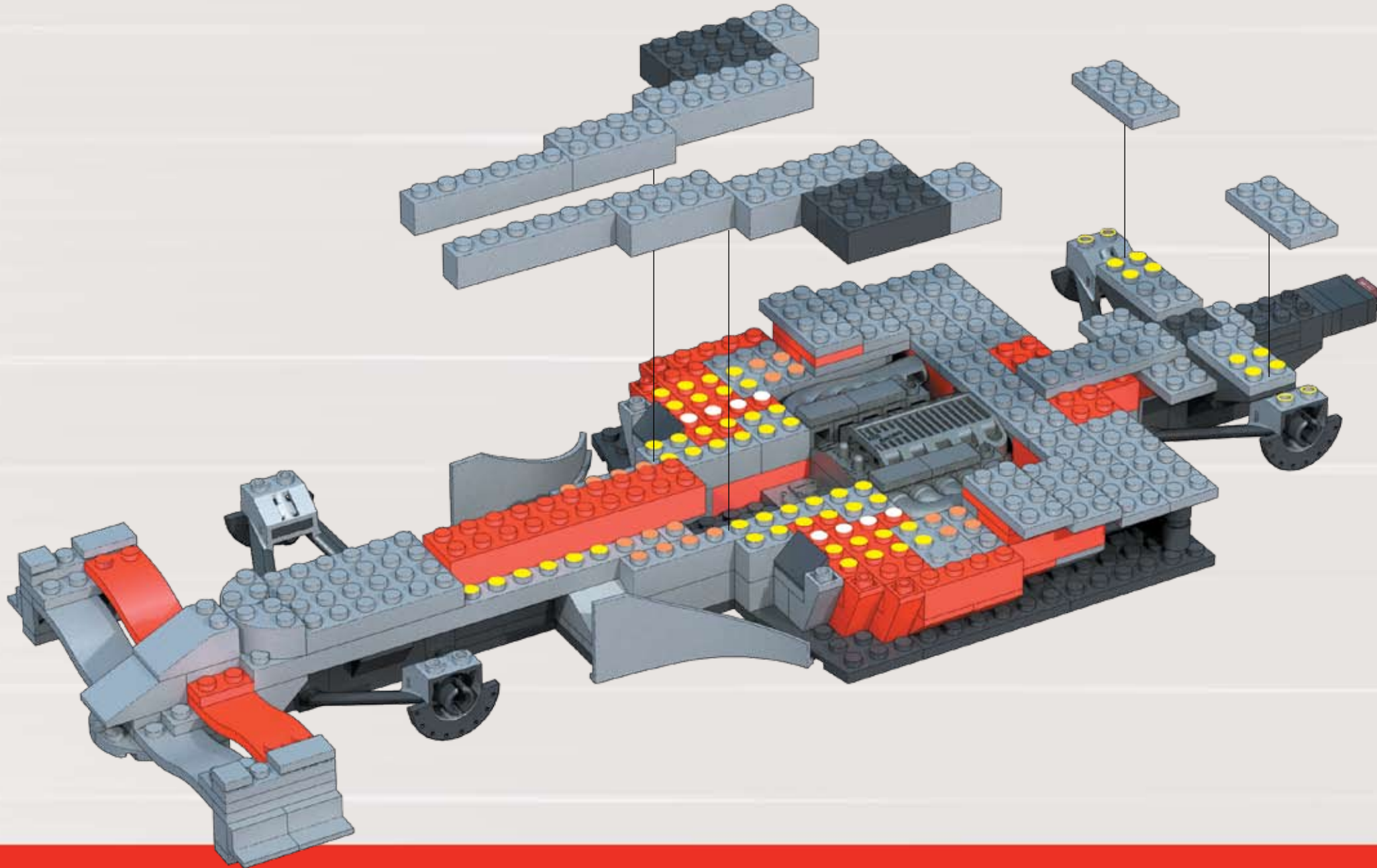
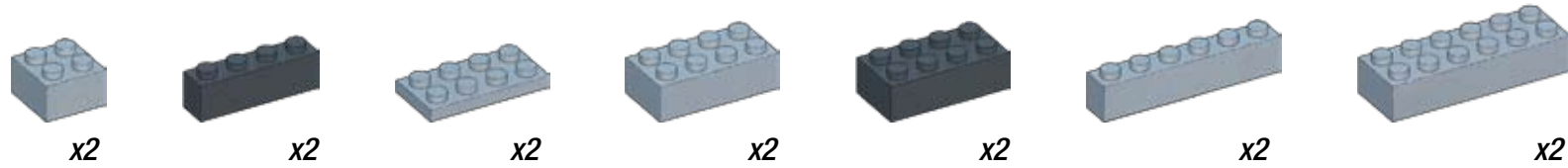

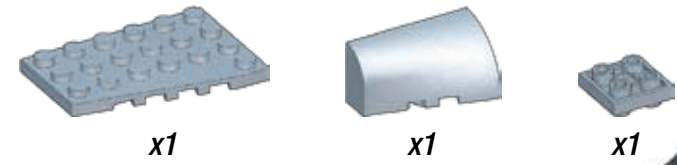
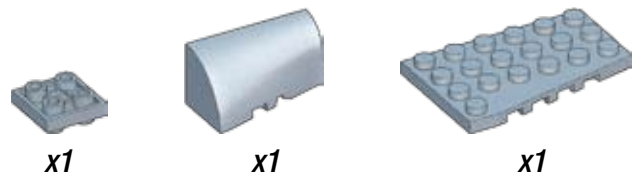



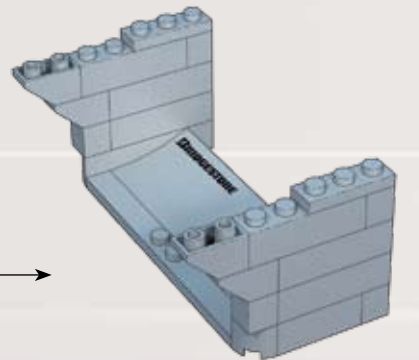
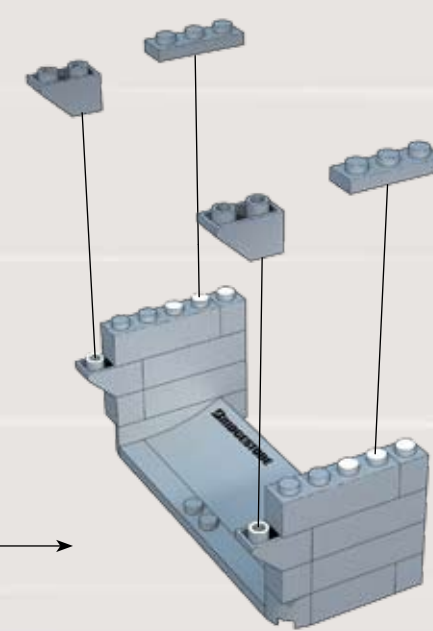
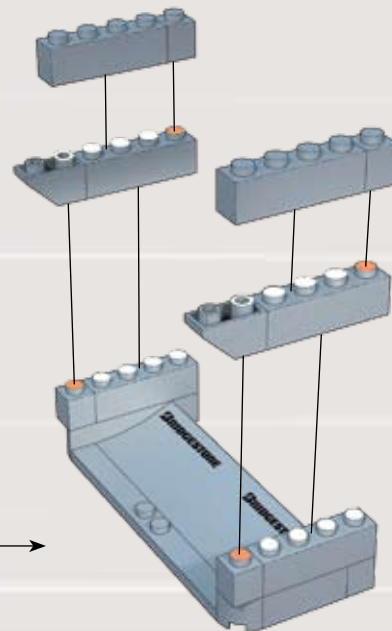
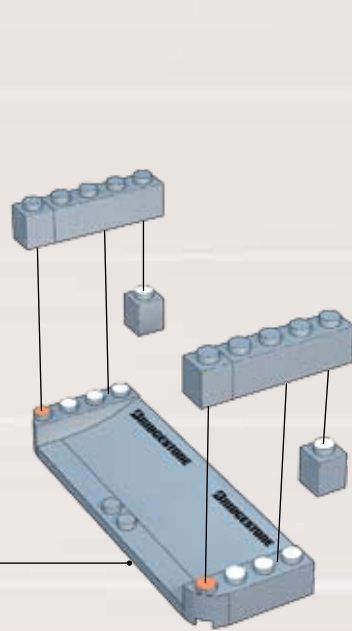
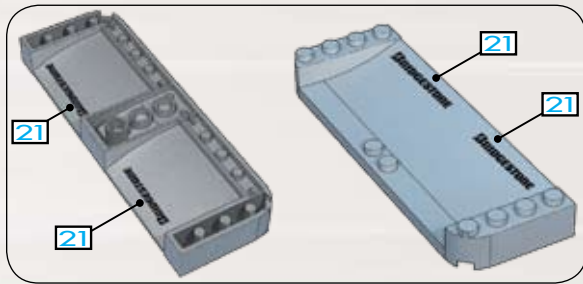
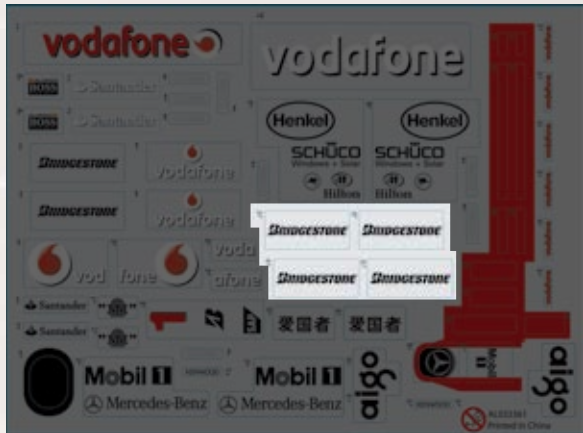
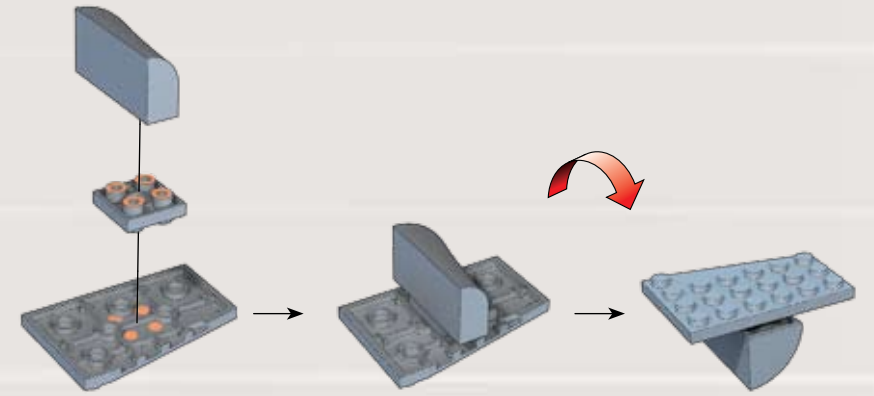
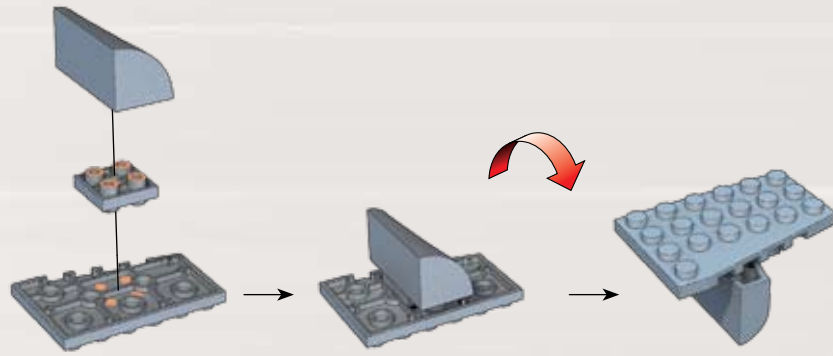



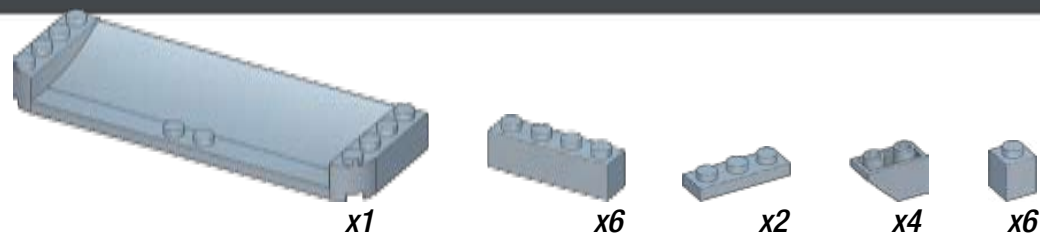

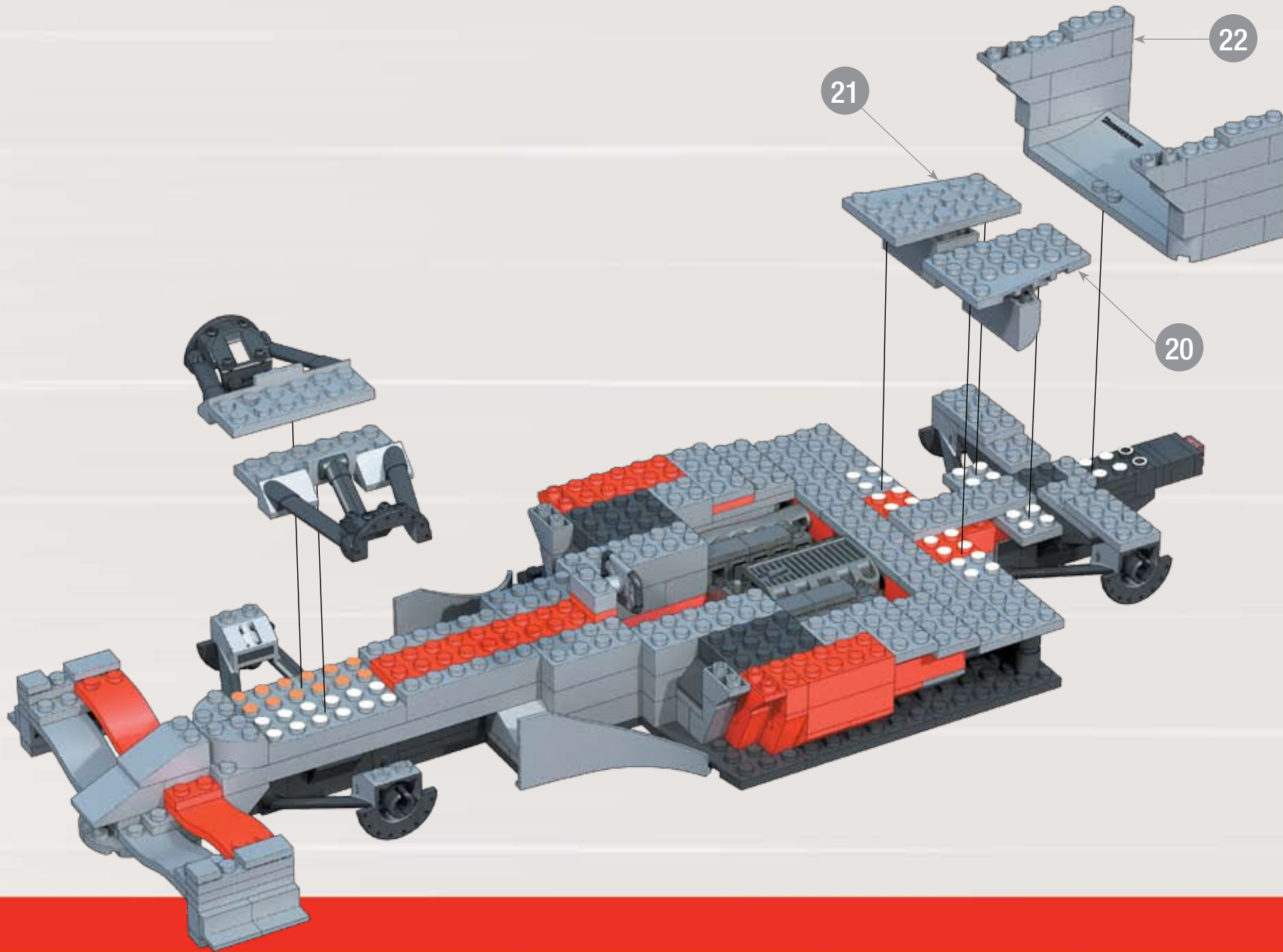



VODAFONE McLaren MERCEDES



Probuilder® Advanced Building Set 8+™





-  x1
-  x6
-  x2
-  x2
-  x2
-  x1
-  x2
-  x4
-  x2
-  x2
-  x1

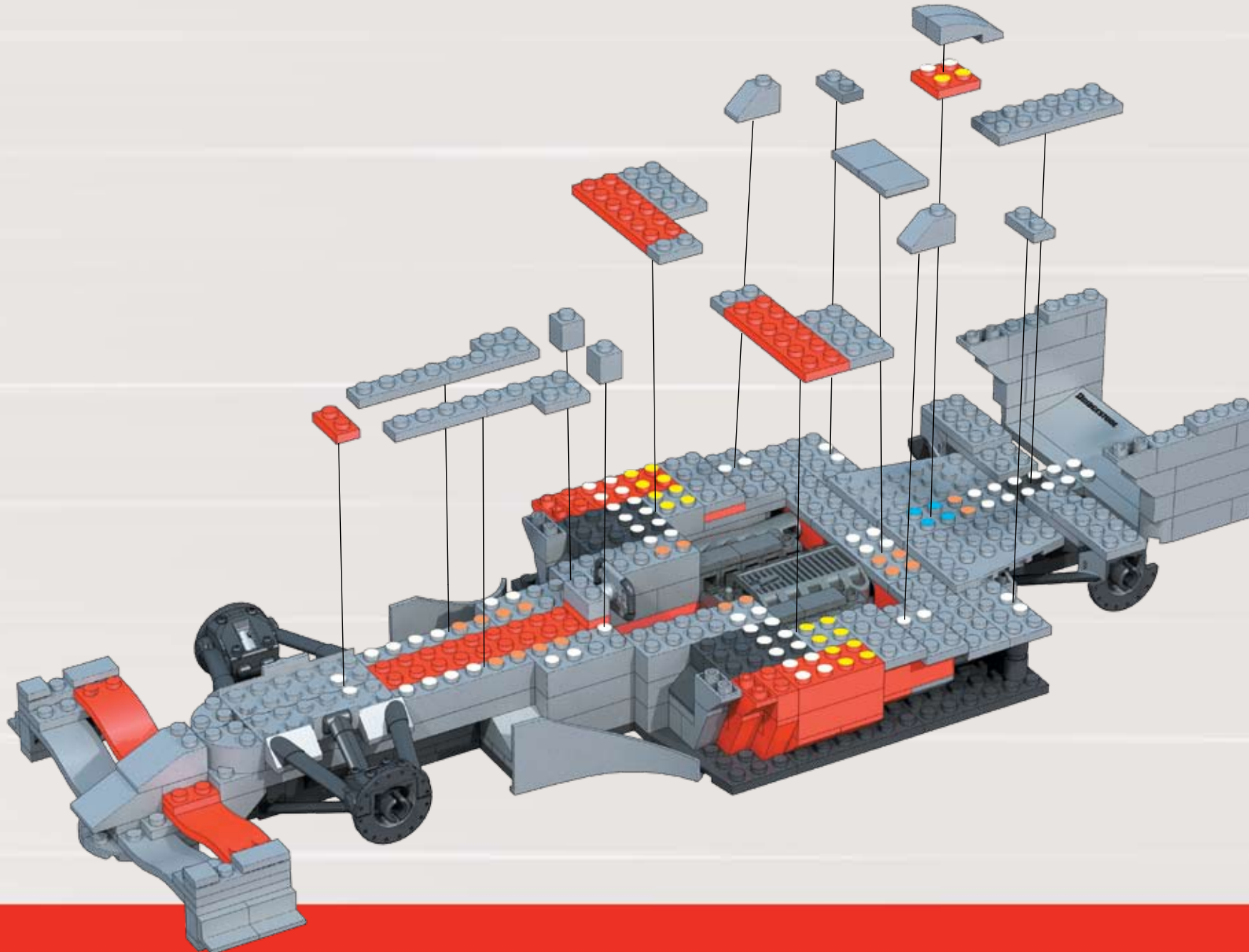

25



x2

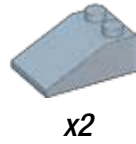

x2



x1



x1

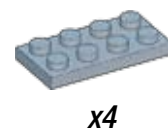

x4

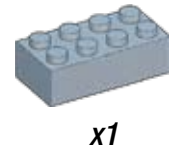

x1

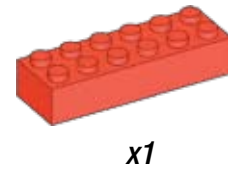

x1

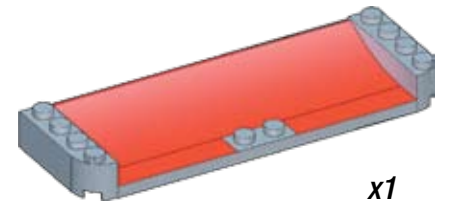

x1

VODAFONE McLAREN MERCEDES

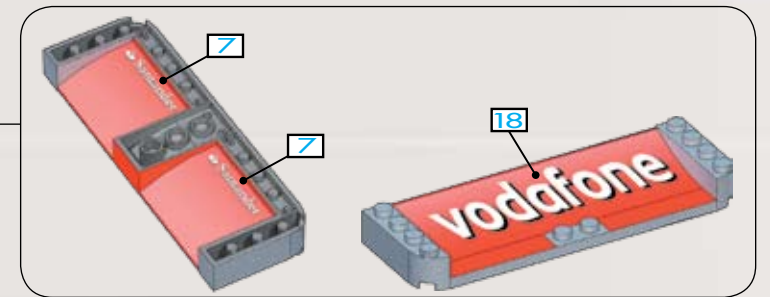
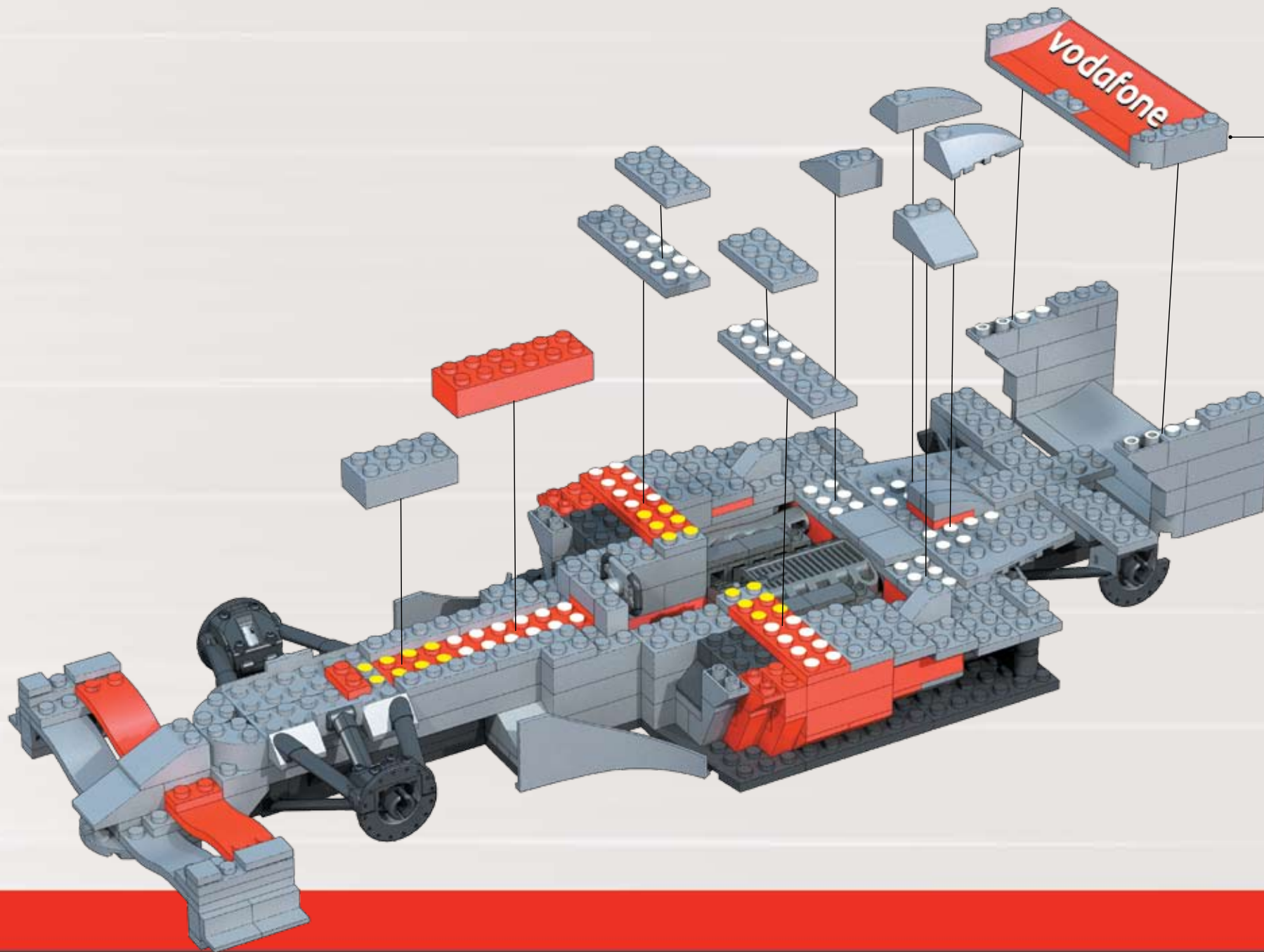

Probuilder® Advanced Building Set 8+™

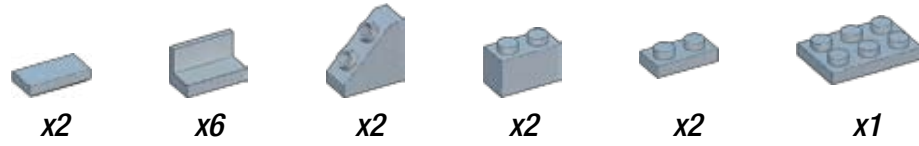

VODAFONE McLAREN MERCEDES

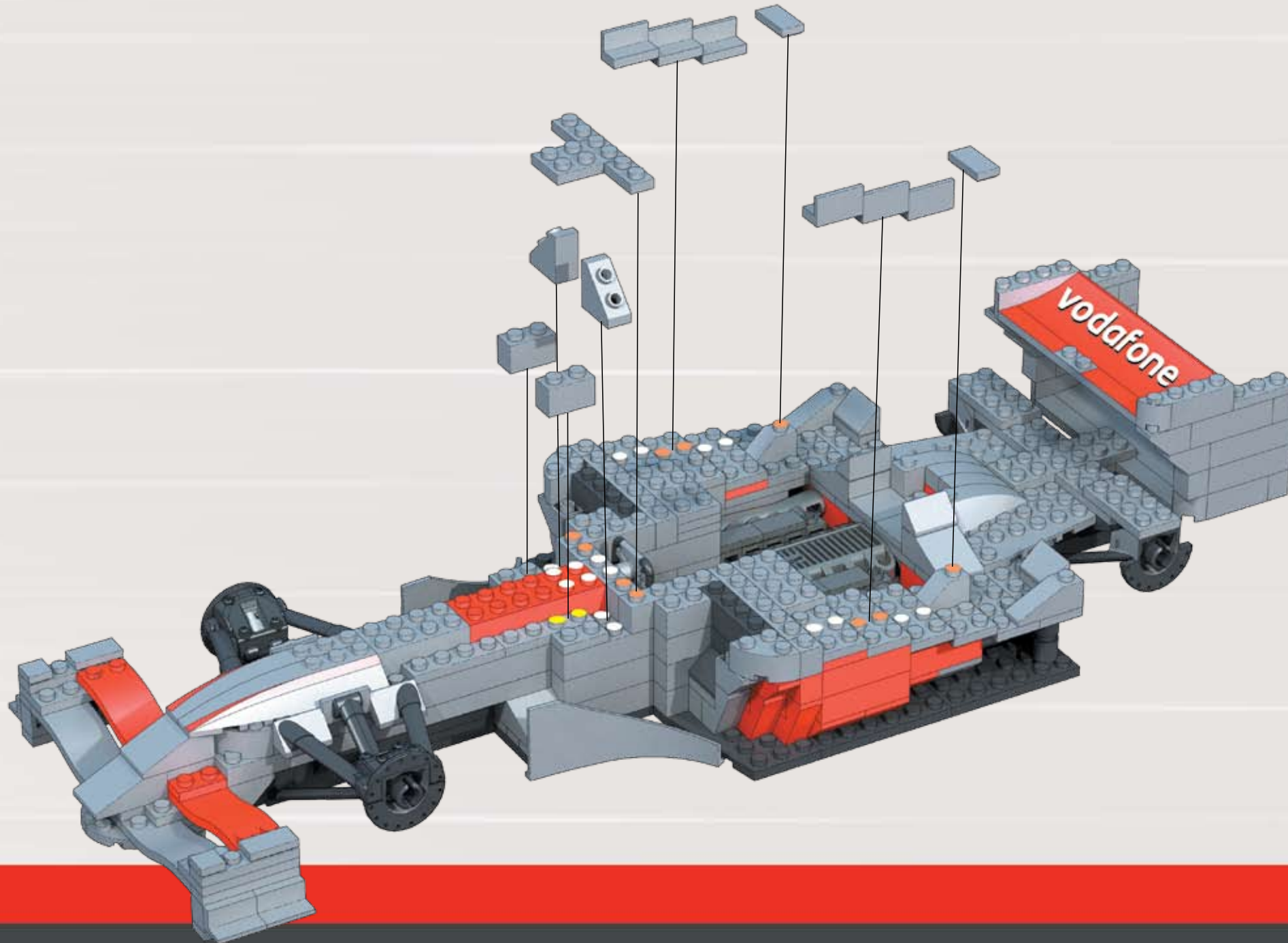

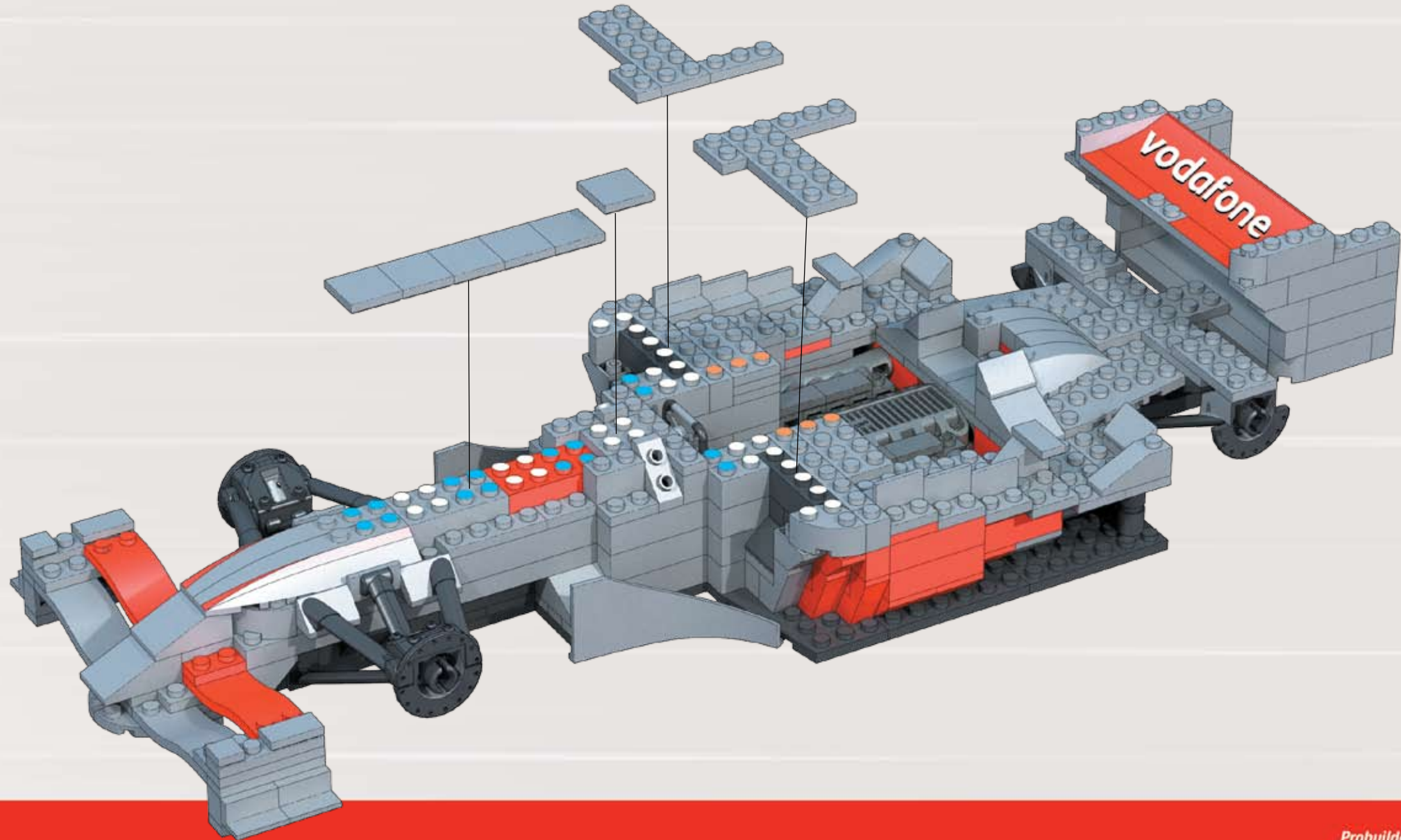
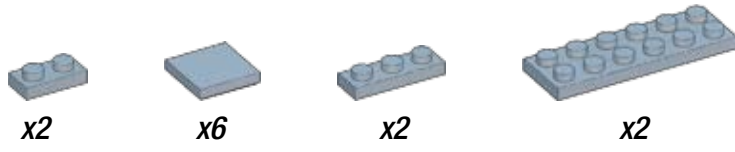



x2



x18

VODAFONE McLAREN MERCEDES

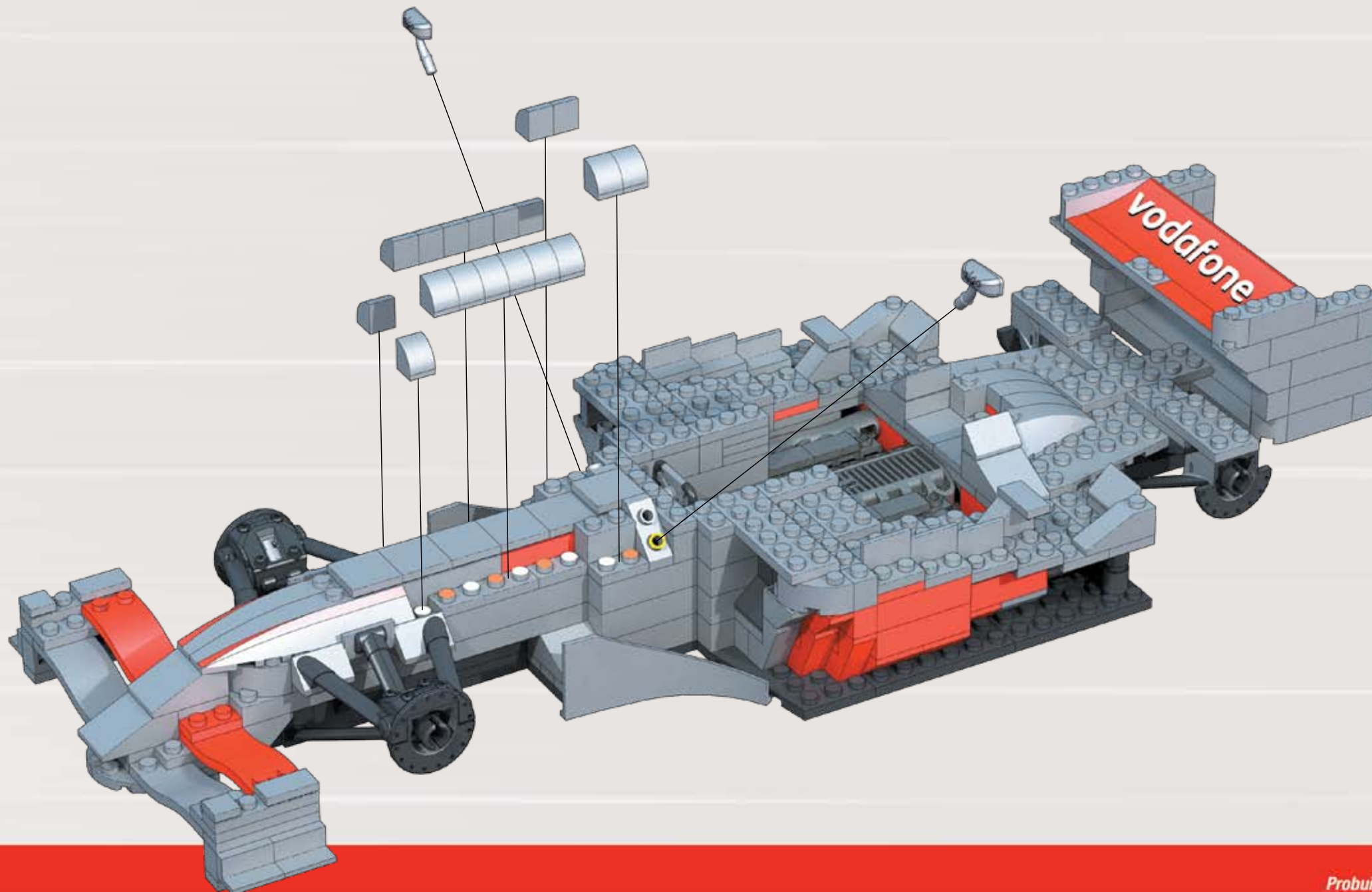

30



x1

VODAFONE McLAREN MERCEDES

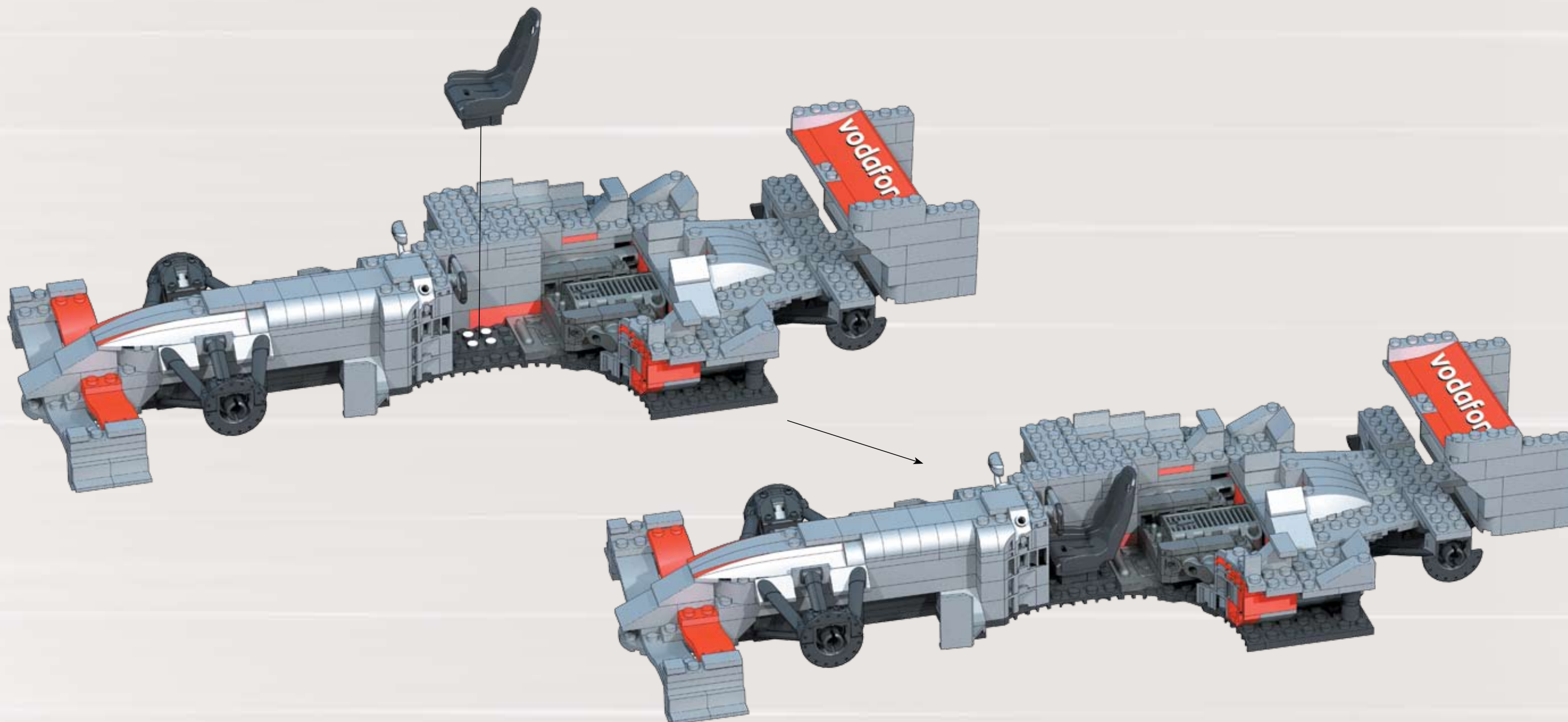

Probuilder® Advanced Building Set 8+™

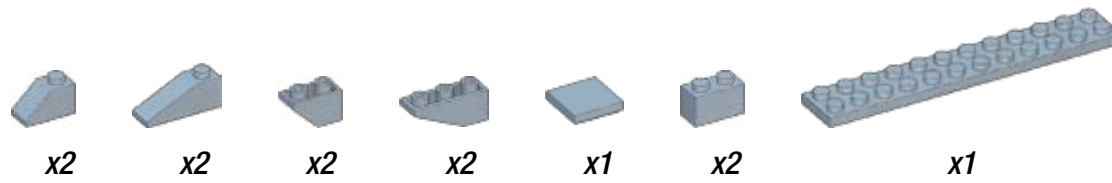

VODAFONE McLAREN MERCEDES

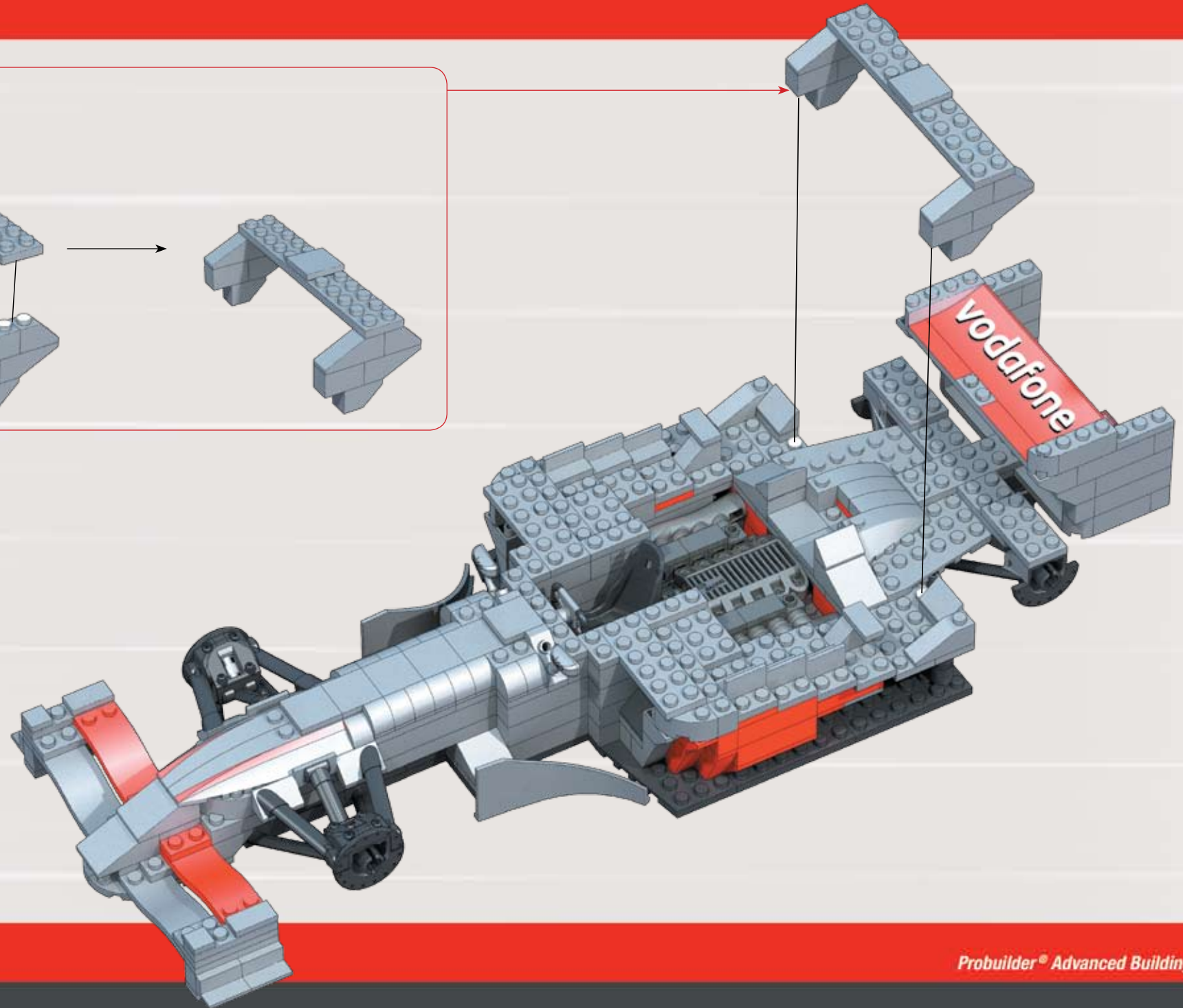
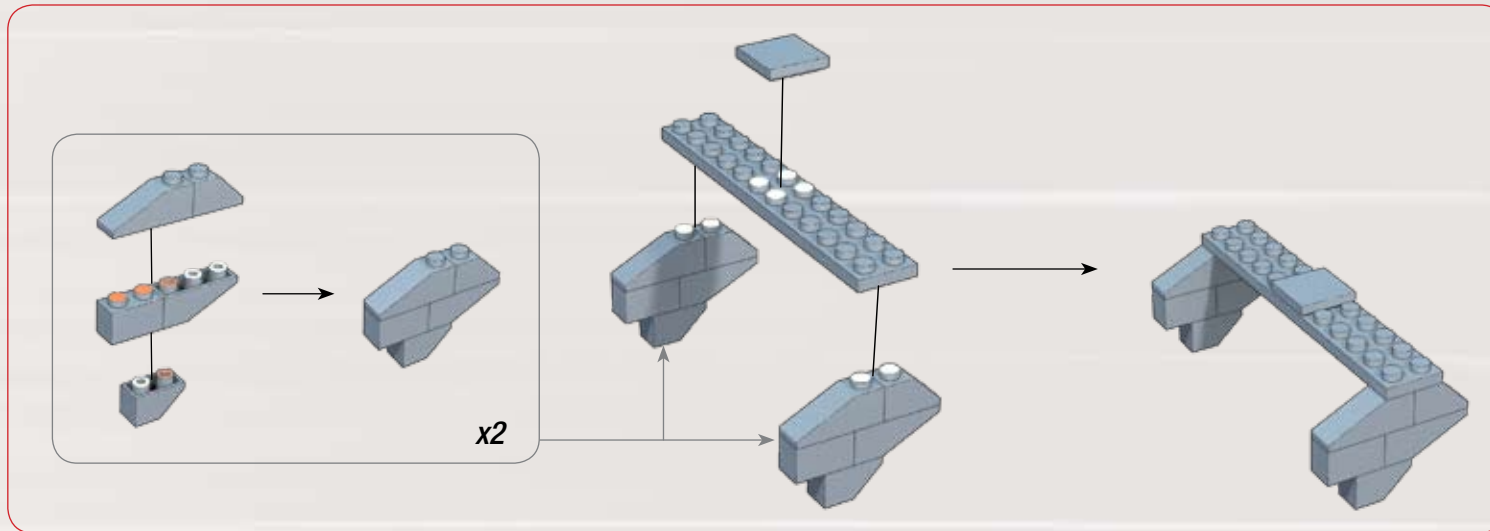

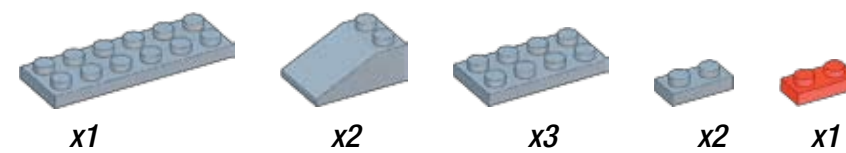
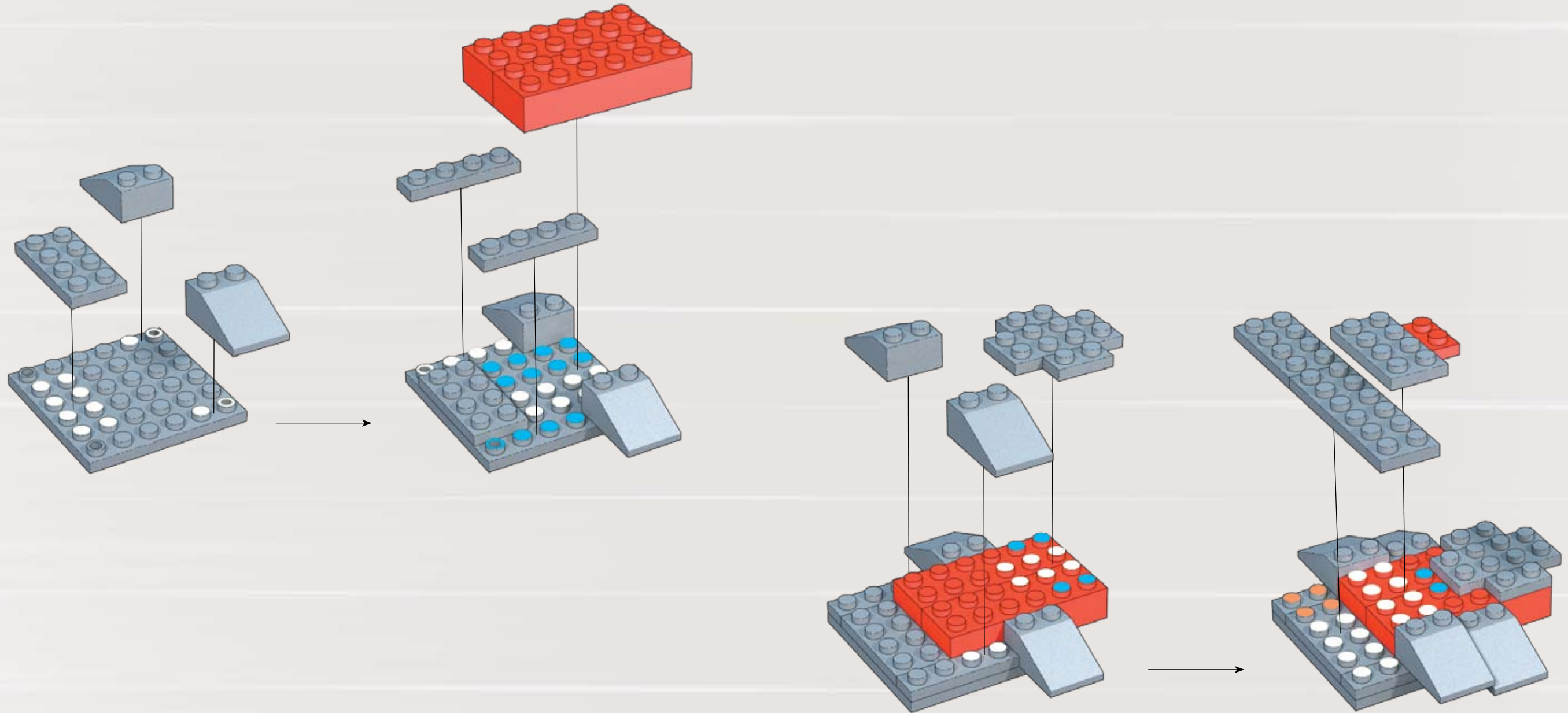
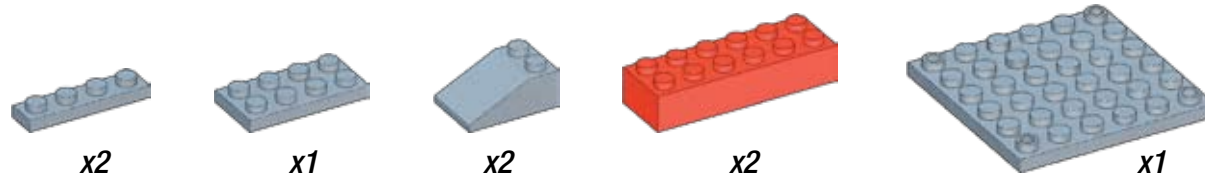

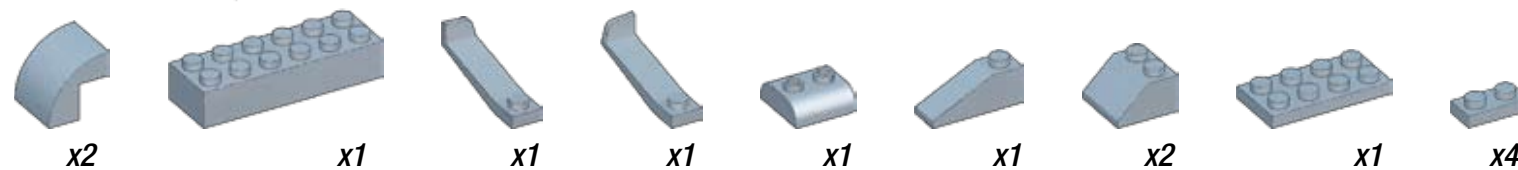
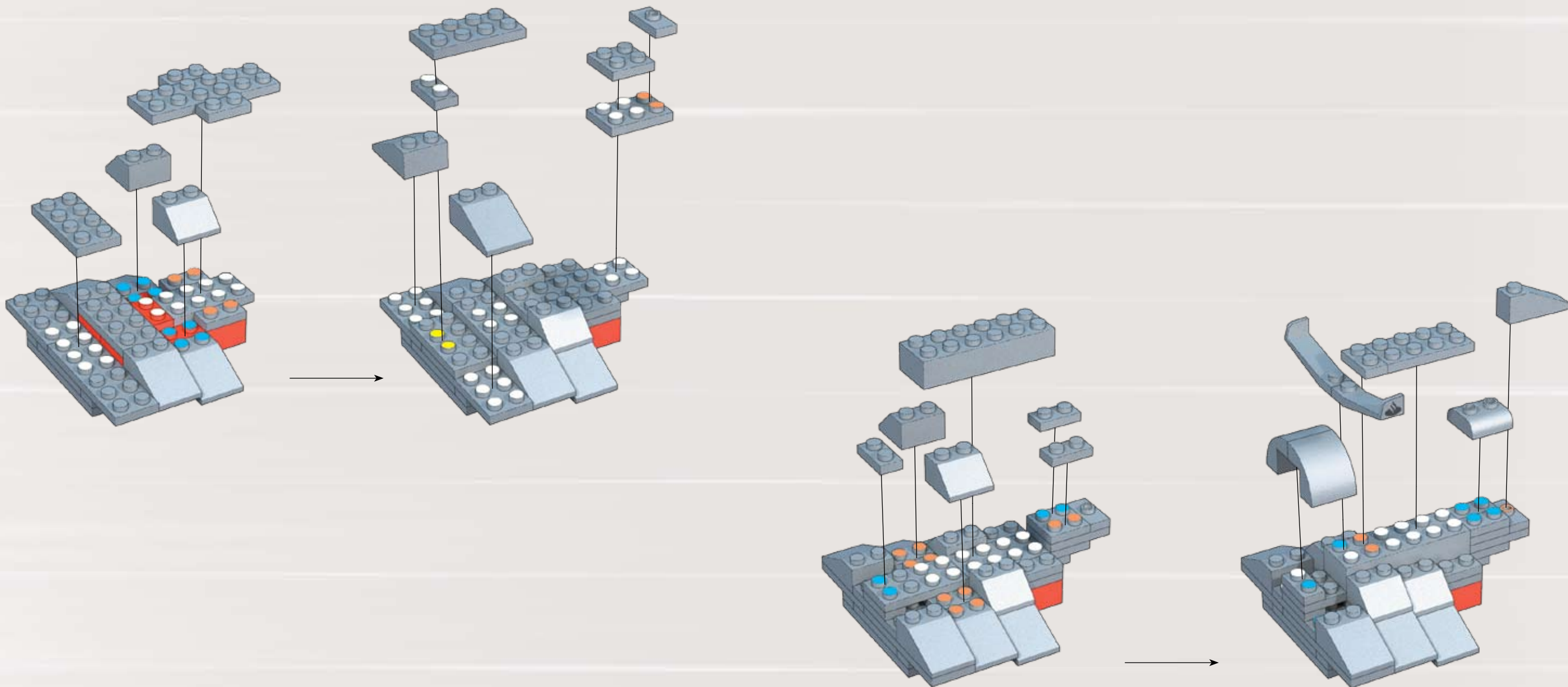
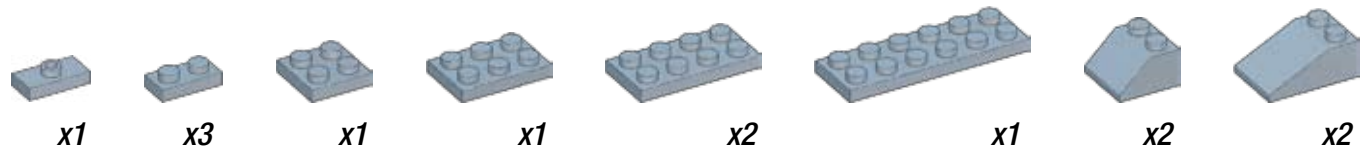

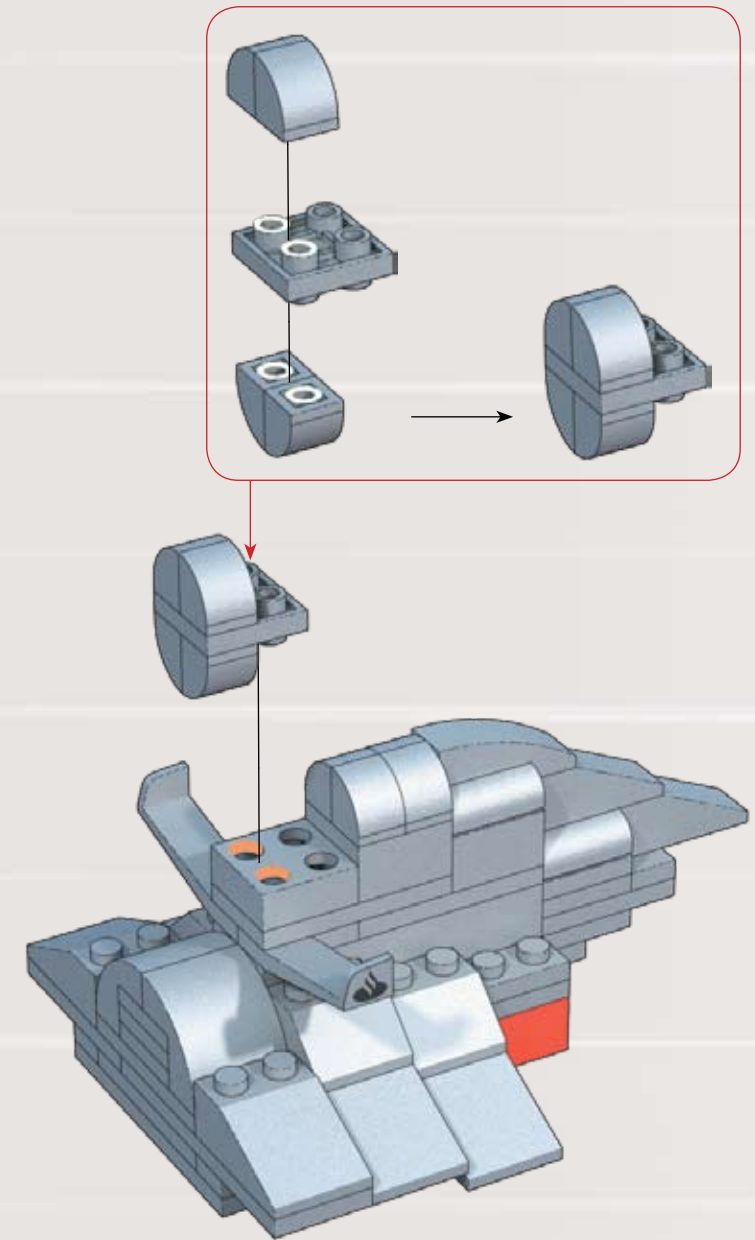
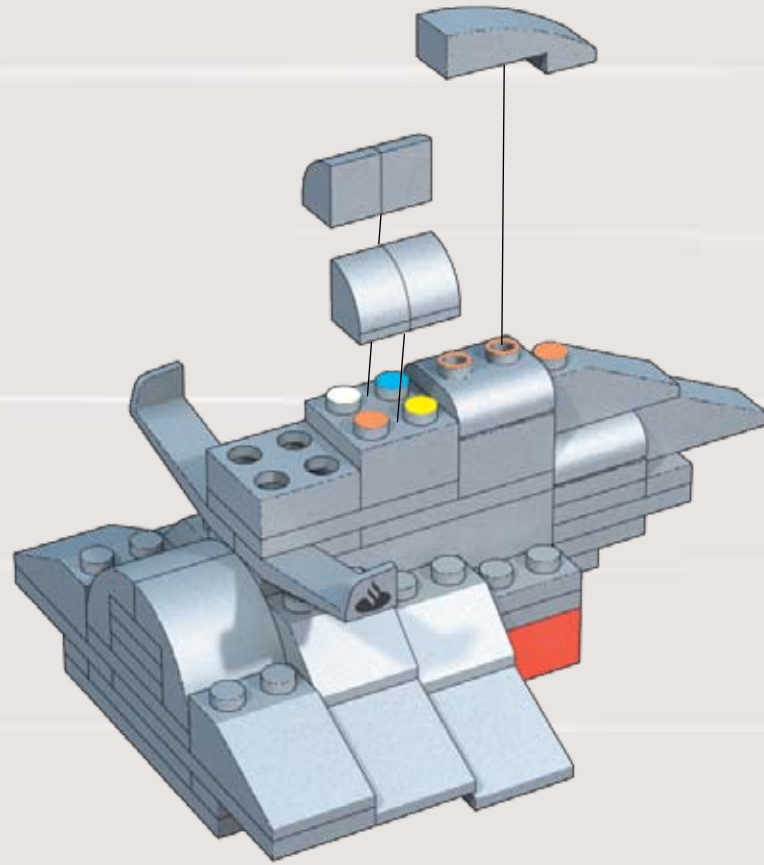
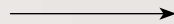
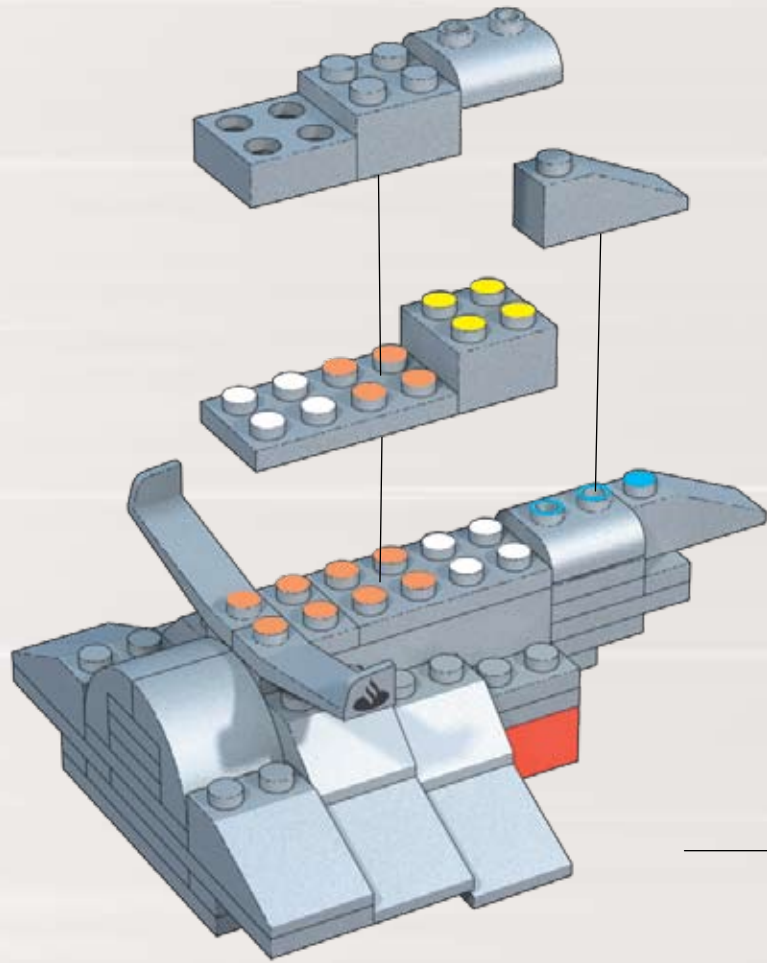
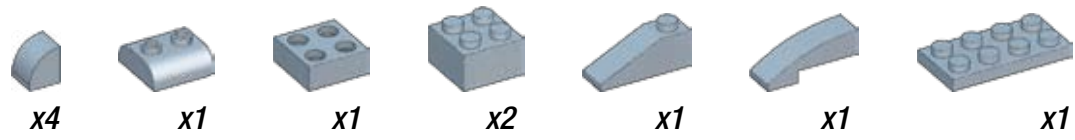

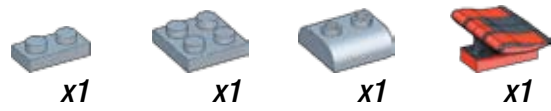

VODAFONE McLAREN MERCEDES

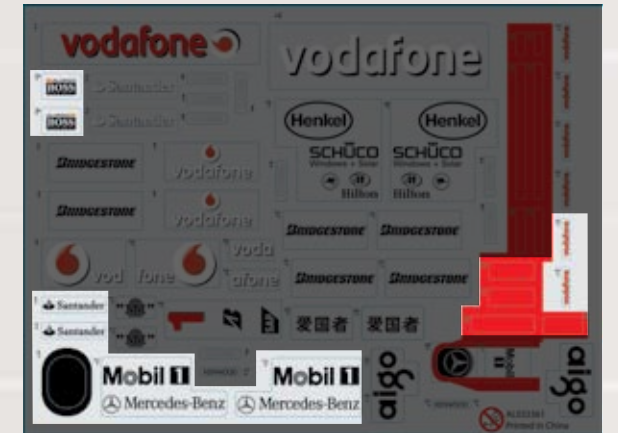
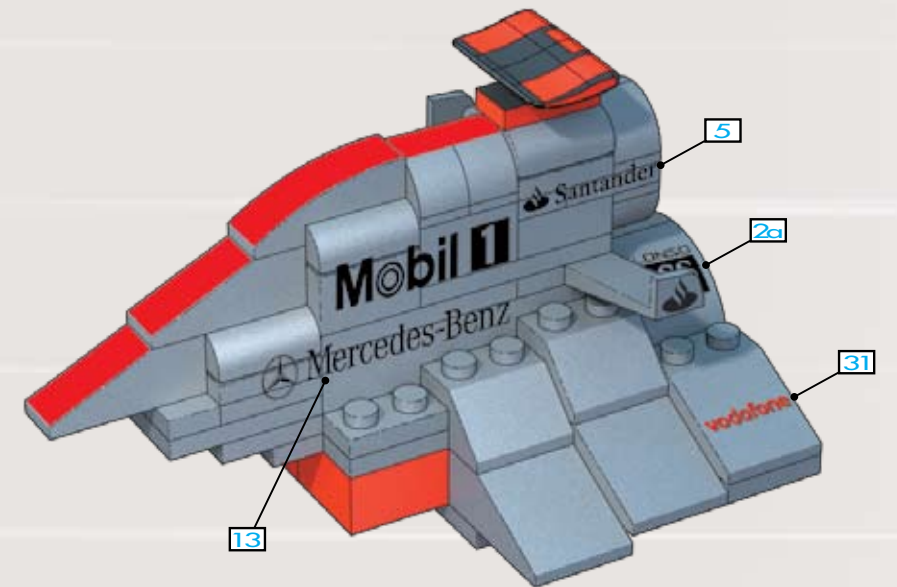
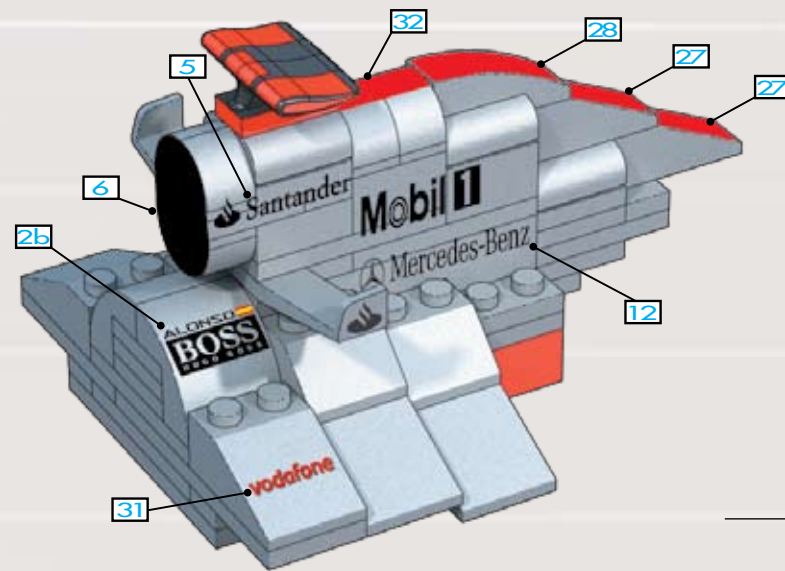
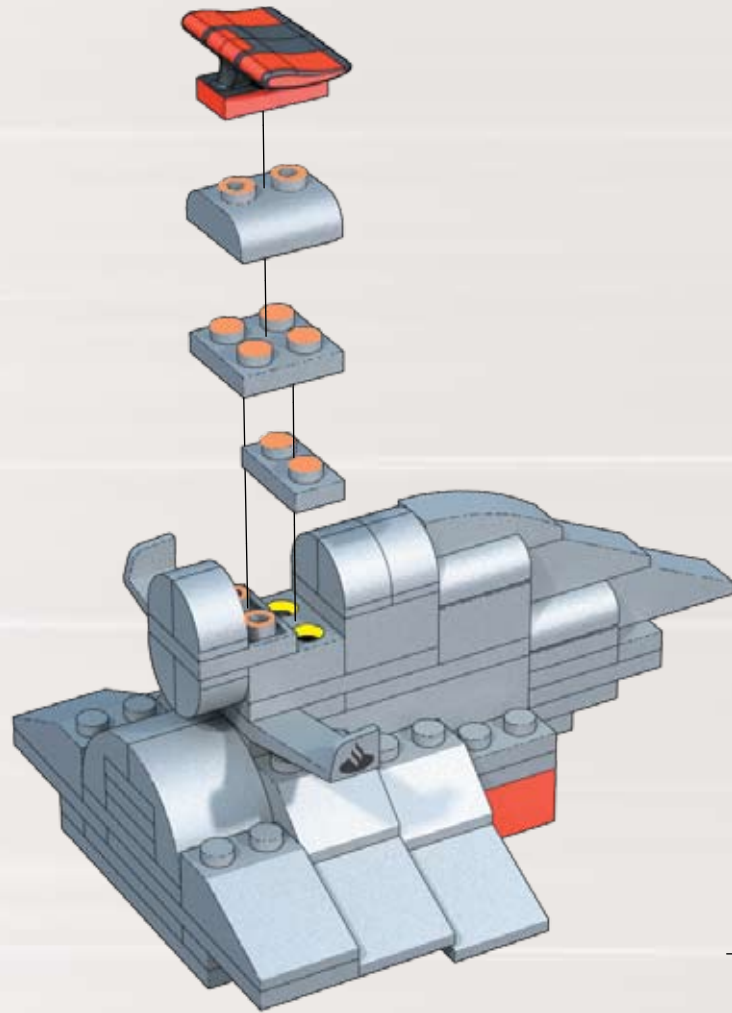

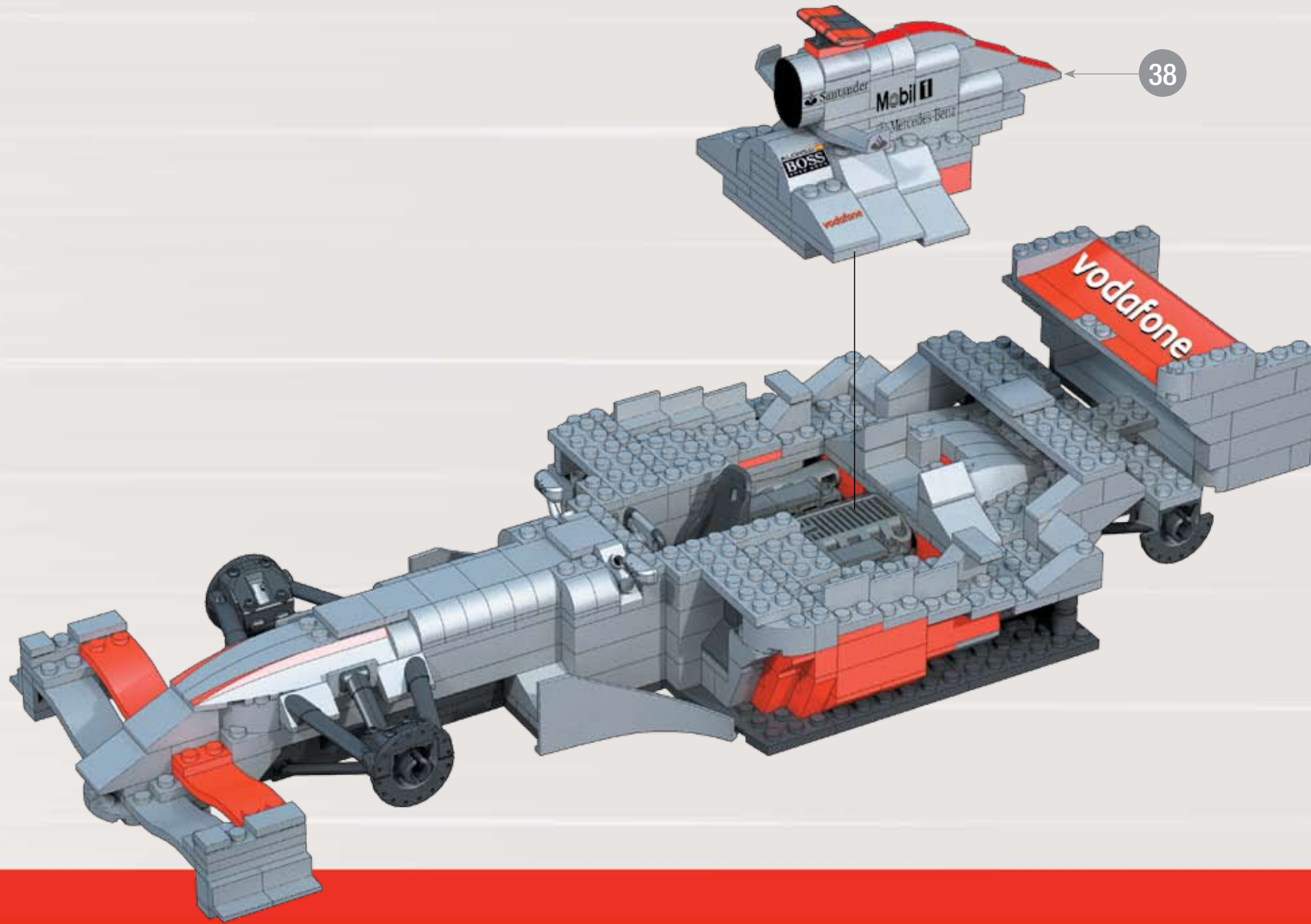

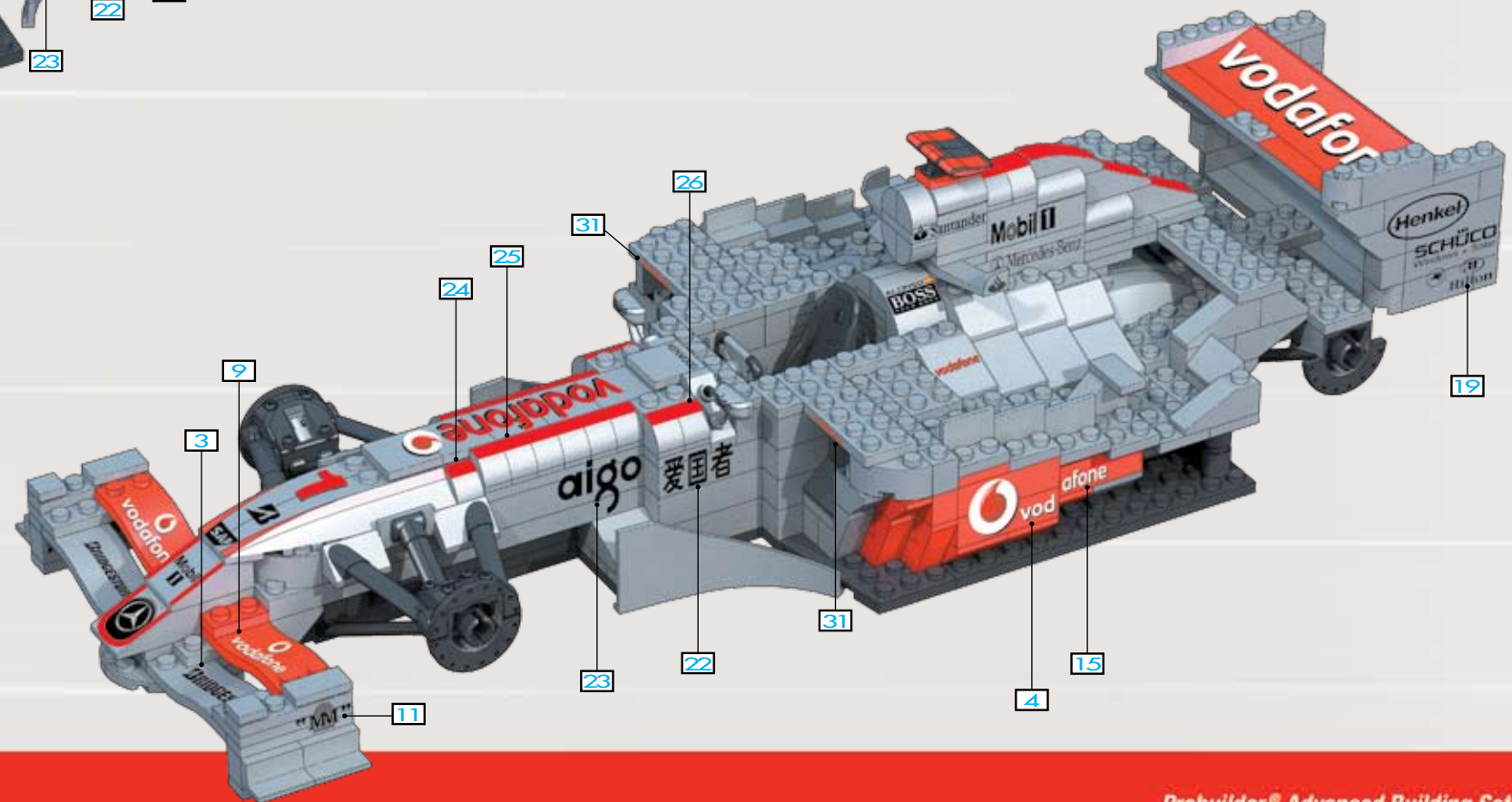
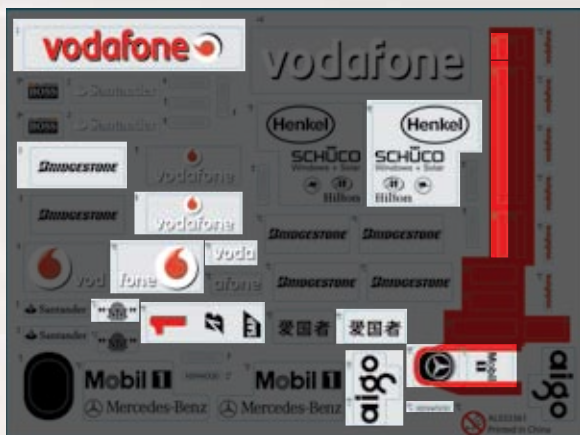
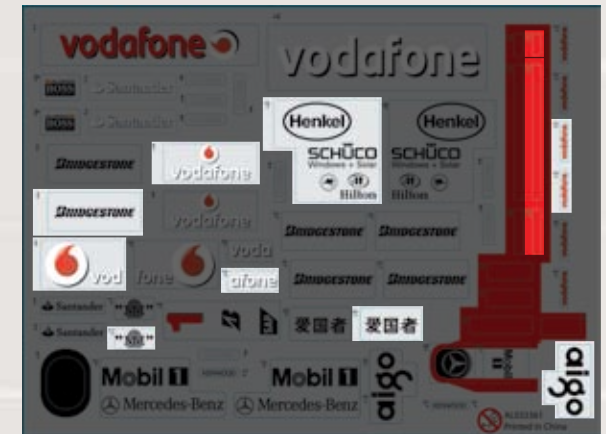
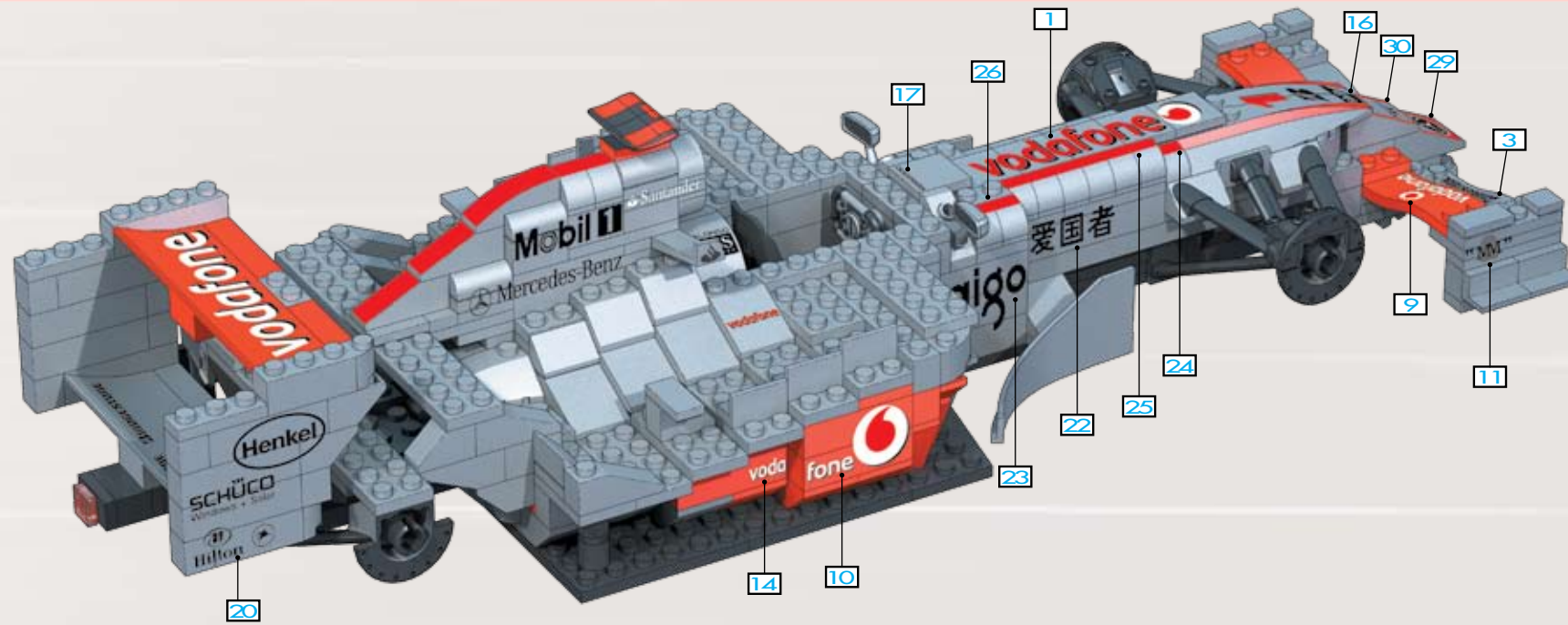

42



VODAFONE McLaren MERCEDES

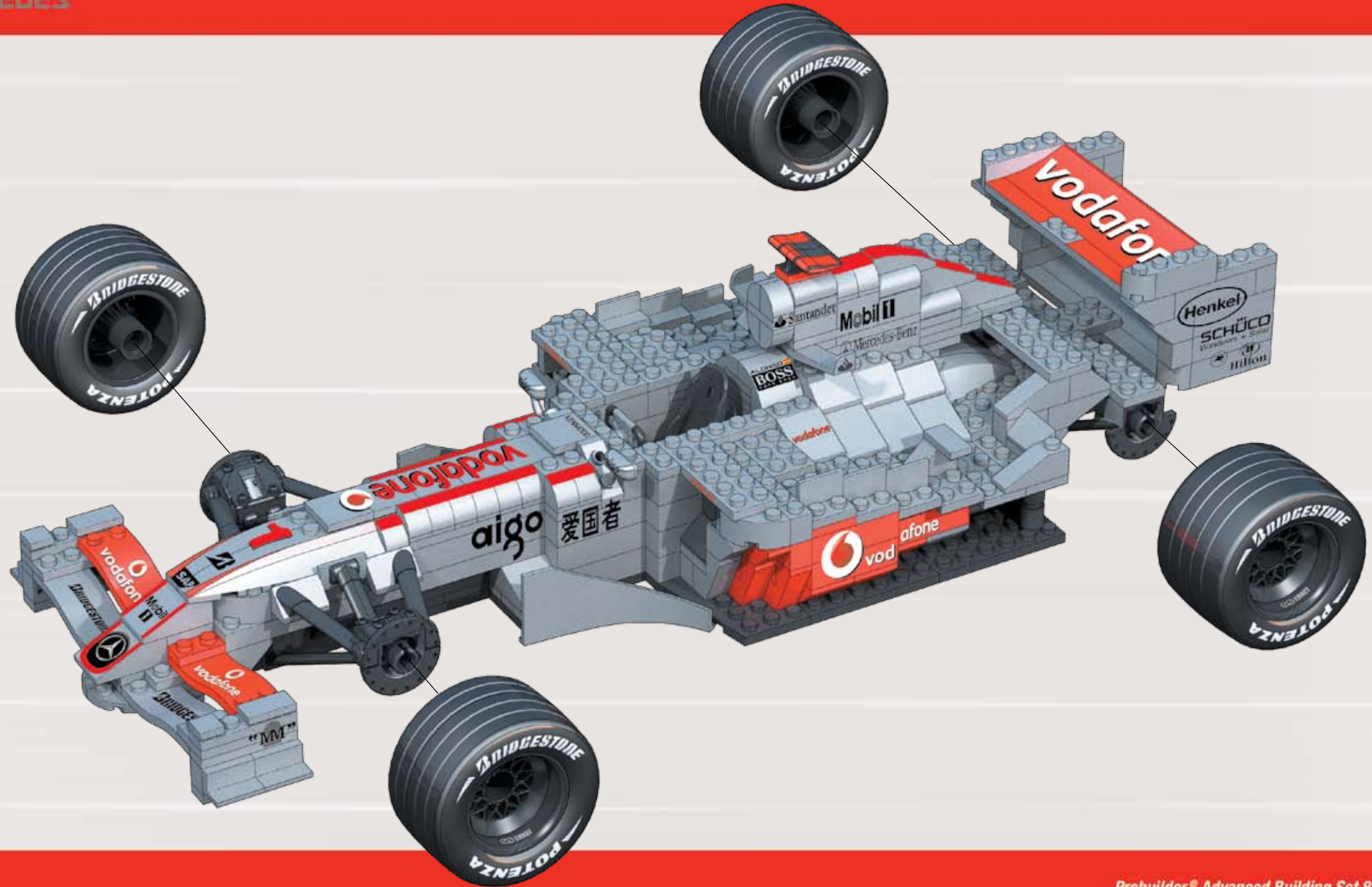
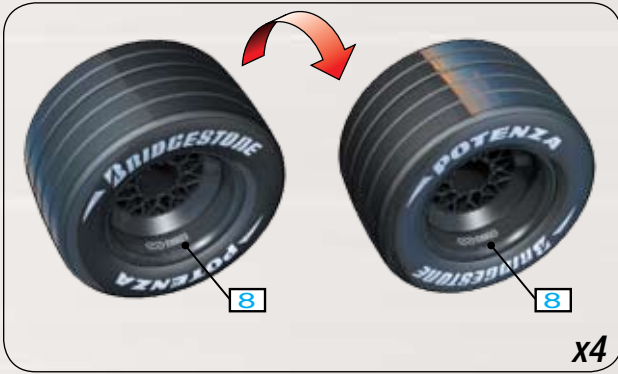

Probuilder® Advanced Building Set 8+™

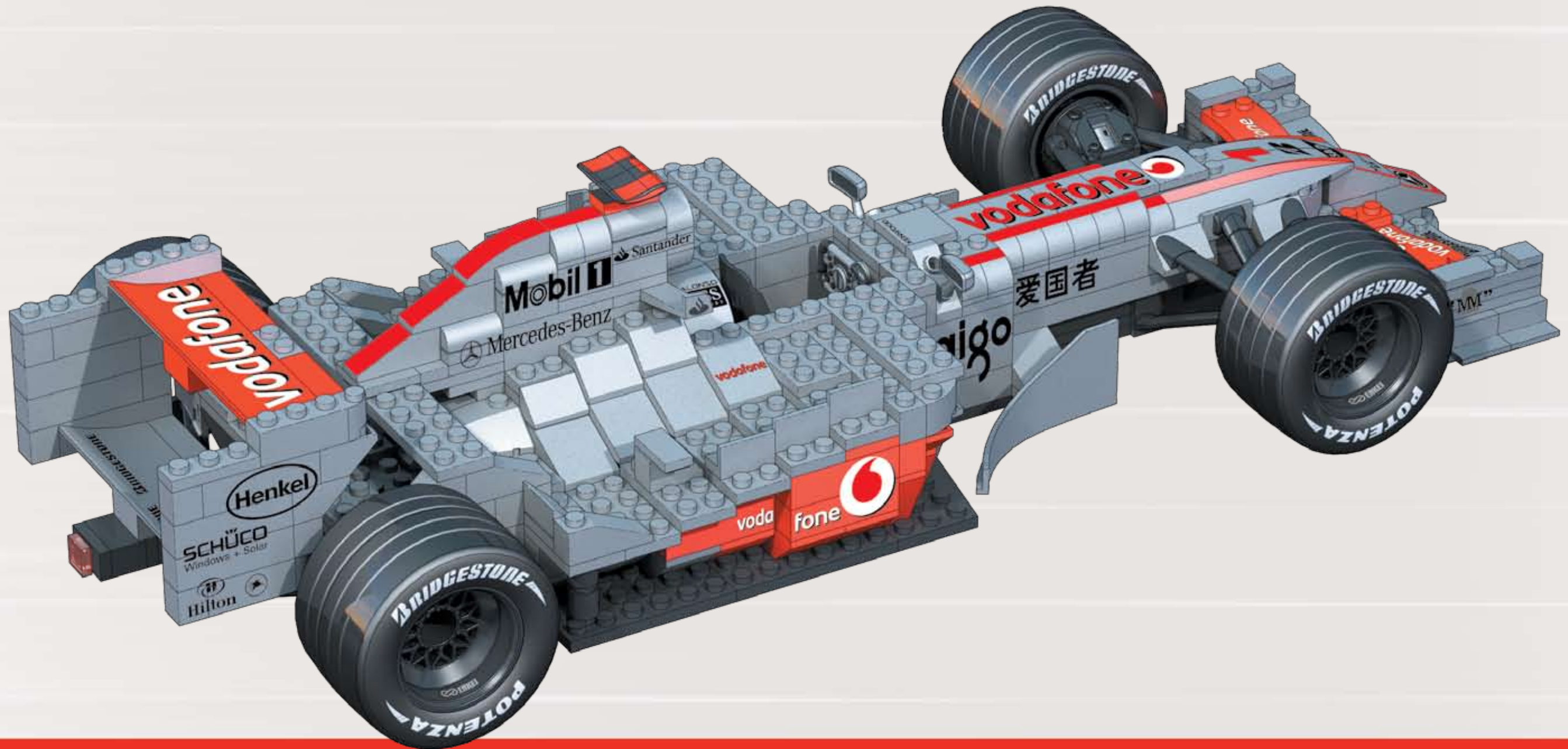

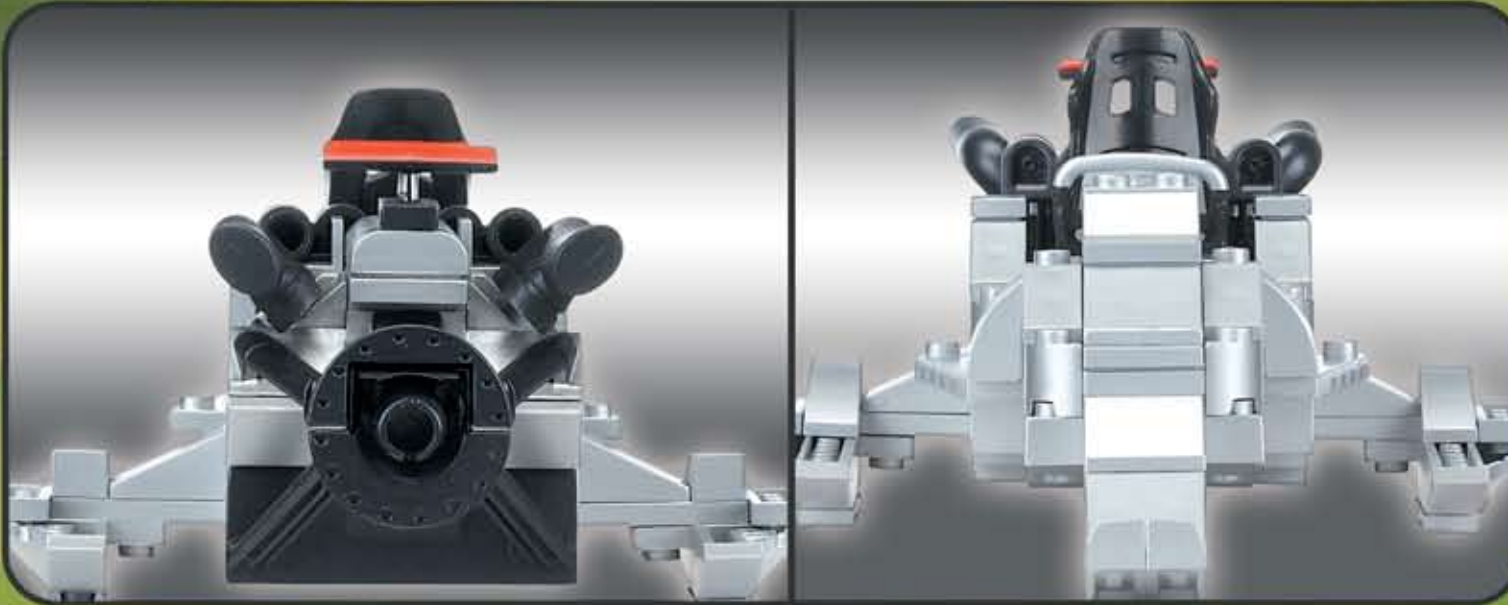

Building challenge / Desafío de construcción
Défi de construction / Bauaufgabe
Bouwuïtdaging / Sfida di costruzione
Desafio de construção



3236

Vodafone McLaren Mercedes MP4-22

Vodafone McLaren Mercedes MP4-22

Engine • Motor • Moteur • Motore:

Type • Tipo del motor • Type de moteur • Motortype • Motormodell •
 Tipo del motore • Tipo do motor:

Mercedes-Benz FO 108T

No. of cylinders • N.º de cilindros • Nombre de cylindres • Aantal cylinders •

Zylinder-Zahl • N.º di cilindri • No. de cilindros:

8

Weight • Peso • Poids • Gewicht:

95 kg

Transmission • Transmisión • Transmission • Vernellingsbak •

Getriebe • Trasmiszione • Transmissão:

Seven speed semi-automatic with hand-operated clutch • Siete velocidades, semiautomático con embrague manual • Semi-automatique à sept vitesses avec embrayage à main • Zeven versnellingsen semi-automatisch met handkoppeling • Halbautomatisches Sieben-Gang-Getriebe mit Handkupplung • Semi-automatica a sette velocità con frizione manuale • Semi-automático de sete velocidades, com embraagem manual

Chassis • Chasis • Châssis • Fahrgestell • Telaio:

Moulded carbon fibre / aluminium honeycomb composite • Fibra de carbono moldeada, compuesto de aluminio en forma de panal • Composite moulé de fibre de carbone / aluminium en nid d'abeilles • Gevormde koolstofvezel / aluminium samenstelling in honingraat constructie • Geformter Bienenwaben-Verbundstoff aus Kohlefaser / Aluminium • Modulo di fibra di carbonio / alluminio ad alveare composito • Fibra de carbono / alumínio modelado, construção favo de mel

Suspension • Suspensión • Suspension • Vering • Radaufhängung • Sospensioni • Suspensão:

Inboard torsion bar / damper system • Barra de torsión interna, sistema de amortiguadores • Système intérieur de barres de torsion / amortisseurs • Binnenboords torsiestang / schokbrekersysteem • Innenliegender Drehstab / Stoßdämpfer • Barra di torsione interna / sistema idraulico • Barra de torção interna, sistema hidráulico de amortecedores

Tires • Neumáticos • Pneus • Banden • Reifen • Pneumatici:

Bridgestone Potenza

Race Wheels • Ruedas de carrera • Roues de course • Racewielen •

Rennfelgen • Ruote Corsa • Rodas de corrida:

Enkel

Steering • Dirección • Direction • Besturing • Lenkung • Volante:

McLaren power-assisted • McLaren (asistida) • Direction assistée McLaren • McLaren met stuurbekrachting • McLaren Servolenkung • McLaren servo assistito • McLaren direcção assistida

Batteries • Pilas • Batteries • Batterien • Batterijen • Batterie • Pilhas:

GS Yuasa Corporation

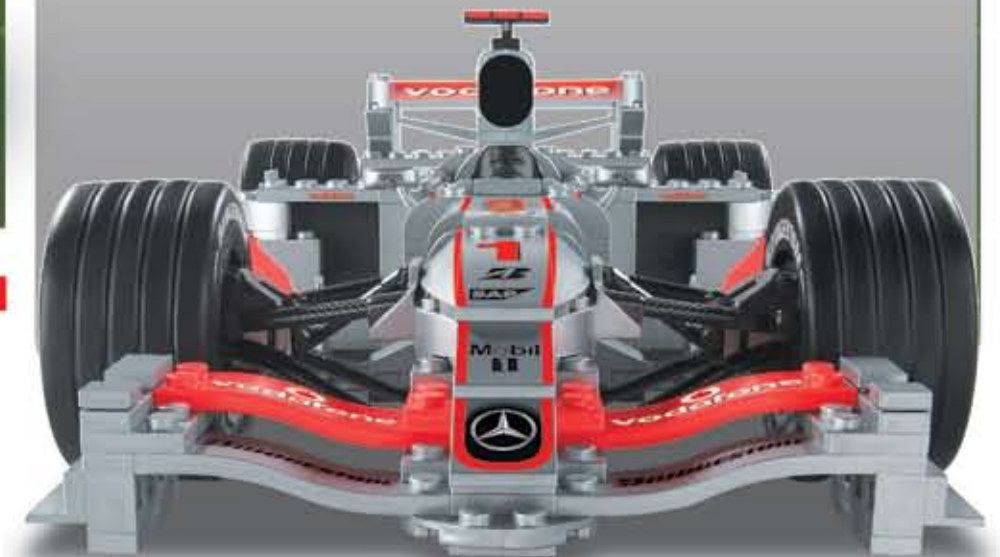

© 2007, MEGA Brands Inc.

MEGA Brands Inc. and the MEGA Brands Inc. logo are registered trademarks of MEGA Brands Inc.
 MEGA Brands Inc. y el logotipo MEGA Brands Inc. son marcas registradas de MEGA Brands Inc.
 MEGA Brands Inc. et le logo de MEGA Brands Inc. sont des marques de commerce déposées de MEGA Brands Inc.
 MEGA Brands Inc. und das MEGA Brands Inc.-Logo sind eingetragene Warenzeichen von MEGA Brands Inc.
 MEGA Brands Inc. en het MEGA Brands Inc. logo zijn gedeponeerde handelsmerken van MEGA Brands Inc.
 MEGA Brands Inc. ed il logo di MEGA Brands Inc. sono marchi di fabbrica di MEGA Brands Inc.
 MEGA Brands Inc. e o logo MEGA Brands Inc. são marcas registradas de MEGA Brands Inc.



Printed in China

AD032361A