



# AGENTS



8632



1

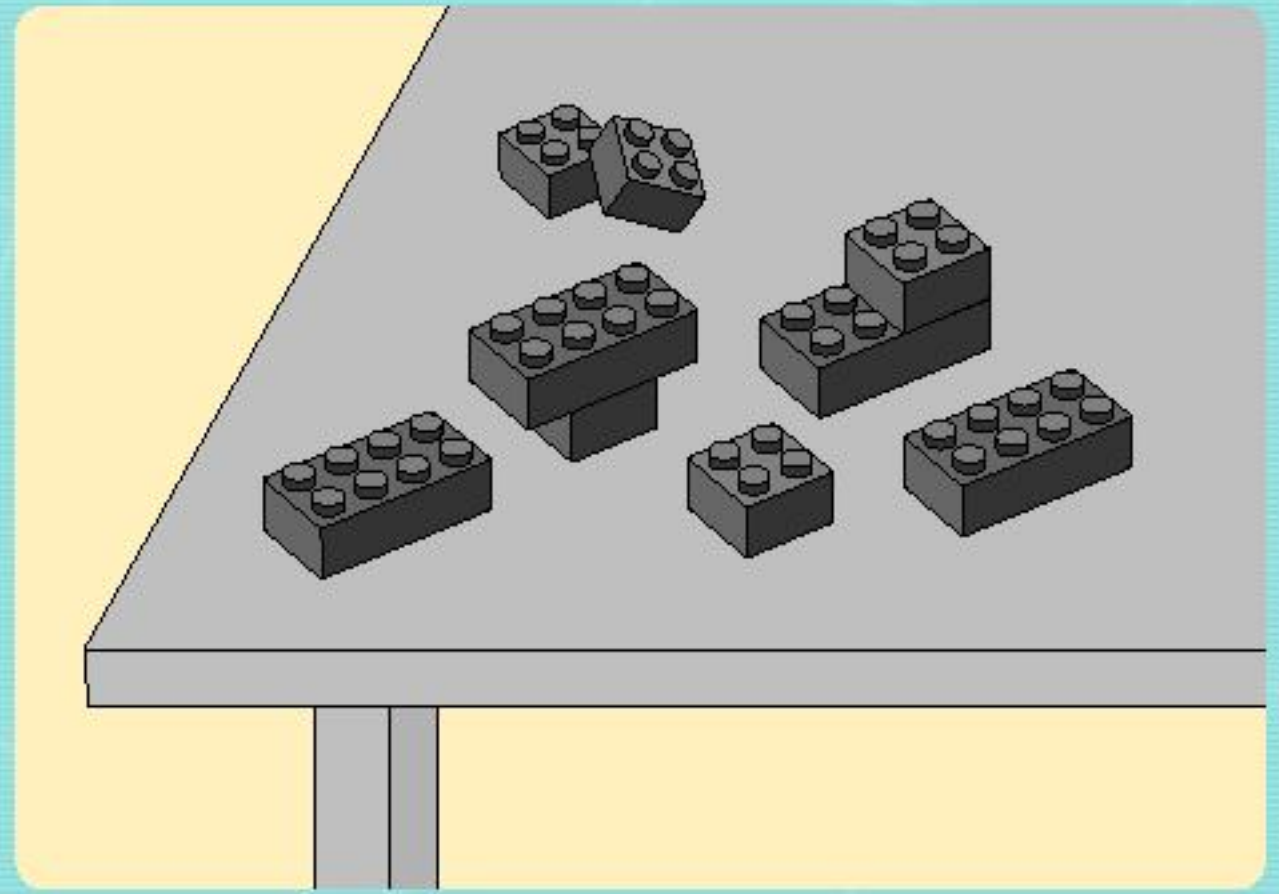
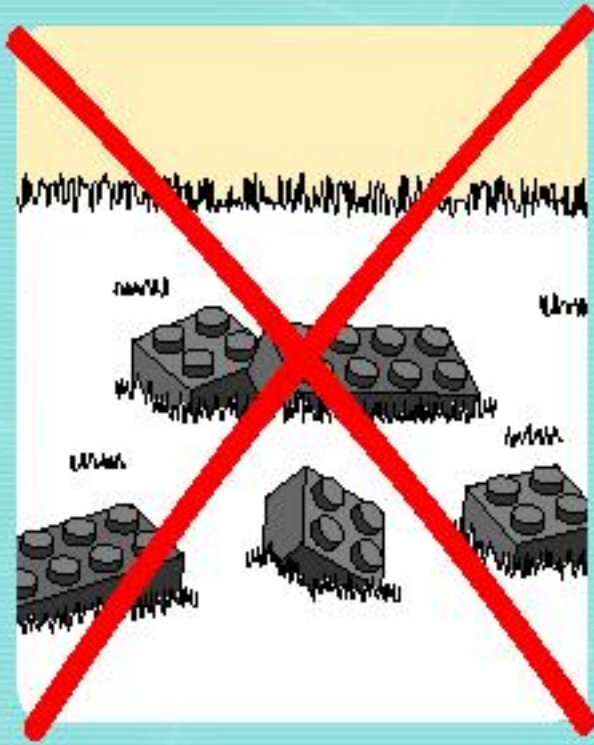

2

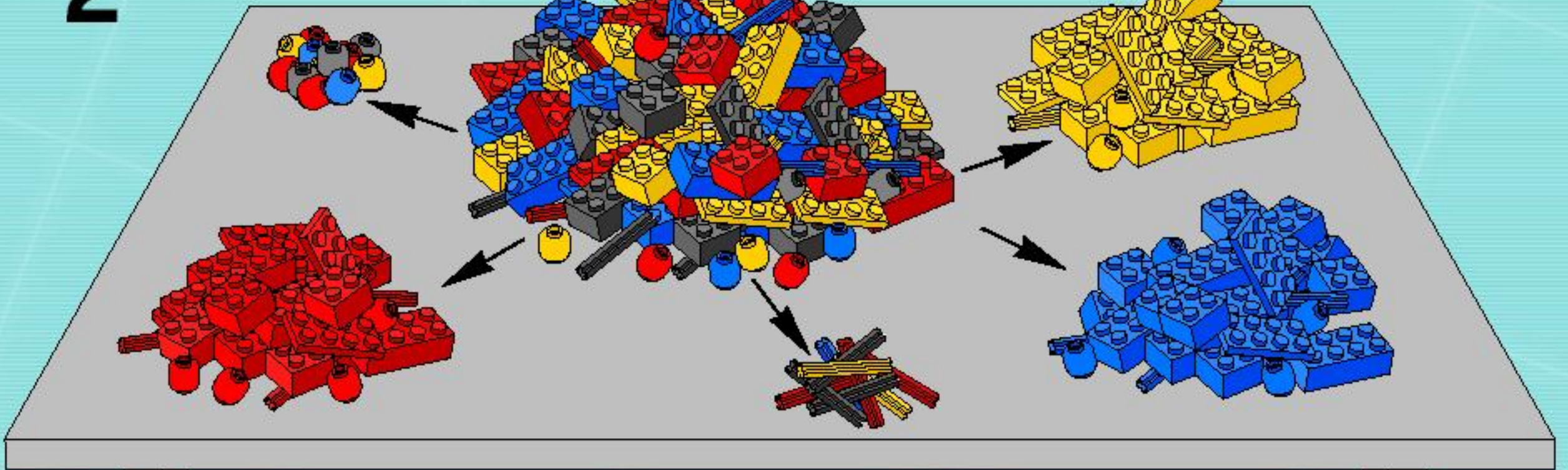



3

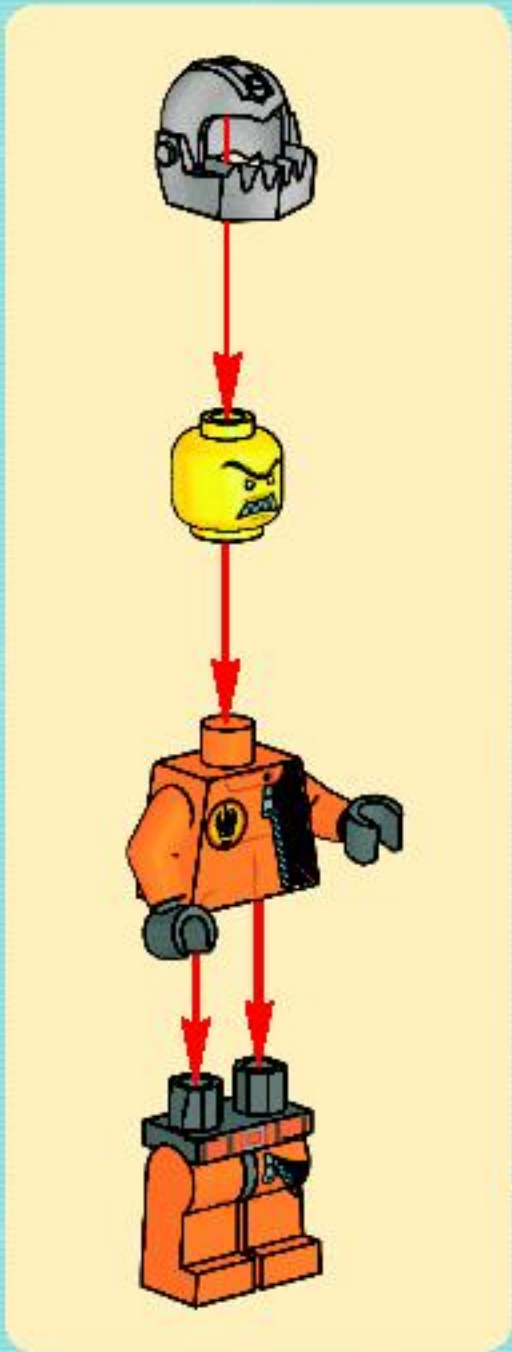

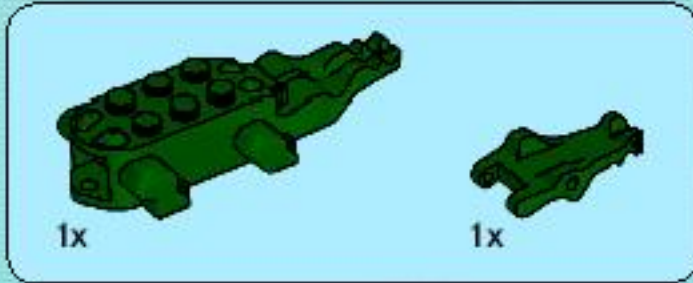
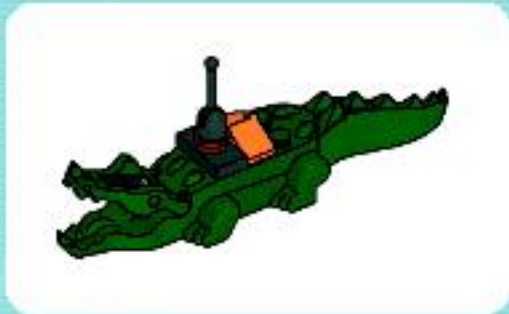

**1**

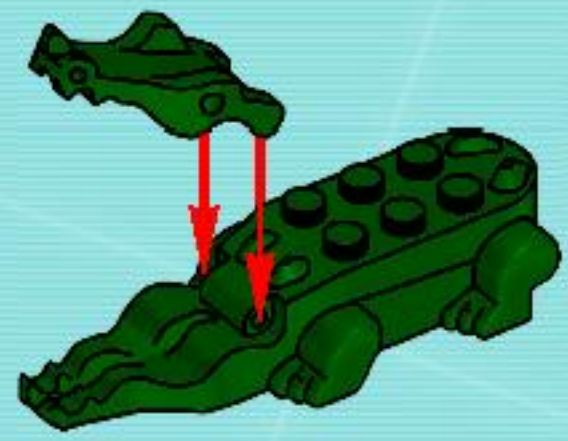

**2**

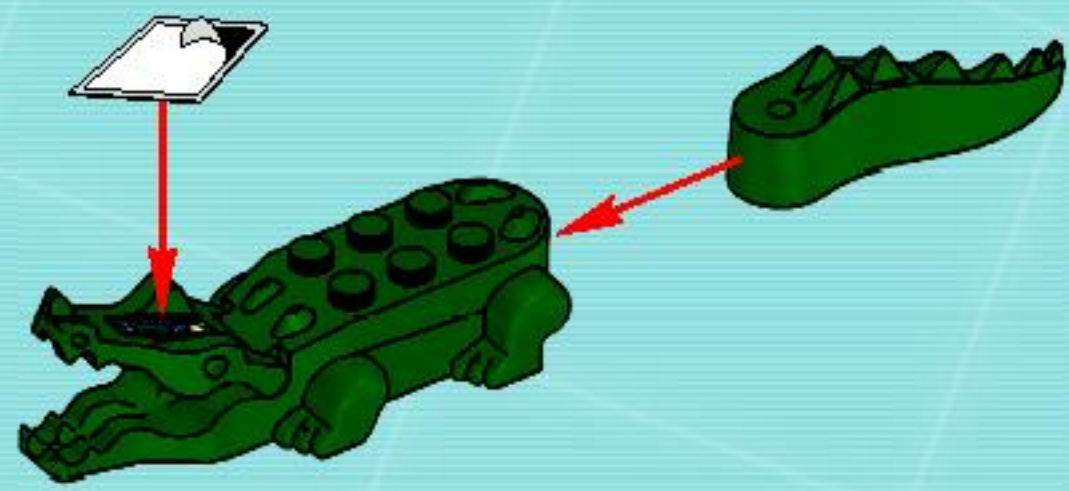



1x



2x

3

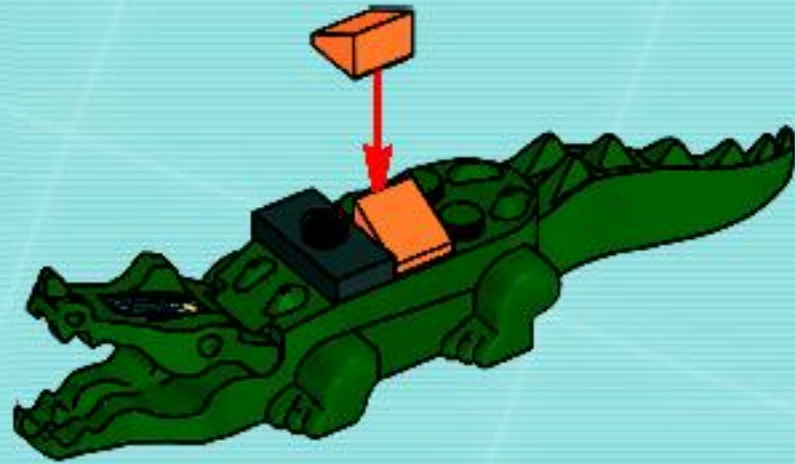

1x



1x

4

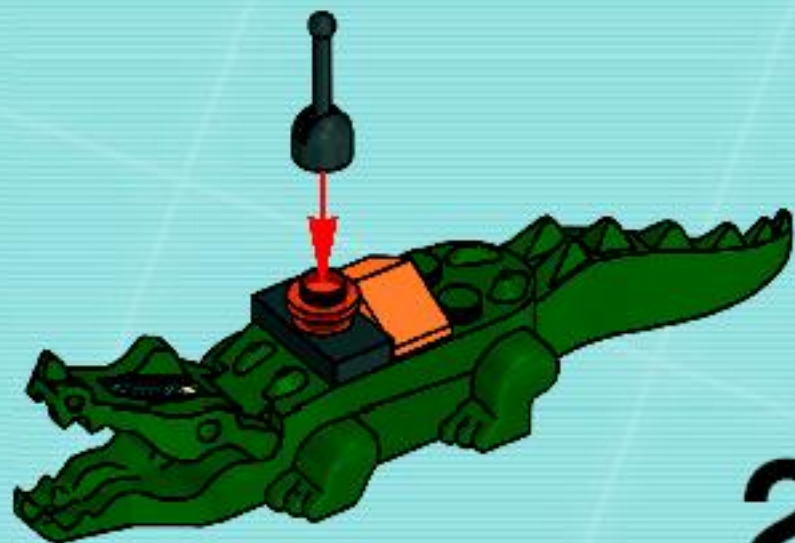

2x



1

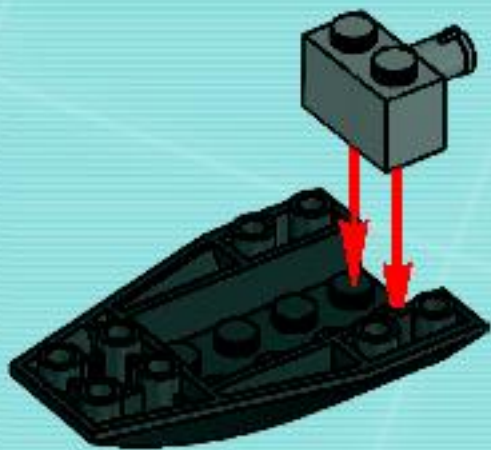

2

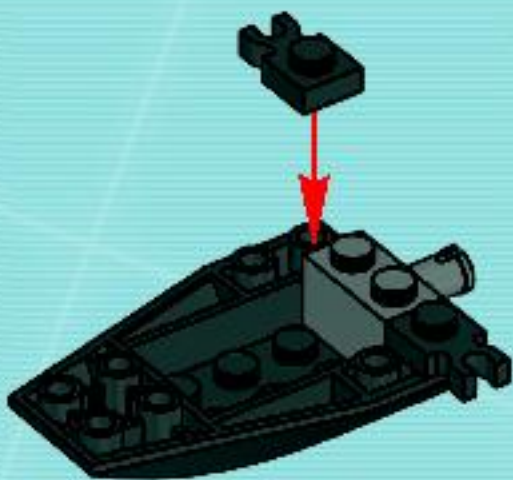



1x



2x

3

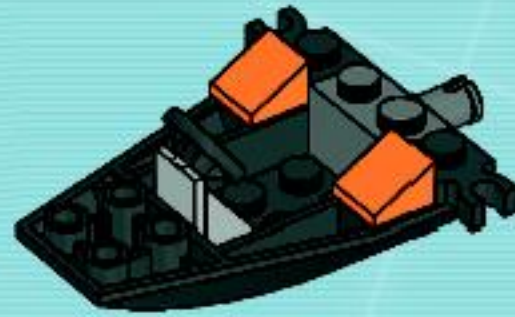

1x



2x

4





5

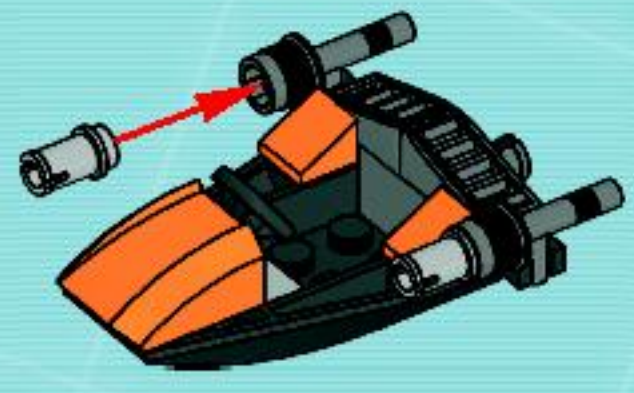

6





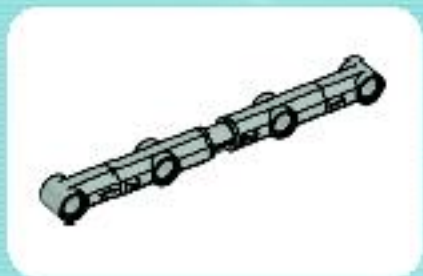

1

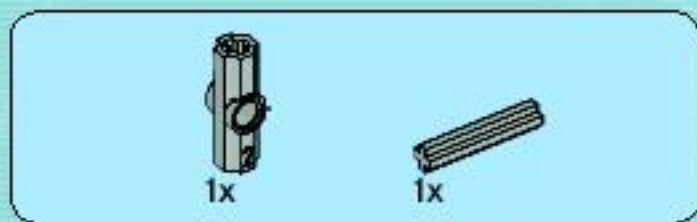
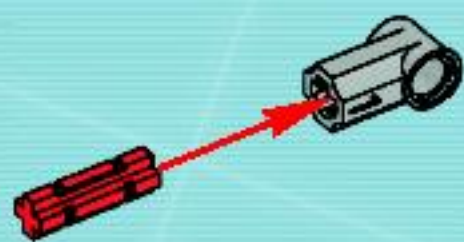

2

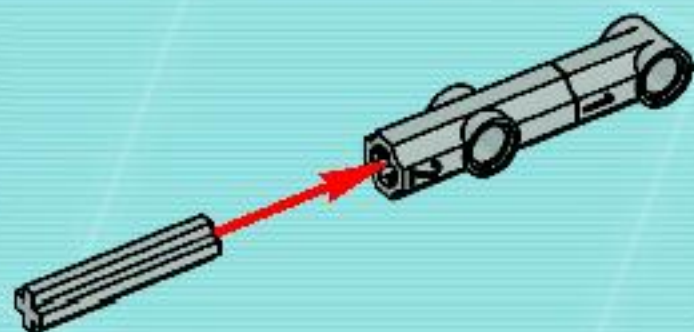



3

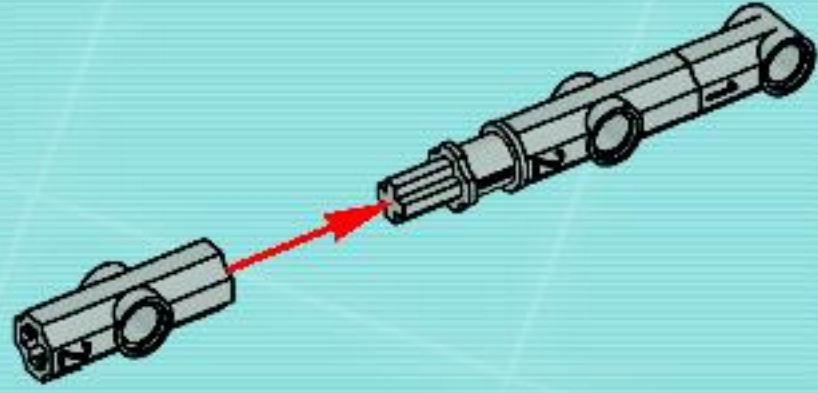

4

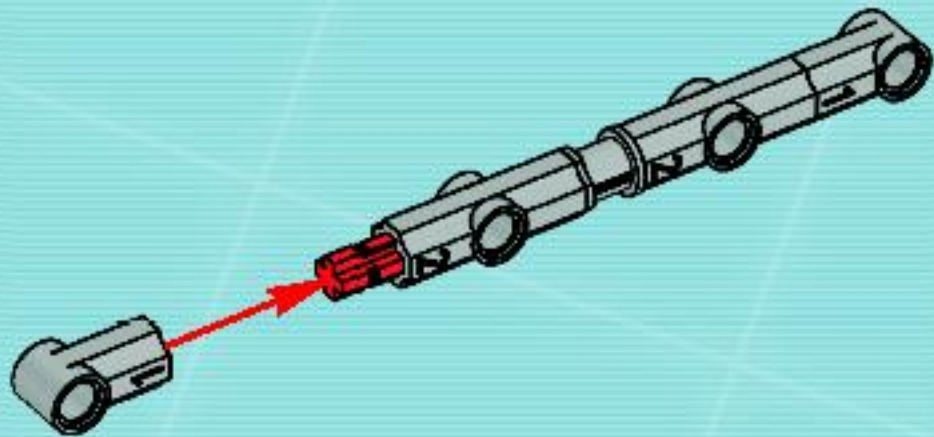



5

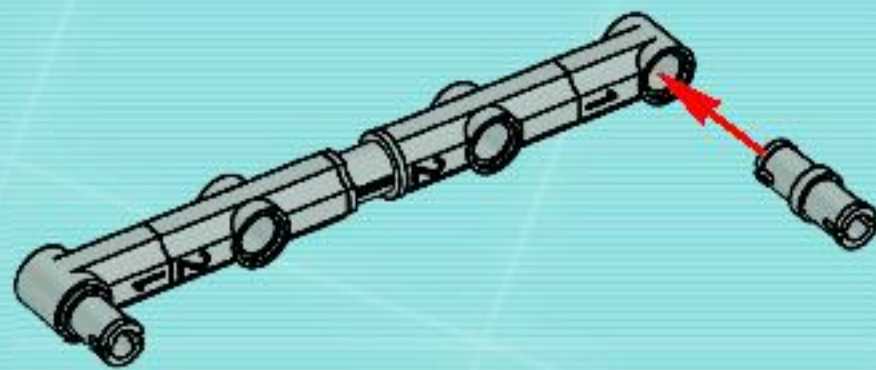

6

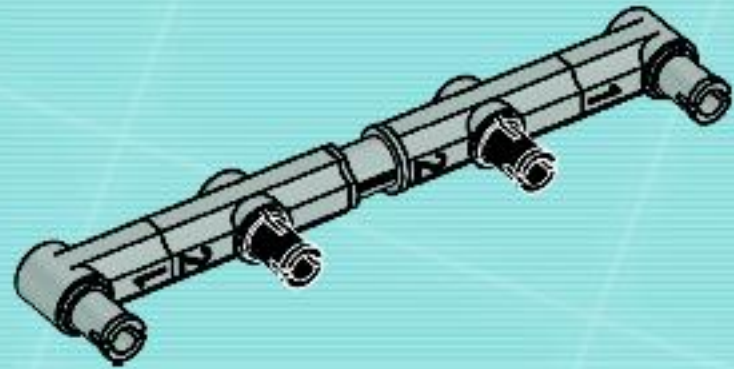

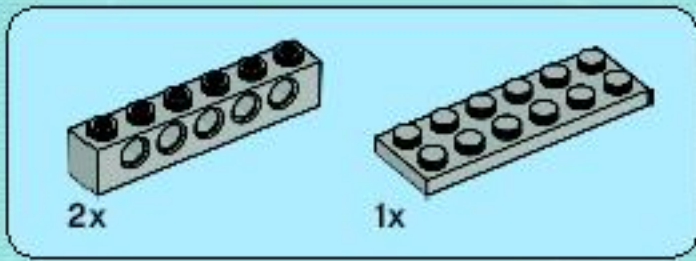

7

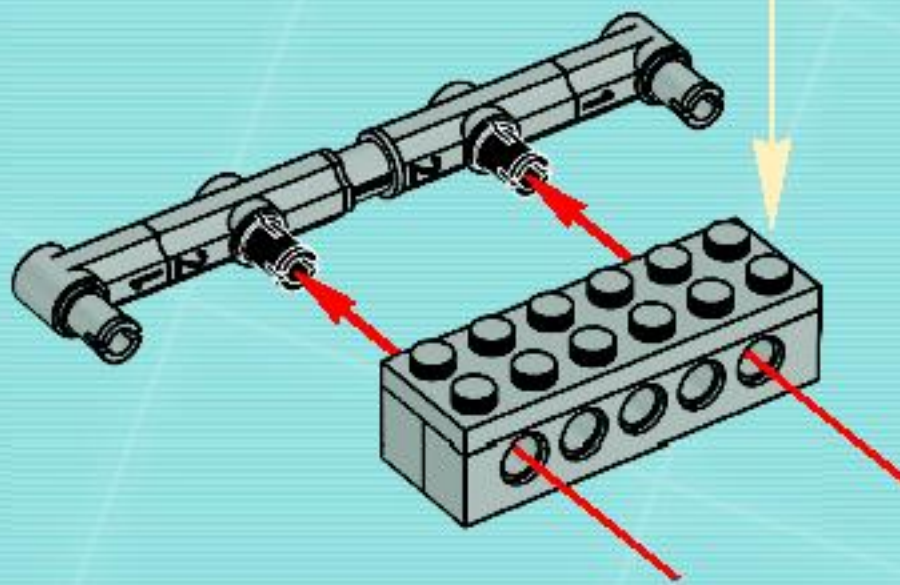
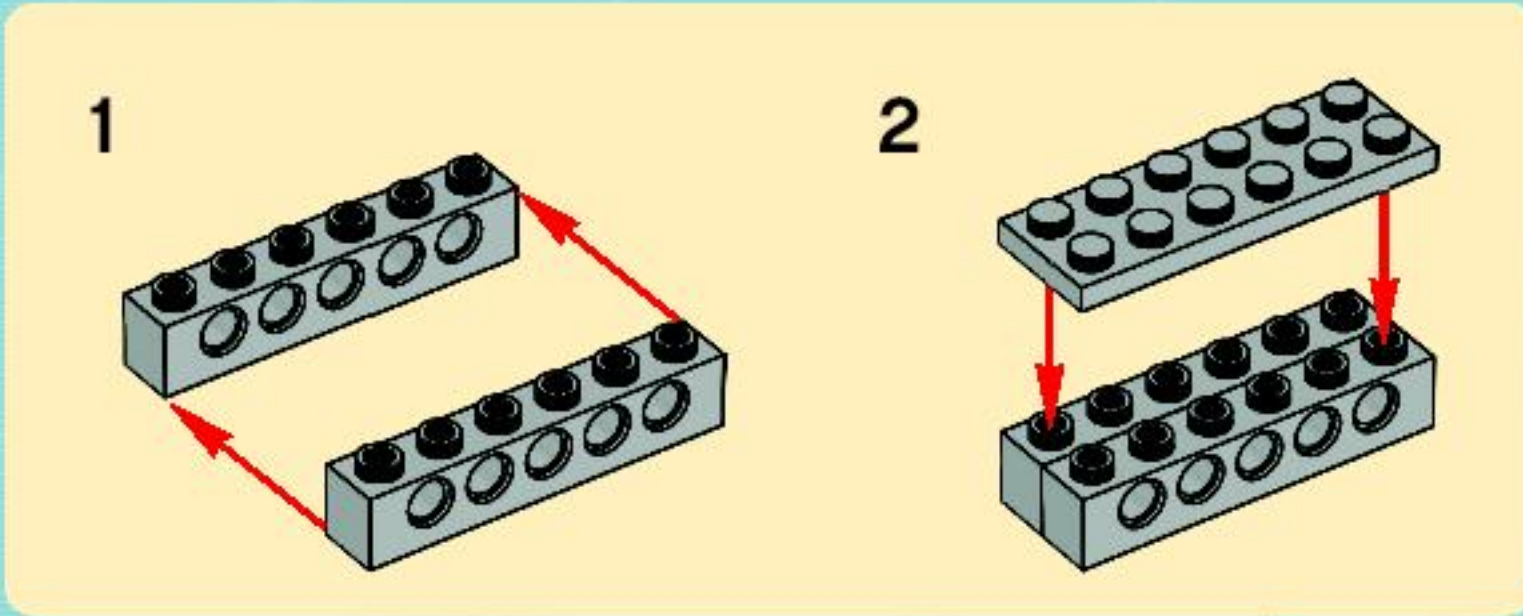

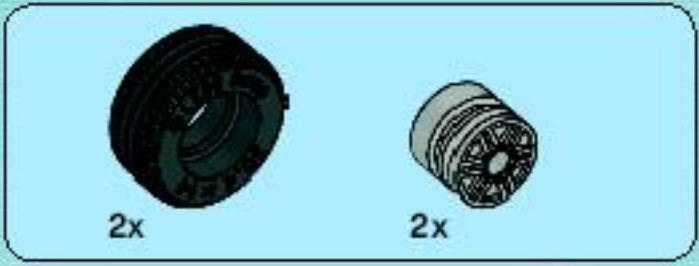

8

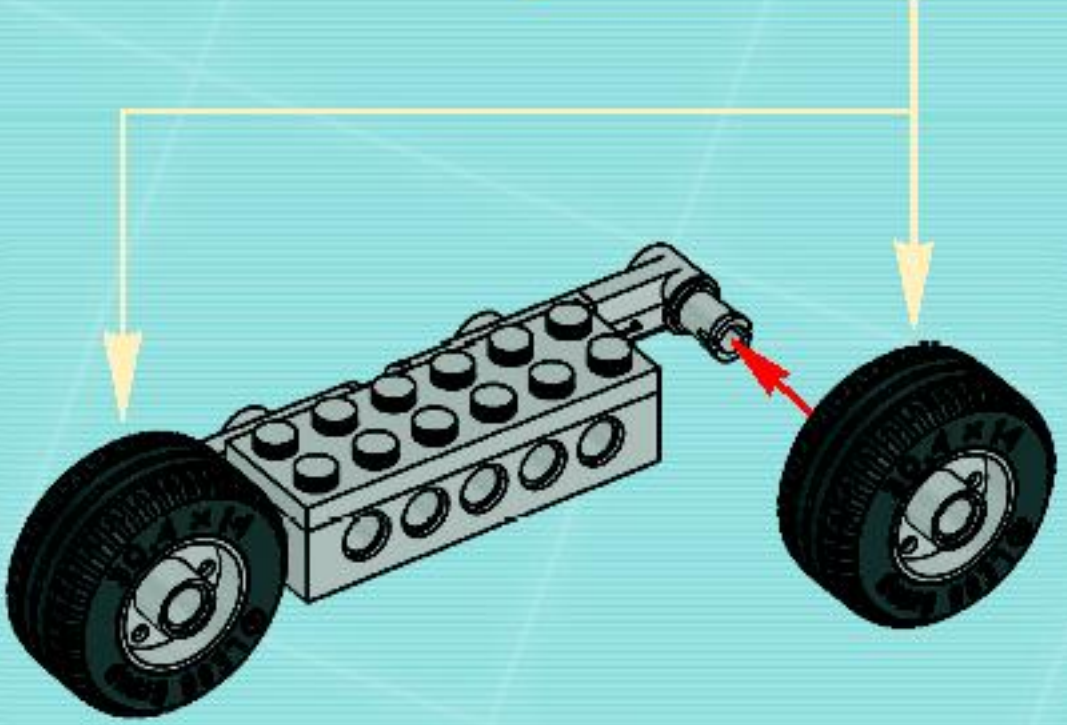
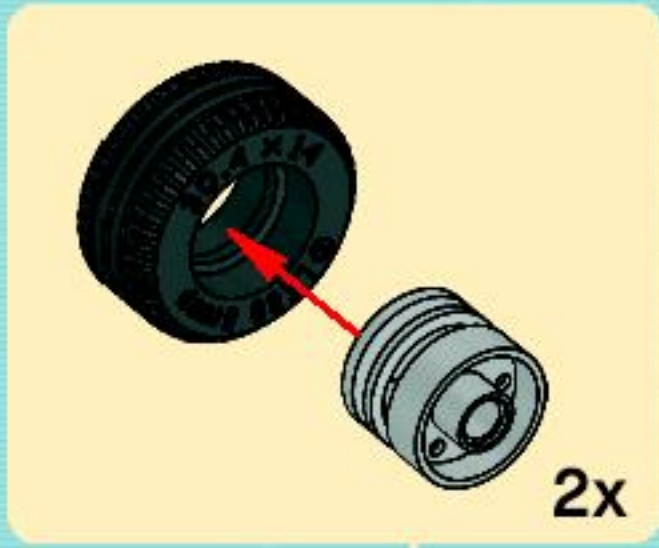

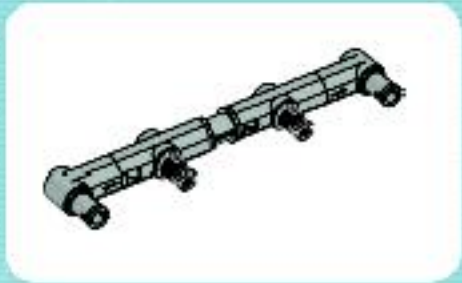

1

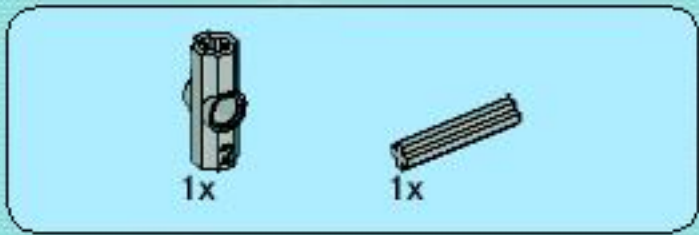
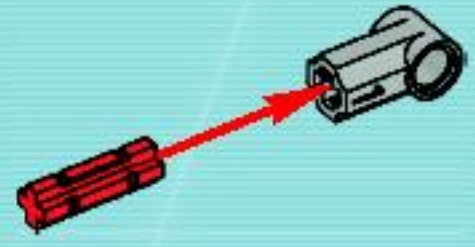

2

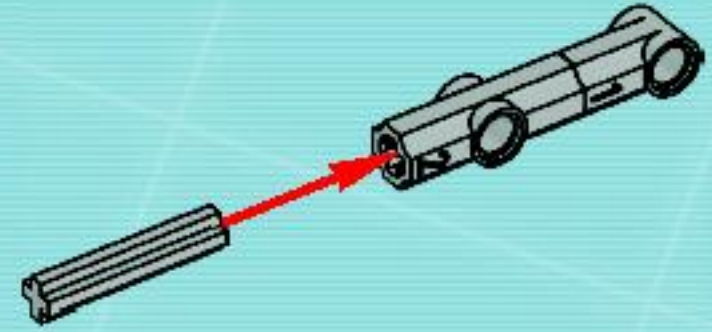

3

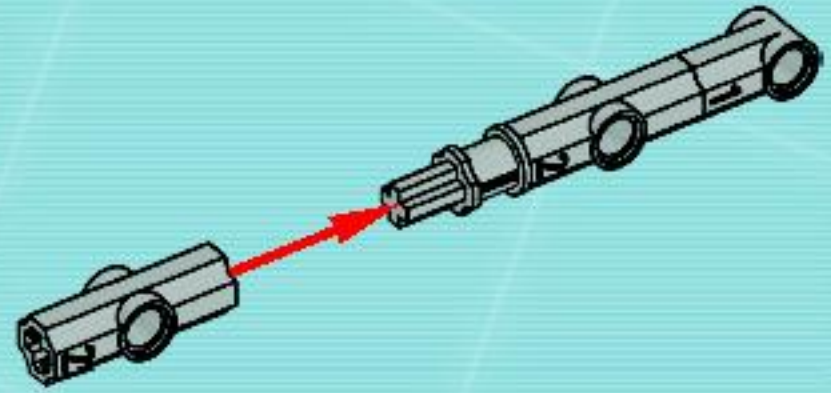



4

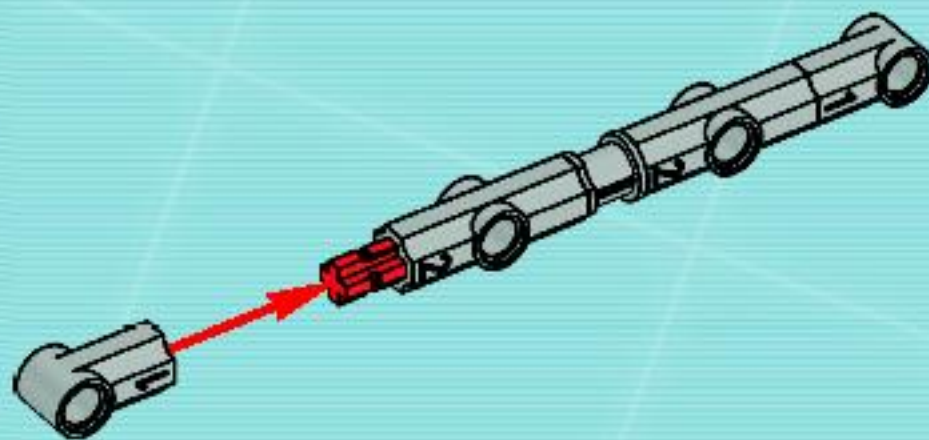

5

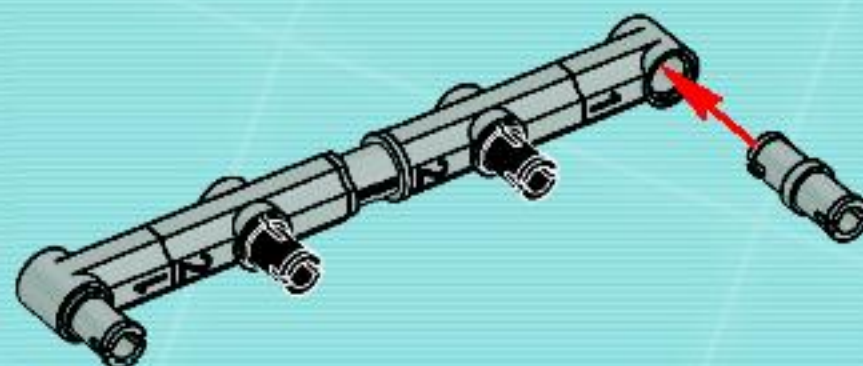

9

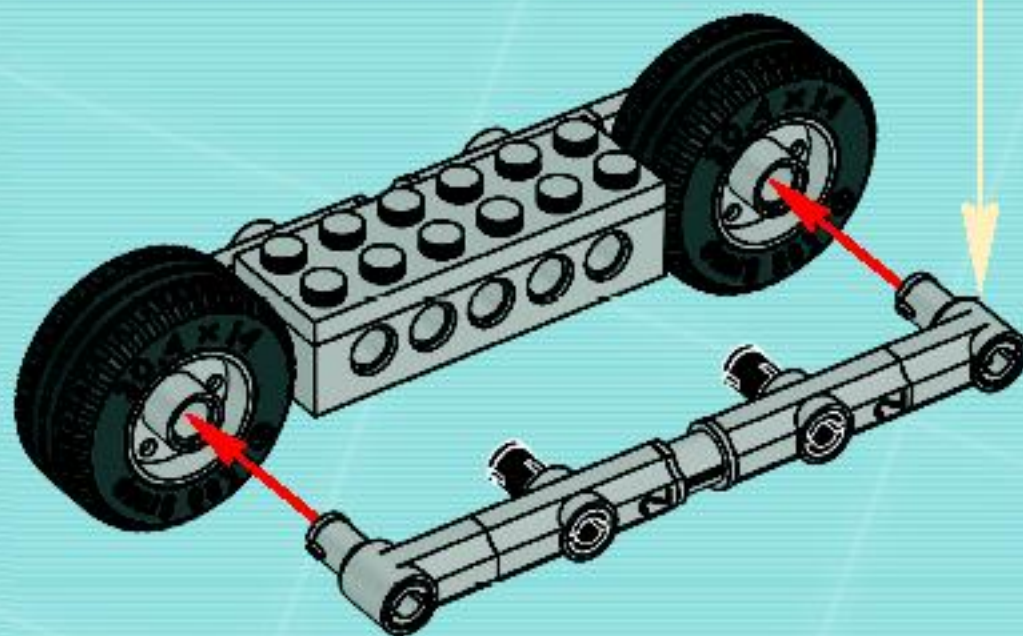

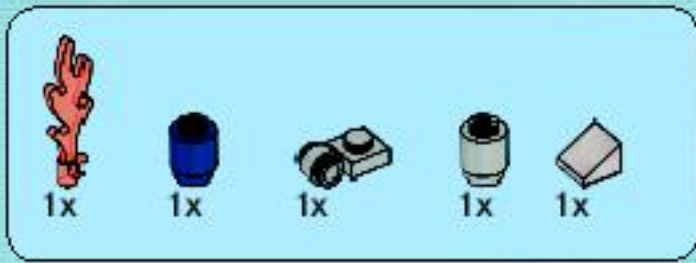

1

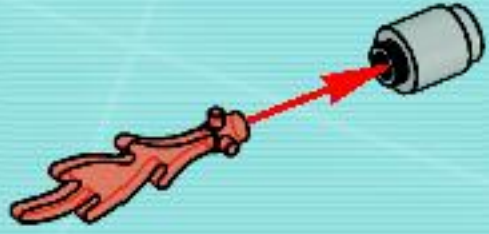

2



3

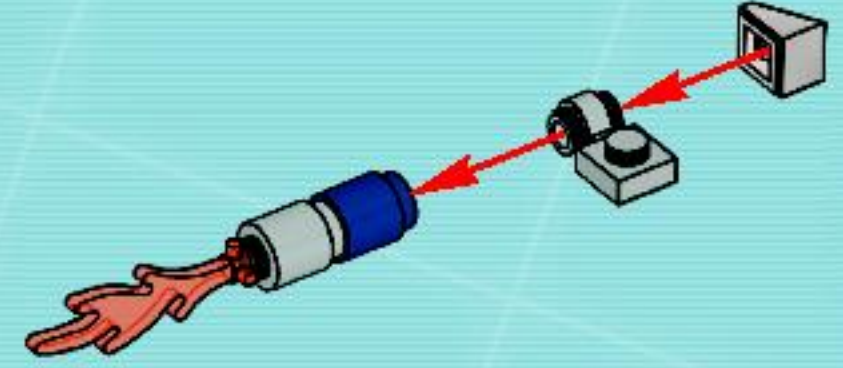

4



10

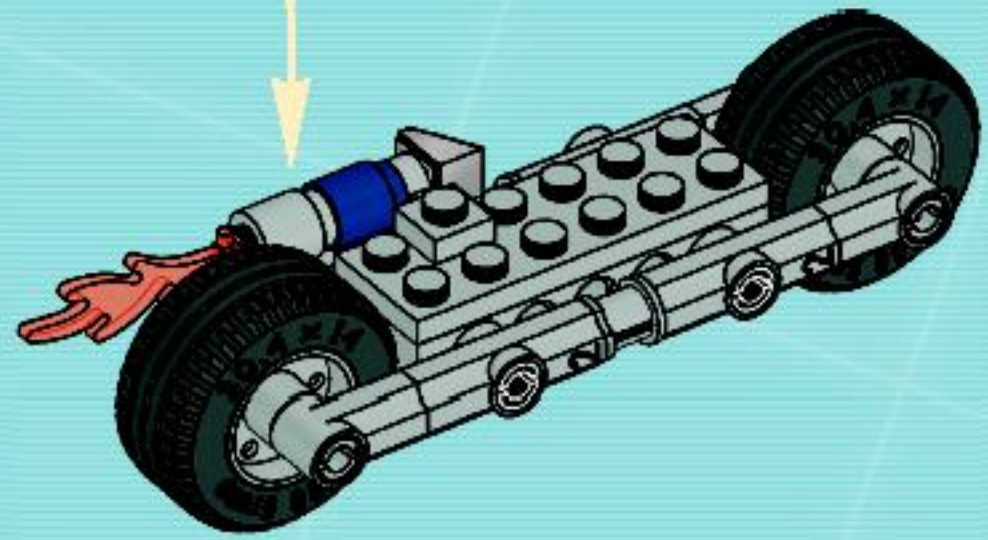



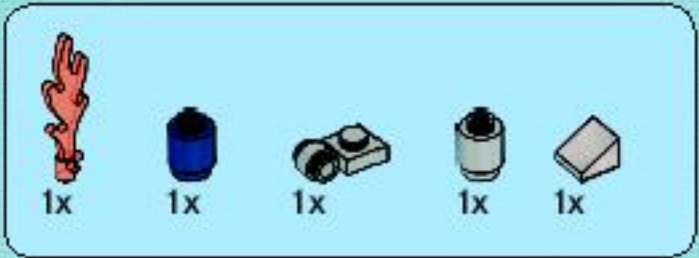

1

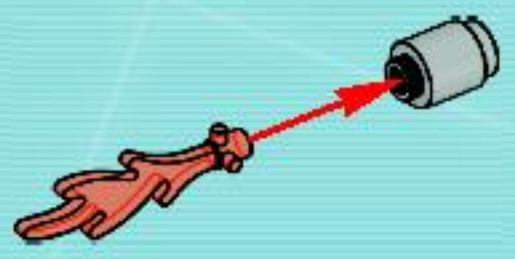

2

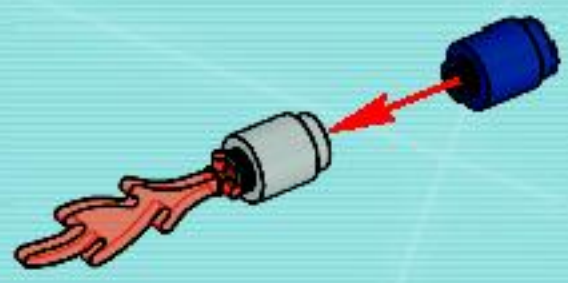

3

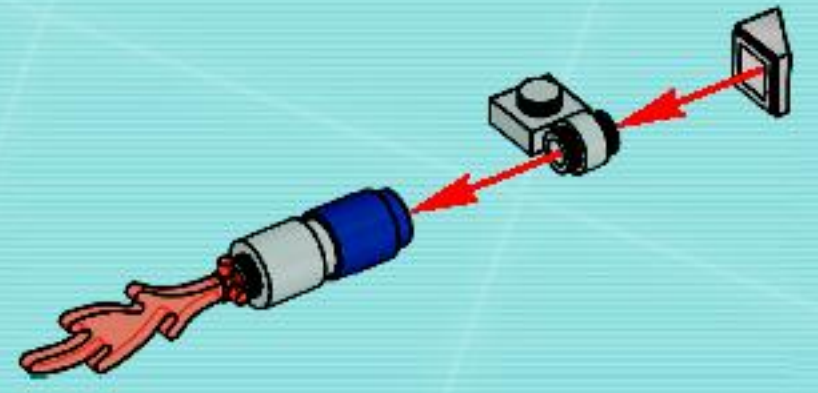

4



11

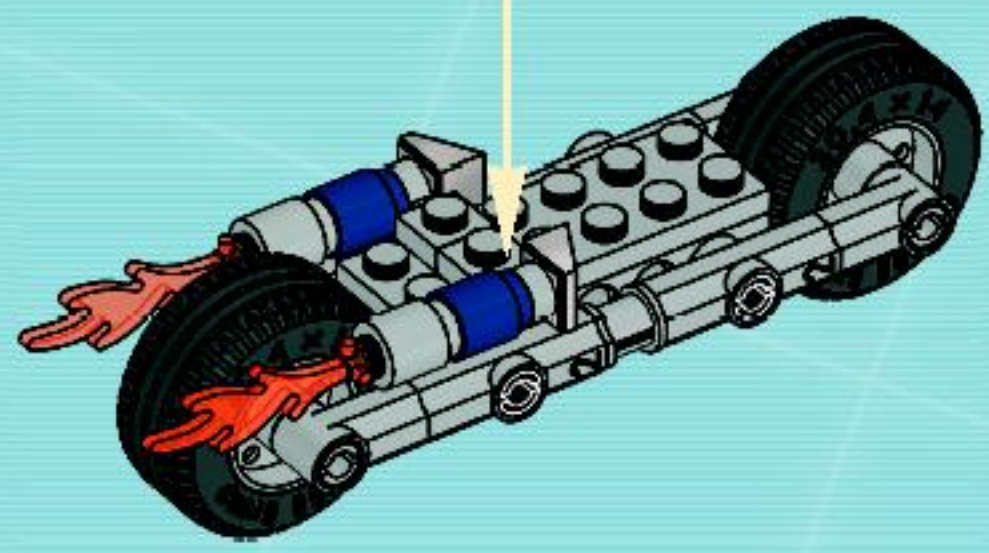

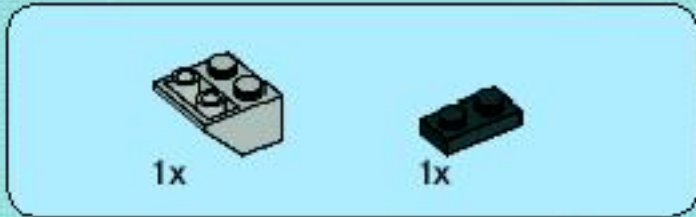

12

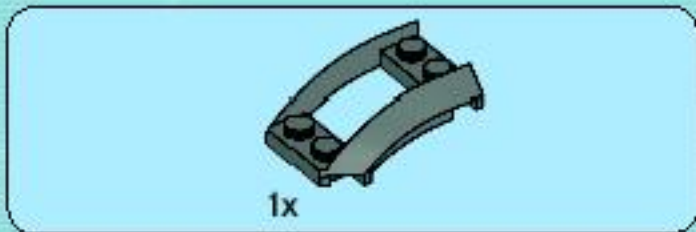
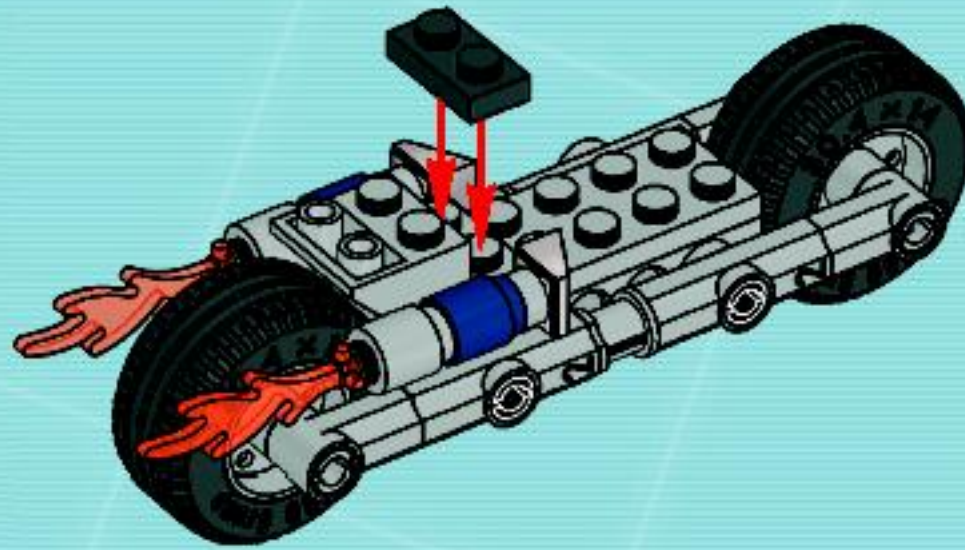

1



2

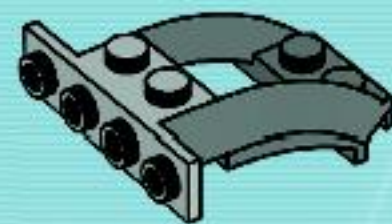



2x



2x

3

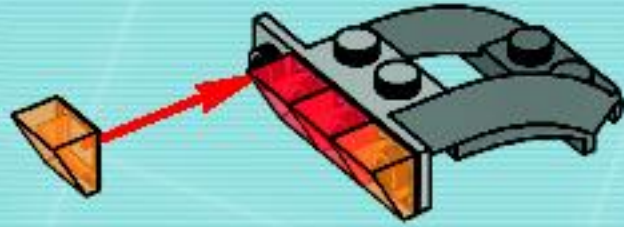

13

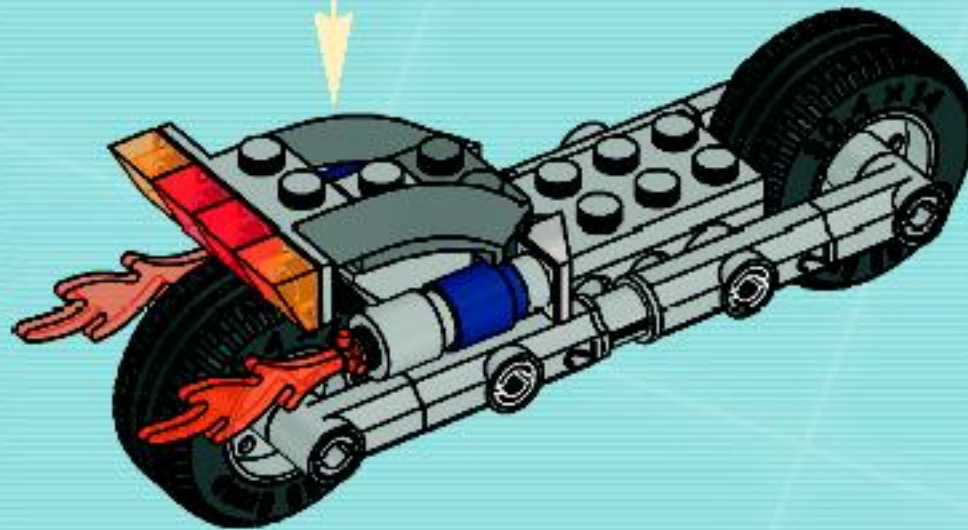



1x

14

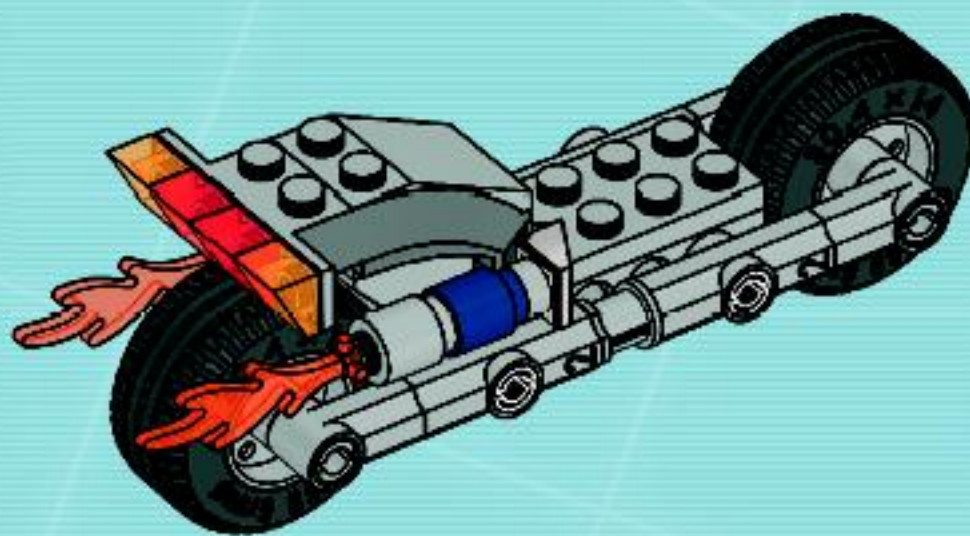

1x

15

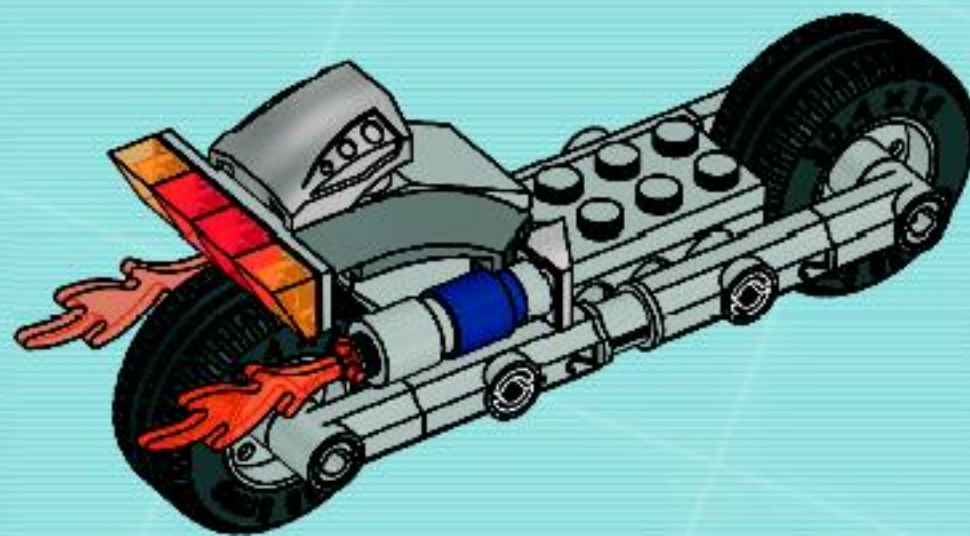



1

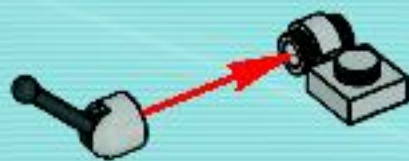

2



3

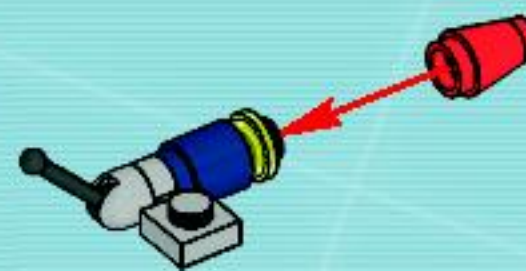

16

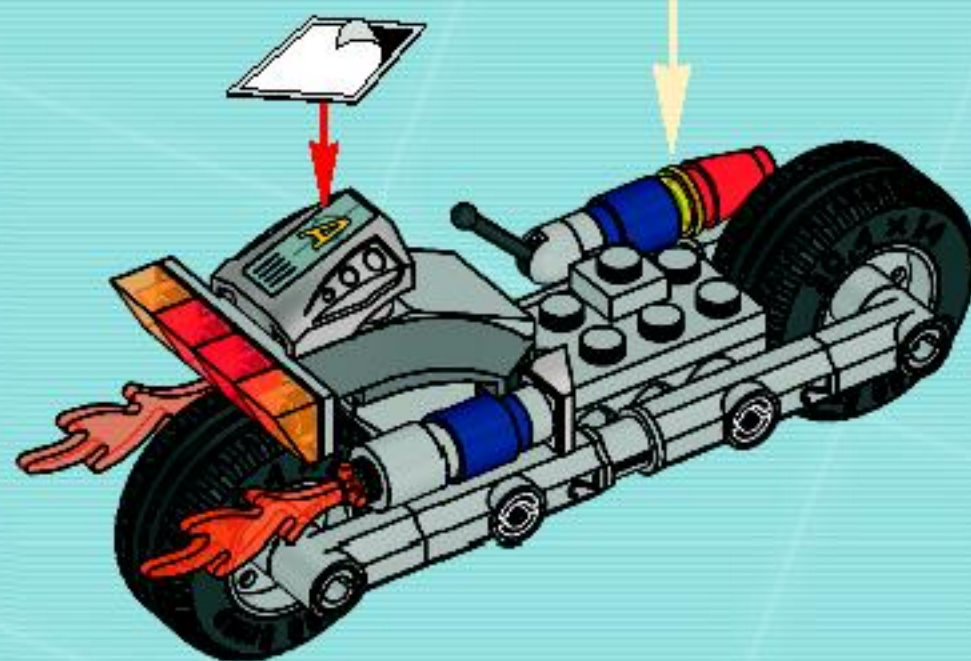



1

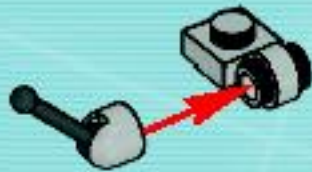

2

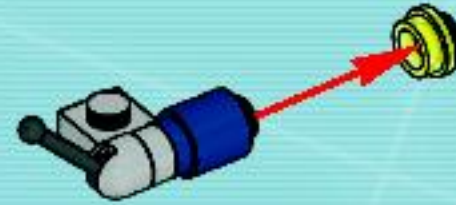

3



17

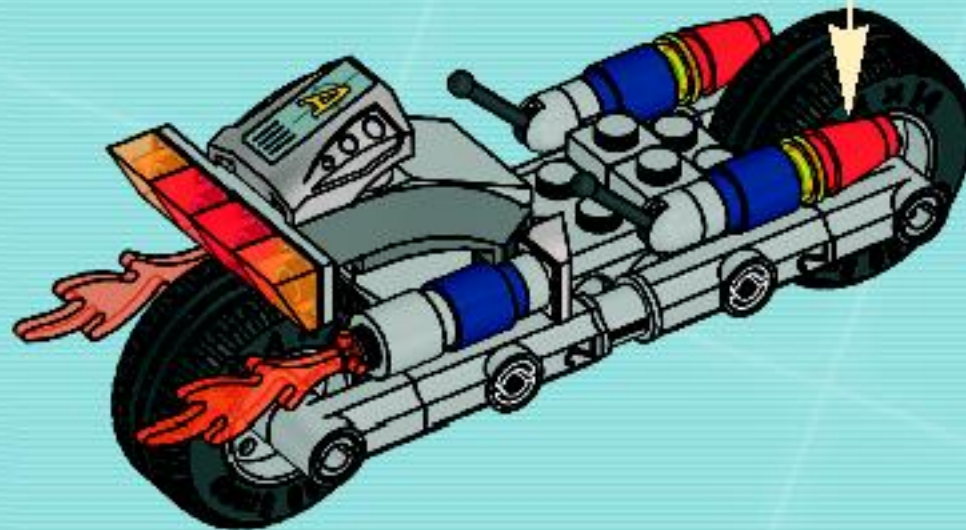



1x



1x

# 18

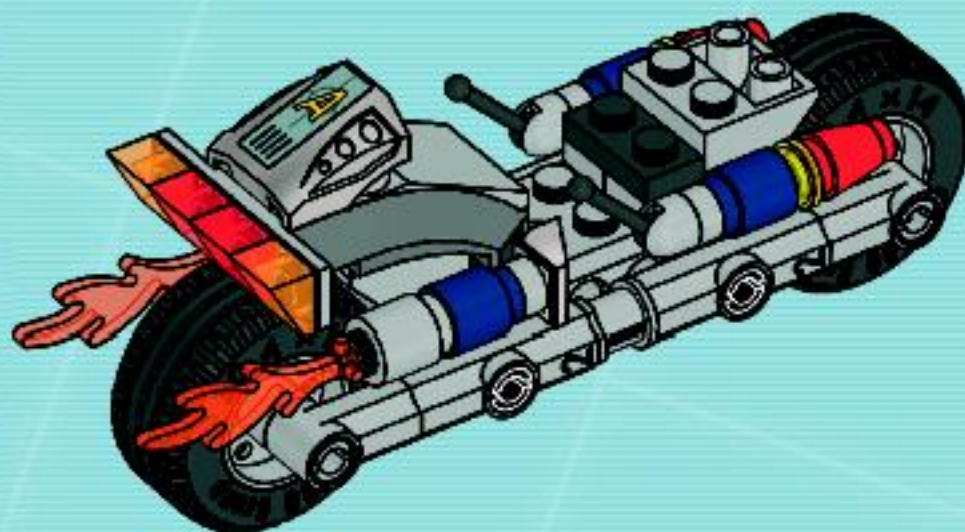

1x

# 19

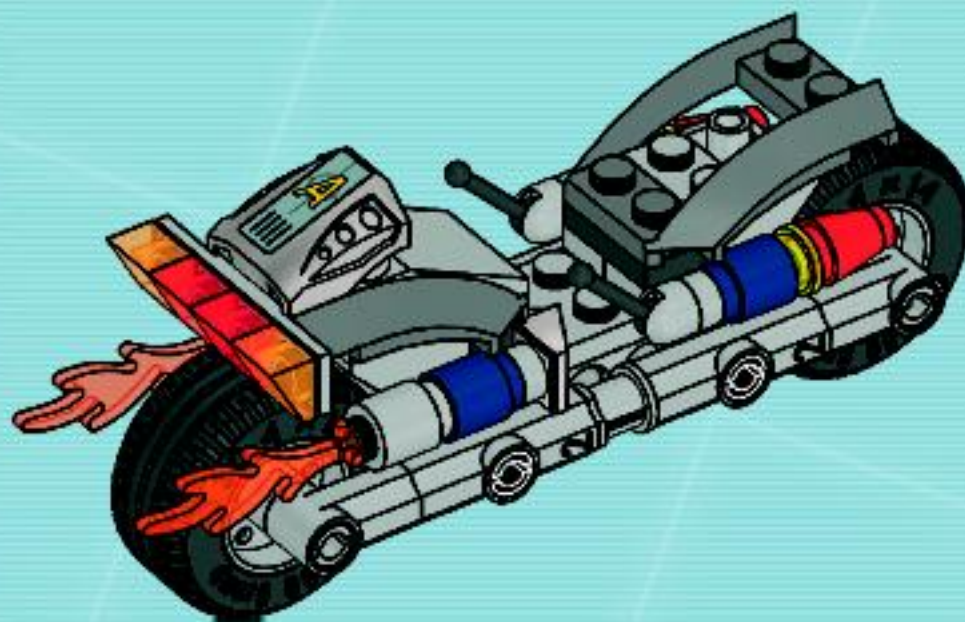

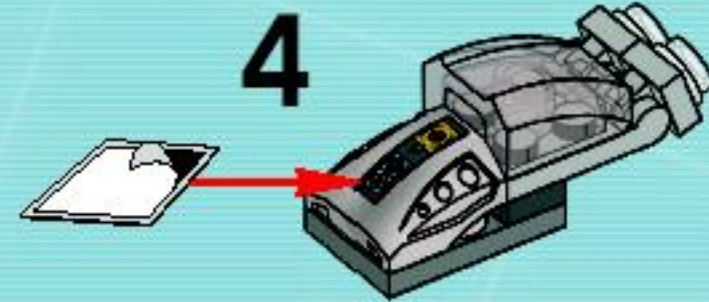
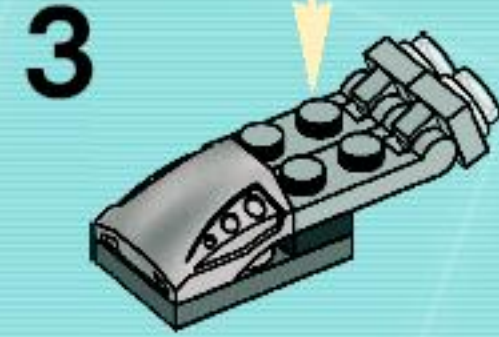
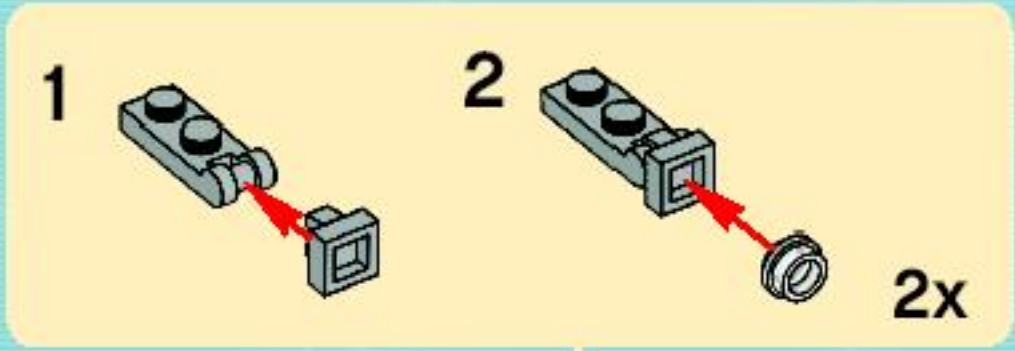
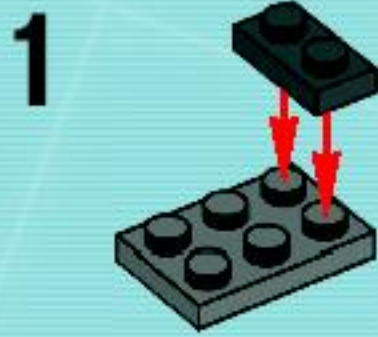
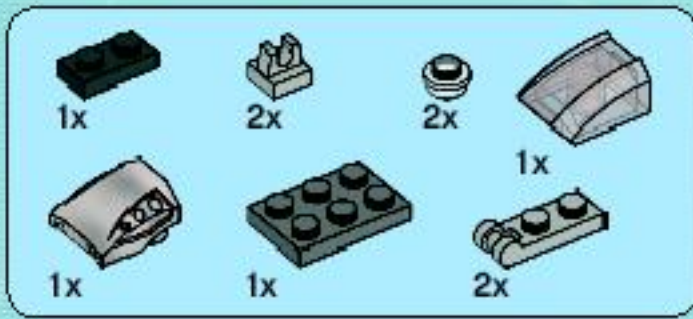

**20**

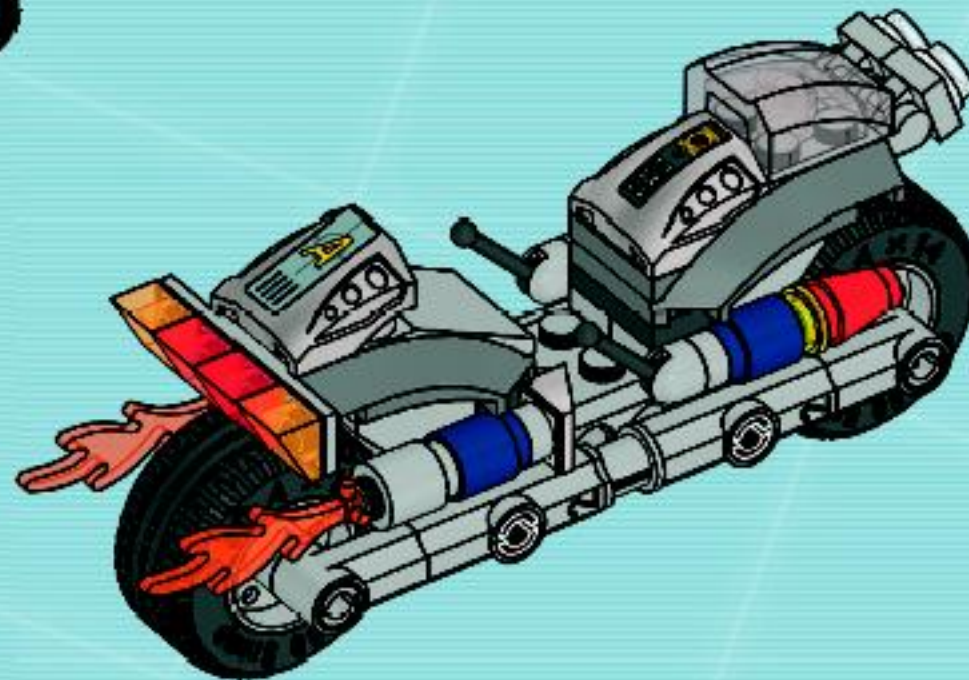



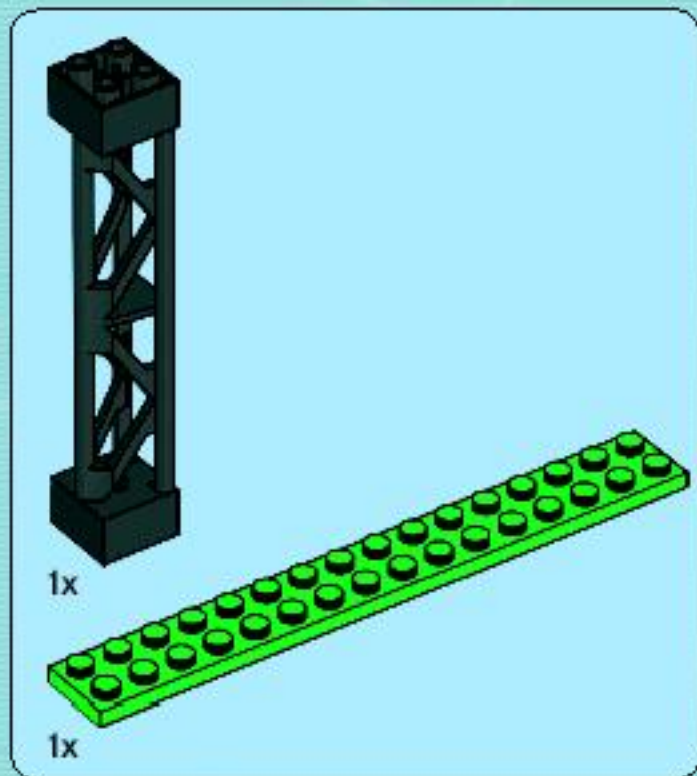

**1**

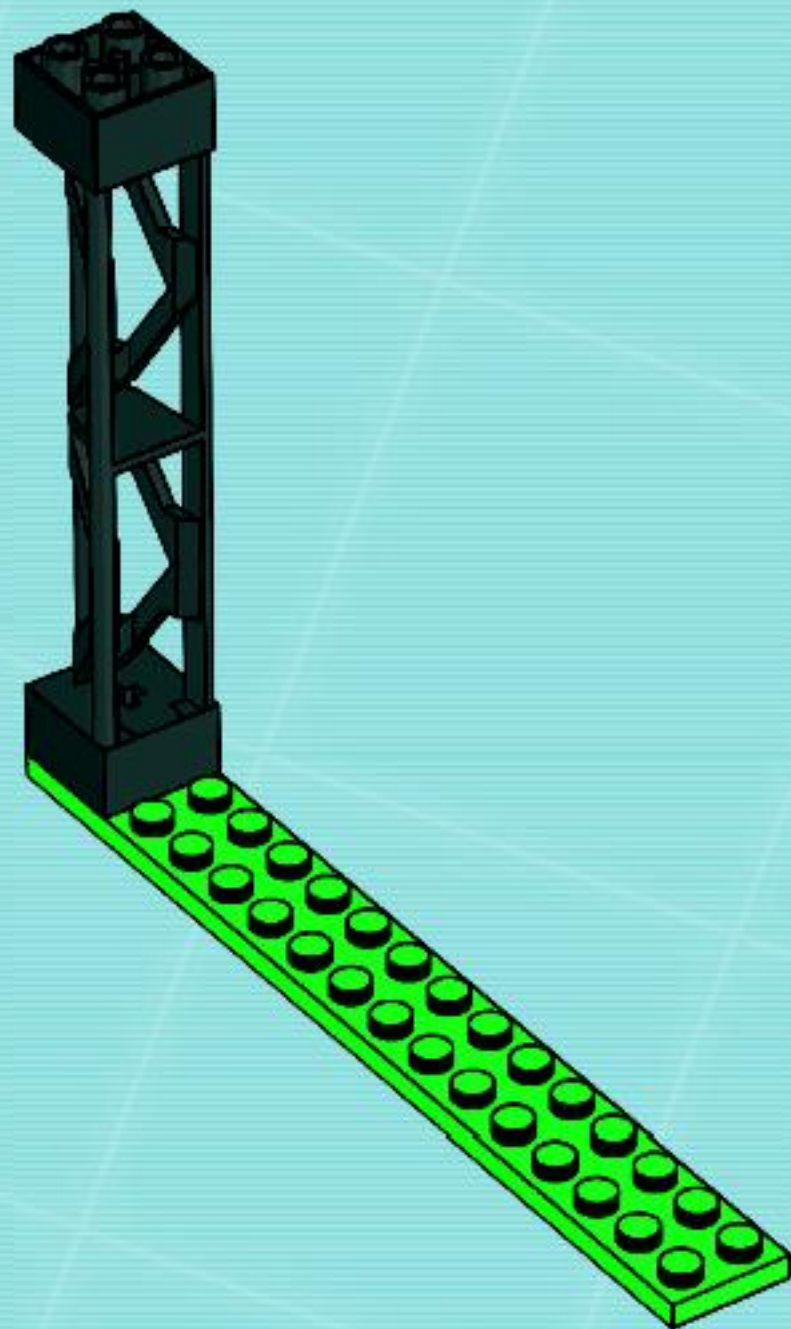

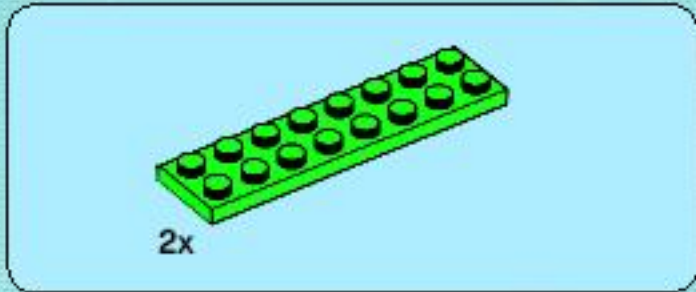

2

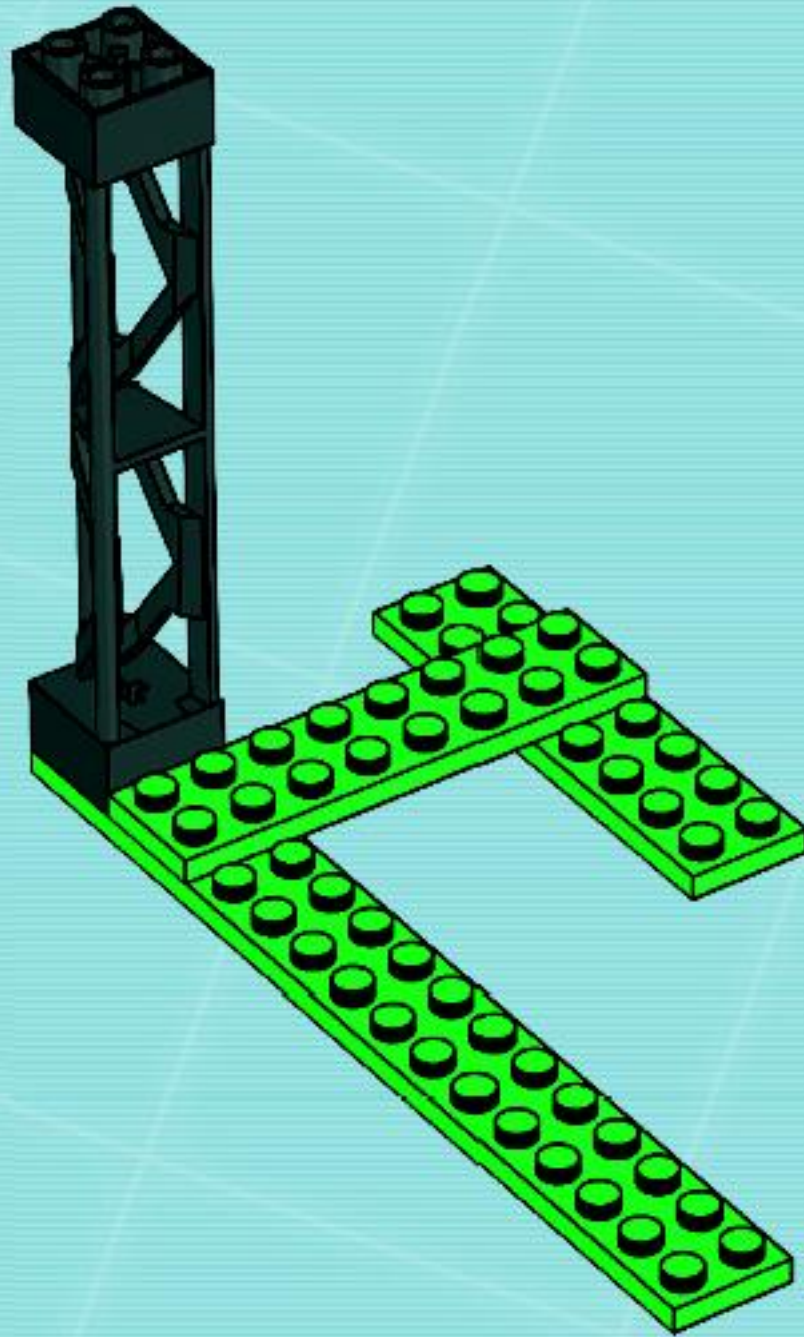

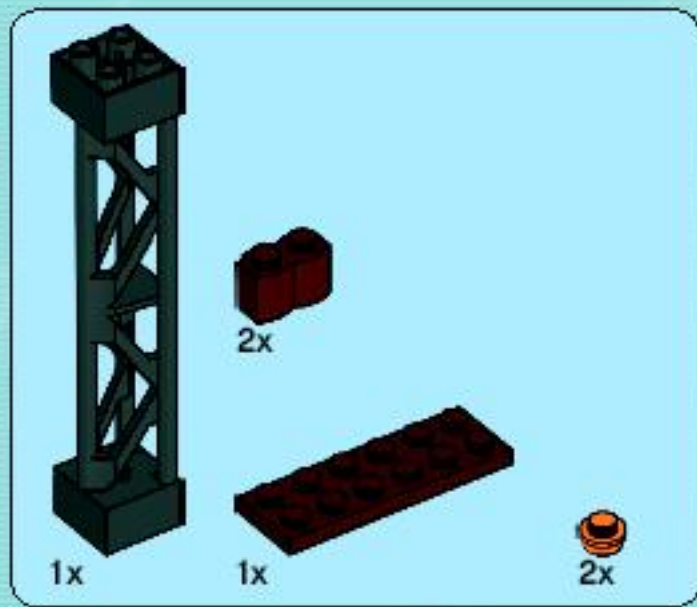

3

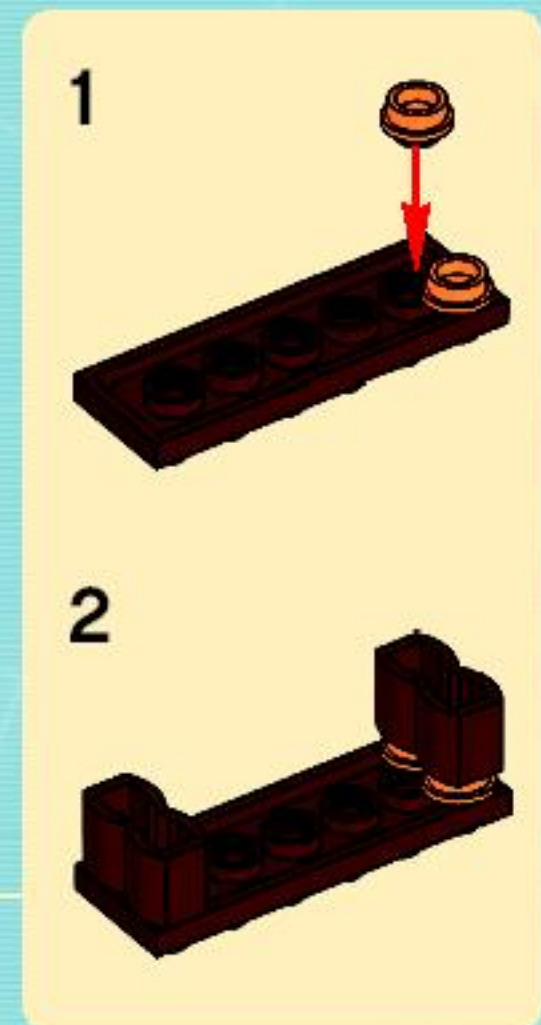
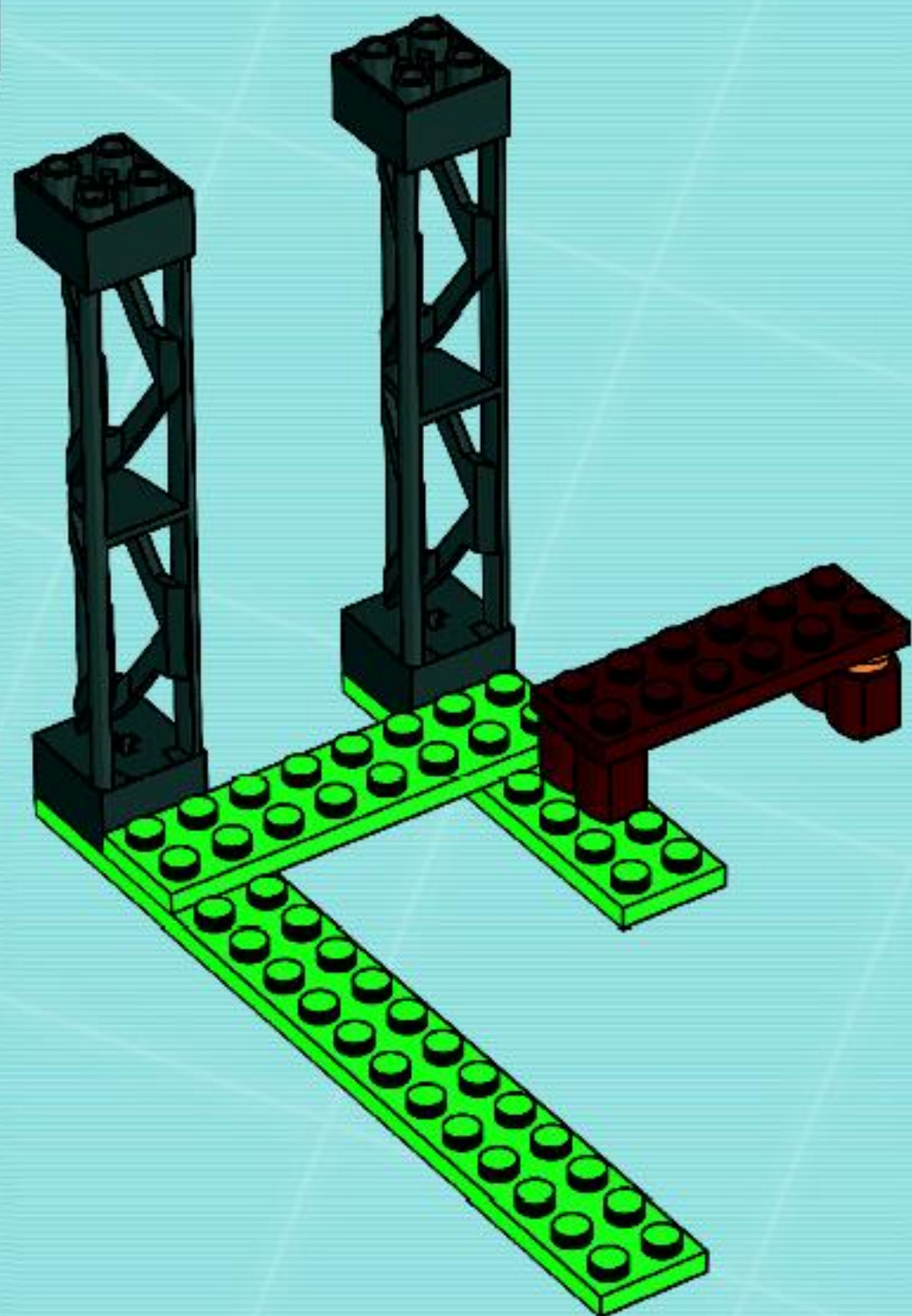

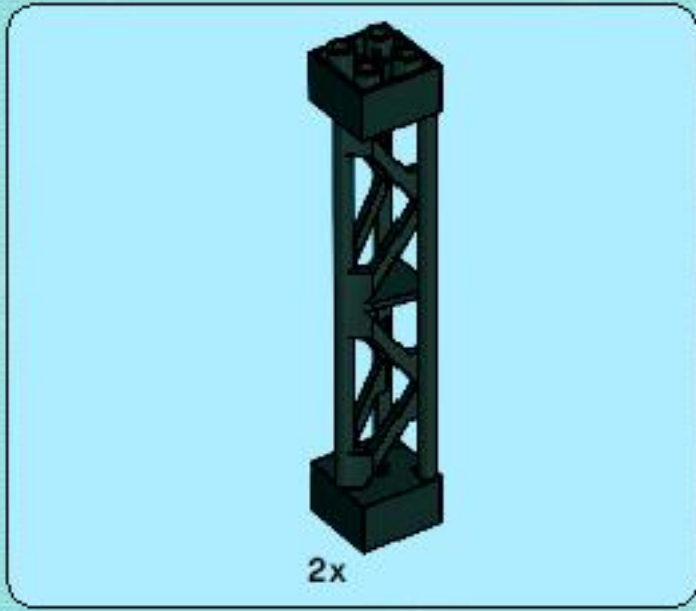

4

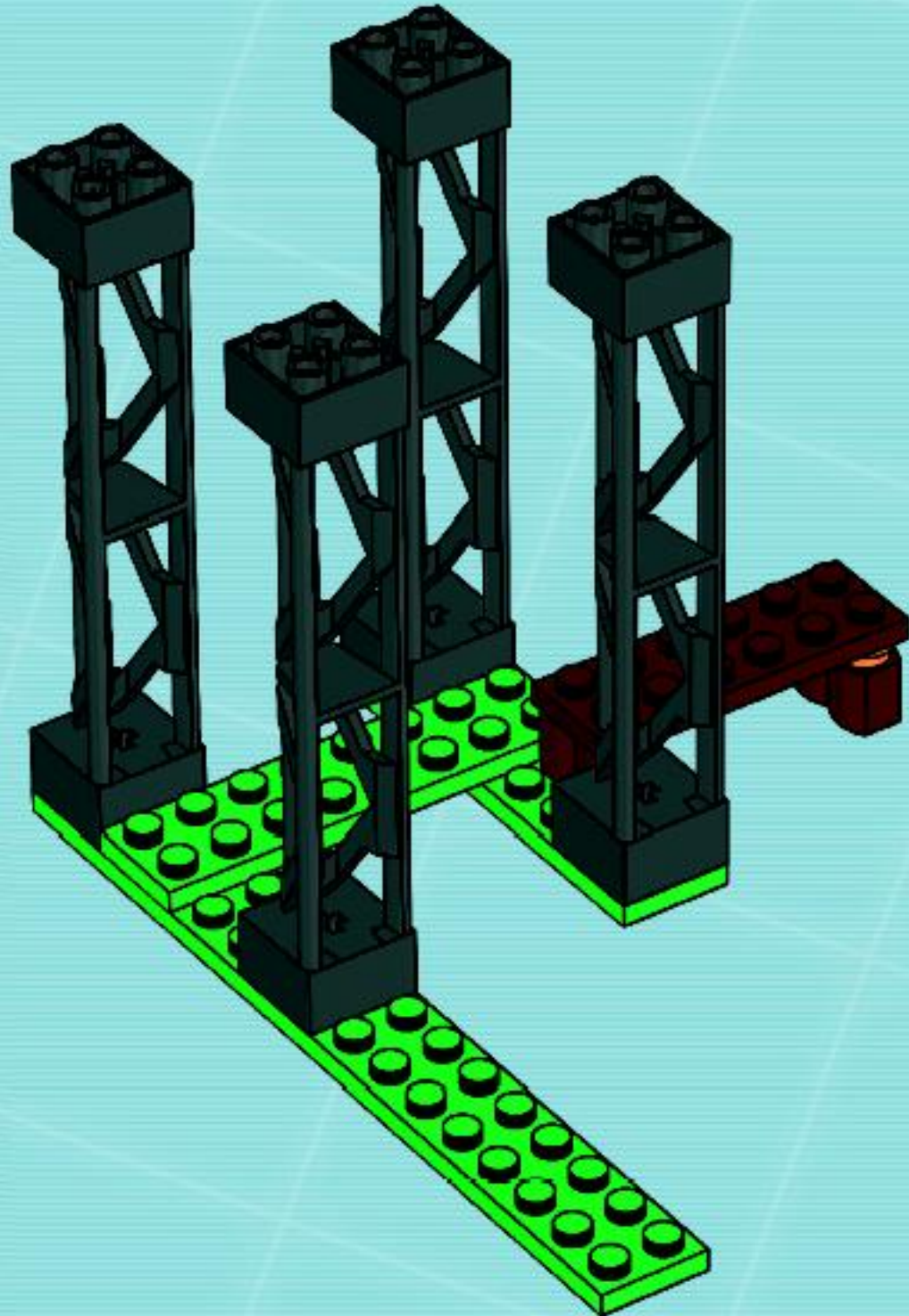

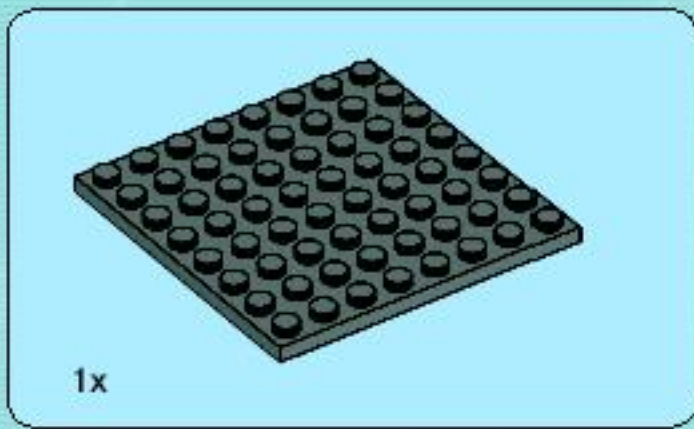

5

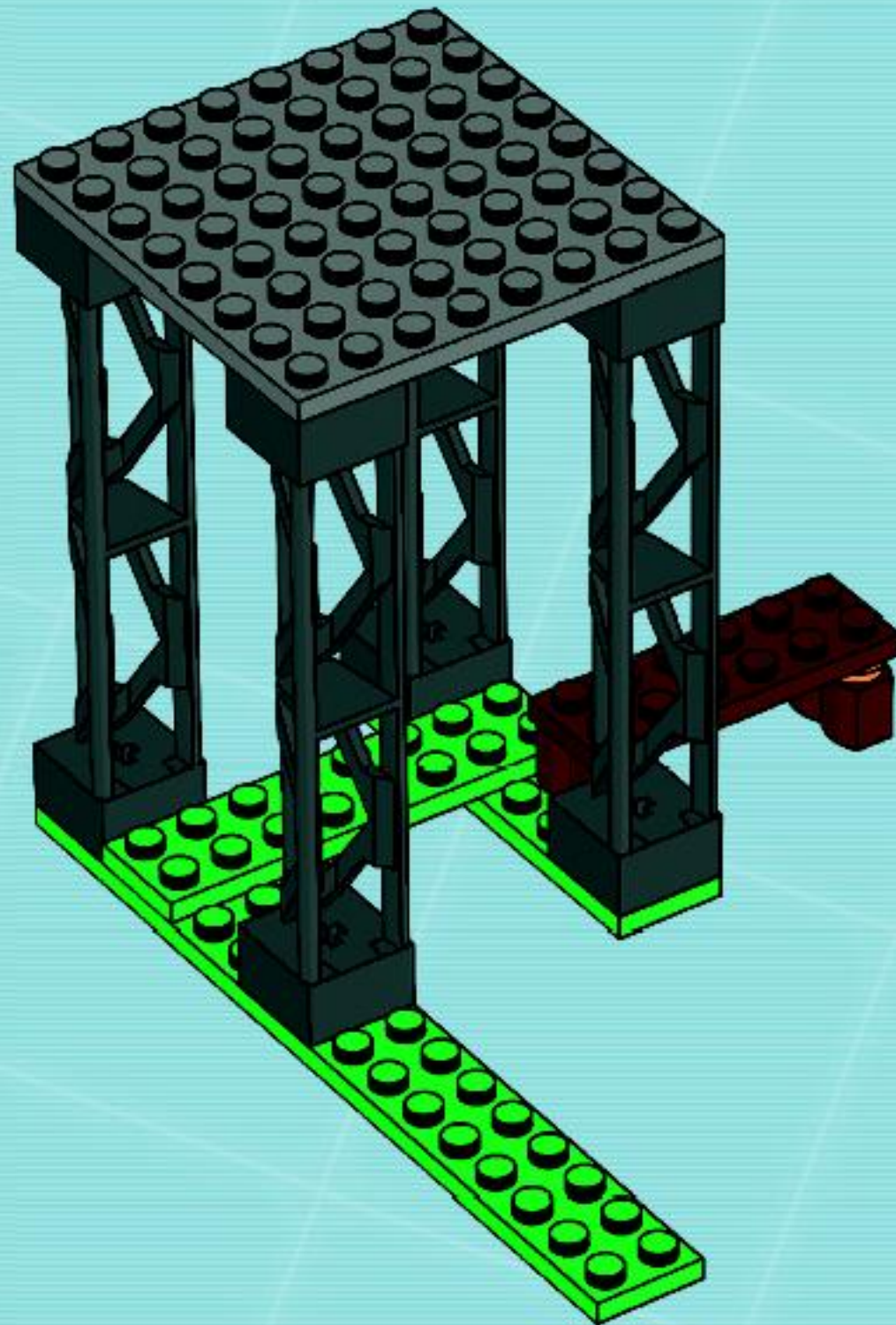

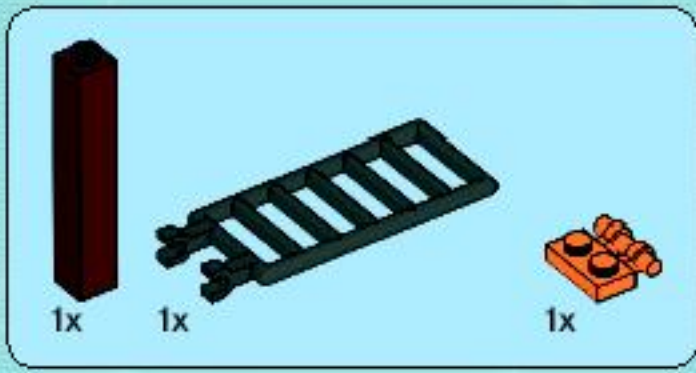

6

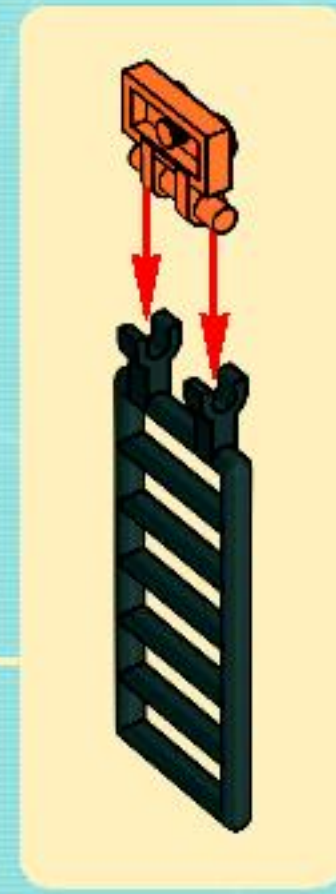

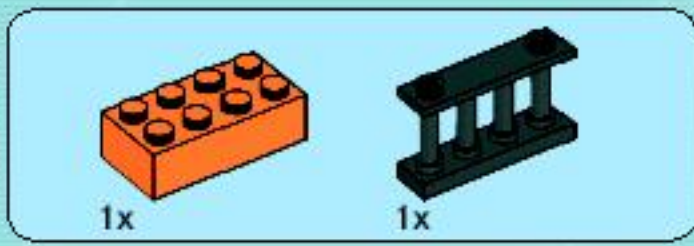

7

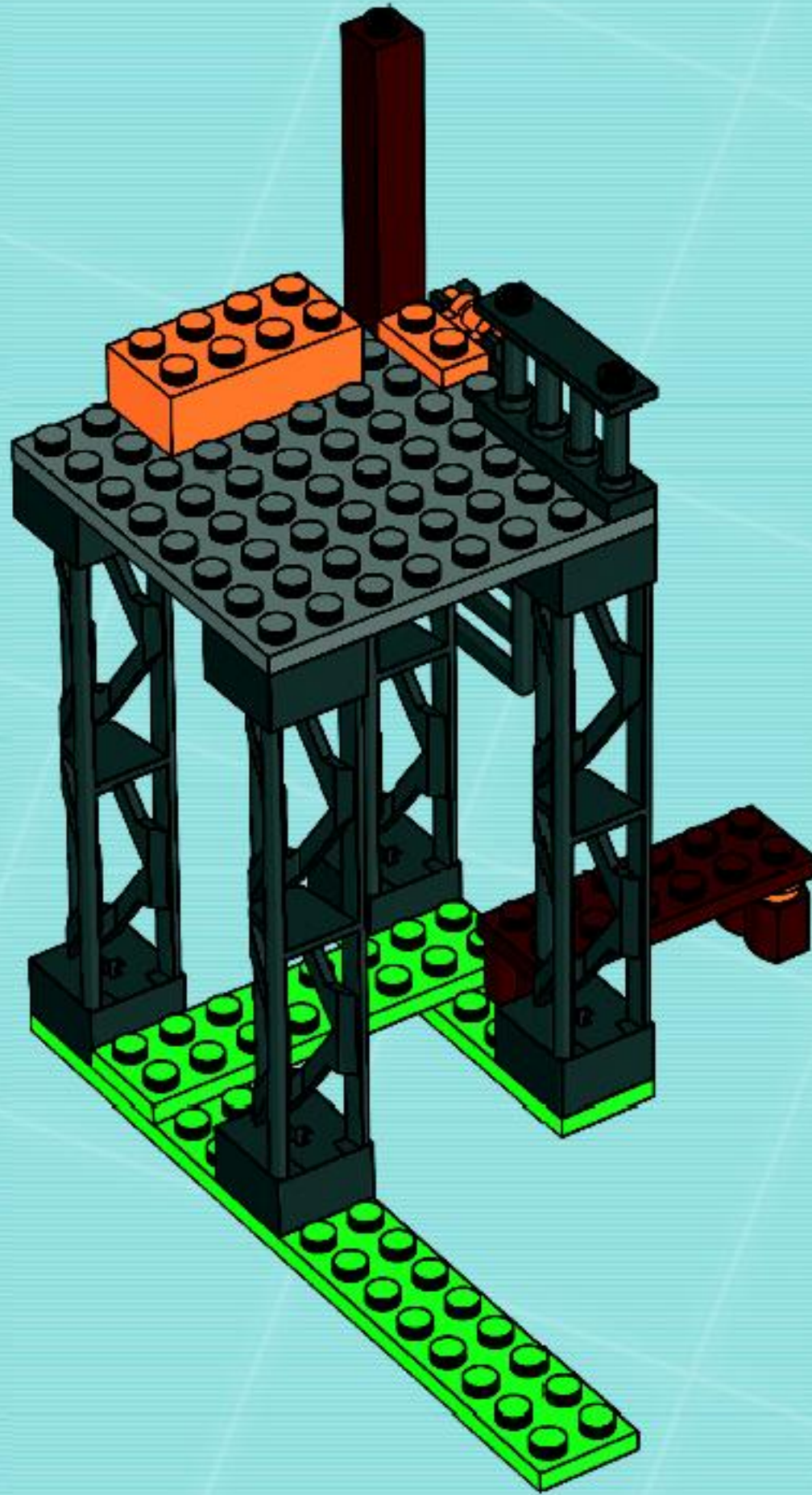

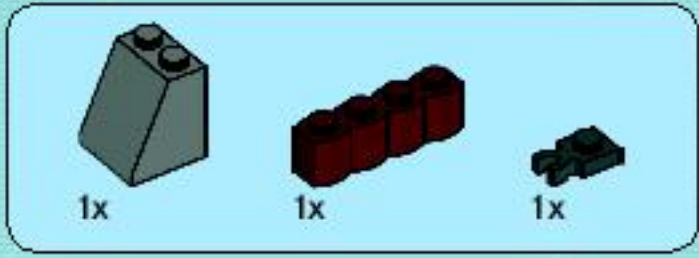

8

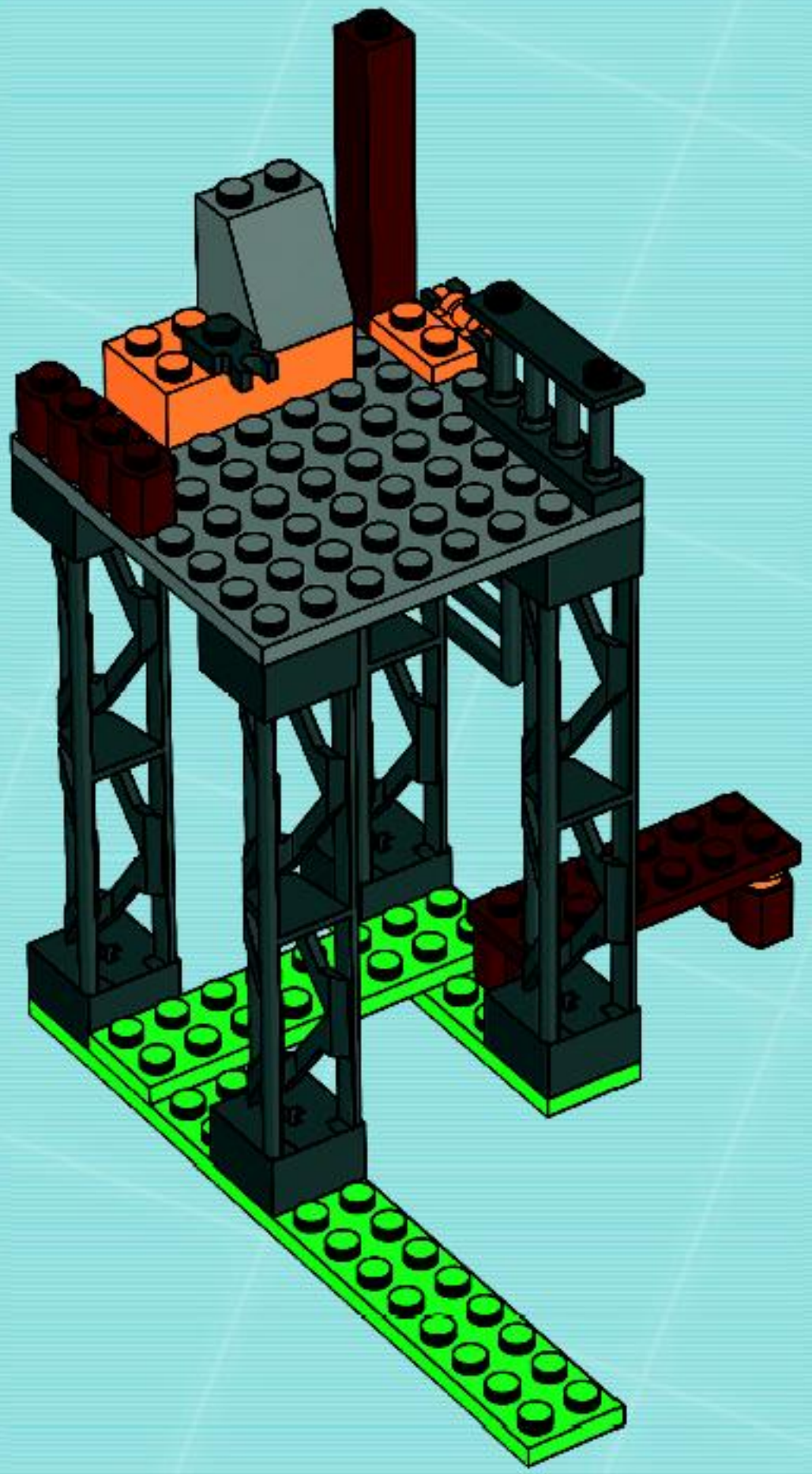



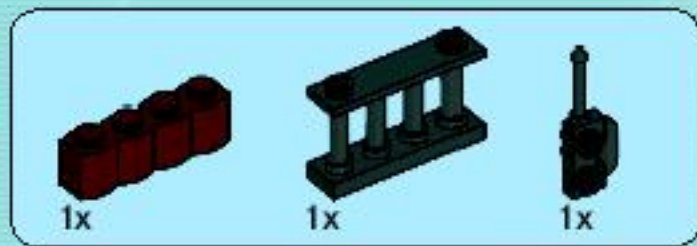

9

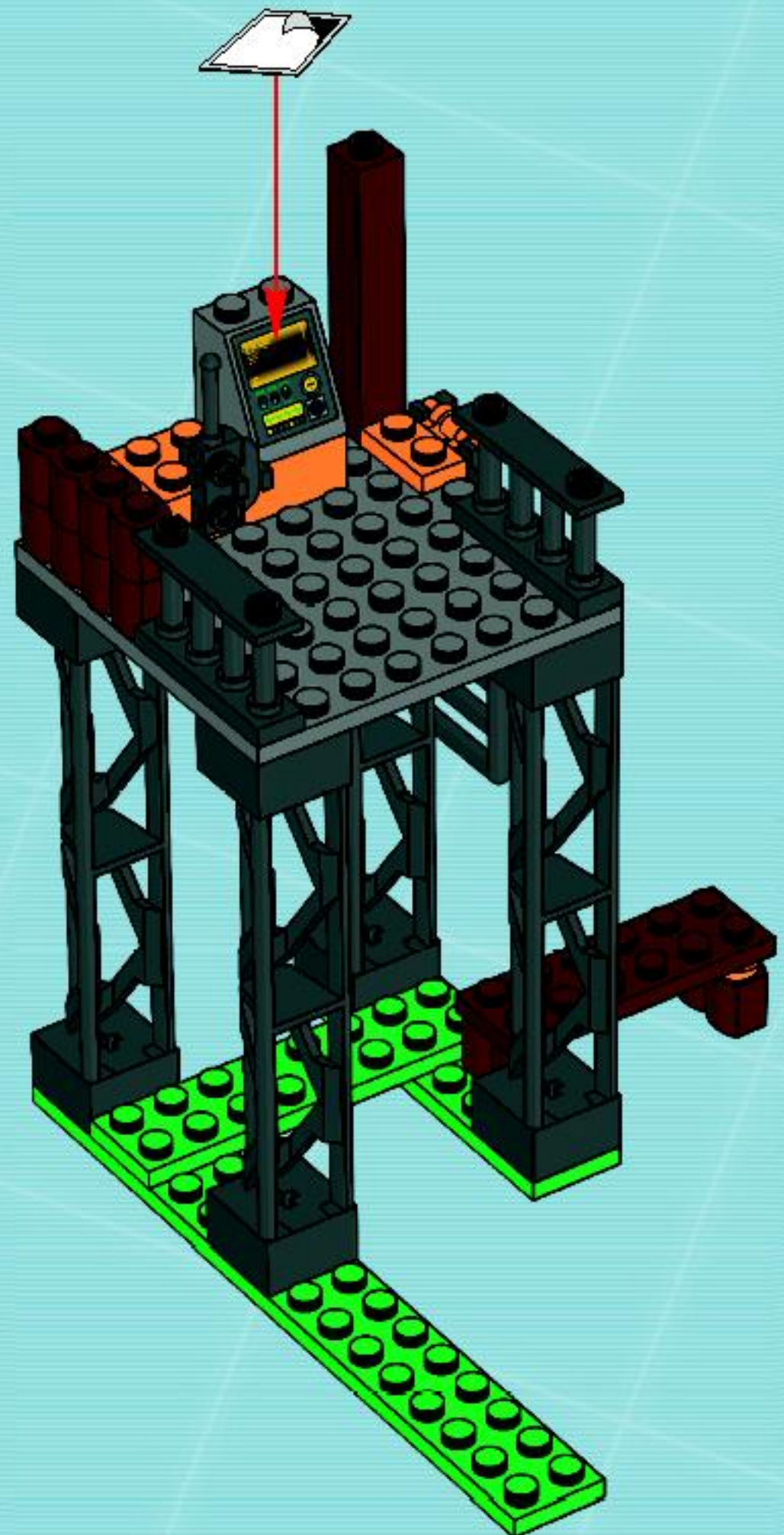

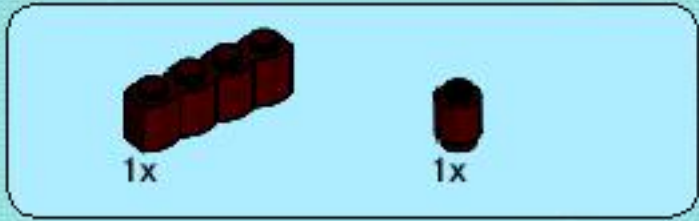

# 10

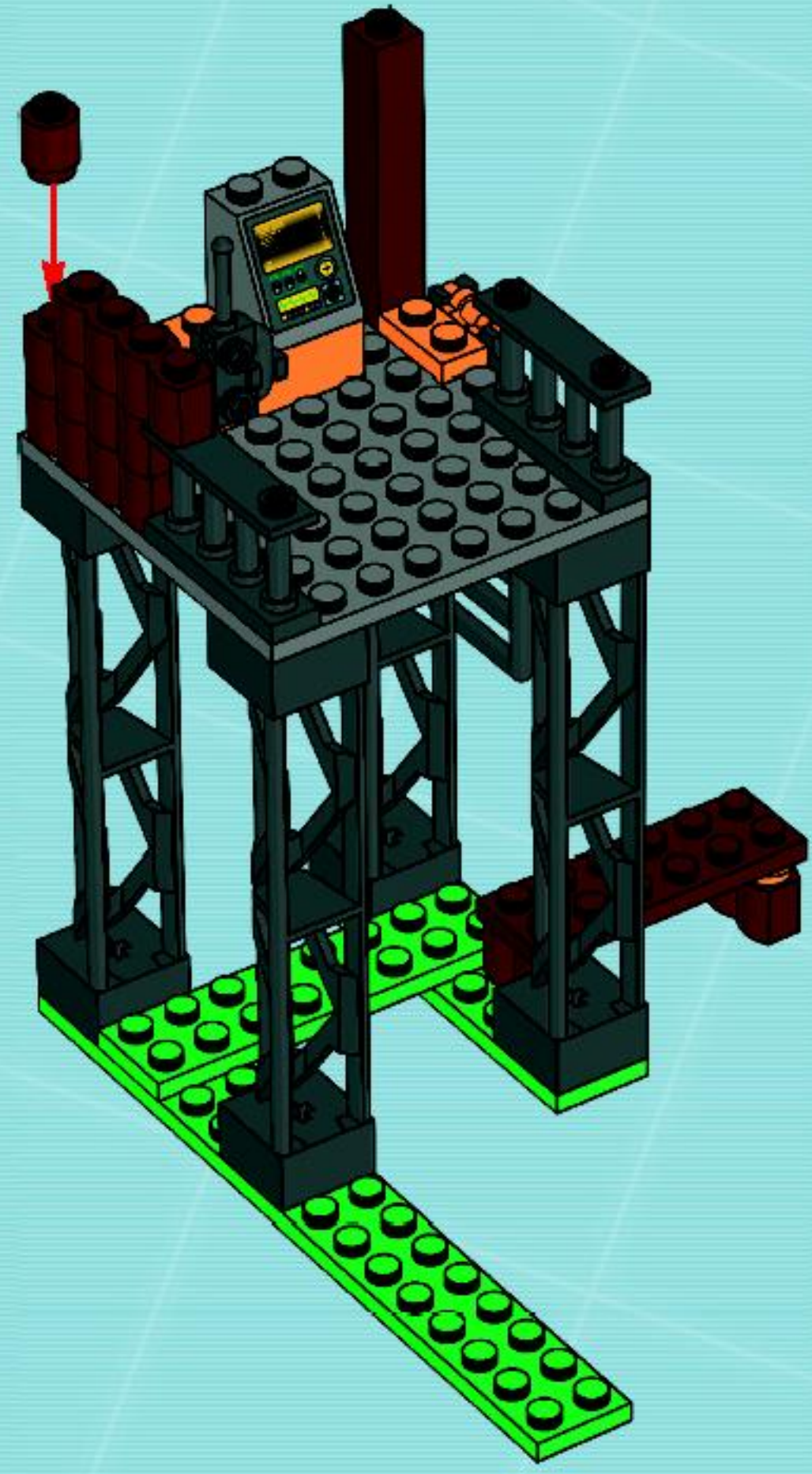



11

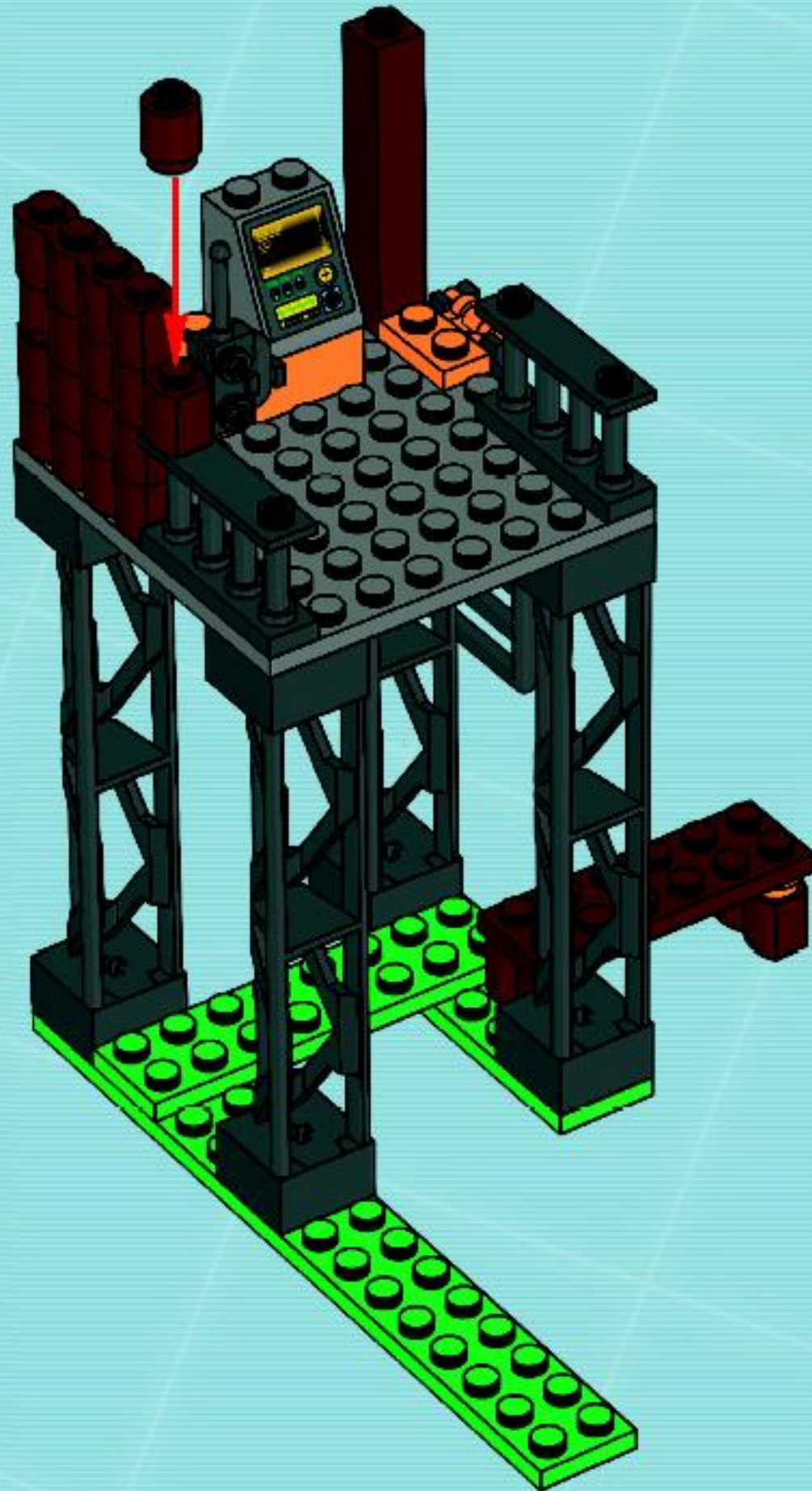



12

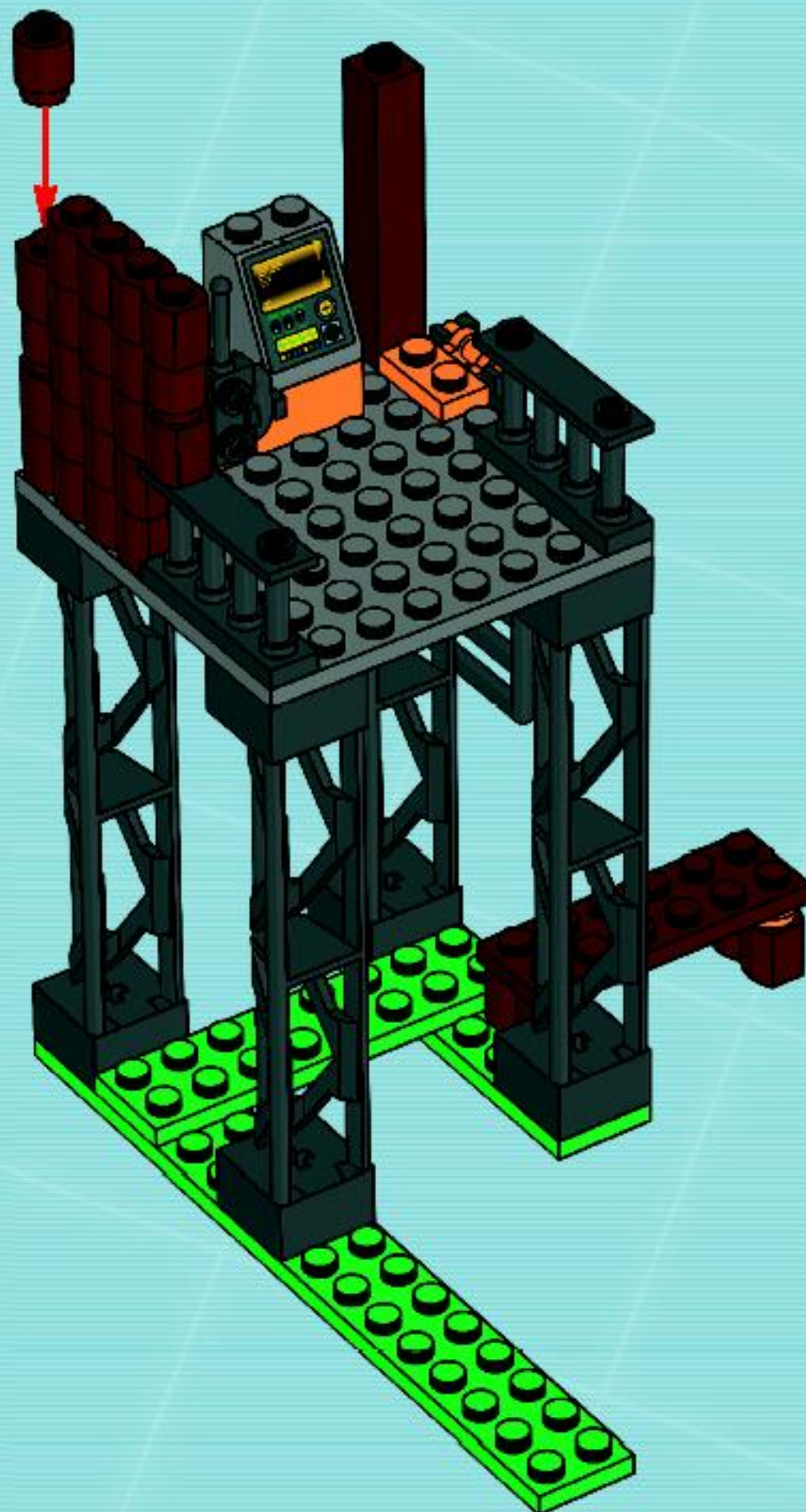



1x



3x



1x

# 13

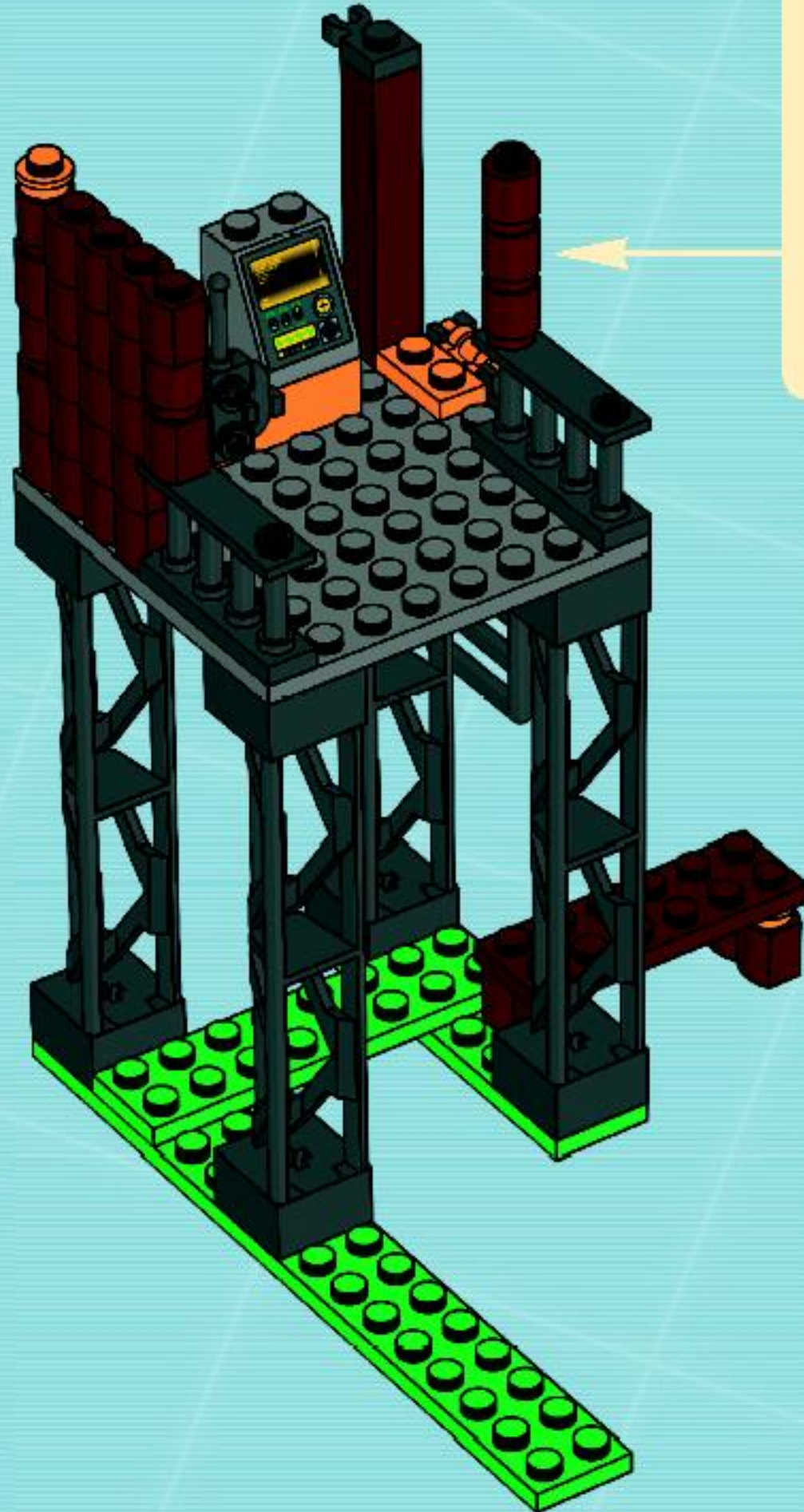

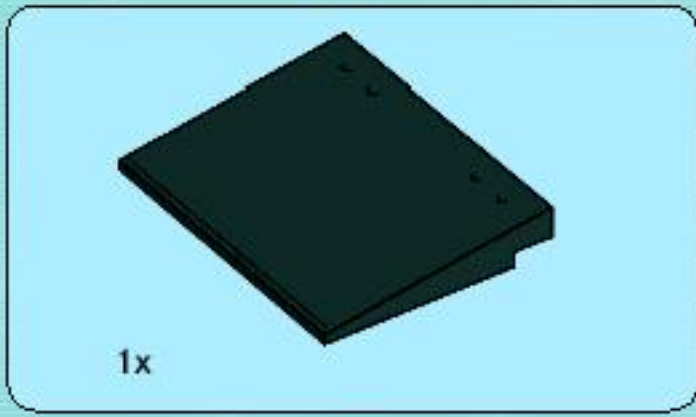

14

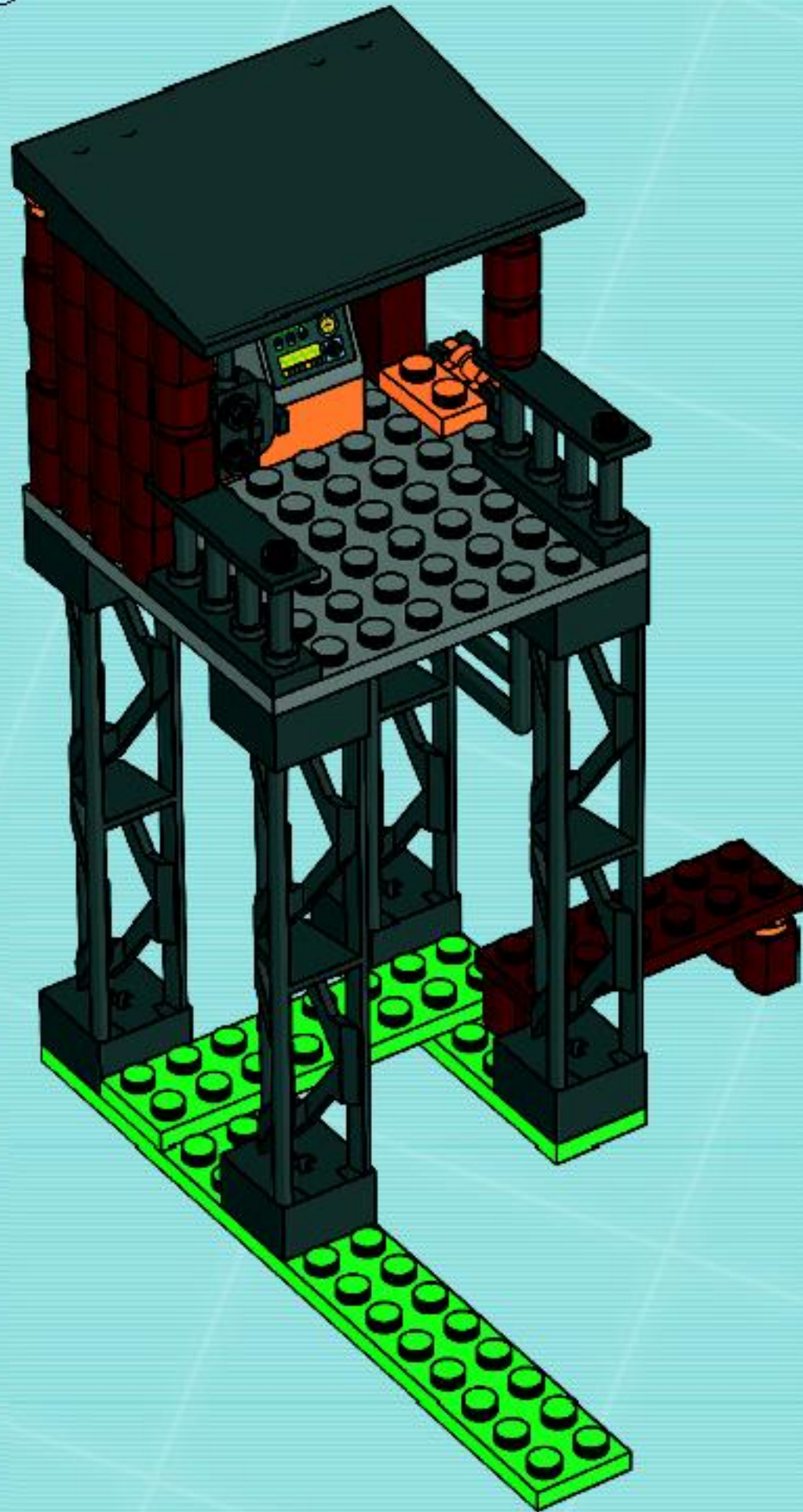



2x



2x

# 15

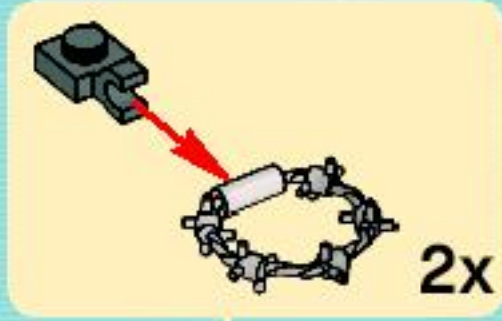
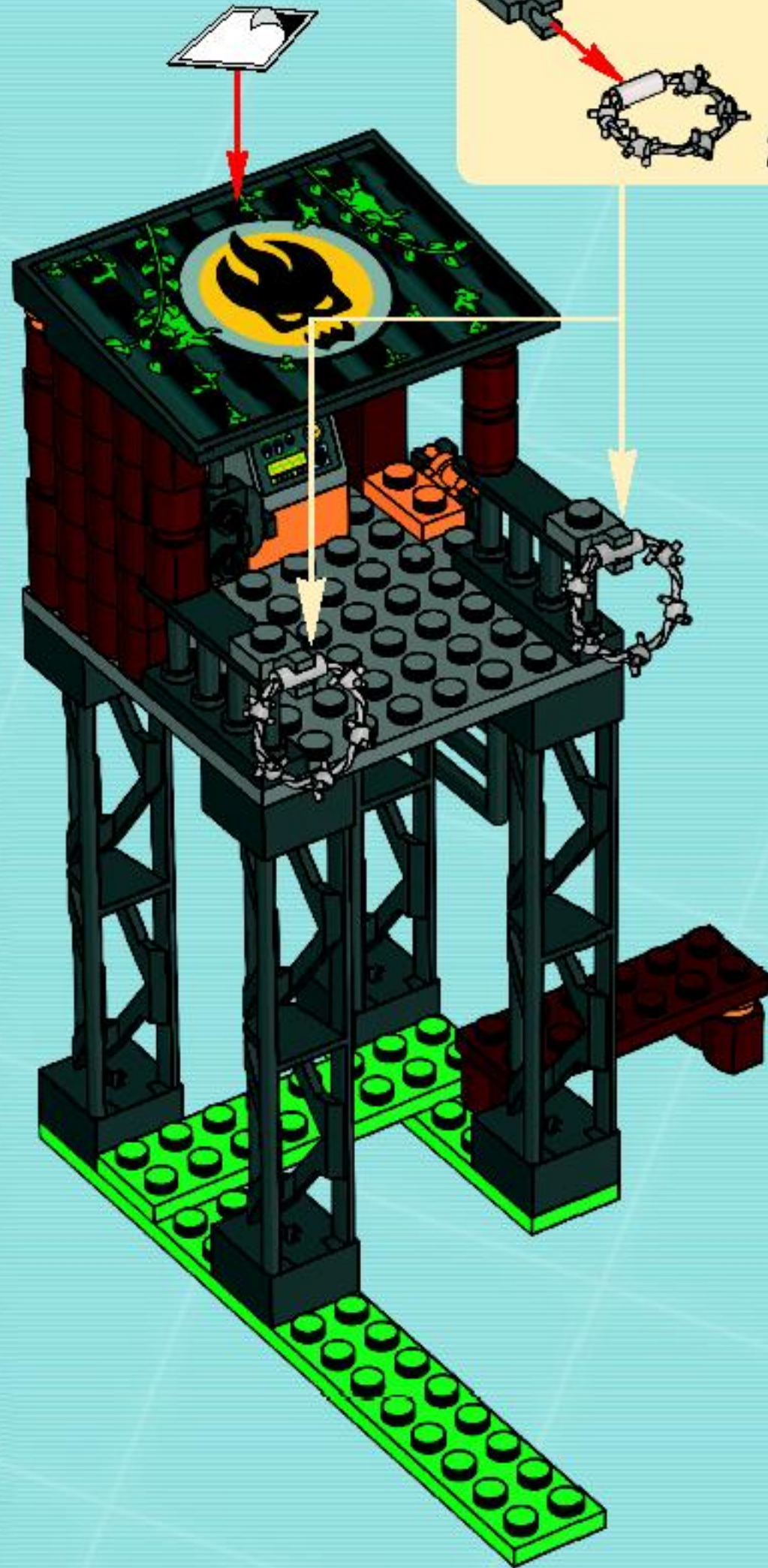

2x

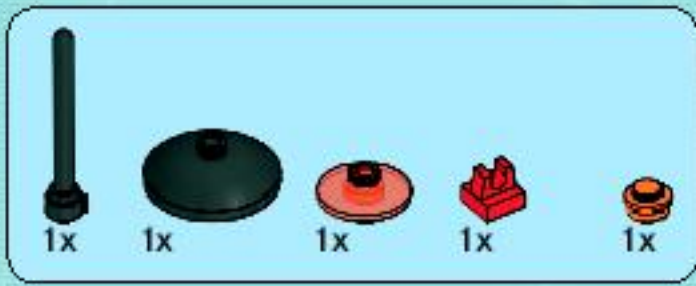

16

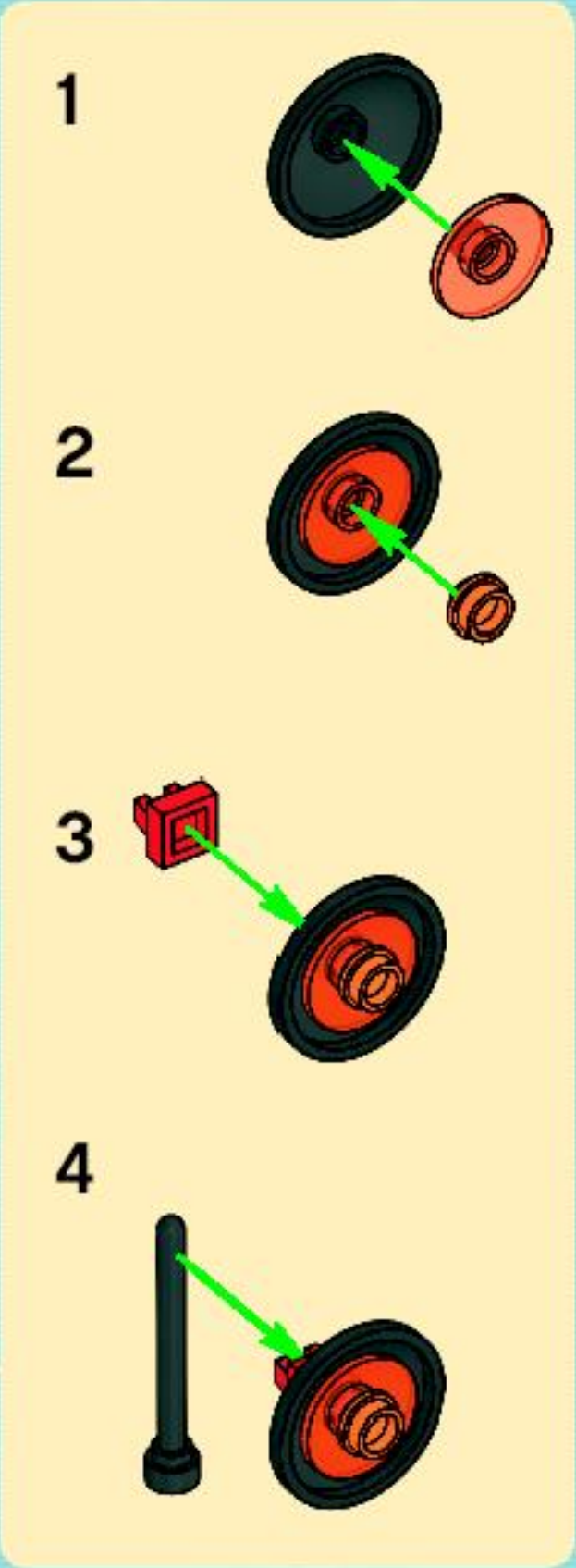
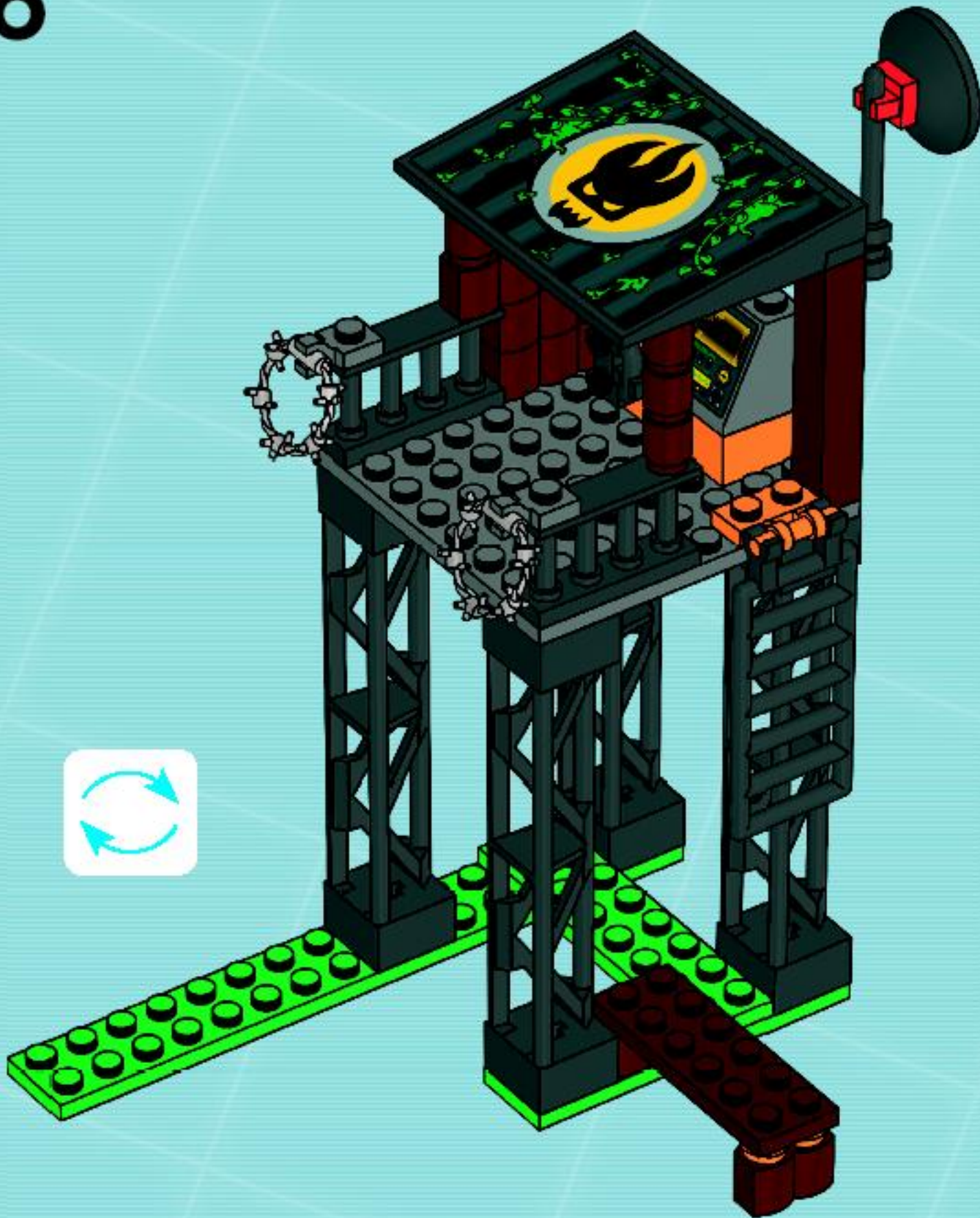



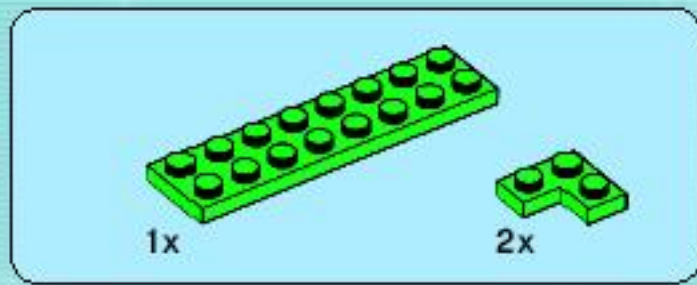

17

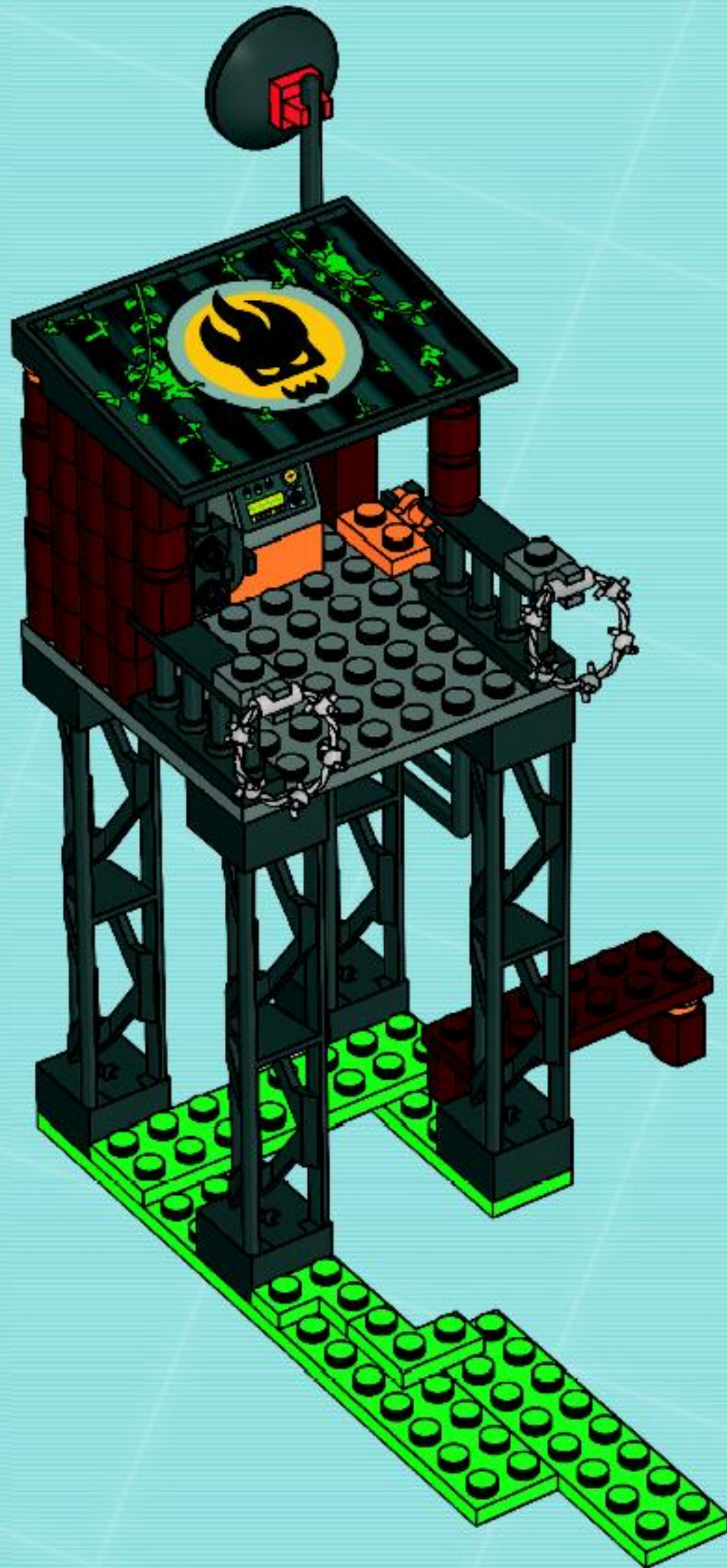

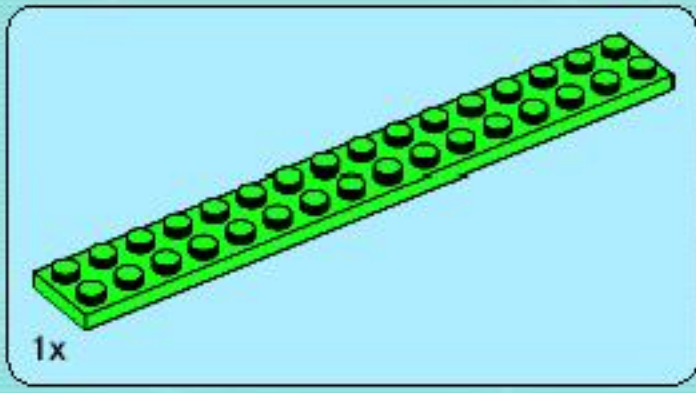

18



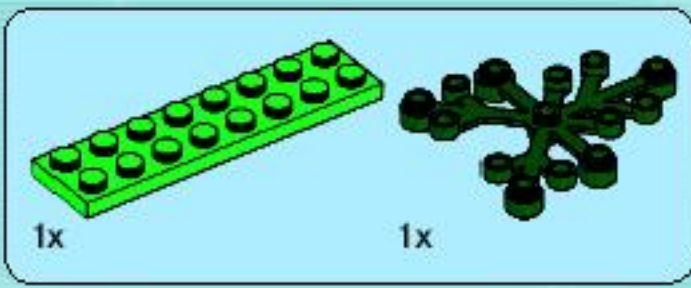

19



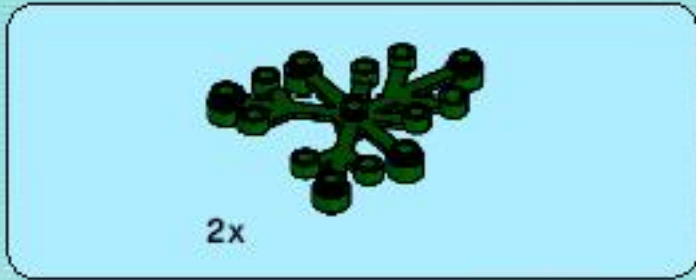

20



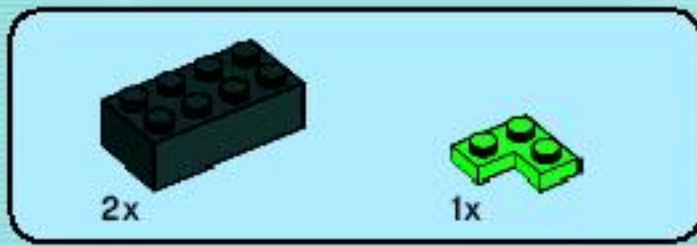

21



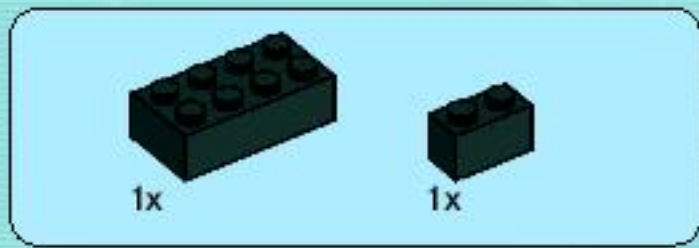

22





1

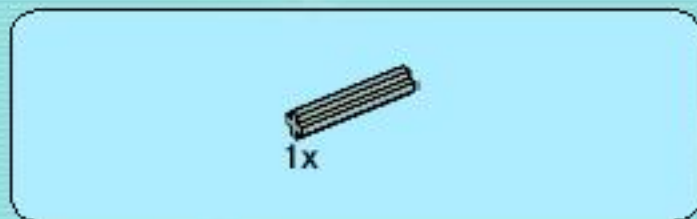
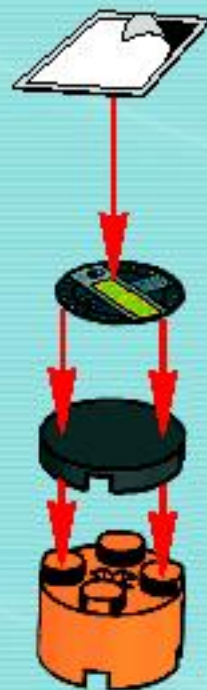

2

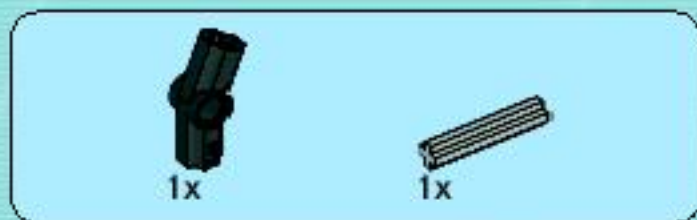
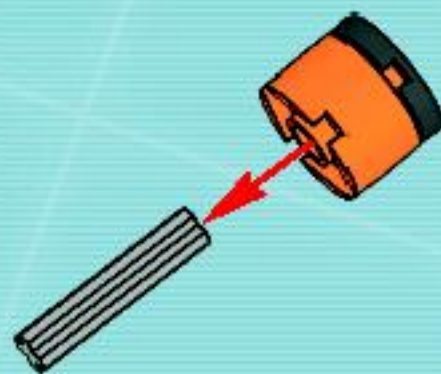

3

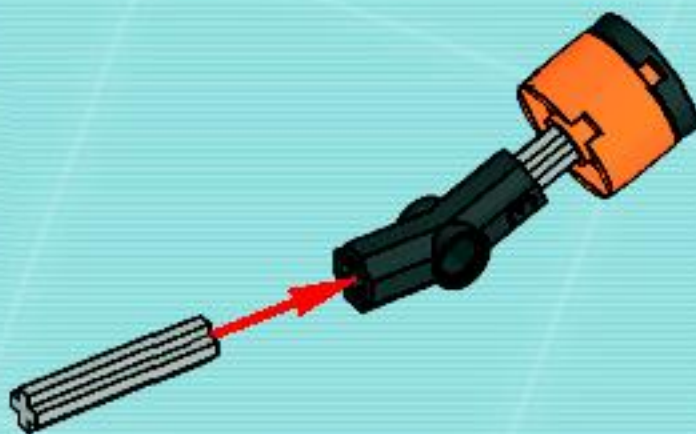

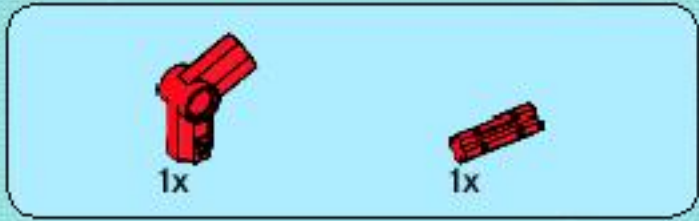

4

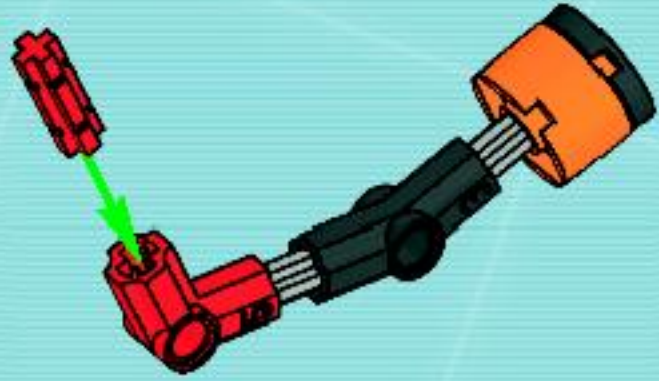

5

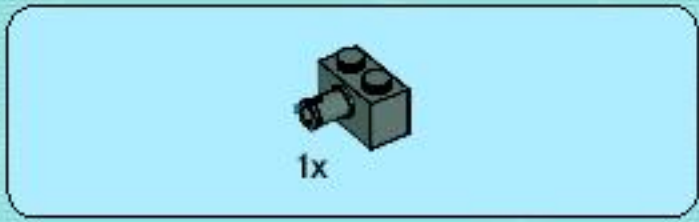
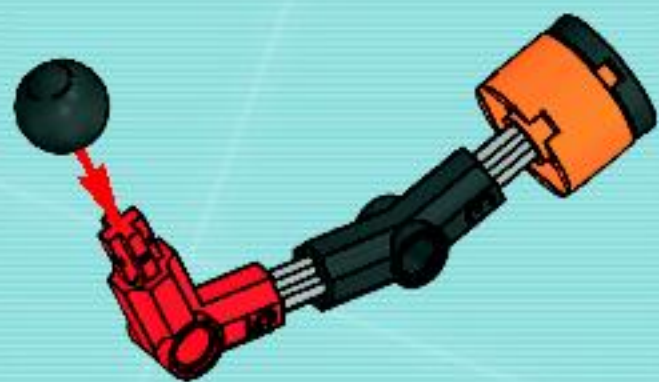

6

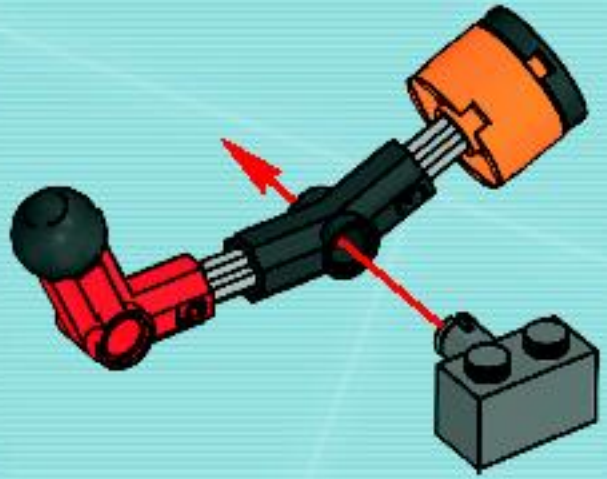



23



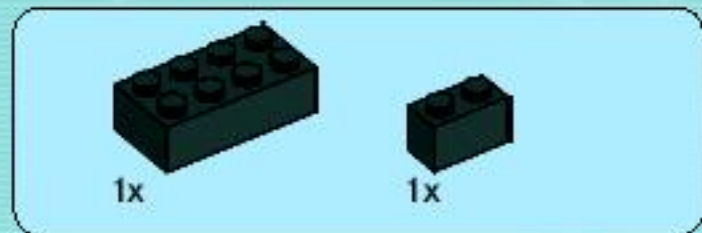

# 24

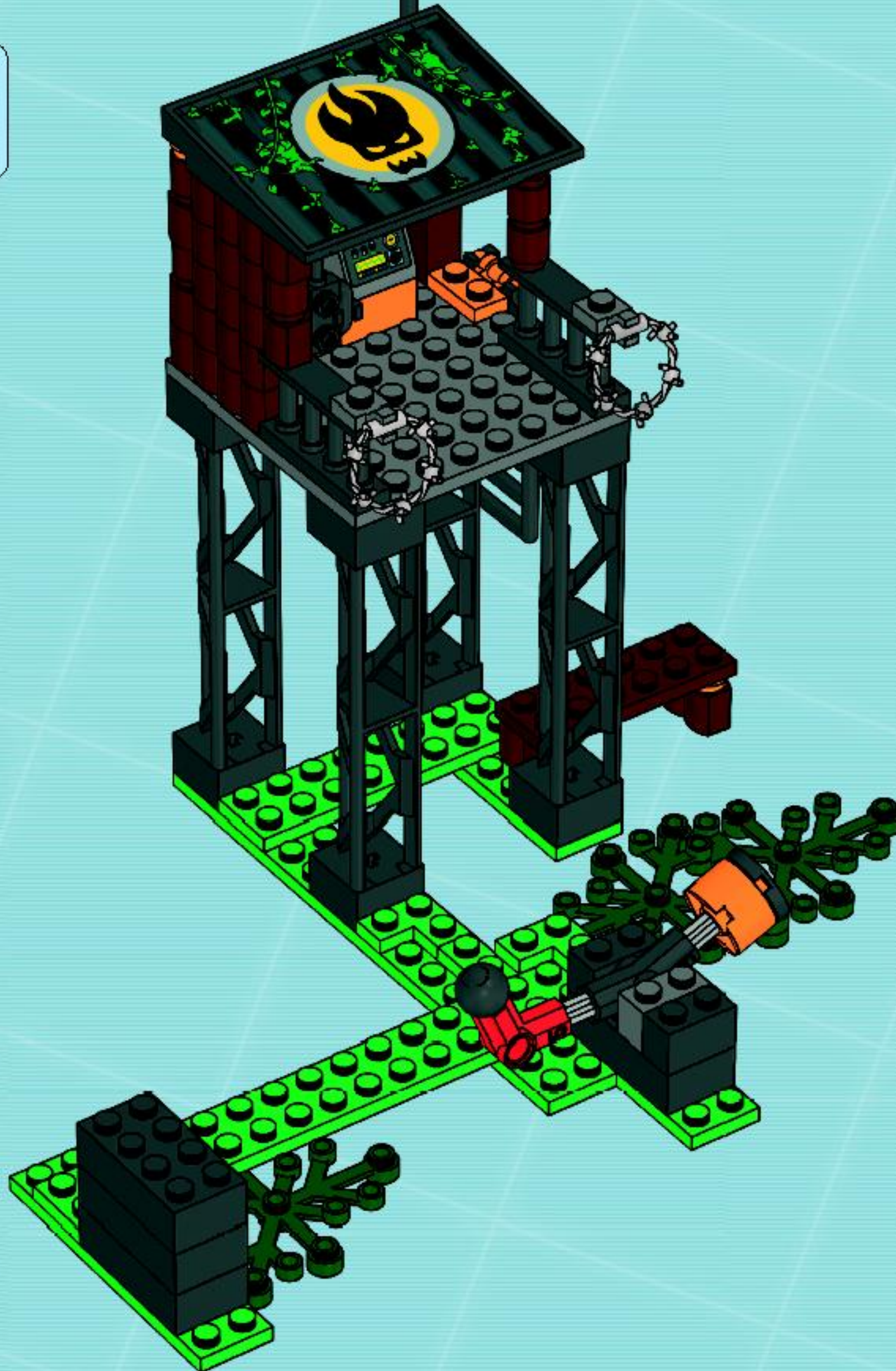



25



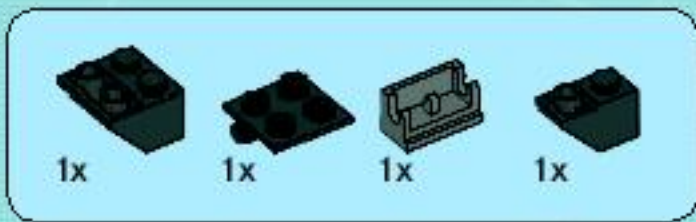

26



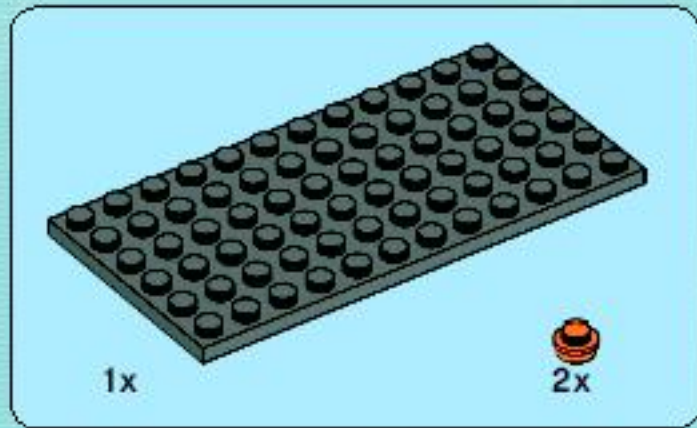

1

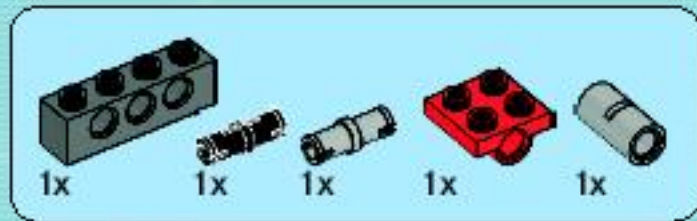
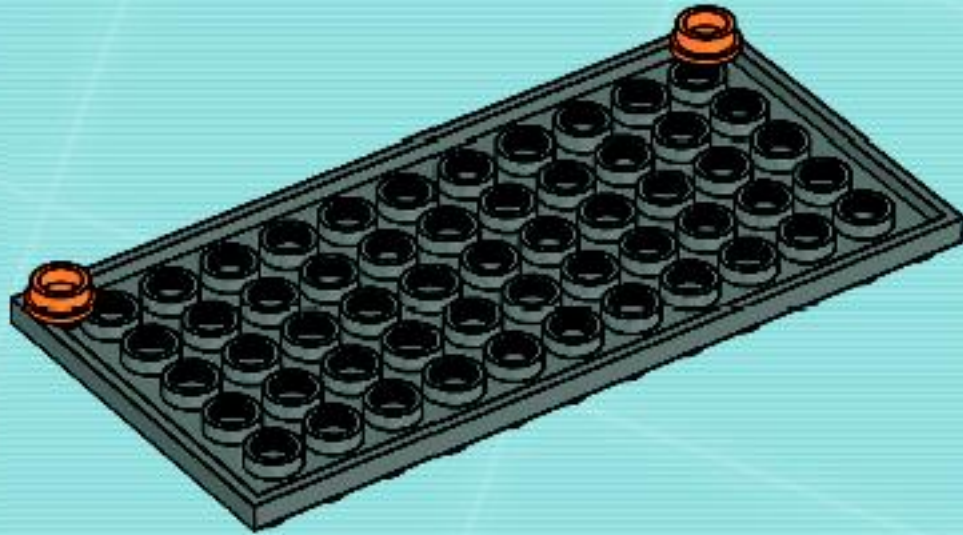

2

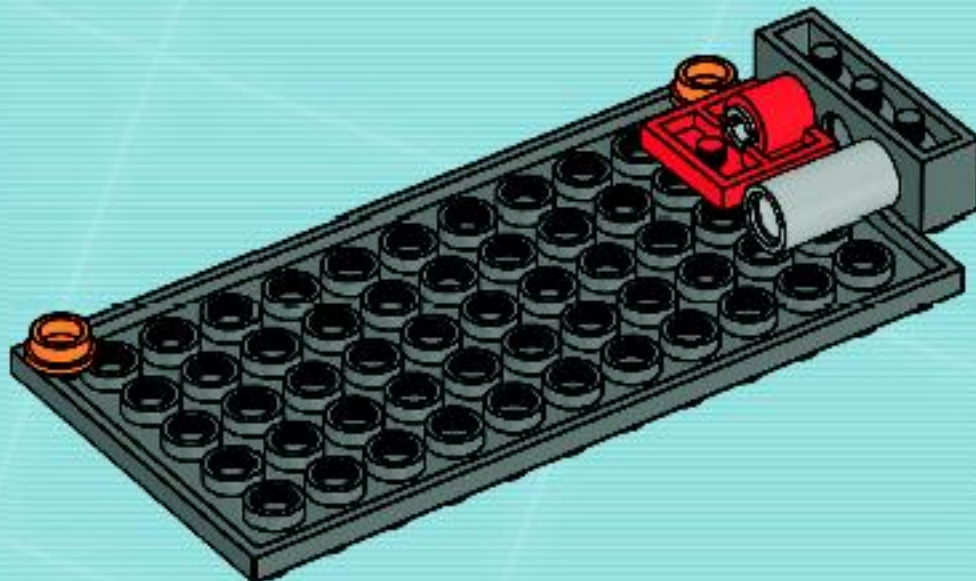
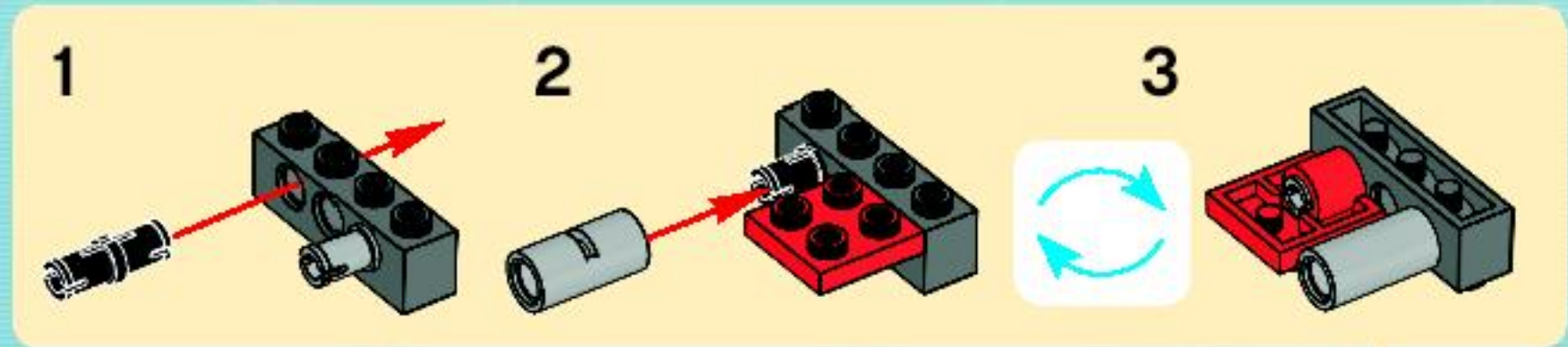

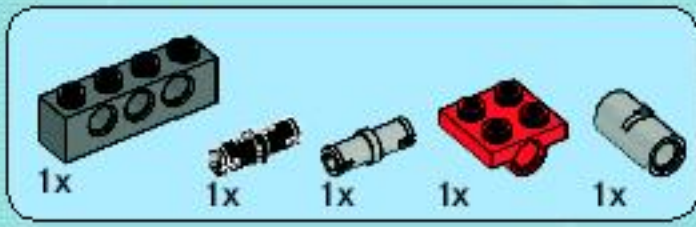

3

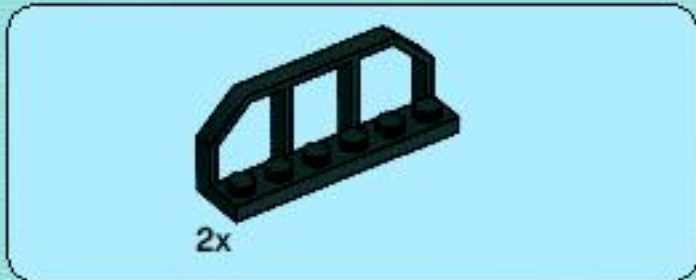
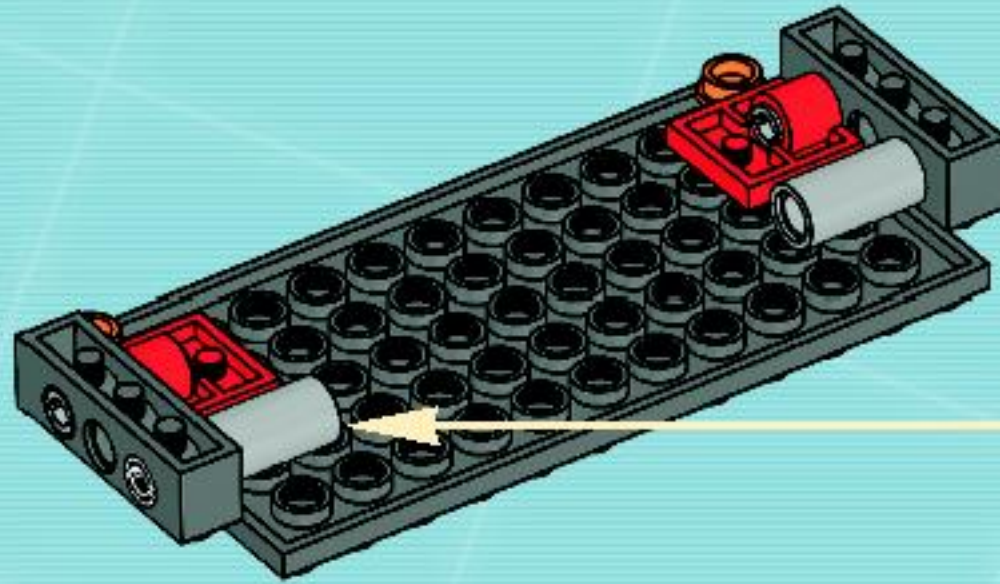
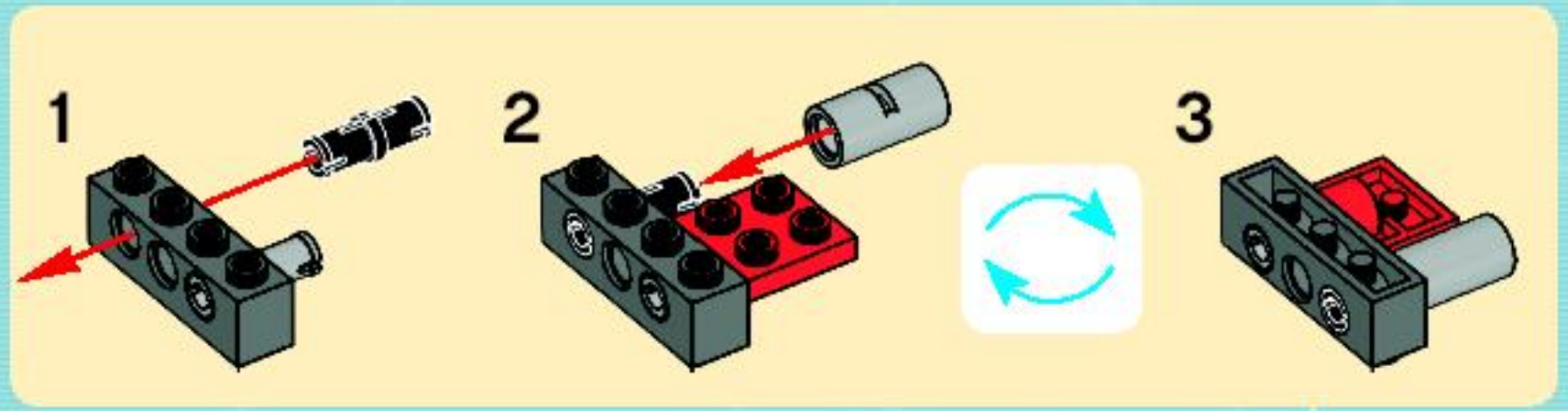

4

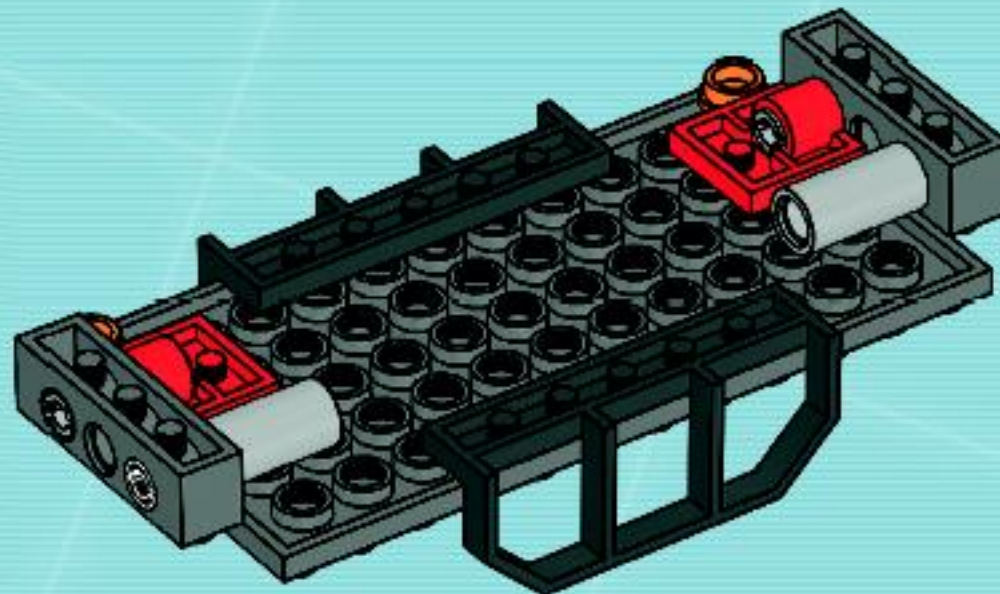

27

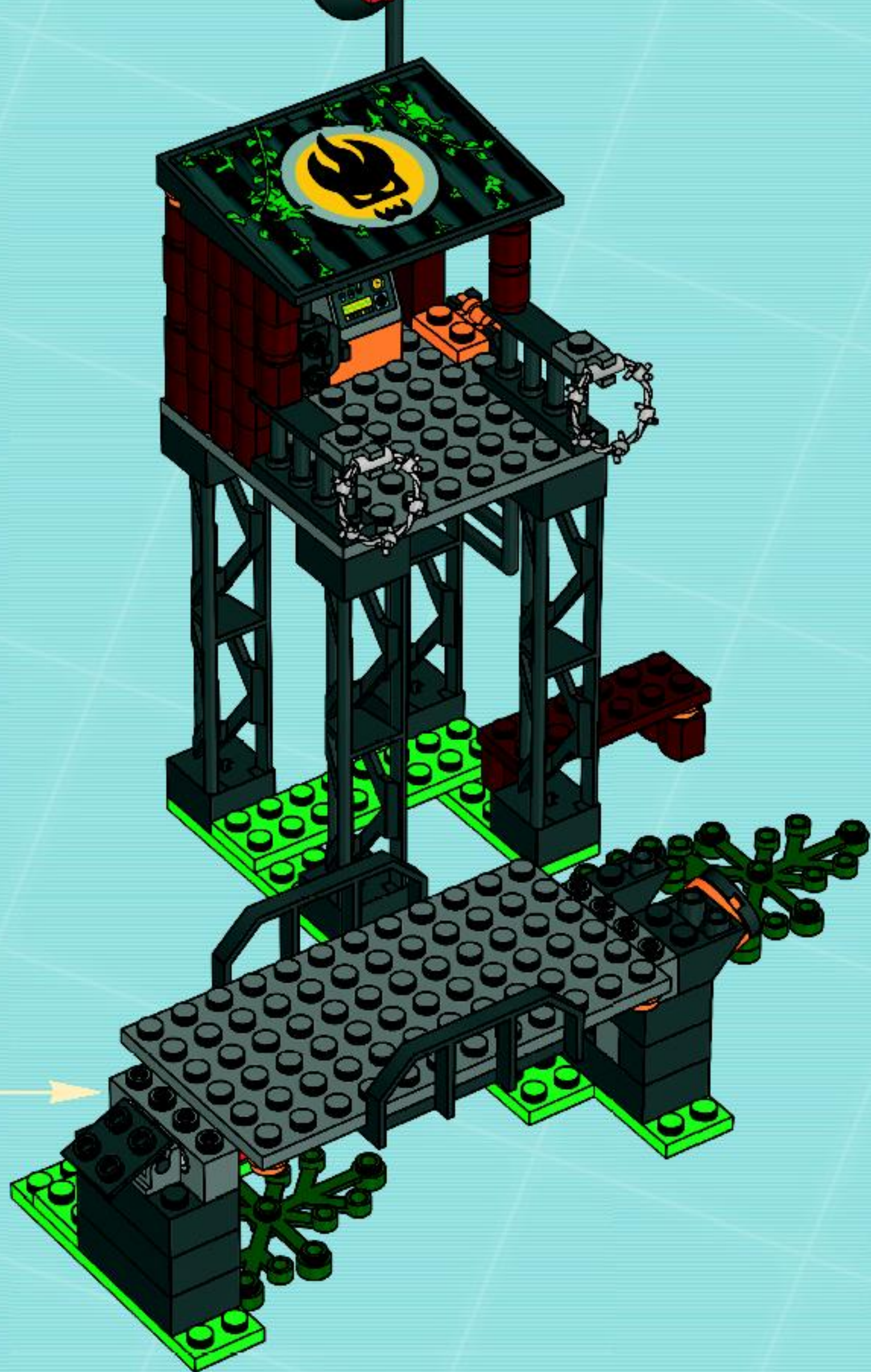

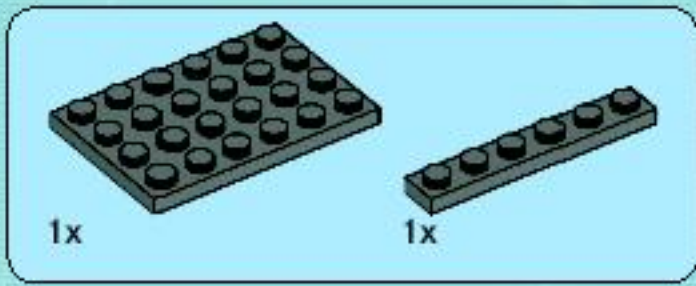

28

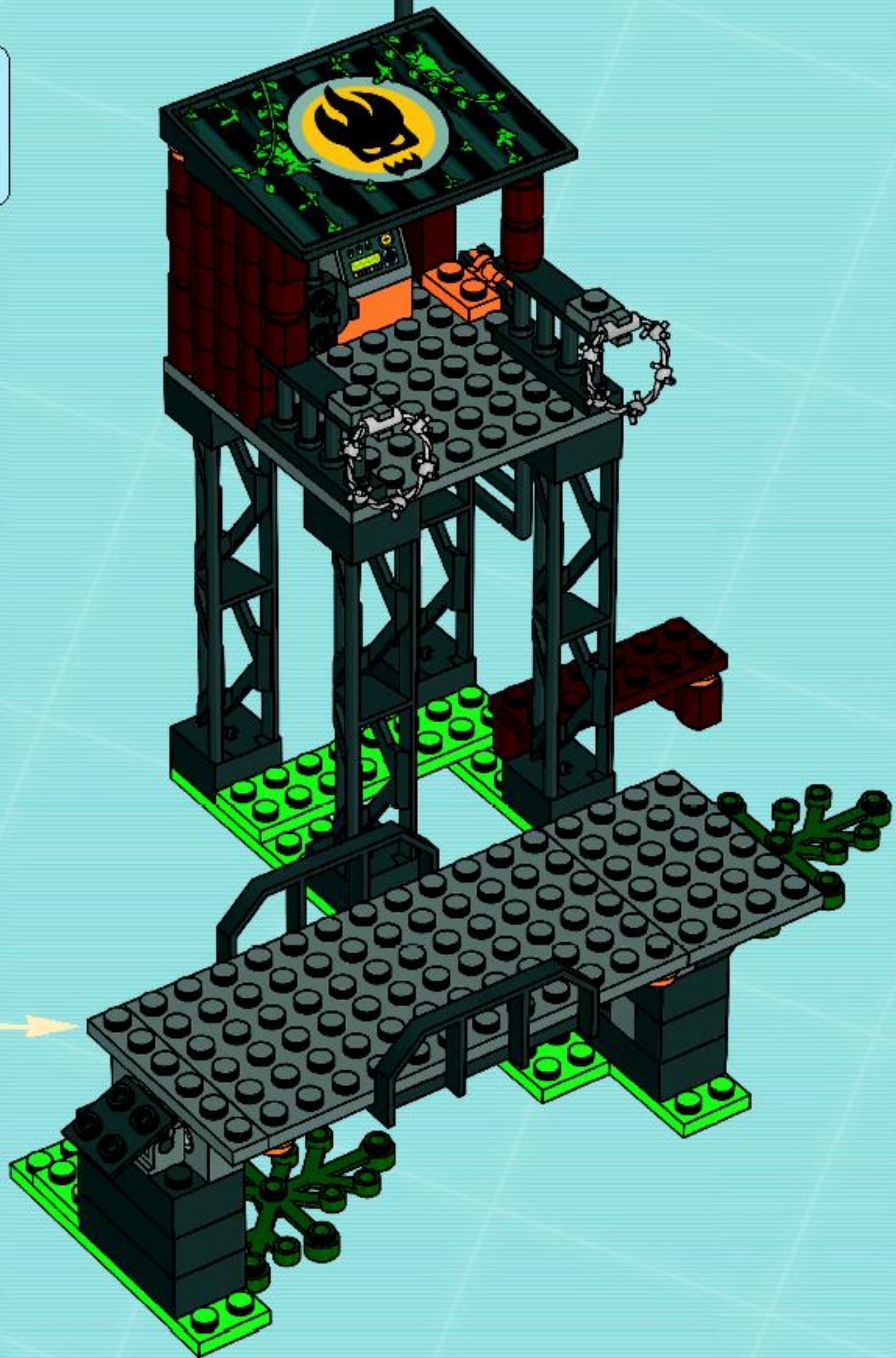





1x

29



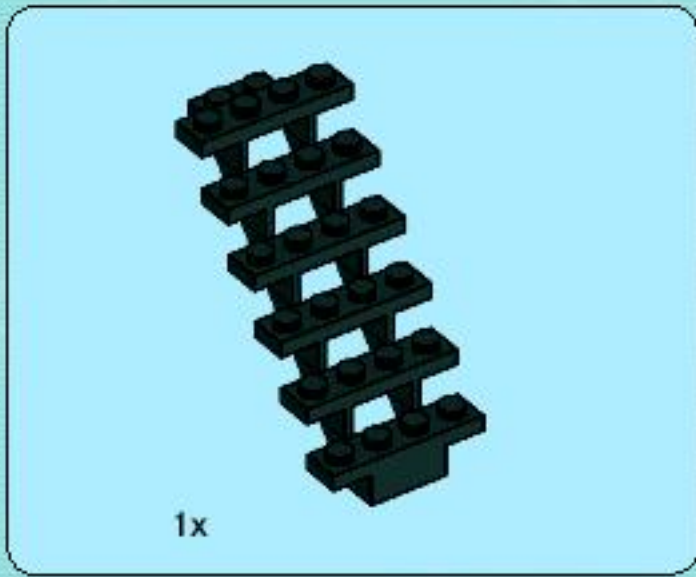

30

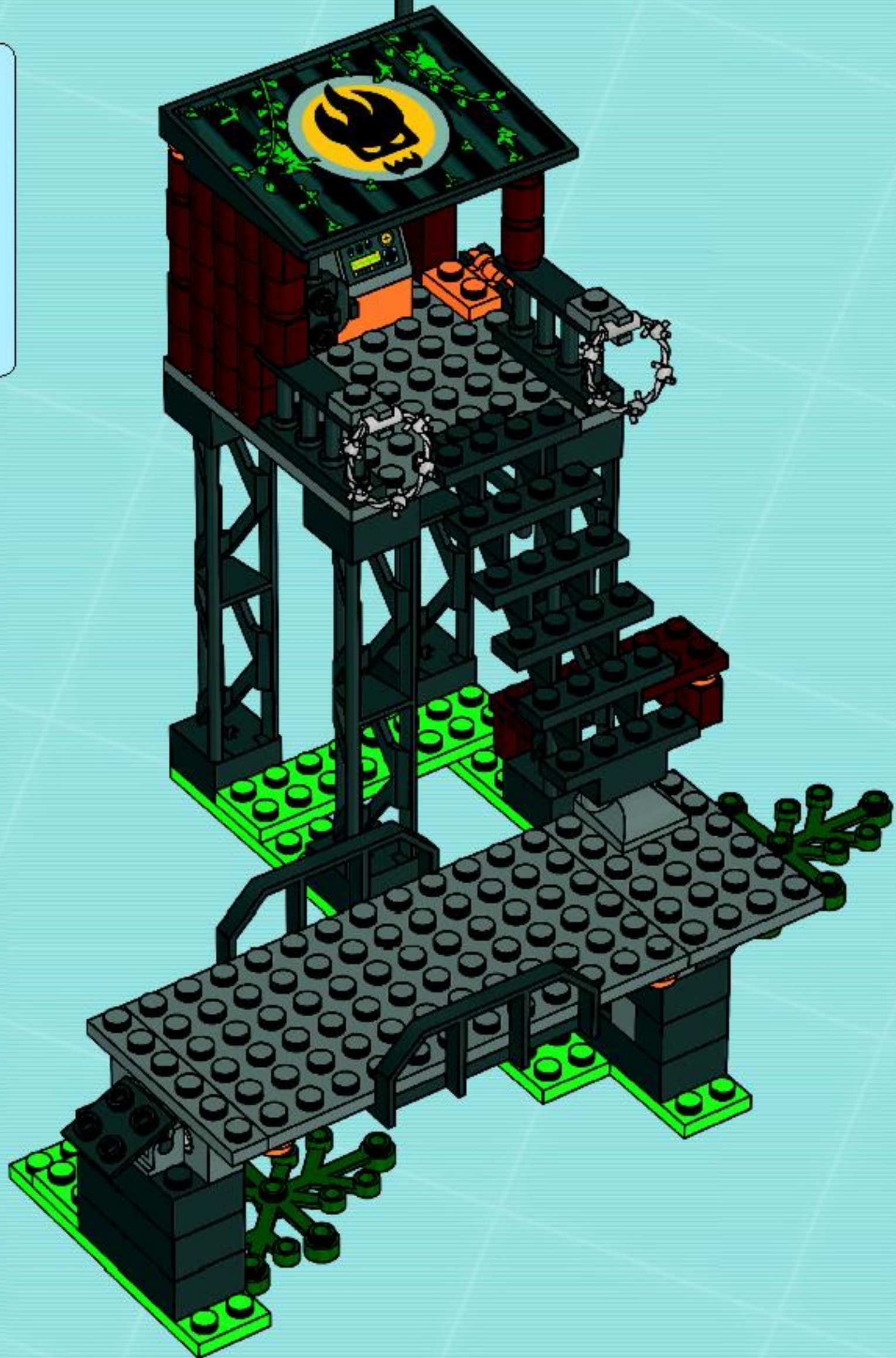

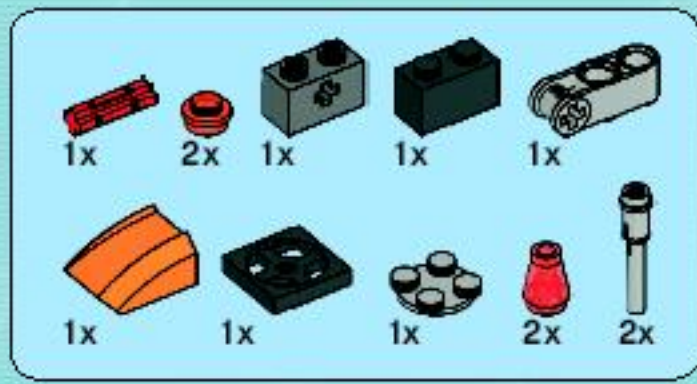

1



2



3

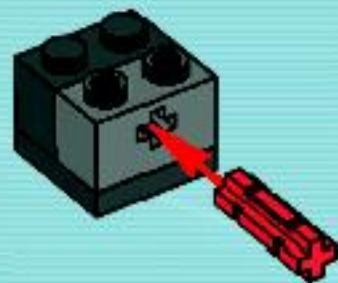

4

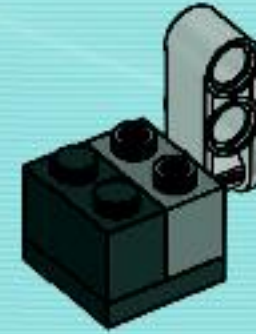

1



2



2x

5

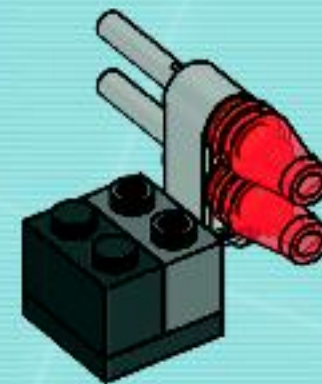

6

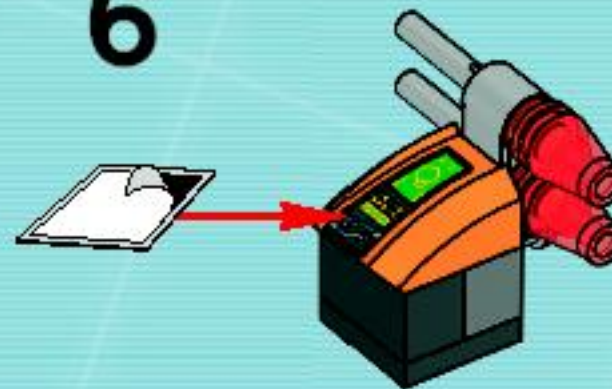

31



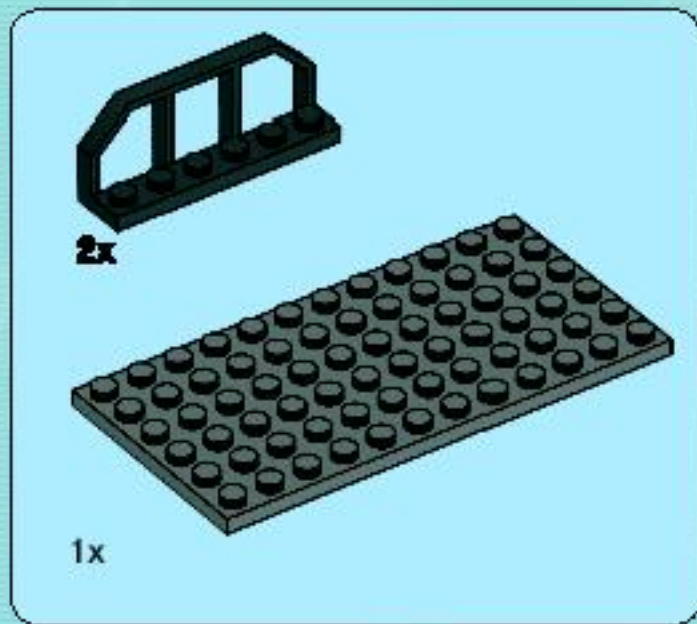

32

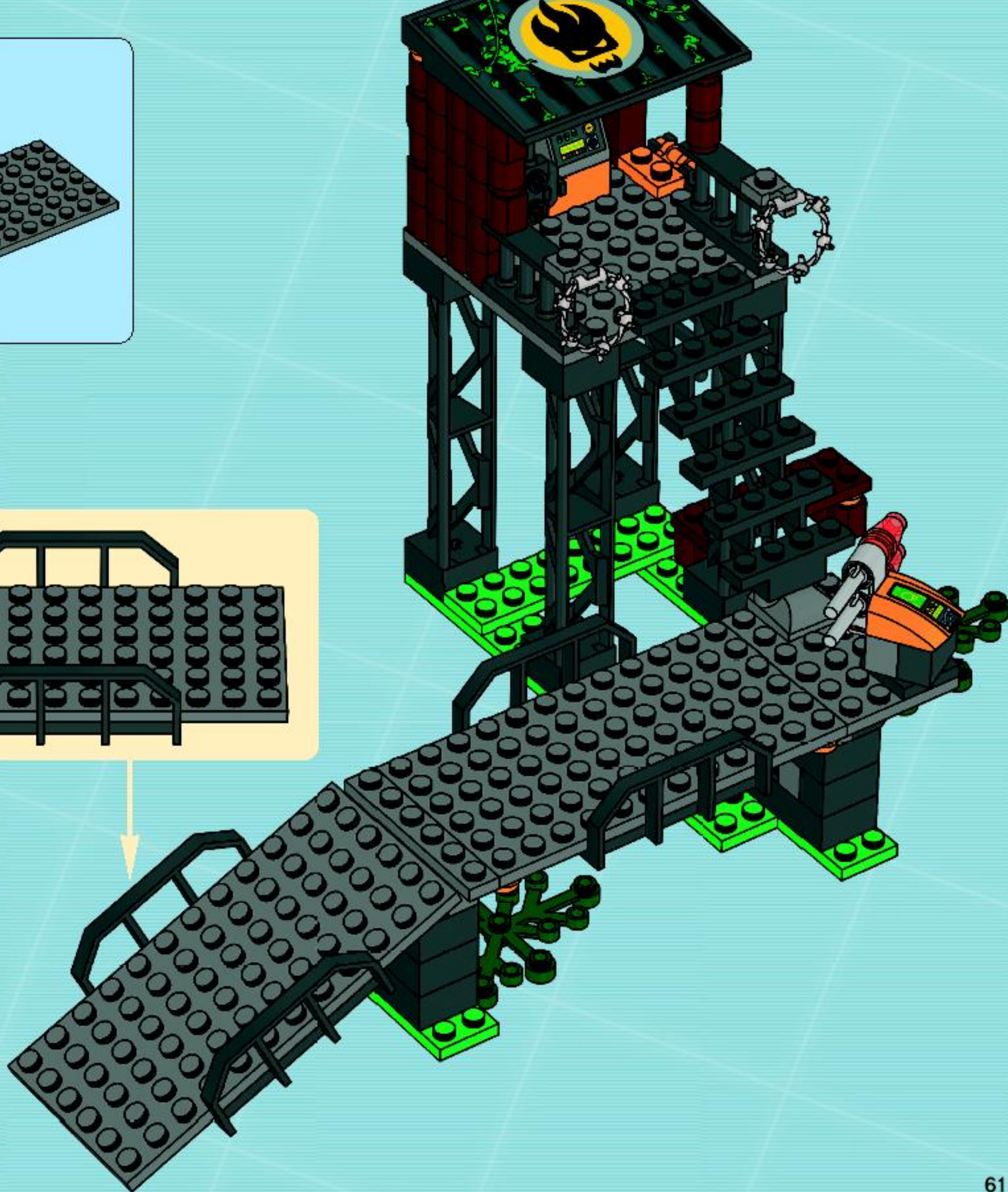
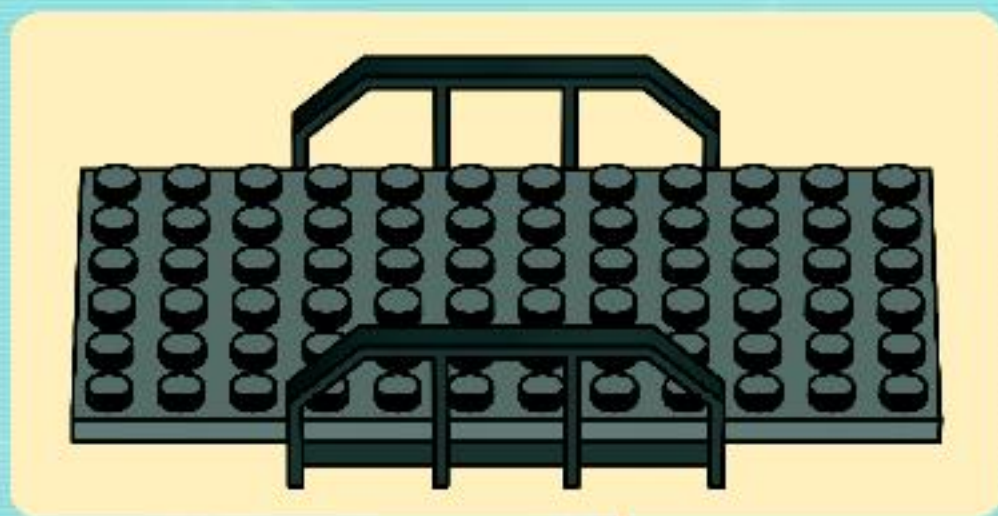

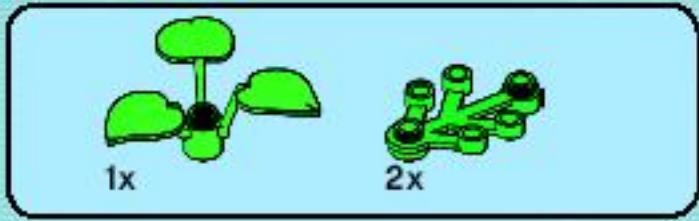

33

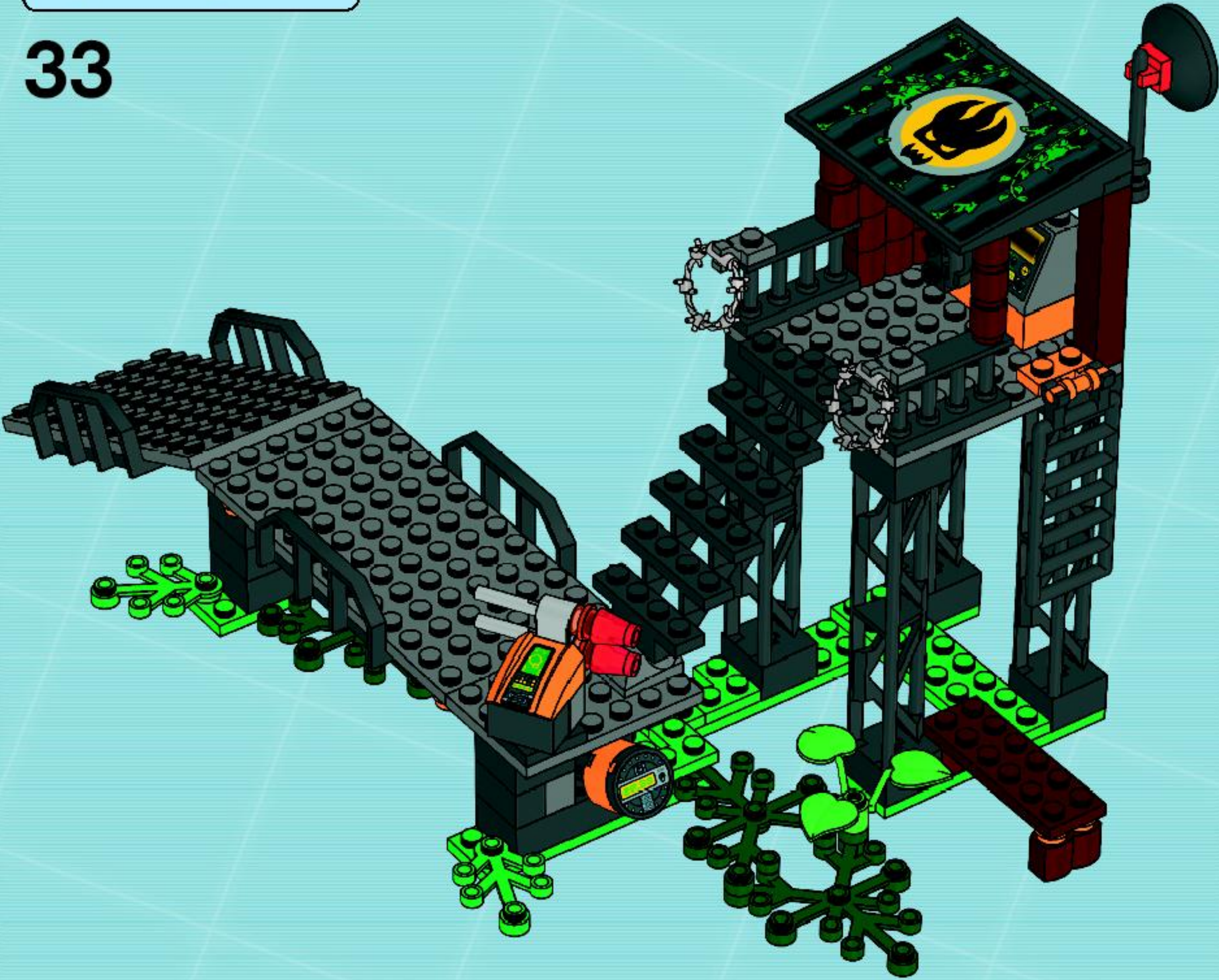

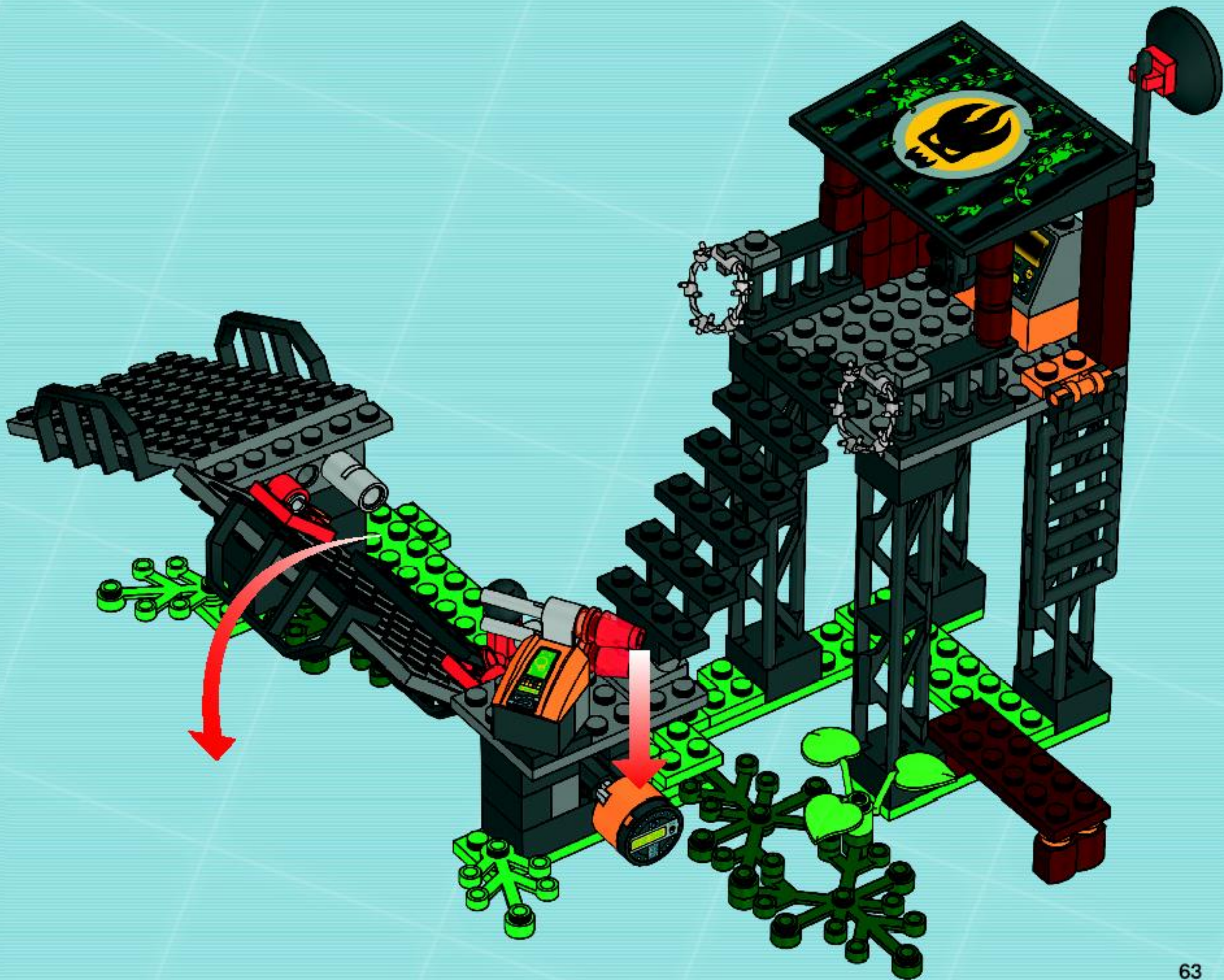

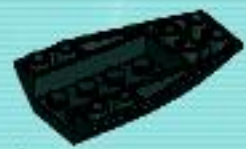

1x  
4180469



6x  
4121715



2x  
4185652



1x  
415026



4x  
658326



1x  
602026



4x  
4509669



2x  
73587



4x  
408526



3x  
302326



2x  
379426



1x  
4124096



1x  
604126

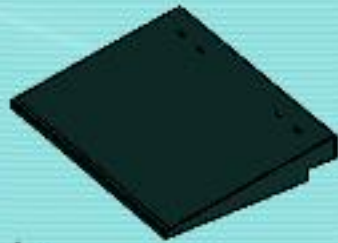

1x  
4161067



1x  
366526



1x  
366026



1x  
4537551



1x  
4180087



1x  
368026



2x  
4500518



1x  
4290713



1x  
396226



1x  
395726



1x  
4107082



4x  
300426



1x  
300326



4x  
300126



1x  
4153827



1x  
4141089



2x  
4169355



1x  
4528214



1x  
4527177



1x  
4190164



6x  
4504371



6x  
4157103

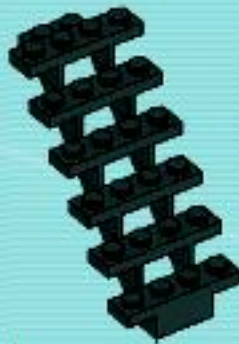

1x  
4279270



2x  
4520320



4x  
4211550



4x  
4211567



1x  
4282740



2x  
4211466



2x  
4211622



2x  
4515369



1x  
4211452



2x  
4299119



6x  
4211807



2x  
4211483



1x  
4226995



4x  
4211815



1x  
4211779



2x  
4526985



1x  
4211439



1x  
4514195



2x  
4211369



2x  
4221775



- 2x 3005749
- 2x 4528675
- 3x 4505066
- 2x 4528674
- 2x 4528676
- 3x 4157120
- 2x 242328
- 2x 4528706
- 4x 303428
- 1x 4107432
- 5x 4211181
- 1x 4211247
- 6x 4211183
- 1x 4226966
- 2x 4211180
- 6x 4142865
- 1x 4227544
- 2x 4529234
- 1x 255521
- 2x 244421
- 2x 4211087
- 1x 4210935
- 2x 4262540
- 2x 4216973
- 1x 4211056
- 1x 4211043
- 2x 4294289
- 4x 4211477
- 2x 4211436
- 1x 4211421
- 2x 4211412
- 1x 4211115
- 2x 4256149
- 1x 4210802
- 1x 4218696
- 1x 4211066
- 1x 4234534
- 2x 4521185
- 2x 4213607
- 2x 3005740
- 2x 4527061
- 1x 4504949
- 2x 4244369
- 2x 4528454
- 1x 4528859
- 2x 4528609
- 1x 4528221
- 1x 4527738
- 2x 612647
- 1x 3006347
- 4x 4177741
- 1x 4528883
- 1x 4528200
- 1x 4528206
- 1x 4528716
- 2x 618841
- 2x 4244363
- 4x 3005747
- 1x 4217722



Customer Service  
Kundenservice  
Service Consommateurs  
Servicio Al Consumidor

[www.lego.com/service](http://www.lego.com/service) or dial

- 
- : 00800 5346 5555
- : 1-800-422-5346

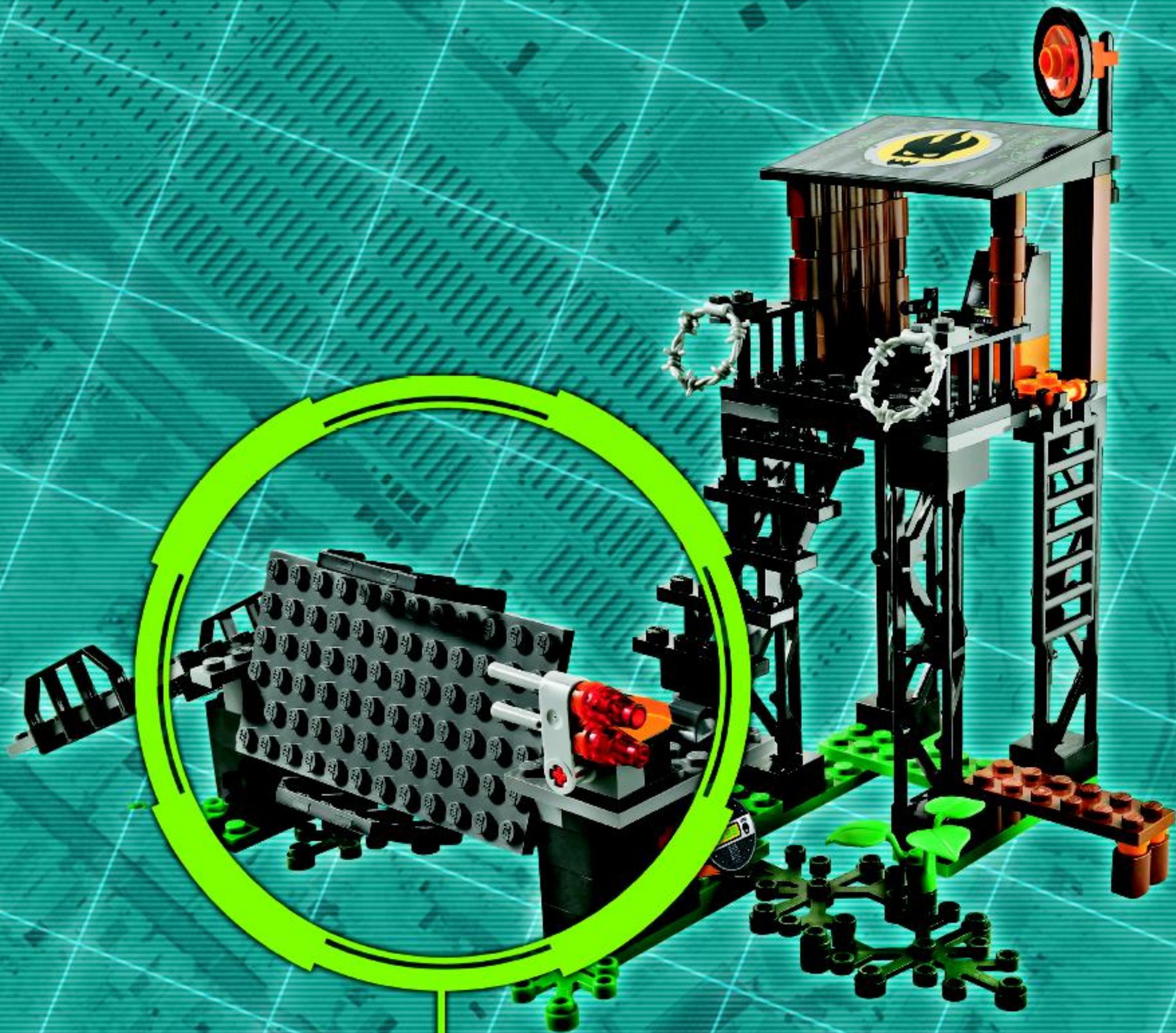



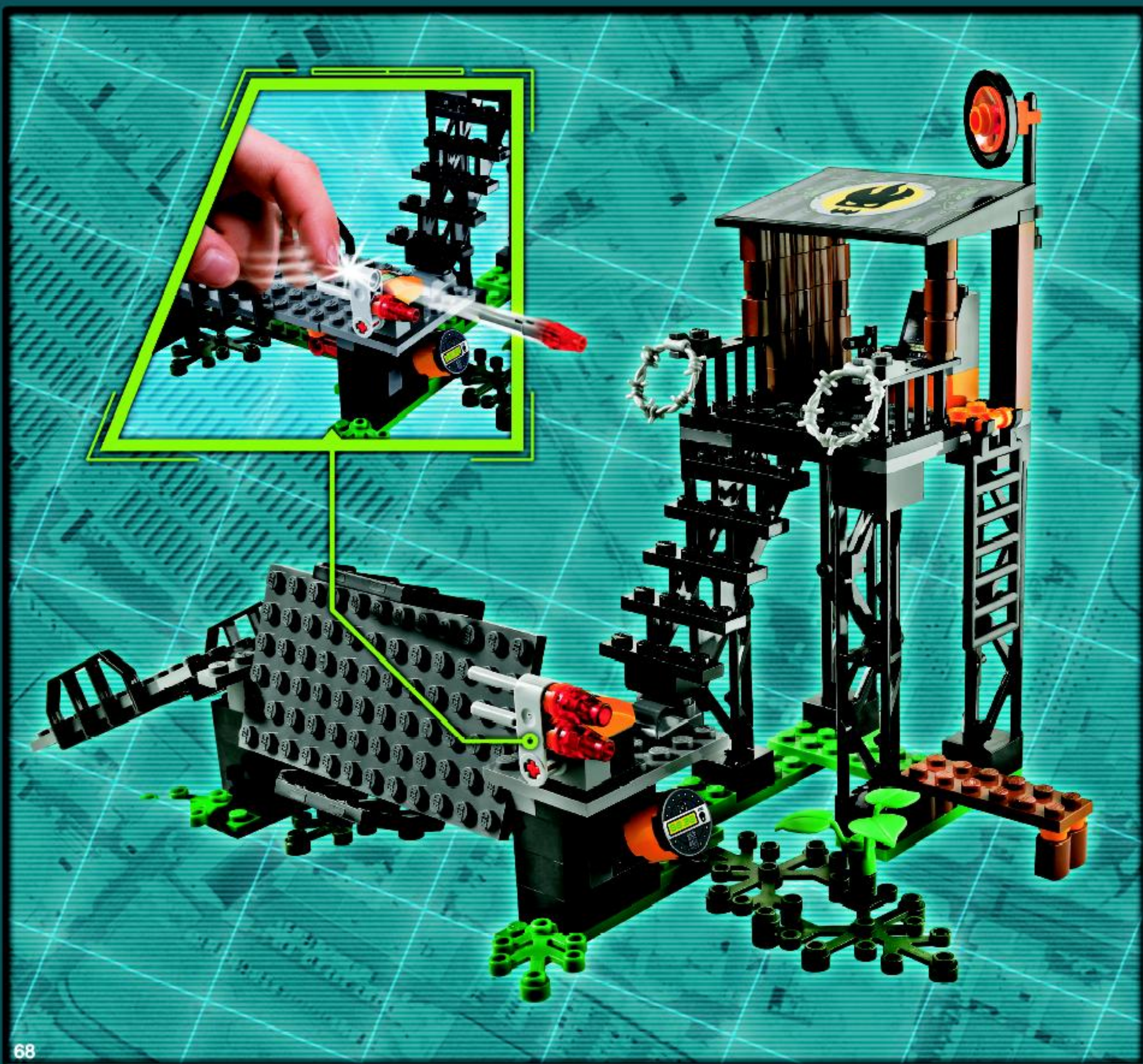



# AGENTS

NAME:

## AGENT CHASE

STATUS:



8634 ★



8635 ★



8632 ★



8631 ★



8630 ★



8633 ★







batteries included



**CHOOSE YOUR MISSION**







# AGENTS

A group of three Agents minifigures is shown to the right of the title. They are wearing blue and black tactical suits. One is holding a large silver rifle, another a handgun, and the third is wearing a helmet and holding a submachine gun.



# club™



FREE LEGO Magazine • GRATUIT • GRATIS LEGO Magazin

**Join Today!**

**Abonne-toi  
dès aujourd'hui!**

**Meld je nu aan!**

**Jetzt anmelden!**



US & Canada only

1-866-534-6258 / 1-877-518-5346

(ex. Friends)



00800 5346 5555

[www.LEGOclub.com](http://www.LEGOclub.com)

**VISIT THE WORLD'S  
BIGGEST LEGO® SHOP!**

[www.LEGOshop.com](http://www.LEGOshop.com)



**YES! I want to join the LEGO® Club FREE!**

**OUI ! Je veux m'abonner au Club LEGO® GRATUITEMENT !**

**Ja! Ich möchte Mitglied im kostenlosen LEGO Club werden.**

**Ja! Ik wil graag GRATIS lid worden van de LEGO Club.**

First Name  
Prénom  
Vorname  
Voornaam

Last name  
Nom de Famille  
Familiename  
Achternaam

Date of Birth  
Date de naissance  
Geburtsdag  
Geboortedatum

Boy  
Garçon  
Junge  
Jongen

Girl  
Fille  
Mädchen  
Meisje

Street No.  
Rue  
Straße, Hausnr.  
Straat, huisnr.

City/County  
Ville  
Stadt  
Woonplaats

State  
Prov.

Zip/Postcode  
Code Postal  
PLZ  
Postcode

Country  
Pays  
Land

Email \_\_\_\_\_

Parent's signature  
Signature d'un parent  
Unterschrift Erziehungsberechtigte/r  
Handtekening ouders \_\_\_\_\_



Mail to: / Poster à:  
**LEGO Club**  
**P.O. Box 1157**  
**Enfield, CT USA**  
**06083-1157**



Mail to:  
**LEGO Club**  
**33 Bath Road**  
**Slough SL1 3UF**  
**United Kingdom**



Per Post an:  
**LEGO® Club**  
**Postfach 14 15**  
**D-36243**  
**Niederaula**

The English version of the magazine can only be mailed to addresses in the US, Canada, the UK, and Republic of Ireland. Club membership is valid for 2 years and includes free copies of the LEGO Magazine. In the US and Canada please allow up to 6 weeks for delivery of your first magazine. By signing this form you consent the LEGO Club to use your child's data for LEGO mailings. The data will only be used for LEGO mailings and will not be sold, rented or otherwise disclosed to any company outside the LEGO Company except for disclosure to companies acting as our agents to help us provide services requested by the child. This coupon good for one free membership per person, group or organization. If you would not like to receive other communication from the LEGO company please tick here:  La version Française du magazine peut être postée uniquement au Canada. L'abonnement est valide pour 2 ans et inclut des exemplaires gratuits du Magazine LEGO. Aux É.-U. et au Canada, allowez 6 semaines pour la livraison initiale. En remplissant ce formulaire, vous consentez à ce que LEGO utilise les informations de votre enfant pour des envois postaux de LEGO. L'information sera utilisée uniquement pour des envois postaux par LEGO et ne sera en aucun cas, vendue, louée, échangée ou divulguée à d'autres compagnies autres que la compagnie LEGO, à l'exception des compagnies affiliées qui nous procurent des services auxquels l'enfant en a fait la demande. Das deutschsprachige Angebot gilt nur für die Länder D, A und CH. Die kostenlose Mitgliedschaft beinhaltet die Zusendung des LEGO Magazins und endet nach zwei Jahren. Für die Mitglieder entstehen keine Verpflichtungen. Es kann bis zu drei Monate dauern, bis das erste Magazin zugestellt wird. Mit Ihrer Unterschrift erklären Sie sich einverstanden, dass die Daten Ihres Kindes zum Zweck einer LEGO Club-Mitgliedschaft von der LEGO Gruppe gespeichert werden. Die Daten werden vertraulich behandelt und nicht an Dritte weitergegeben, außer an Dienstleister des LEGO Clubs. Wenn Sie außer vom LEGO Club keine weiteren Informationen von der LEGO Company bekommen möchten bitte hier ankreuzen:  Door dit formulier te tekenen geeft u de LEGO Club toestemming om bovenstaande gegevens te gebruiken voor het toesturen van LEGO mailings. Uw gegevens worden uitsluitend gebruikt voor mailings van LEGO en zullen niet worden verkocht, verhuurd of op welke wijze dan ook verstrekt aan derden buiten de LEGO Groep, uitgezonderd de organisaties die namens ons optreden om de service te verlenen waar uw kind om gevraagd heeft.

[www.acnielsen.aim.dk/LEGO](http://www.acnielsen.aim.dk/LEGO)



## WIN LEGO® PRODUCTS

No purchase necessary.

Open to residents of all countries where not prohibited.

Go to [www.aim.dk](http://www.aim.dk) for official rules and details.

## WIN LEGO® PRODUCTEN

Kopen niet nodig.

Open voor alle leeftijden, en in alle landen waar geen verbod geldt.

Ga naar [www.aim.dk](http://www.aim.dk) voor officiële regels en details.

## GEWINNE LEGO® PRODUKTE

Die Teilnahme am Gewinnspiel führt zu keinerlei Kaufverpflichtungen.

Sie können in allen nicht ausgeschlossenen Ländern teilnehmen.

Die offiziellen Regeln und nähere Informationen finden Sie unter [www.aim.dk](http://www.aim.dk).

## GAGNE DES PRODUITS LEGO®

Aucun achat n'est nécessaire.

Ouvert à tous les âges et aux résidents de tous les pays, sauf en cas d'interdiction.

Rendez-vous sur [www.aim.dk](http://www.aim.dk) pour obtenir plus de détails et le règlement officiel.

## レゴ®製品を「当てよう」

購入は不要です

禁止されていない限り、あらゆる年代およびあらゆる国の居住者の方々にご利用いただけます。

公認規則および詳細につきましては、[www.aim.dk](http://www.aim.dk)をご覧ください

