



# MONKIE KID 悟空小侠

80044



1



FR

**DONNEZ  
OU  
RECYCLEZ**



ASSOCIATION

OU



MAGASIN

OU



DÉCHÈTERIE

Adresses sur [quefairedemesdechets.fr](http://quefairedemesdechets.fr)



[LEGO.com/sustainable-packaging](http://LEGO.com/sustainable-packaging)

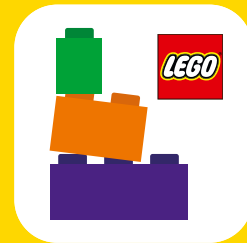

# BUILDER



Apple and the Apple logo are trademarks of Apple Inc., registered in the U.S. and other countries and regions. App Store is a service mark of Apple Inc. Google Play and the Google Play logo are trademarks of Google LLC. Tencent and the Tencent logo are trademarks of Tencent Inc.

Q [LEGO.com/devicecheck](https://www.lego.com/devicecheck)

**EN** Ask parents' permission before going online | **DE** Eltern um Erlaubnis bitten, bevor du online gehst | **FR** Demande l'autorisation d'un parent avant d'aller en ligne | **IT** Chiedi il permesso ai tuoi genitori prima di andare online | **ES** Pídeles permiso a tus papás antes de conectarte a Internet | **PT** Peça autorização aos pais antes de acederes online | **JA** オンラインになる前に ほか者の方のきょかをもらおう | **ZH** 上网前应先征得父母的同意 | **KO** 온라인 접속 전에 보호자 동의가 필요합니다 | **RU** Спроси разрешения у родителей, прежде чем заходить в интернет | **PL** Poproś rodziców o zgodę, zanim wejdiesz do Internetu | **CS** Než půjdeš na internet, požádej rodiče o svolení | **SK** Skôr než pôjdeš na internet, vypýtaj si povolenie od rodičov | **HU** Kérj szülői engedélyt, mielőtt online csatlakoznál! | **RO** Cere permisiunea părinților înainte de a te conecta online | **BG** Поискайте разрешение от родител, преди да влезете онлайн | **LV** Pirms došanās tiešsaistē palūdz atļauju vecākiem | **ET** Enne Interneti kasutamist küsi vanematelt luba | **LT** Prieš prisijungdami prie interneto, atsilkauskite tėvų





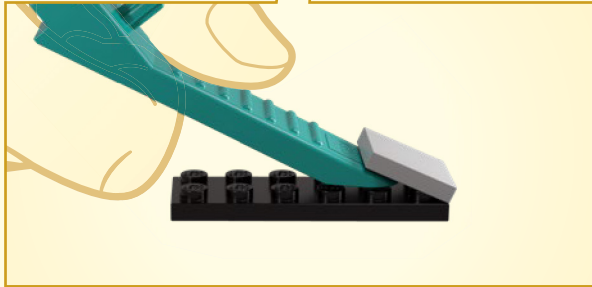
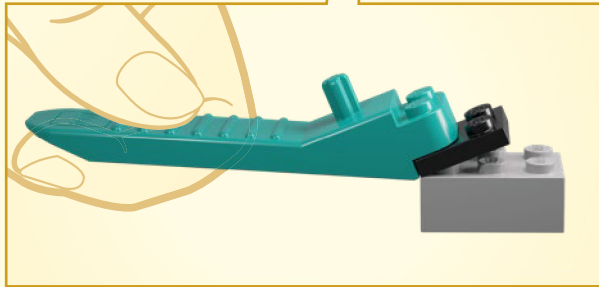
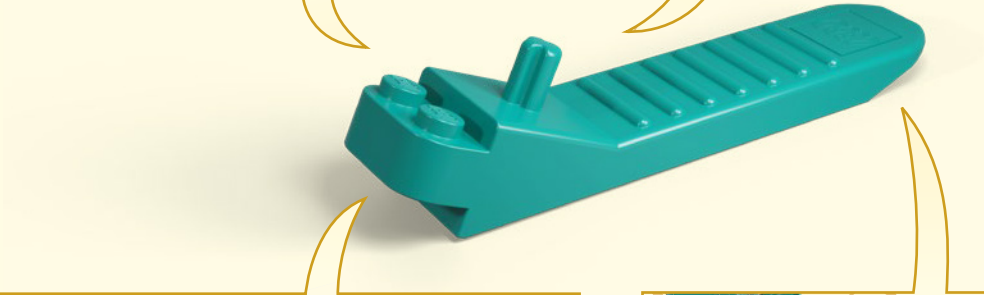
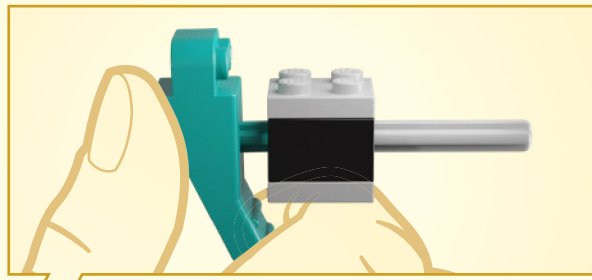
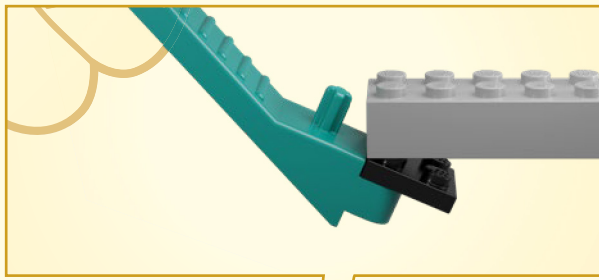



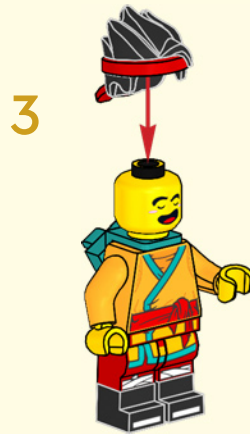
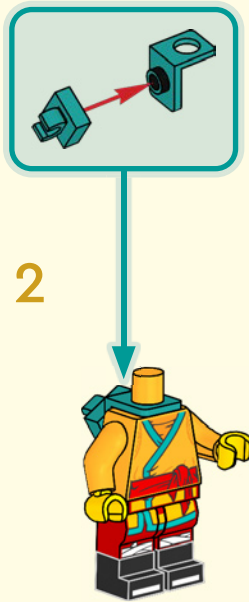
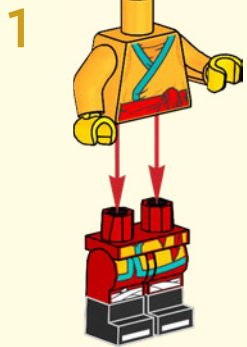
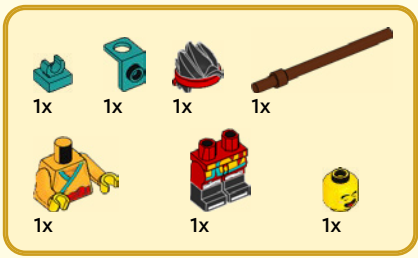



# MONKIE KID





1

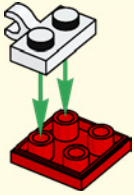

2

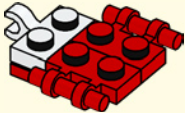

3

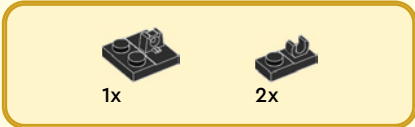
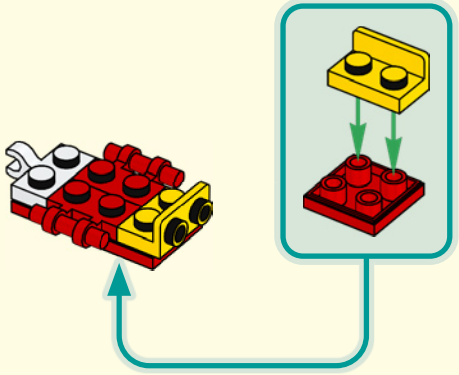

4

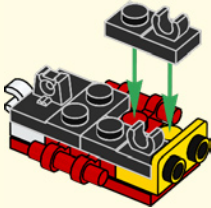



5

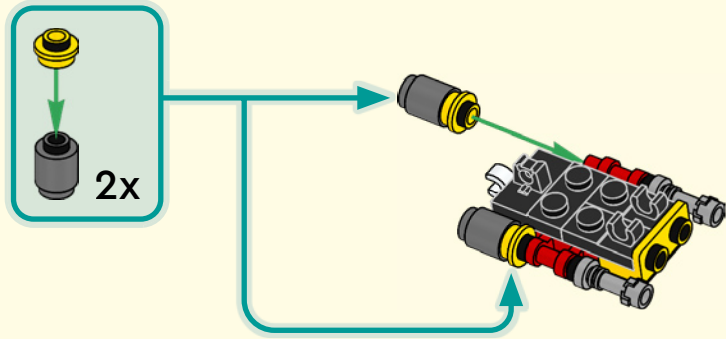

6

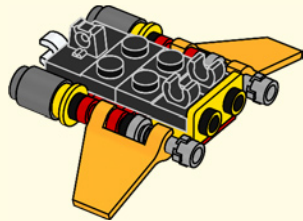

7

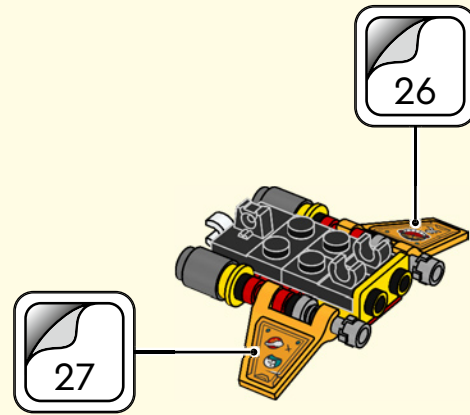

8

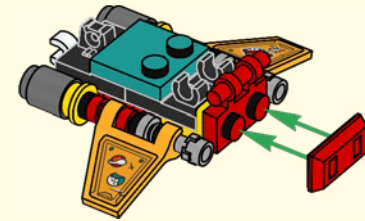

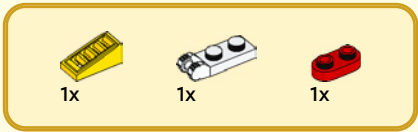

9

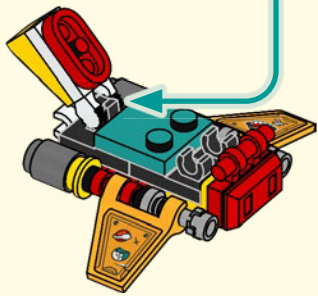
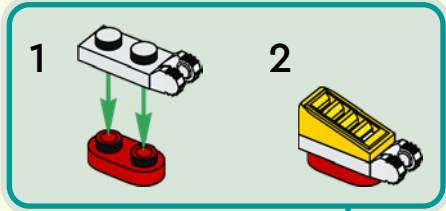

10

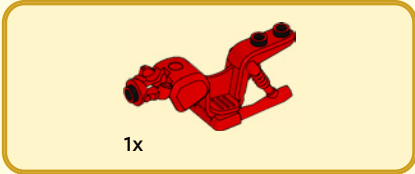
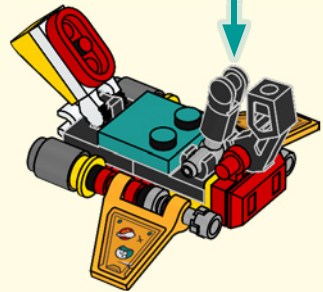
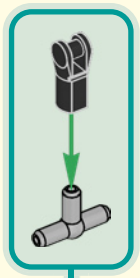

11

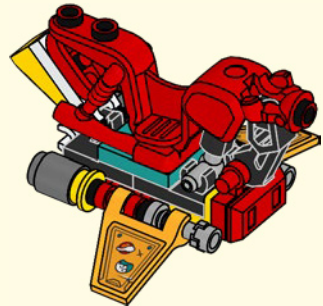



12

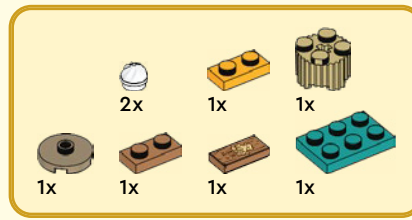
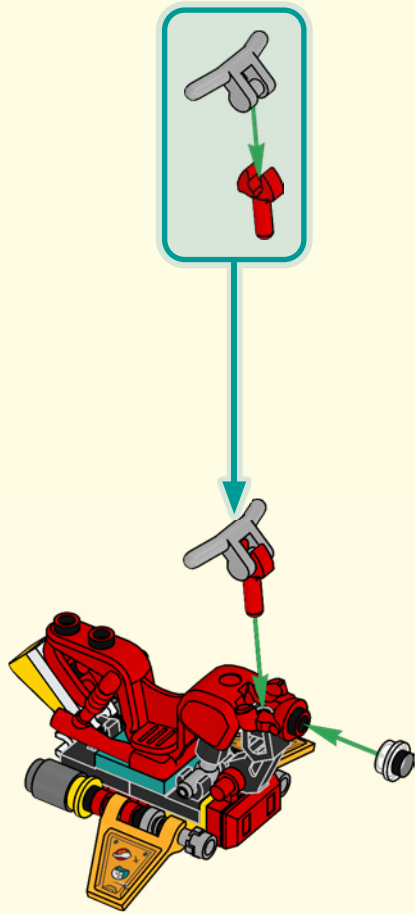

13

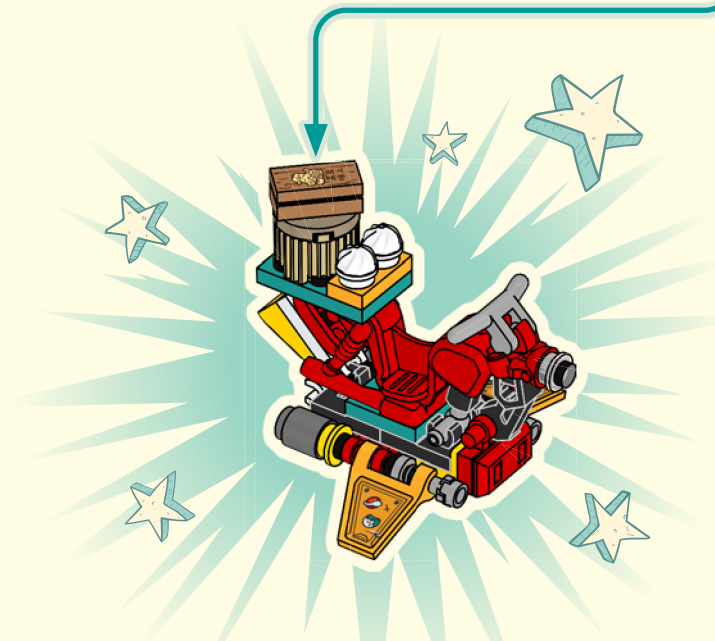
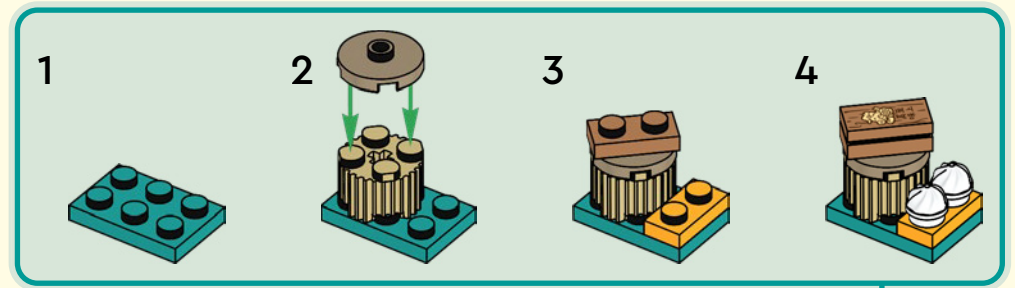

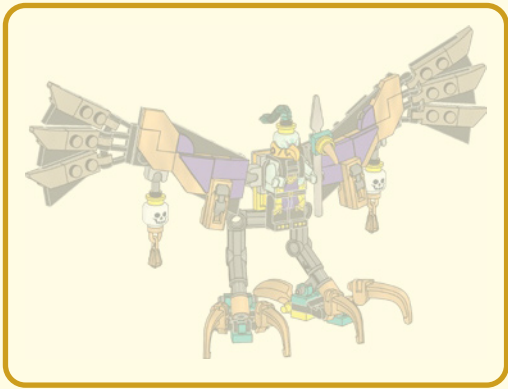

1

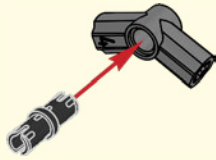

2

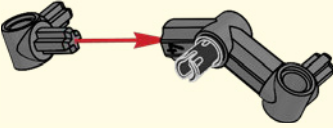

3

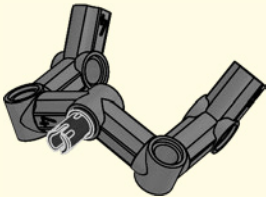



4

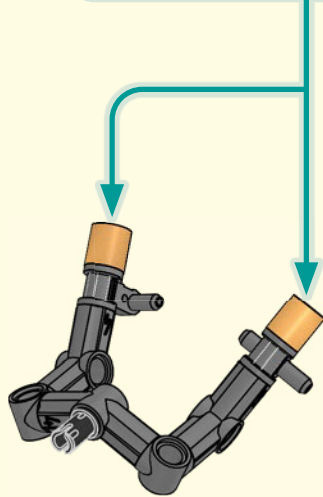
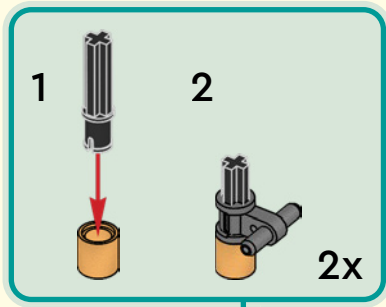

5

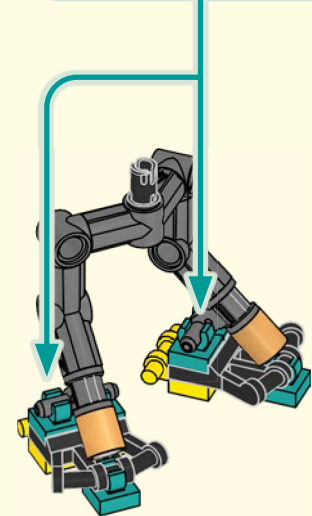
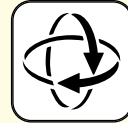
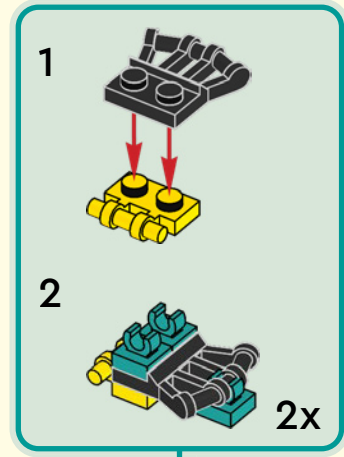

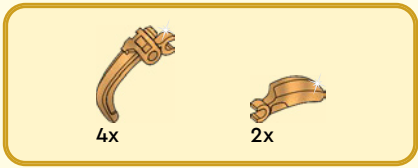

6

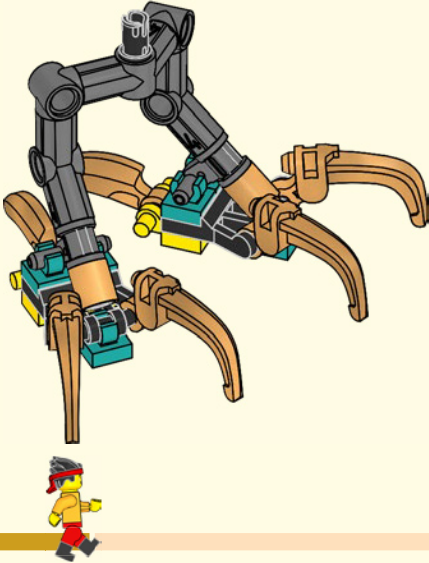

7

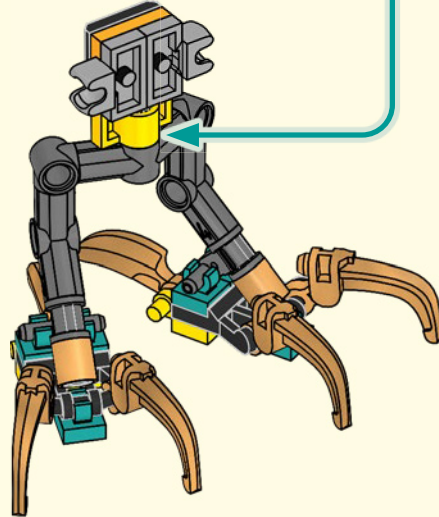
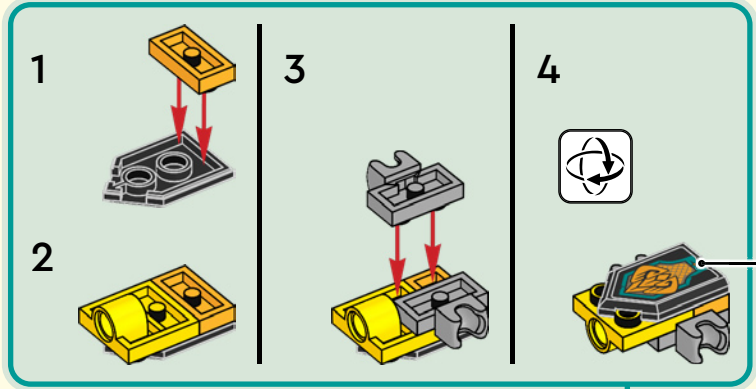



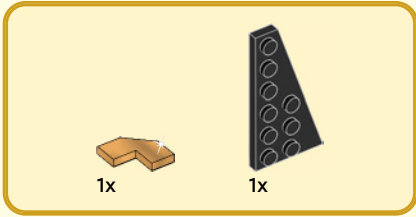

8

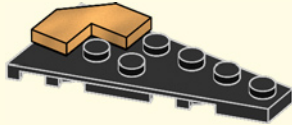

9

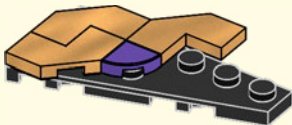

10

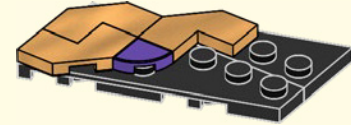

11

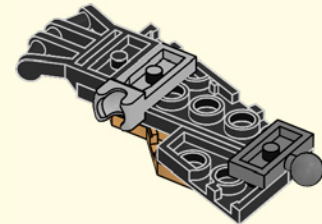
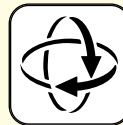



12

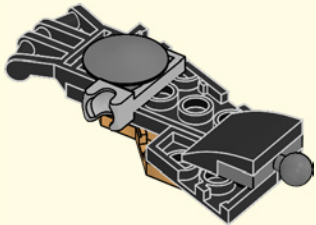

13

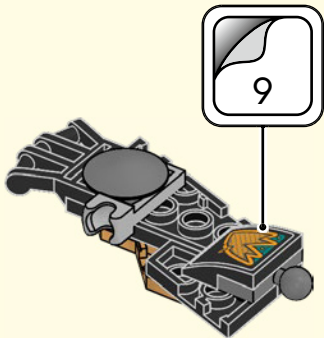

14

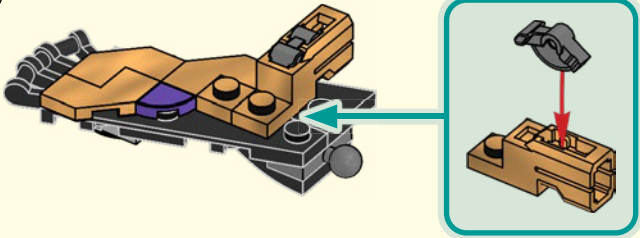

15

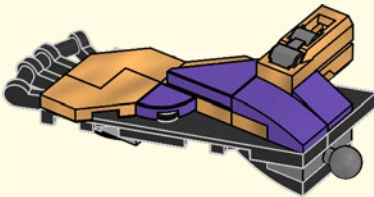
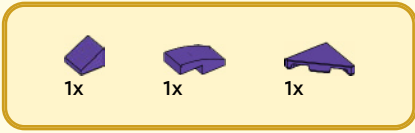

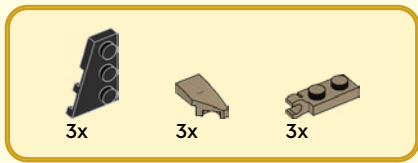

16

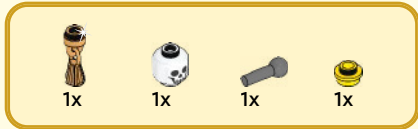
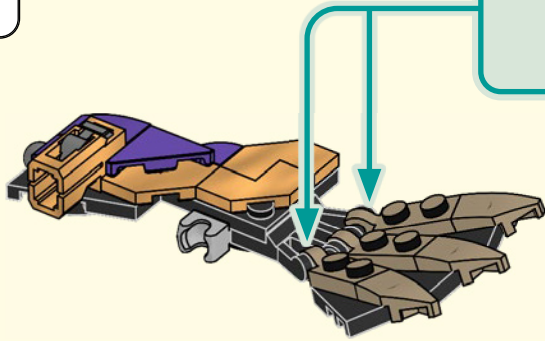
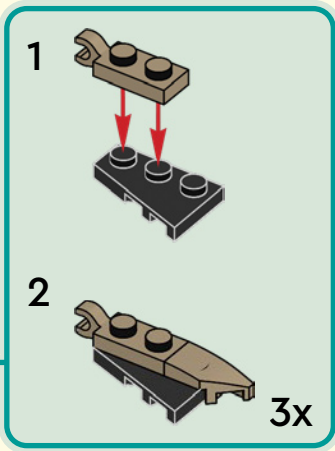

17

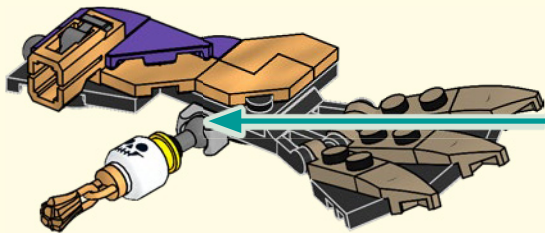
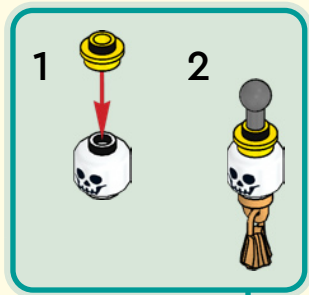

18

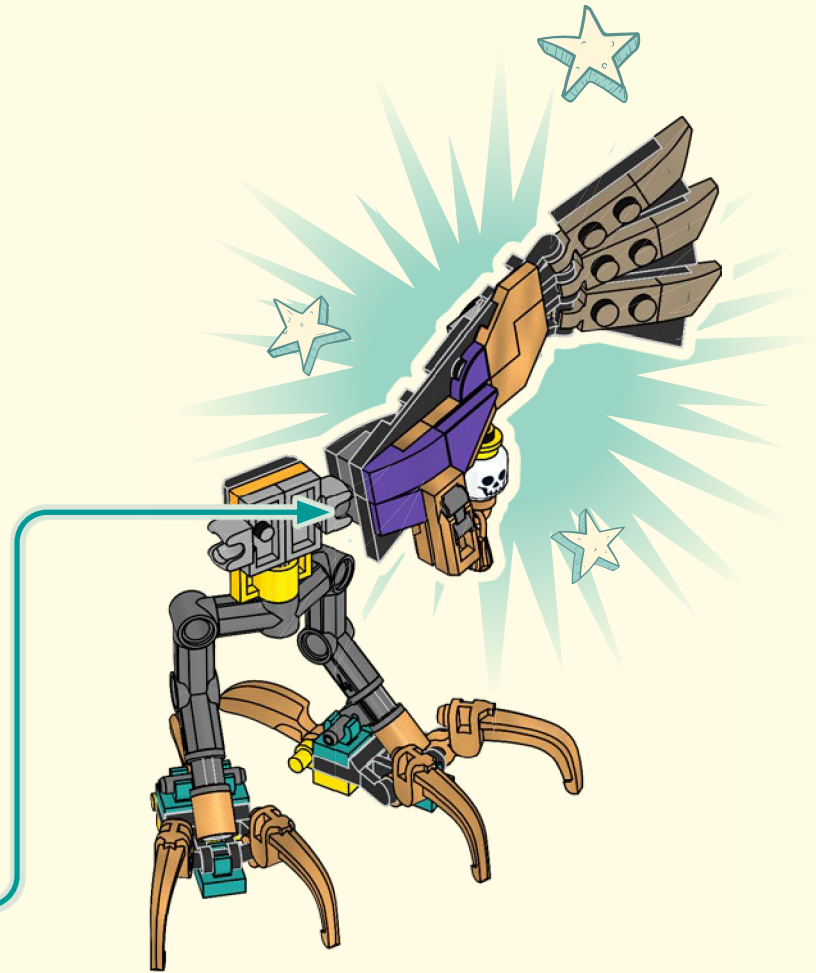

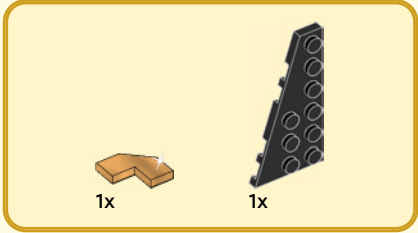

19

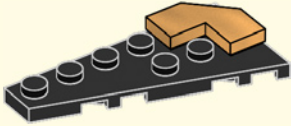

20

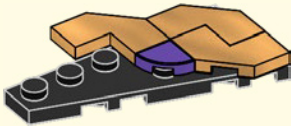

21

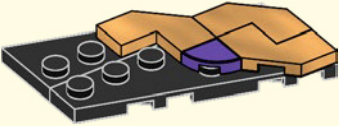

22

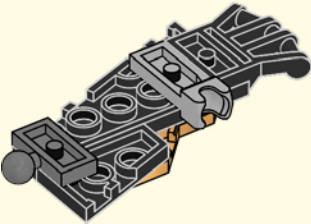



23

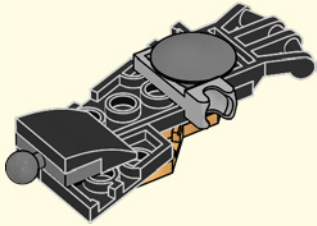

24

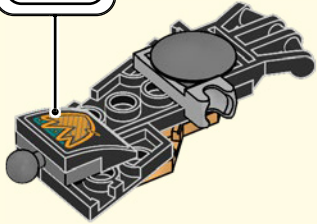

25

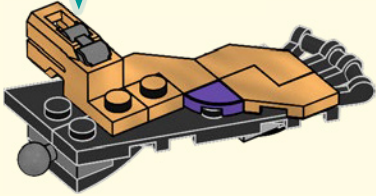
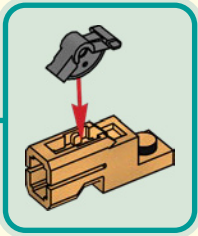

26

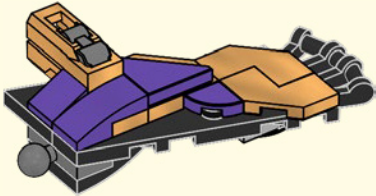

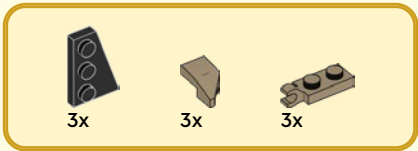

27

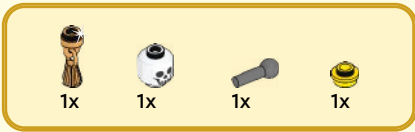
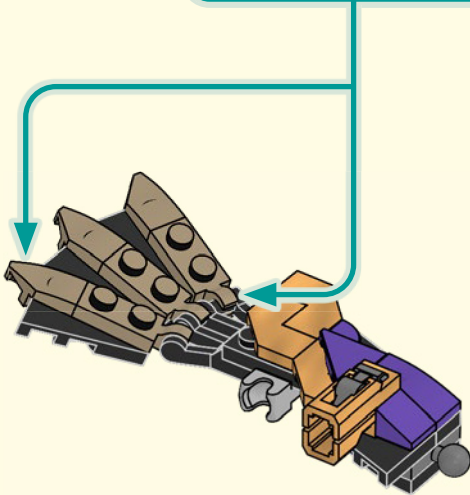
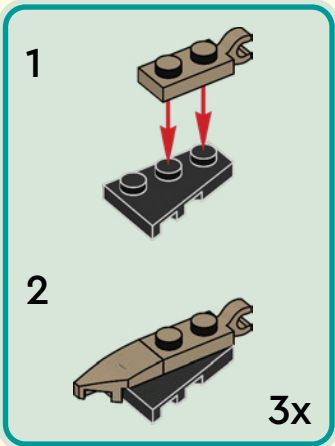

28

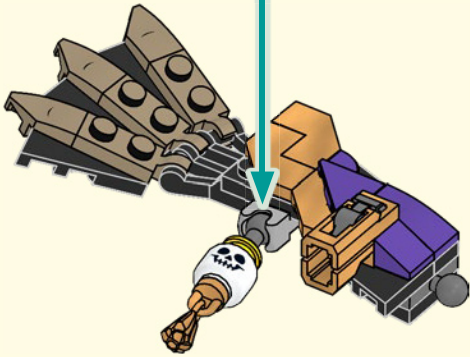
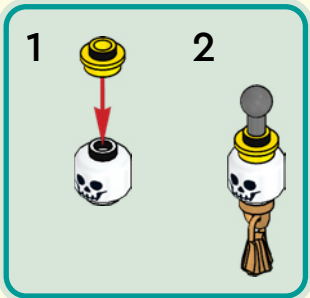

29

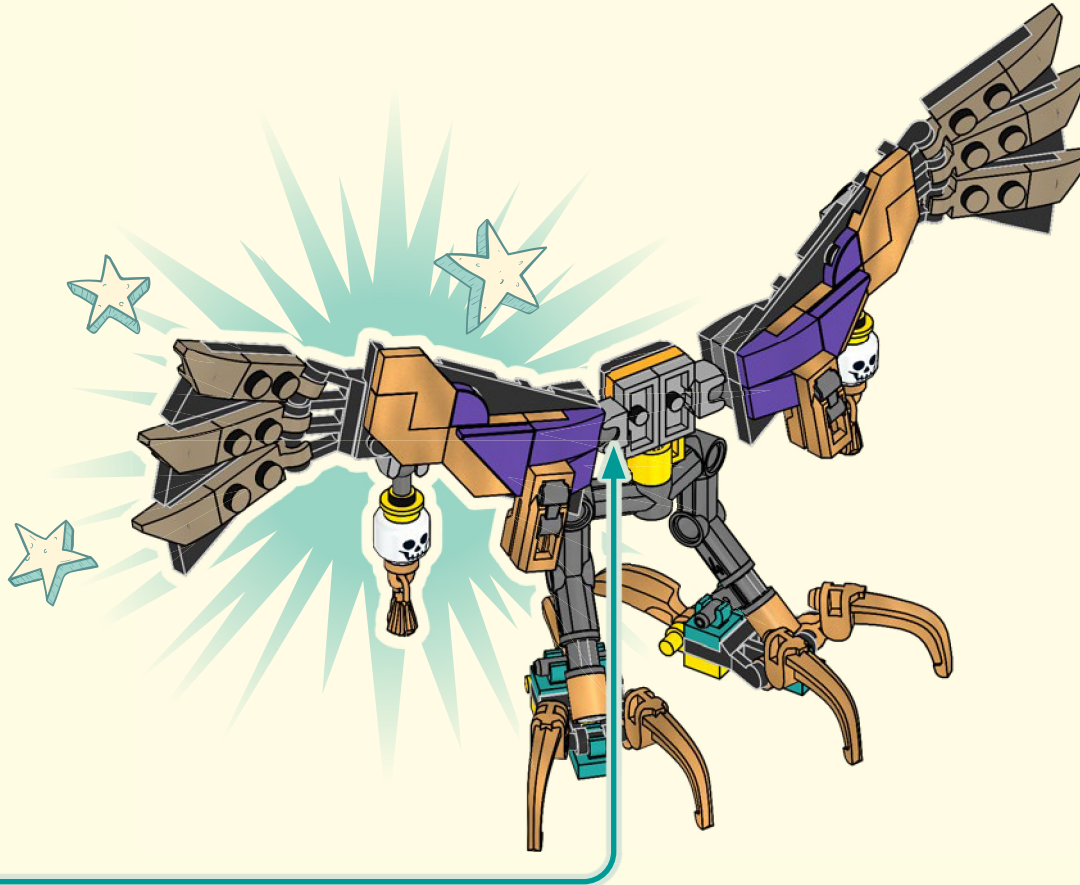



30

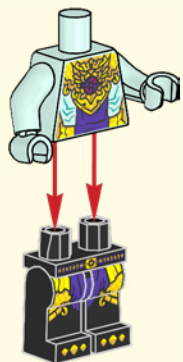

31

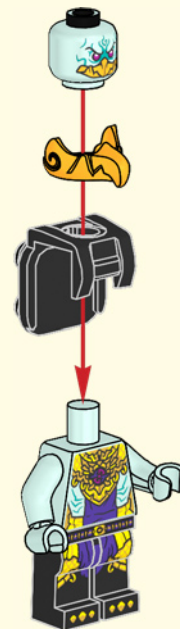



1x



1x

32



1x



1x



1x



1x

33

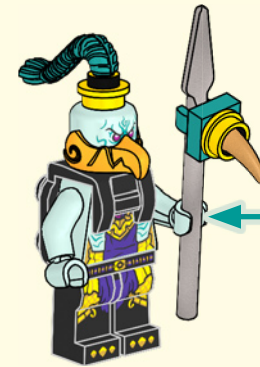
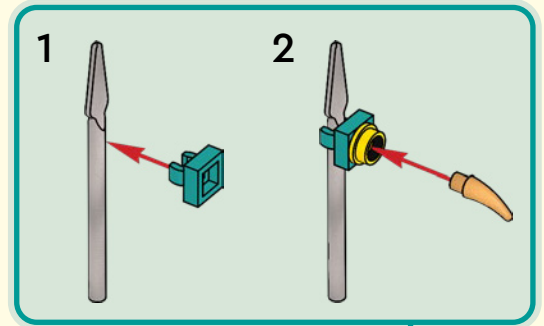

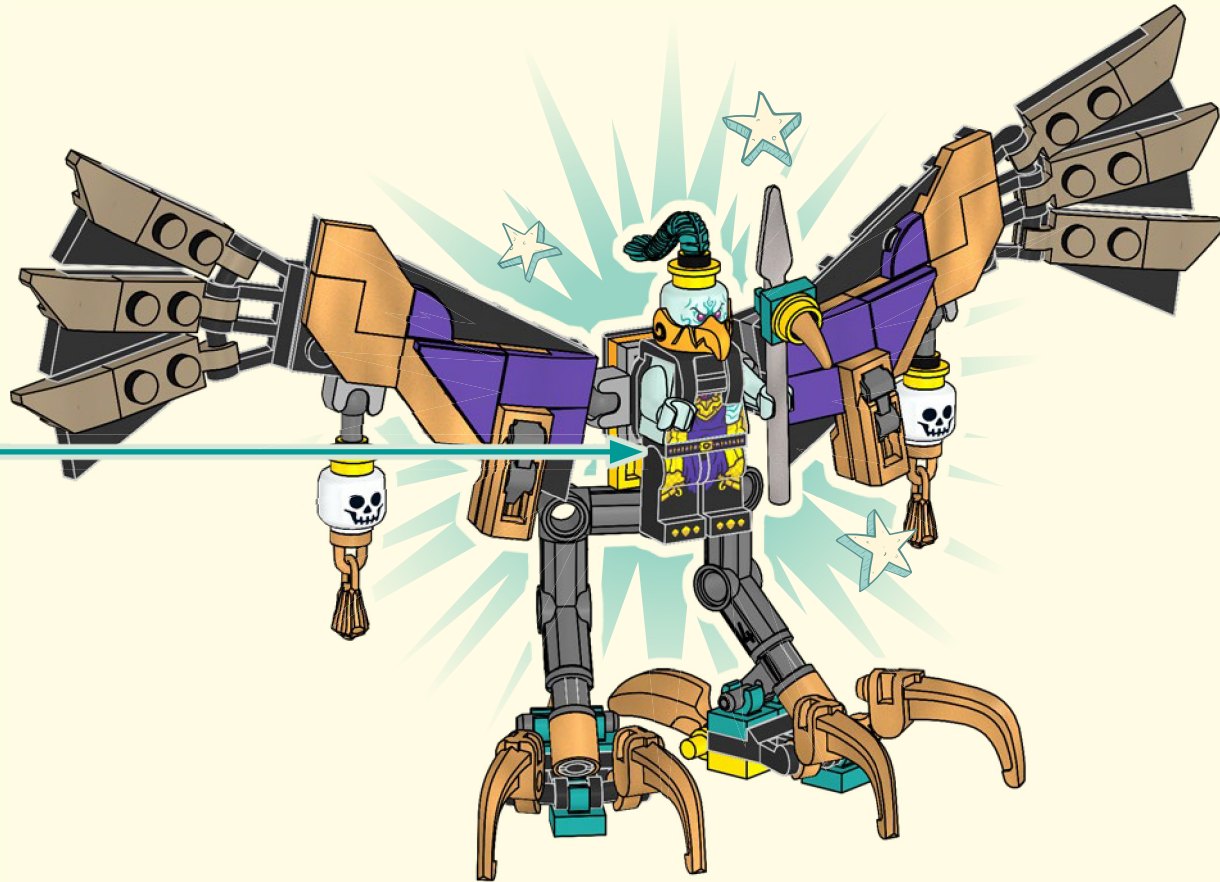

4x



35

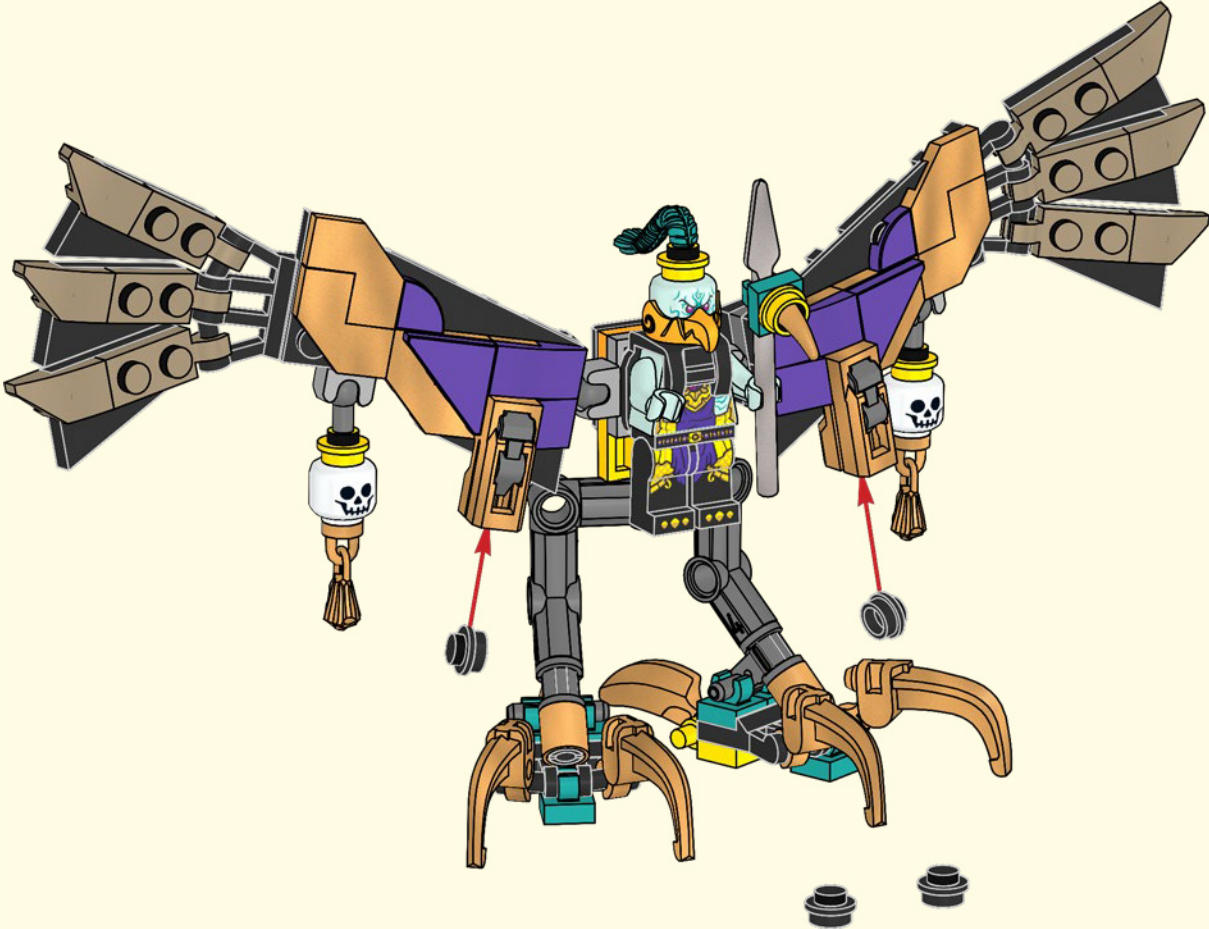



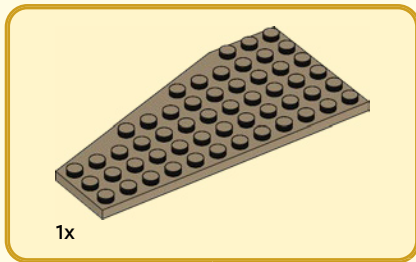

1

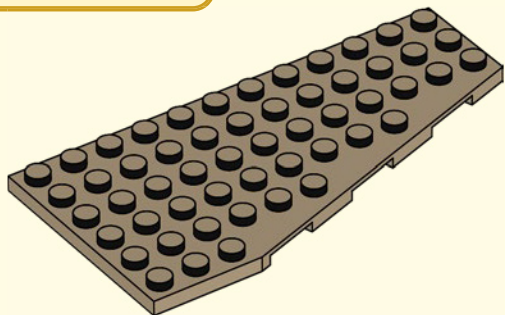

2

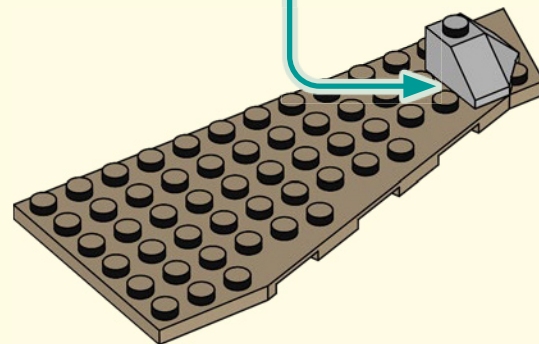
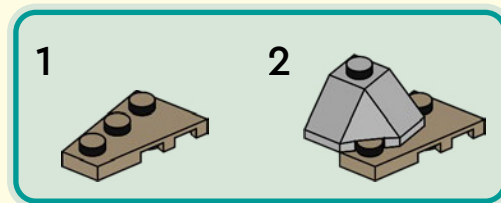

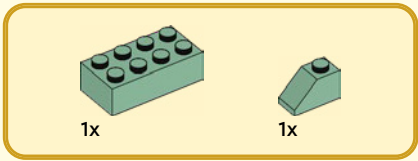

3

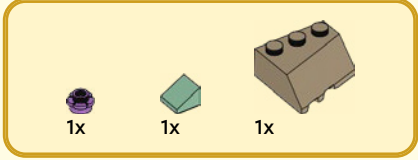
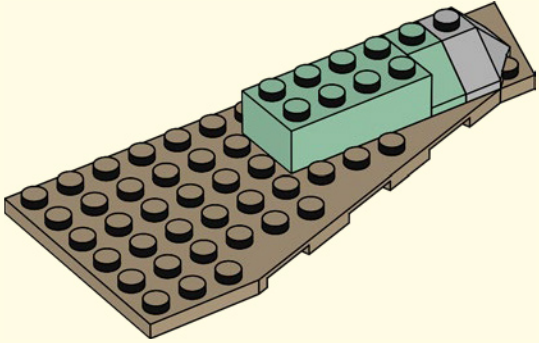

4

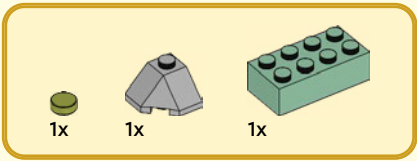
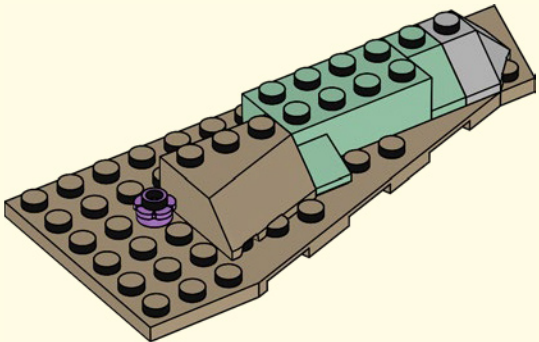

5

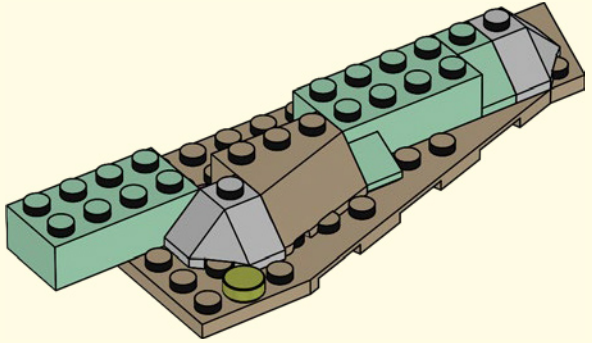

6

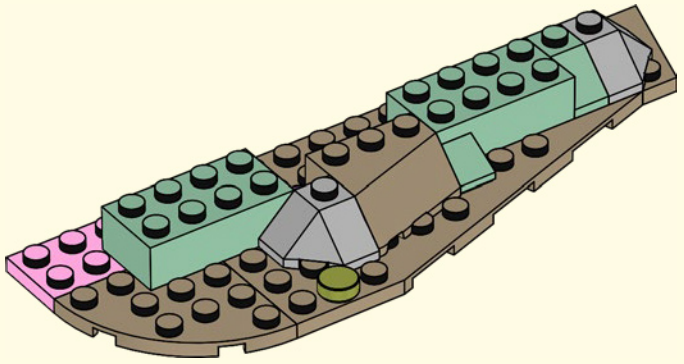

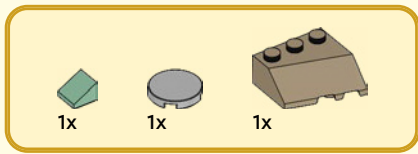

7

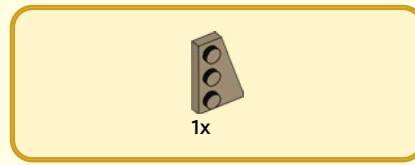
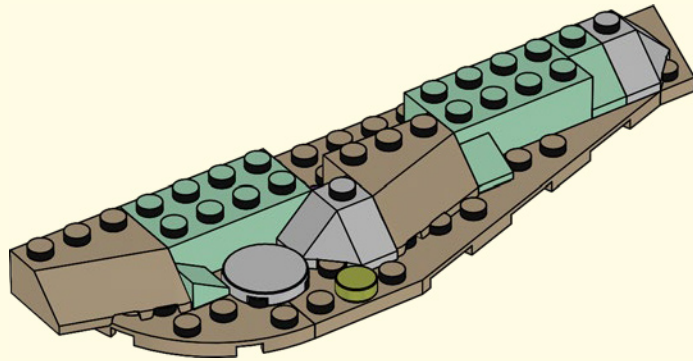

8

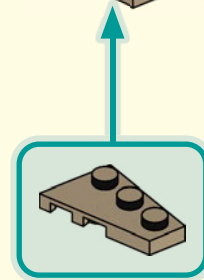
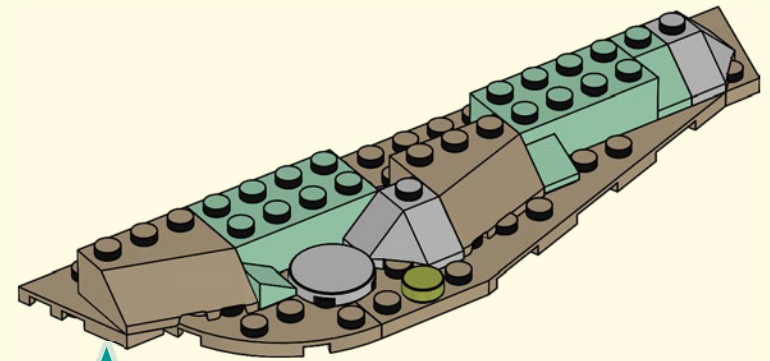

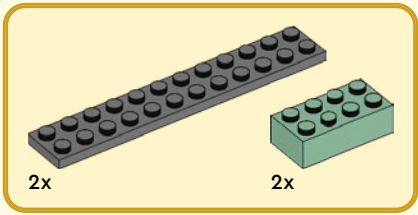

9

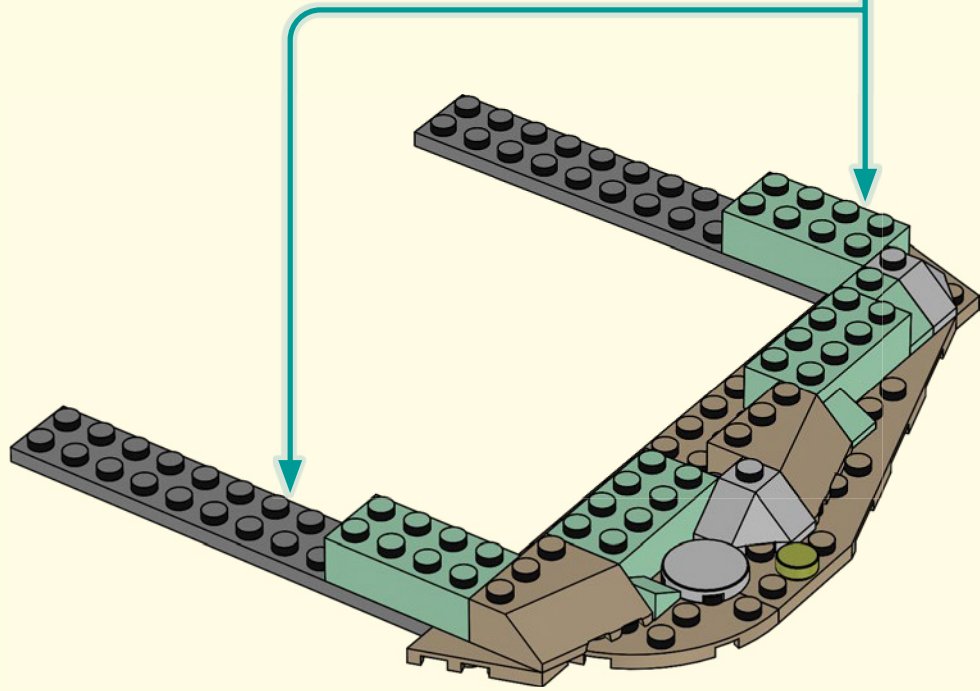
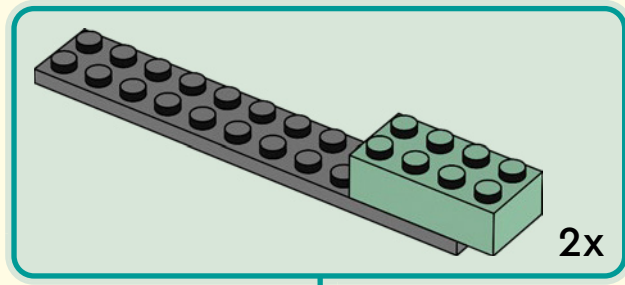



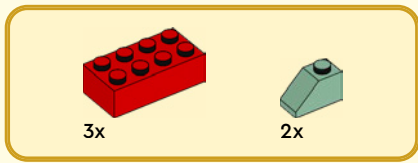

10

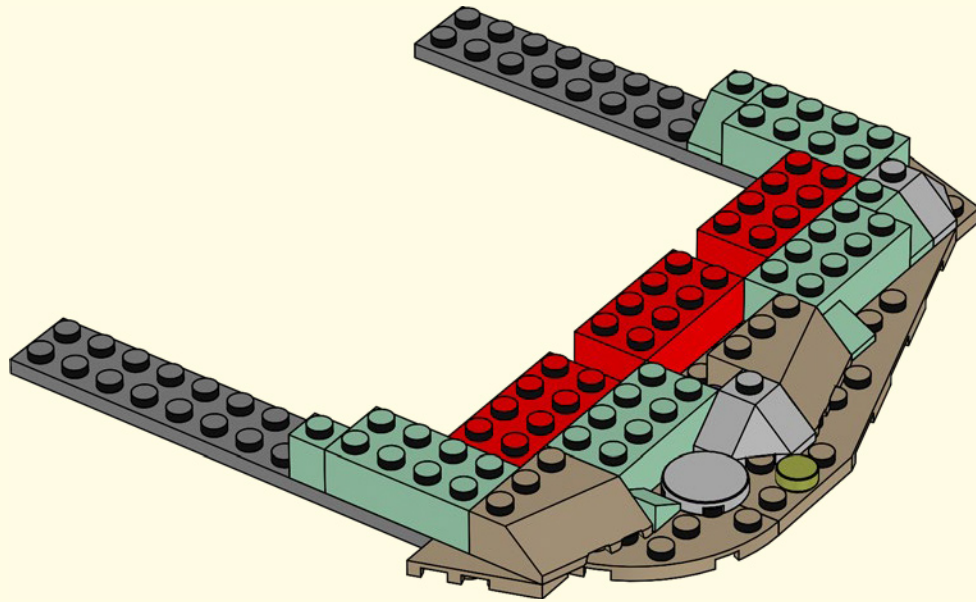

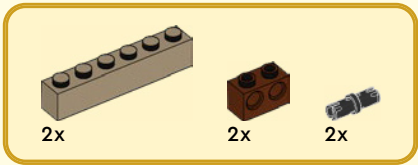

11

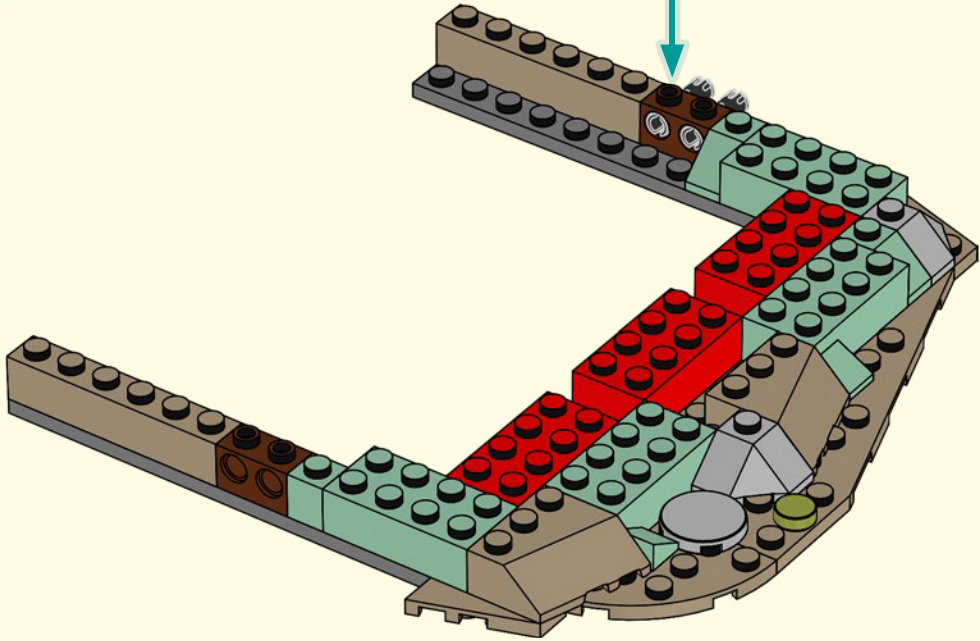
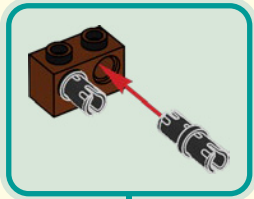

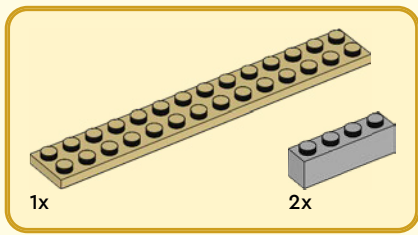

12

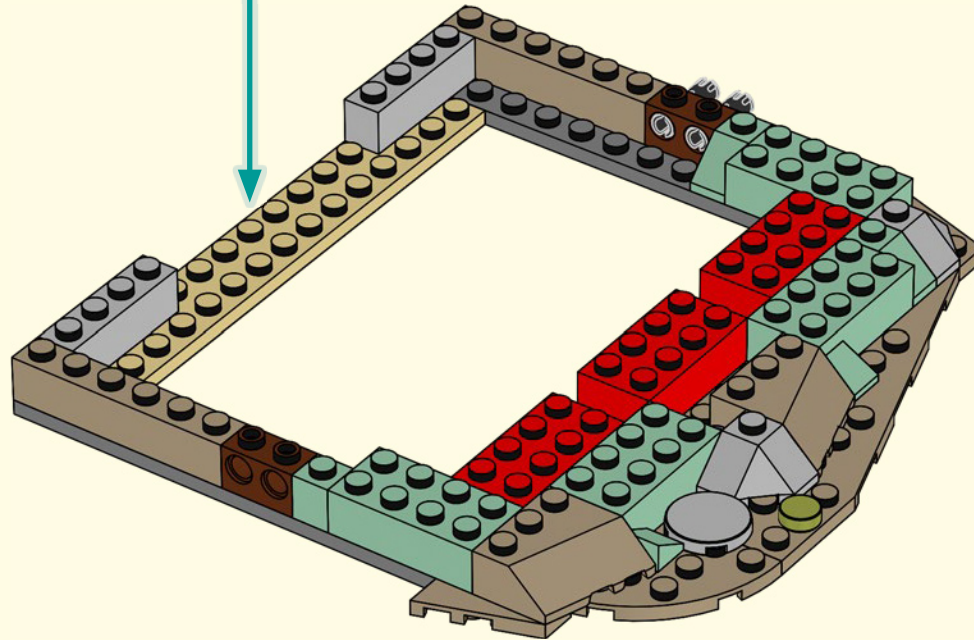
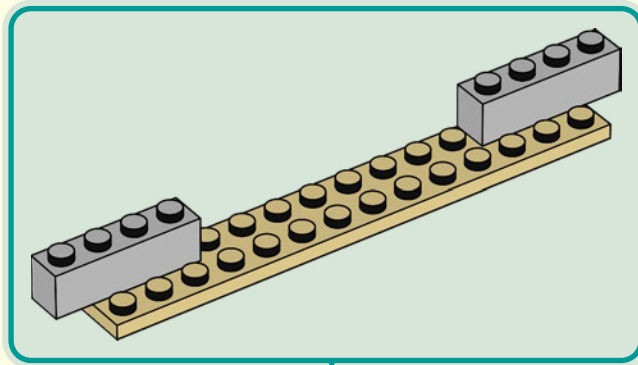

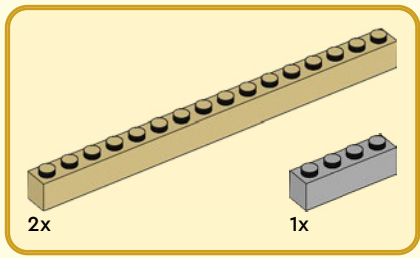

13

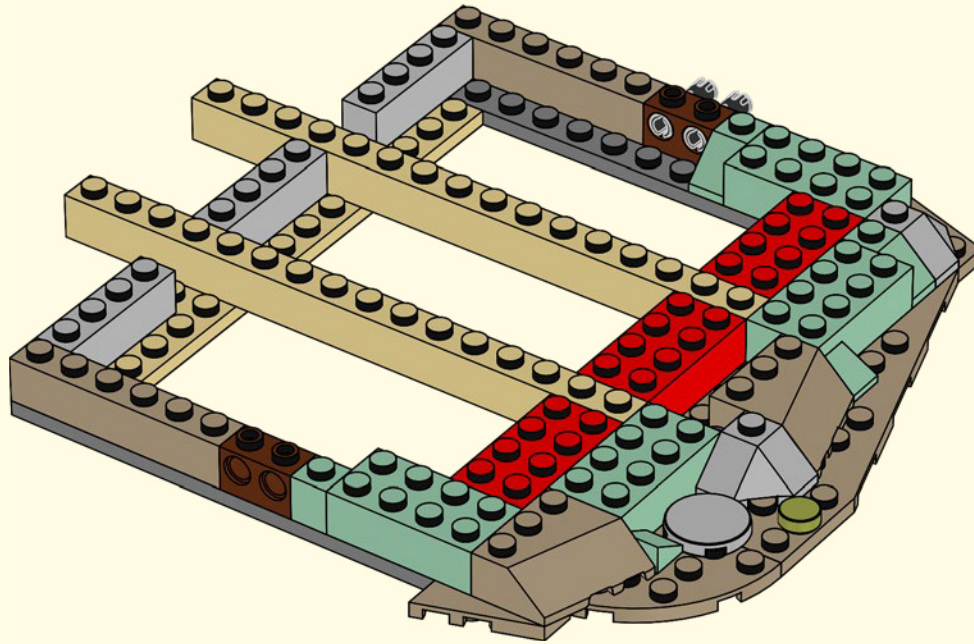

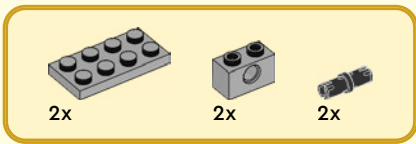

14

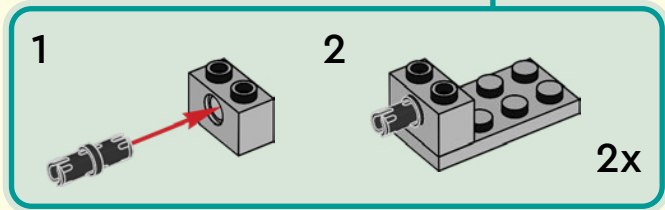
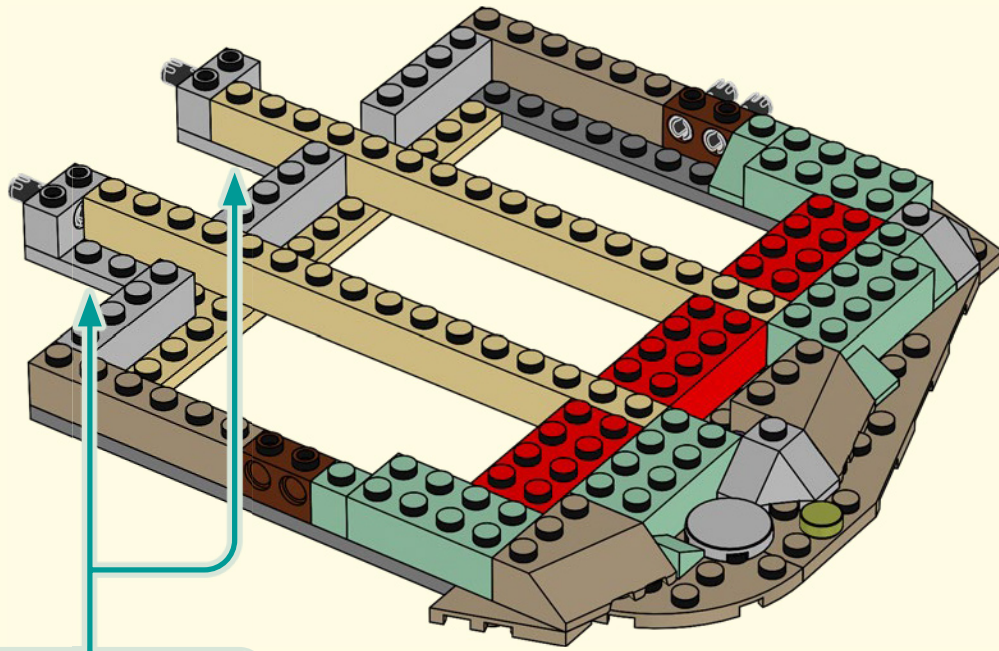

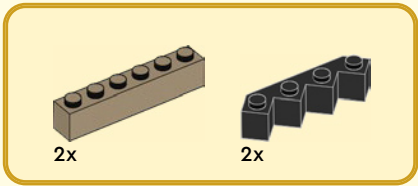

15

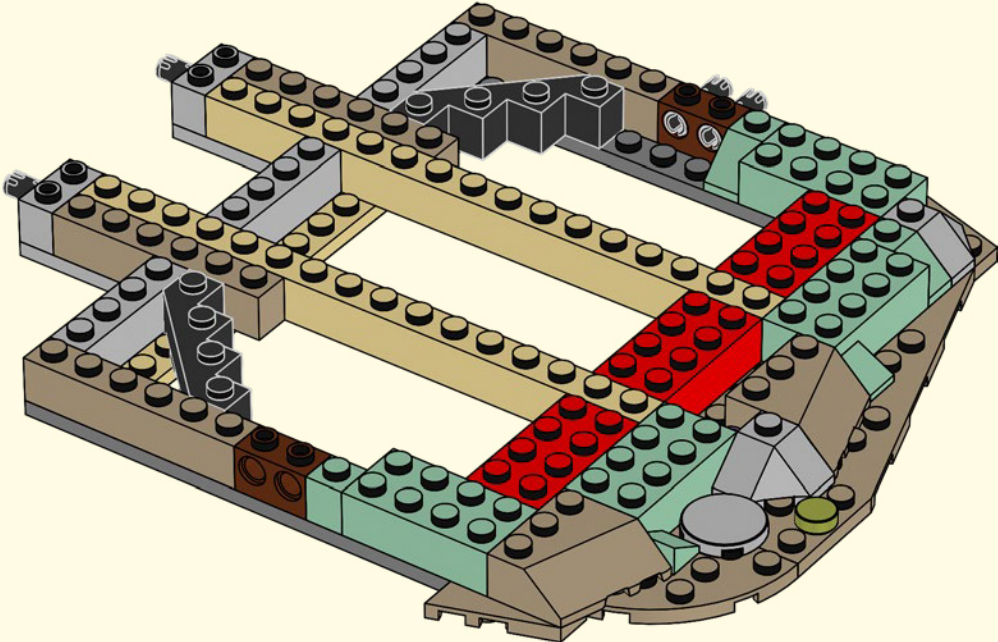

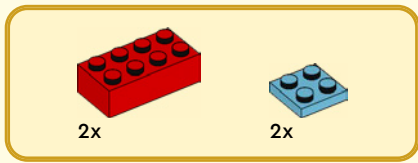

16

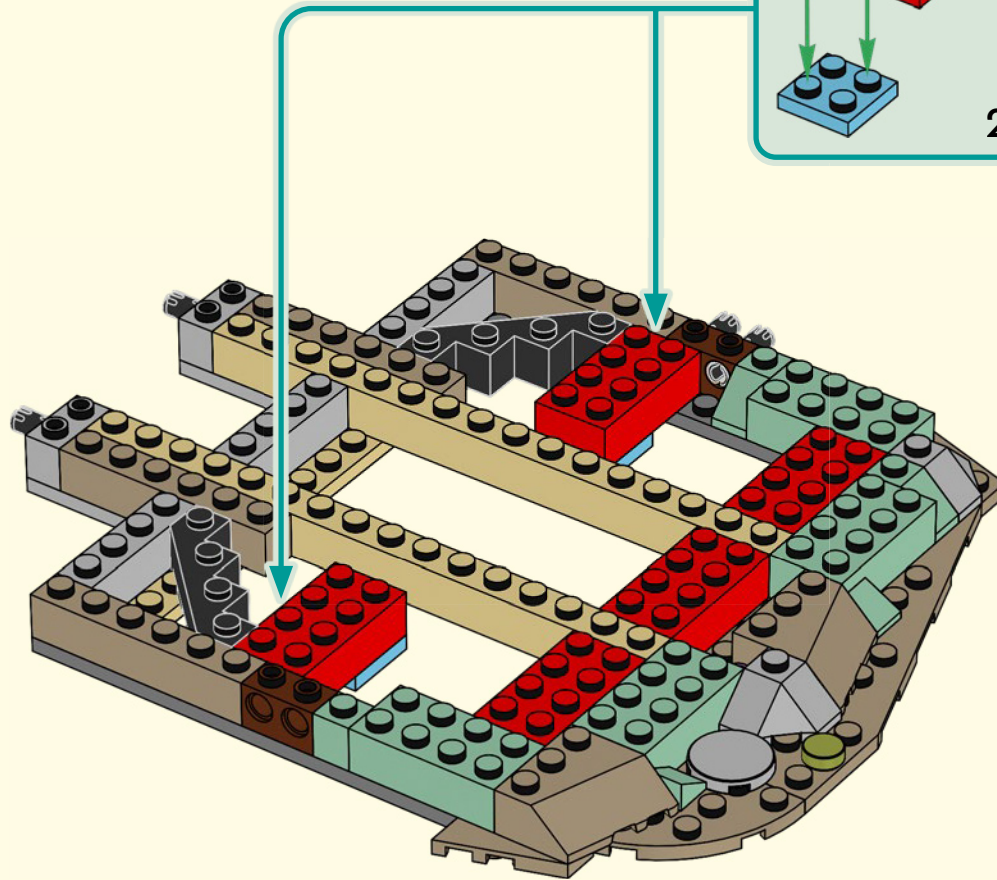
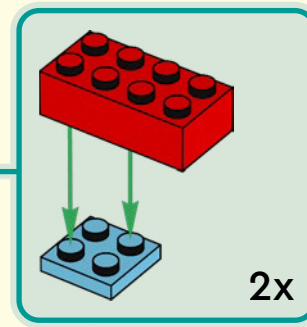

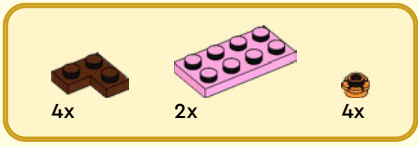

17

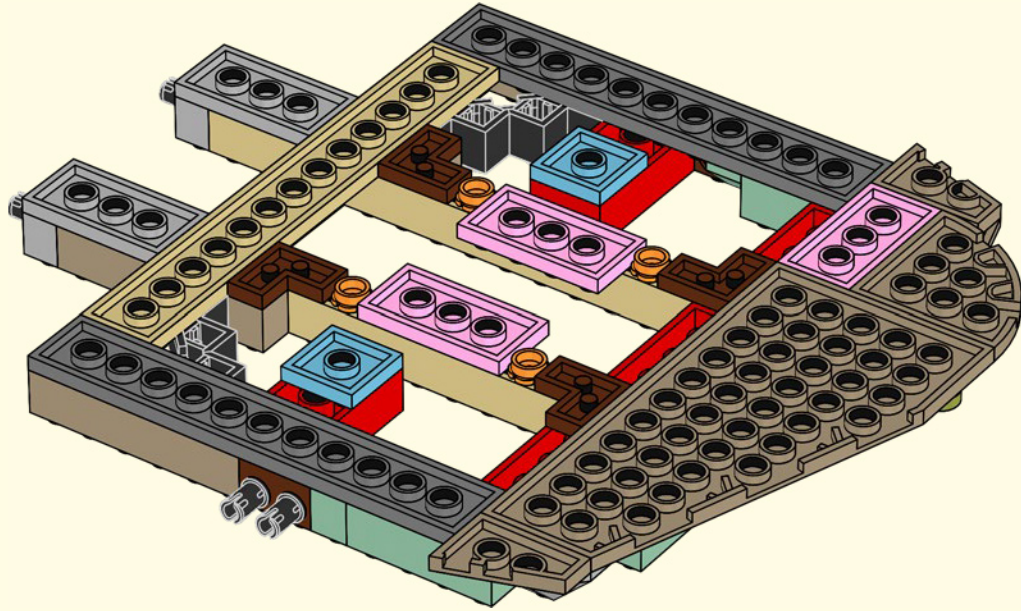



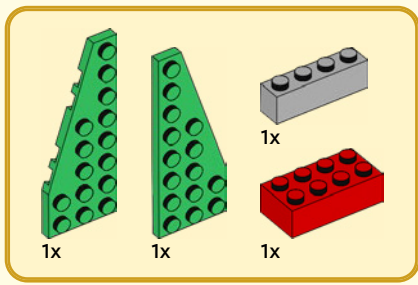

18

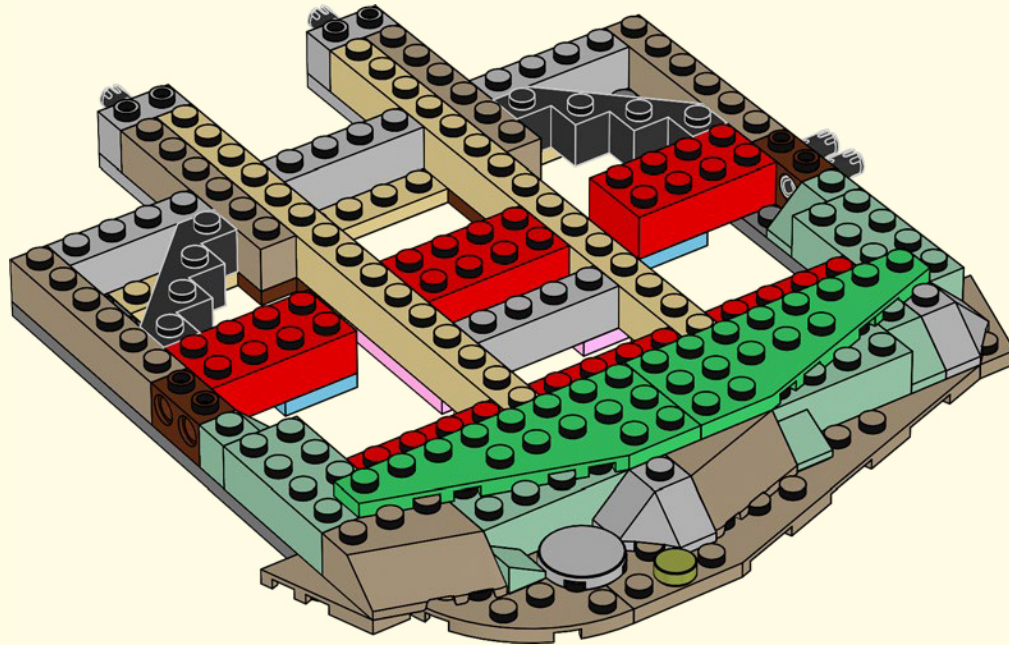

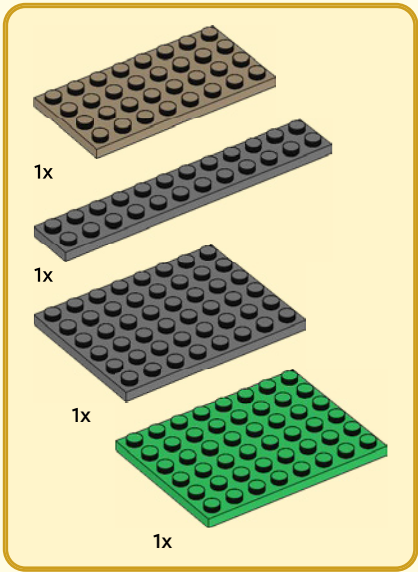

19

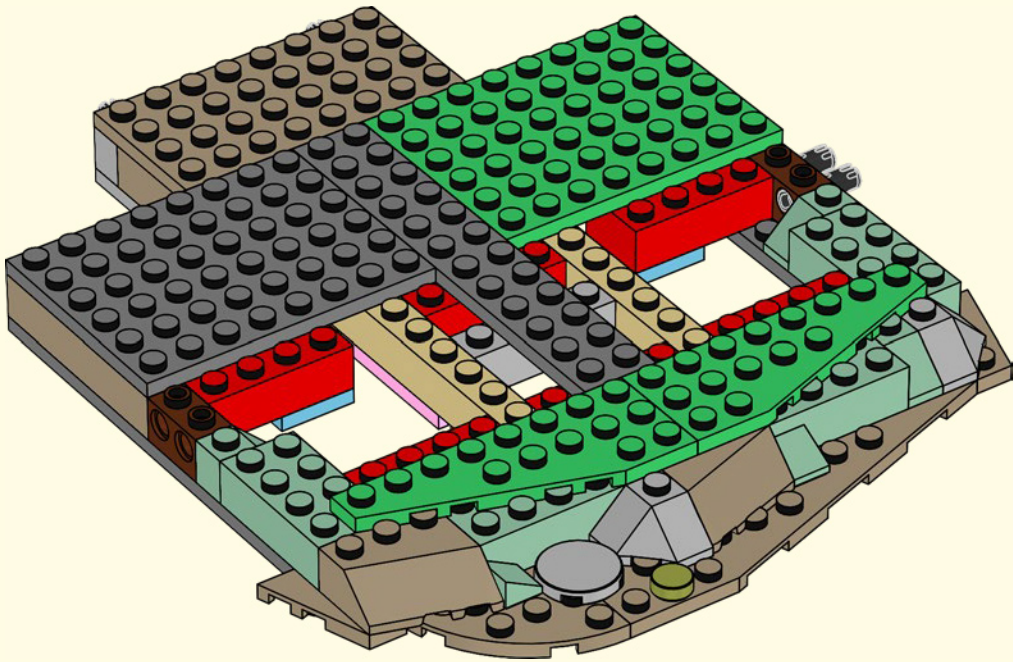

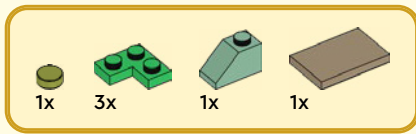

20

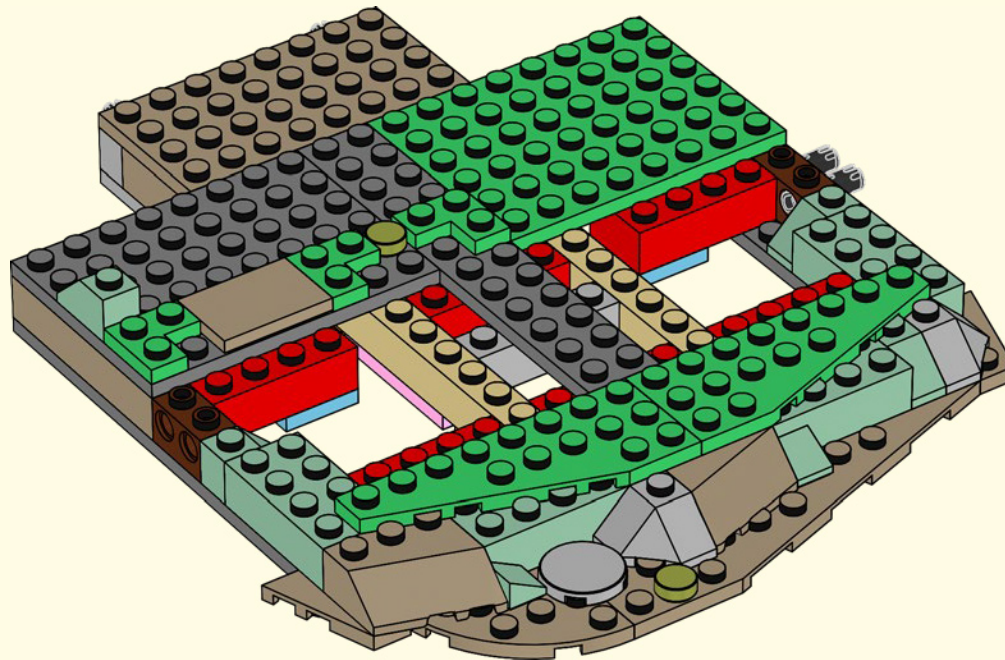

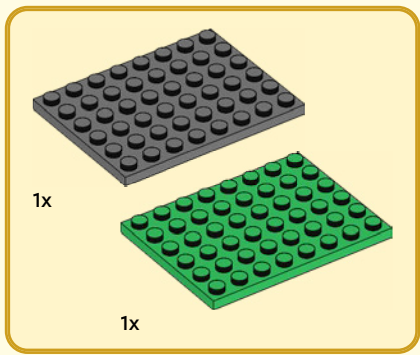

21

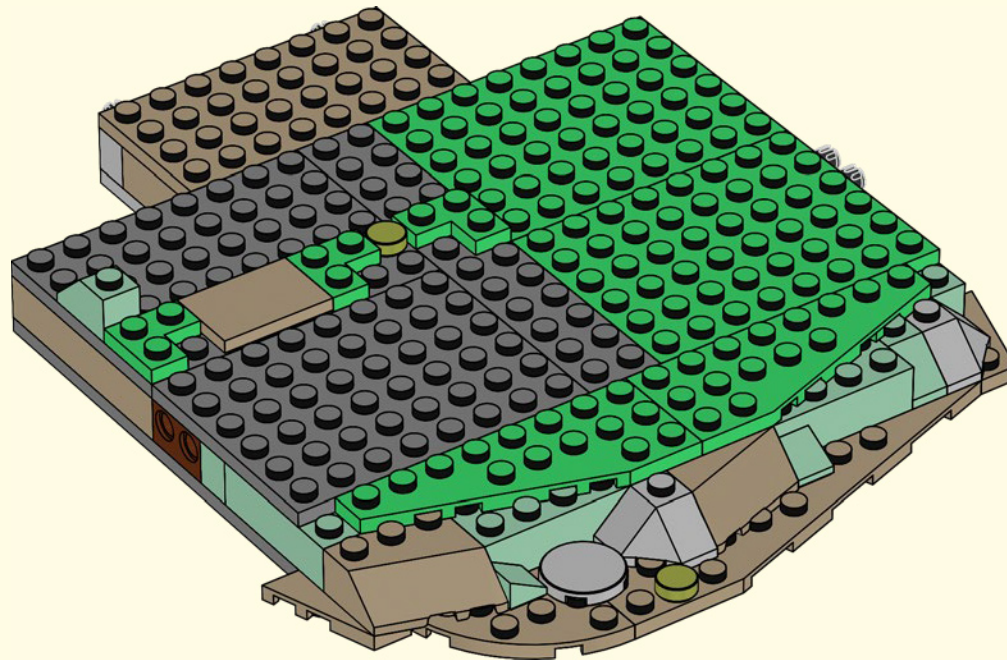

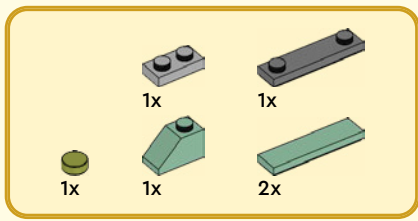

22

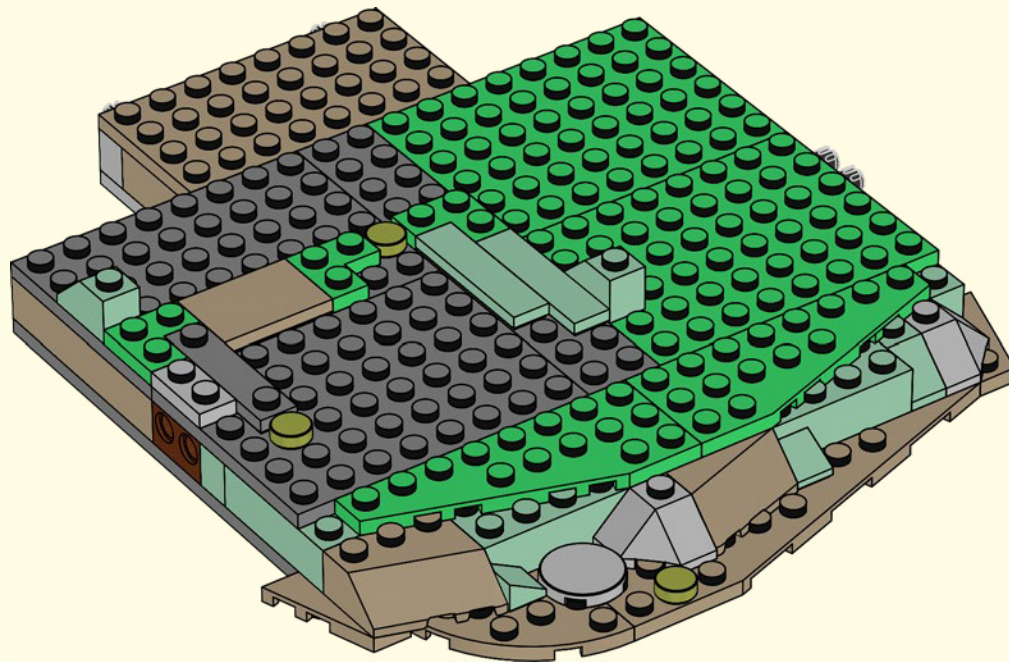

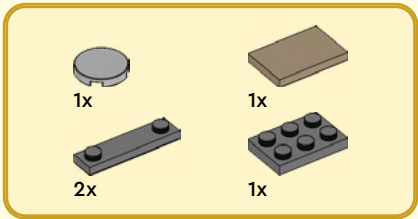

# 23

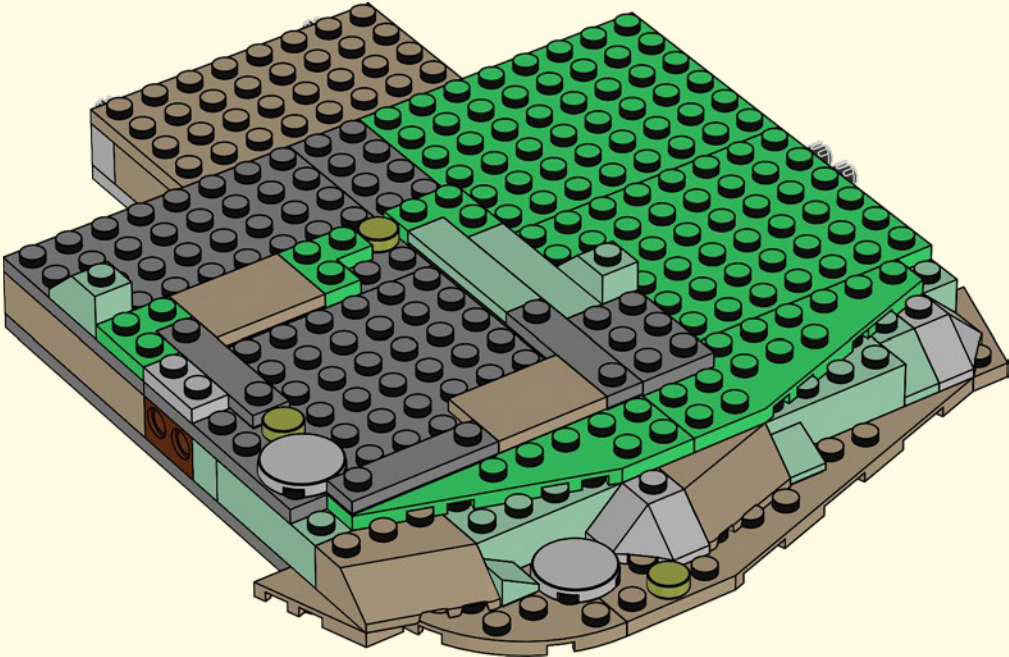

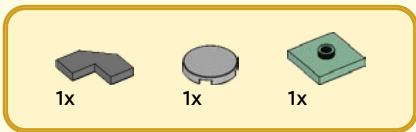

24

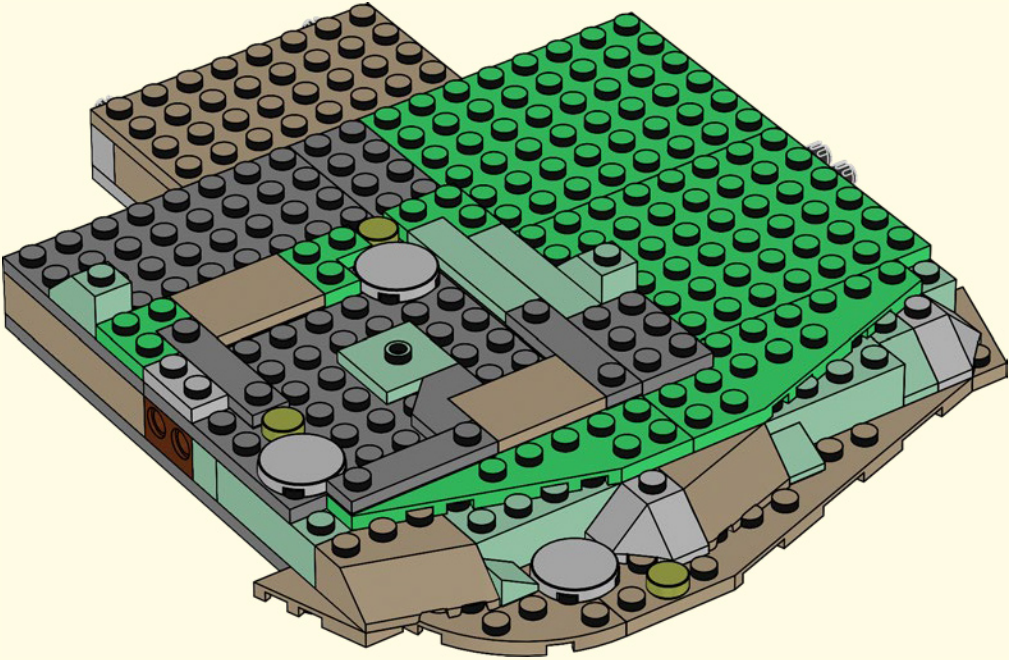



25

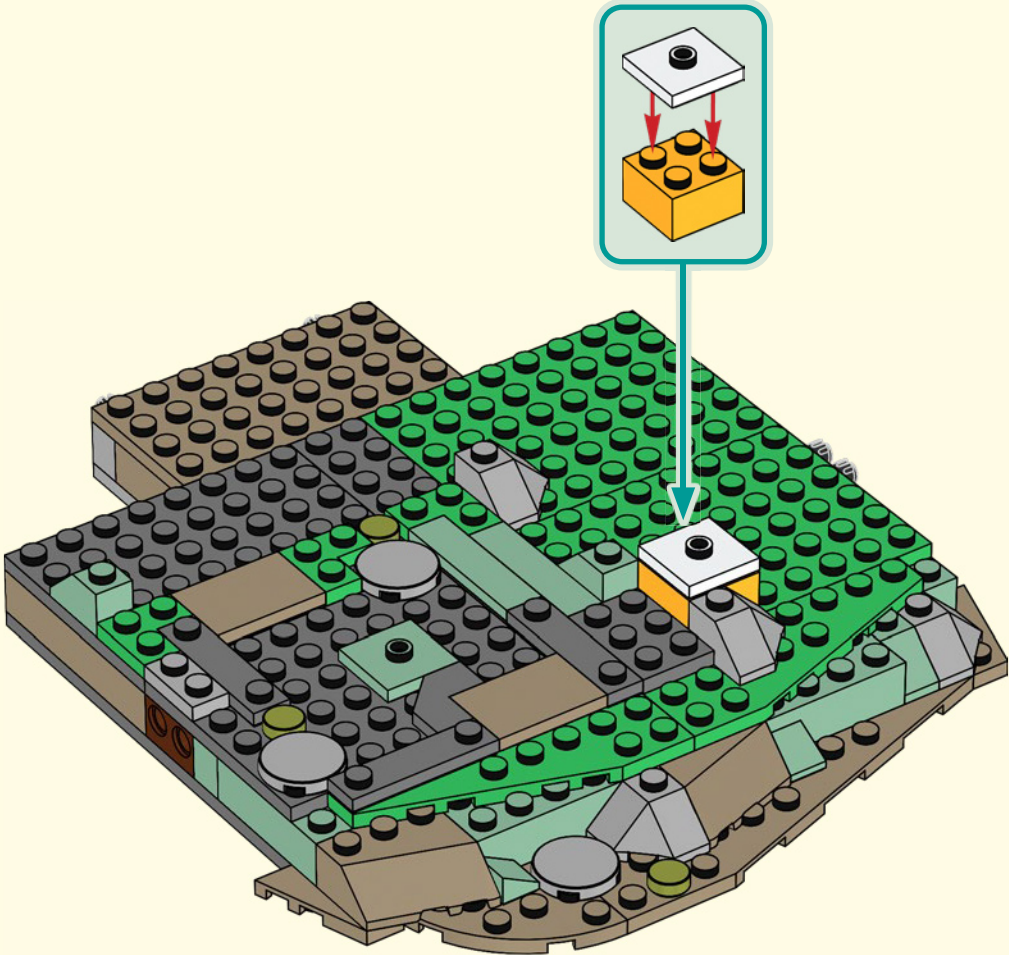



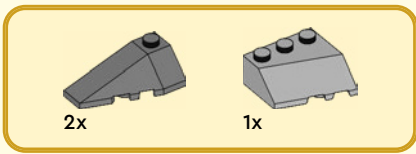

26

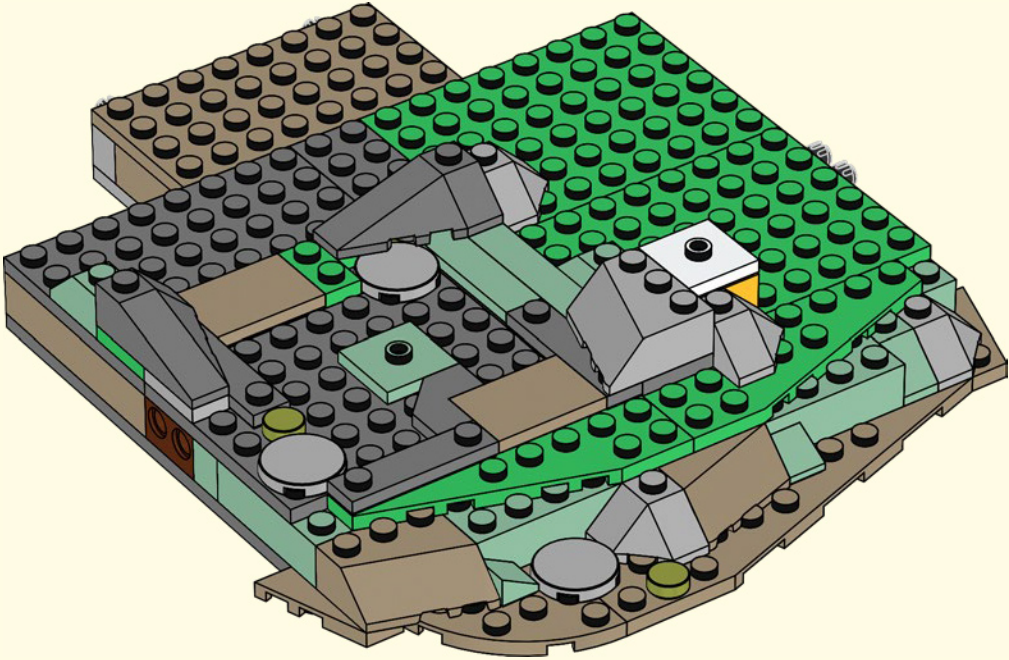



27

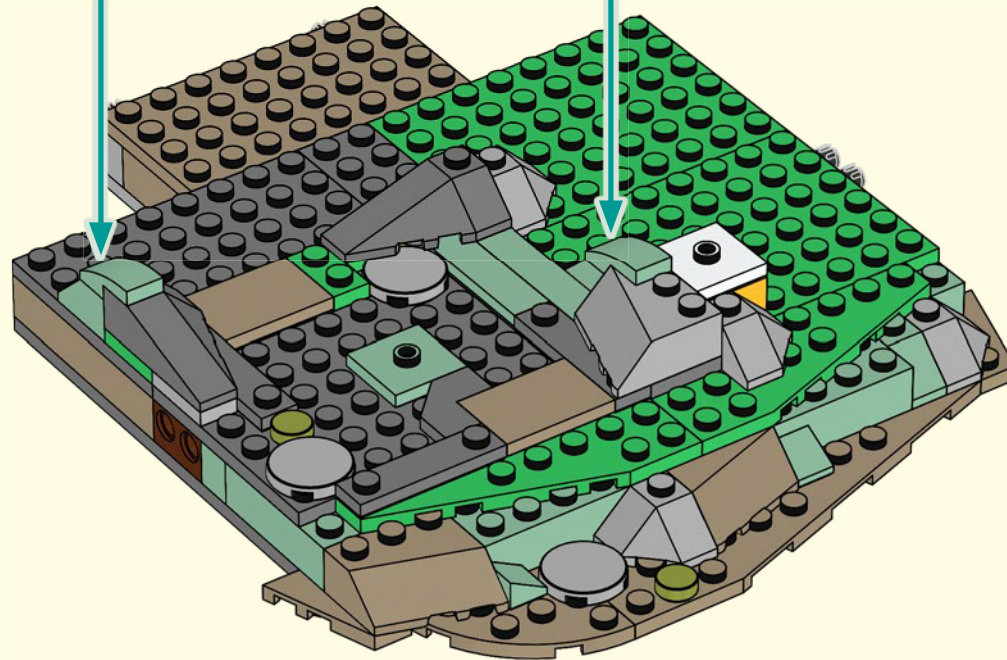
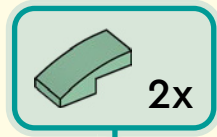





2x



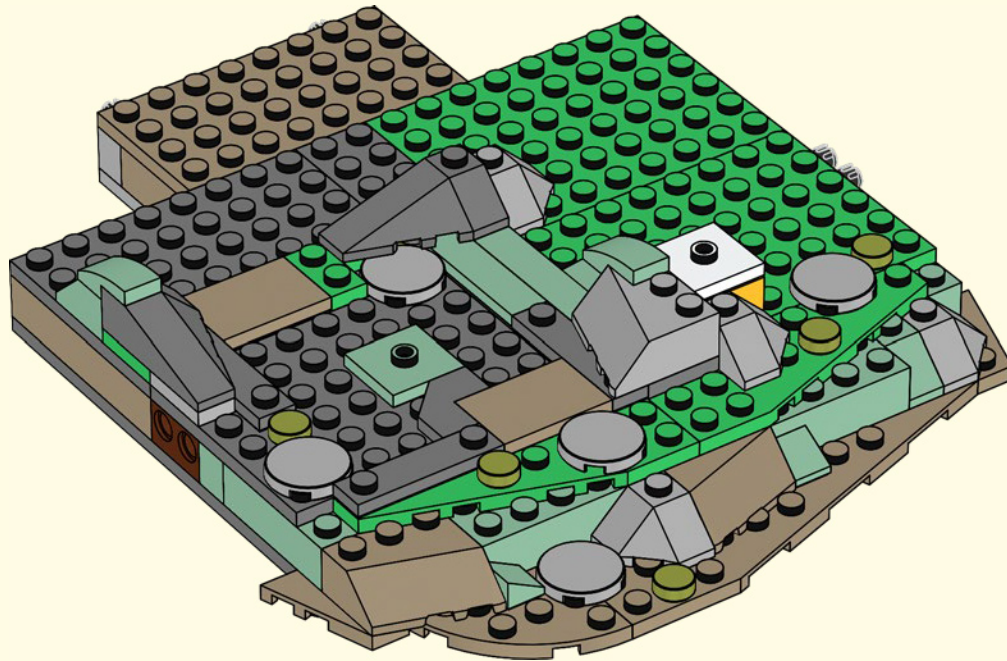

3x

28



3x  3x 

29

  
↓  
 3x

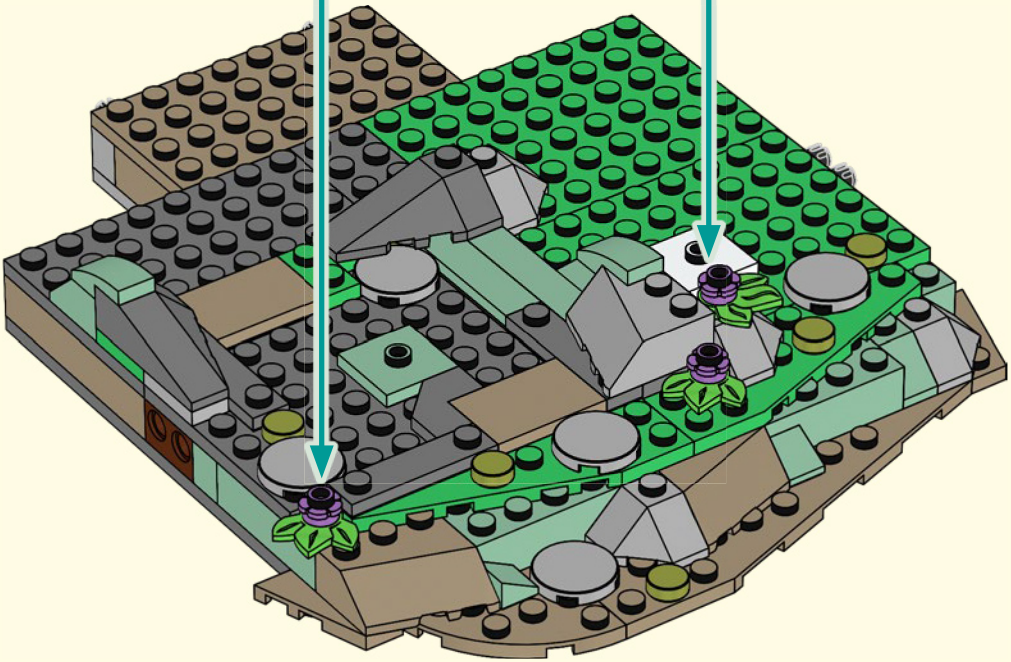





1

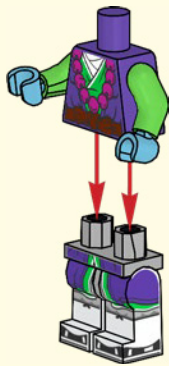

2

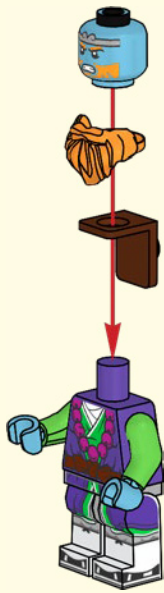

3

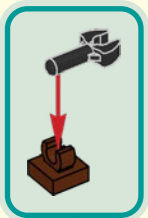



4

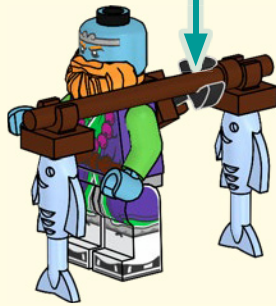
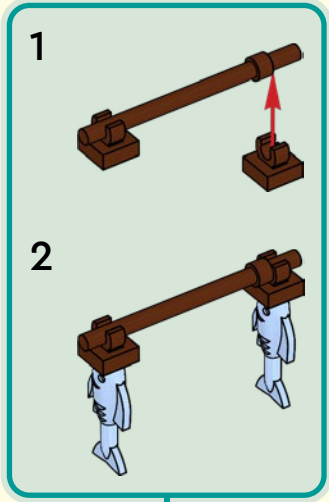

5

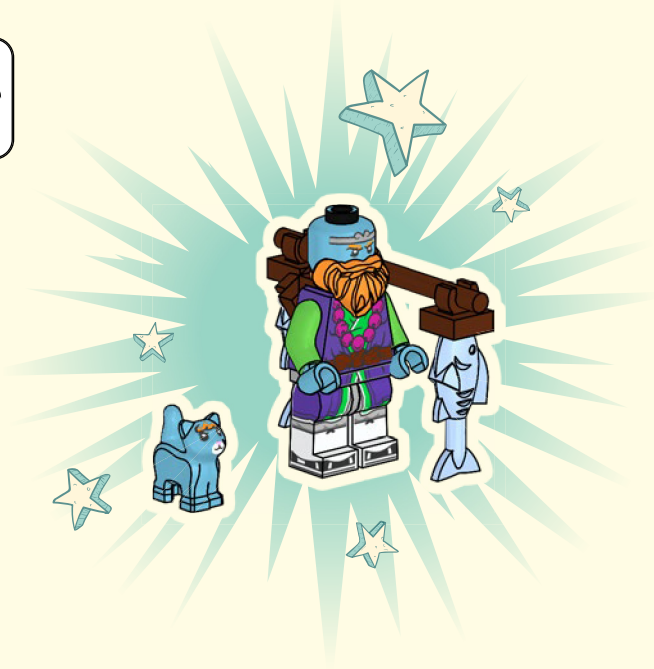

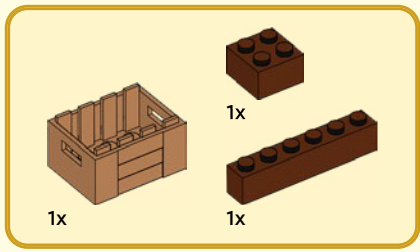

30

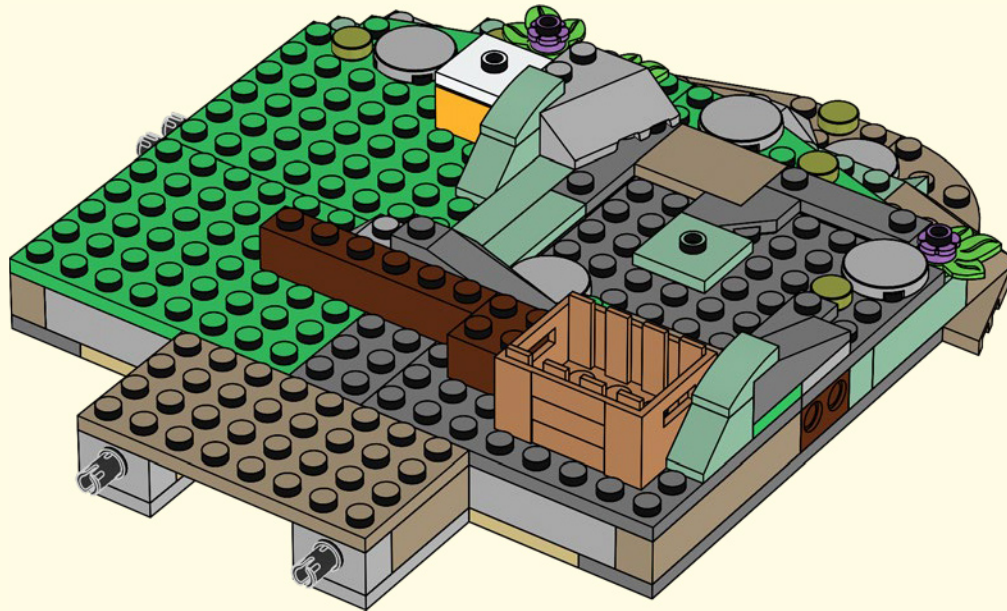



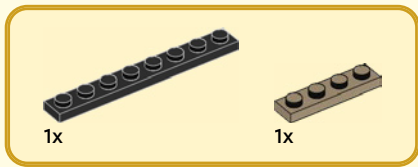

31

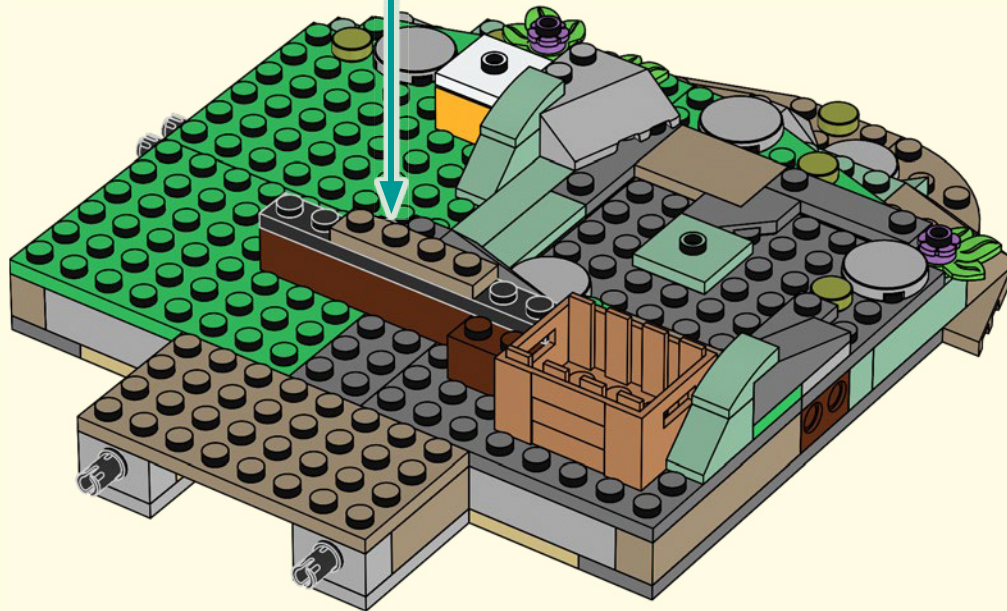
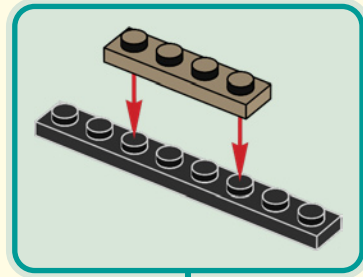

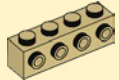

1x



1x

# 32

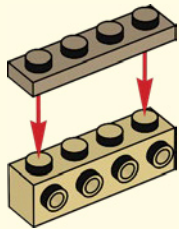

2x



2x

# 33

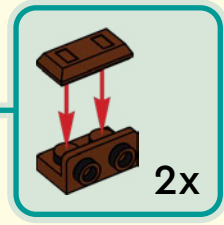
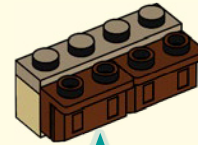

2x

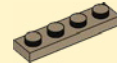

1x

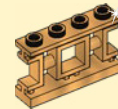

1x

# 34

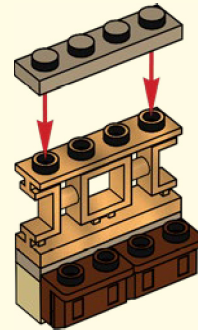

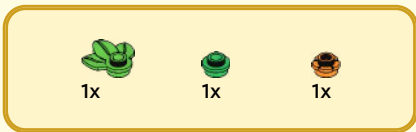

35



36



37

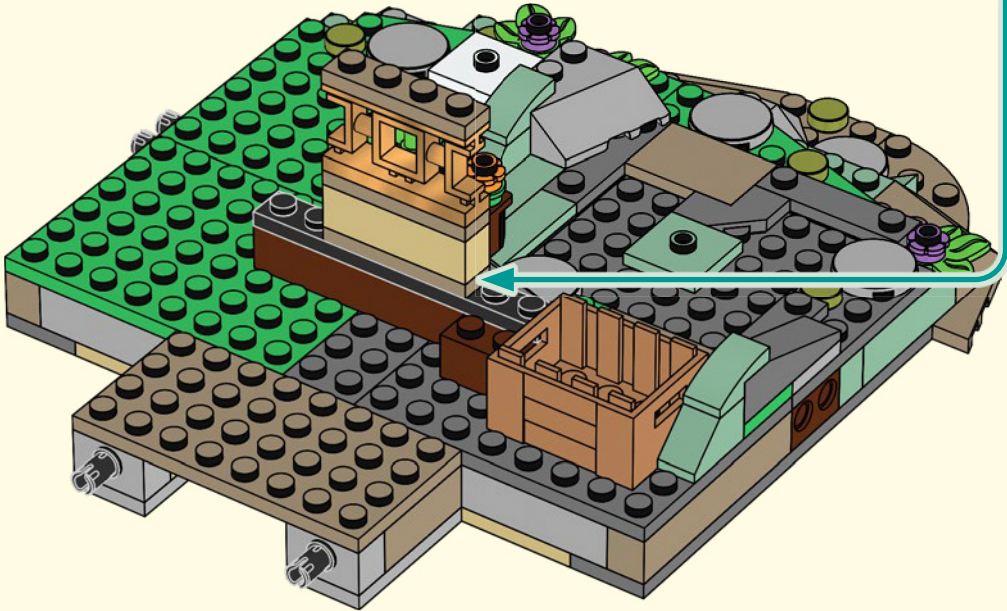

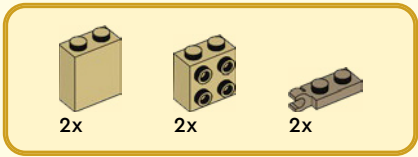

38

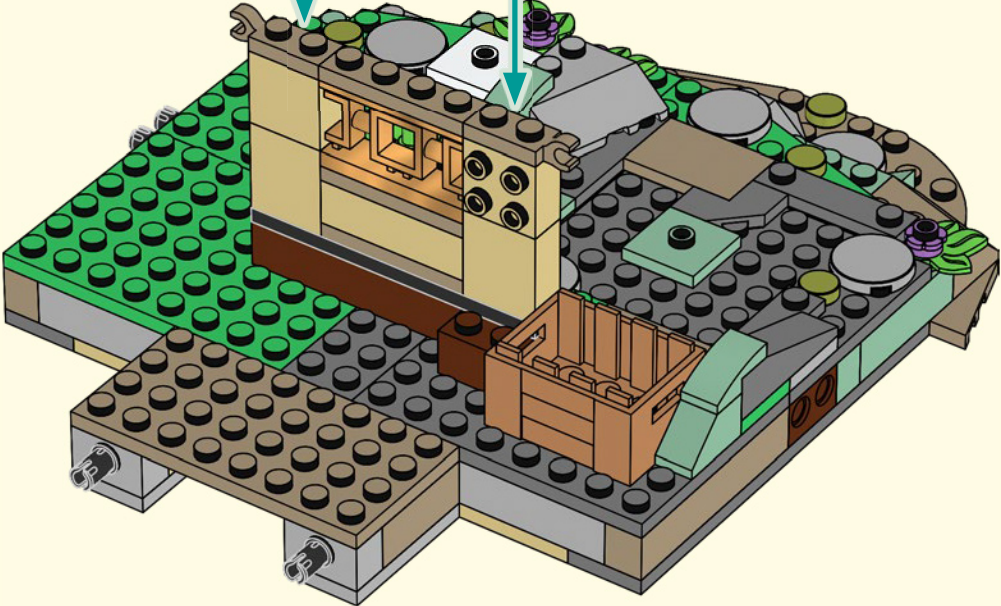
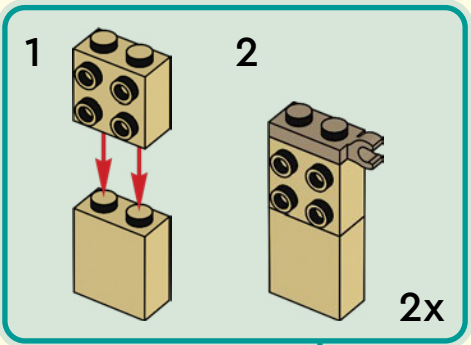

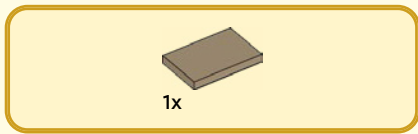

39

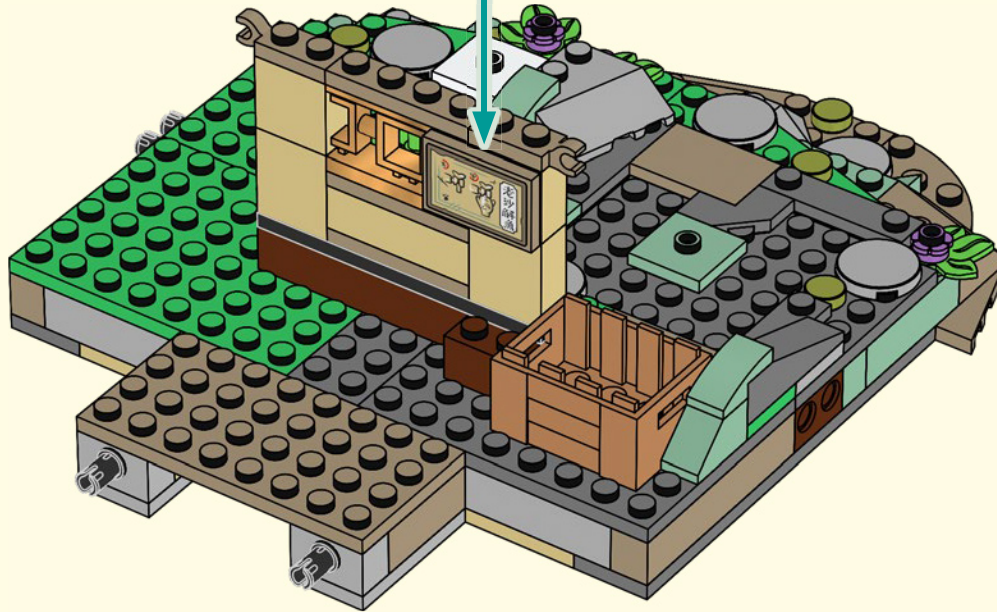
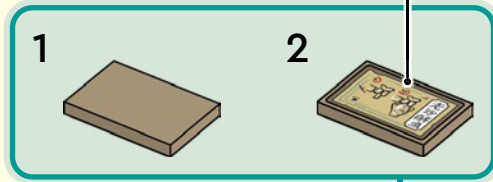



2x



1x

40

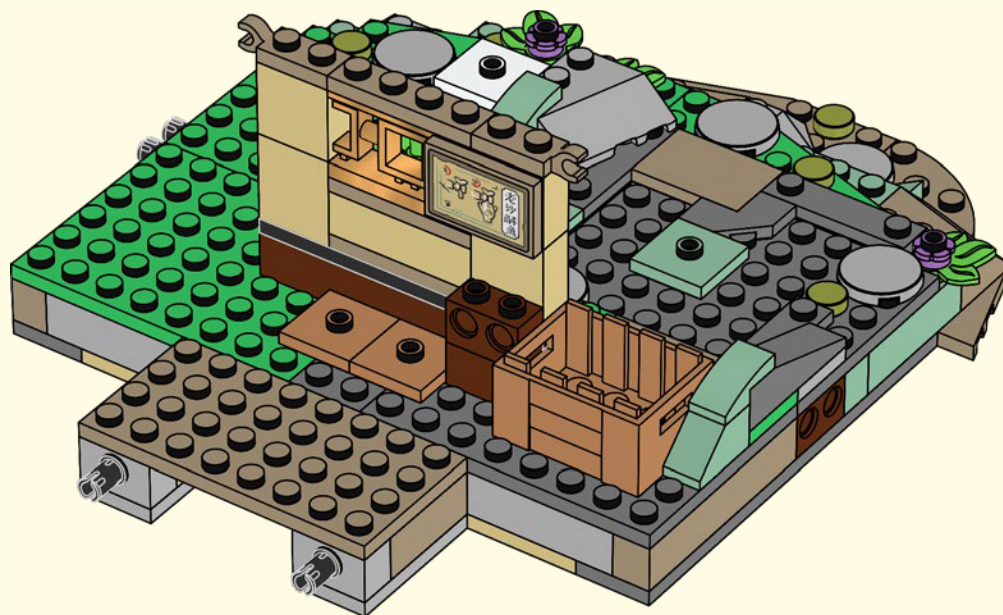

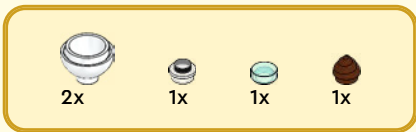

41

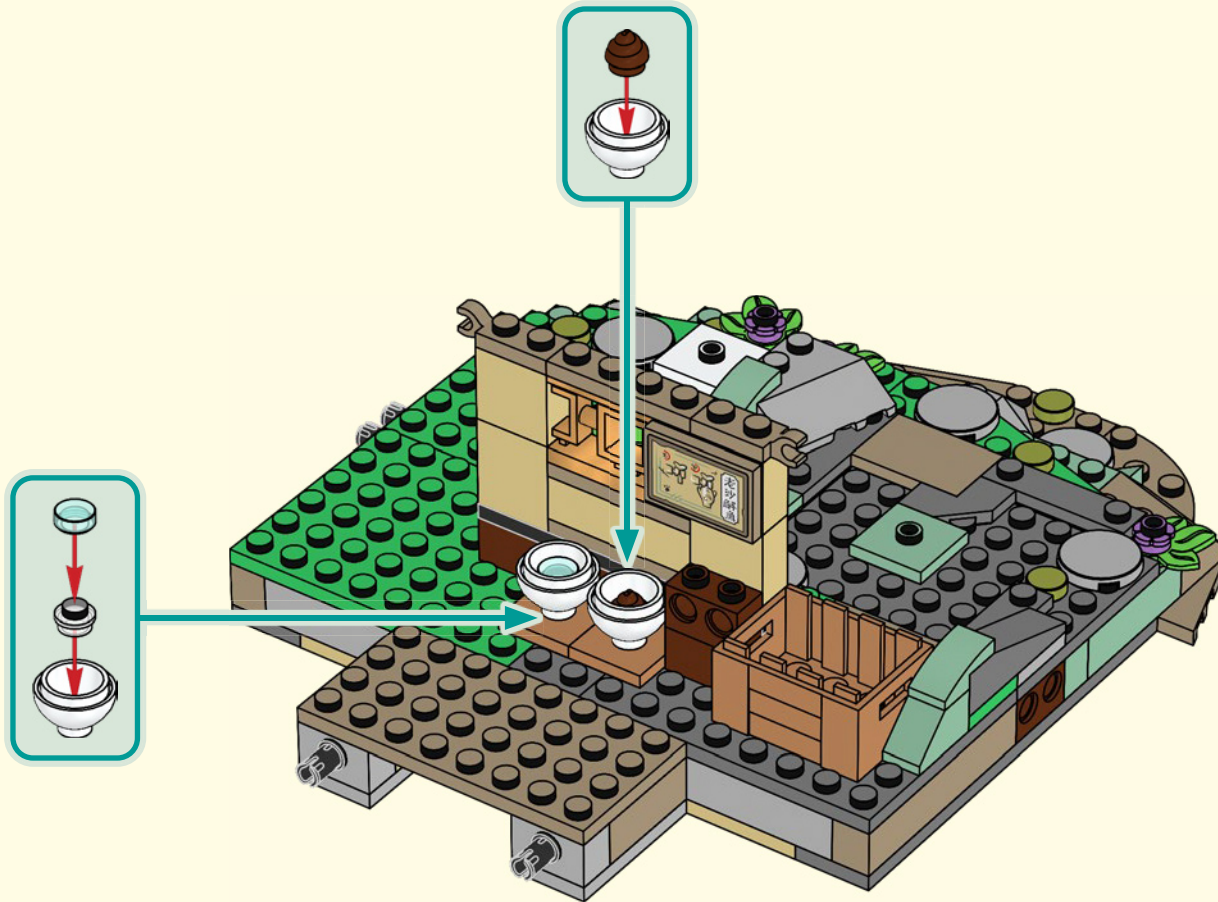

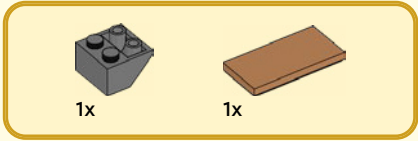

42

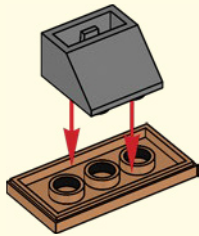

43

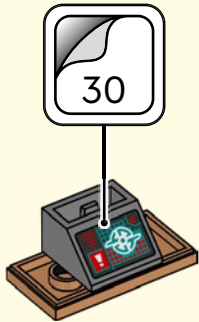

44

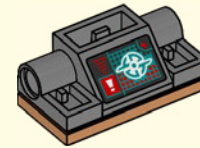

45

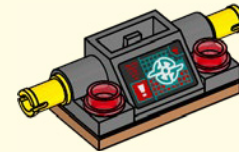





46

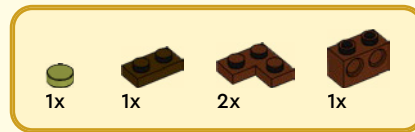
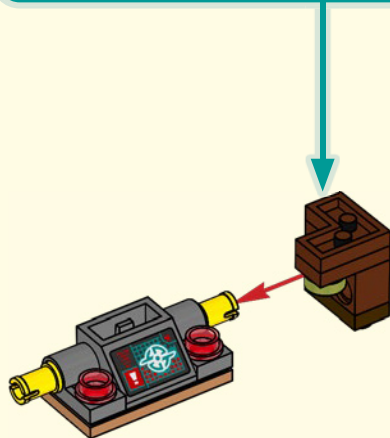
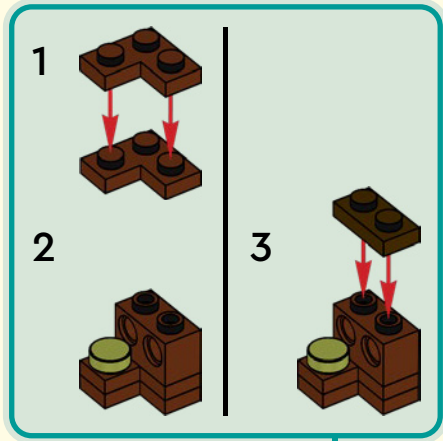

47

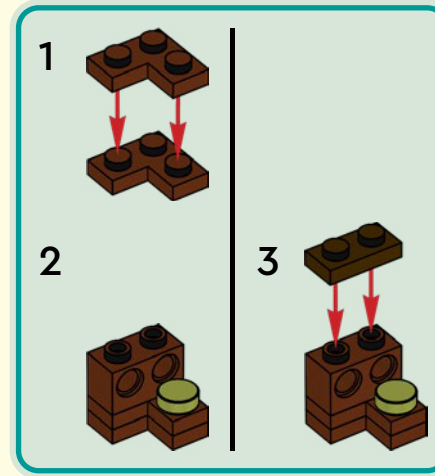

48



49



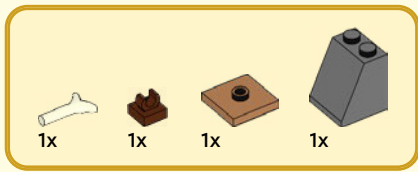

50

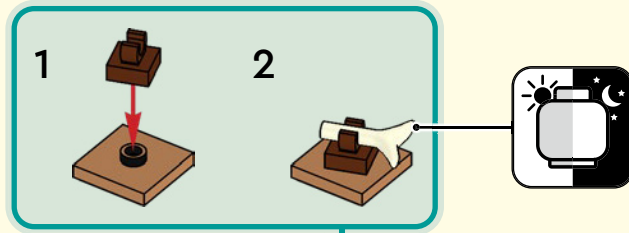

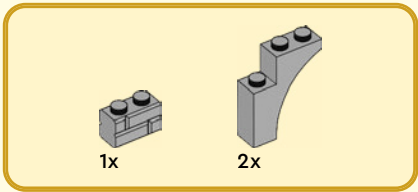

51



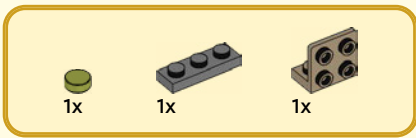

52



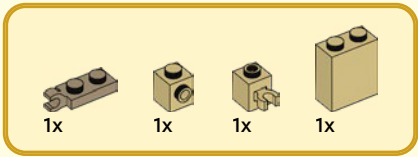

# 53

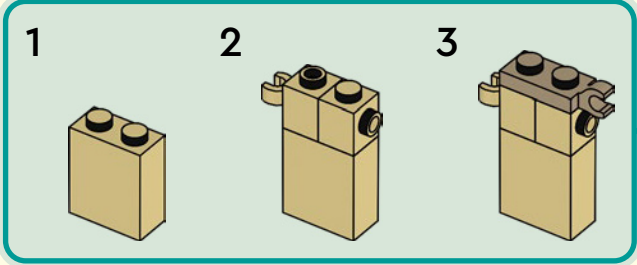
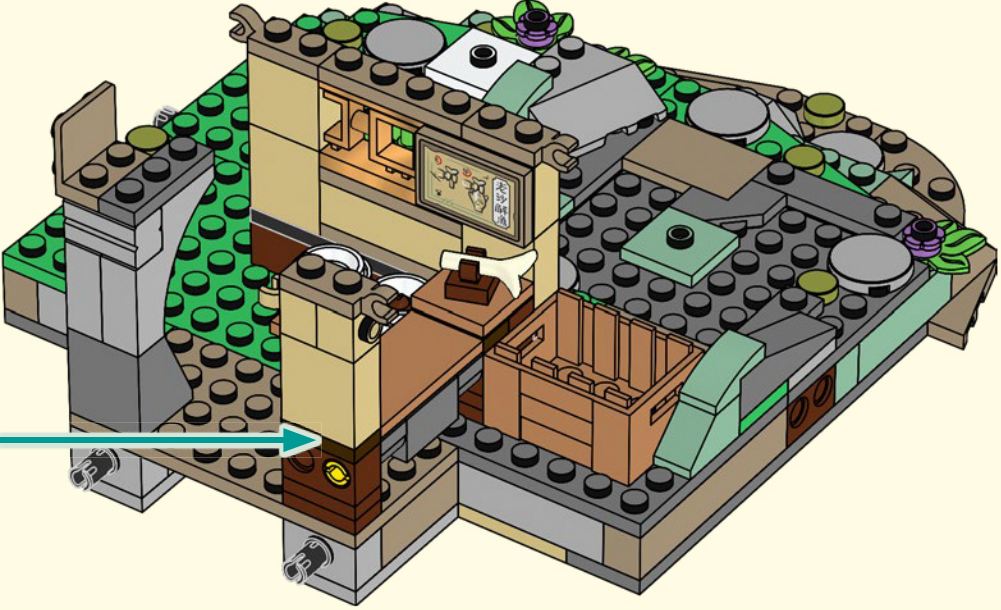

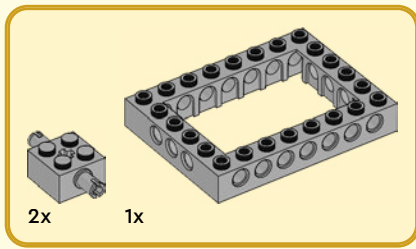

54

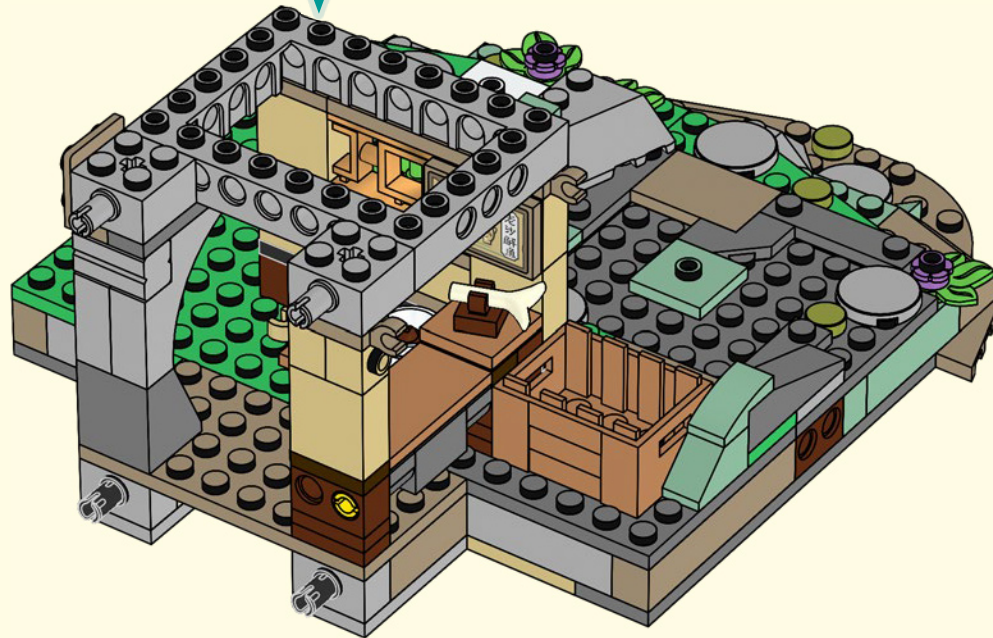
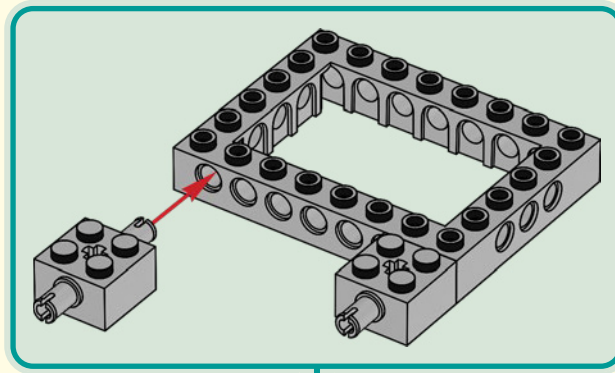

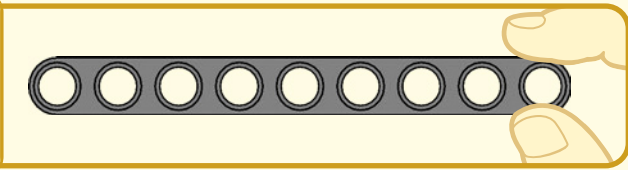
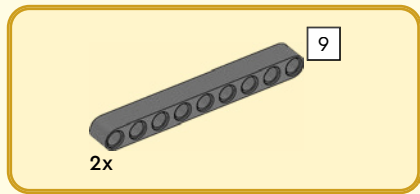

55

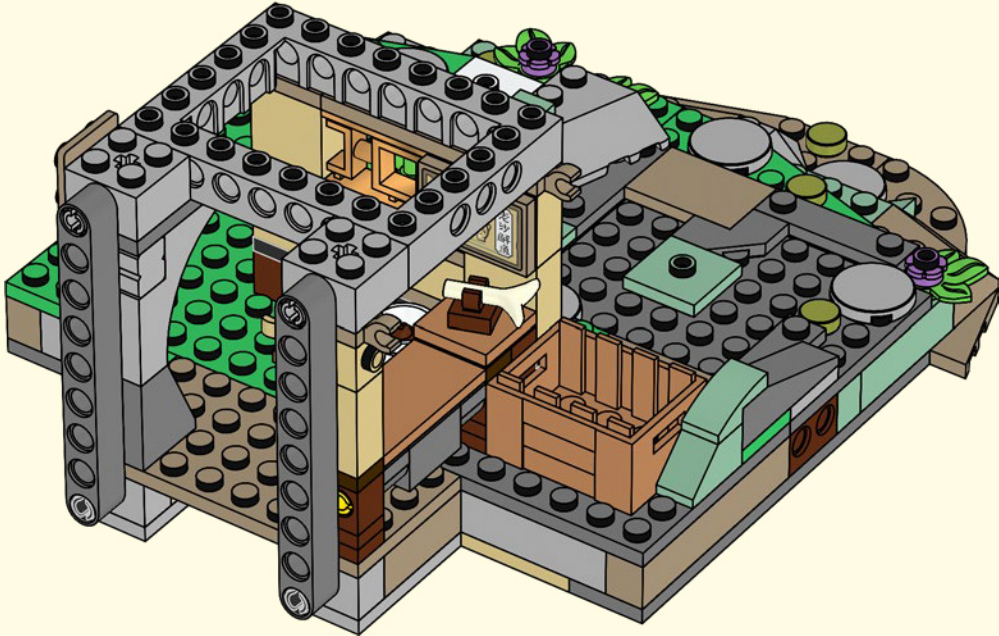



4x  1x 

56

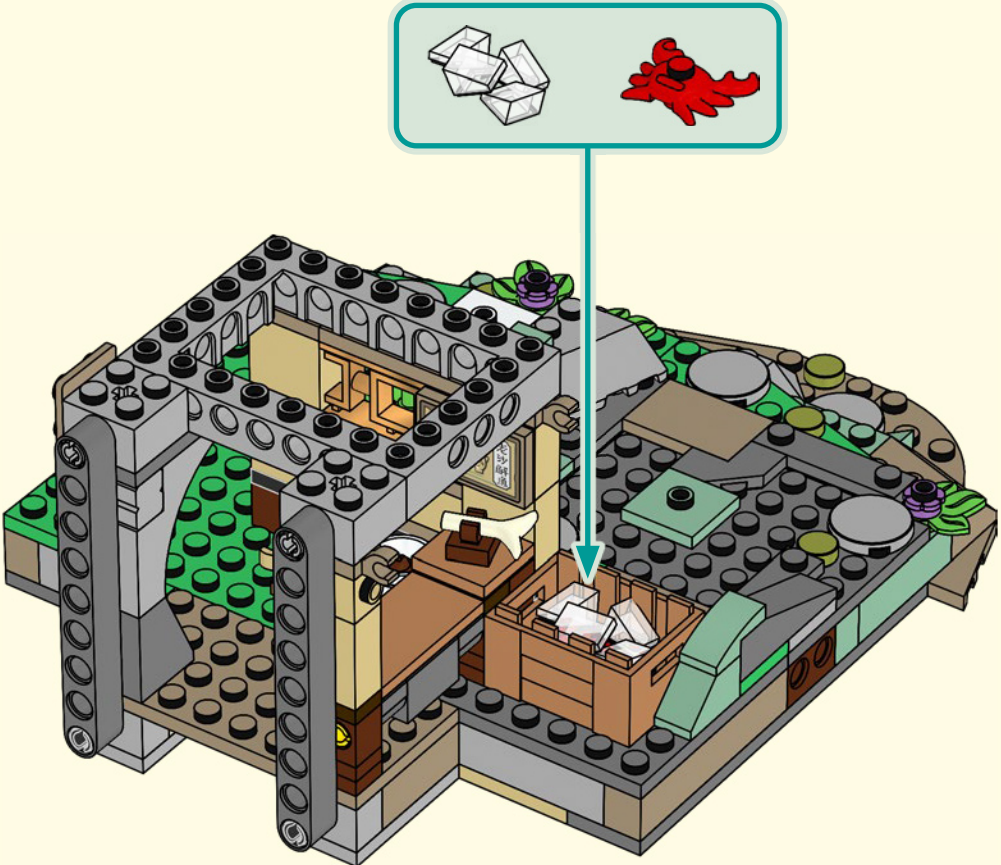

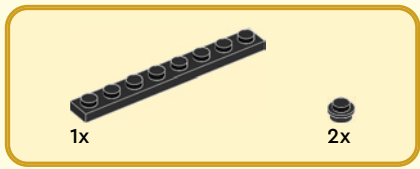

57

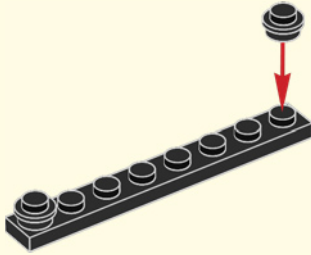

58

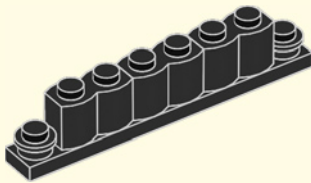

59

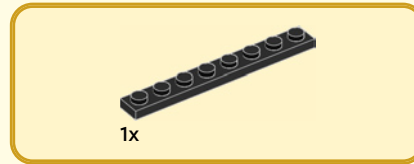
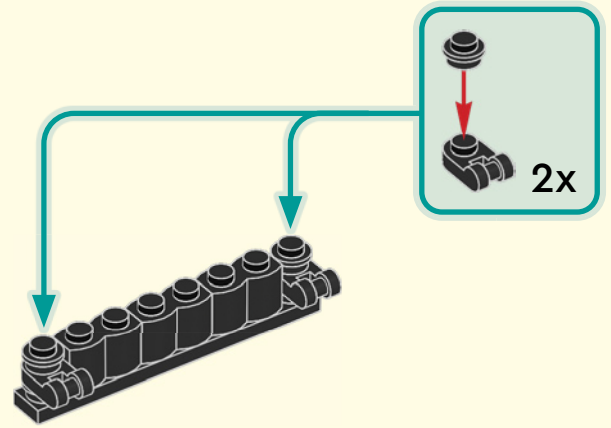

60

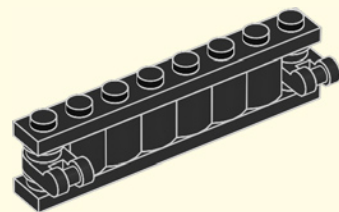

61

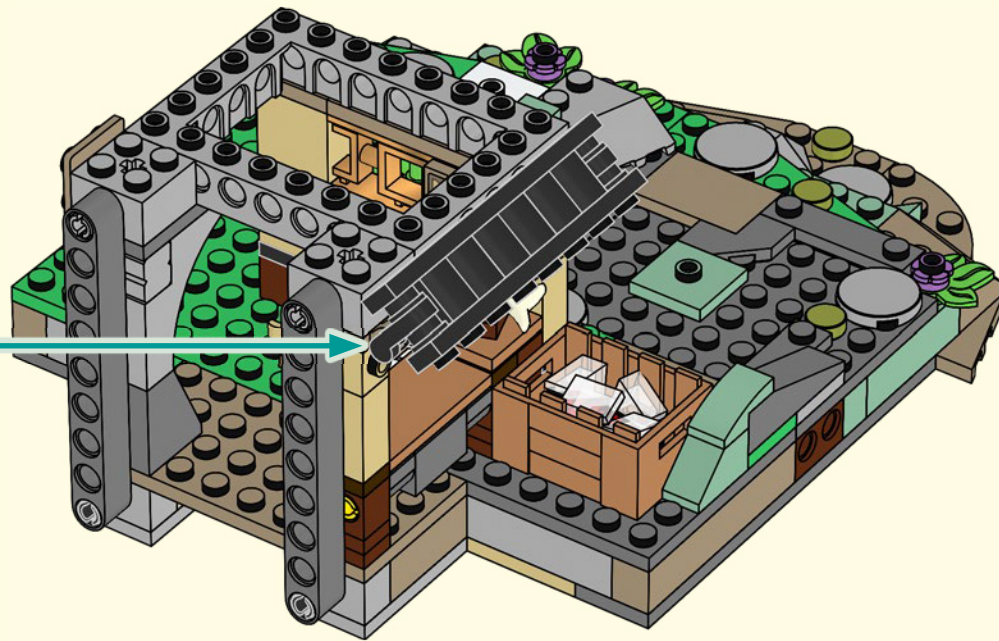

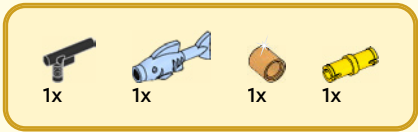

62

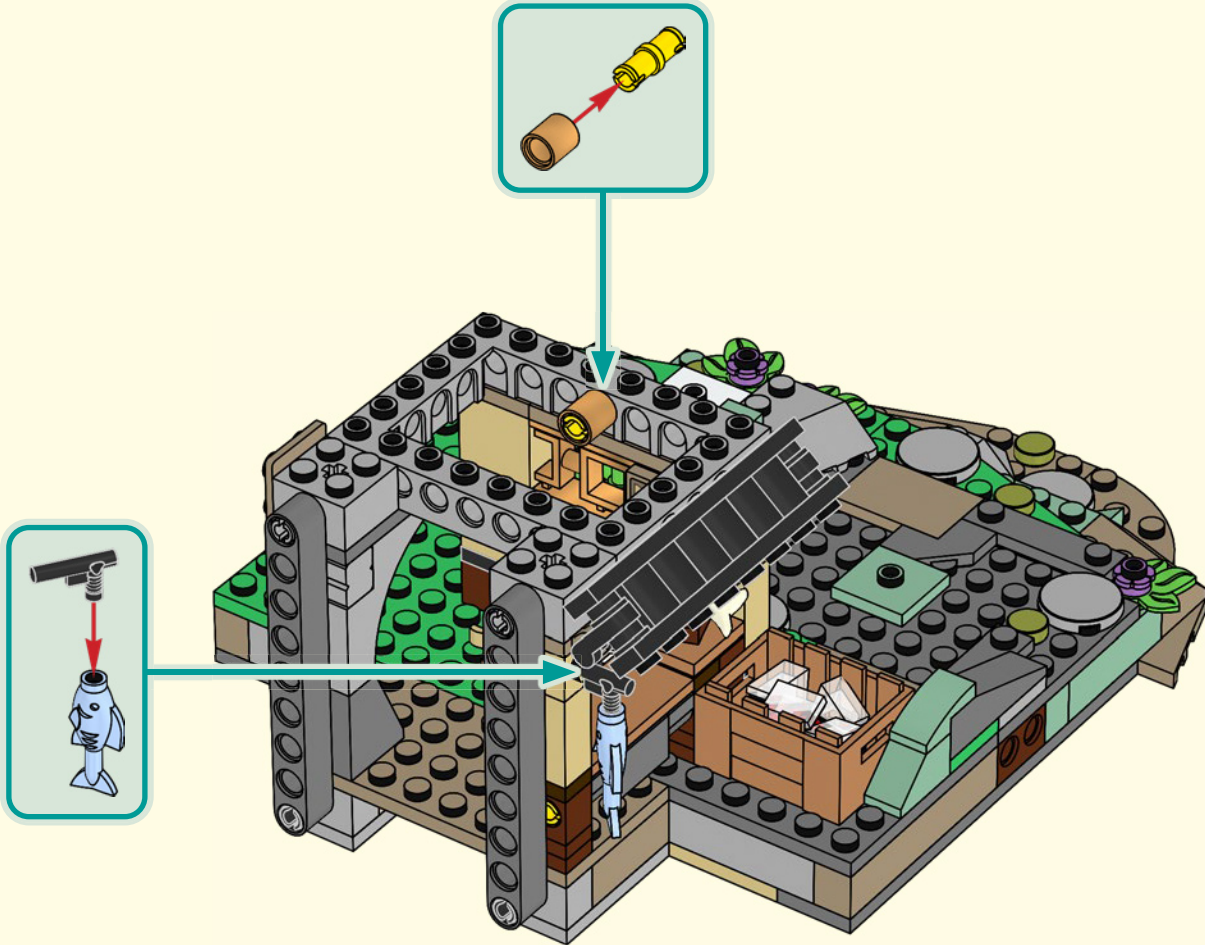

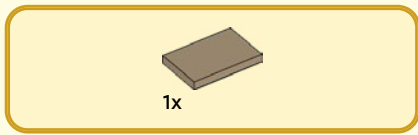

63

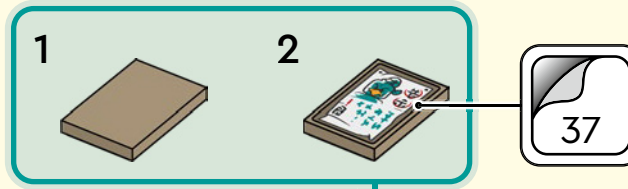

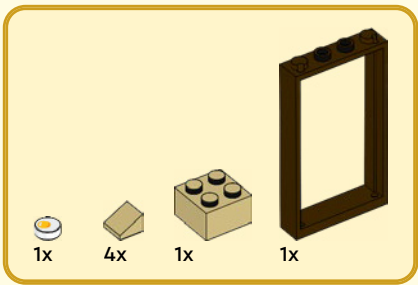

64

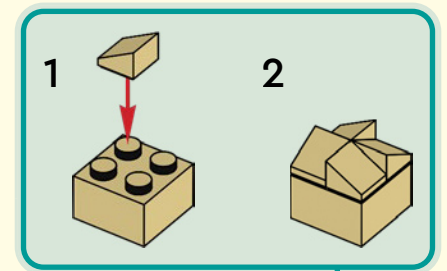

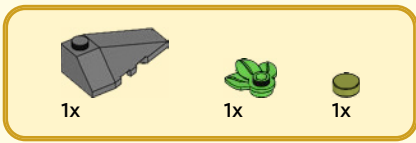

65



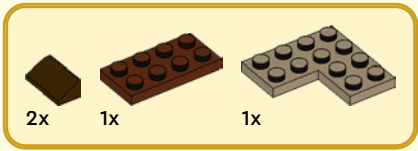

66





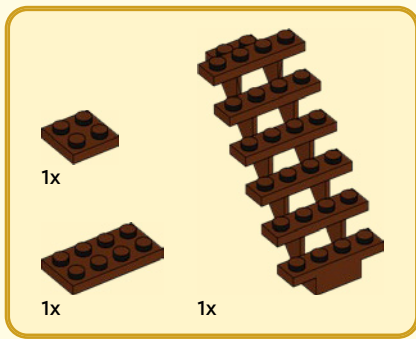

67

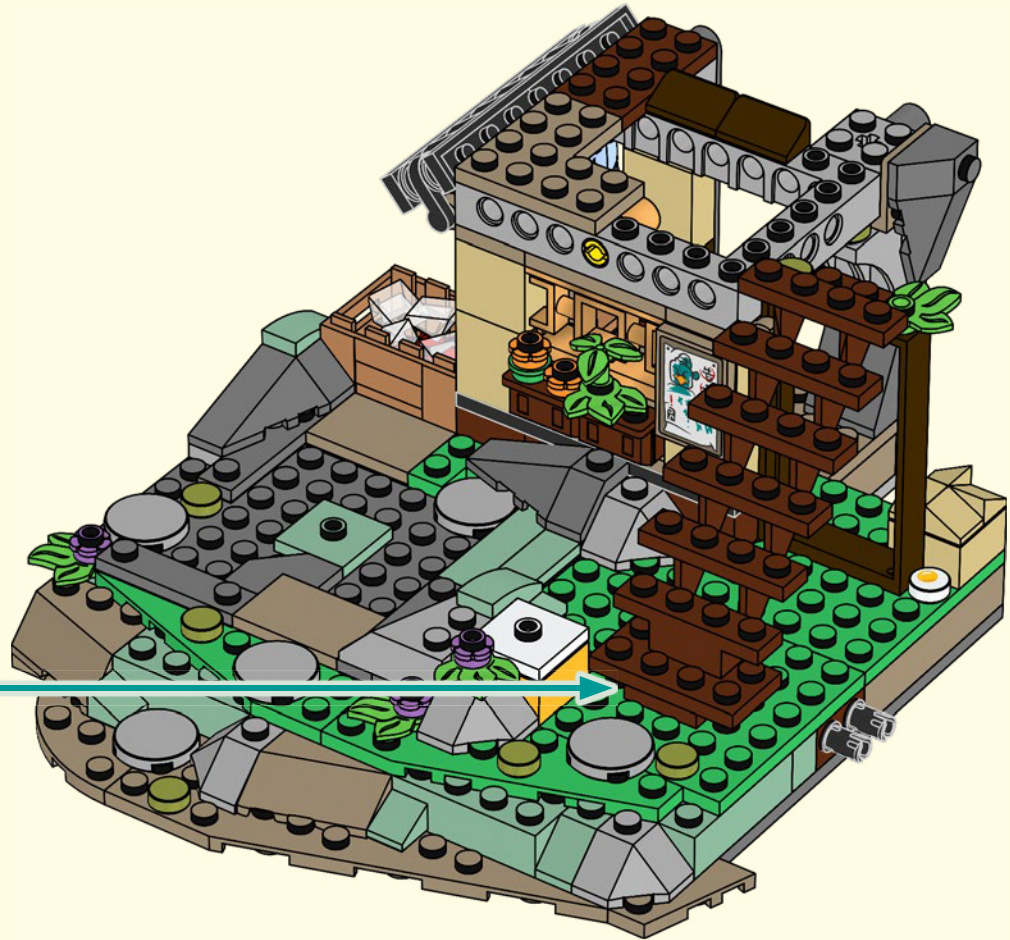
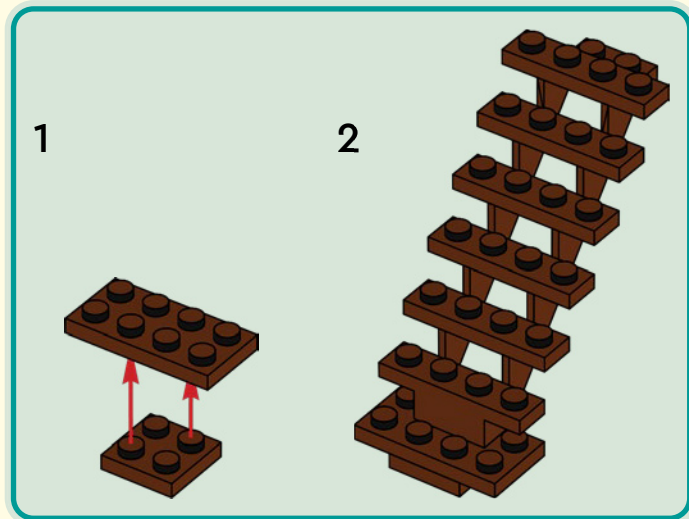

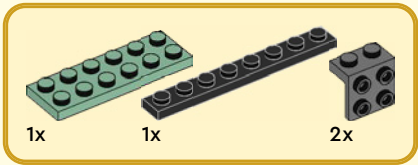

68

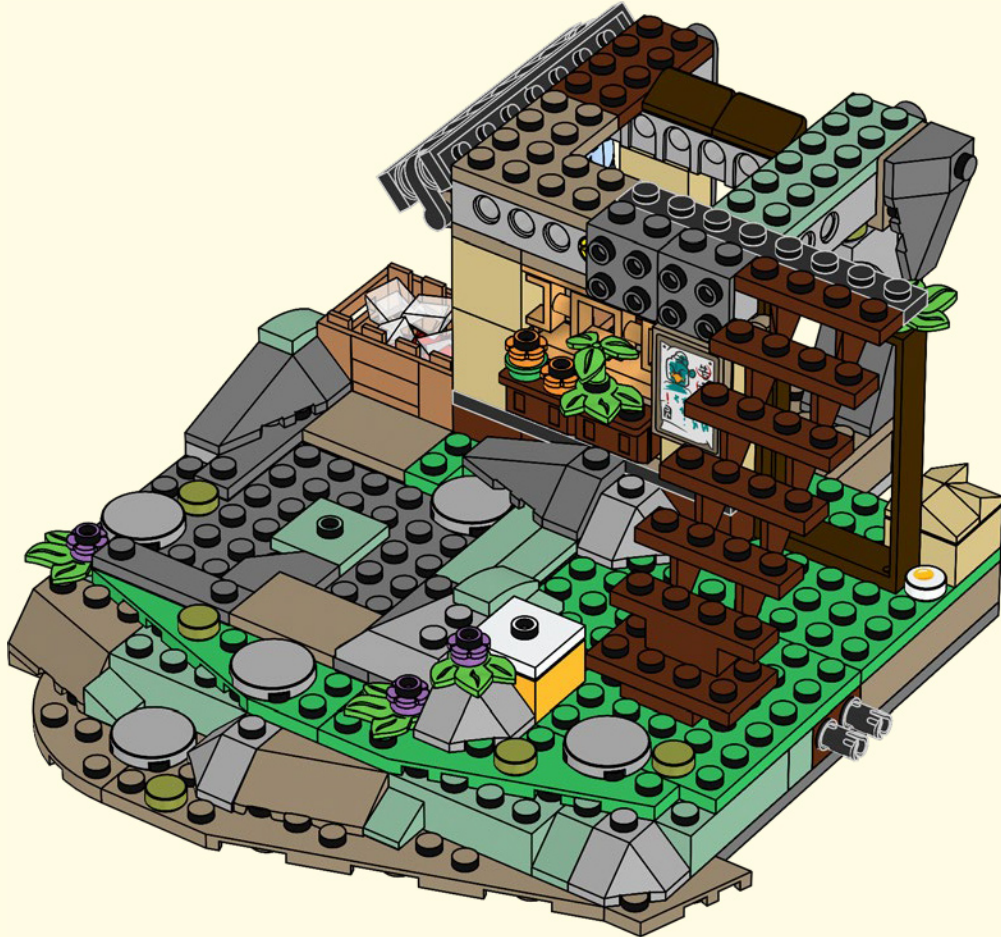

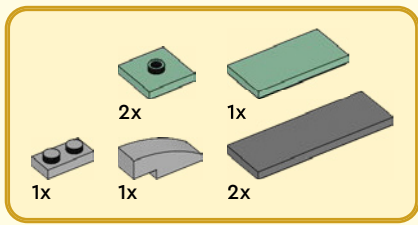

69

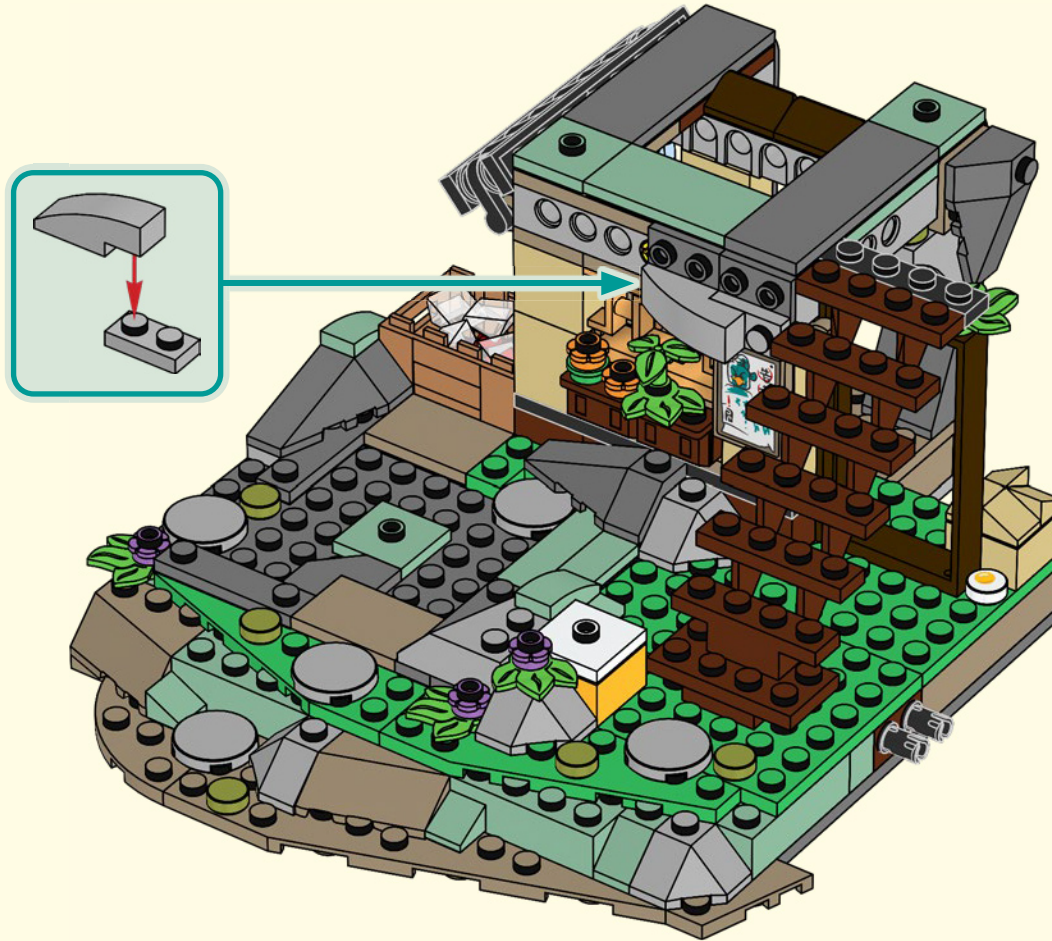

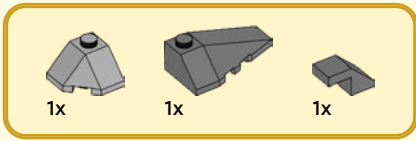

70

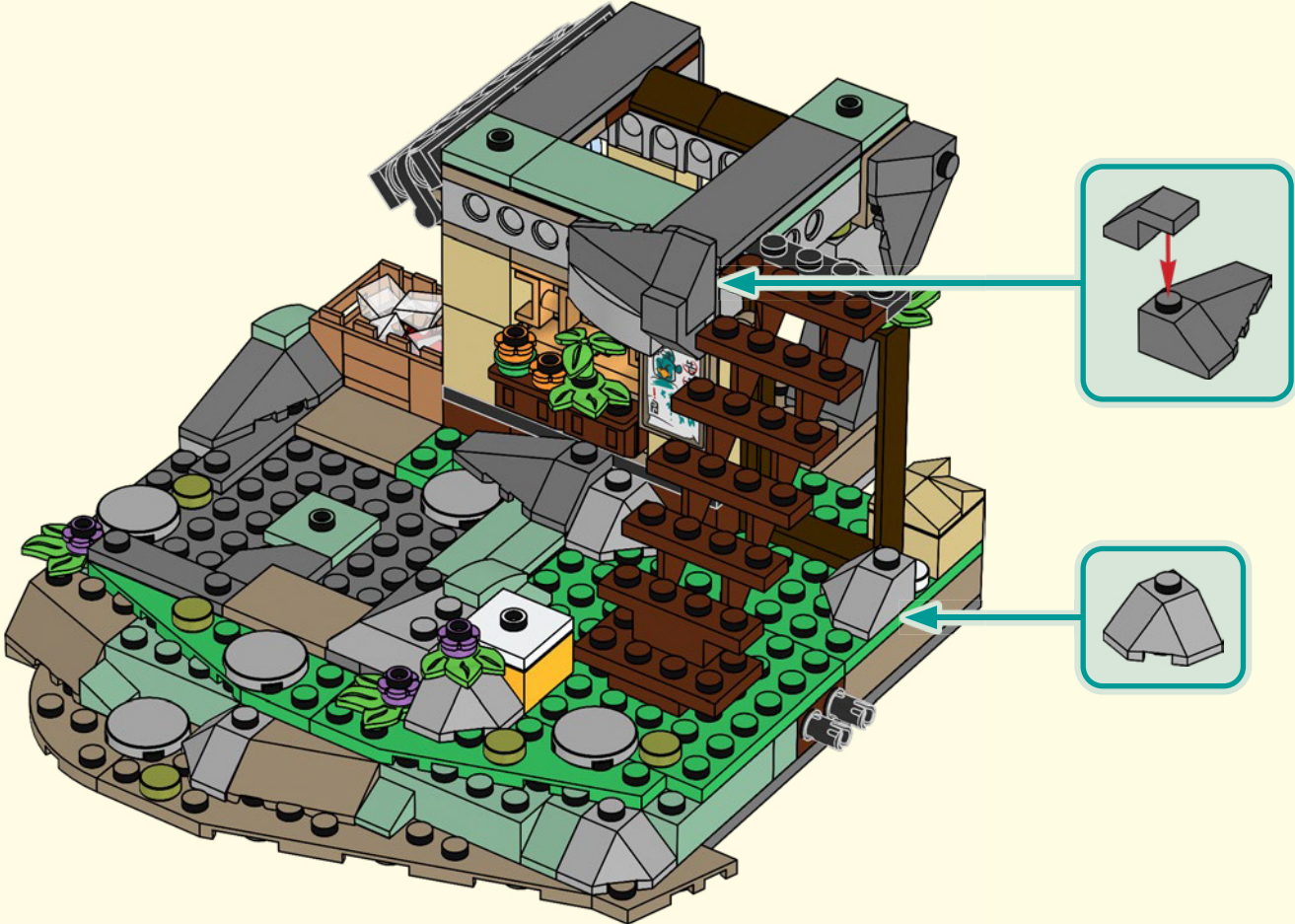



71

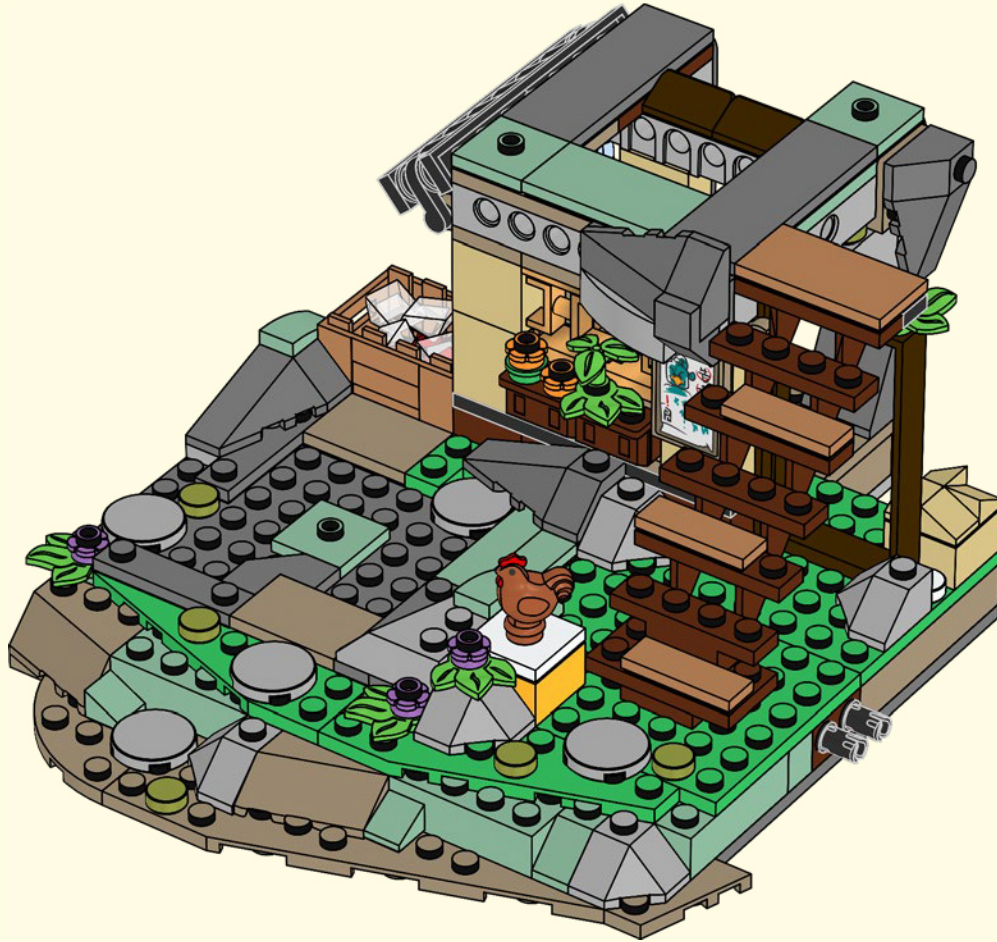

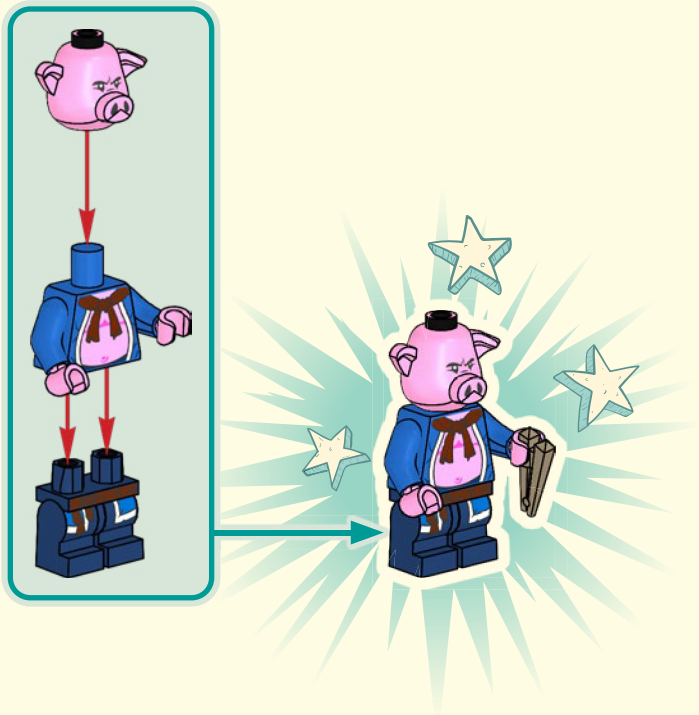
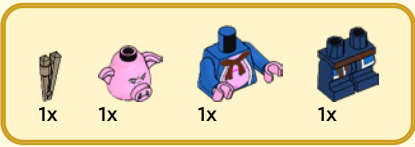

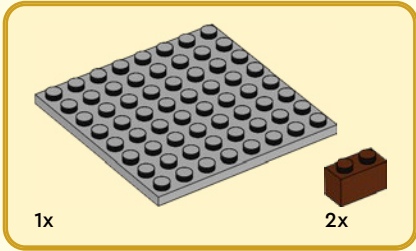

72

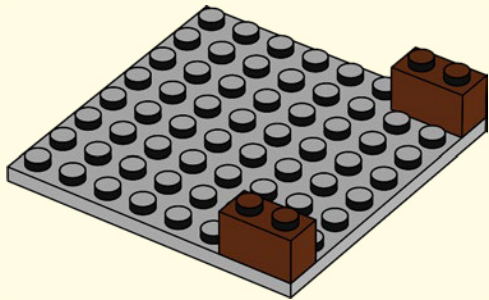

73

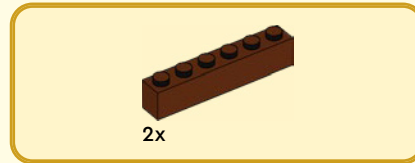
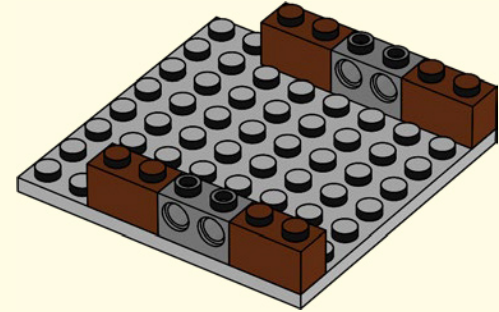

74

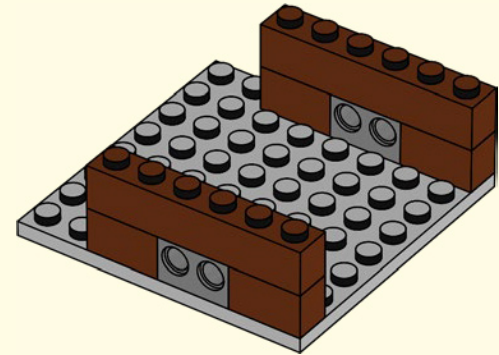

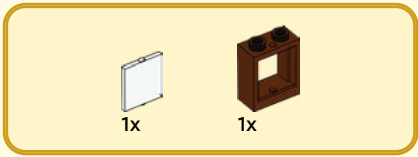

75

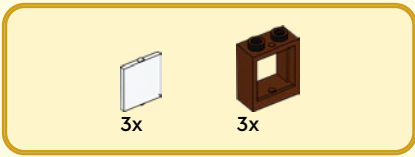
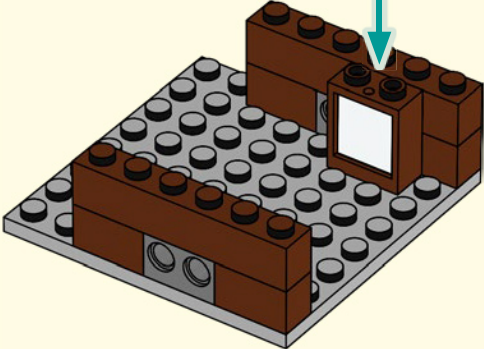
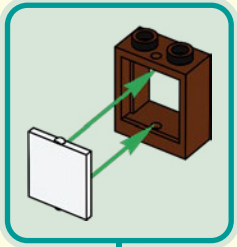

76

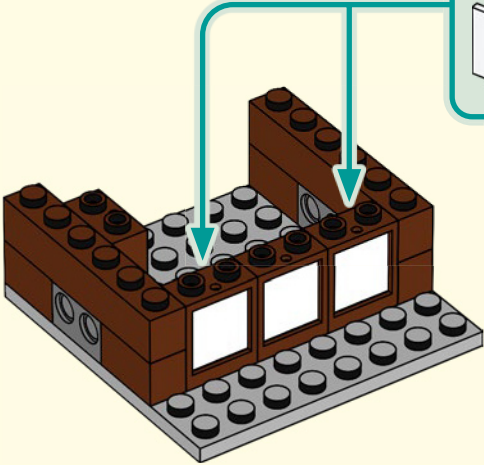
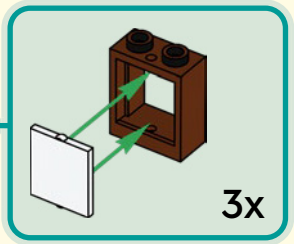

77

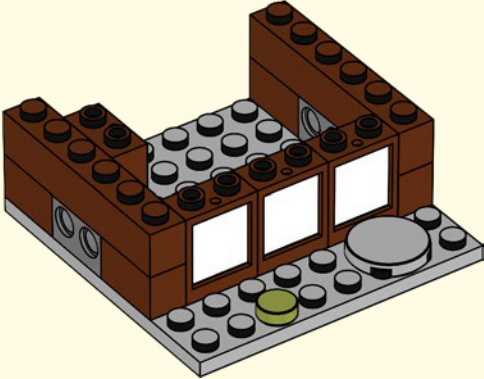





78

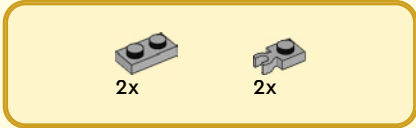
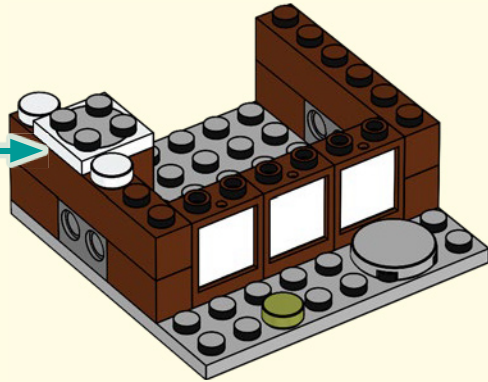
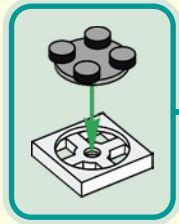

79

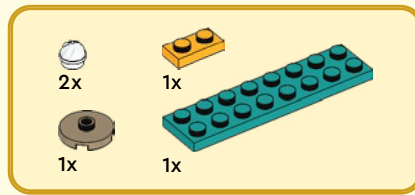
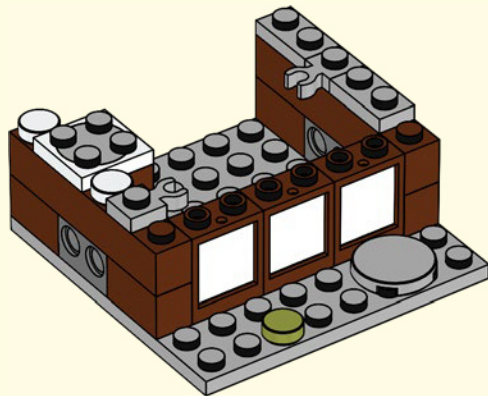

80

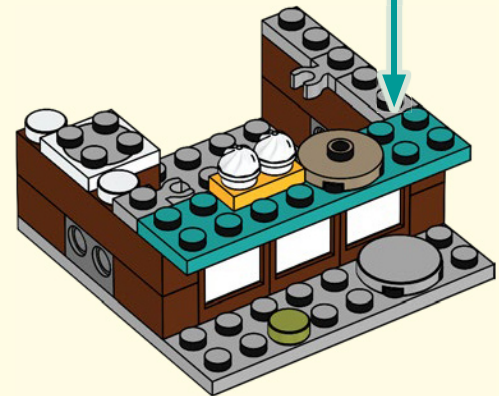
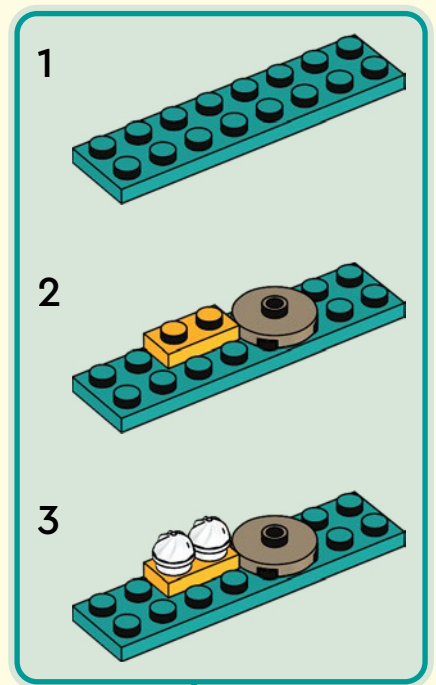

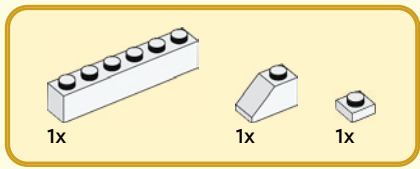

81

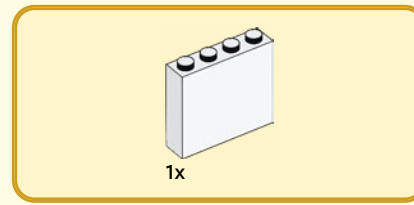
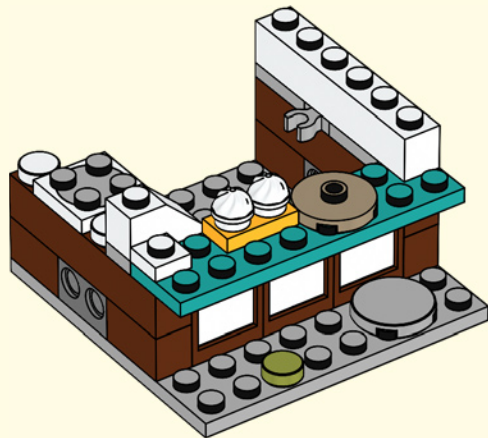

82

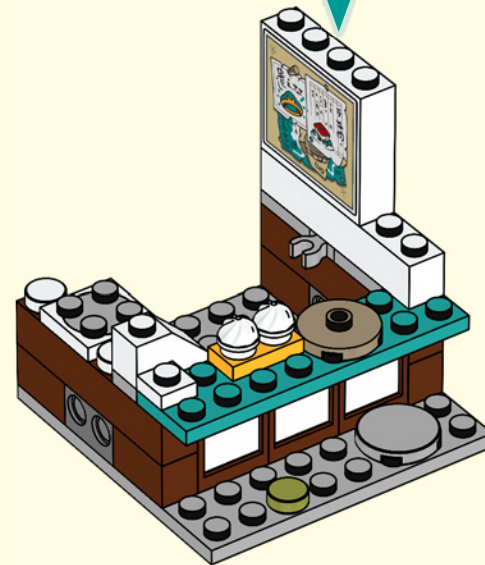
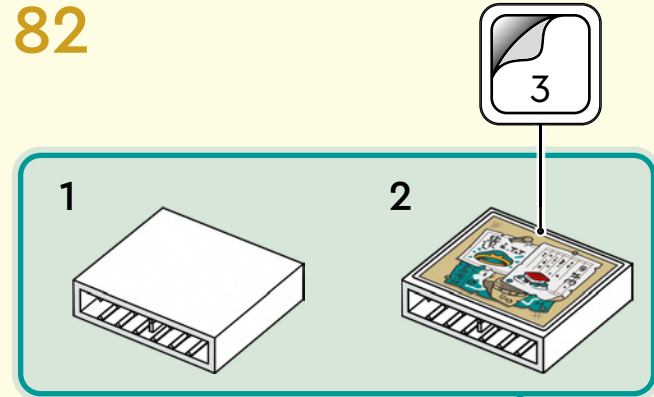

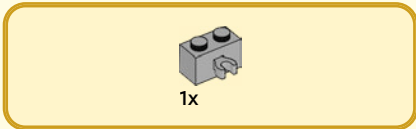

83

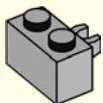

84

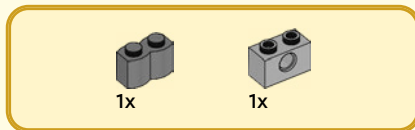
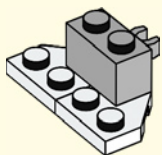

85

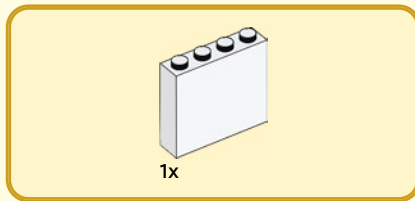
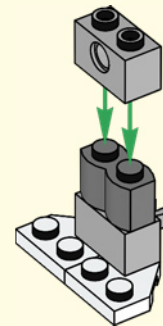

86

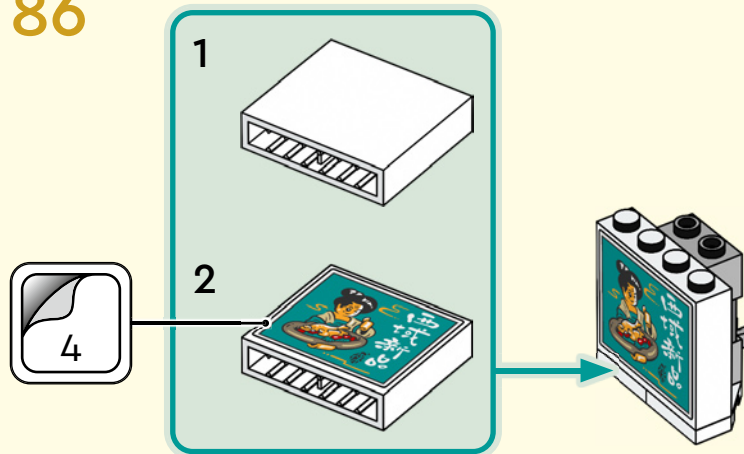



2x

87



1x



1x

88

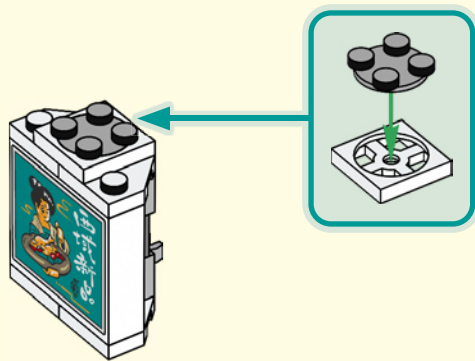

2x



1x

89

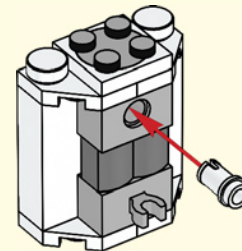
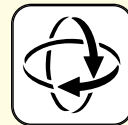

1x



1x

90

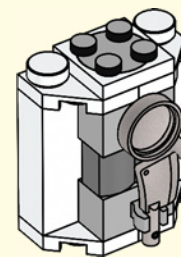

91

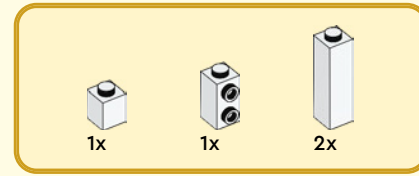
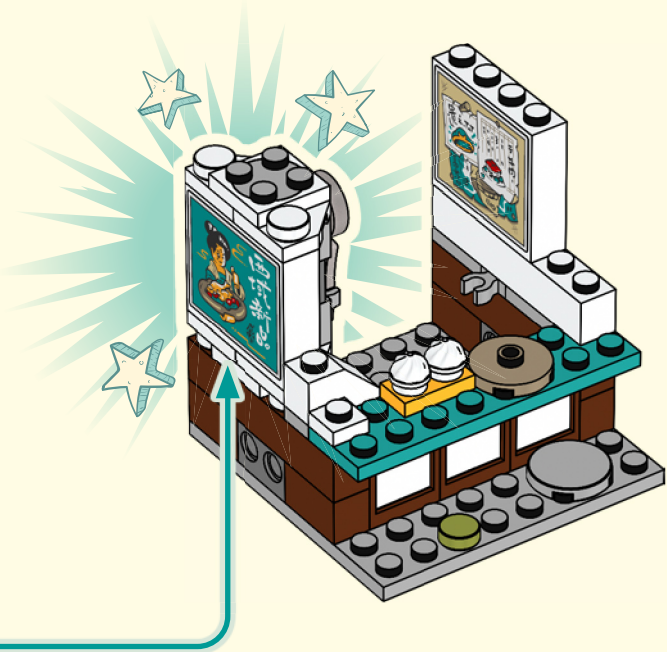

92



2x

2x

2x

# 93

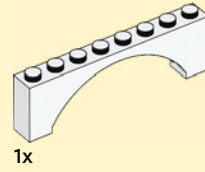
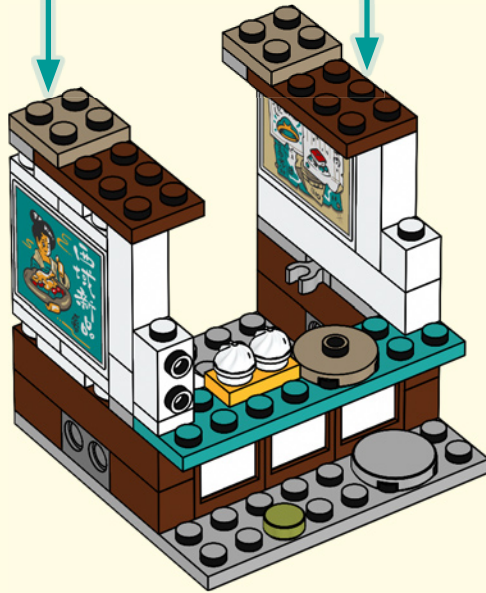
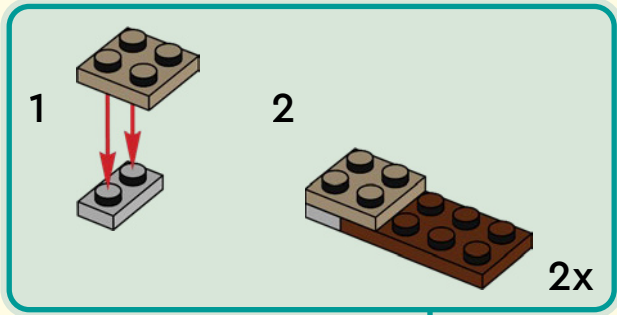

1x

# 94





4x

95

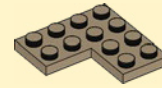

2x

96



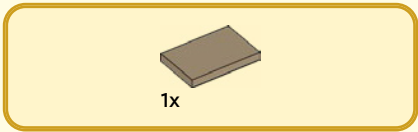

97

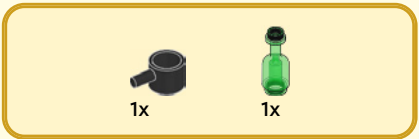
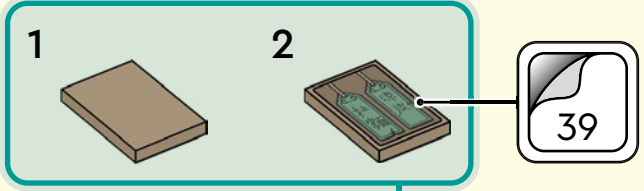

98







99

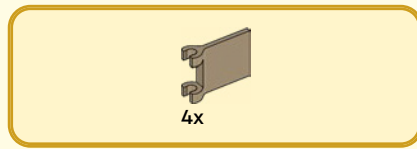
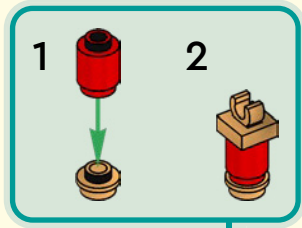

100

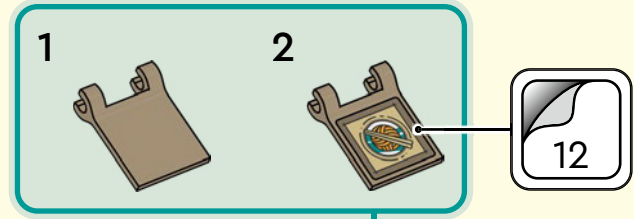



2x

101





102

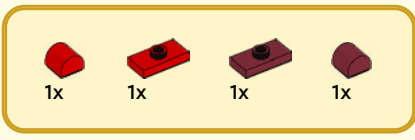

103





104



105



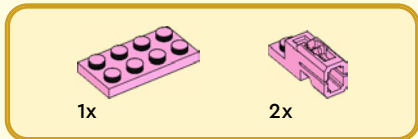
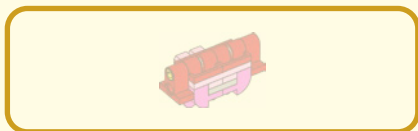

106

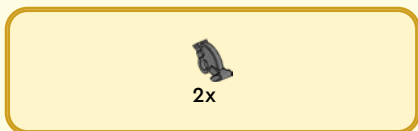
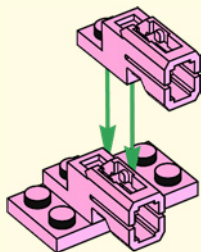

107

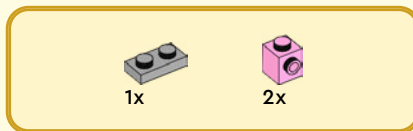
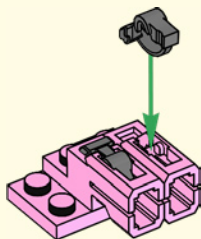

108

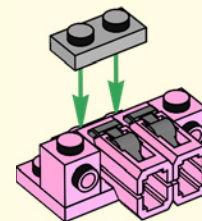

109

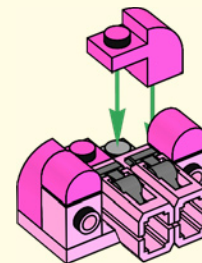

2x

110

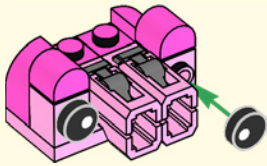

2x

1x

111

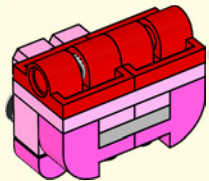

1

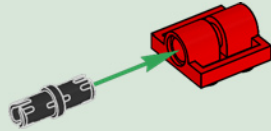

2

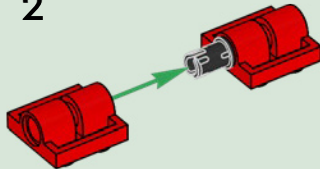

1x

1x

112

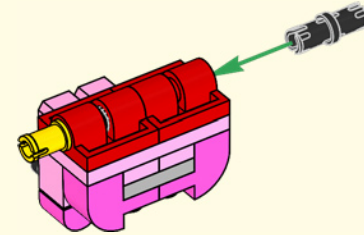

2x

113

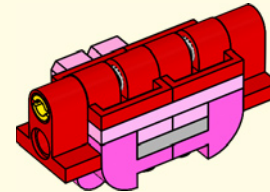

114



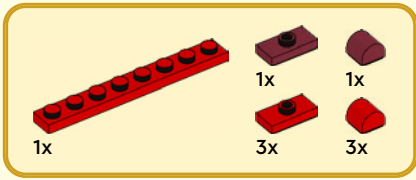

# 115

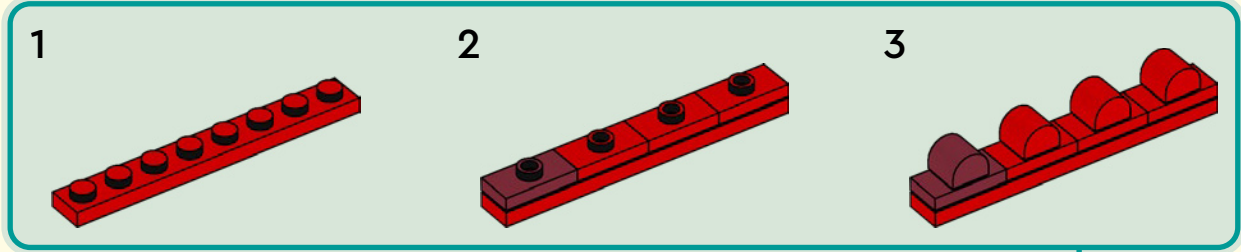



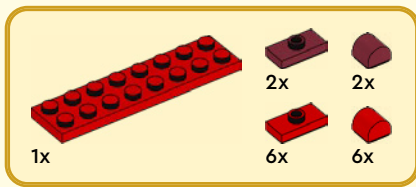

116

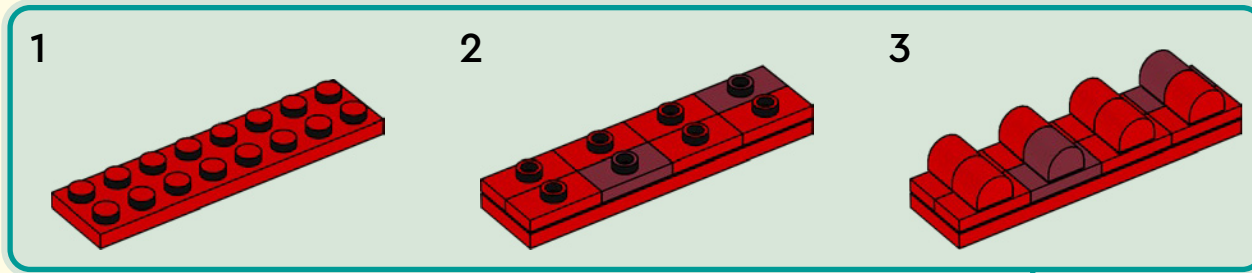

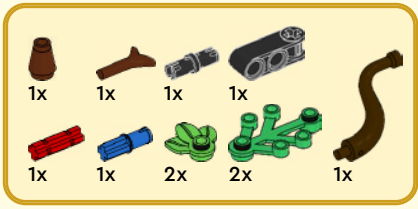

117

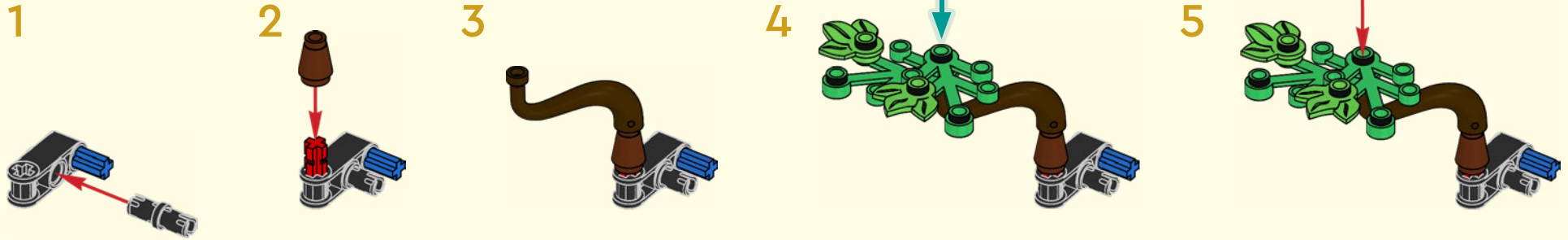
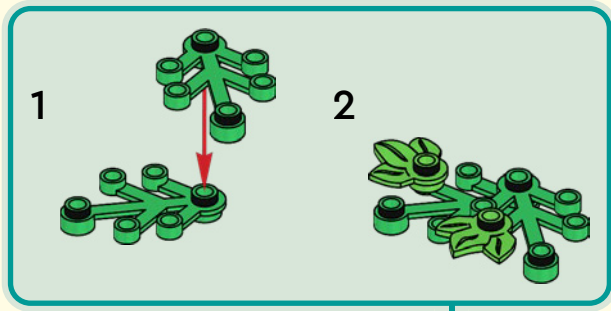

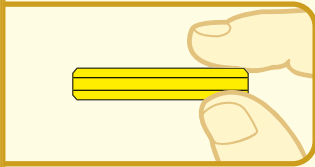
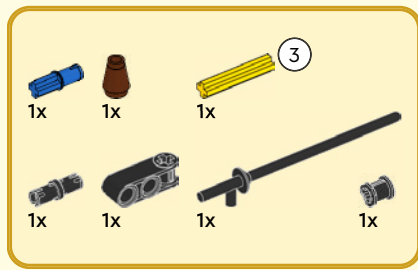

118

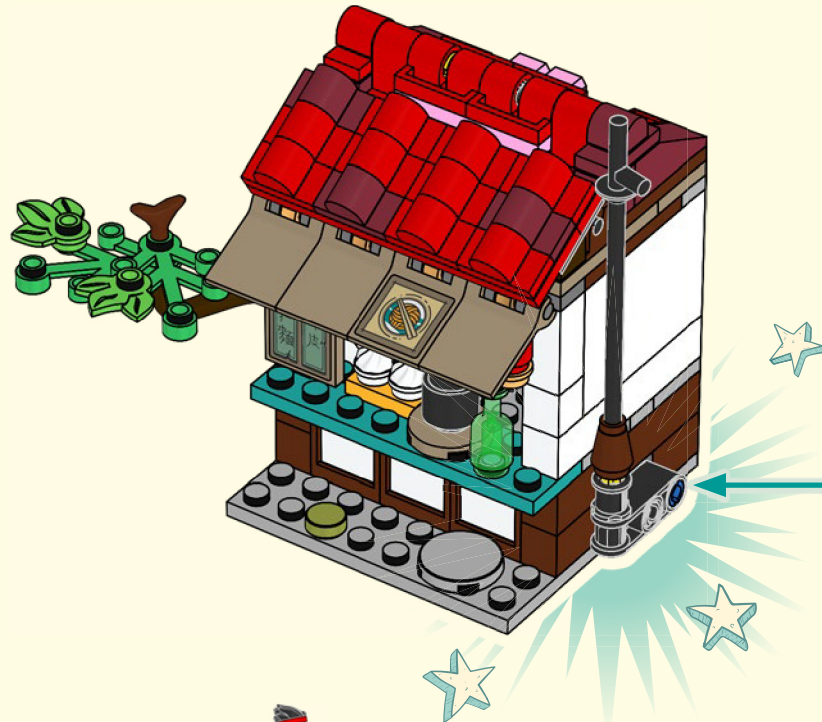
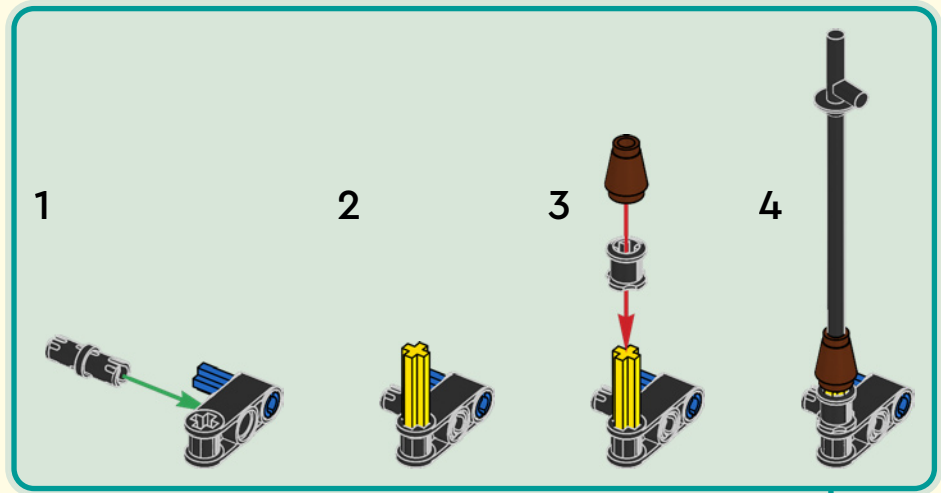

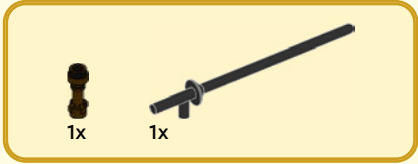

119

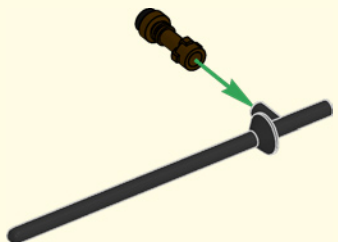

120

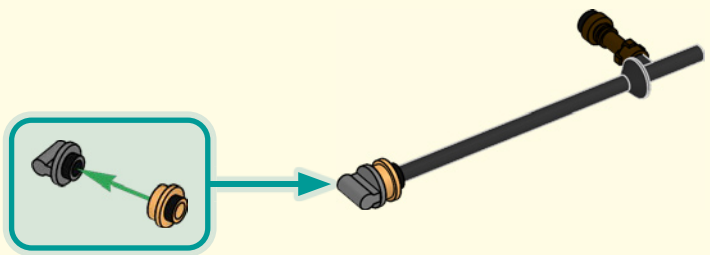

121

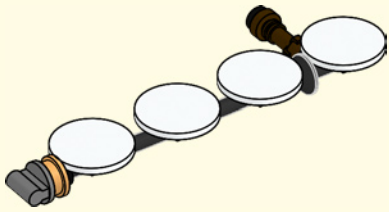

122

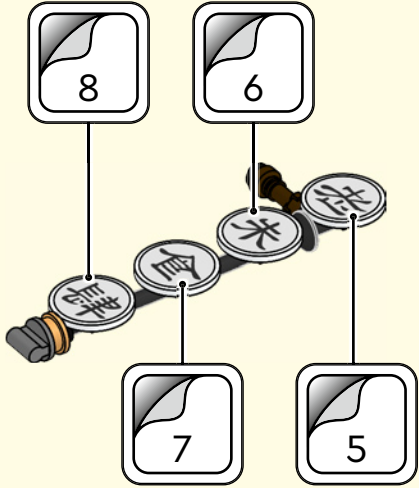



123

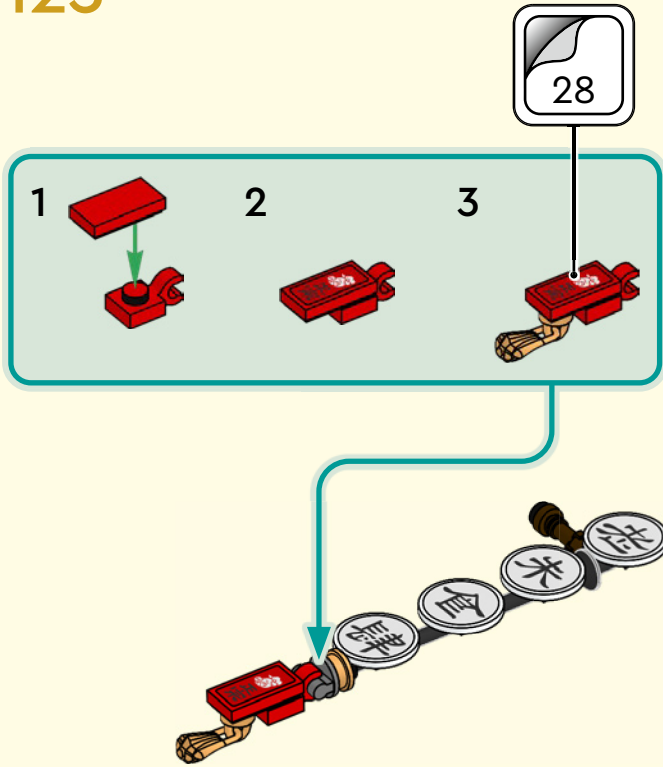

124

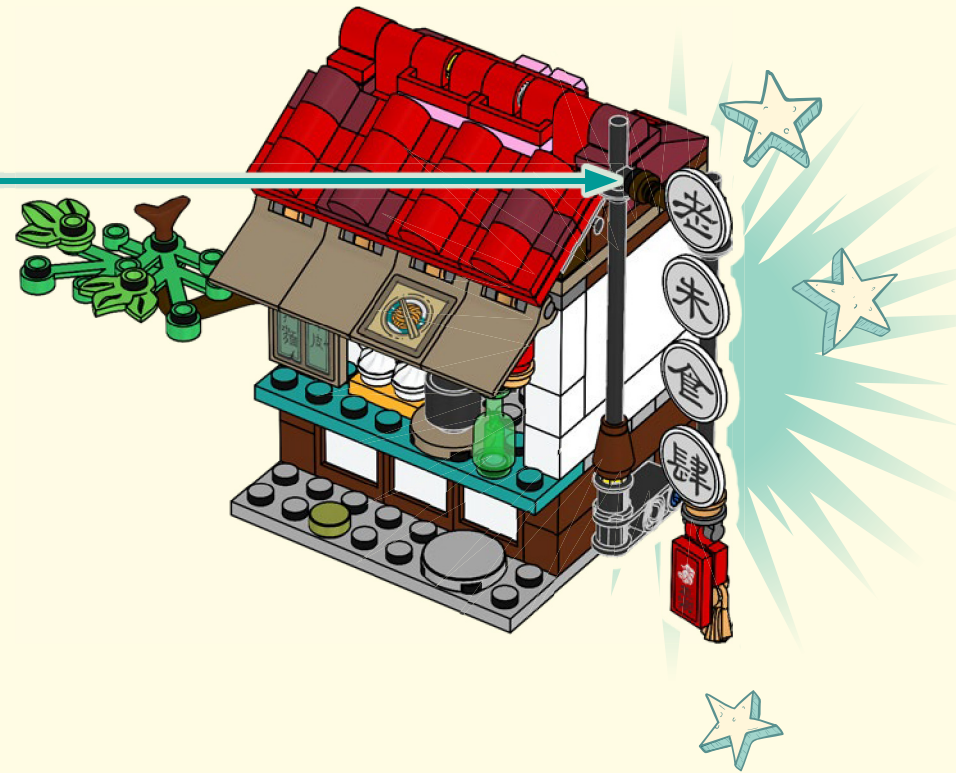

4x

125

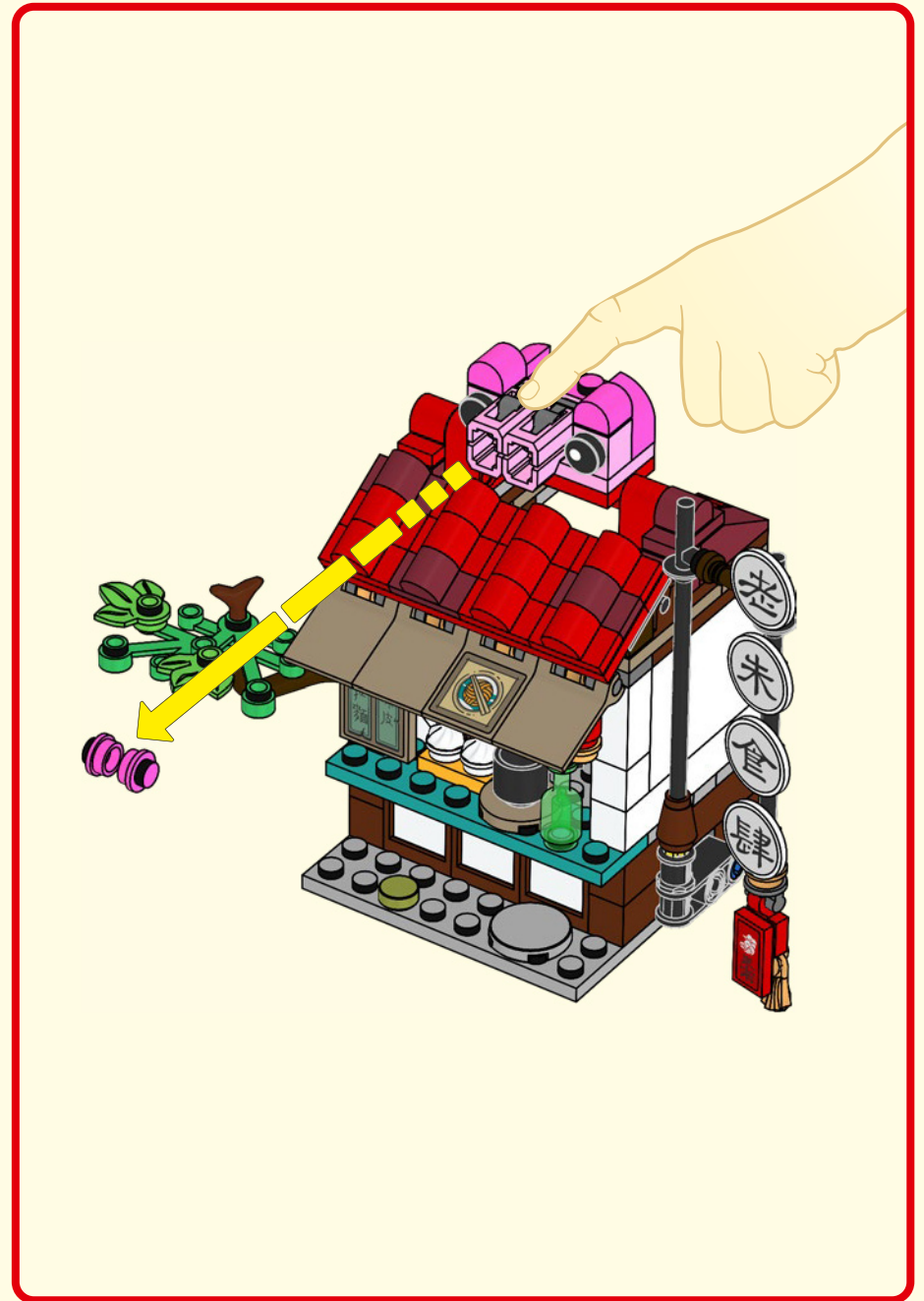
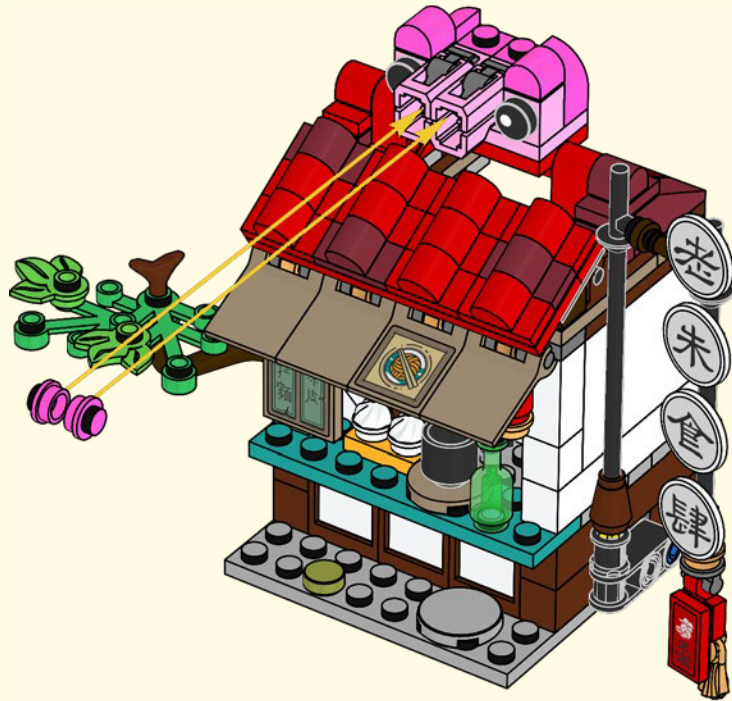



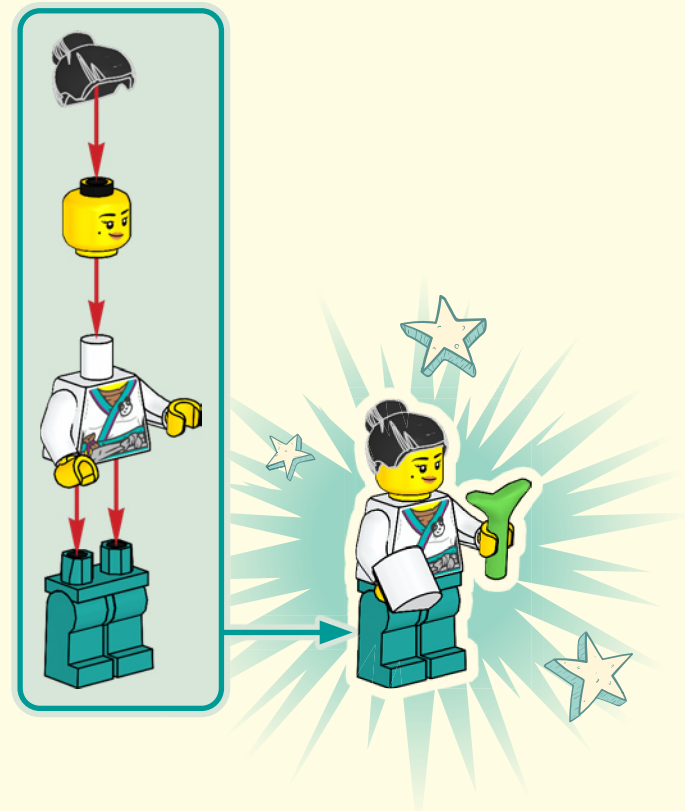



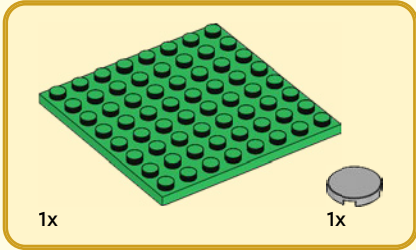

127

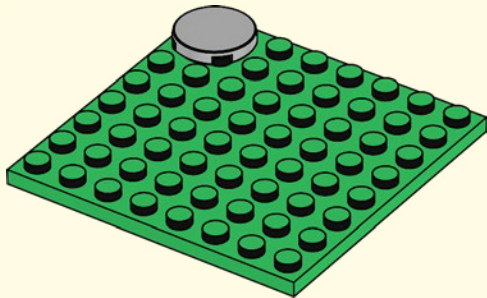

128

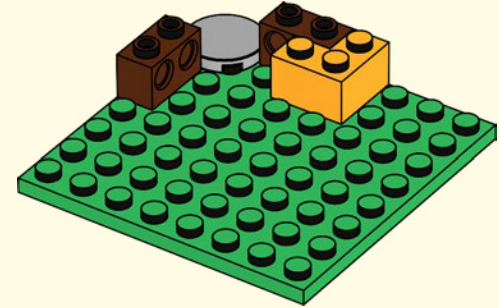

129

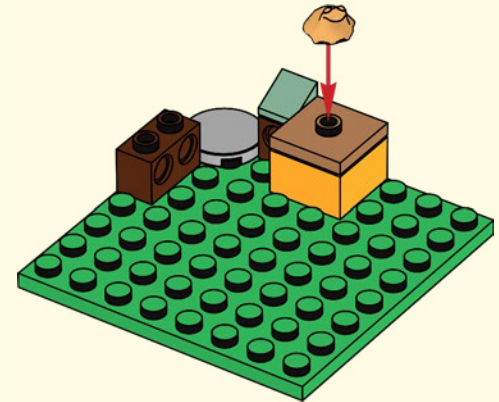

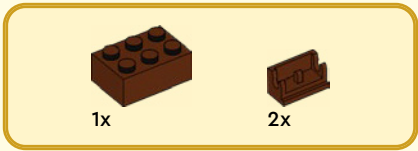

130

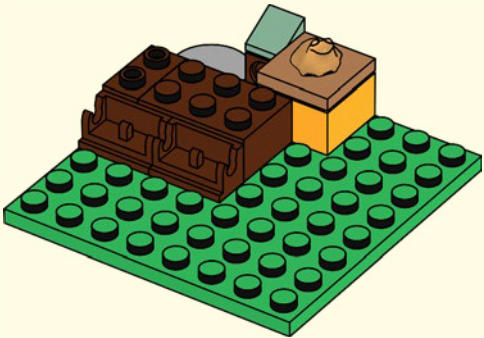

131

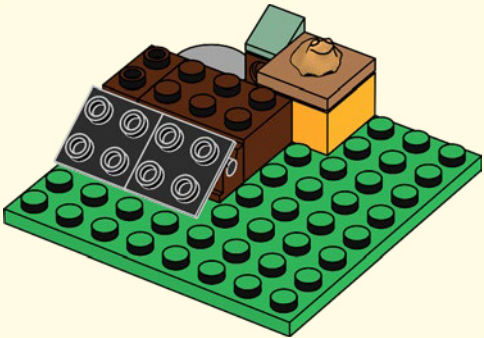



132

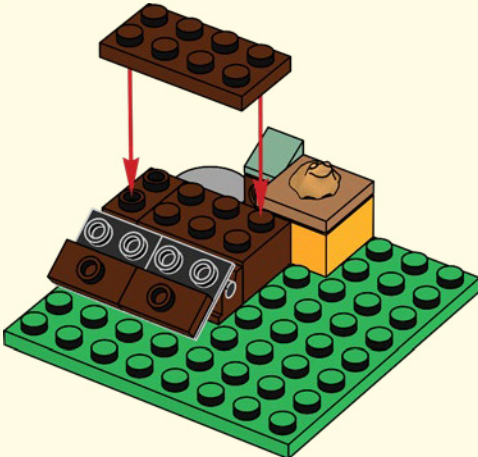

133

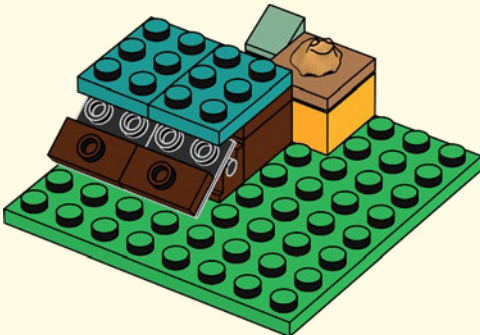



134

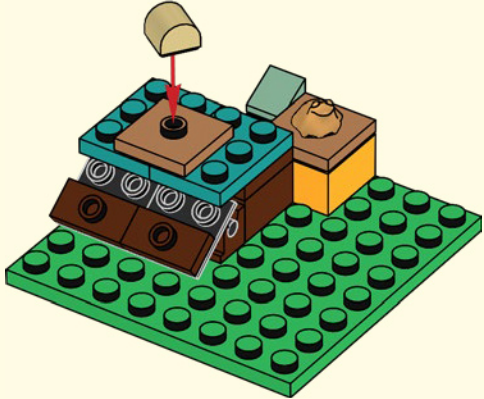

135

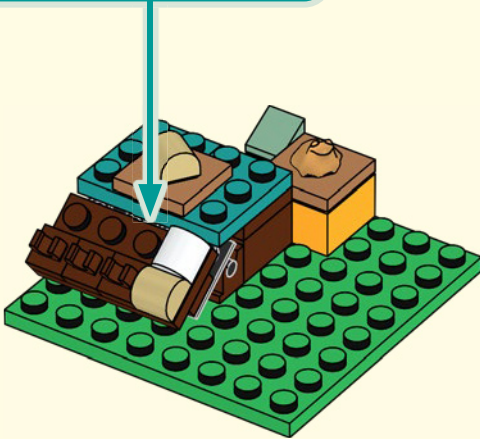
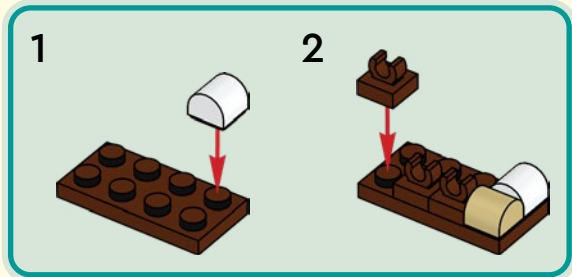



136

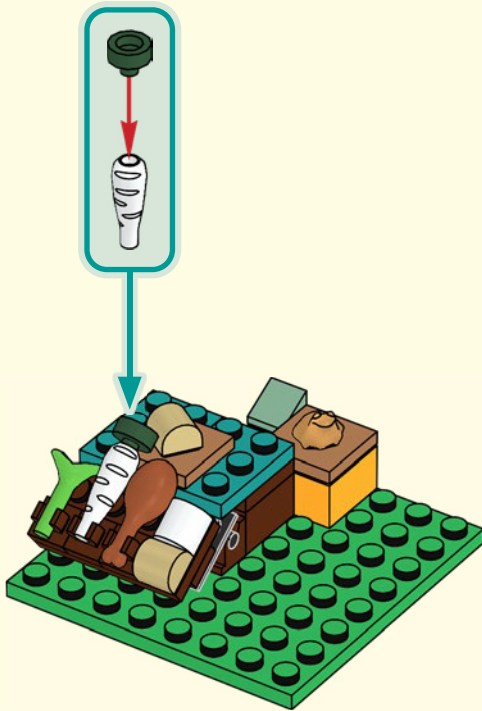

137

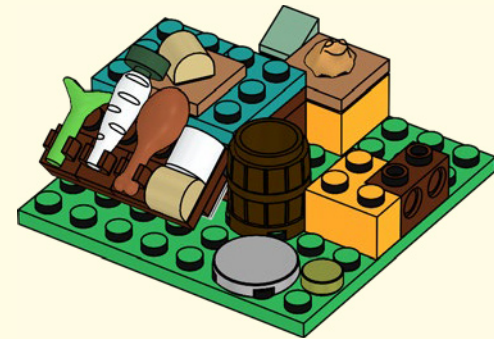



1x



1x



1x

# 138



1x

# 139



4x

# 140



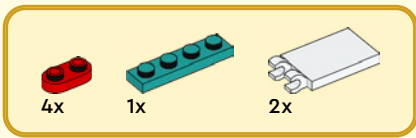

141

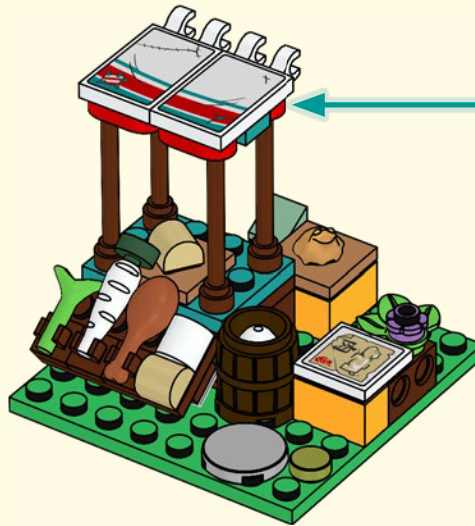
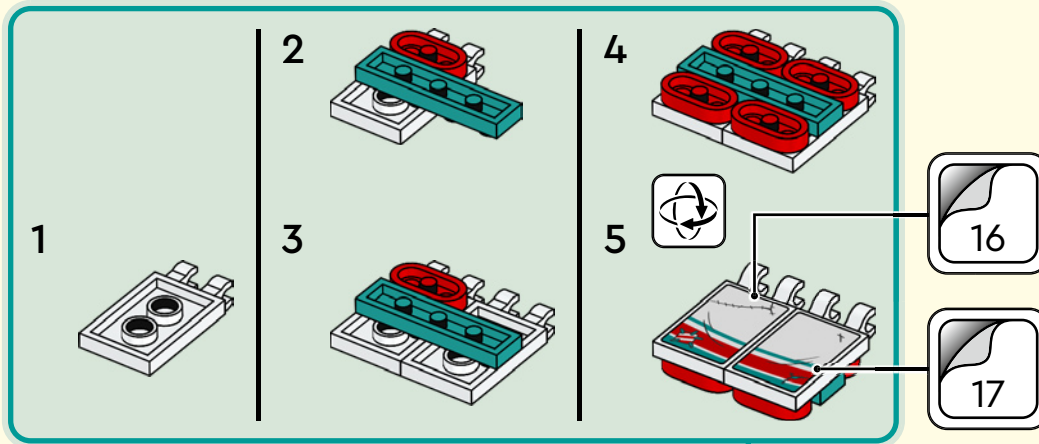



142

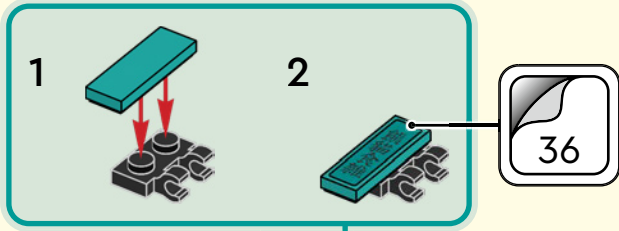



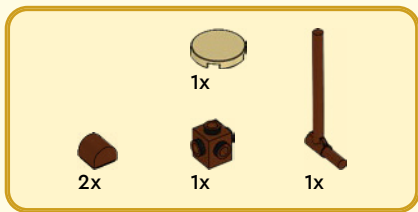

143

1

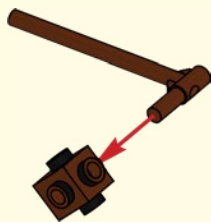

2



3



4





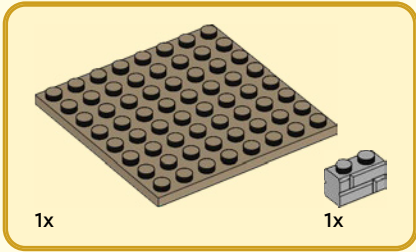
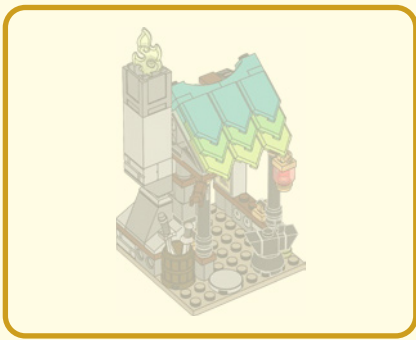

145

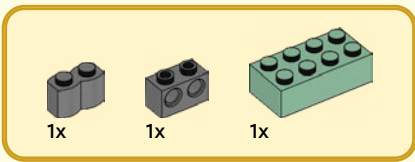
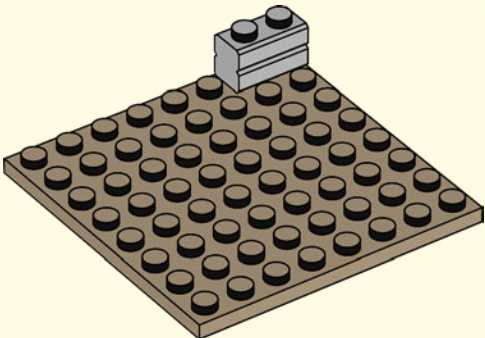

146

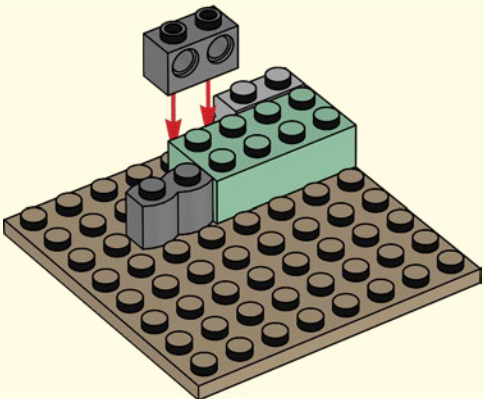

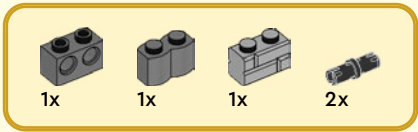

147

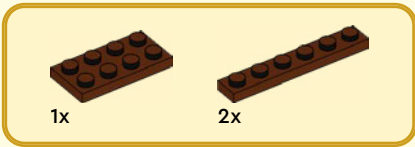
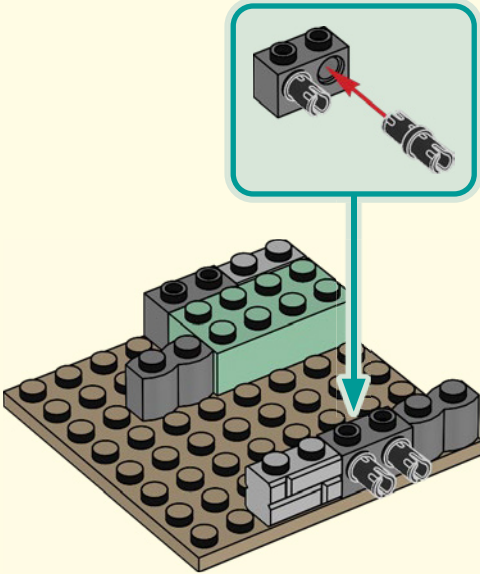

148

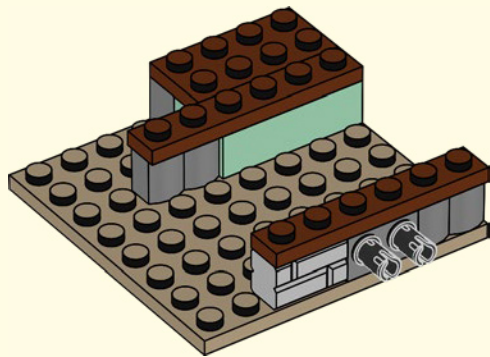



2x



2x

149

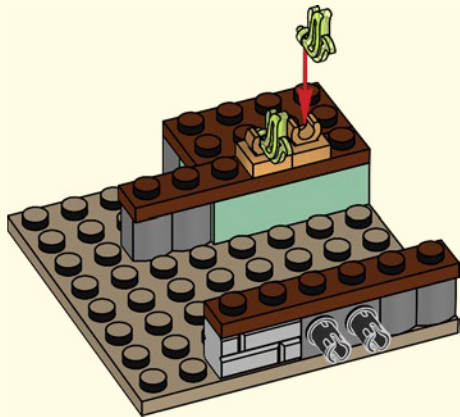

2x



1x

150

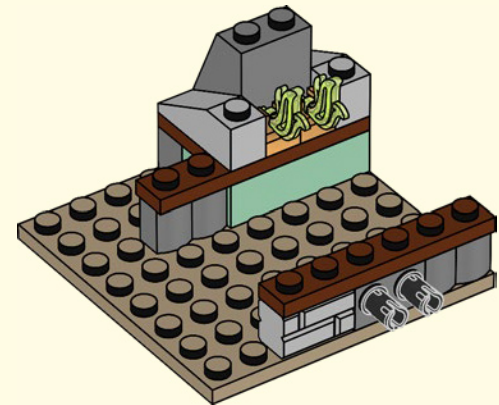



1x



2x

# 151

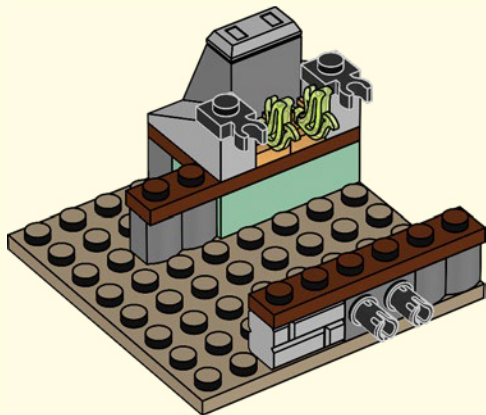

1x



1x



1x



1x

# 152

1

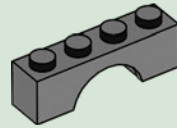

2

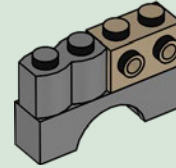

3

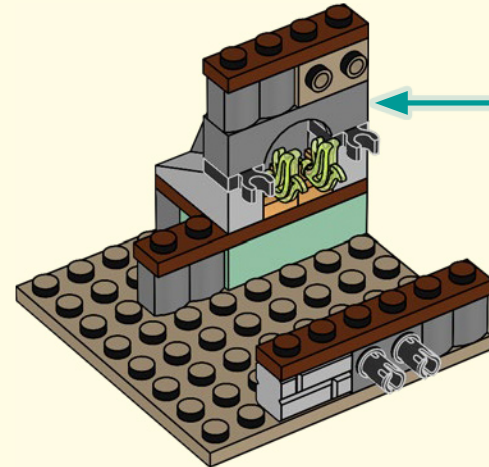
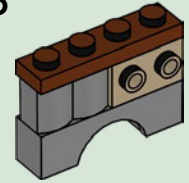



# 153

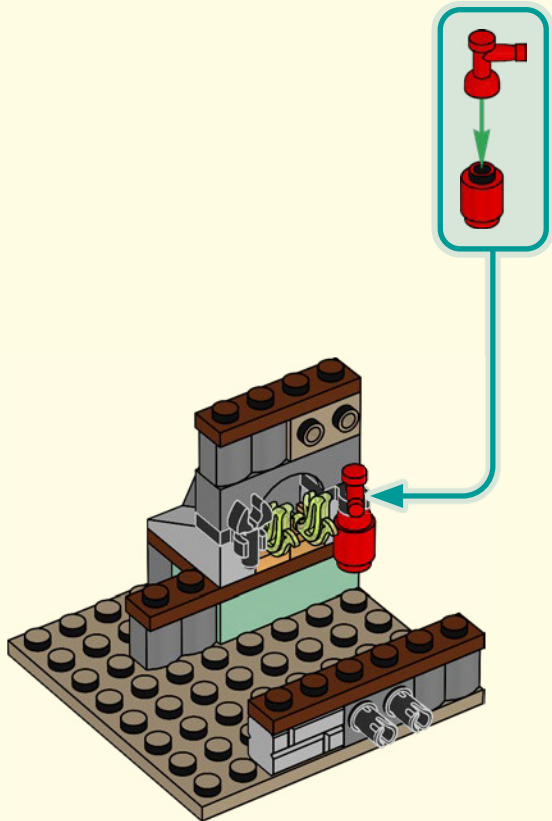

# 154

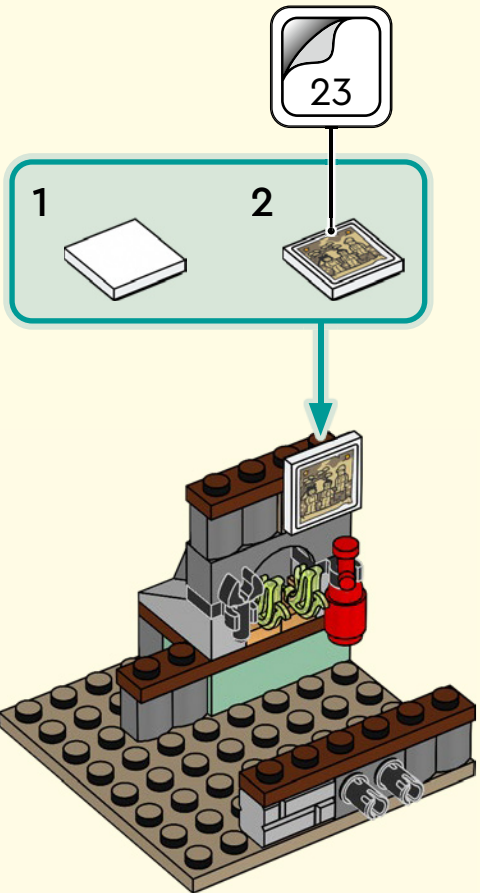

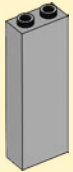

1x

155

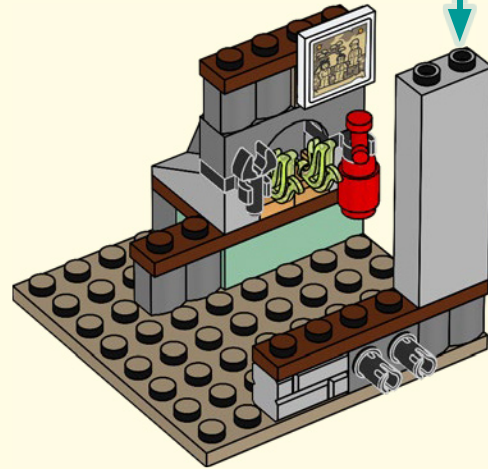
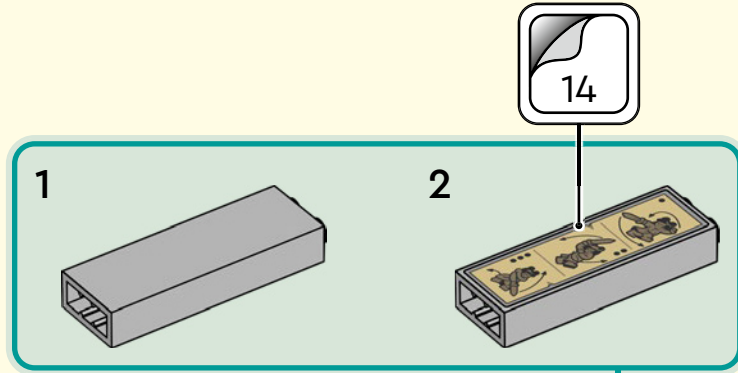





2x



1x

156

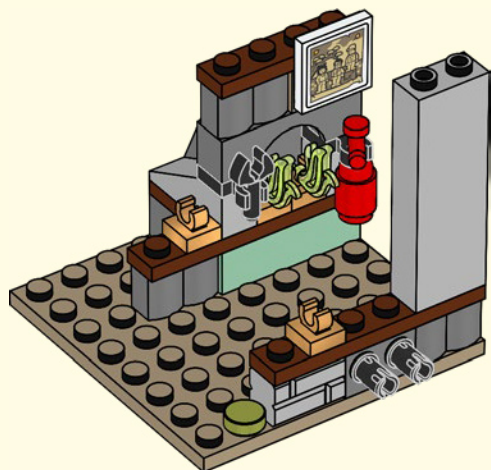

2x

157

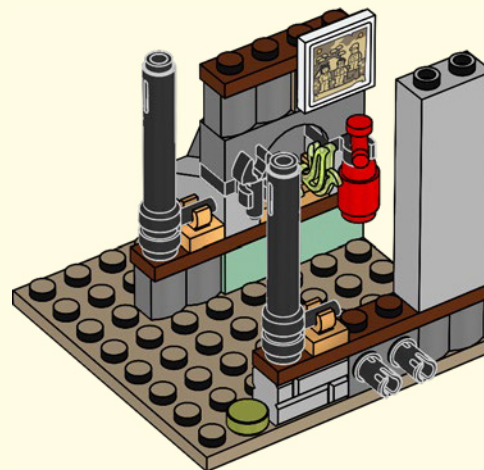

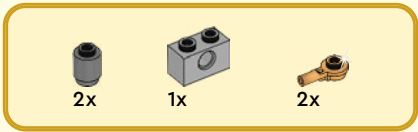

# 158

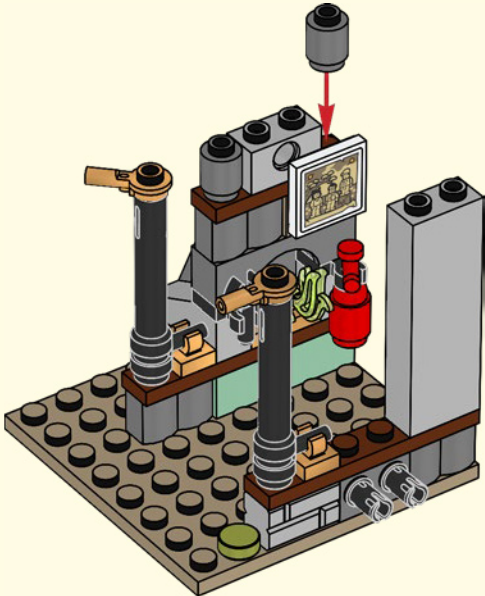

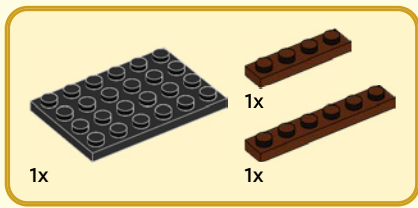

159

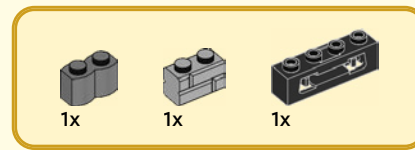
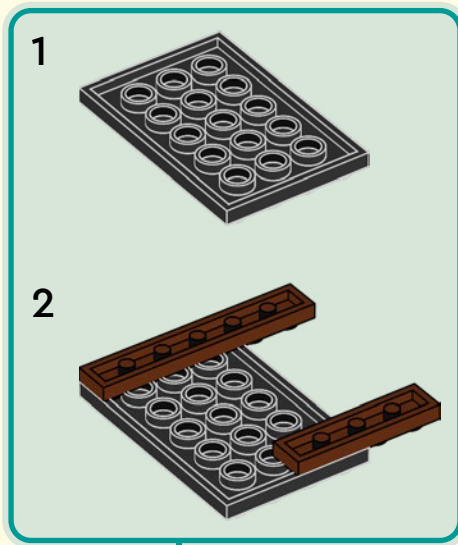

160

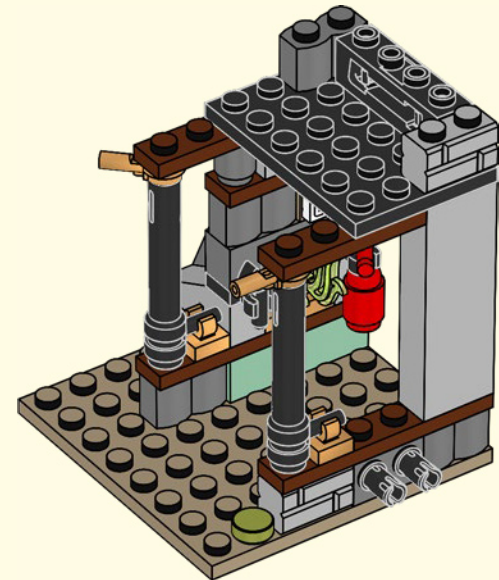



4x

161





162

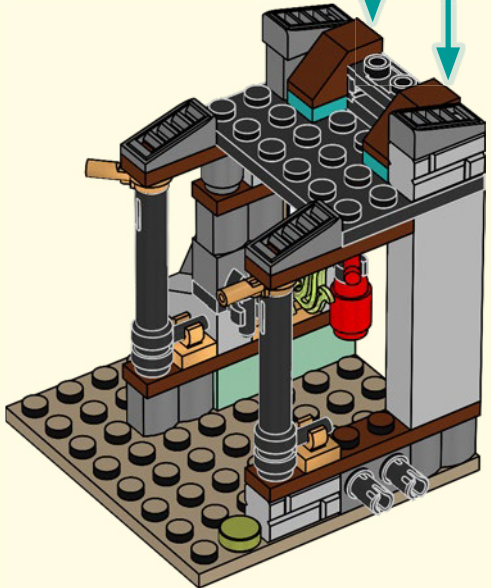
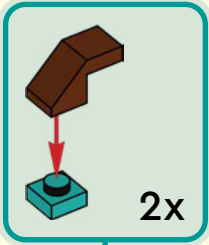

163

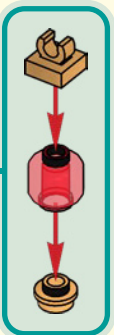
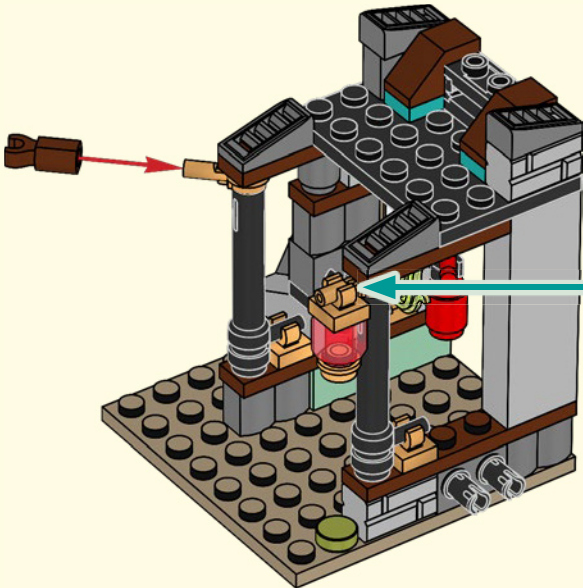

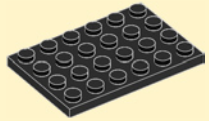
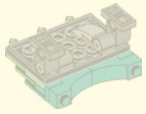

1x

164

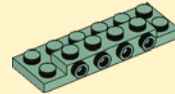
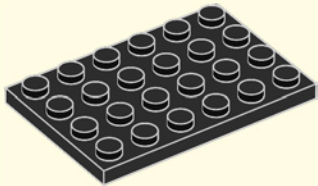

1x

165

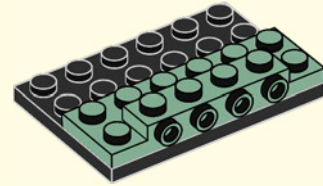

2x



3x

166

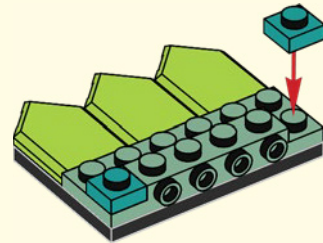



167

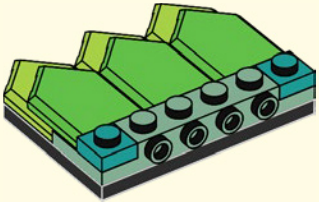

168

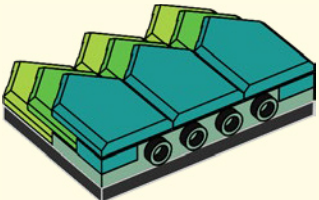

169

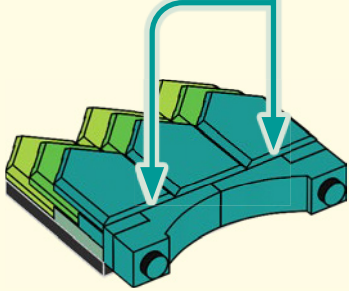
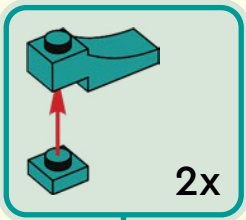

170

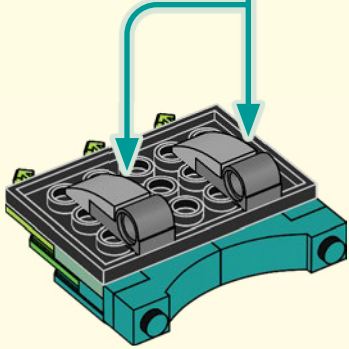
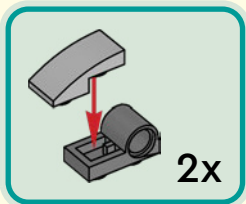



2x

171

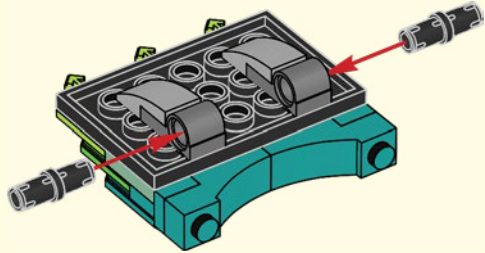

2x

172

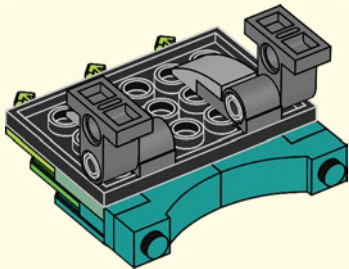

173





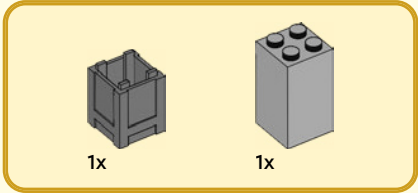
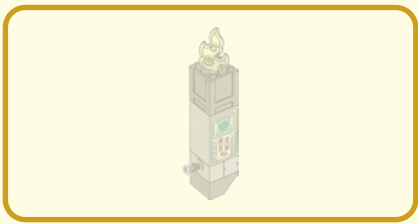

174

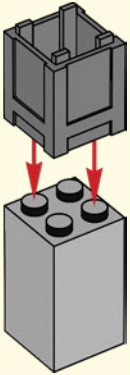

175

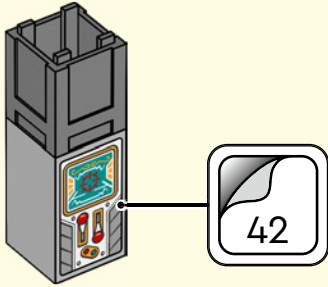



176

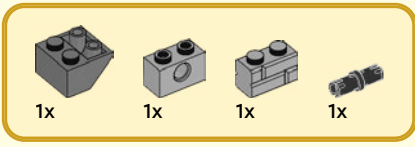
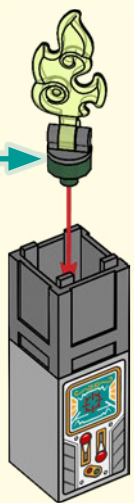
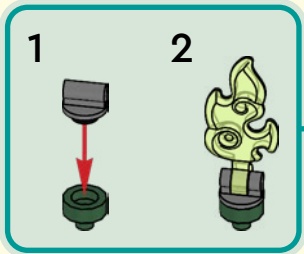

177

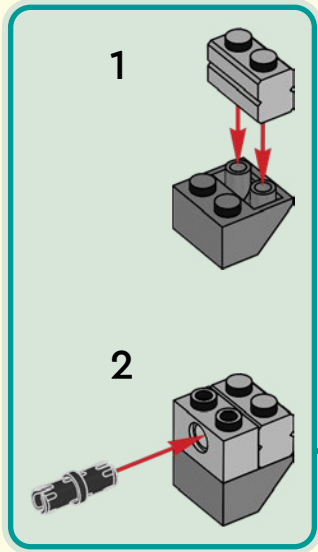

178



179





1x



2x



1x

# 180

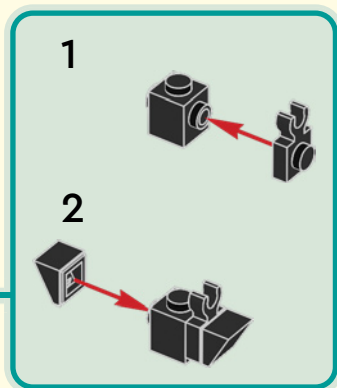

1x



1x

# 181





182

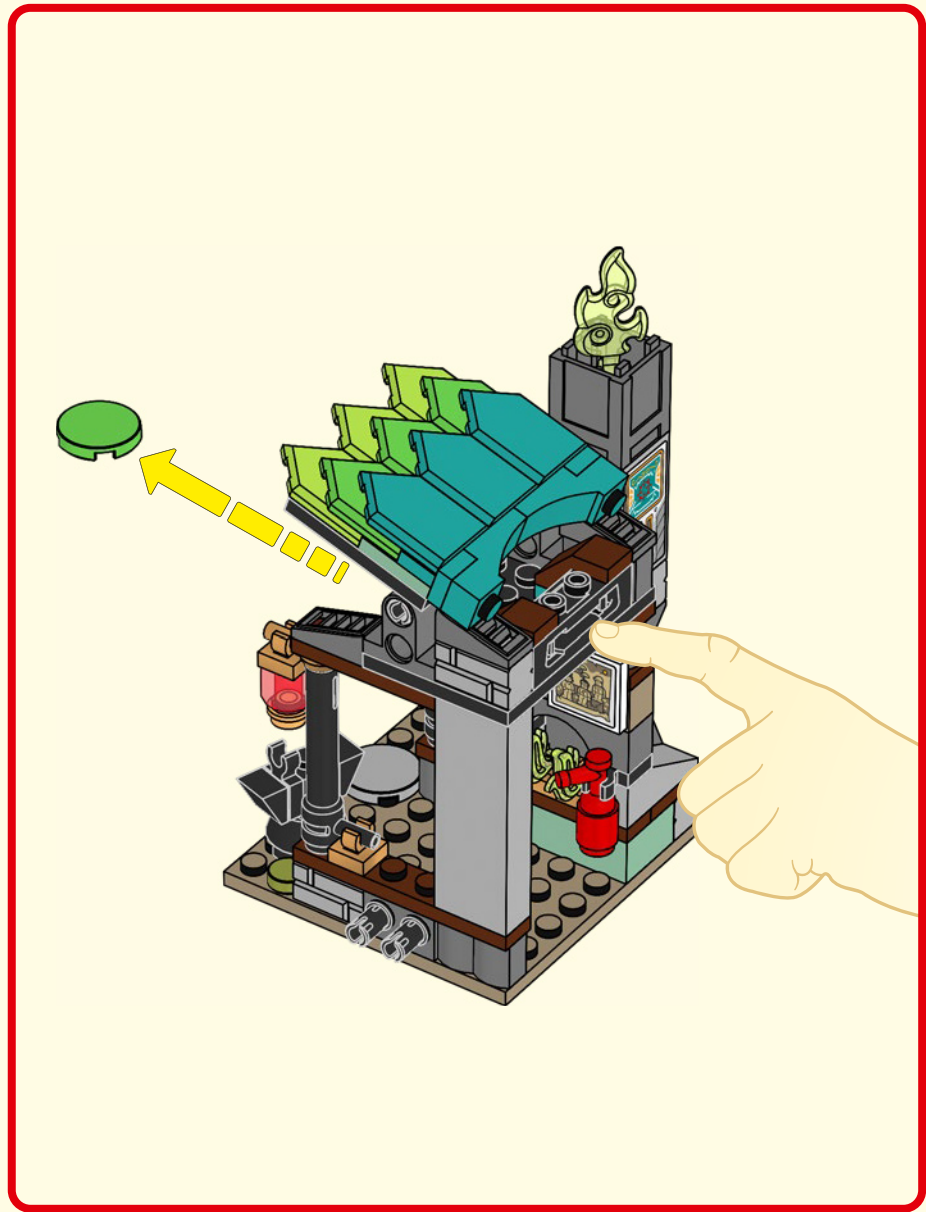
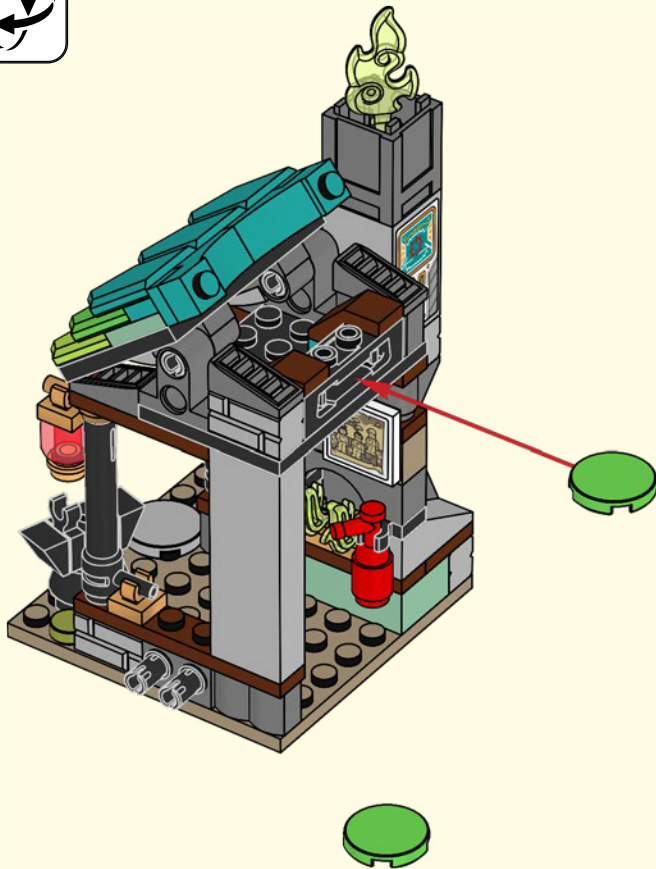





# MONKIE KID 悟空小侠™



80040



80043



80045



80041

## COMBINE 80036+80044

Combine 80036 + 80044  
Kombinierbar mit 80036 und 80044  
Combinez les sets 80036 et 80044  
Combina 80036 + 80044  
可将 80036 和 80044 组合玩乐  
Объедините наборы 80036 + 80044  
Połącz 80036 + 80044  
Zkombinujte stavebnice 80036 a 80044  
Skombinujte stavebnice 80036 a 80044  
Kombinál a 80036-os és 80044-es szettel!  
Combină 80036 + 80044  
Комбинируйте 80036 + 80044  
Savieno komplektus 80036 un 80044  
Sobita kokku komplektid 80036 ja 80044  
Sujunkite 80036 + 80044



**YOU COULD WIN**



Scan this QR code or go to **LEGO.COM/PRODUCTFEEDBACK** and give us your short feedback about this LEGO® set for a chance to win a cool LEGO prize.

Terms and Conditions apply\*

**DE: Du könntest GEWINNEN.** Es gelten die Teilnahmebedingungen\* **FR: Tu pourrais GAGNER.** Des conditions s'appliquent\* **IT: Potresti VINCERE tu.** Termini e condizioni sono applicabili\* **ES: Puedes GANAR.** Aplican términos y condiciones\* **PT: Poderá GANHAR.** Aplicam-se termos e condições\* **JA: プレゼント付き! 利用規約が適用されます\*** **ZH: 轻松获奖. 条款和条件适用\*** **KO: 상품의 주인이 되어보세요. 소정의 약관이 적용됩니다\*** **RU: Вы можете ВЫИГРАТЬ.** Действуют положения и условия\* **PL: Szansa na WYGRANĄ.** Obowiązują warunki korzystania\* **CS: Máte šanci VYHRÁT.** Platí všeobecné smluvní podmínky\* **SK: Máte šancu VYHRAŤ.** Platia všeobecné zmluvné podmienky\* **HU: TE IS NYERHETSZ.** Felhasználási feltételek érvényesek\* **RO: Ai putea CÂȘTIGA.** Se aplică termenii și condițiile\* **BG: Можете да СПЕЧЕЛИТЕ.** Има определени правила и условия\* **LV: Tu vari LAIMĒT.** Ir spēkā noteikumi un nosacījumi.\* **ET: Sul on võimalus VÕITA.** Kehtivad tingimused\* **LT: Jūs galite LAIMĖTI.** Taikomos sąlygos\*

\*[LEGO.com/productfeedback-terms](https://www.lego.com/productfeedback-terms)