



# MONKIE KID 悟空小侠™

80024

1



Booklet available in English on  
Heft in deutscher Sprache erhältlich auf  
Livret disponible en français sur  
Libretto disponibile in italiano su

Folleto disponibile en español en  
如需中文版手册, 请访问  
[LEGO.com/service/buildinginstructions](http://LEGO.com/service/buildinginstructions)



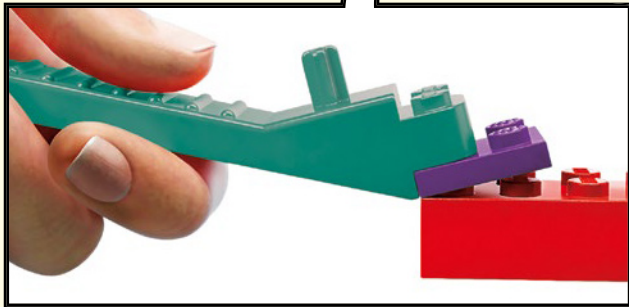
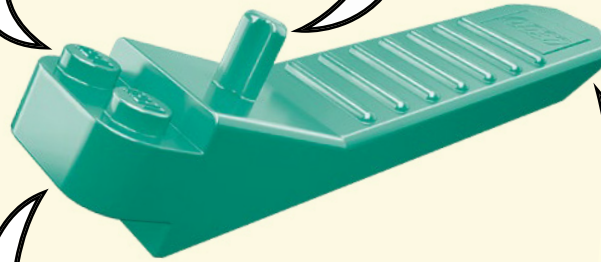
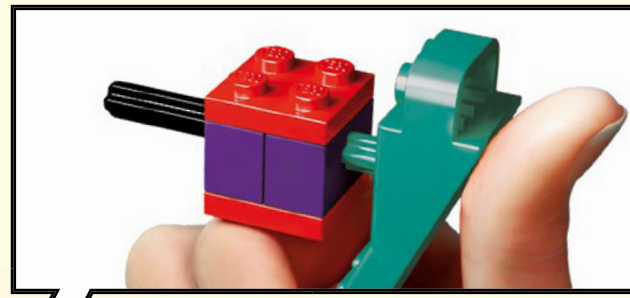
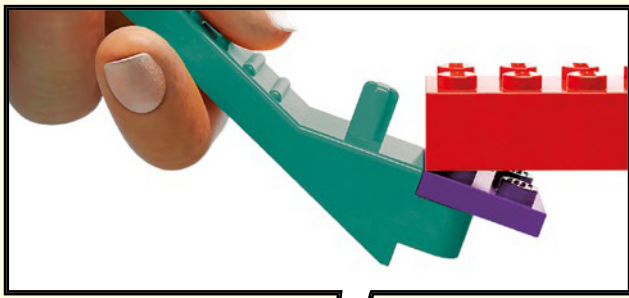

[LEGO.com/brickseparator](https://LEGO.com/brickseparator)





- 1 Scan the code on the front cover  
 Scanne den Code auf der Titelseite  
 Scanne le code sur la page de couverture  
 Scanner le code sur la page couverture  
 Scansiona il codice sulla copertina  
 Escanea el código de la portada  
 Faz scan do código na frente da capa  
 Olvasd be a borítón látható kódot!  
 Noskenē kodu uz priekšējā vāka  
 扫描封面上的二维码



- 2 Get Instructions PLUS  
 Hol dir Instructions PLUS  
 Obtens les instructions PLUS  
 Obtenir les Instructions PLUS  
 Scarica Instructions PLUS  
 Descubre Instructions PLUS  
 Obtém Instrukções PLUS  
 Szerezd be az Instructions PLUS kiegészítőt!  
 Saņem "Instructions PLUS"  
 获取更多说明

**LEGO.com/apps**

Check for compatibility  
 Kompatibilität prüfen  
 Vérifier la compatibilité  
 Controlla la compatibilità  
 Comprueba tu compatibilidad

Verificar a compatibilidade  
 Ellenőrizd a kompatibilitást  
 Pārbaudīt saderību  
 检查兼容性

# THE MAKING OF A LEGEND

INTERVIEW WITH LEGO® FLOWER FRUIT MOUNTAIN DESIGNER LIN LI-YU

## WHERE IT ALL BEGAN

"Among the line-up of cool and exciting LEGO® Monkie Kid™ sets, we wanted to make something really special to celebrate the epic stories of the great Monkey King.

In a legendary world, filled with mystical locations, we all agreed upon Flower Fruit Mountain as an essential landmark from the original story. After all...it's where Monkey King came to life and the epic adventure began!"

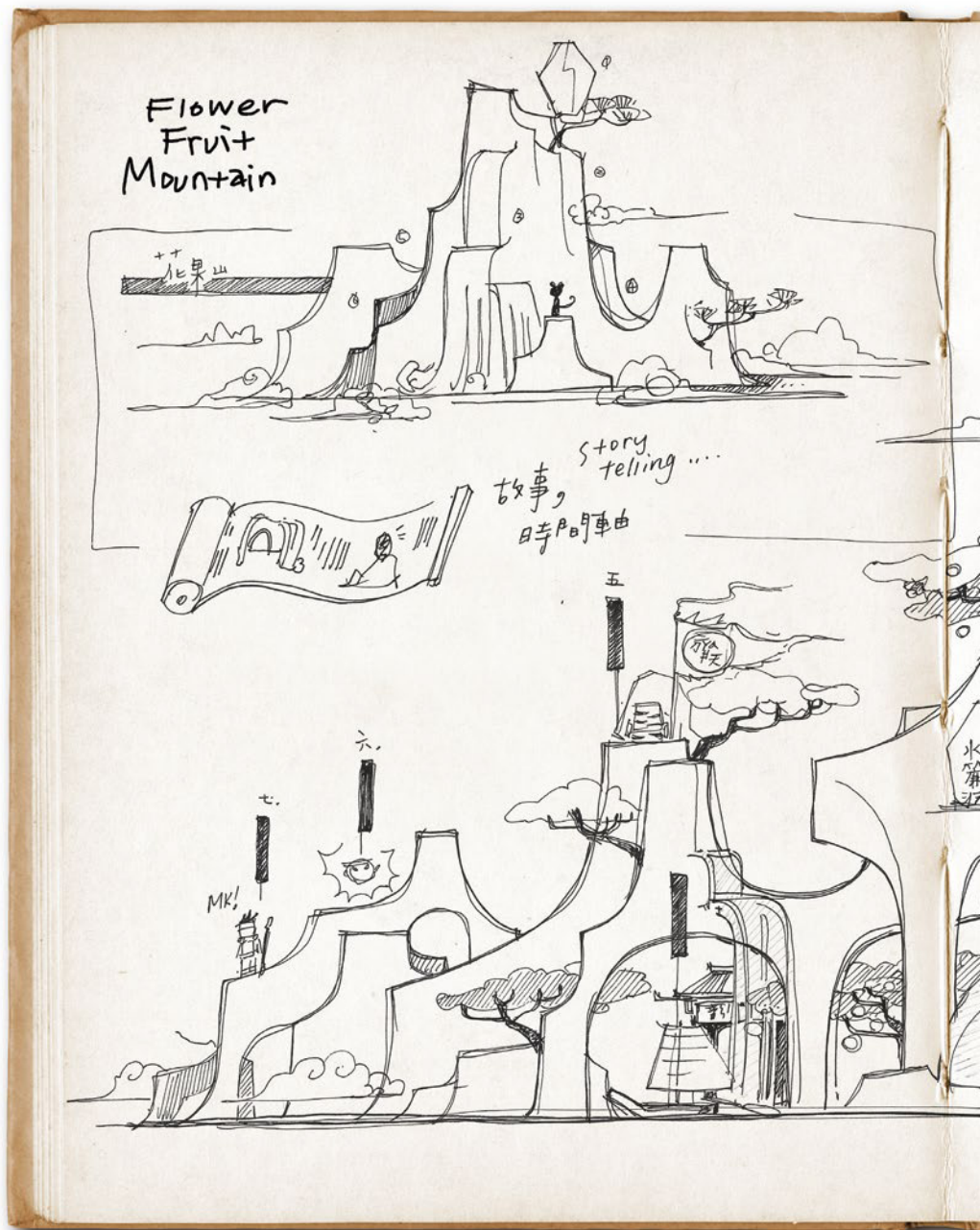



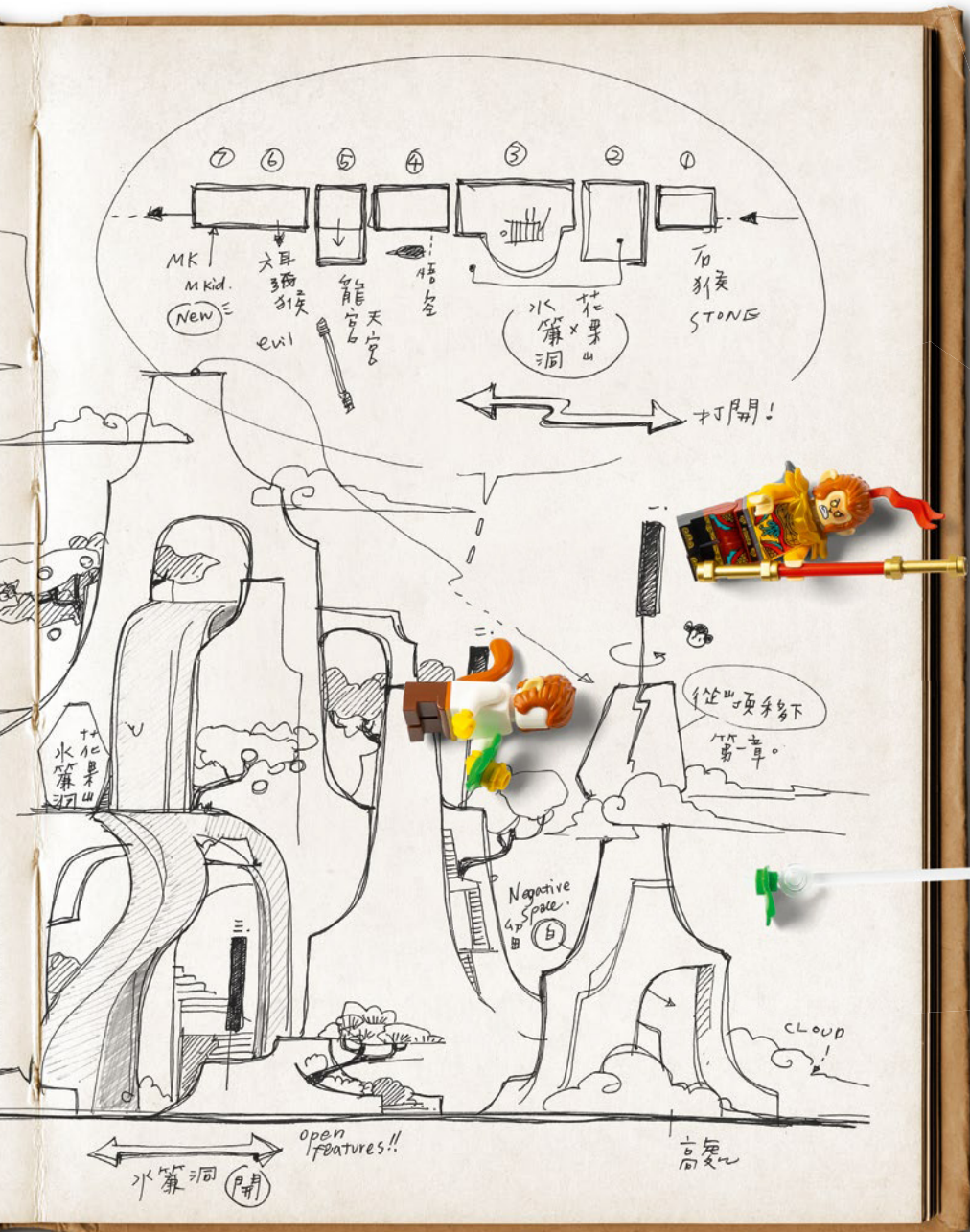





## CAPTURING 'SHANSHUI'

"From the very beginning, I was determined to make this set unique and make it stand apart from all the other LEGO® location sets. One of my key considerations was to capture an authentic Chinese aesthetic within the model.

After numerous discussions with our LEGO concept artist, Xiaodong Wen, I eventually took inspiration from traditional Chinese mountain landscape paintings; 'Shanshui', which literally means 'mountains and waters'. These paintings capture the essence or spirit of the natural world and aim to evoke a *feeling* rather than give a realistic or life-like impression of a place.

The first sketch models I built of Flower Fruit Mountain had a conventional rectangular footprint, but going back to the long horizontal scroll as one of the principal forms of Chinese *Shanshui* paintings, I developed and opened up the model to have a long horizontal footprint instead. This makes it a great set for shelf display as well."

## A TIMELESS TALE: RETOLD

"While designing this model, I was really motivated by the idea that parents would be able to use the set to tell and share the timeless stories of the Monkey King with their children through play.

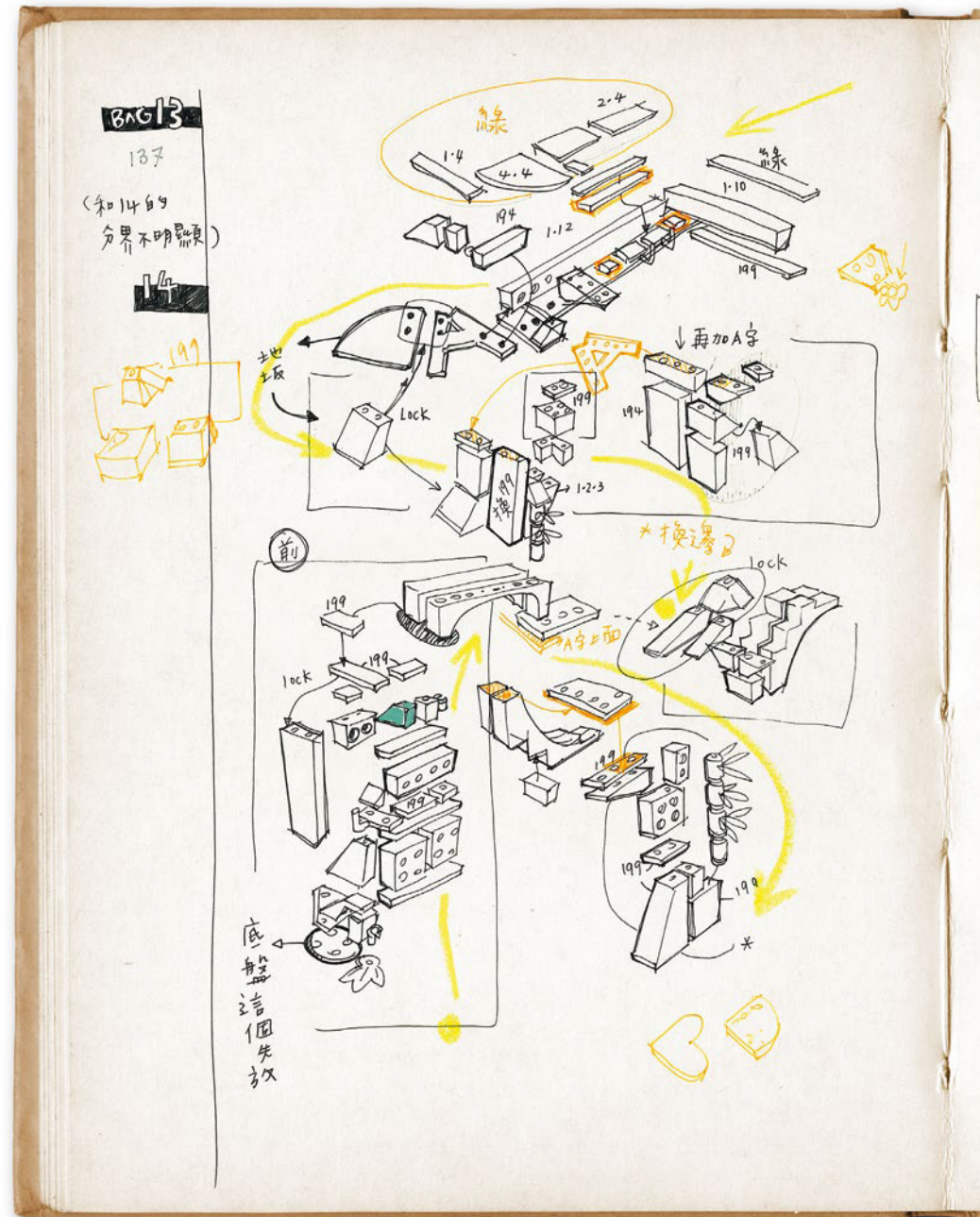



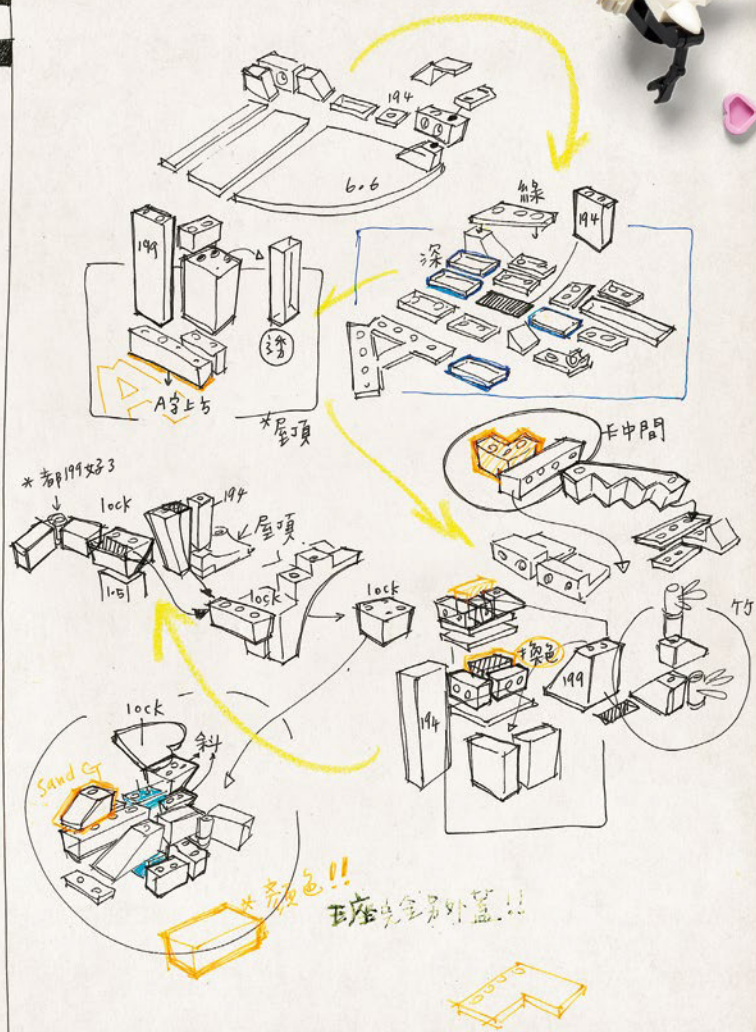
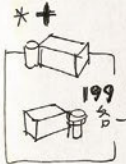

My first thought was to place lots of different Monkey King story elements across the model, but during a design team meeting, the suggestion was made that we could arrange the model to reflect the chapters of the story in a more chronological way.

And so, the final model design of Flower Fruit Mountain was created to give a linear story-telling of the Monkey King legend; starting with how he was born from a rock, to how he took to the Monkey King throne. Last but not least, I'm also extremely excited that we feature no less than four different LEGO minifigure versions of Monkey King himself – something completely unique to this set!"















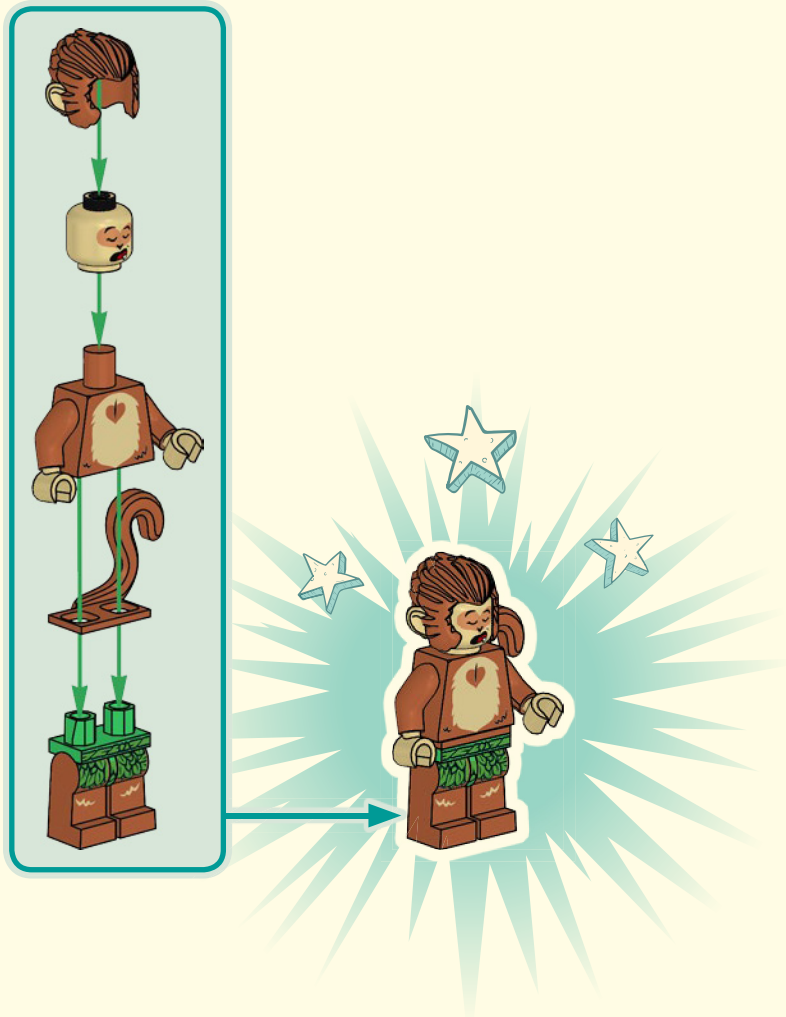

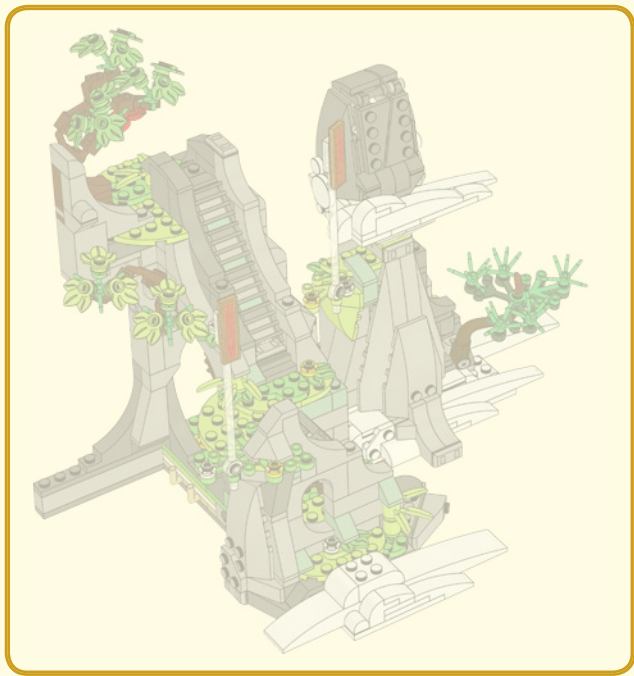

1

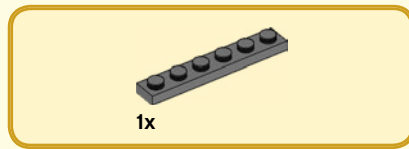
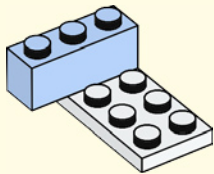

2

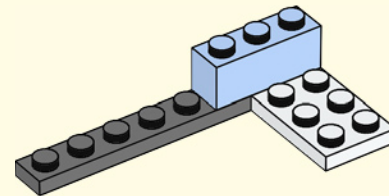



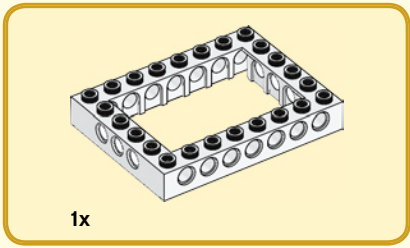

3

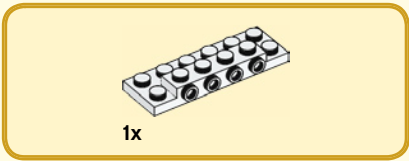
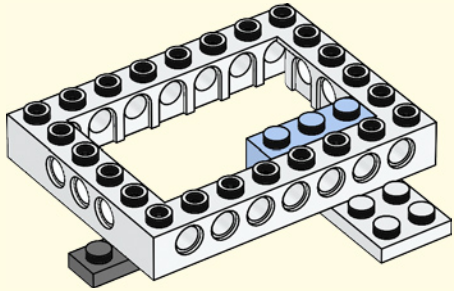

4

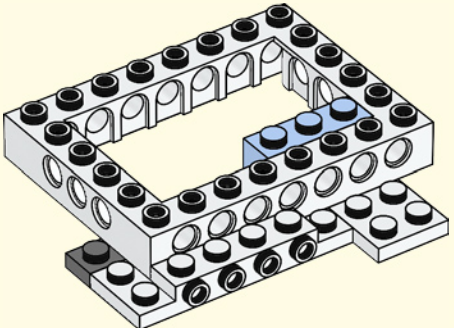

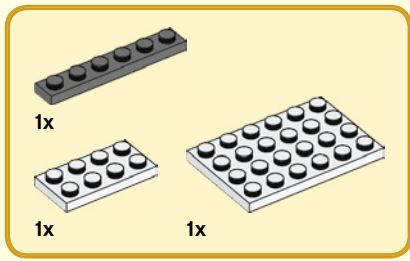

5

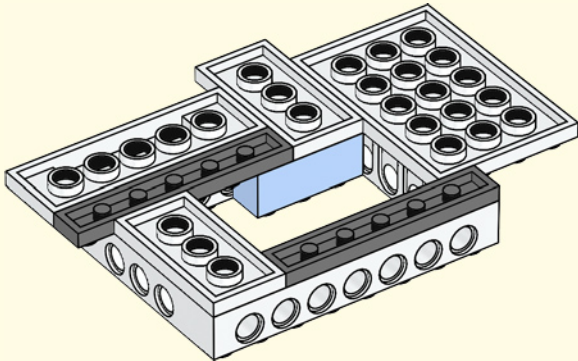

6

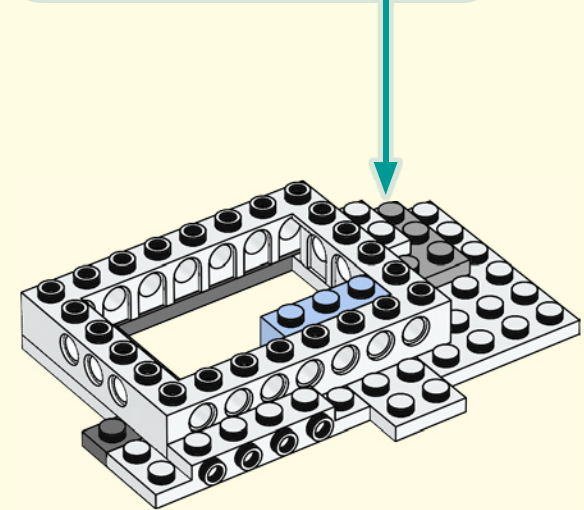
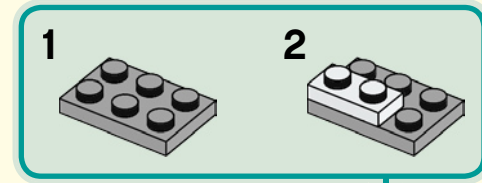
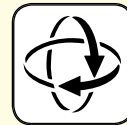

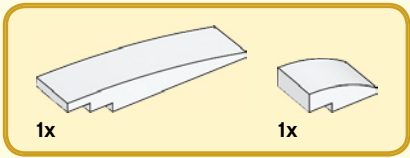

7

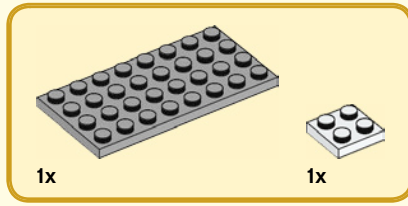
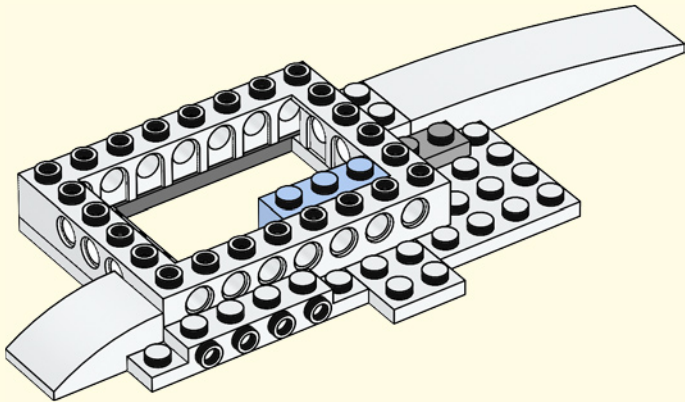

8

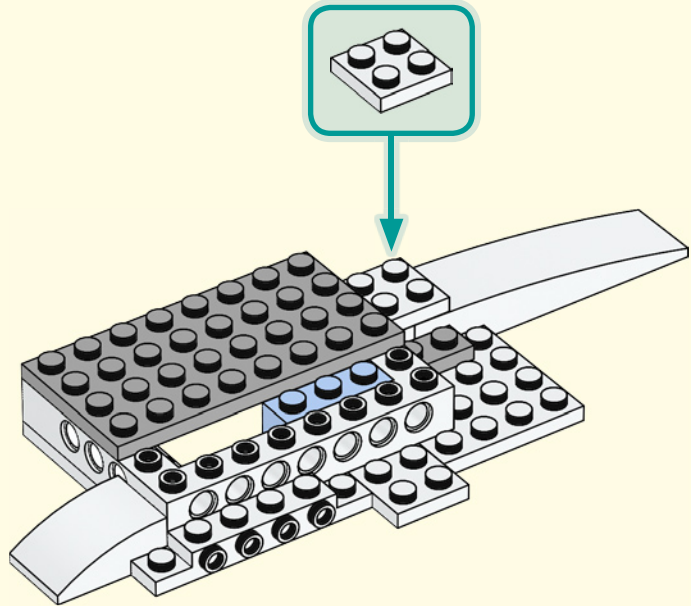



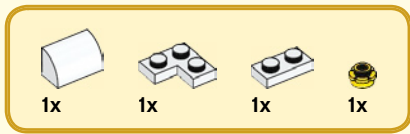

9

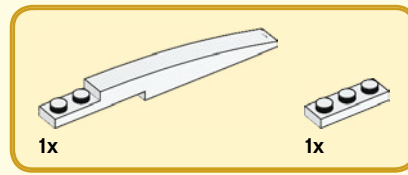
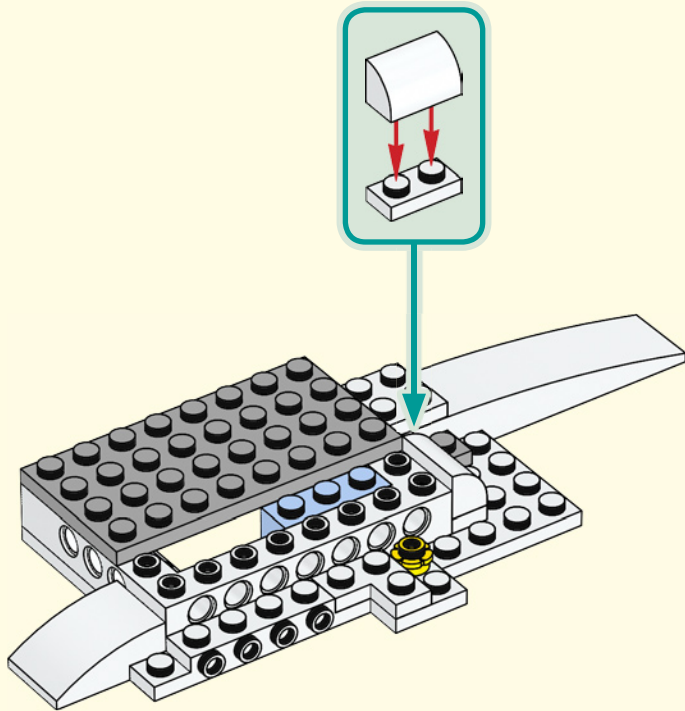

10

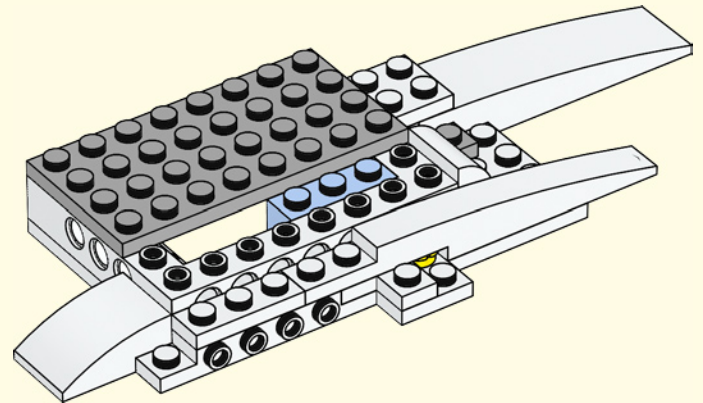

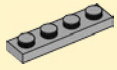

1x



1x

11

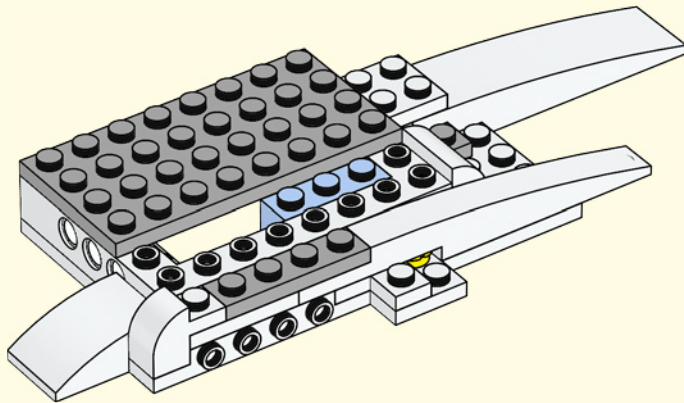

1x



3x

12

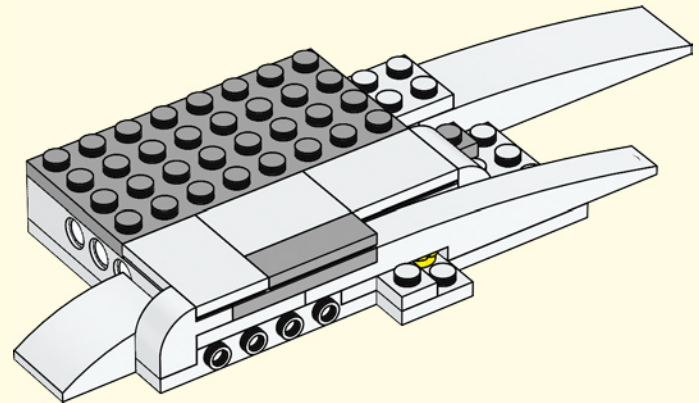

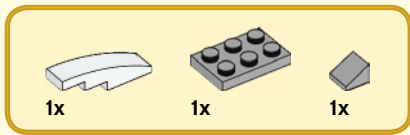

13

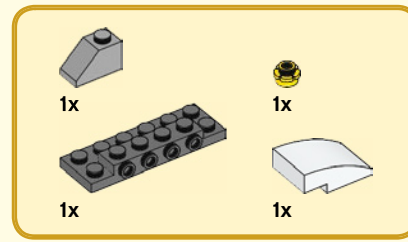
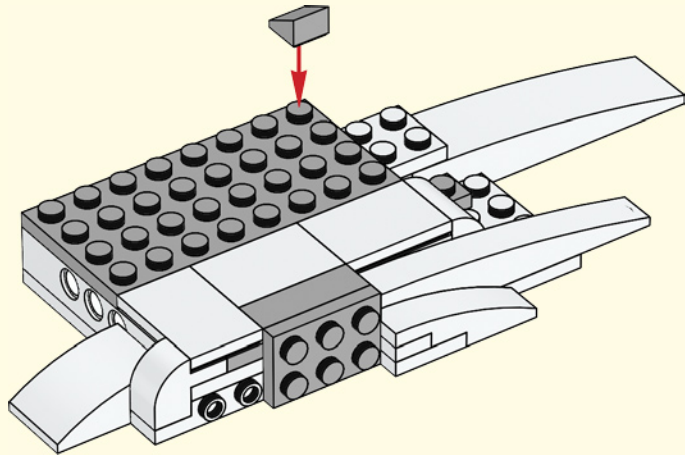

14

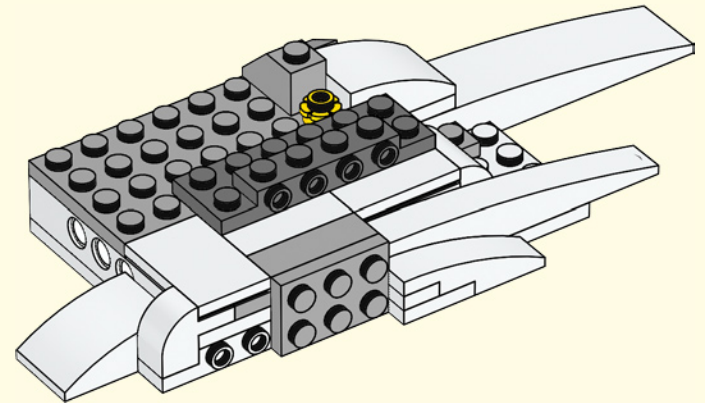



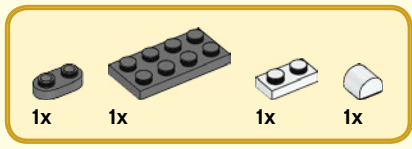

15

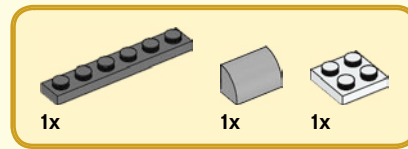
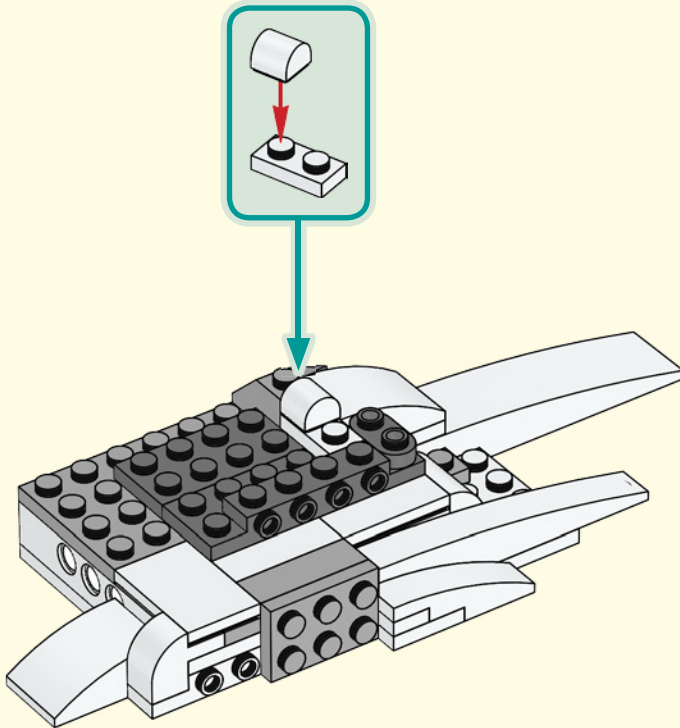

16

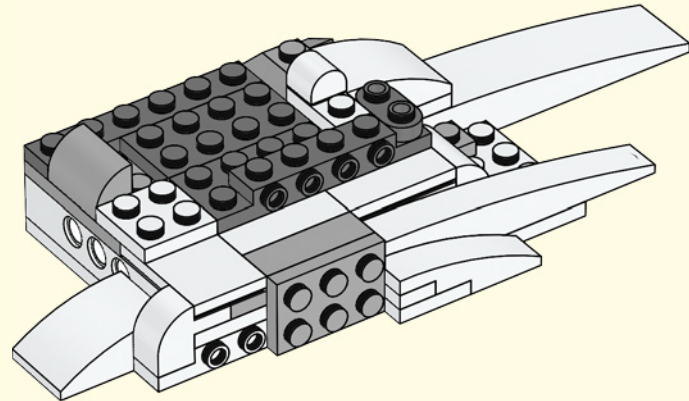

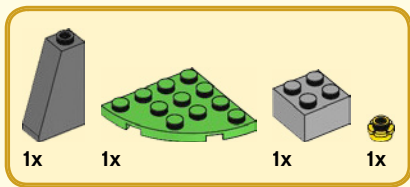

17

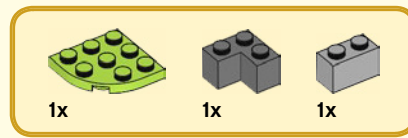
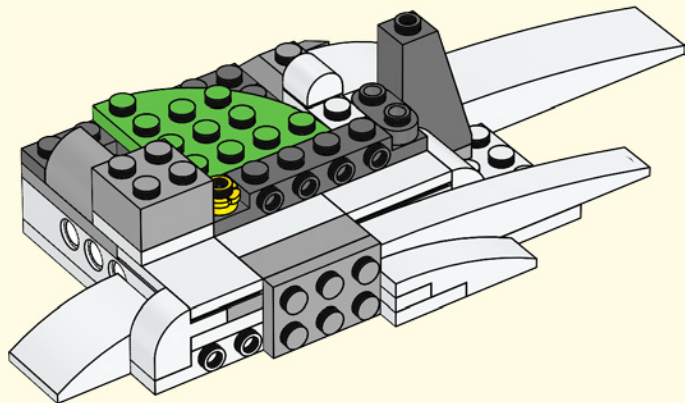

18

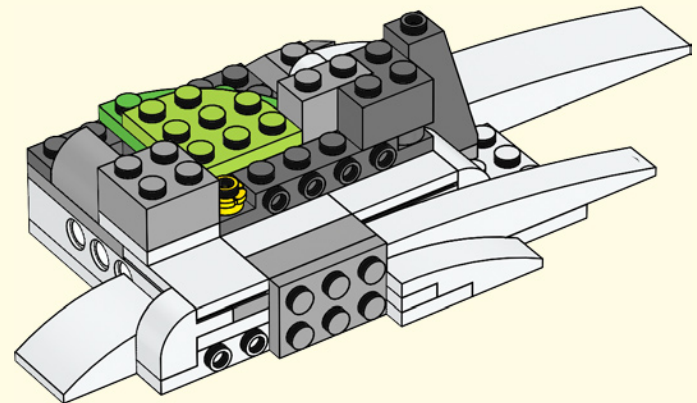



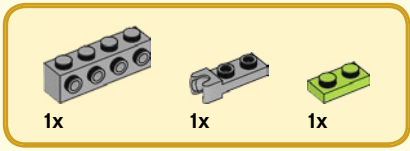

19

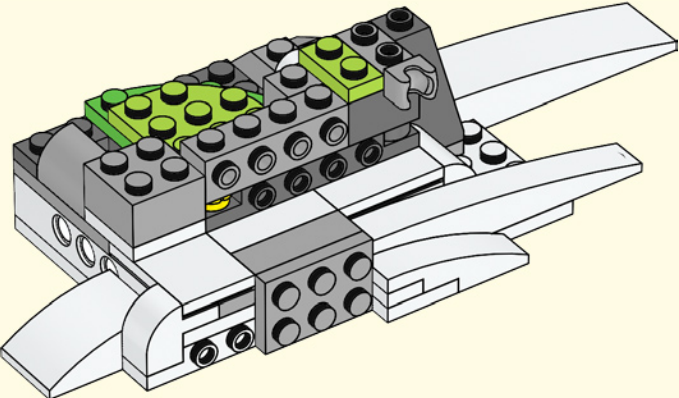

20

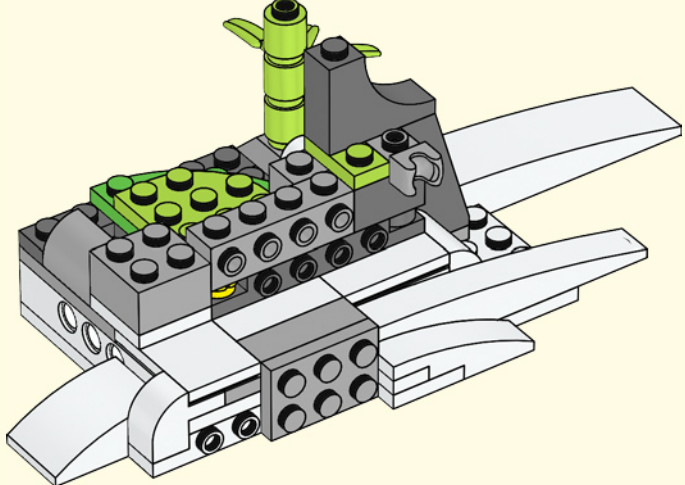
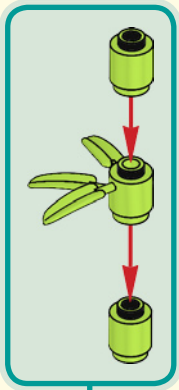

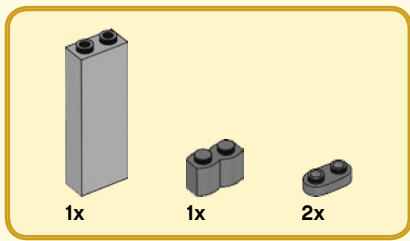

21

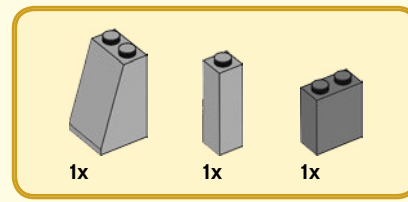
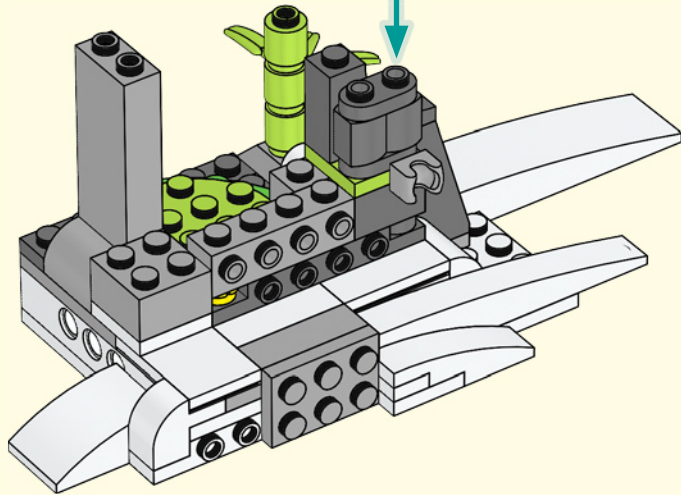
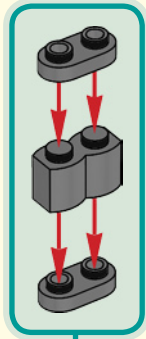

22

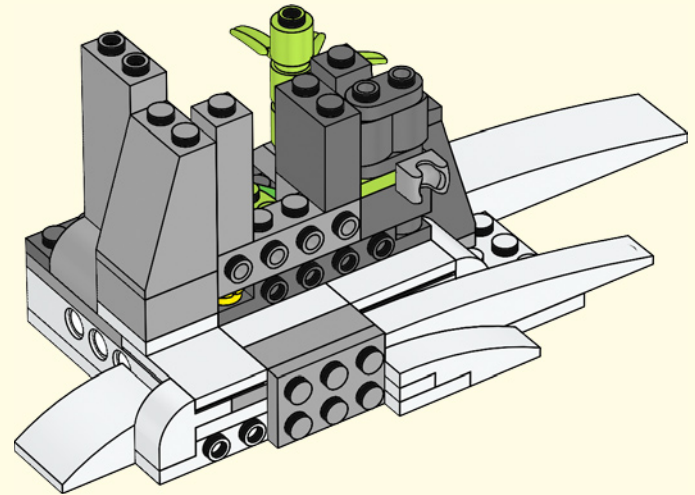

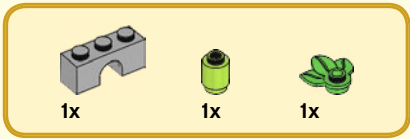

23

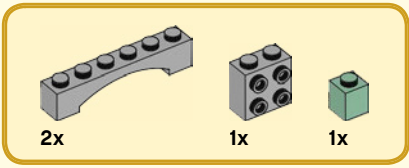
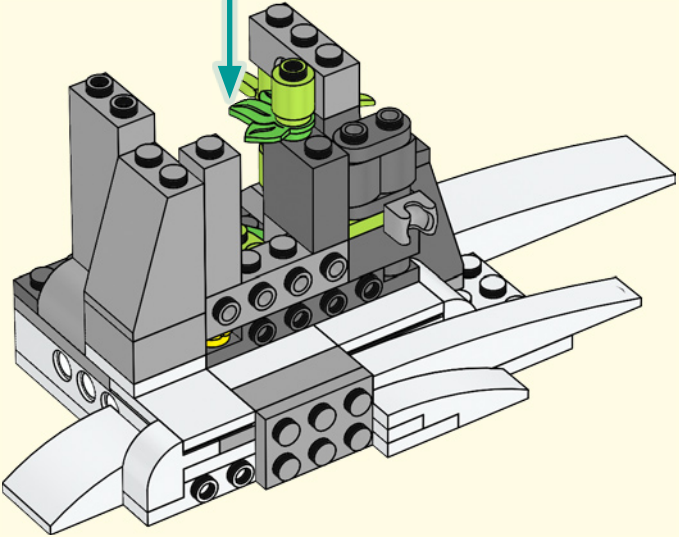
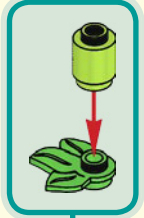

24

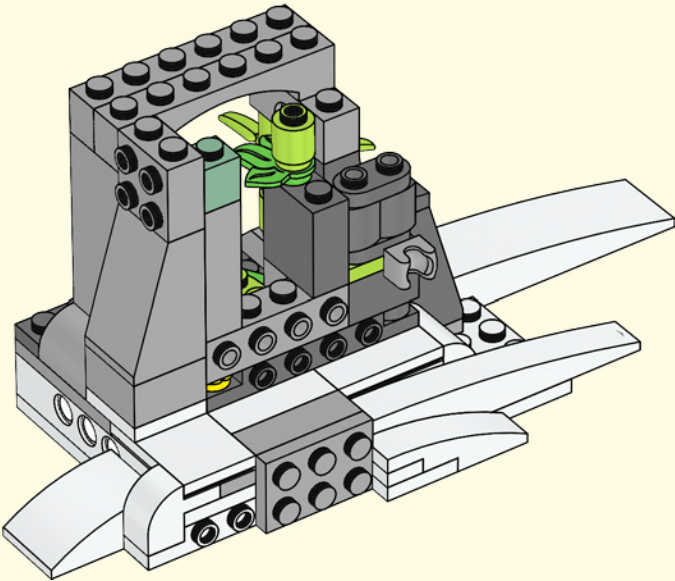



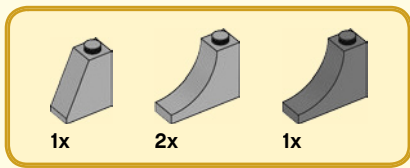

25

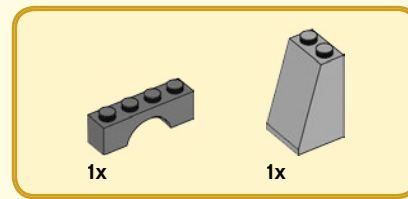
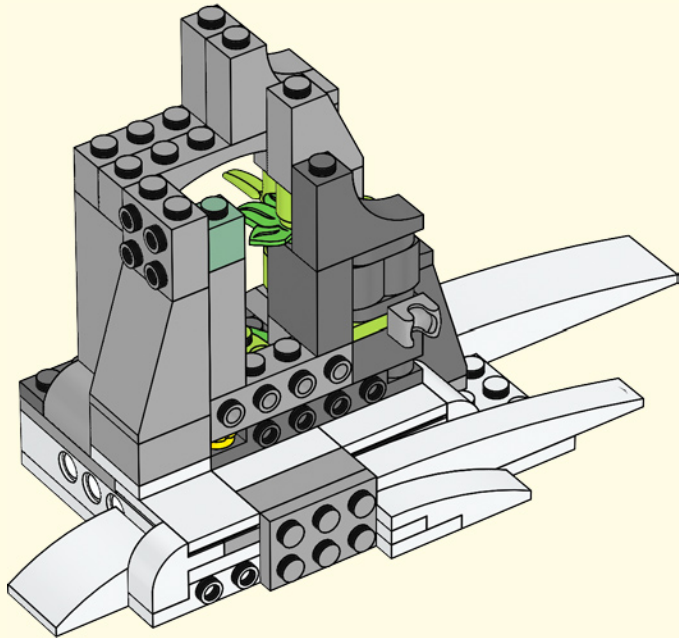

26

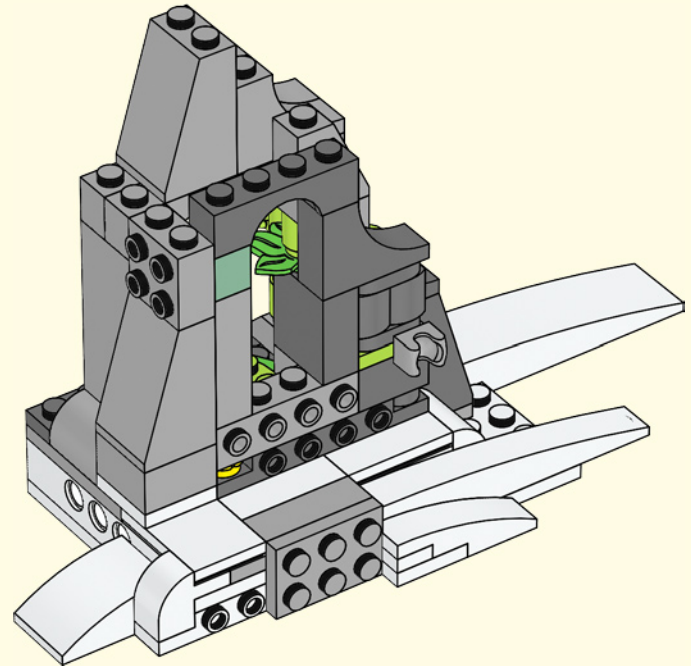

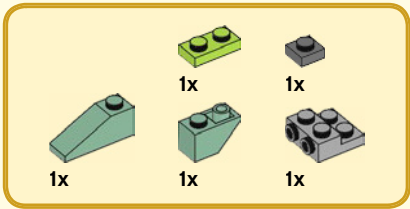

27

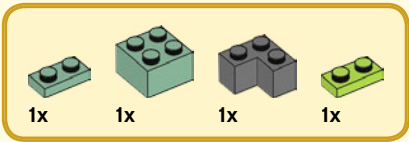
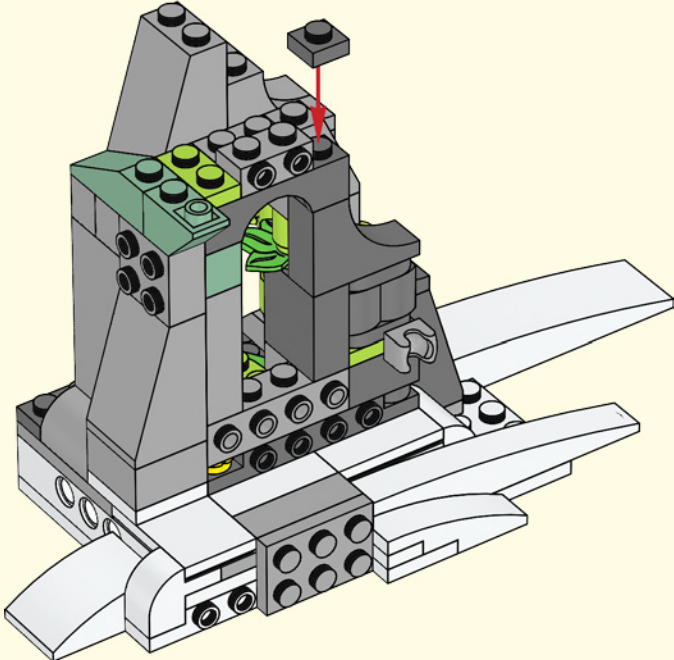

28

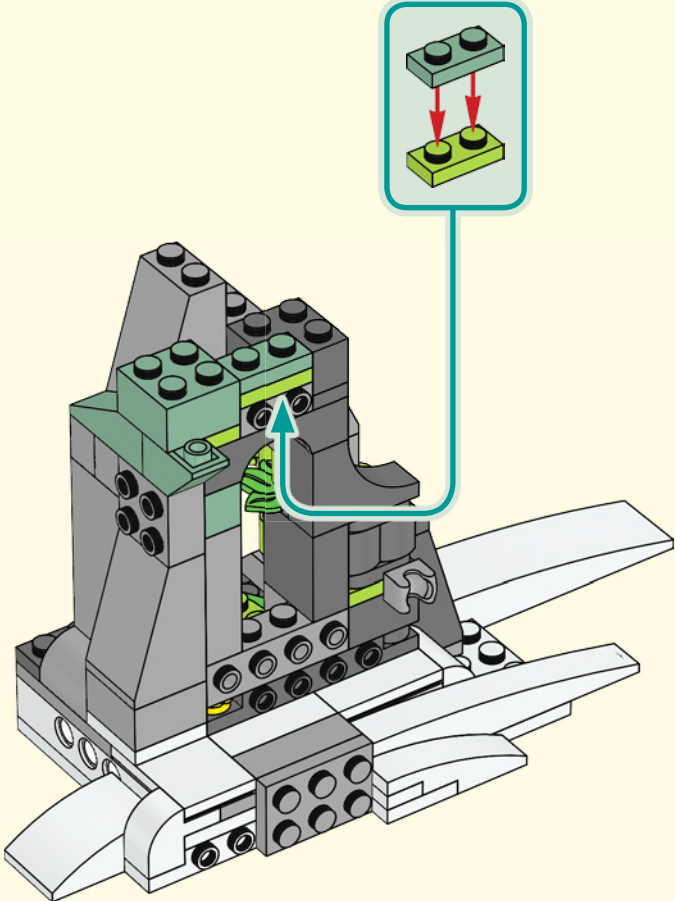

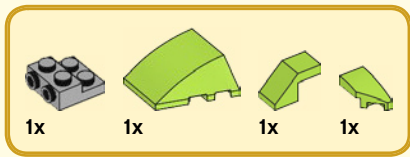

29

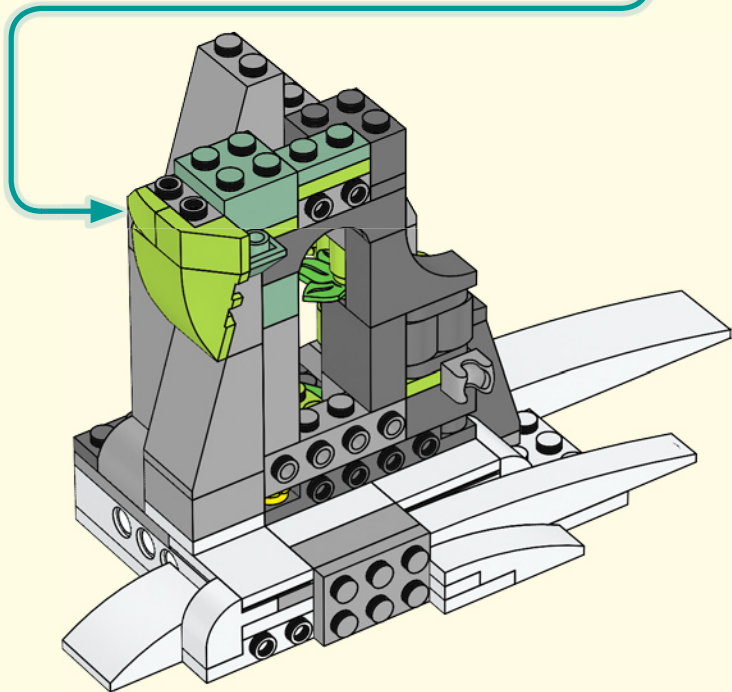
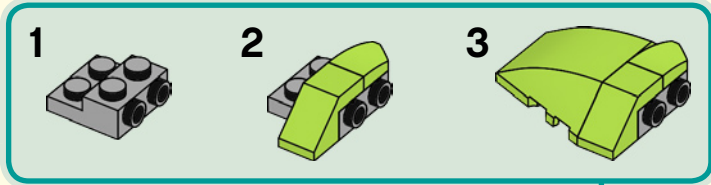

30

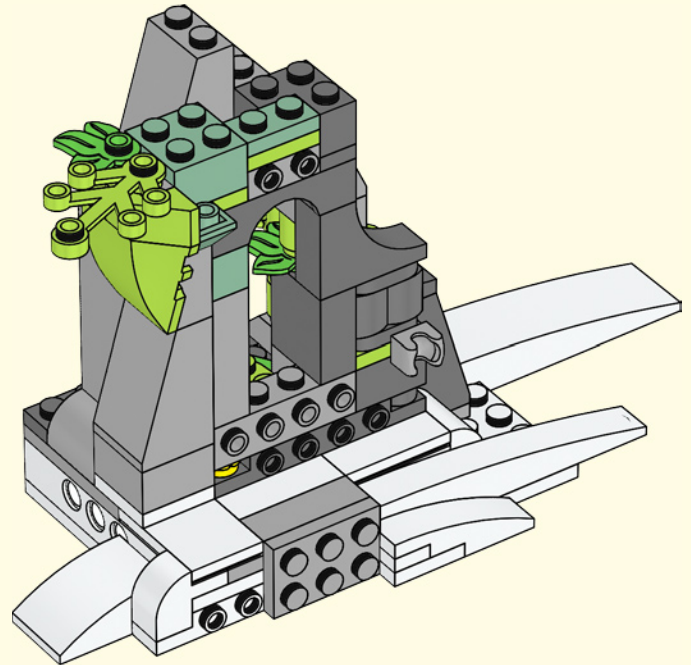



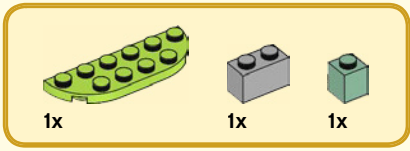

# 31

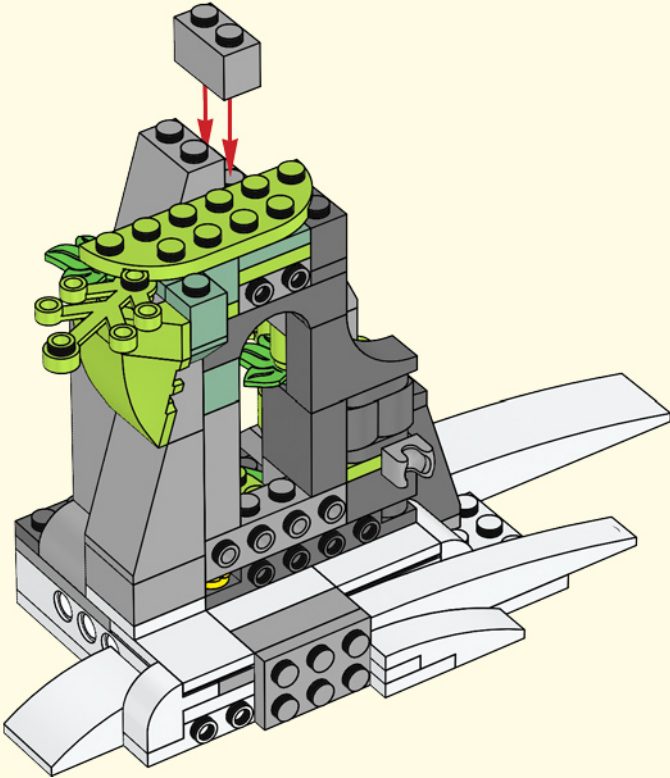



32

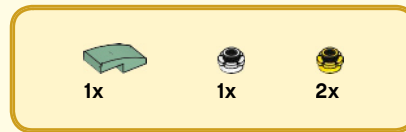
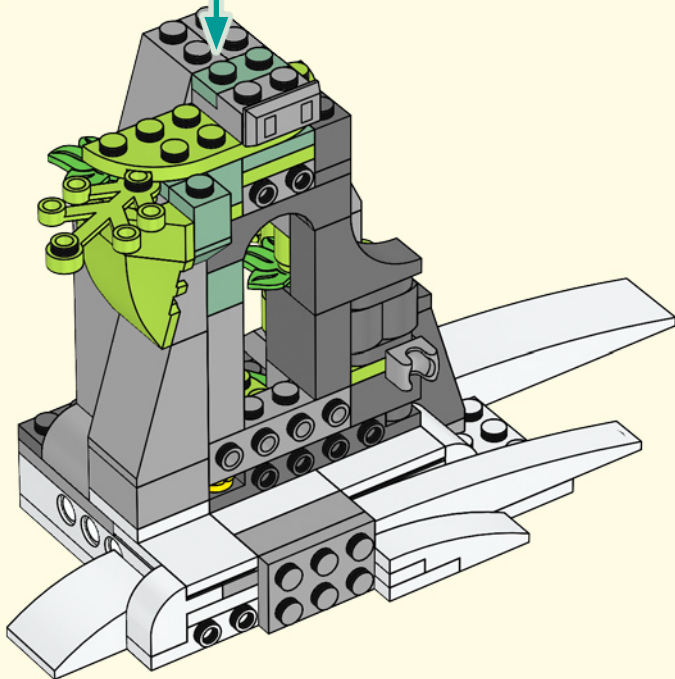
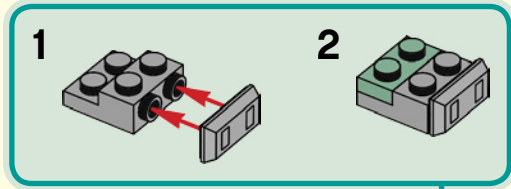

33

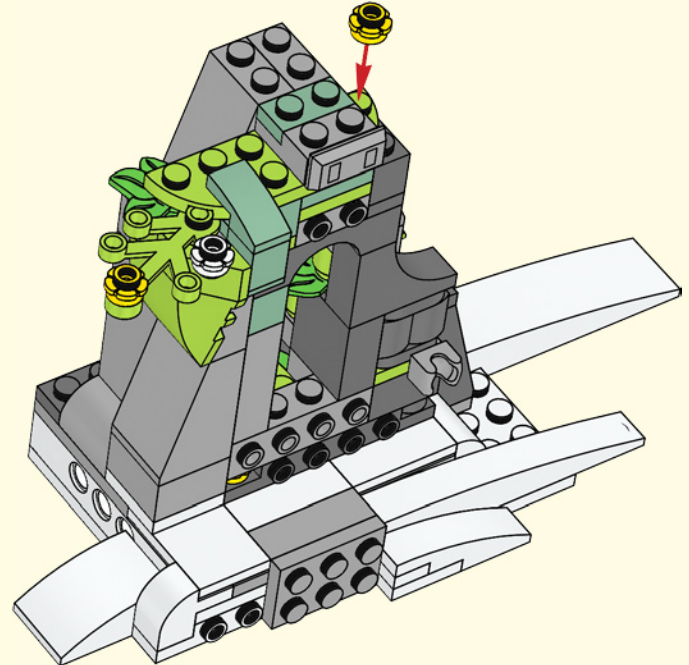

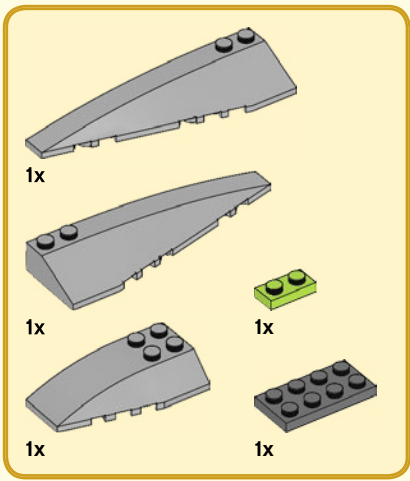

34

1

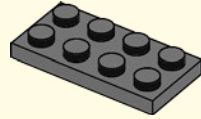

2

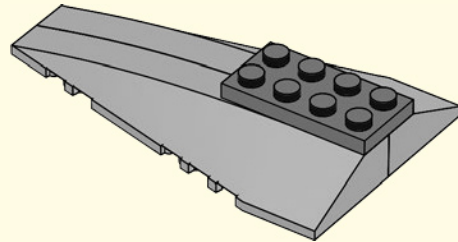

3

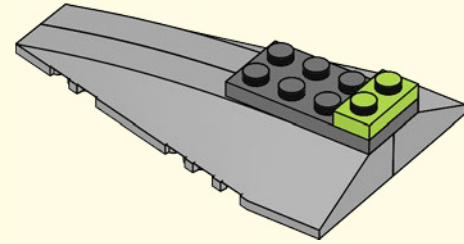

4

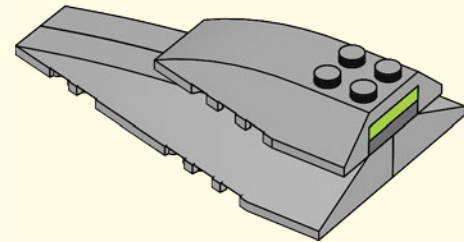



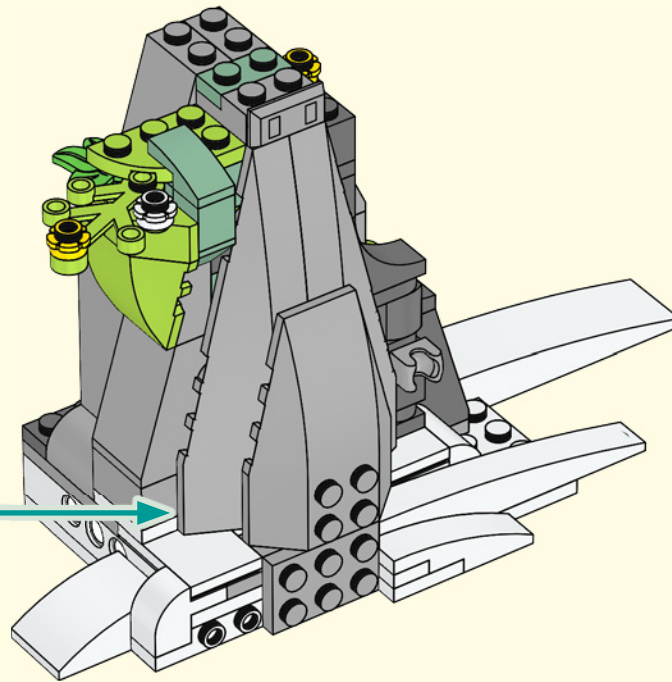

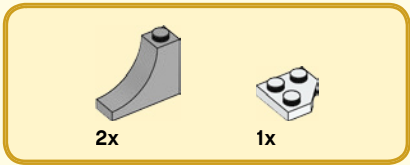

35

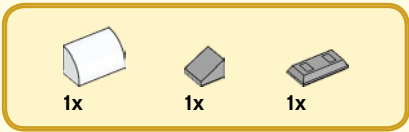
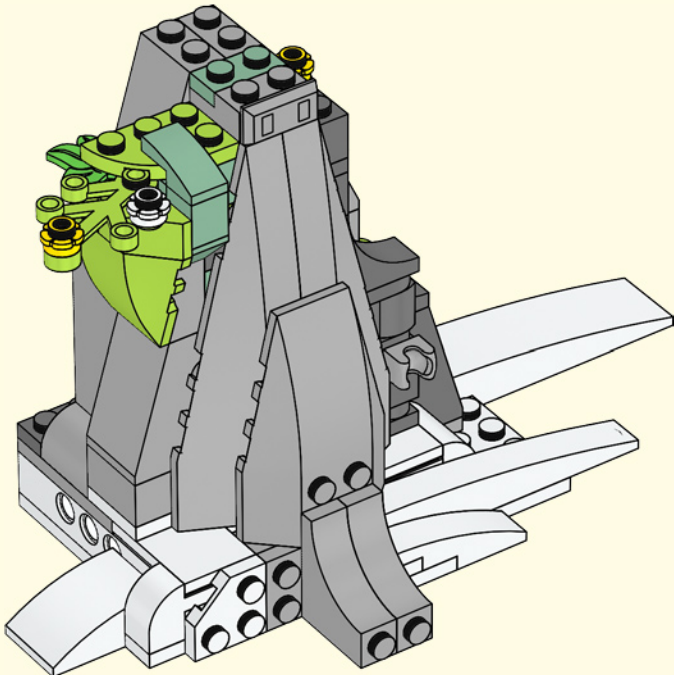

36

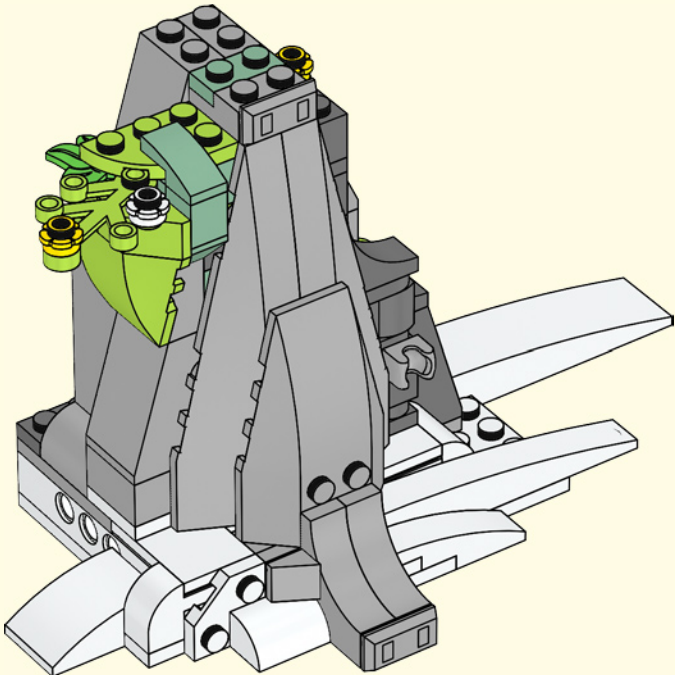



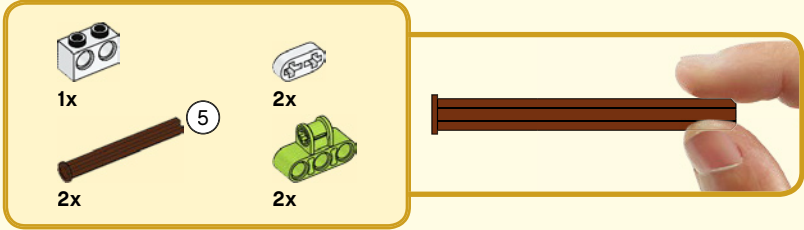
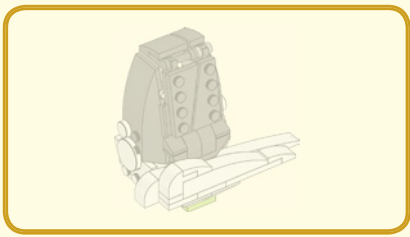

37

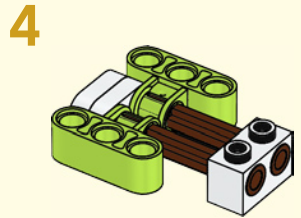
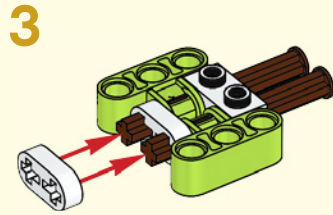
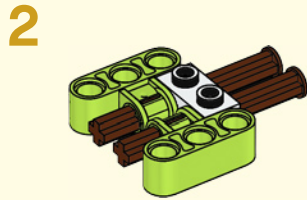
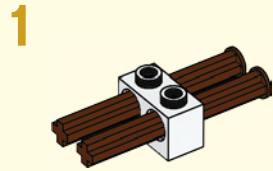



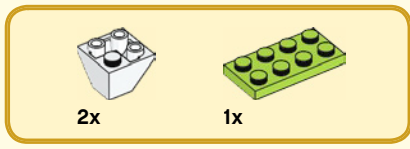

38

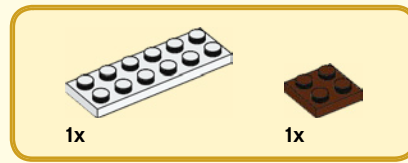
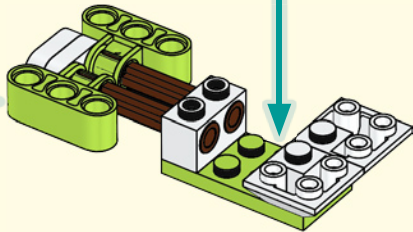
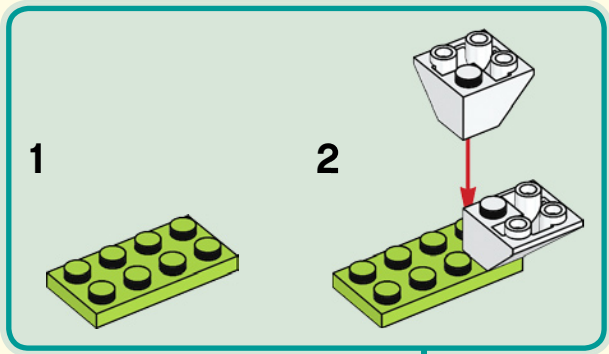

39

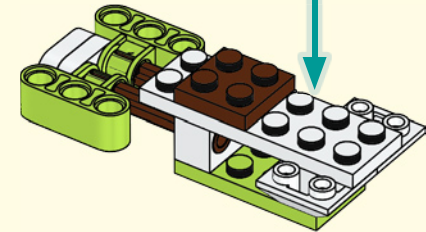
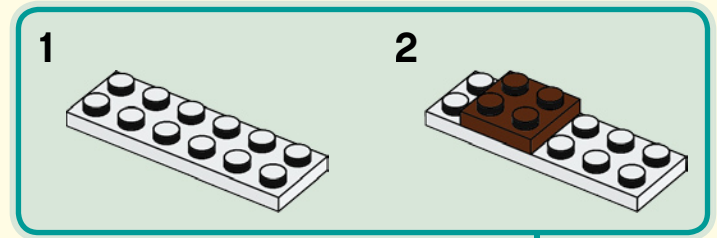



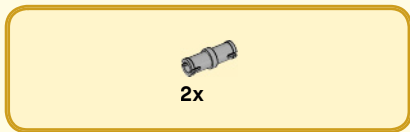

44

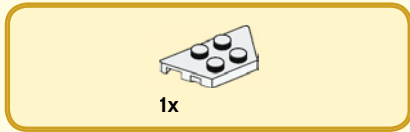
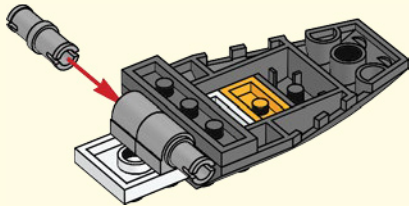

45

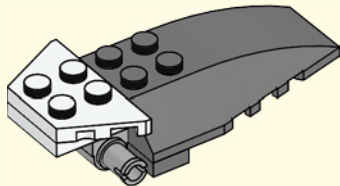

46

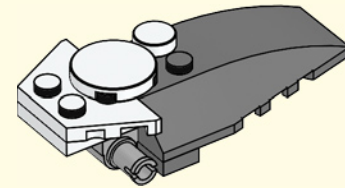

47

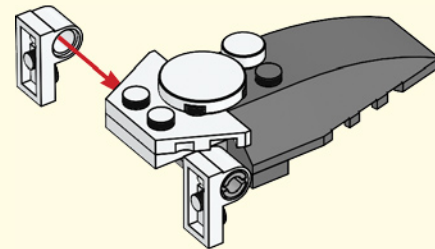

2x

48

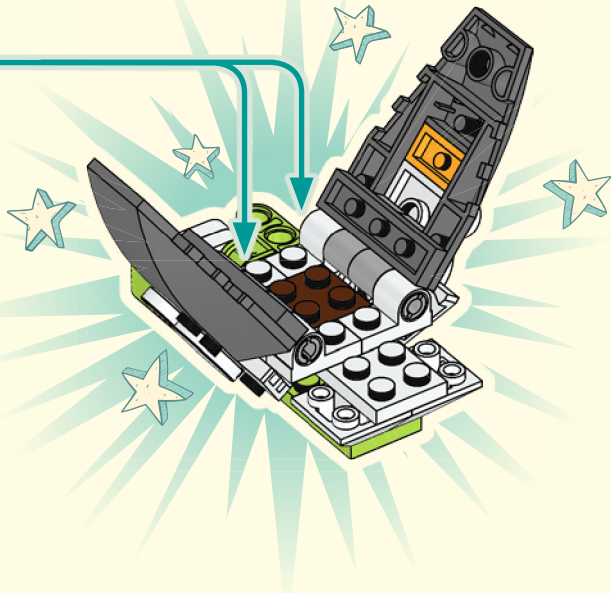

49

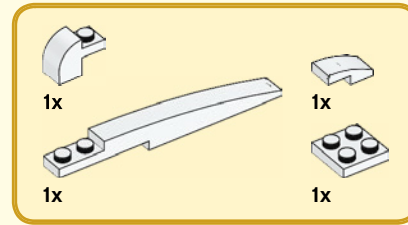
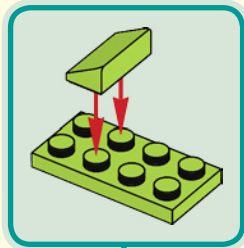
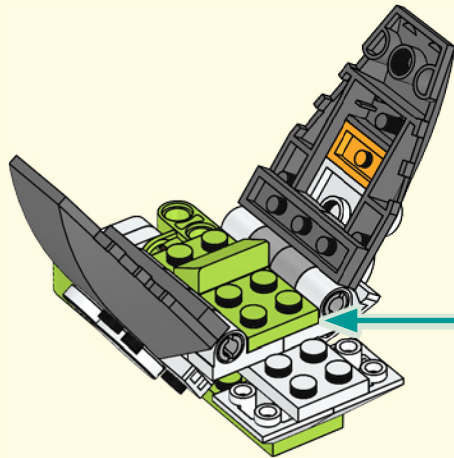

50

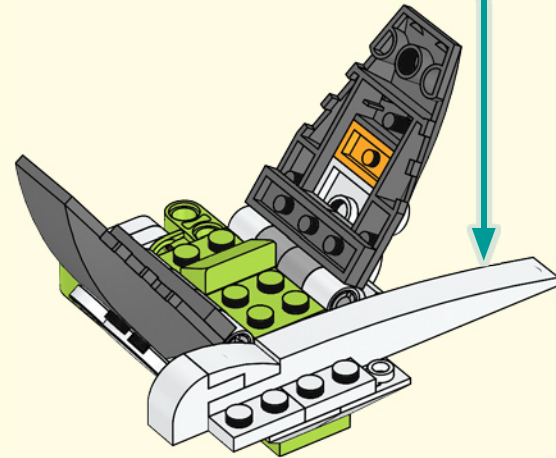
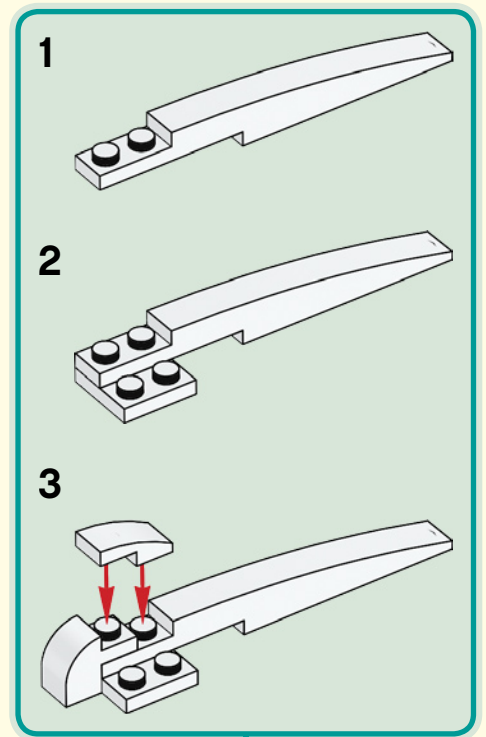



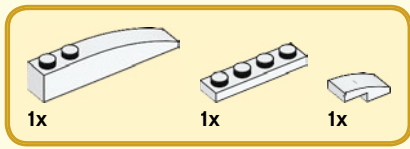

51

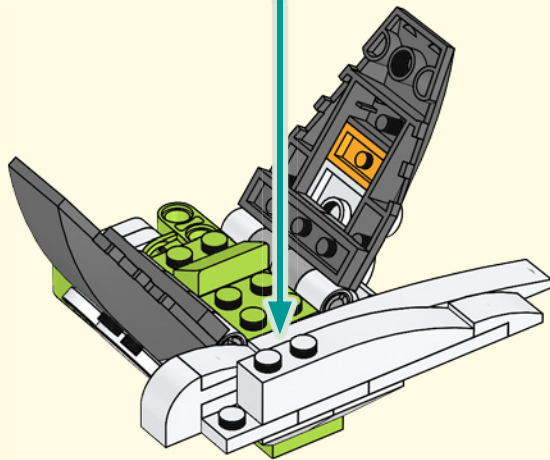
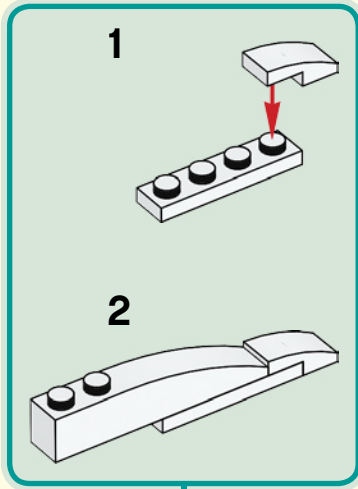

52

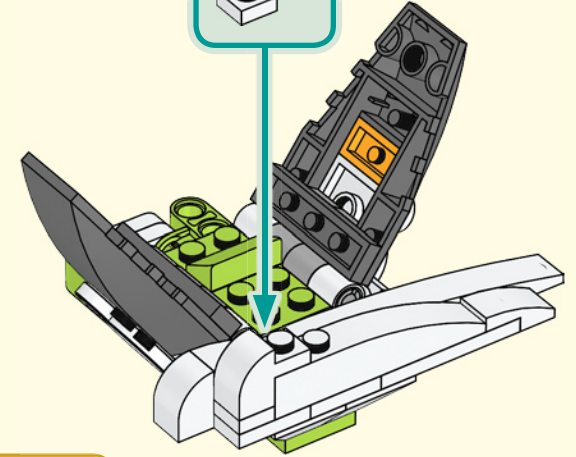
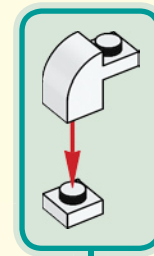

53

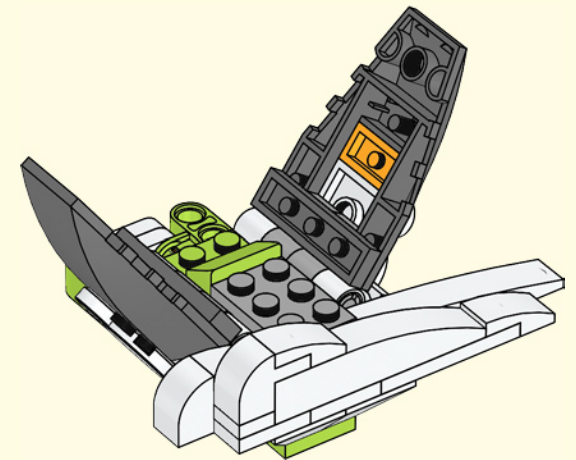



1x

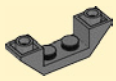

1x

# 54

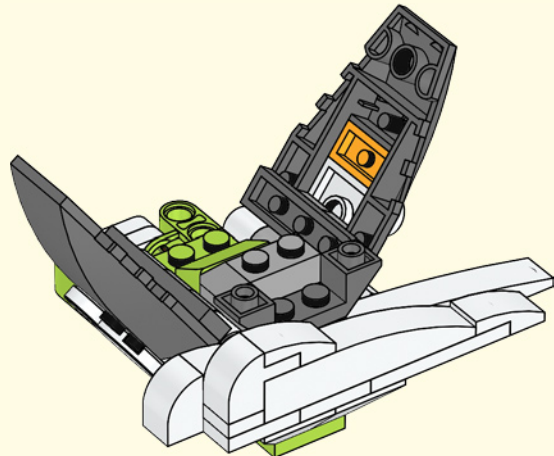

2x

# 55

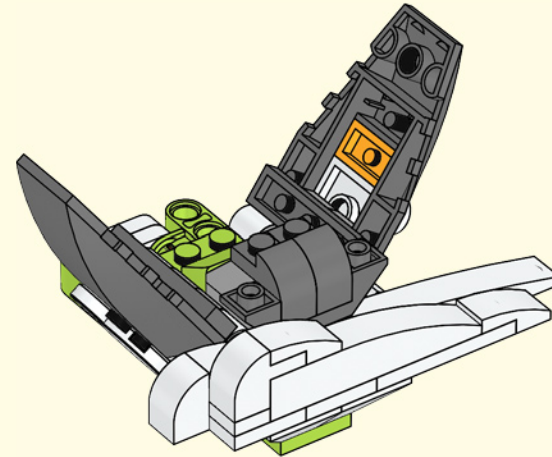

1x



2x

# 56

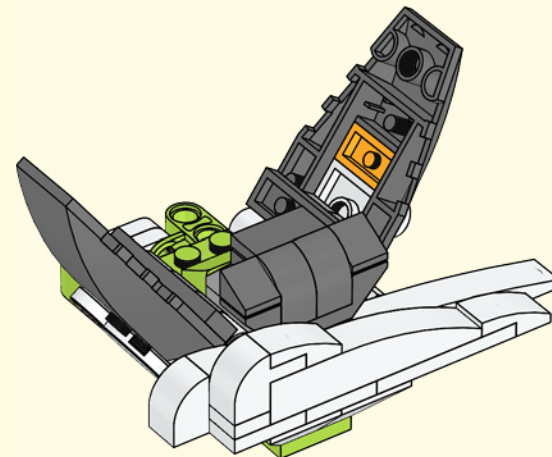

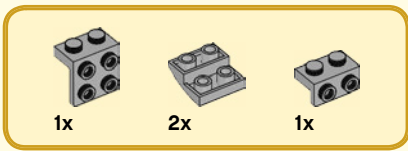

57

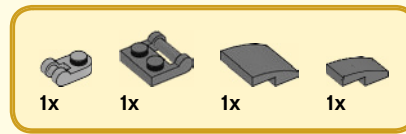
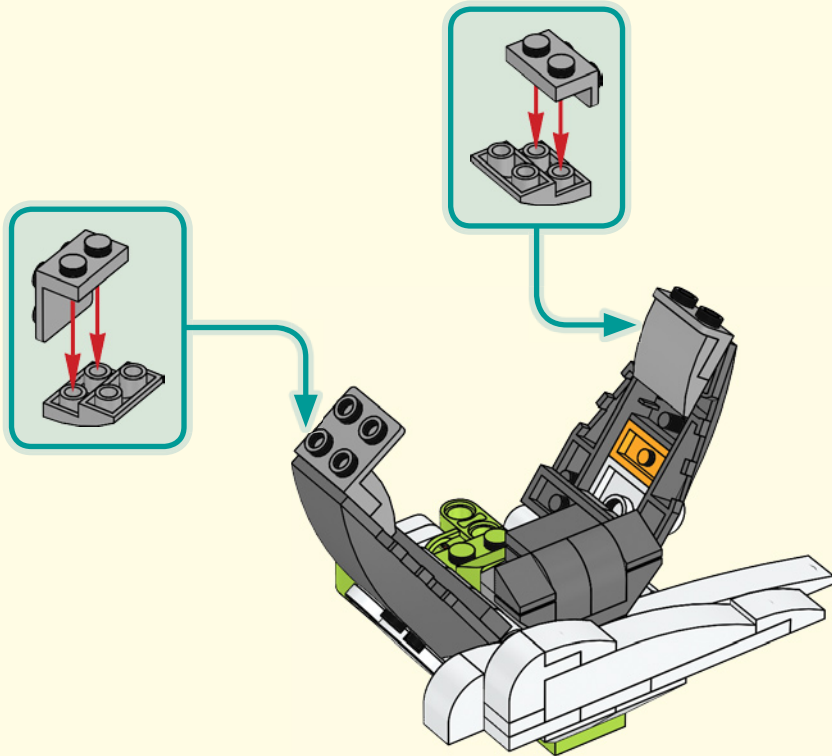

58

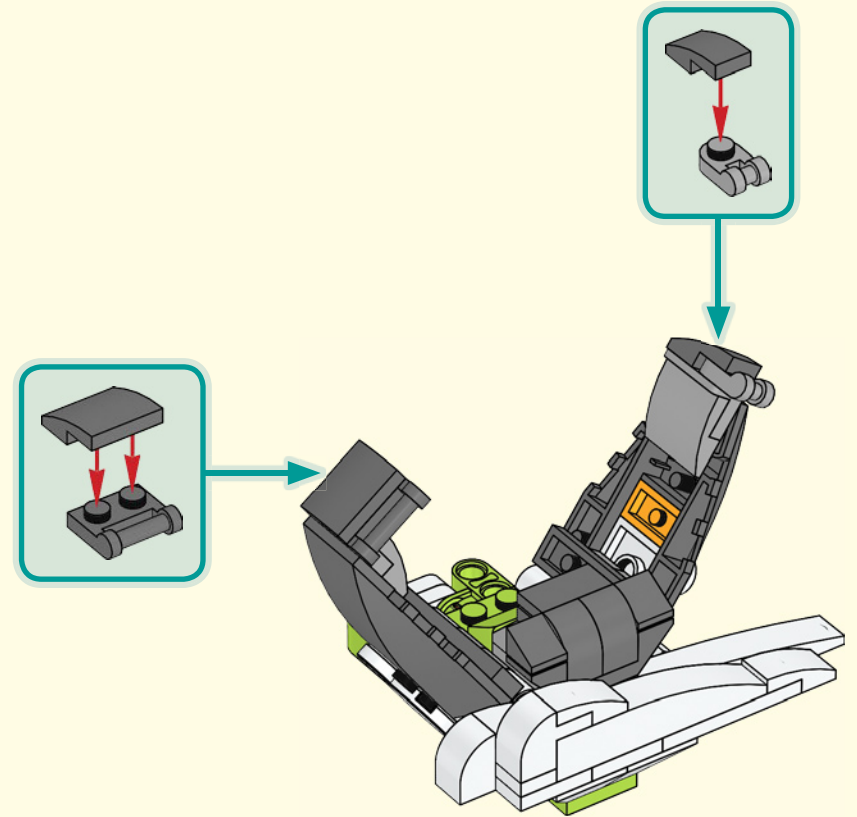

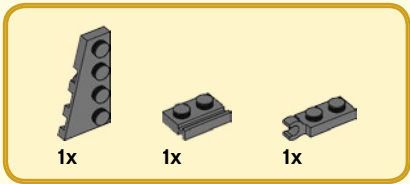

59

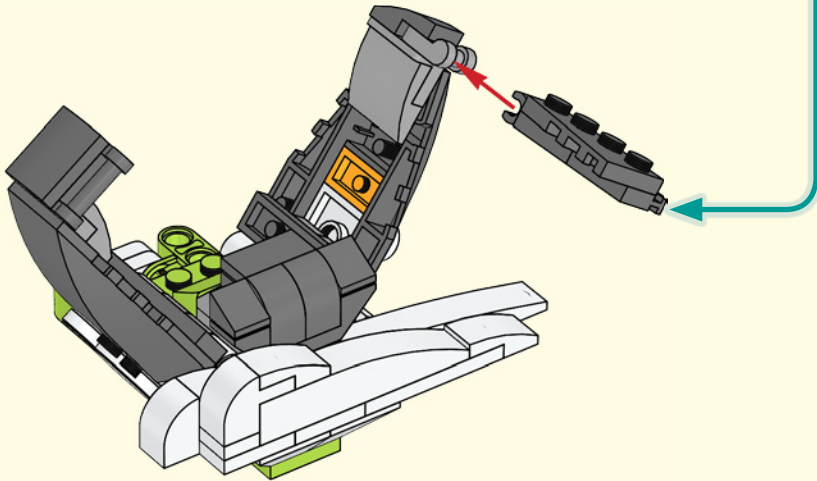
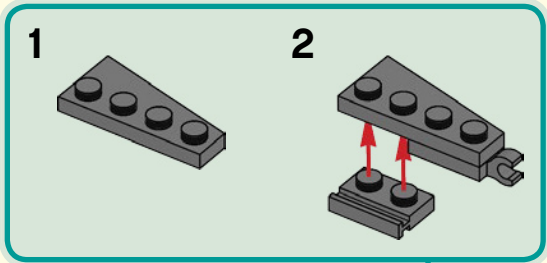



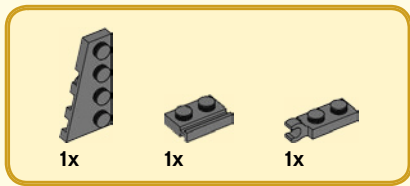

60

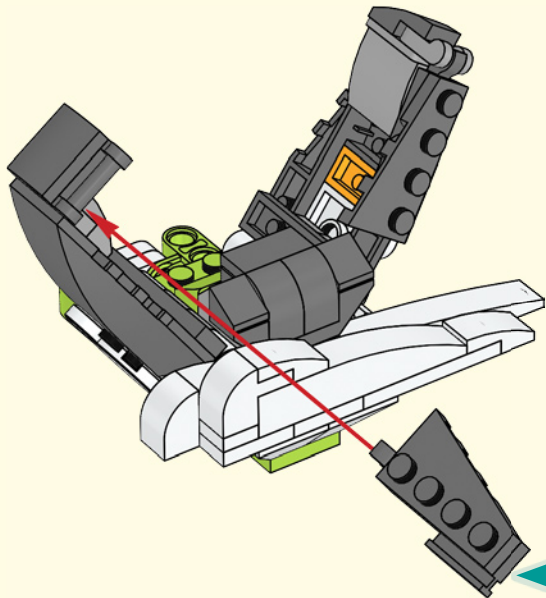
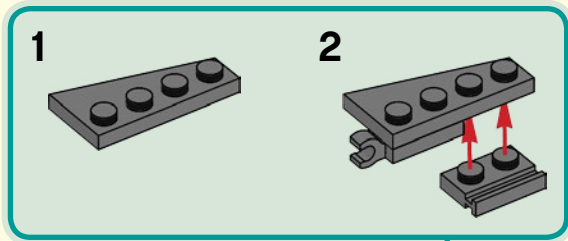

61

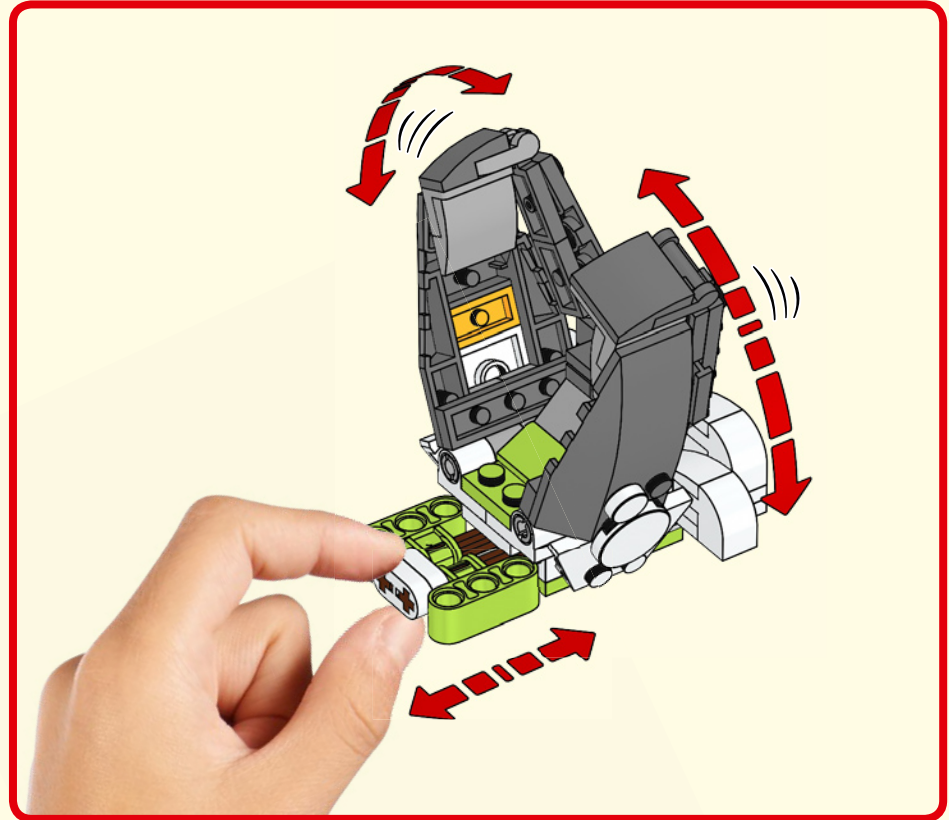

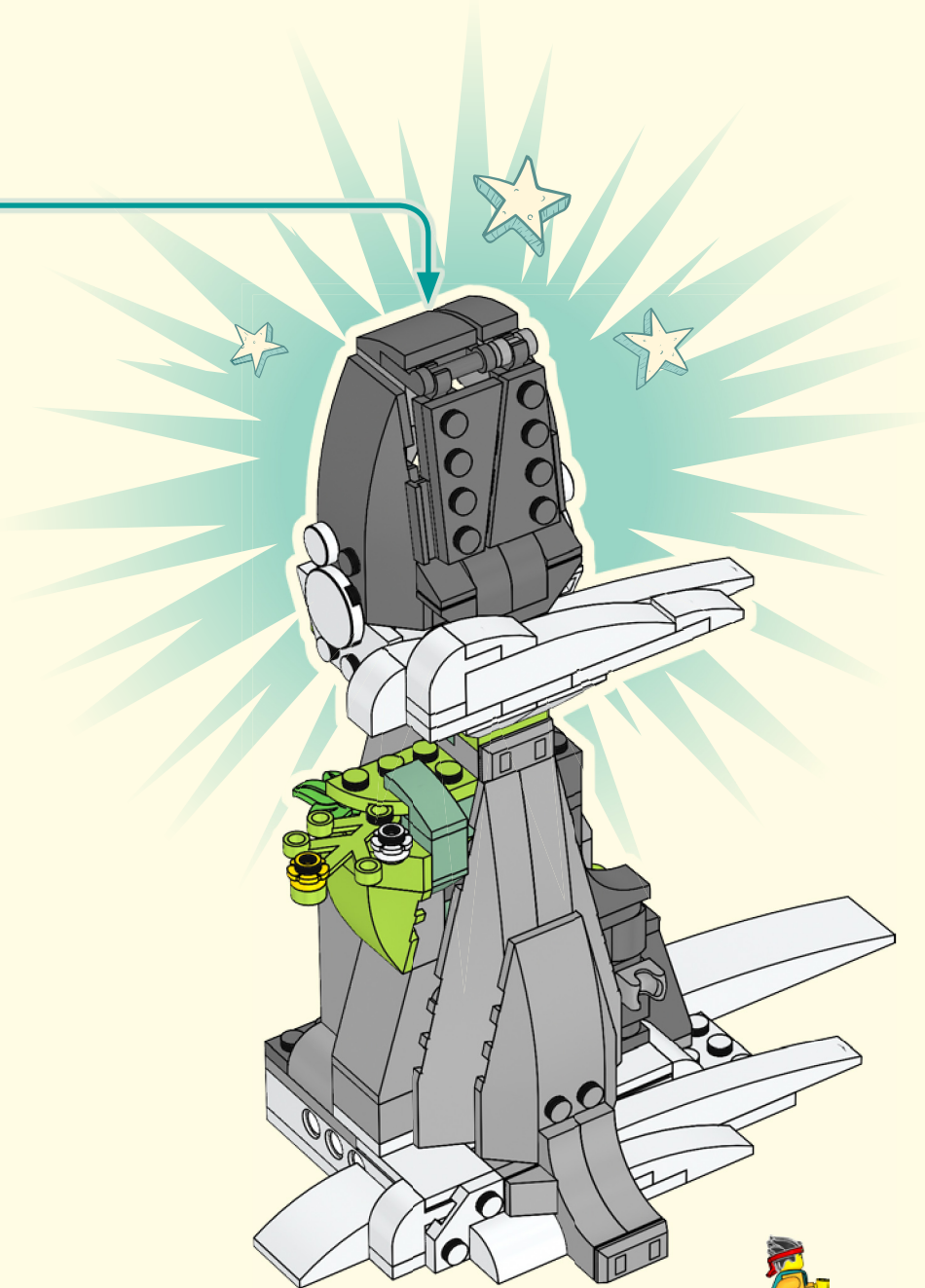

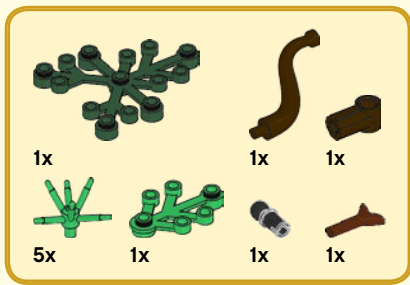

63

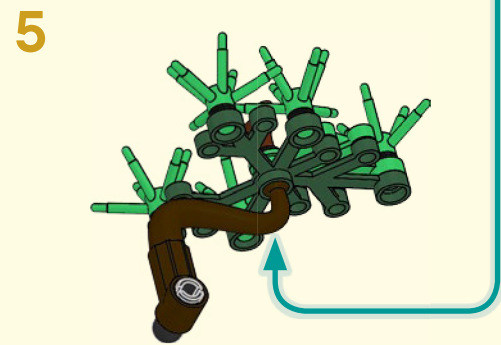
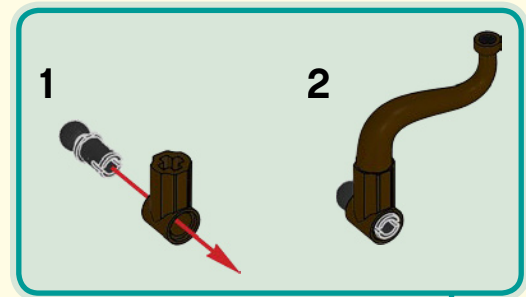
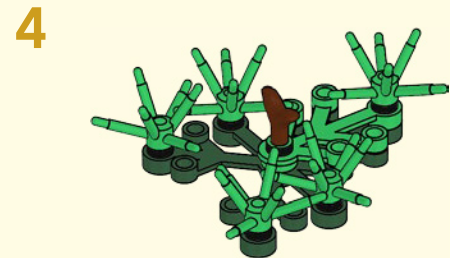
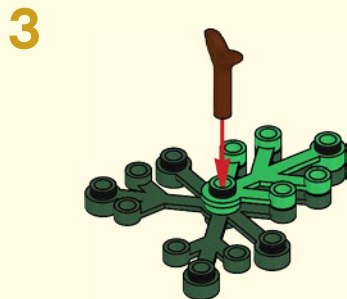
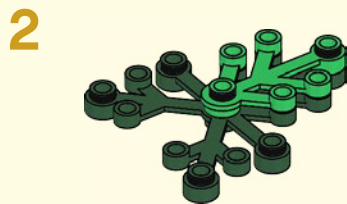
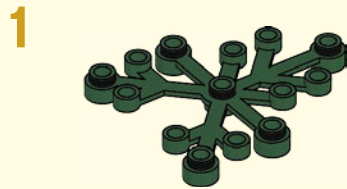

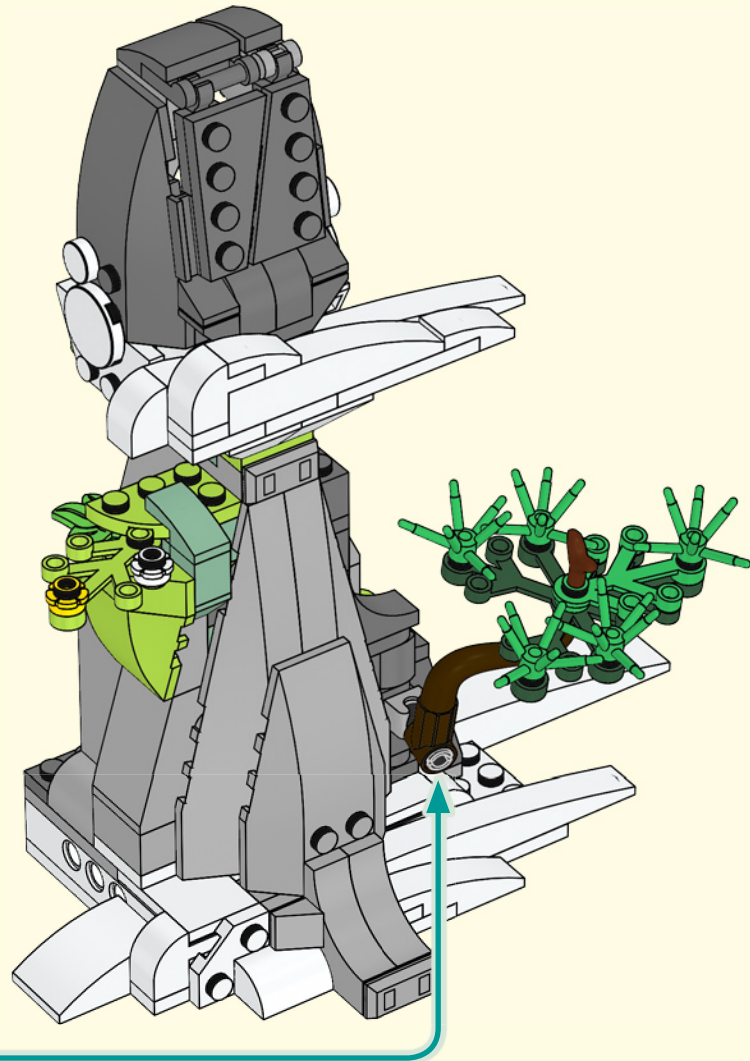



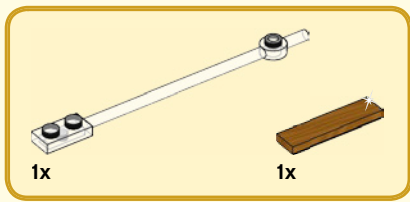

64

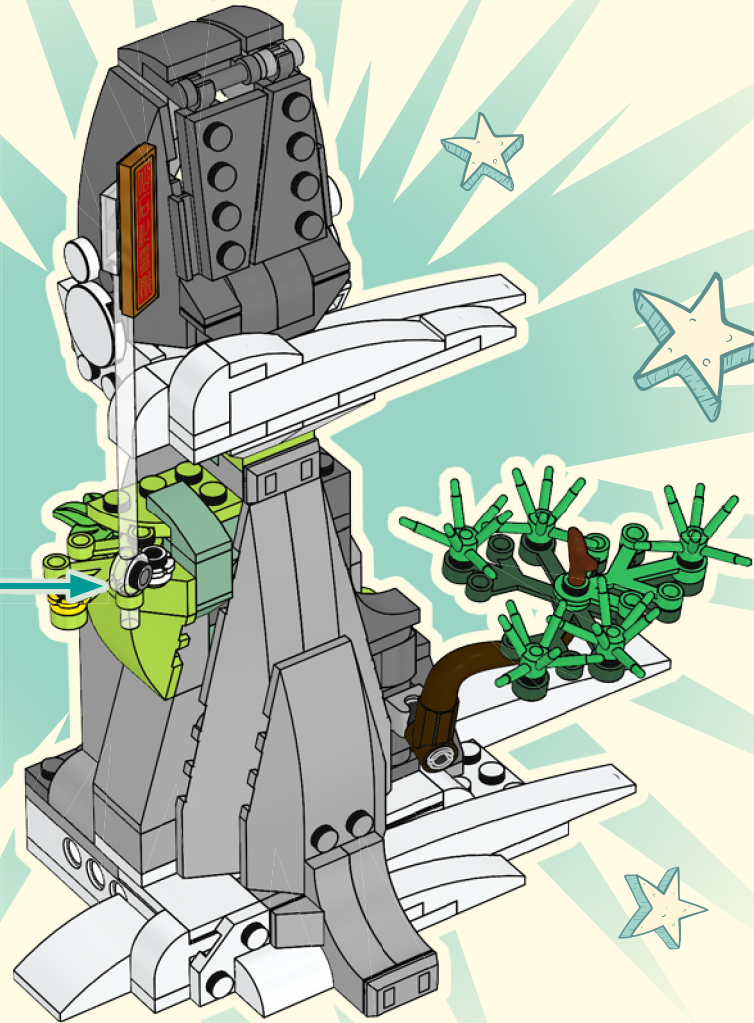
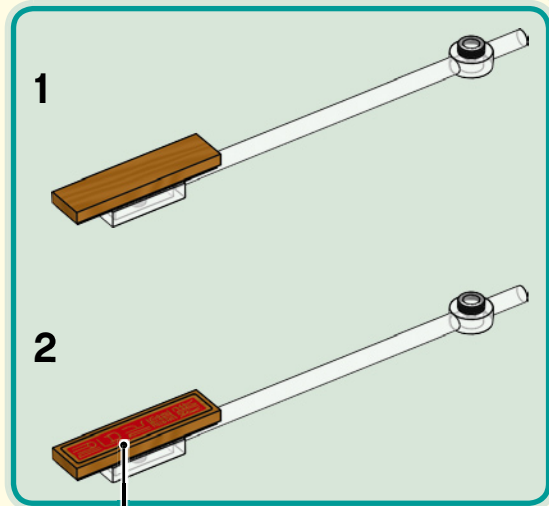



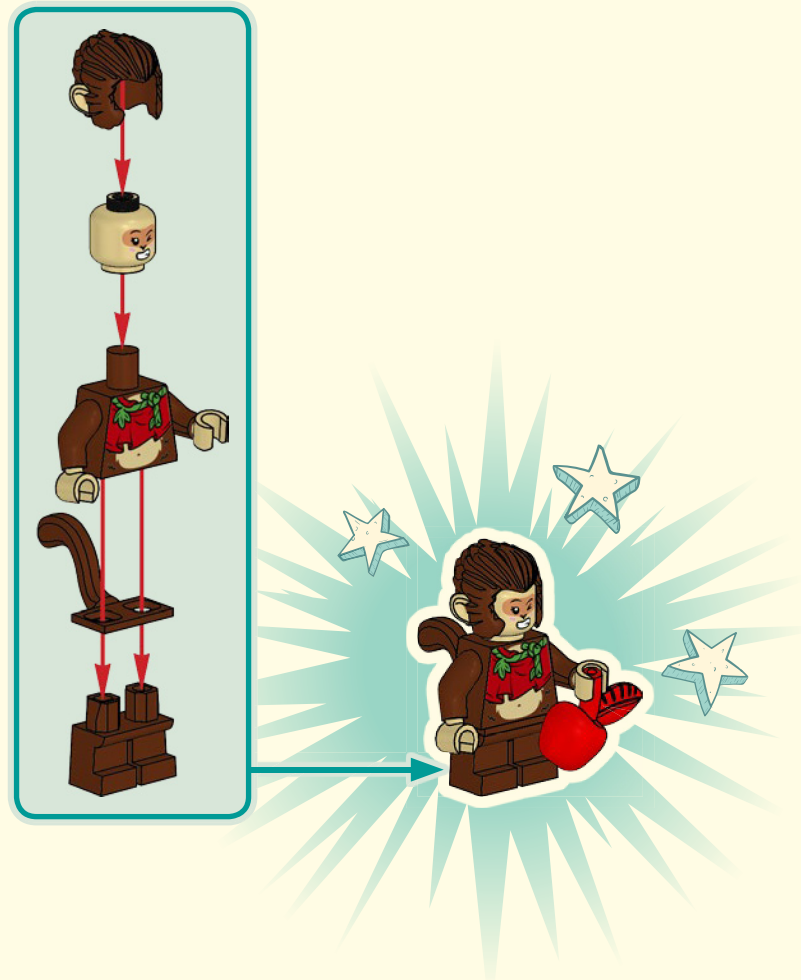
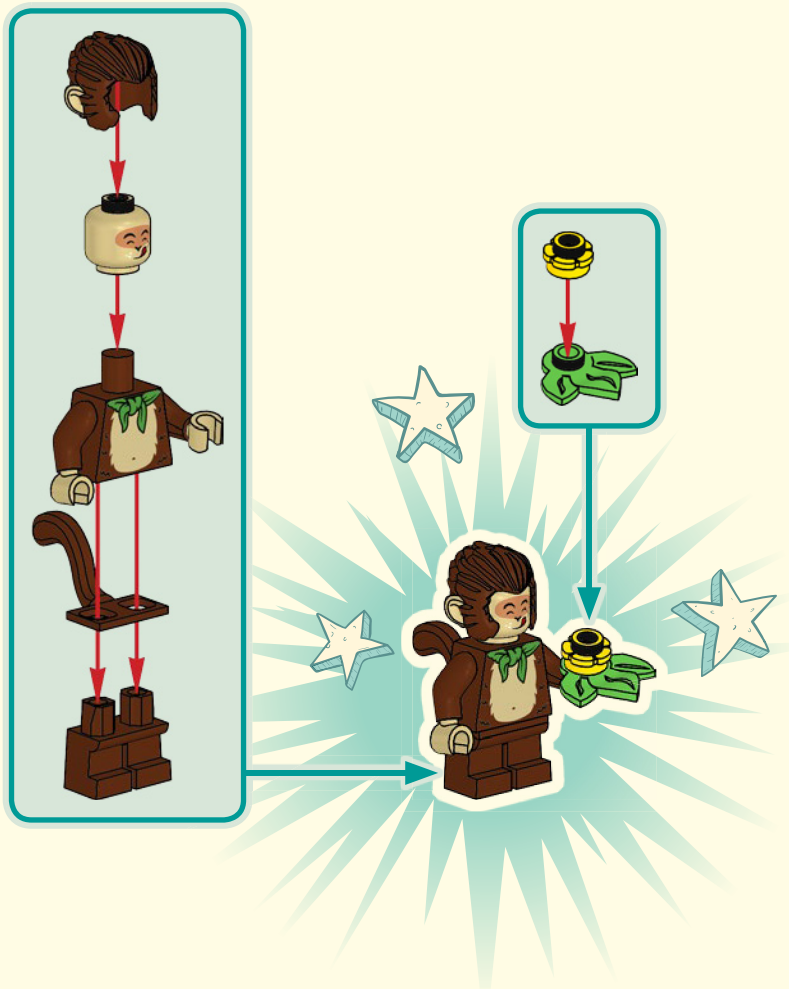
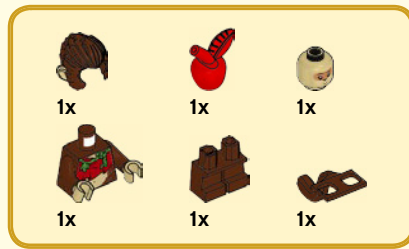
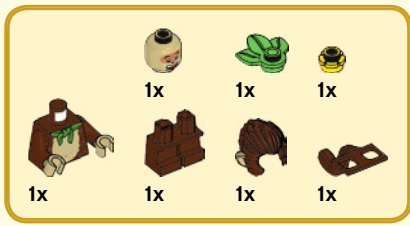

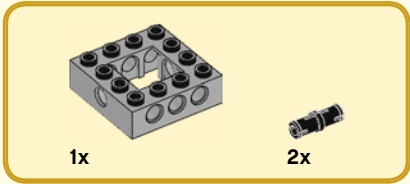

65

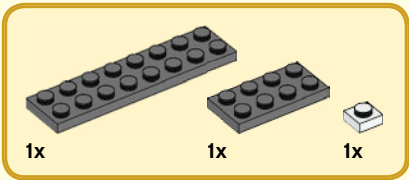
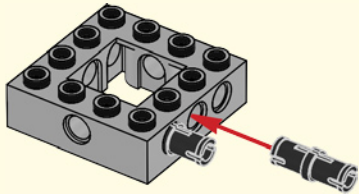

66

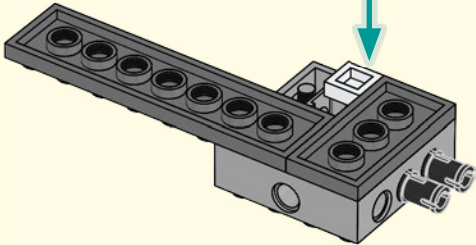



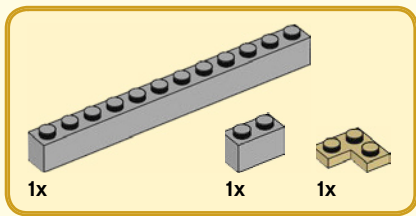

67

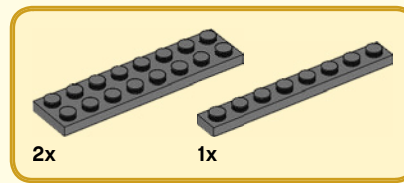
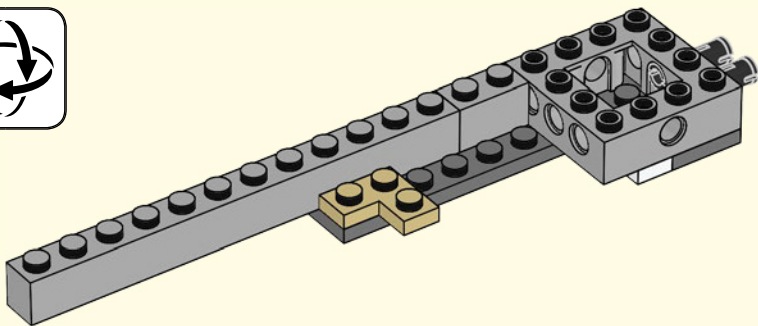

68

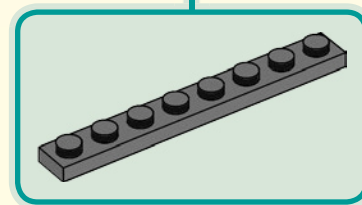
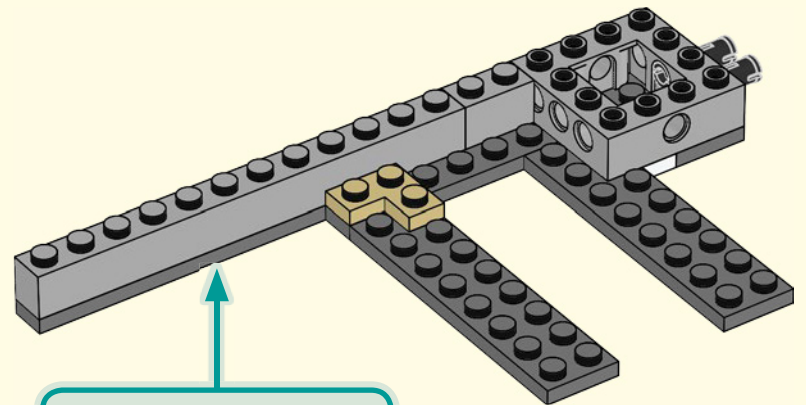



1x



2x

# 69

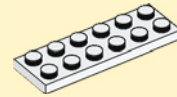
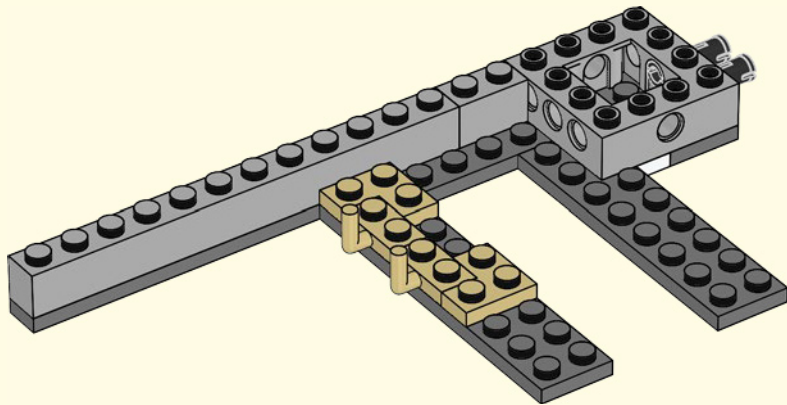

1x

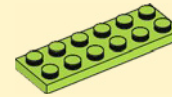

1x

# 70

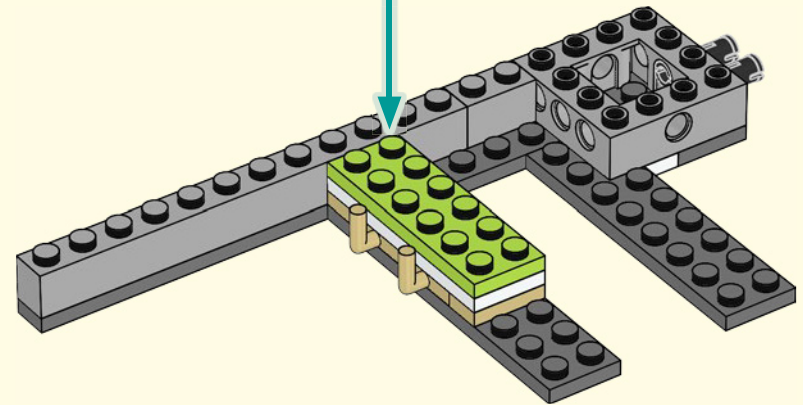
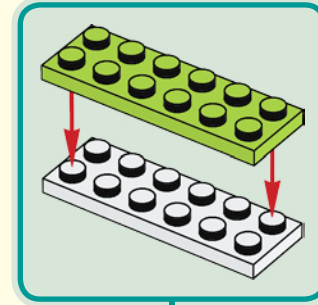

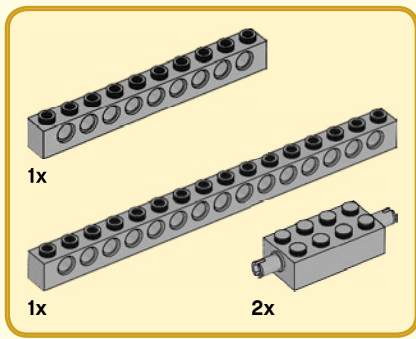

71

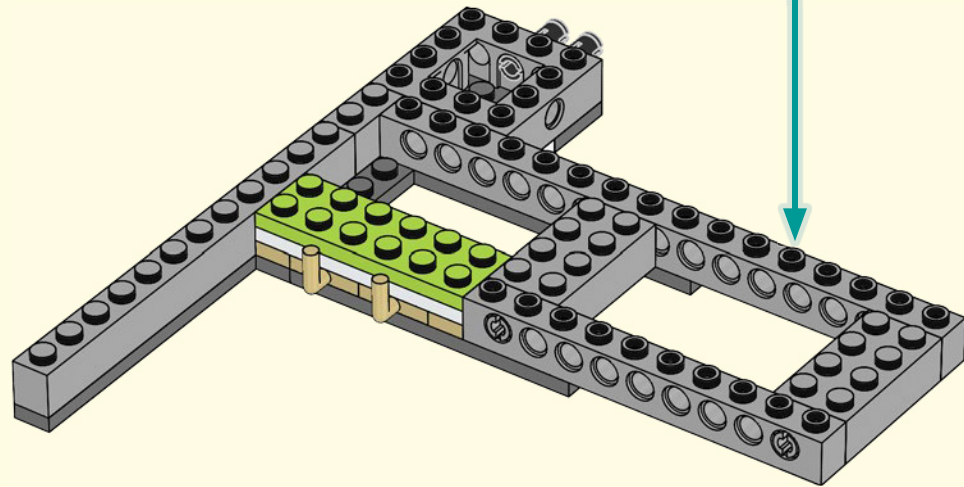
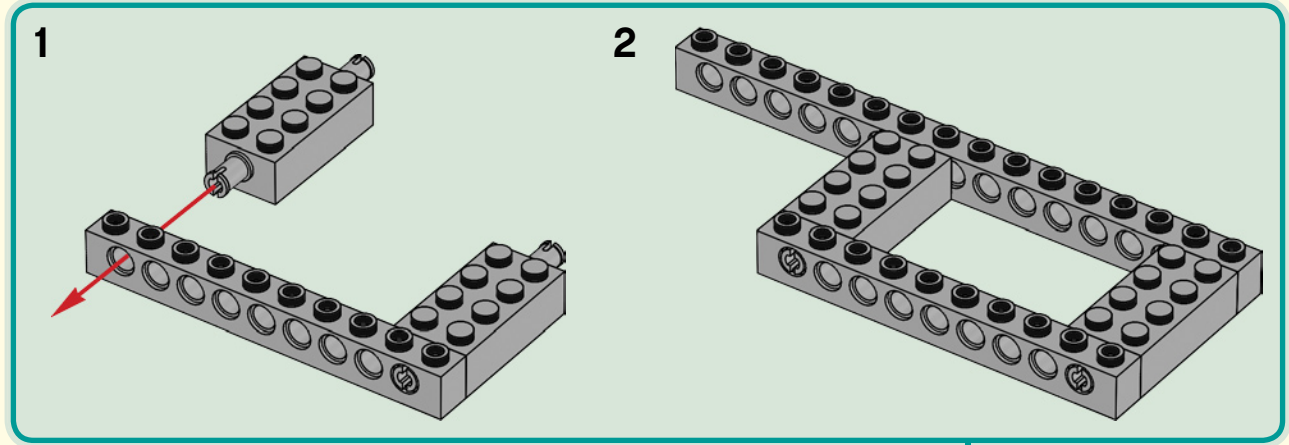

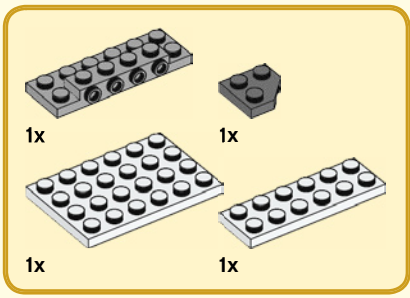

72

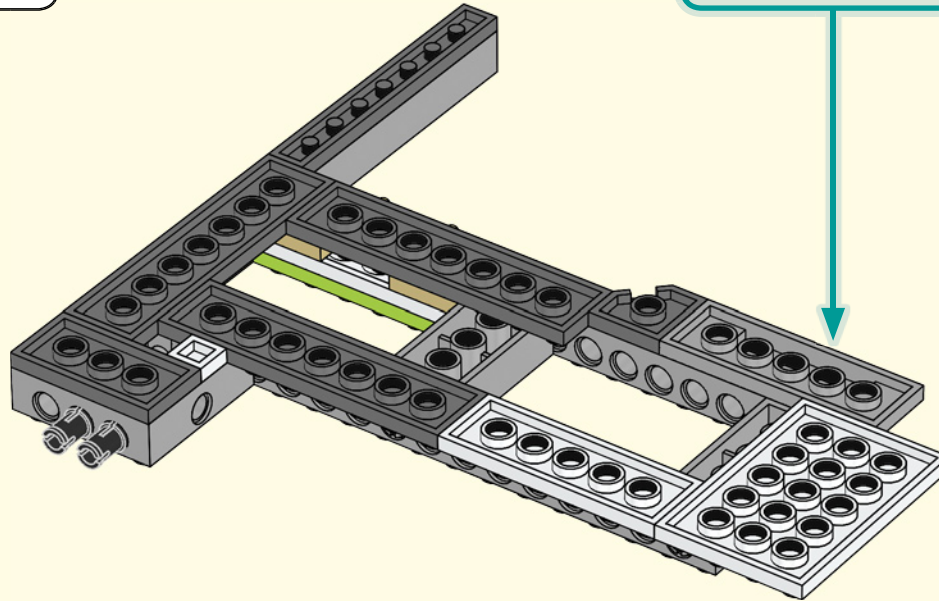
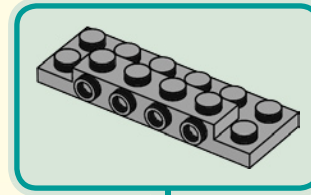



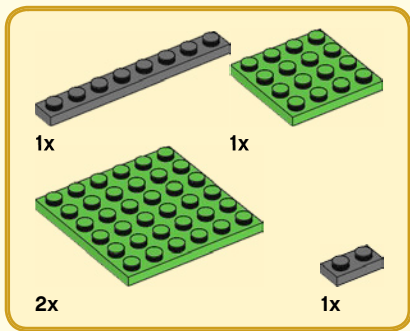

73

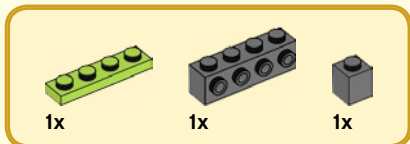
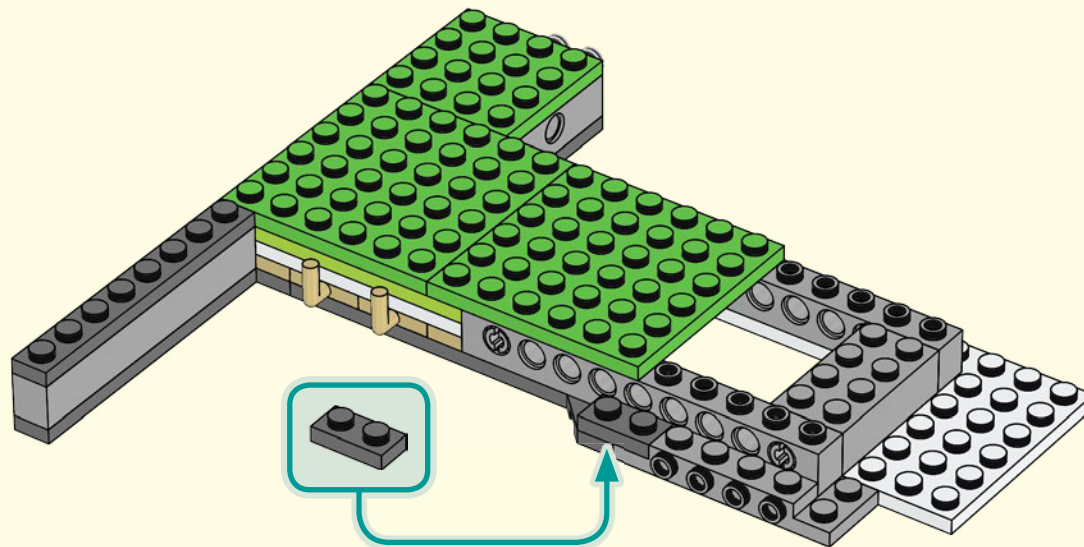

74

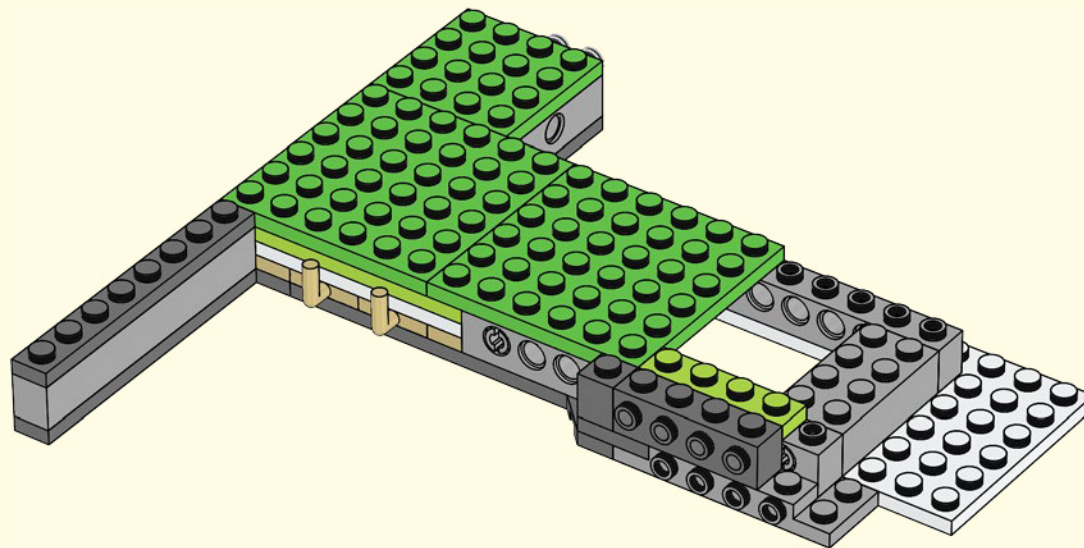

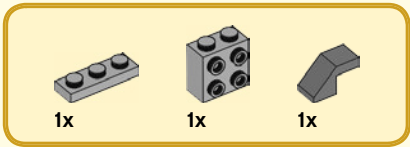

# 75

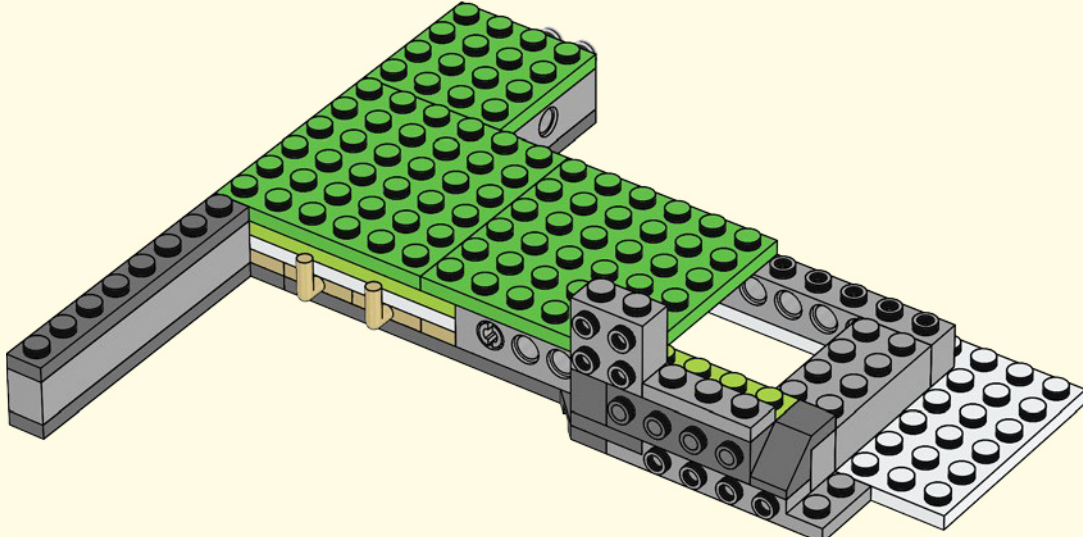

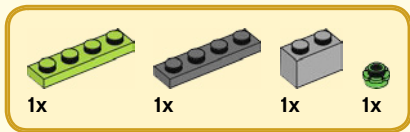

76

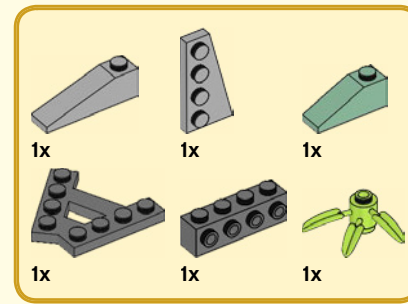
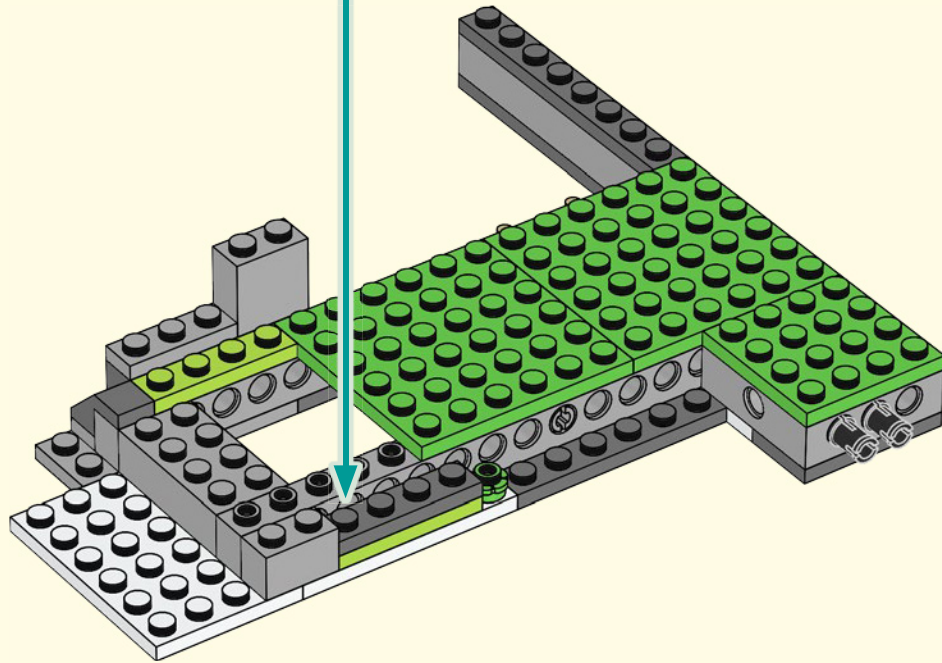
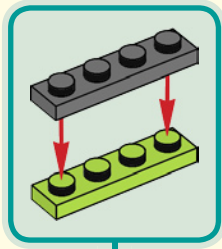

77

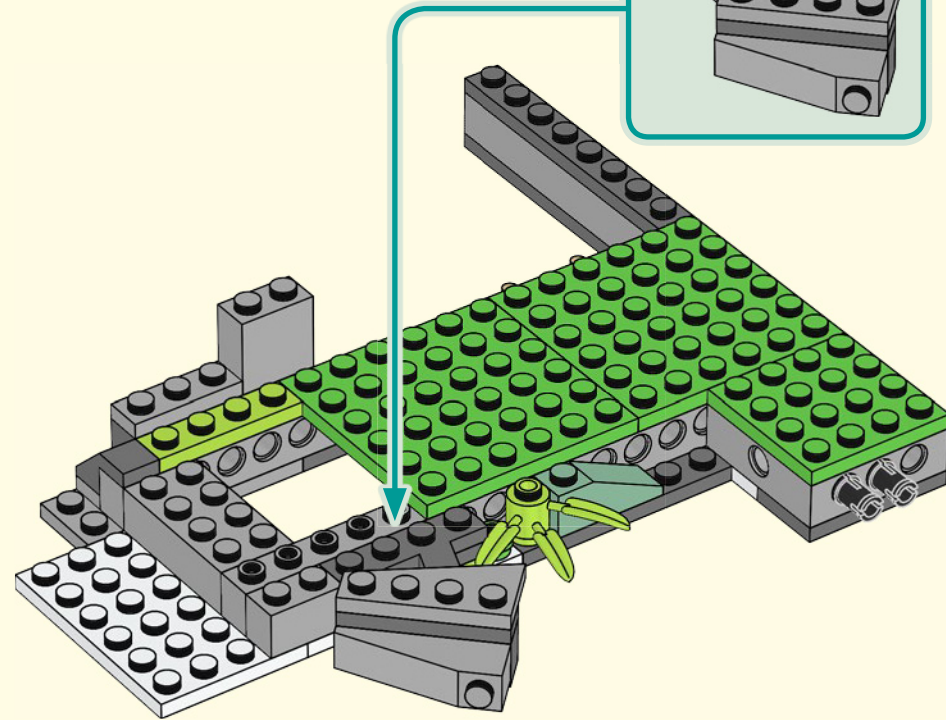
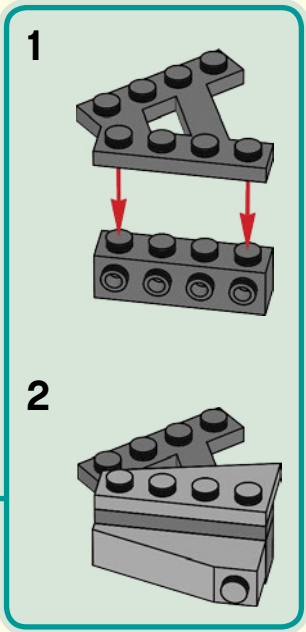



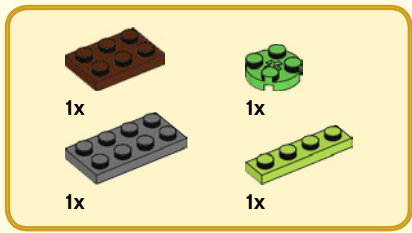

78

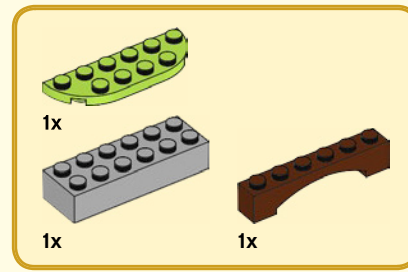
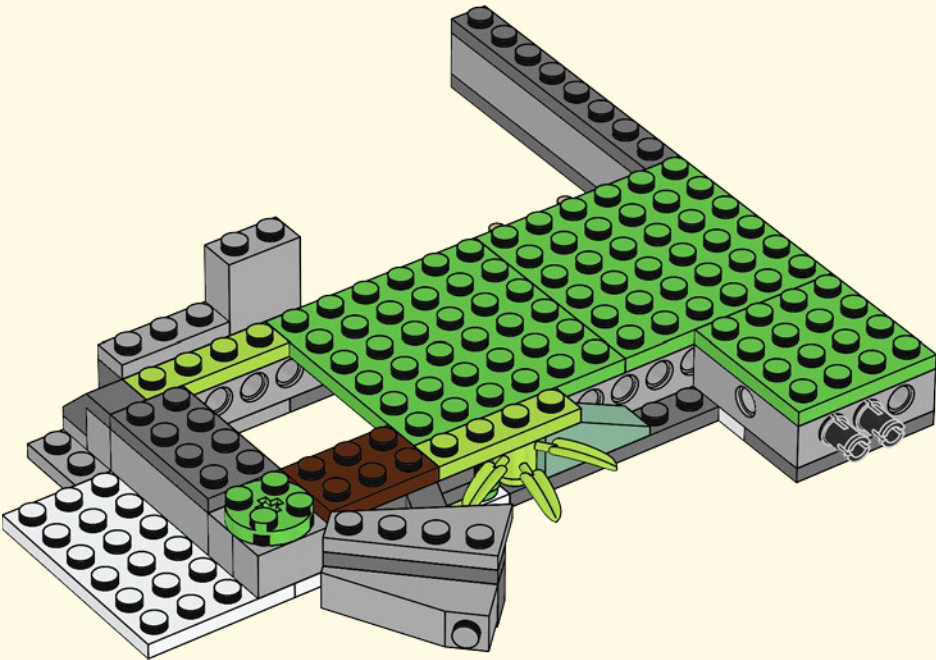

79

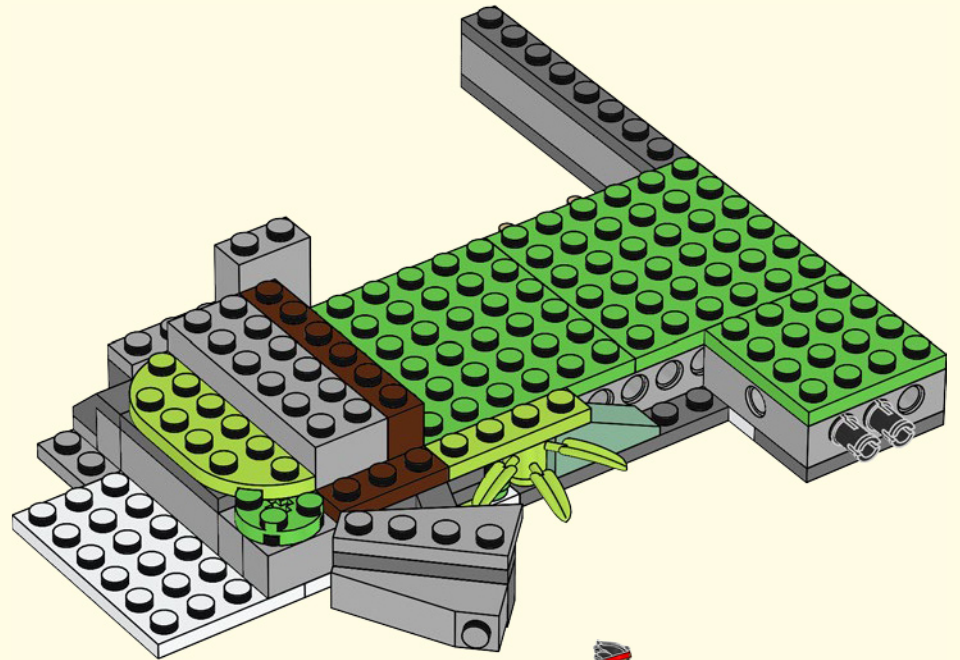



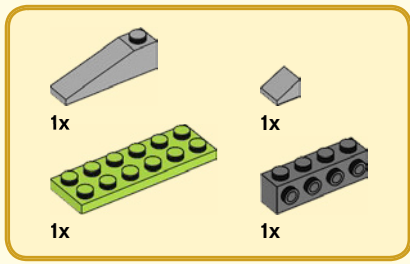

80

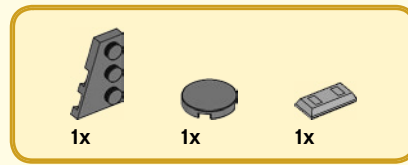
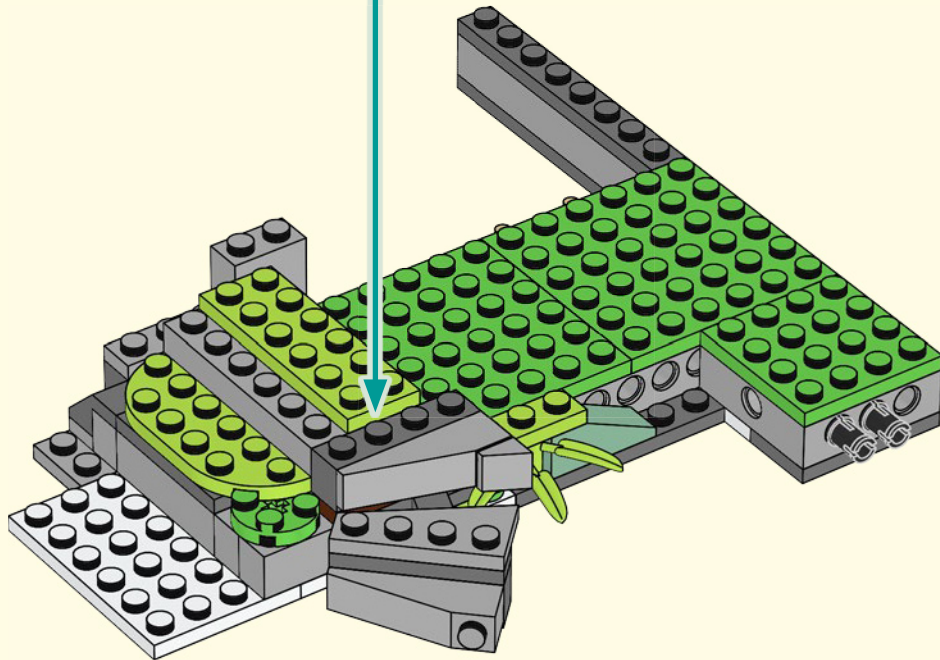
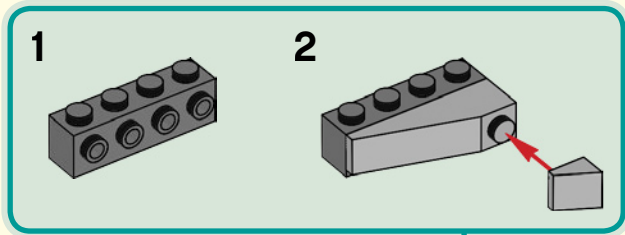

81

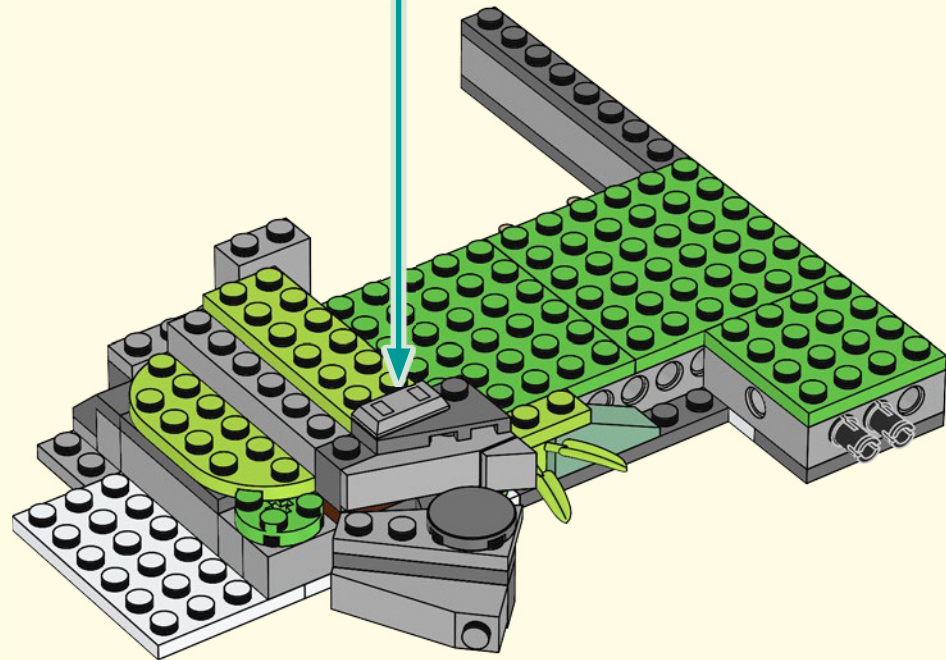
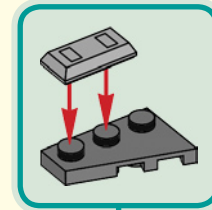

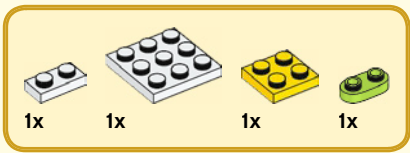

82

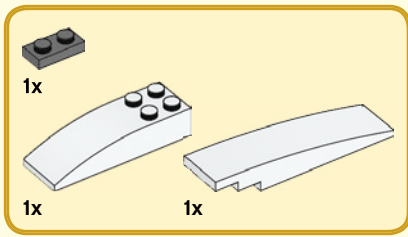
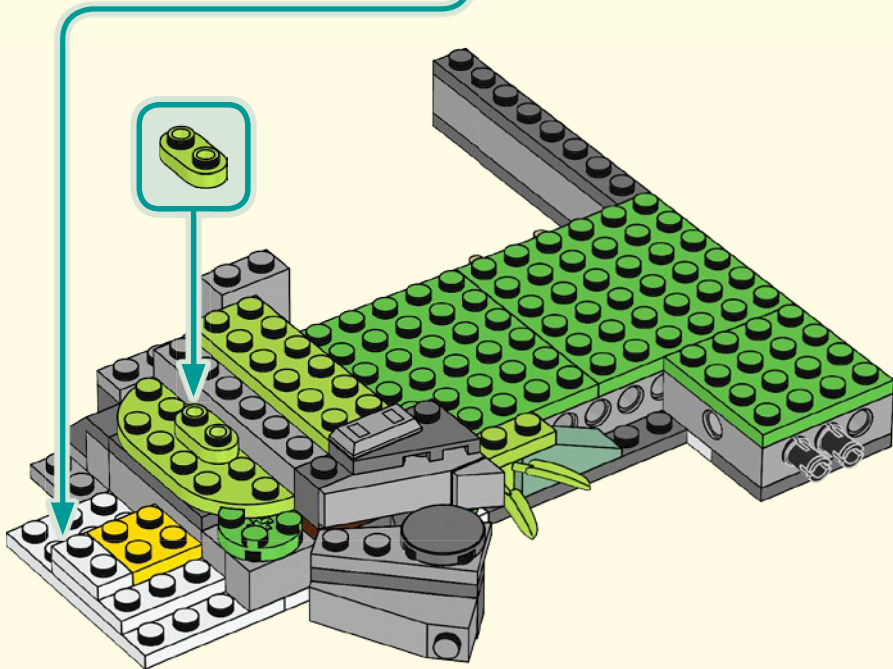
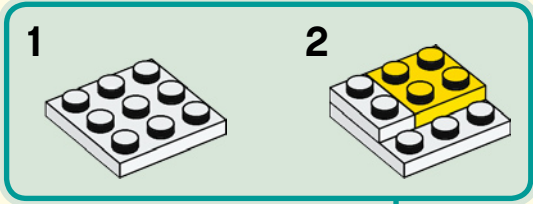

83

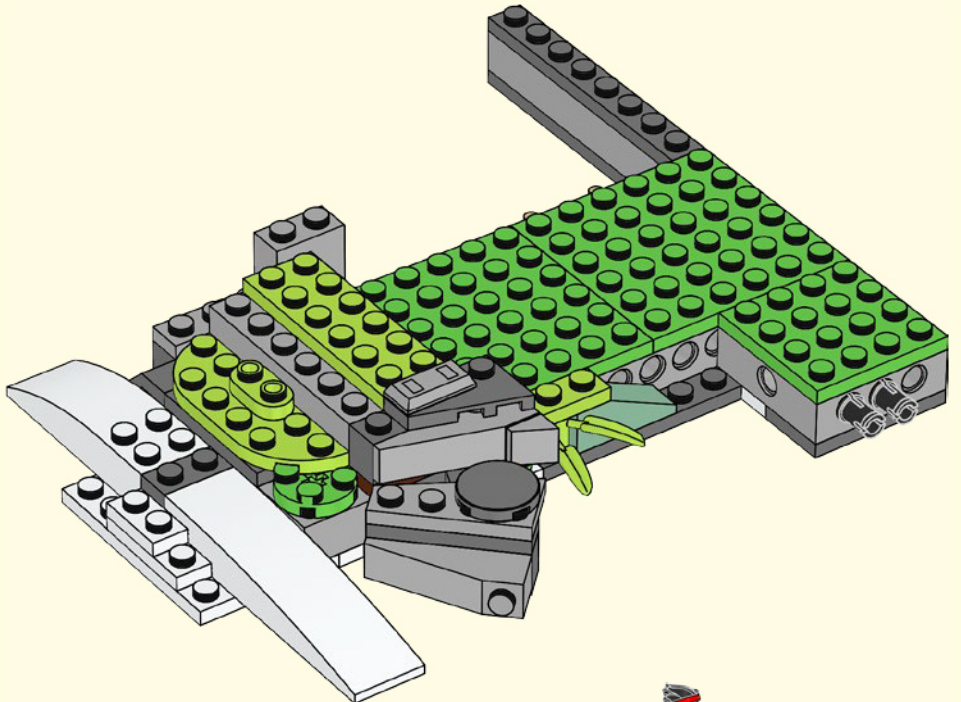

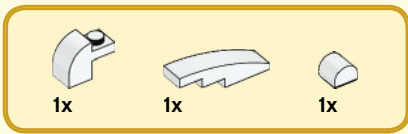

84

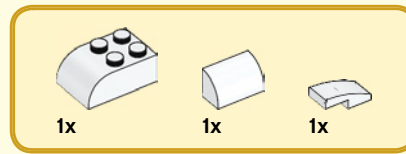
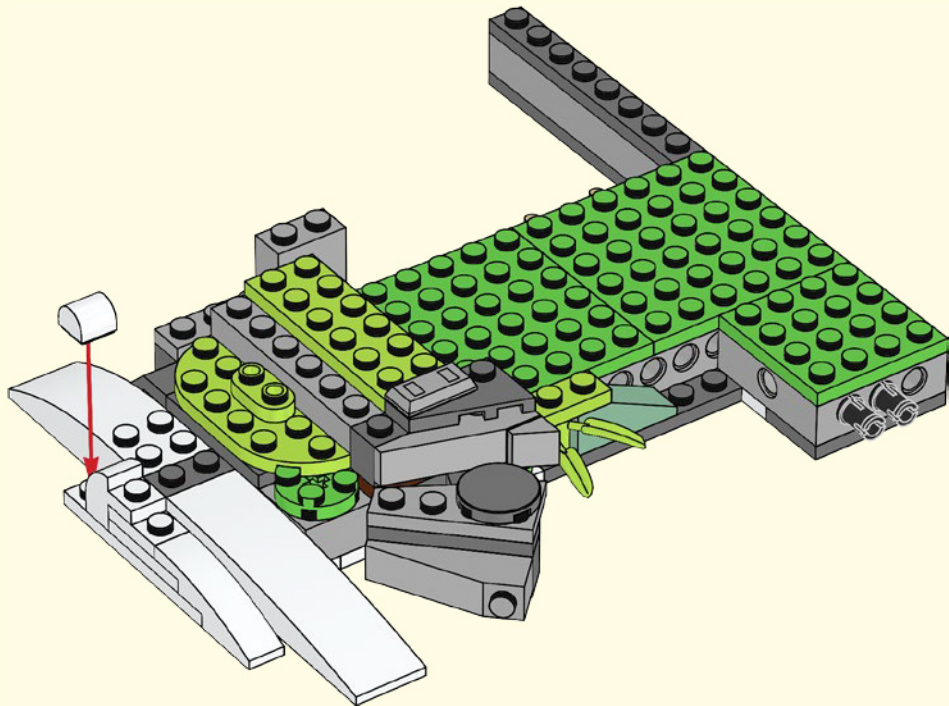

85

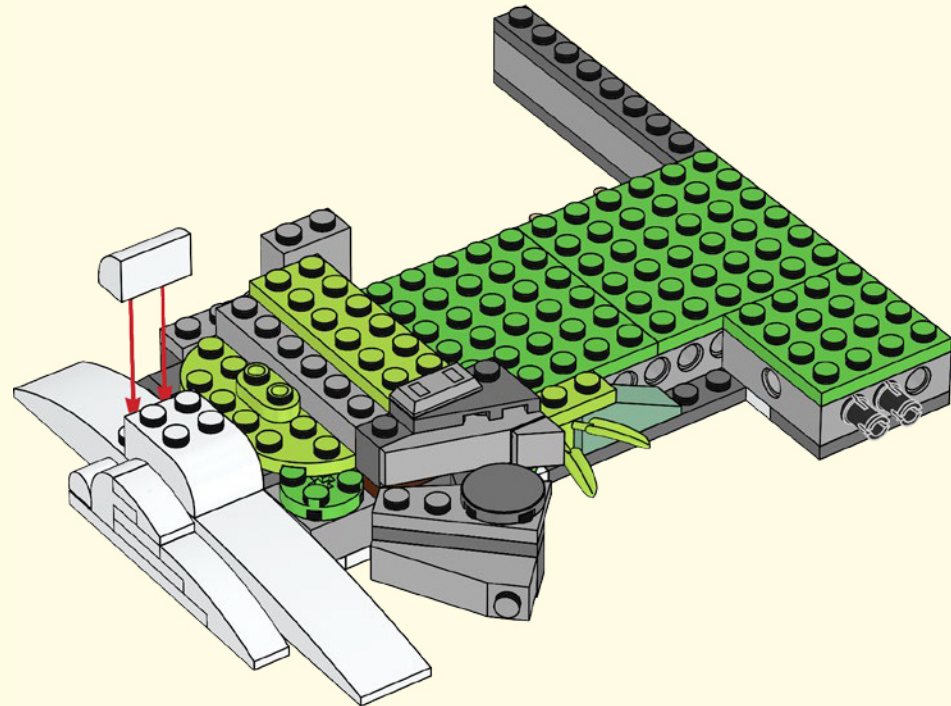





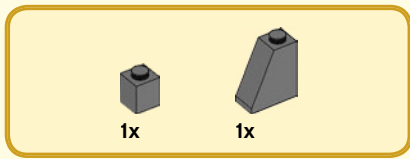

86

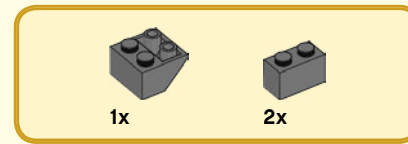
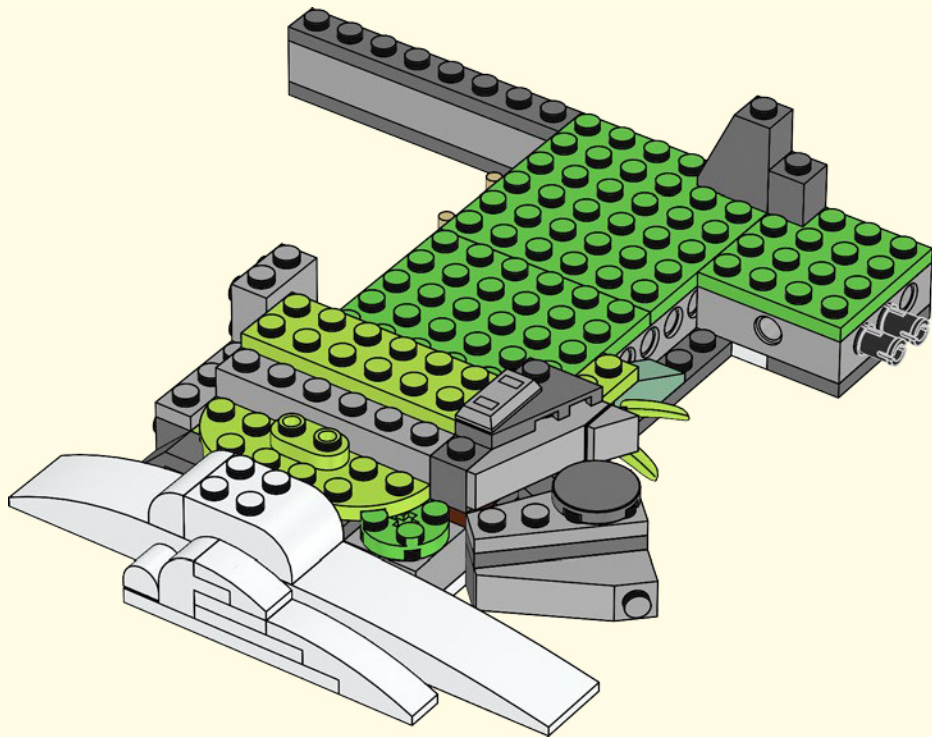

87

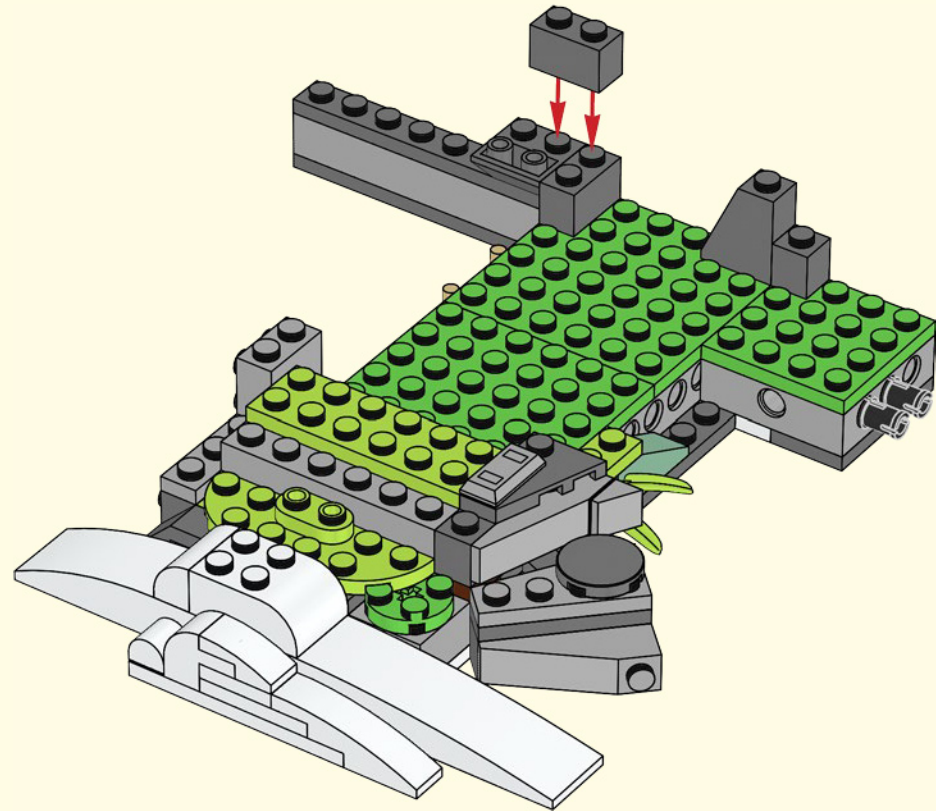



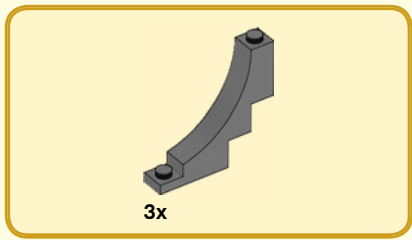

88

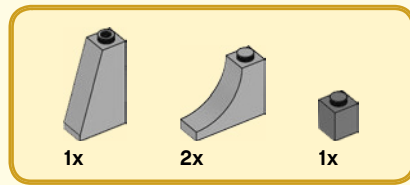
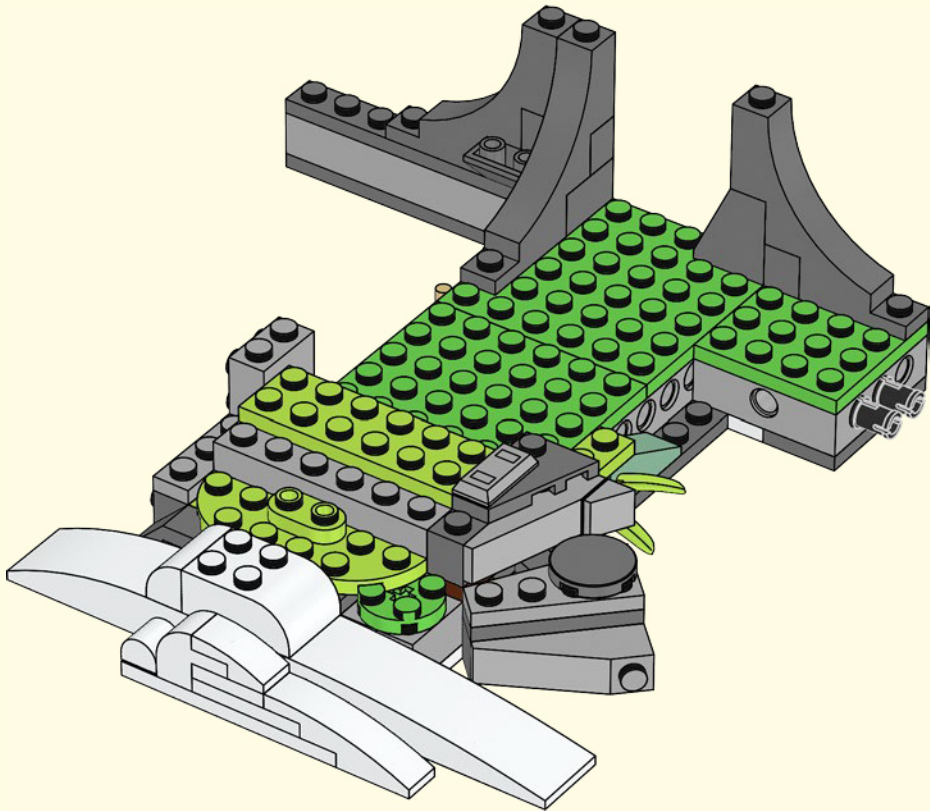

89

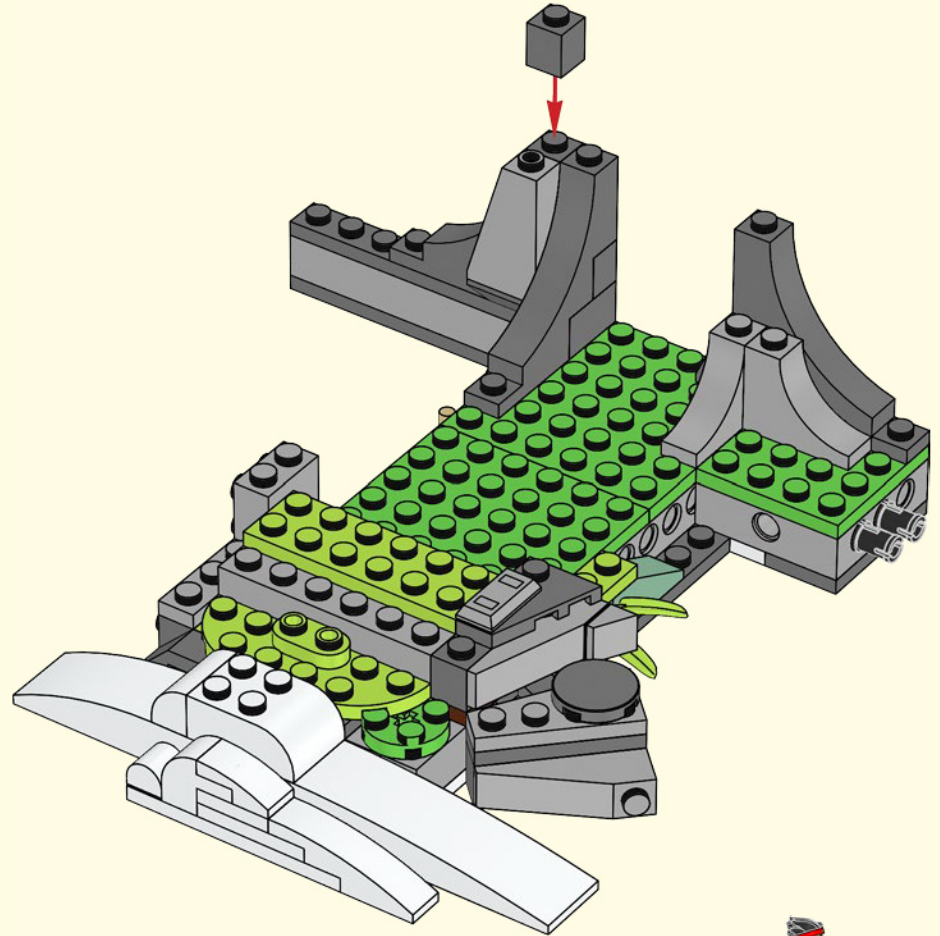

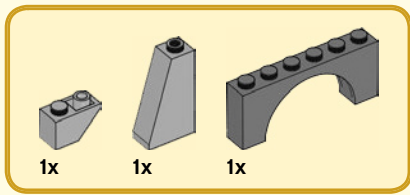

90

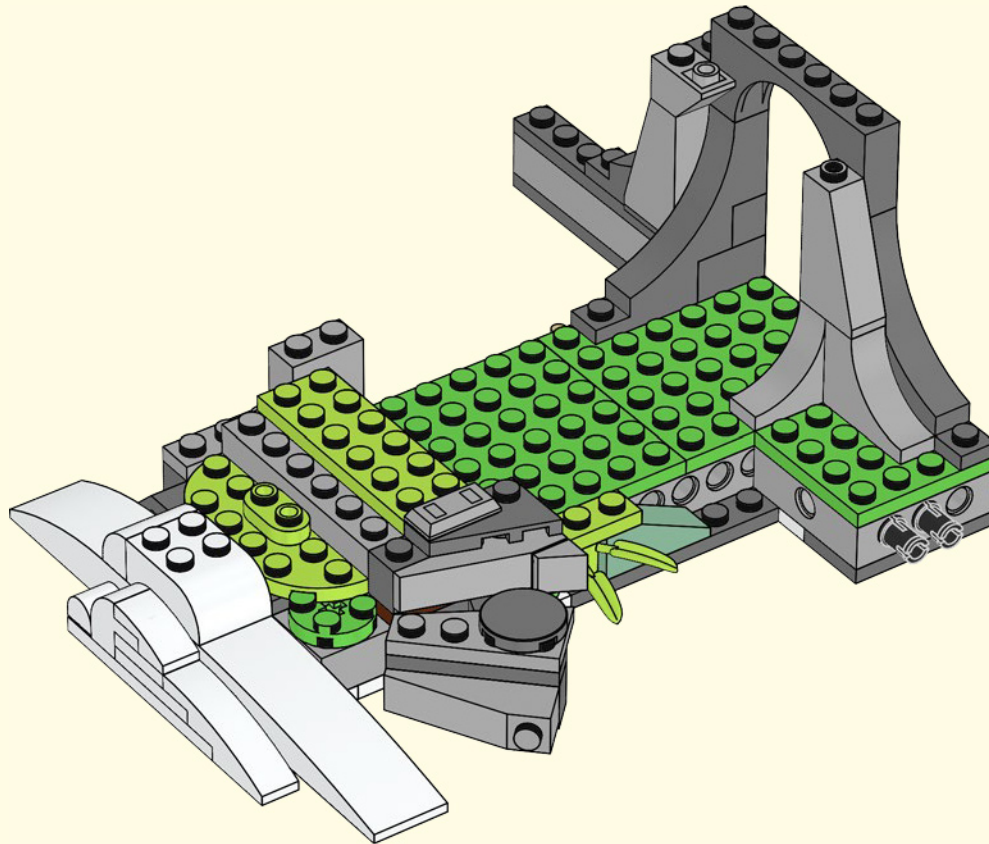

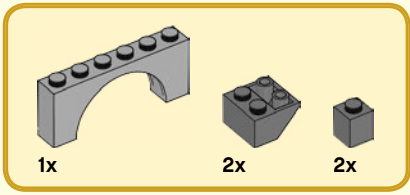

91

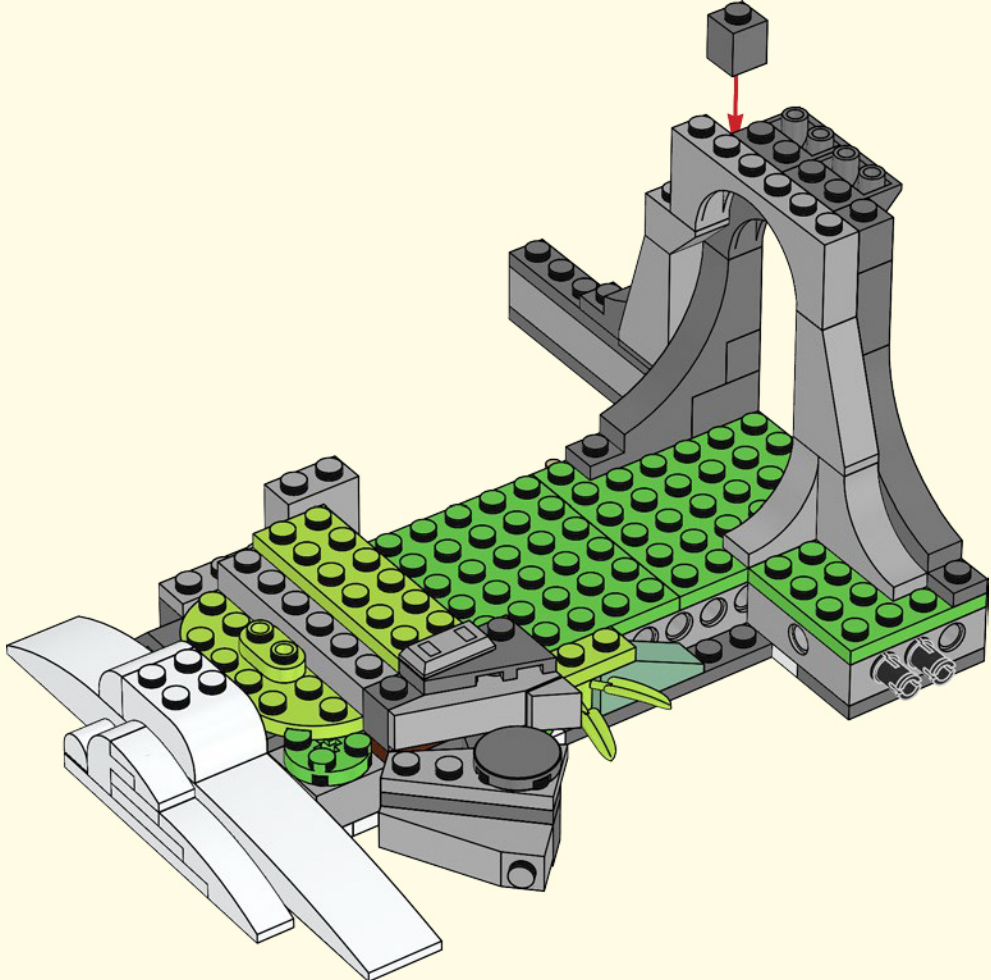

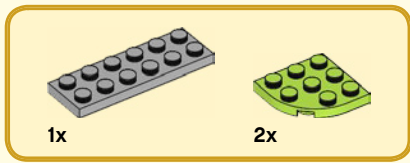

92

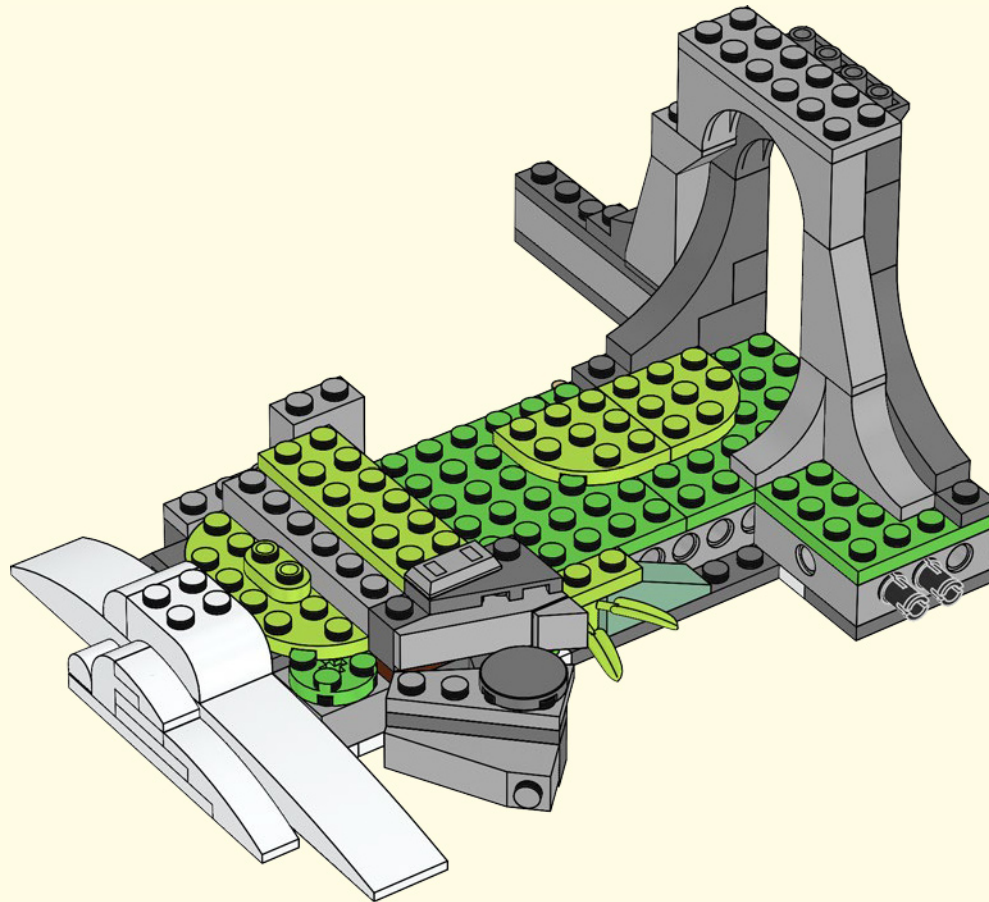



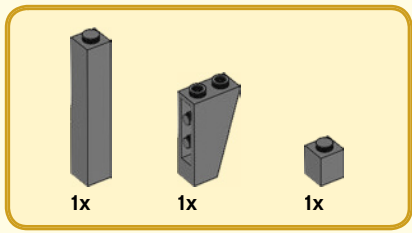

93

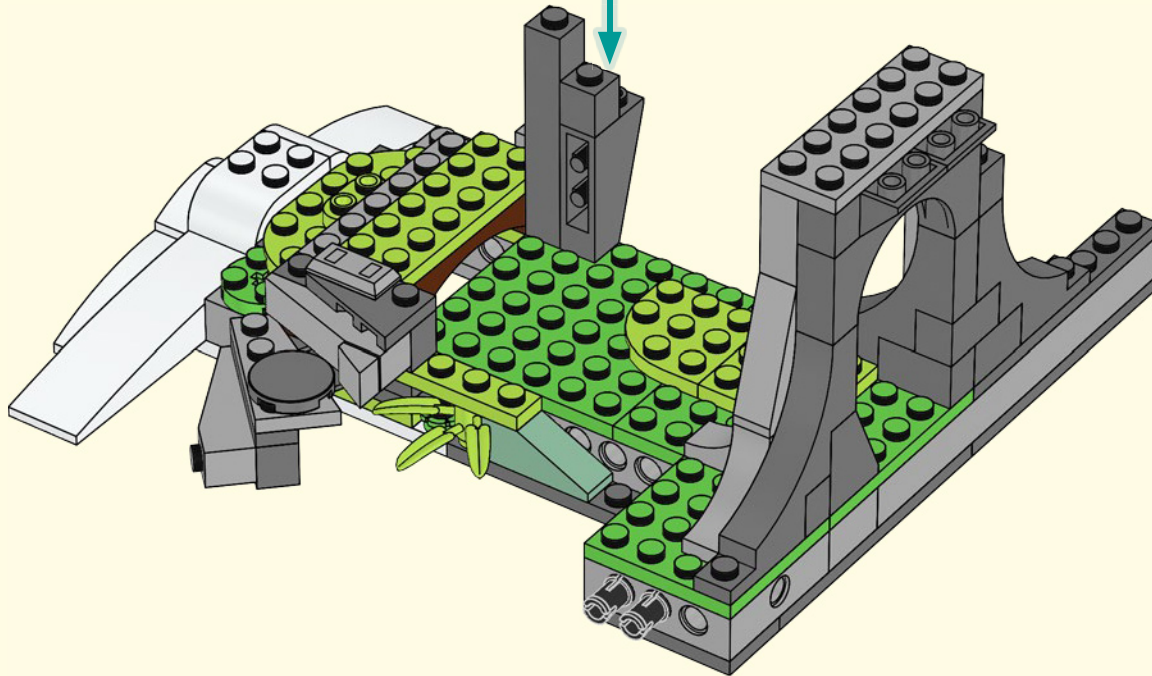
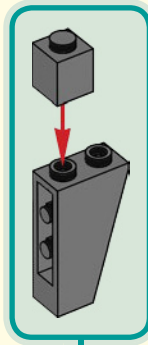





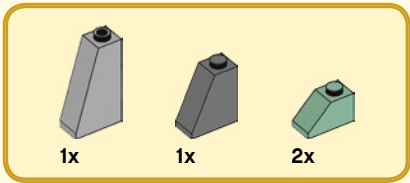

95

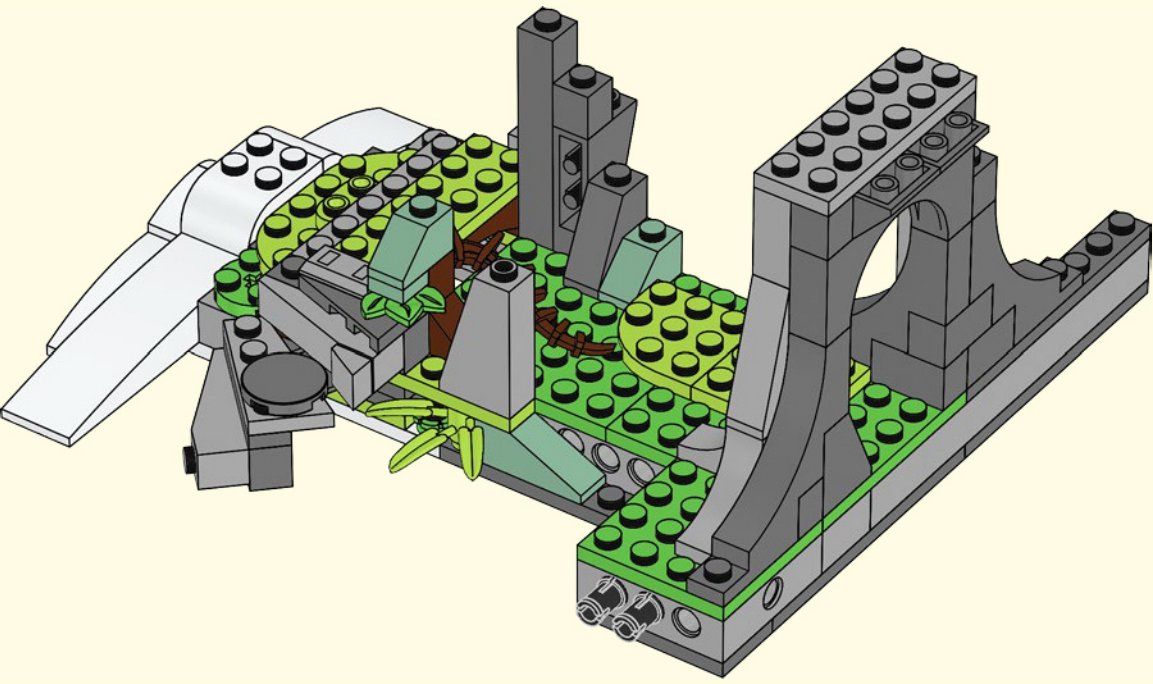

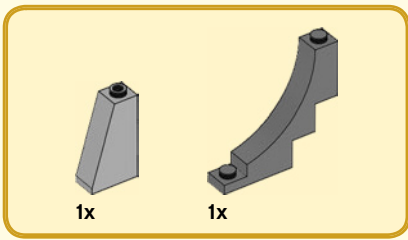

96

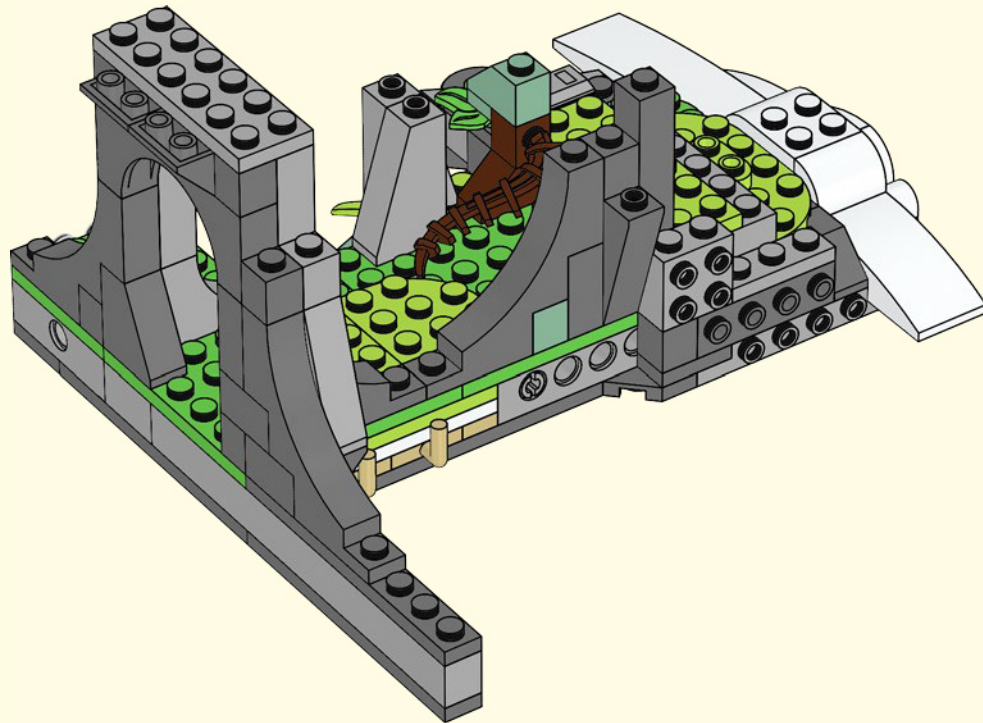

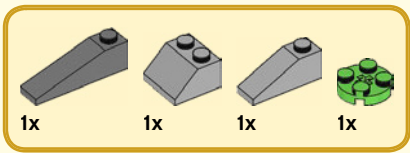

97

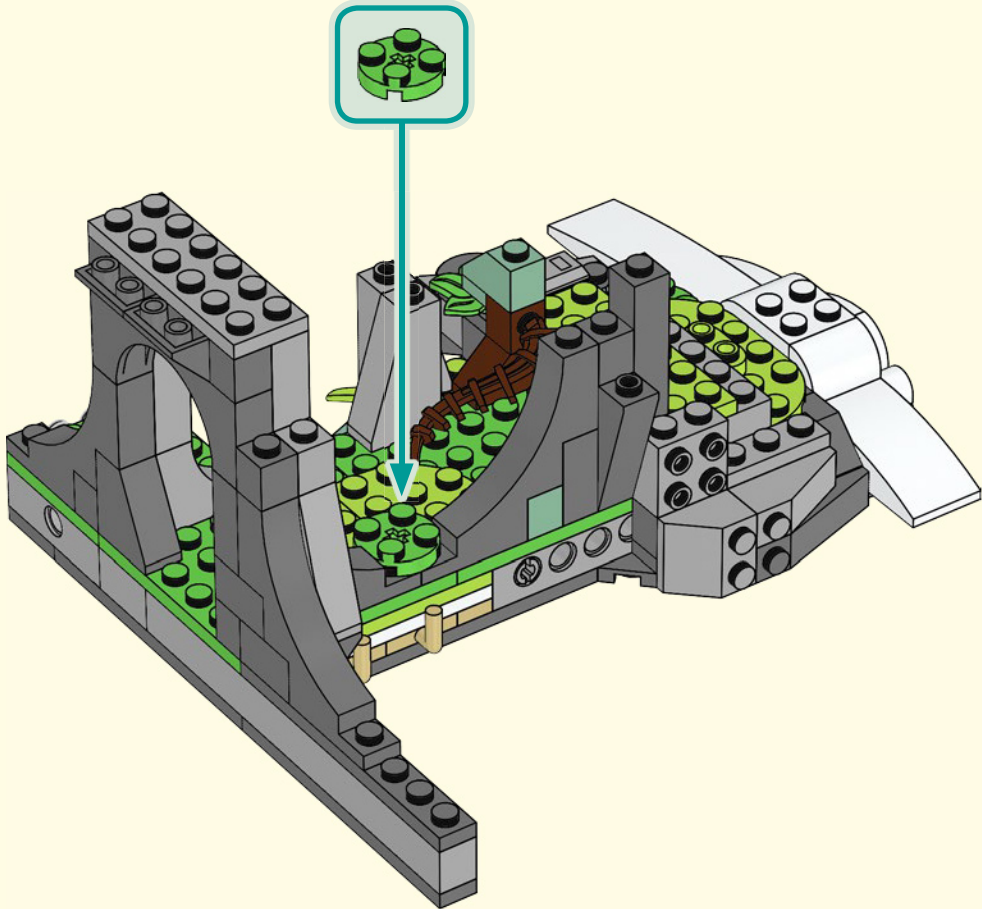

1x 1x 1x

98

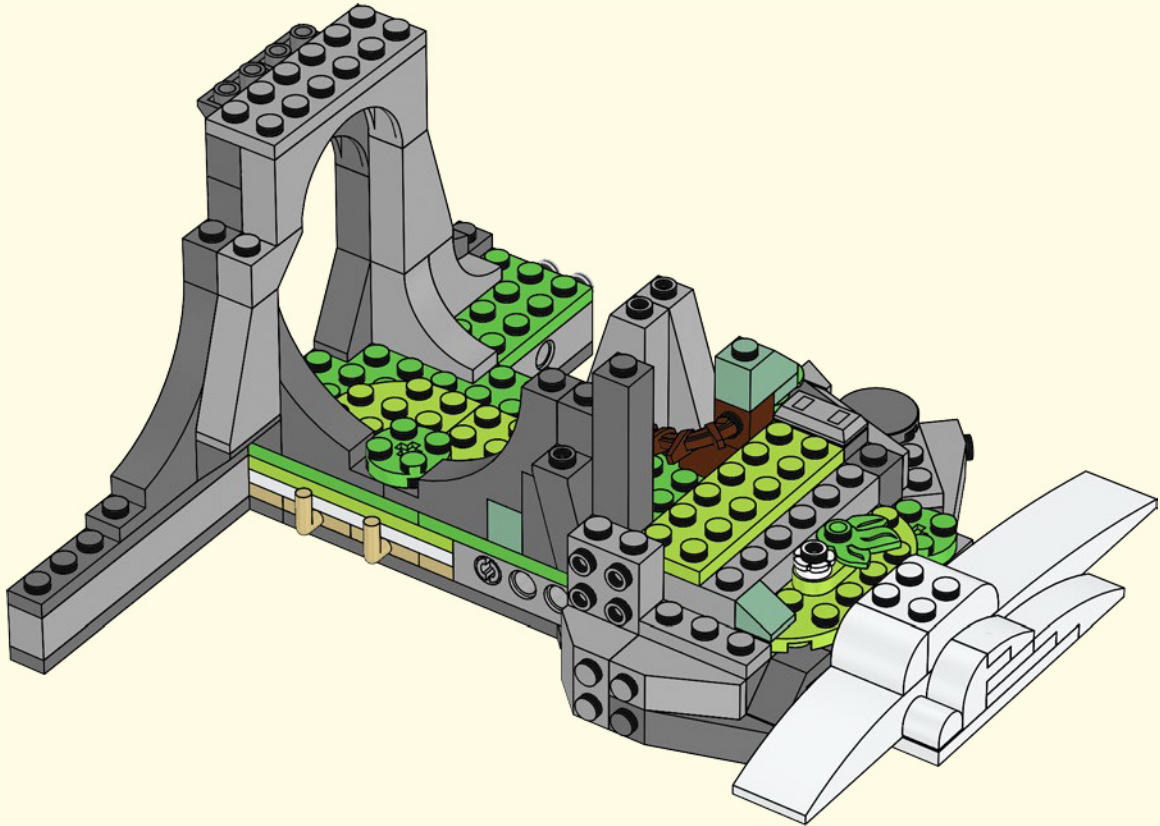



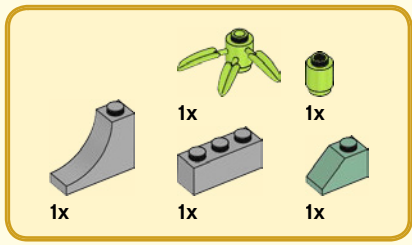

99

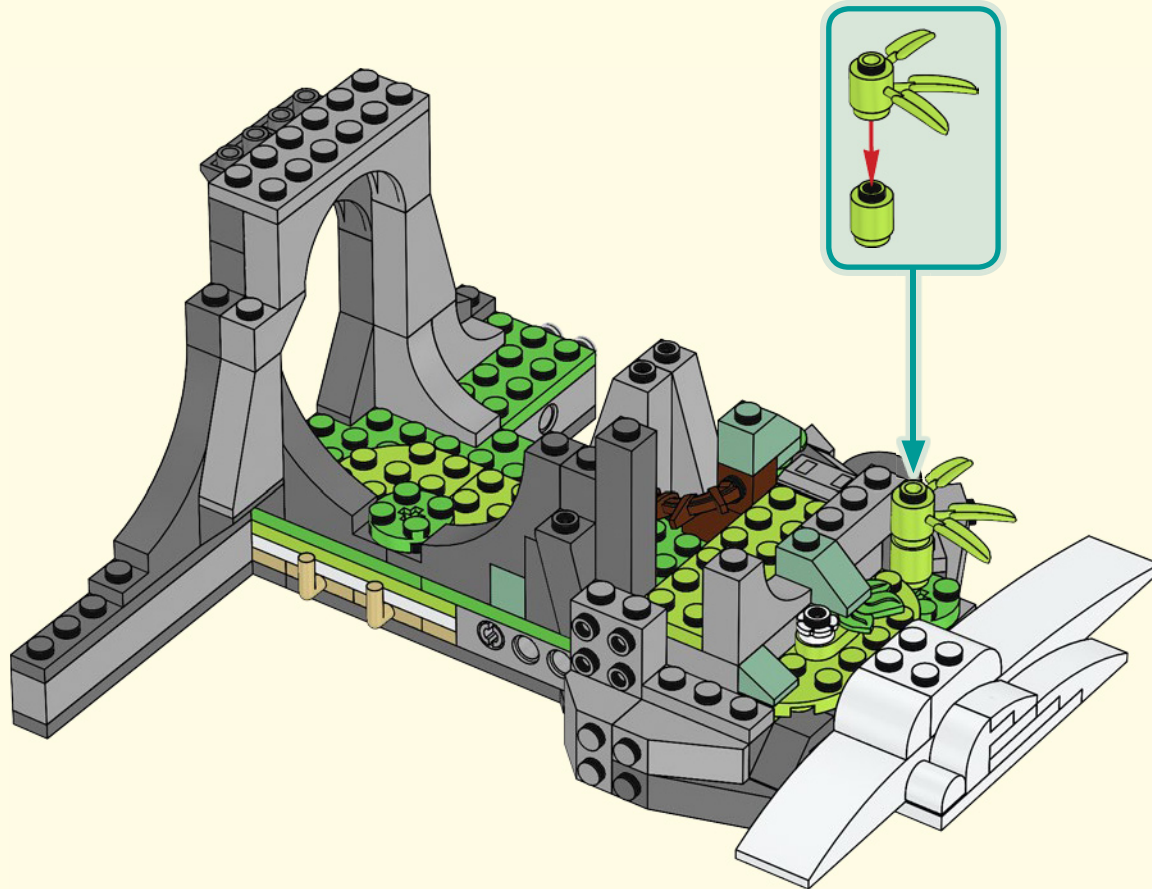

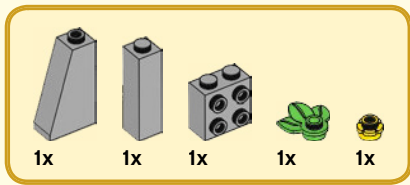

100

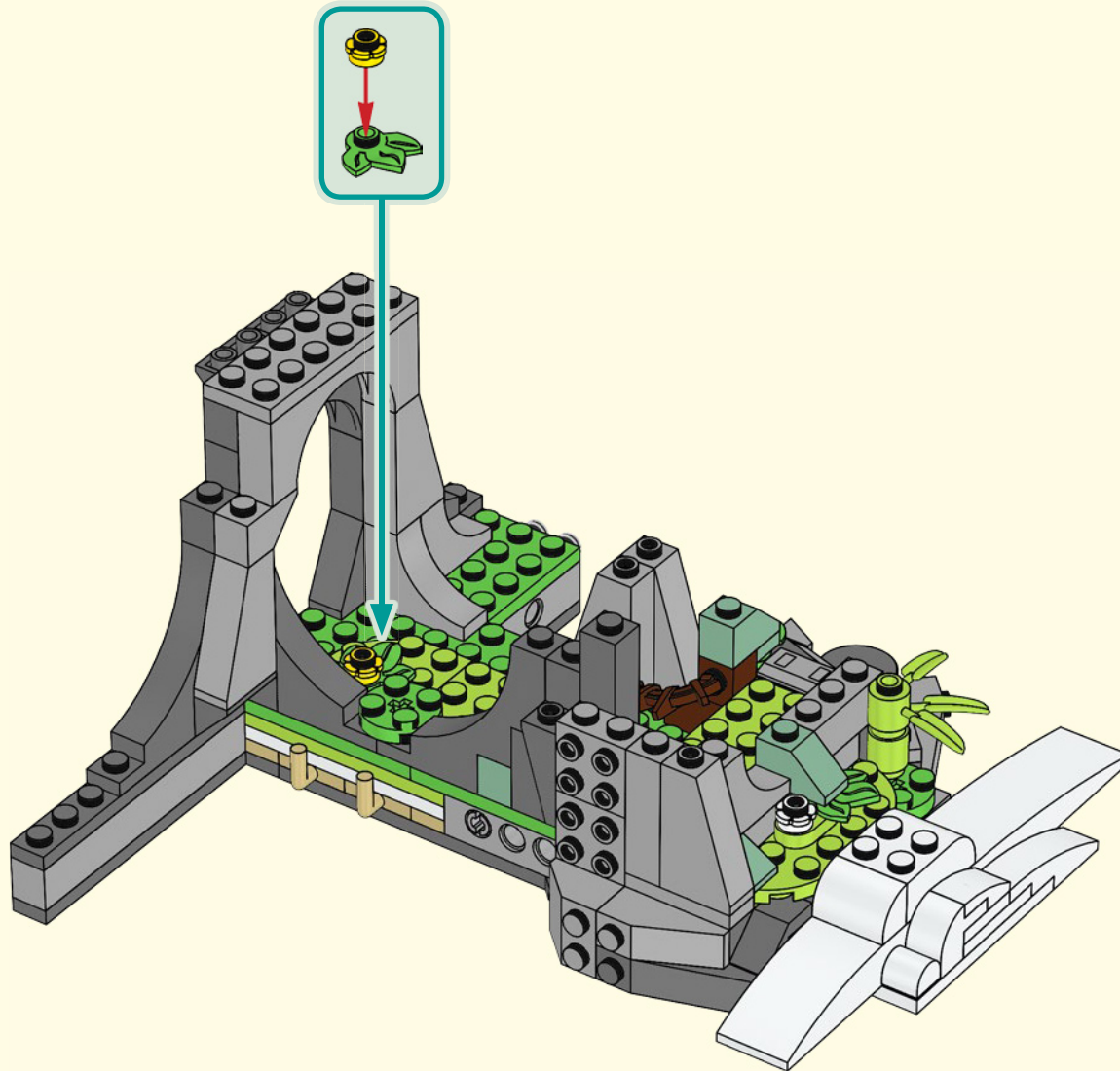

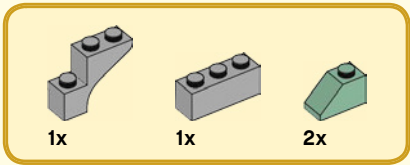

101

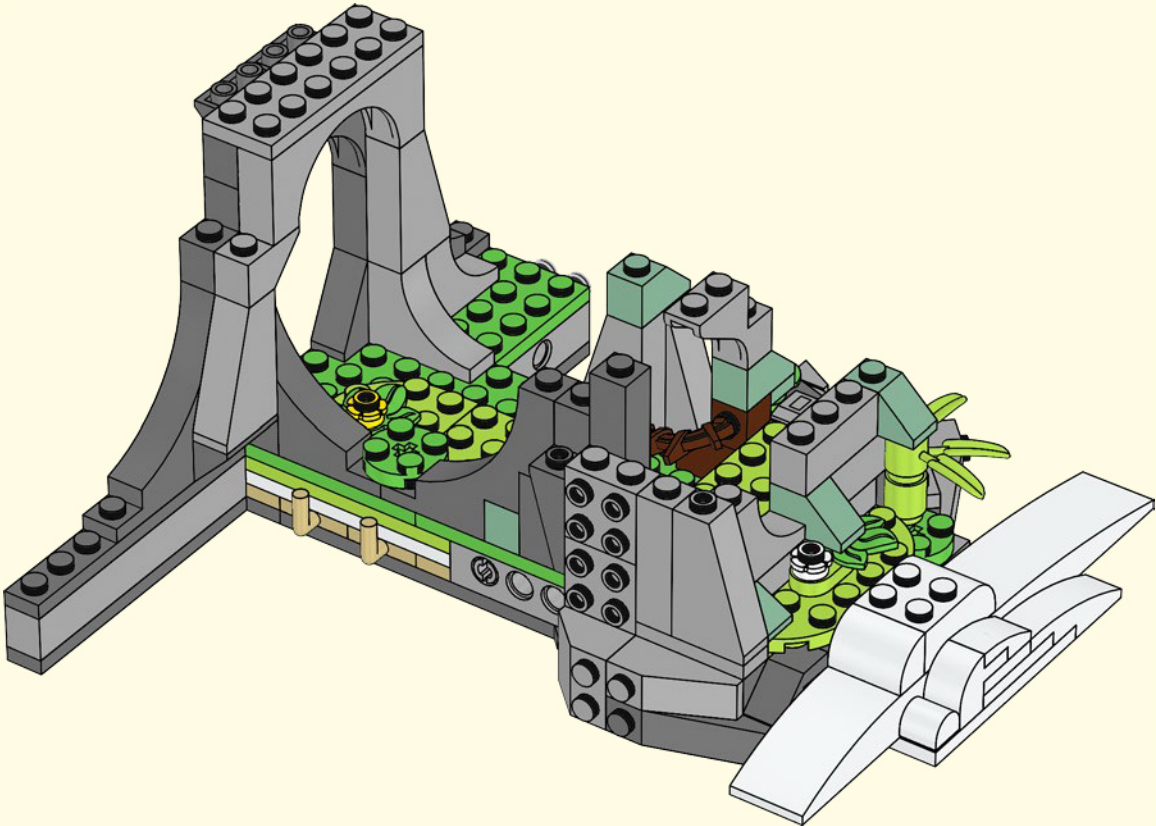

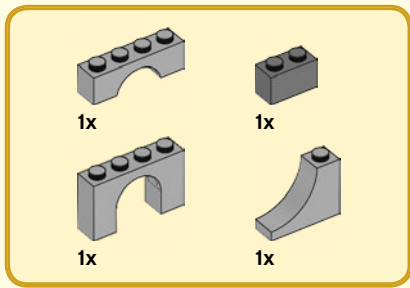

102

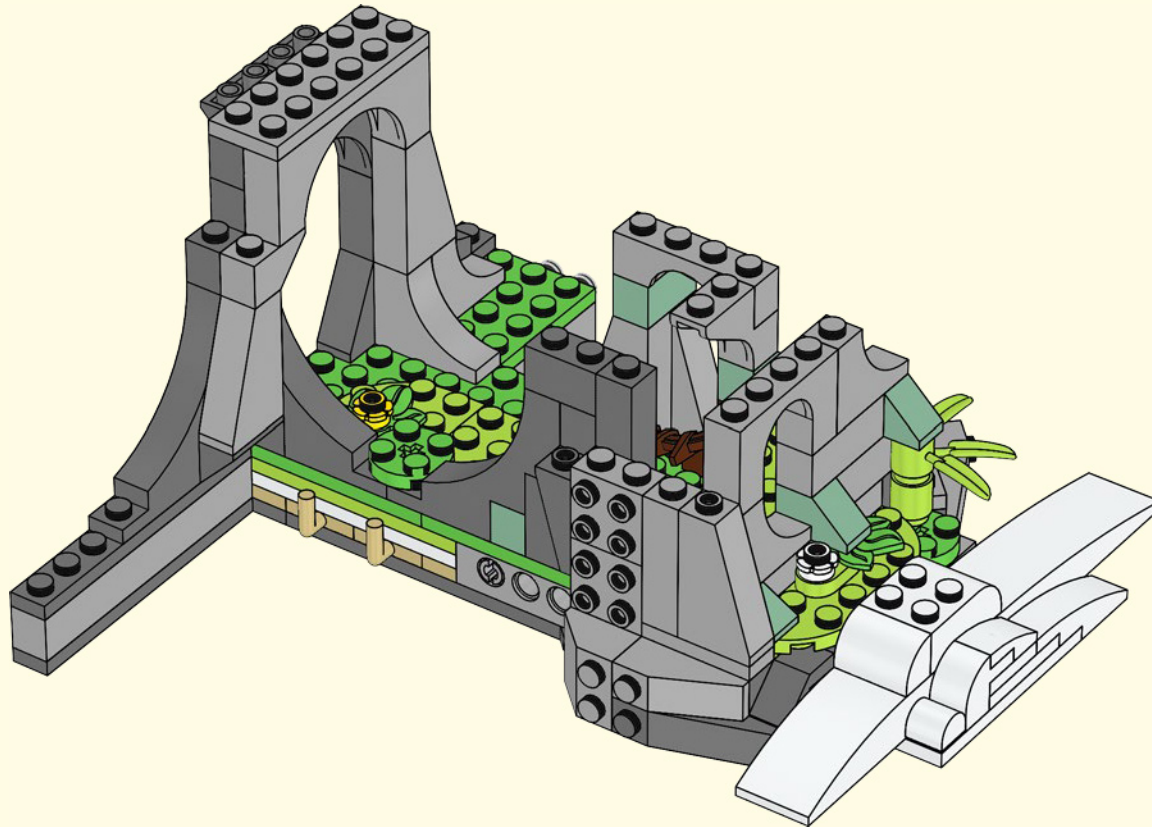



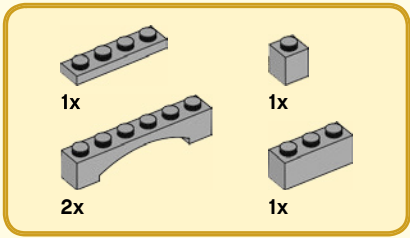

# 103

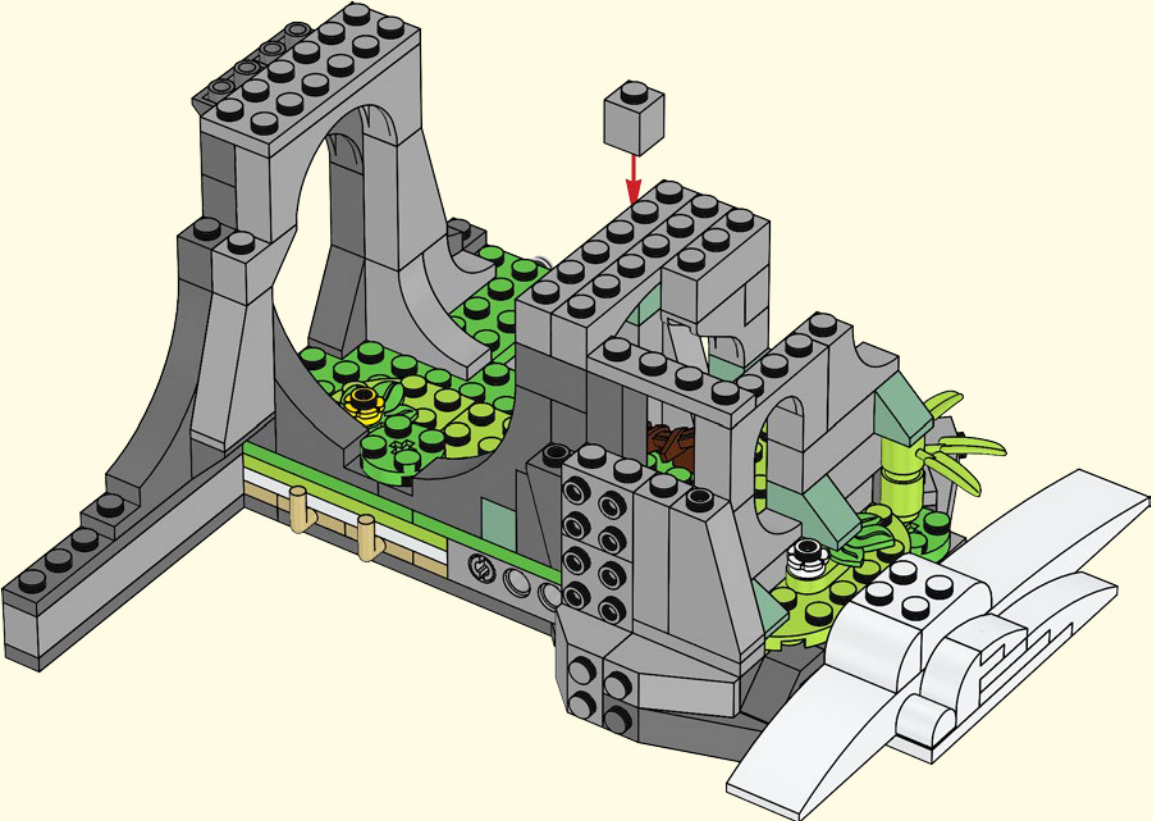

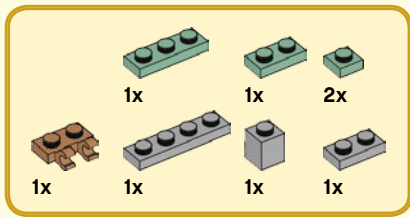

104

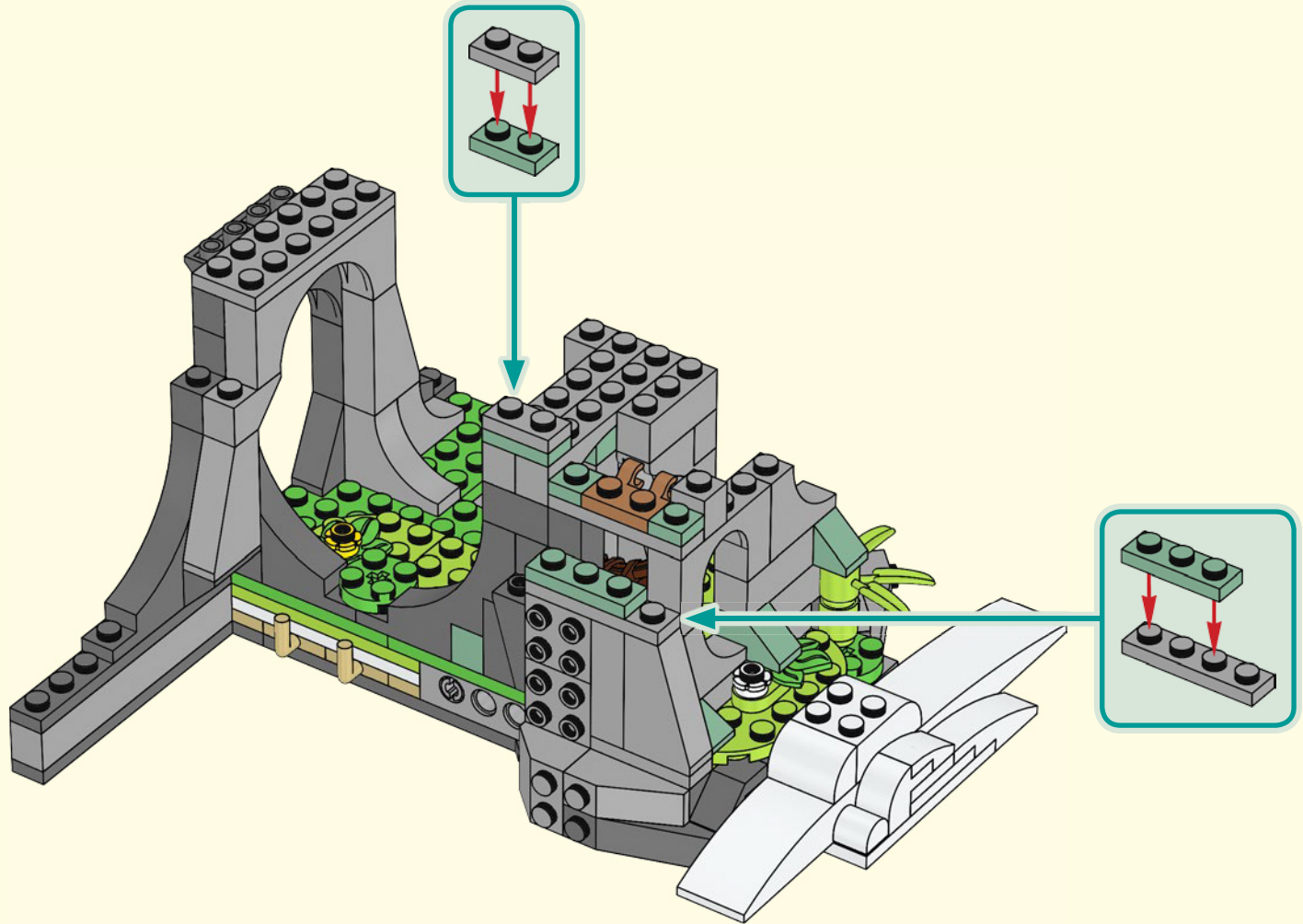

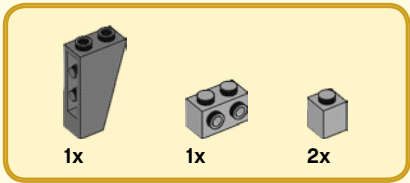

# 105

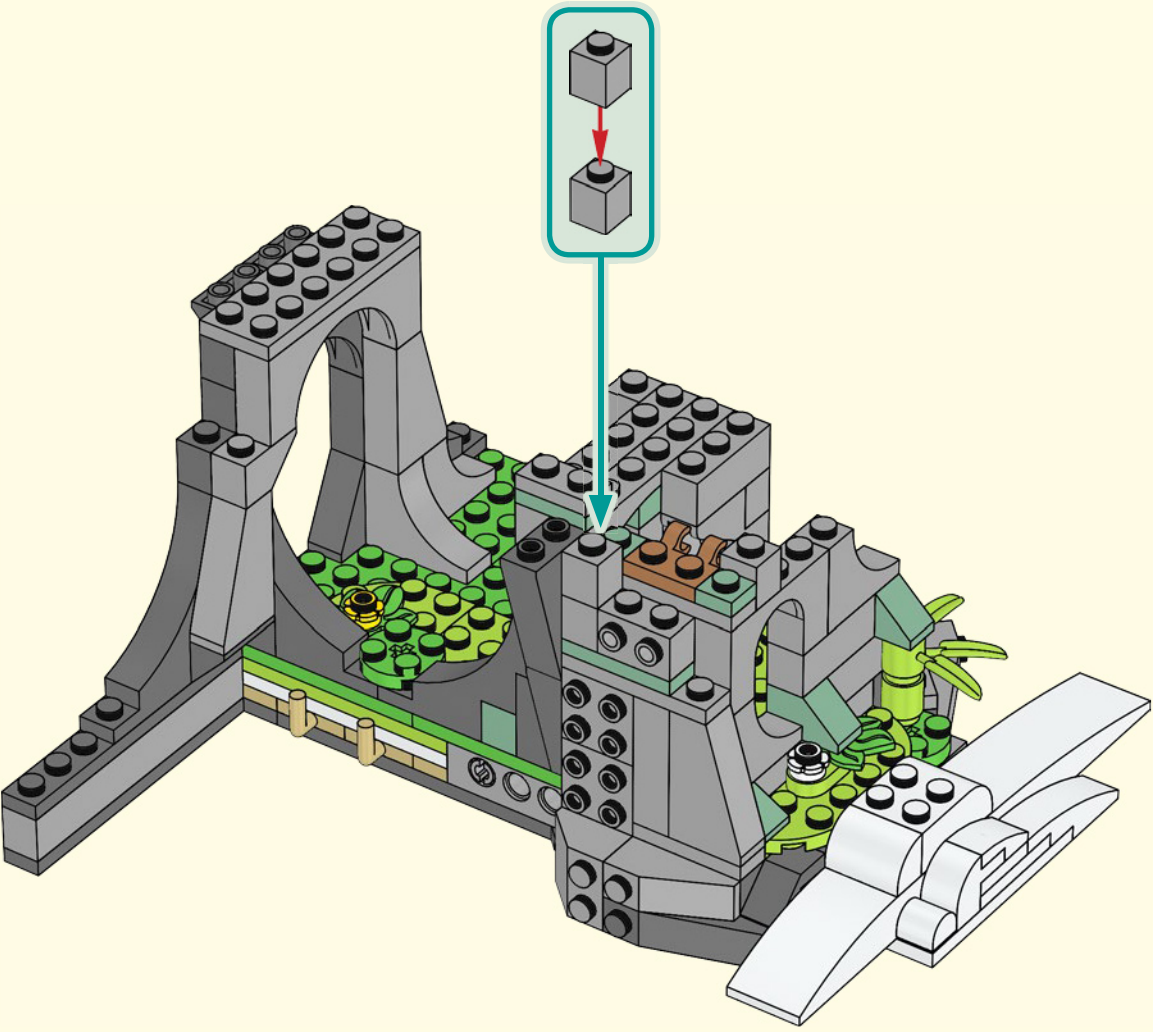

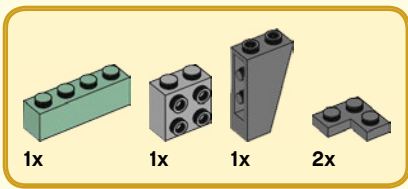

106

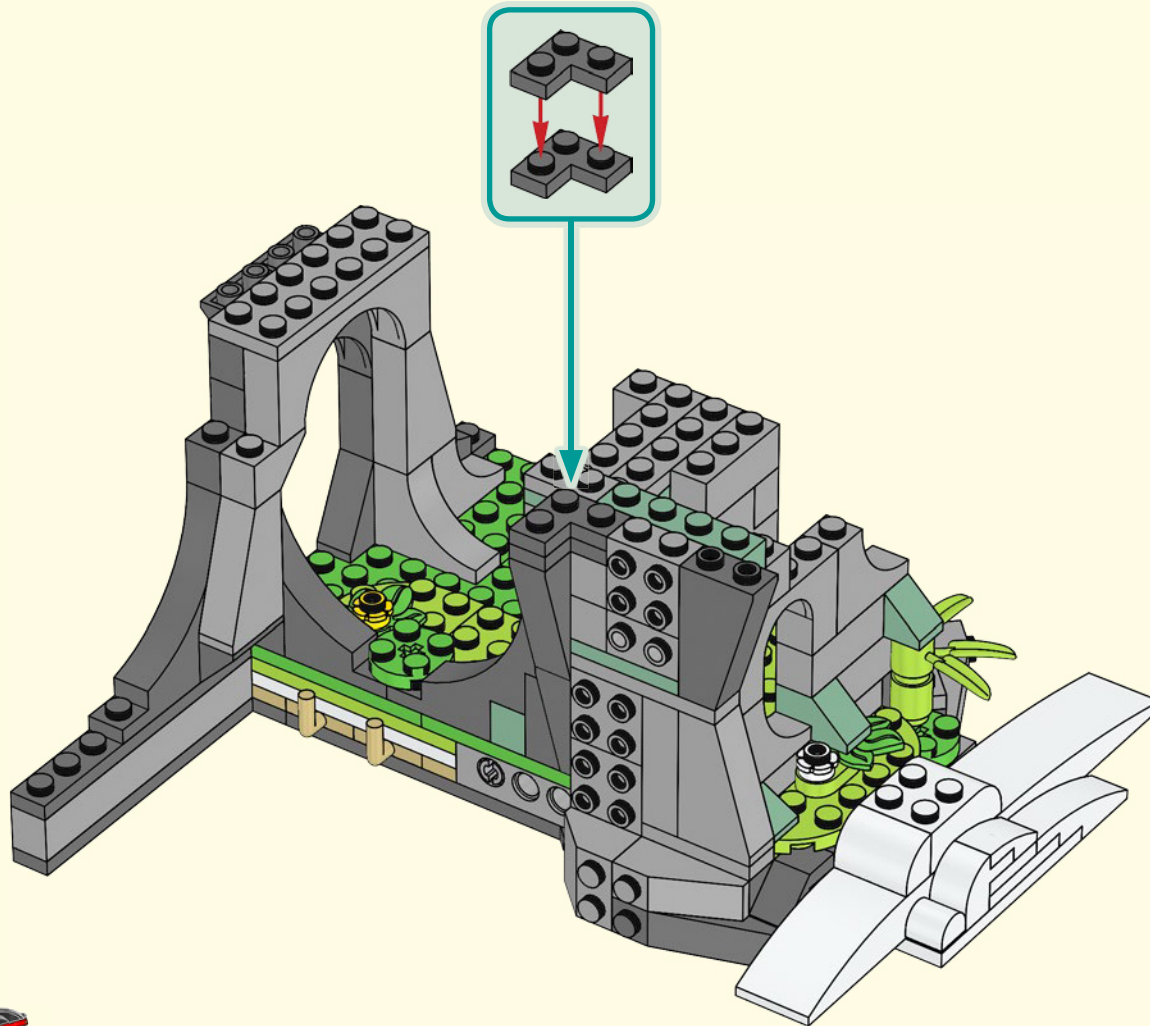



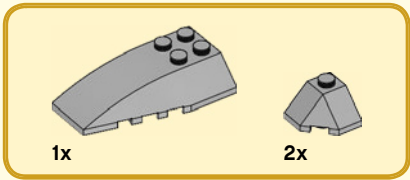

107

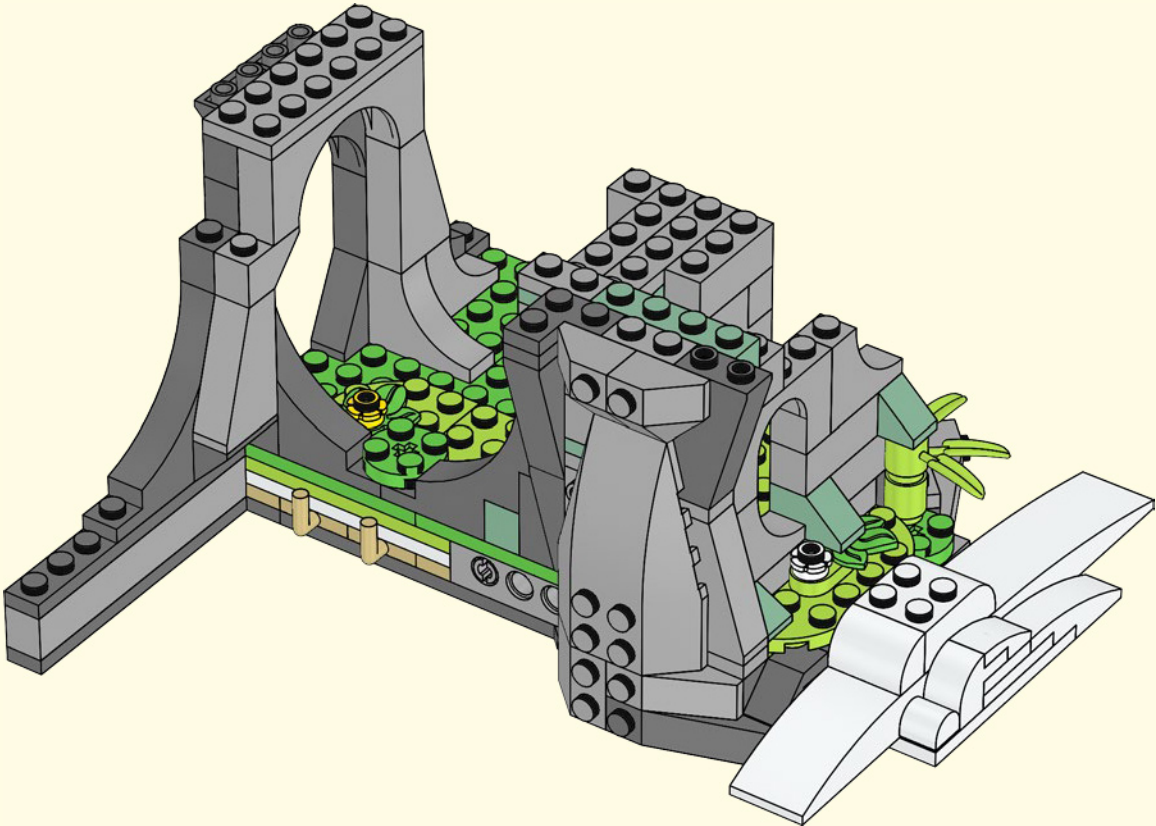



108

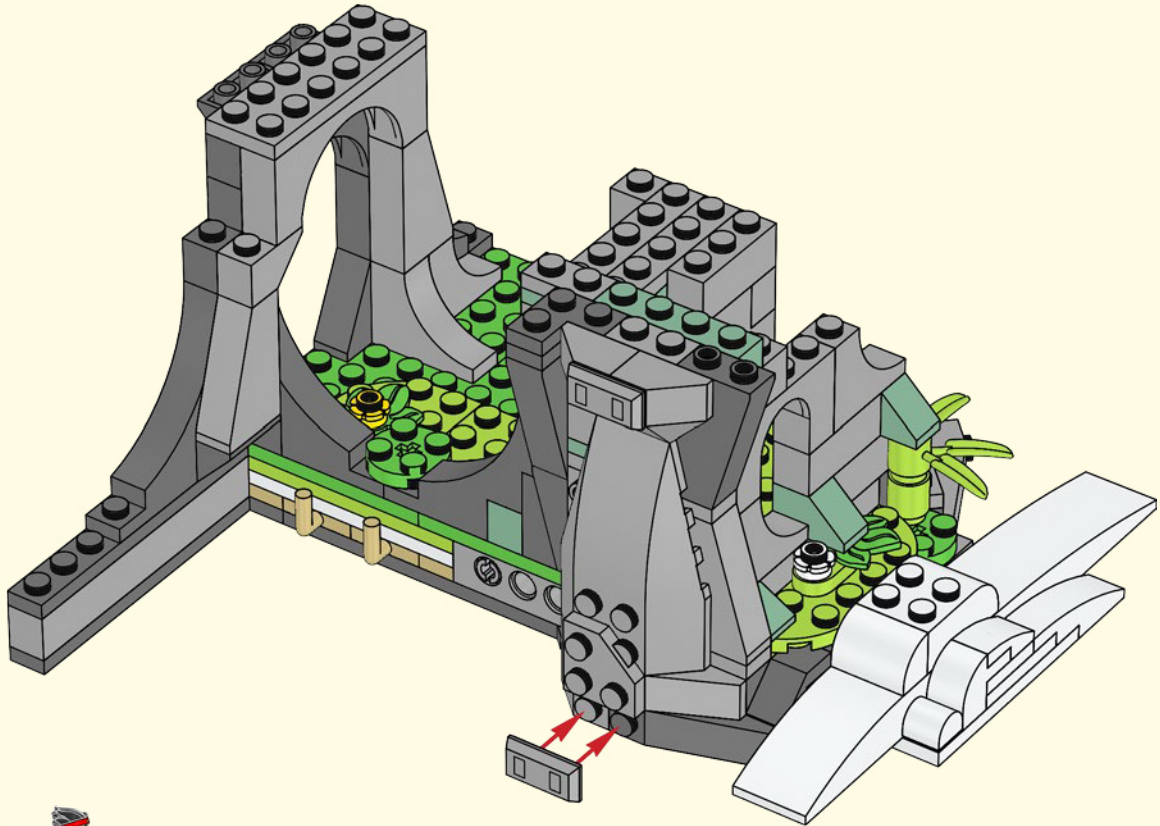

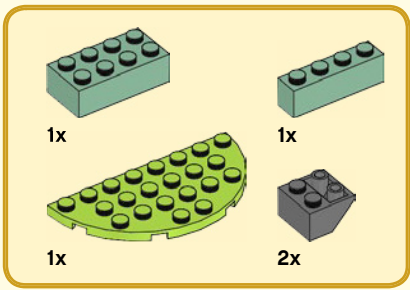

109

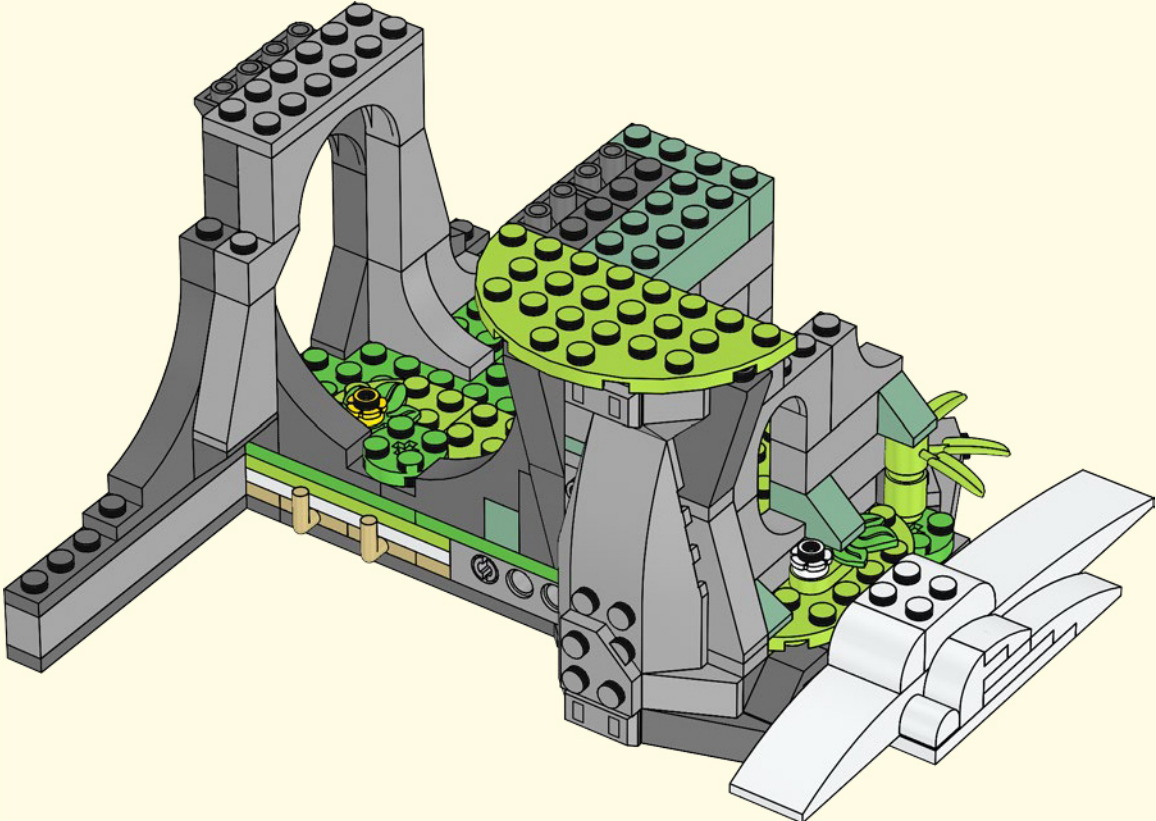

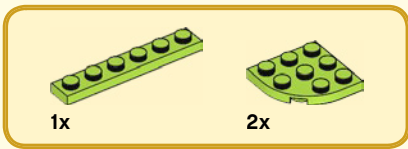

110

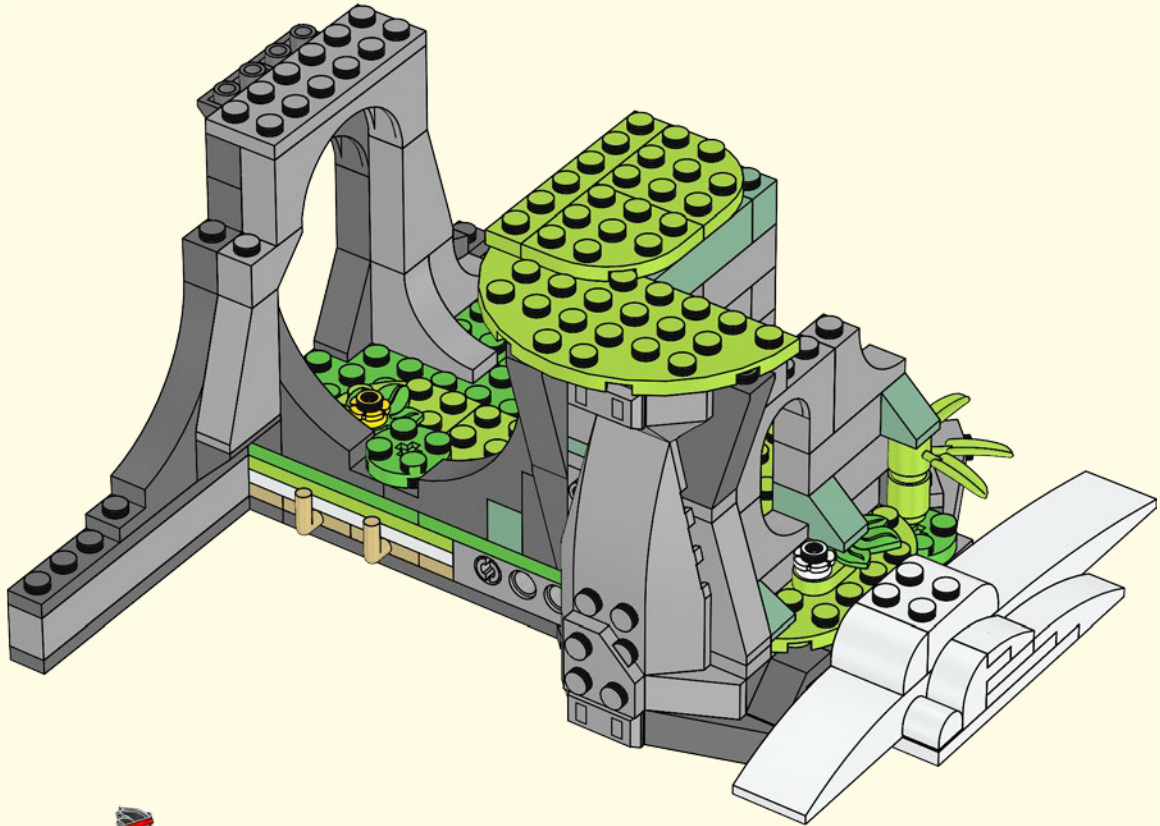





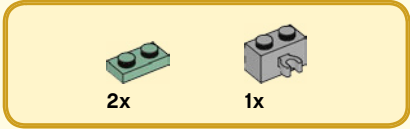
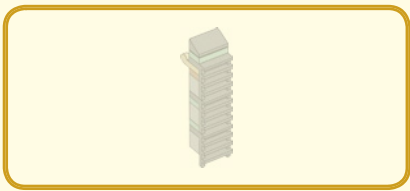

111

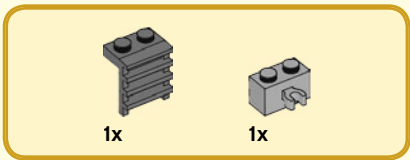
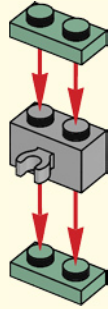

112

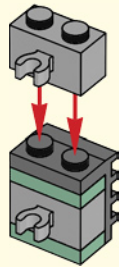

113

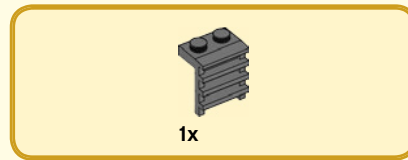
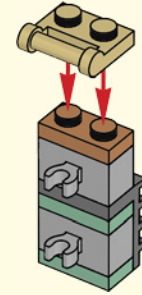

114

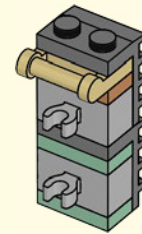



115

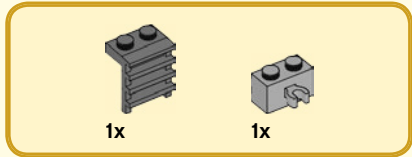
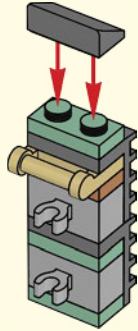

116

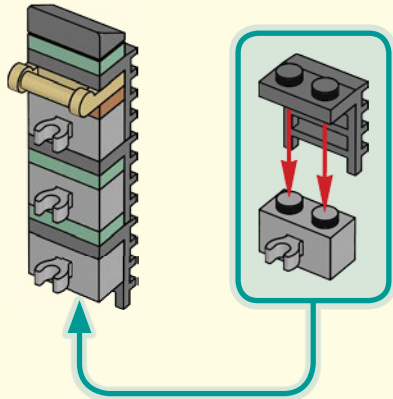

117

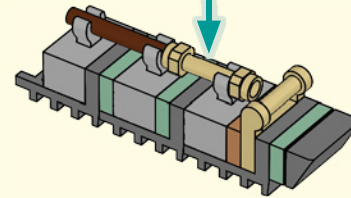
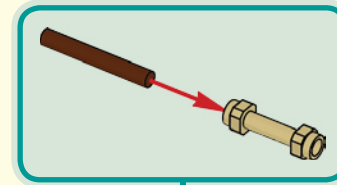
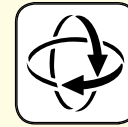

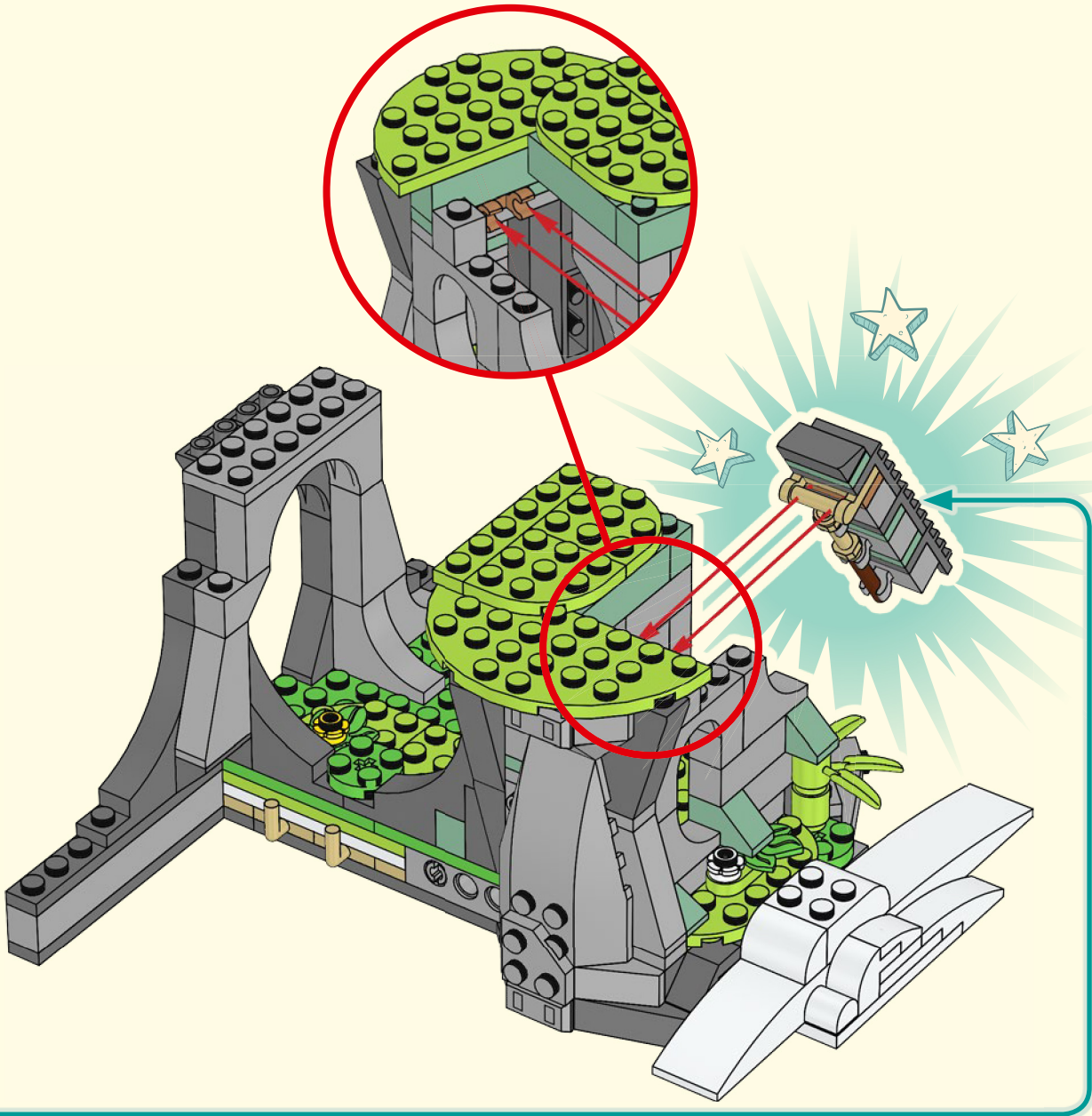

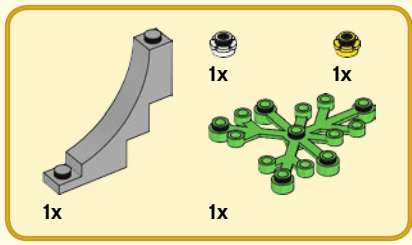

119

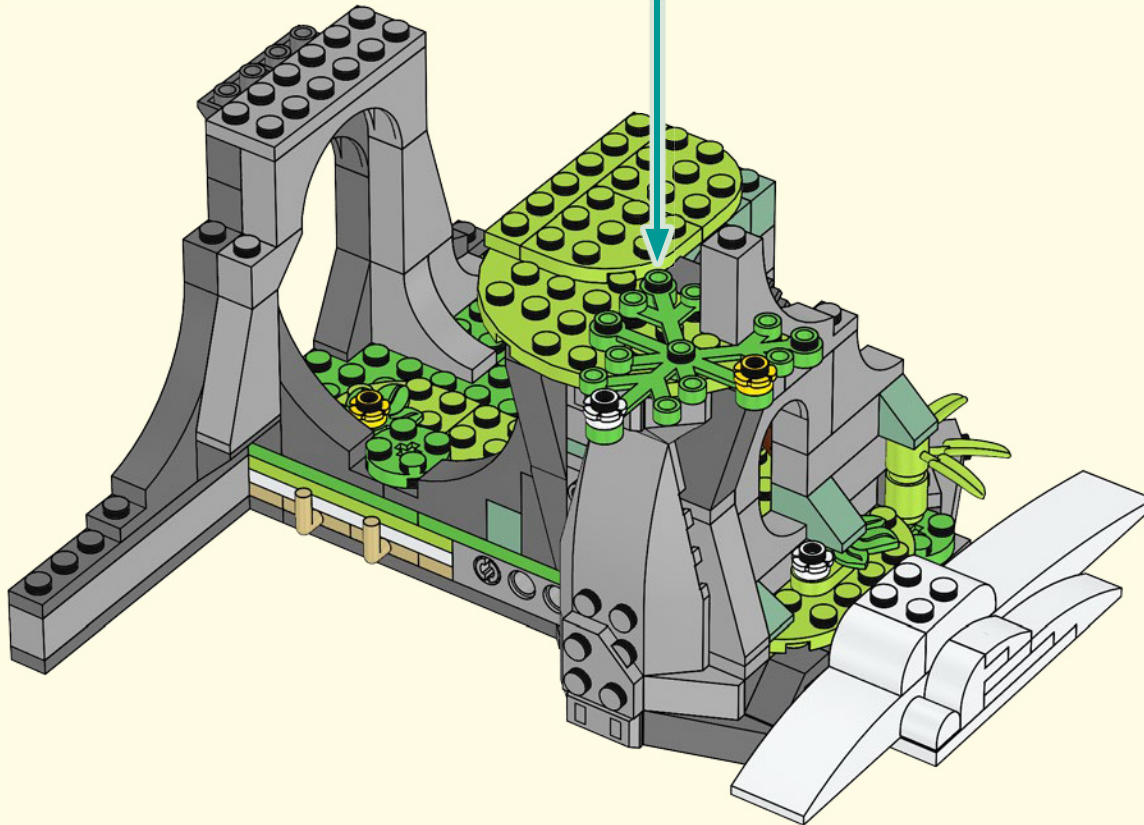
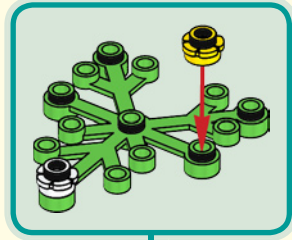





120

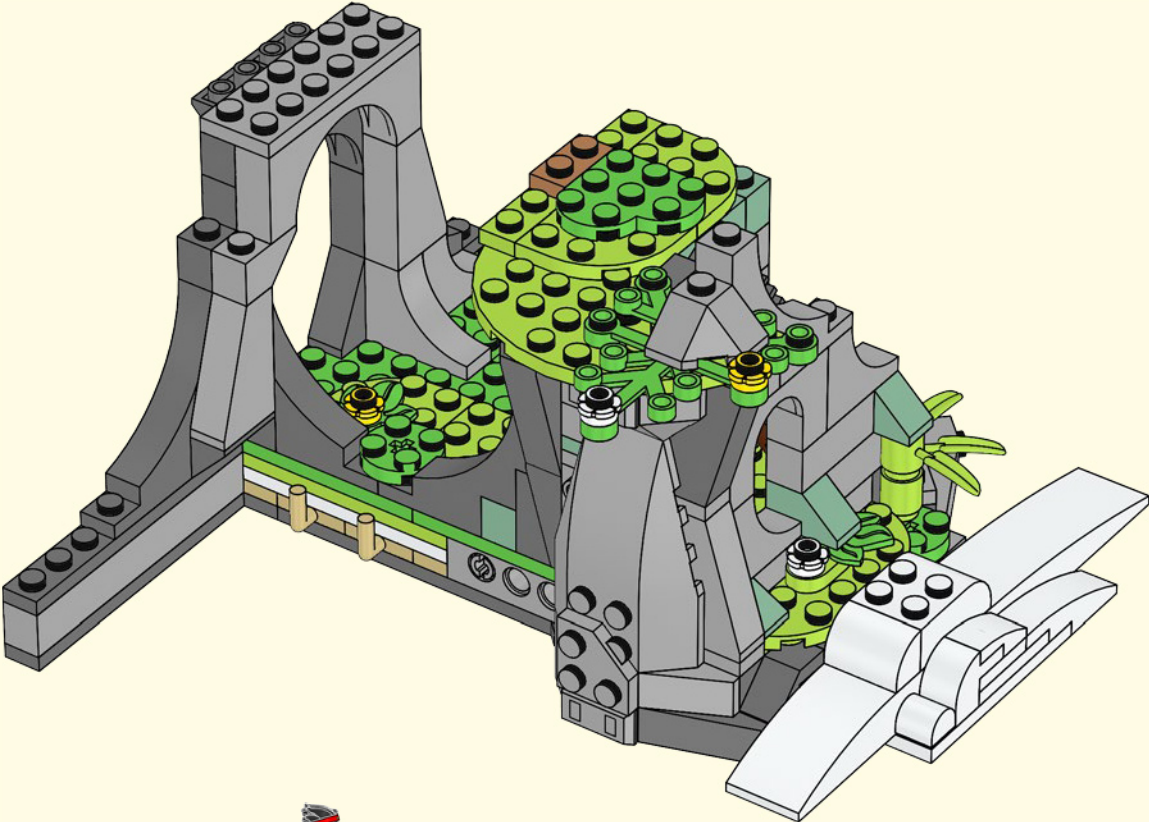

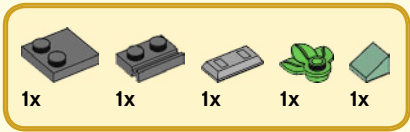

121

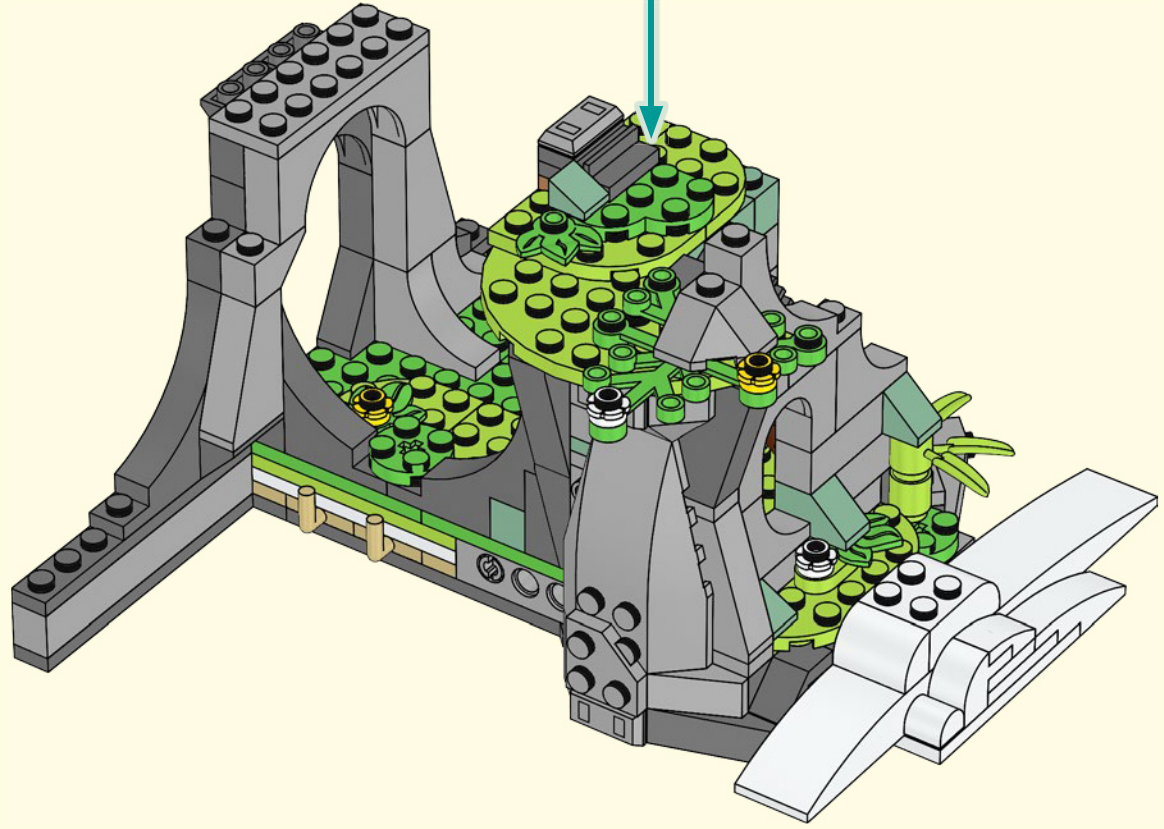
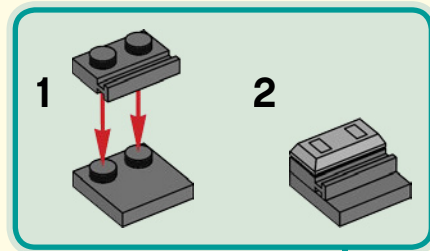

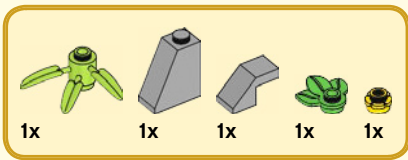

122

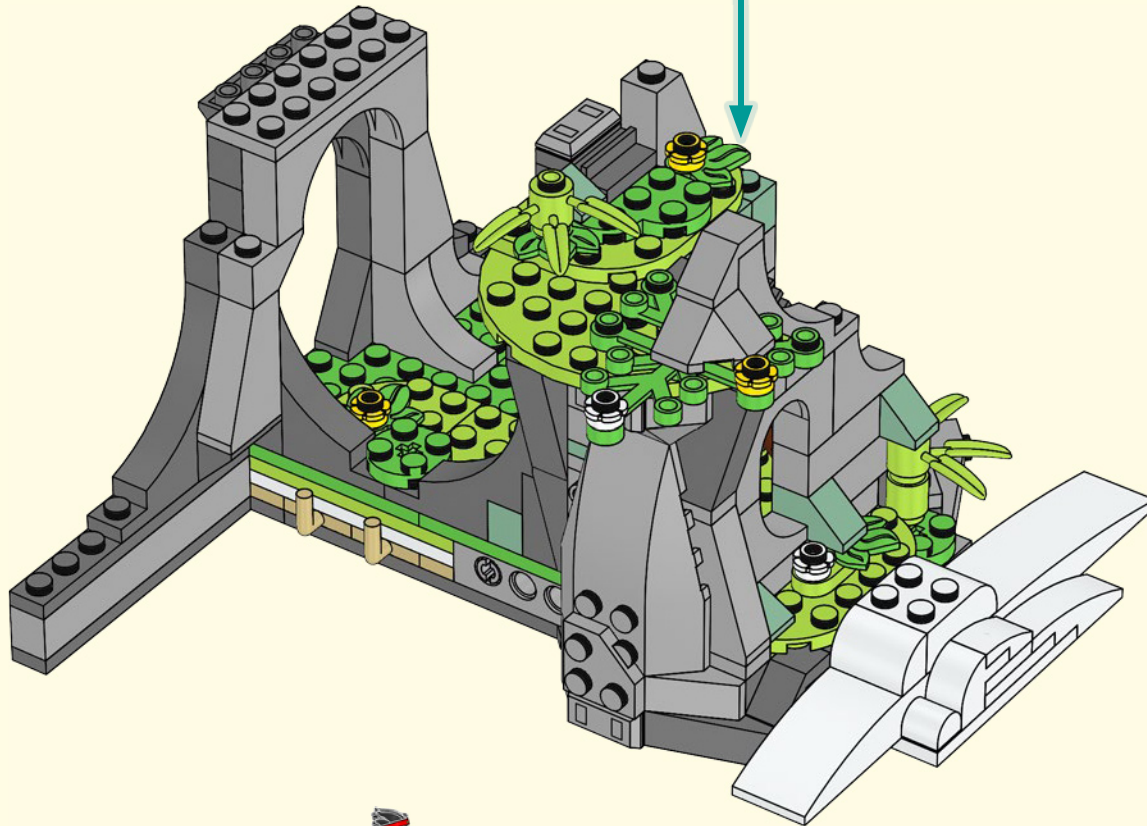
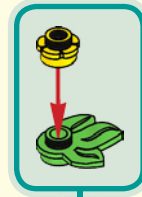



123

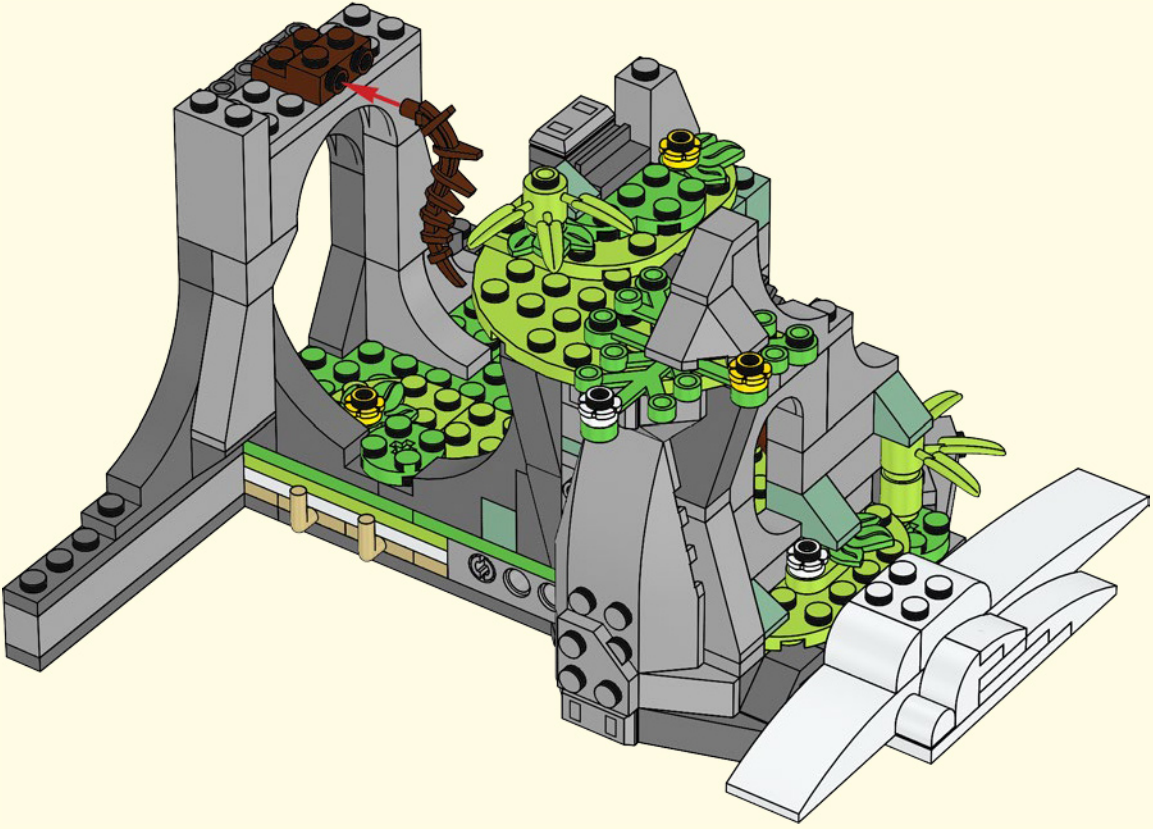



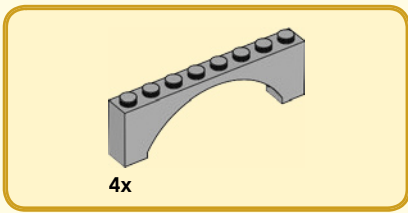

124

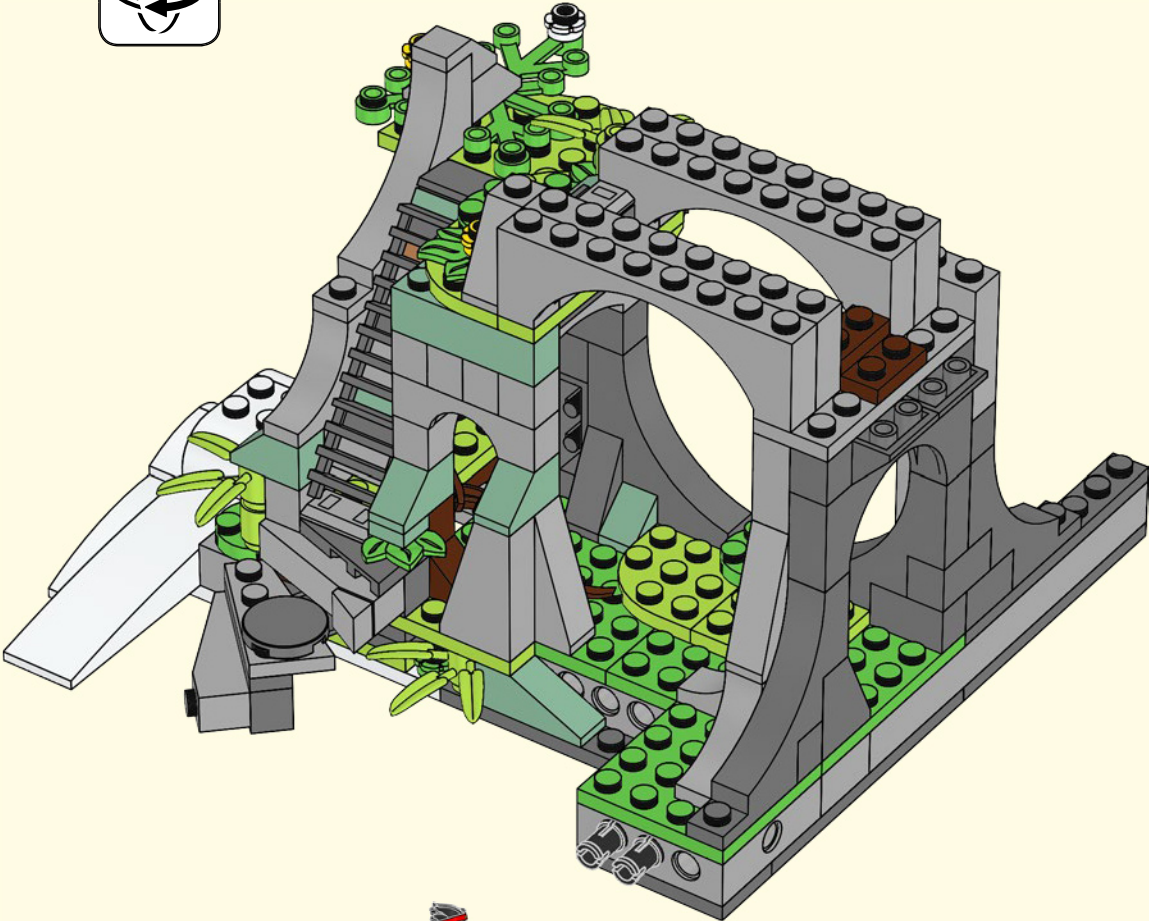



2x 1x 1x

125

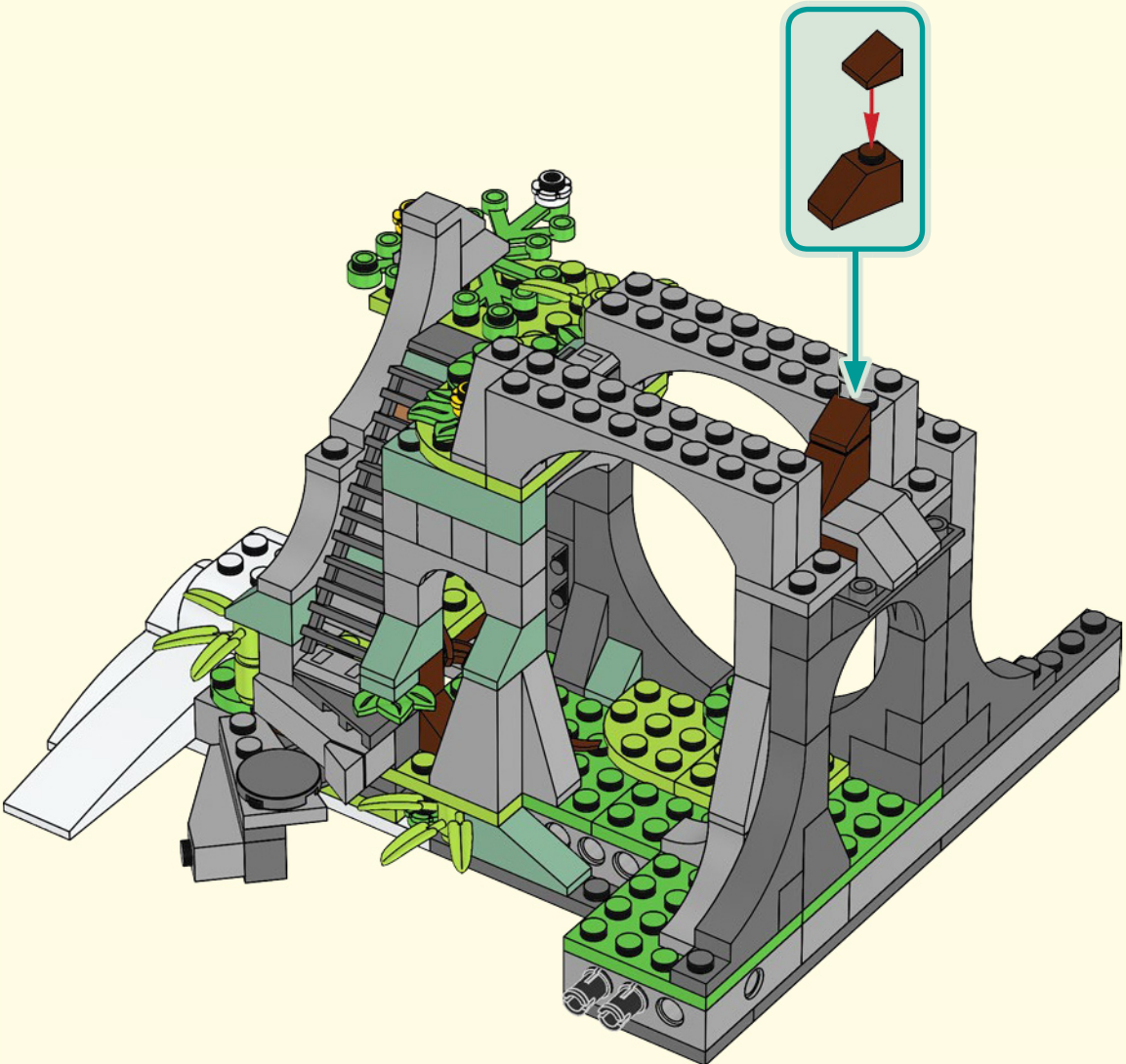

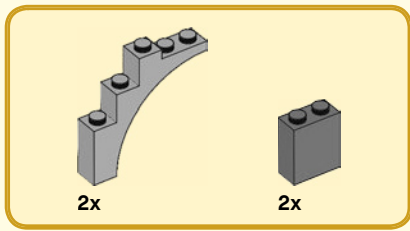

126

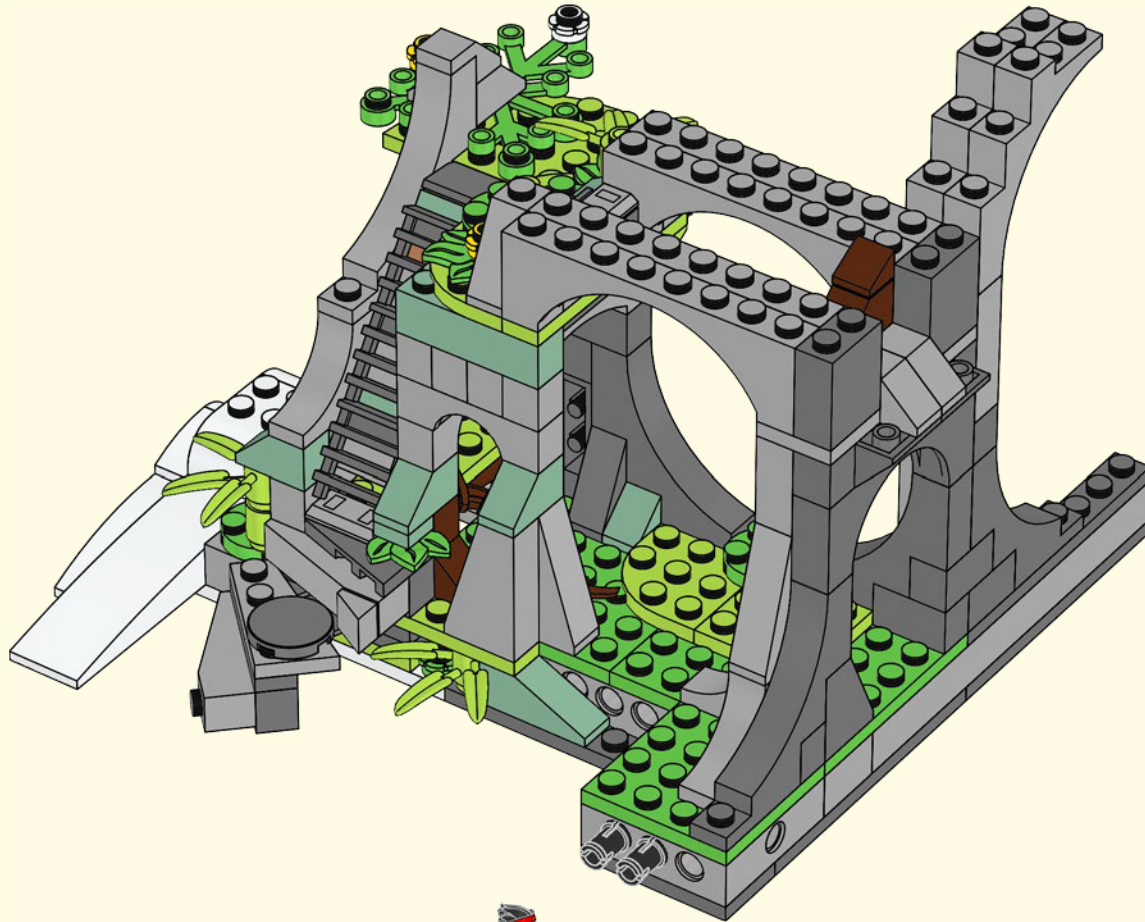

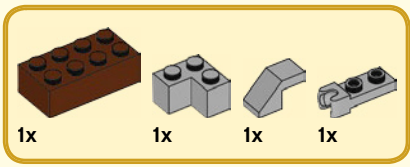

127

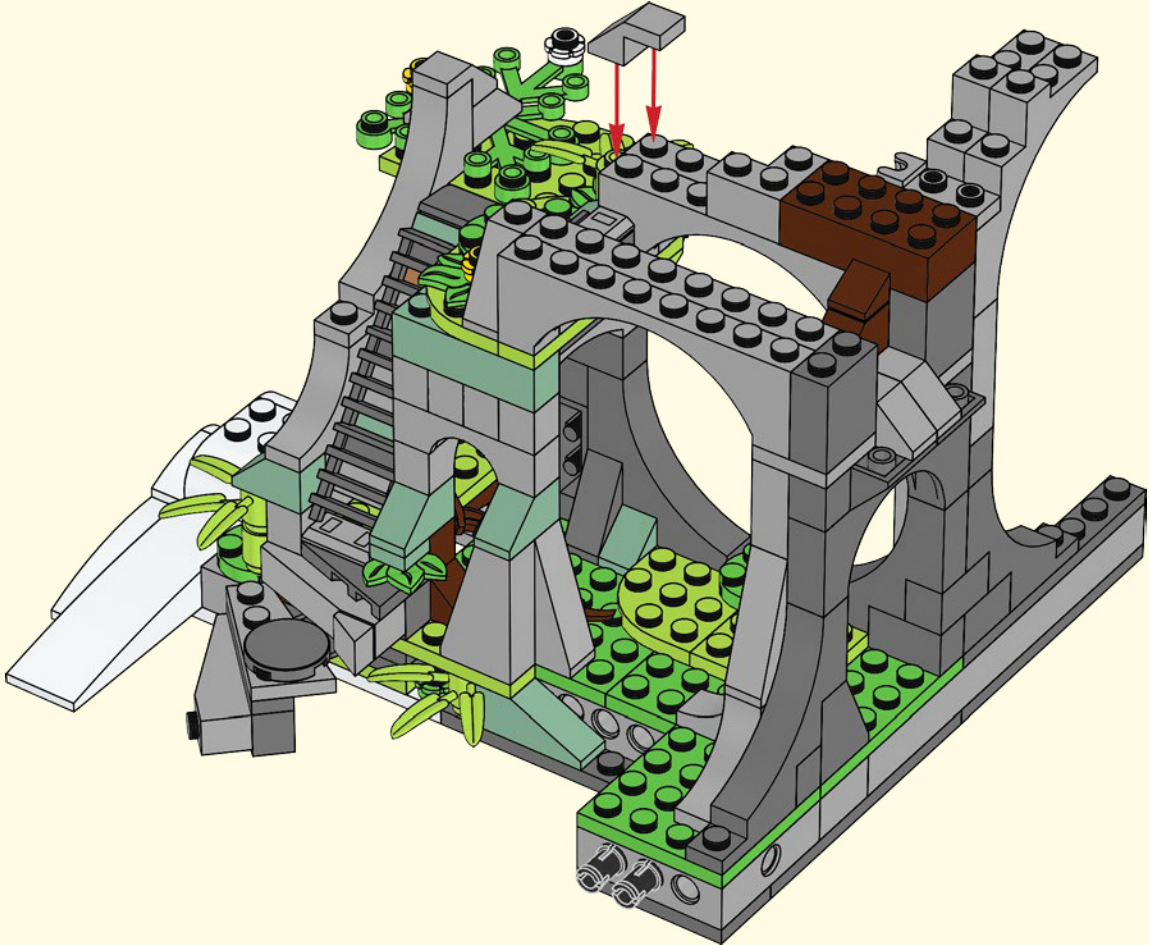

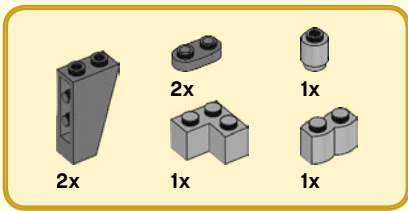

128

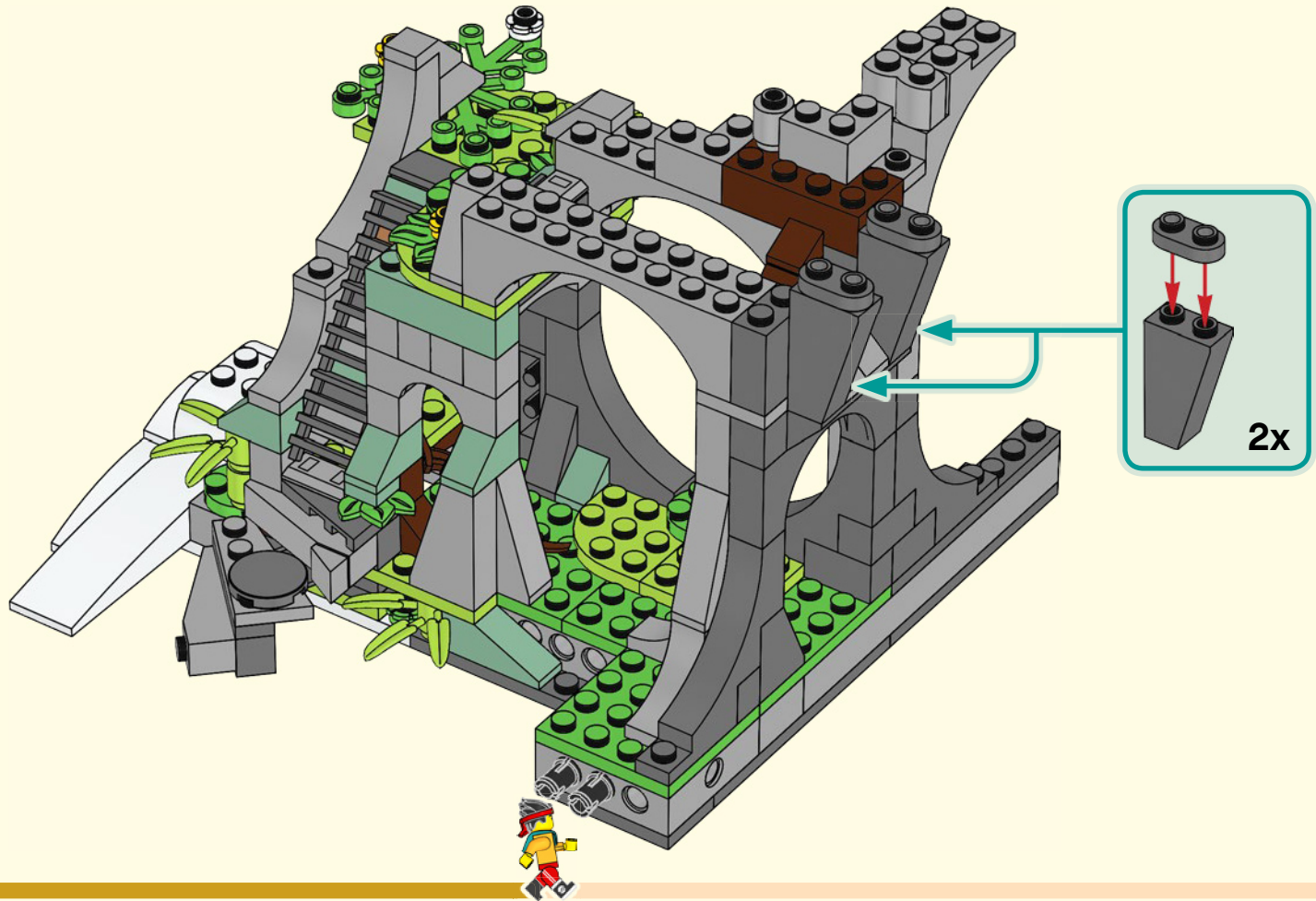



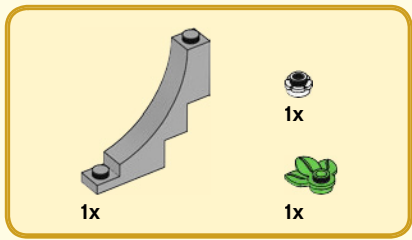

129

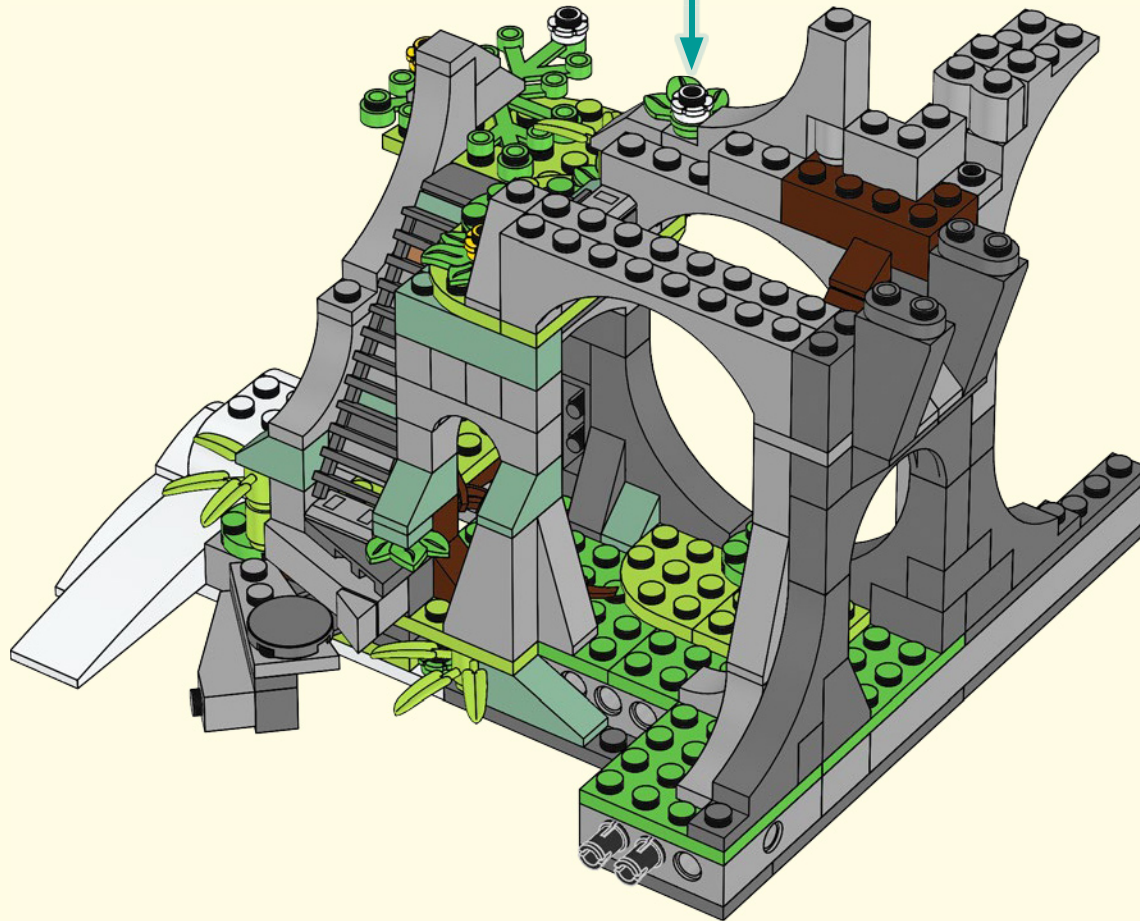
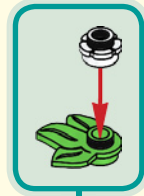



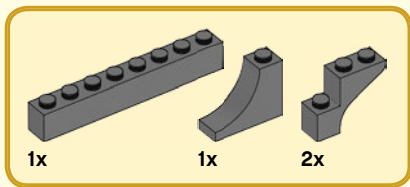

130

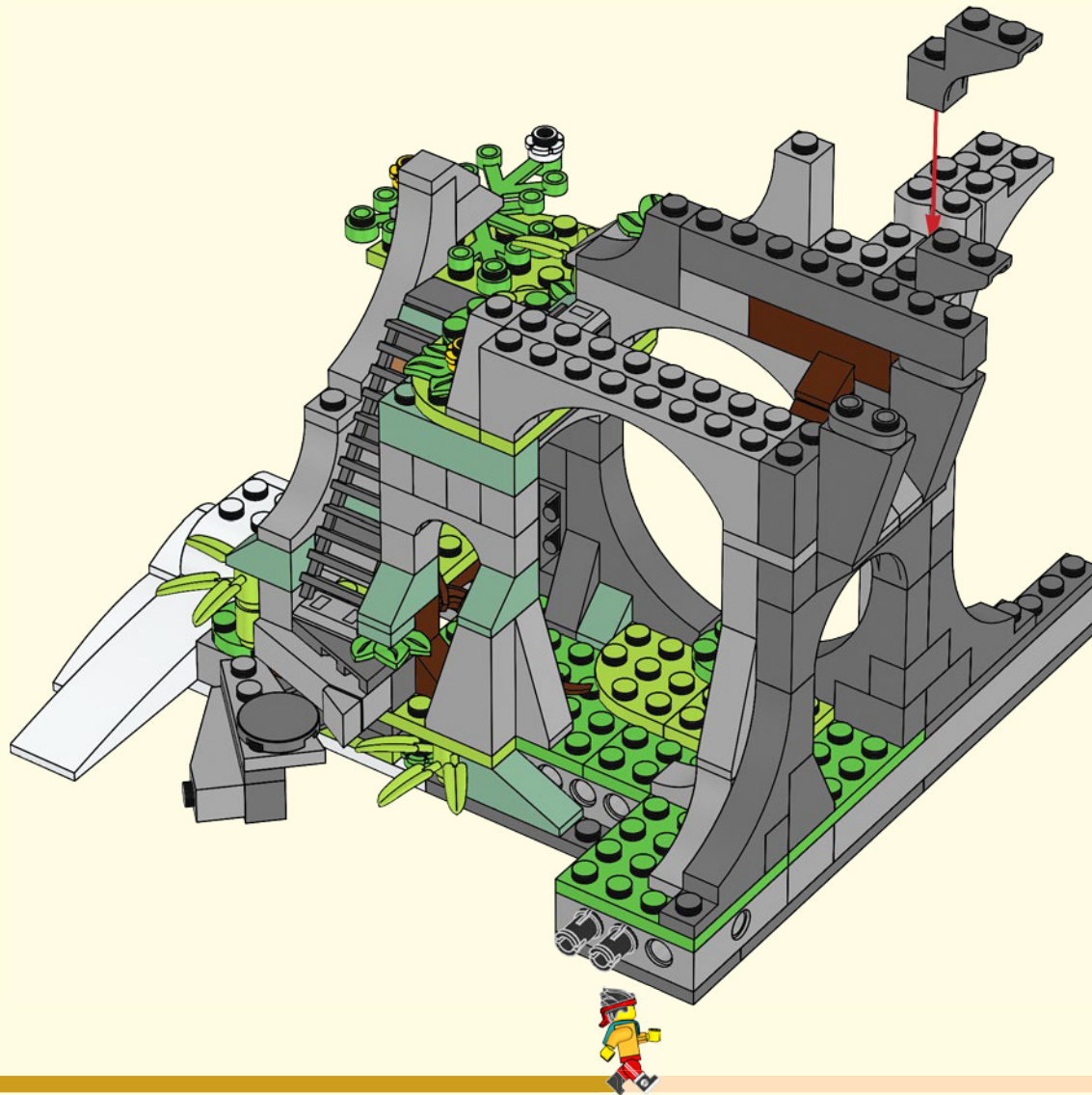

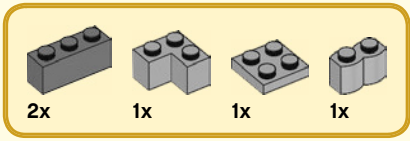

131

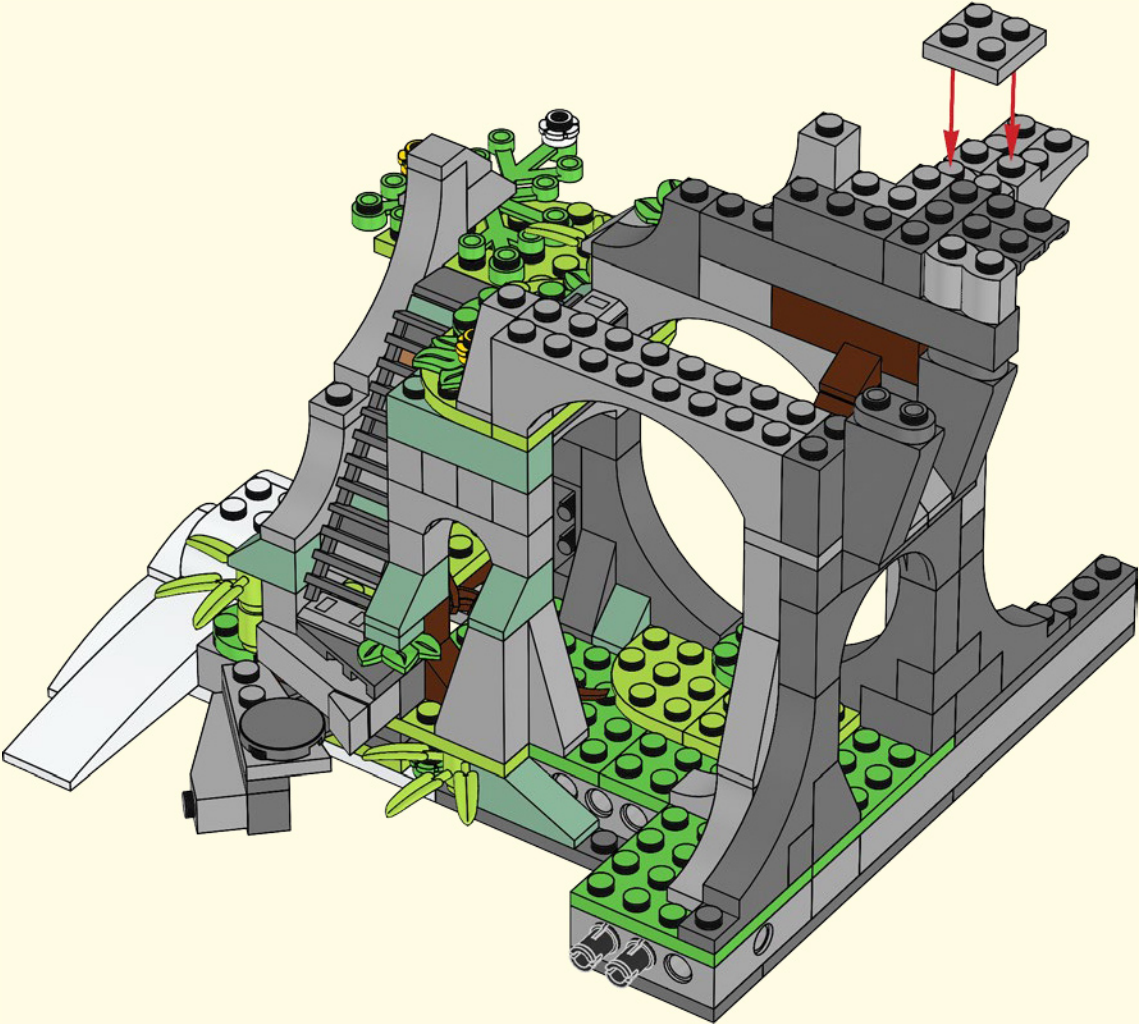

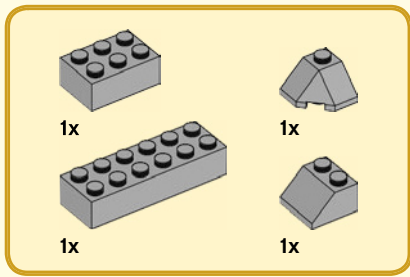

132

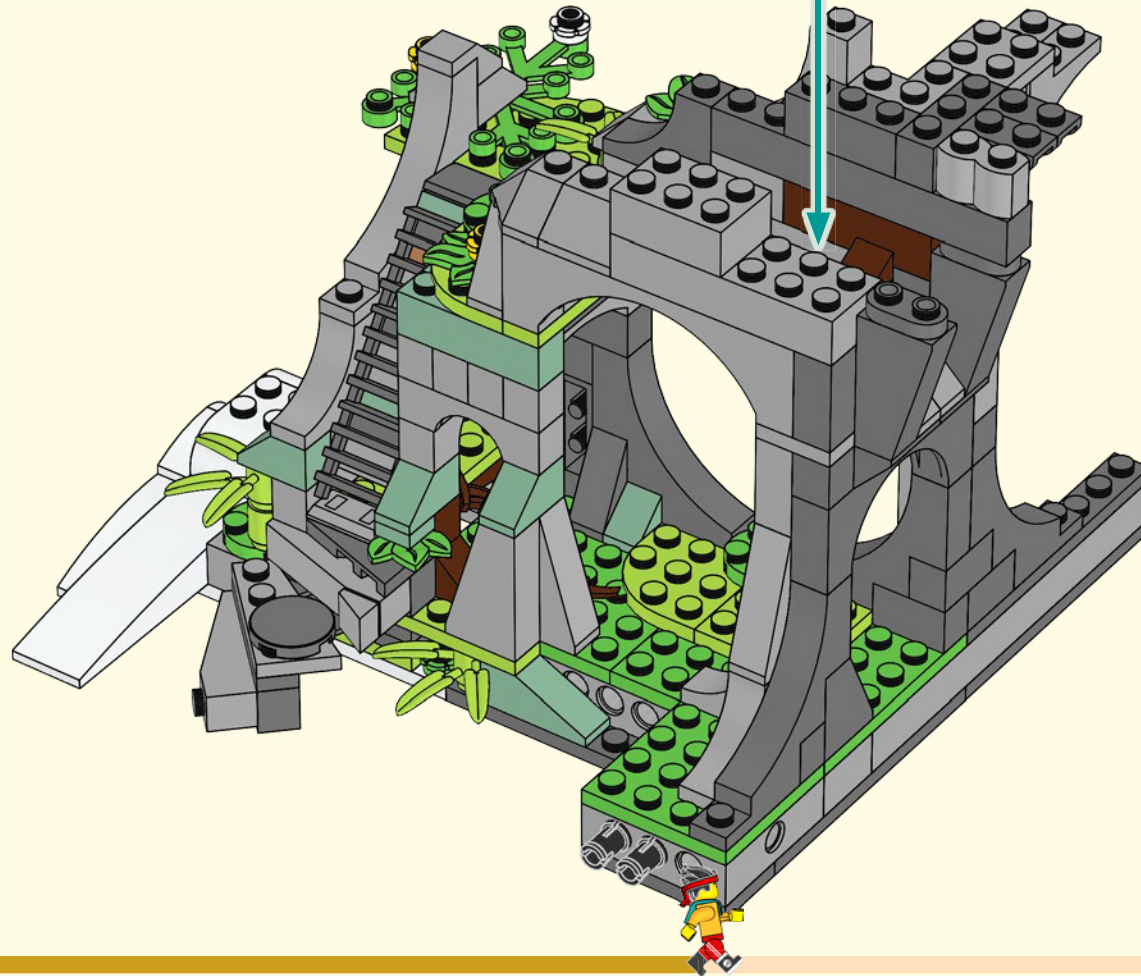
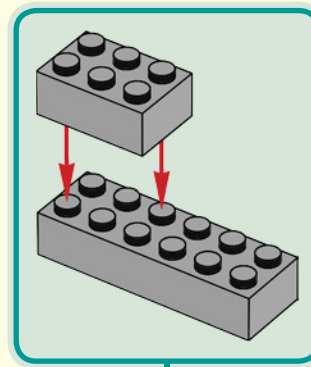



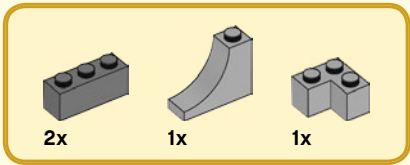

133

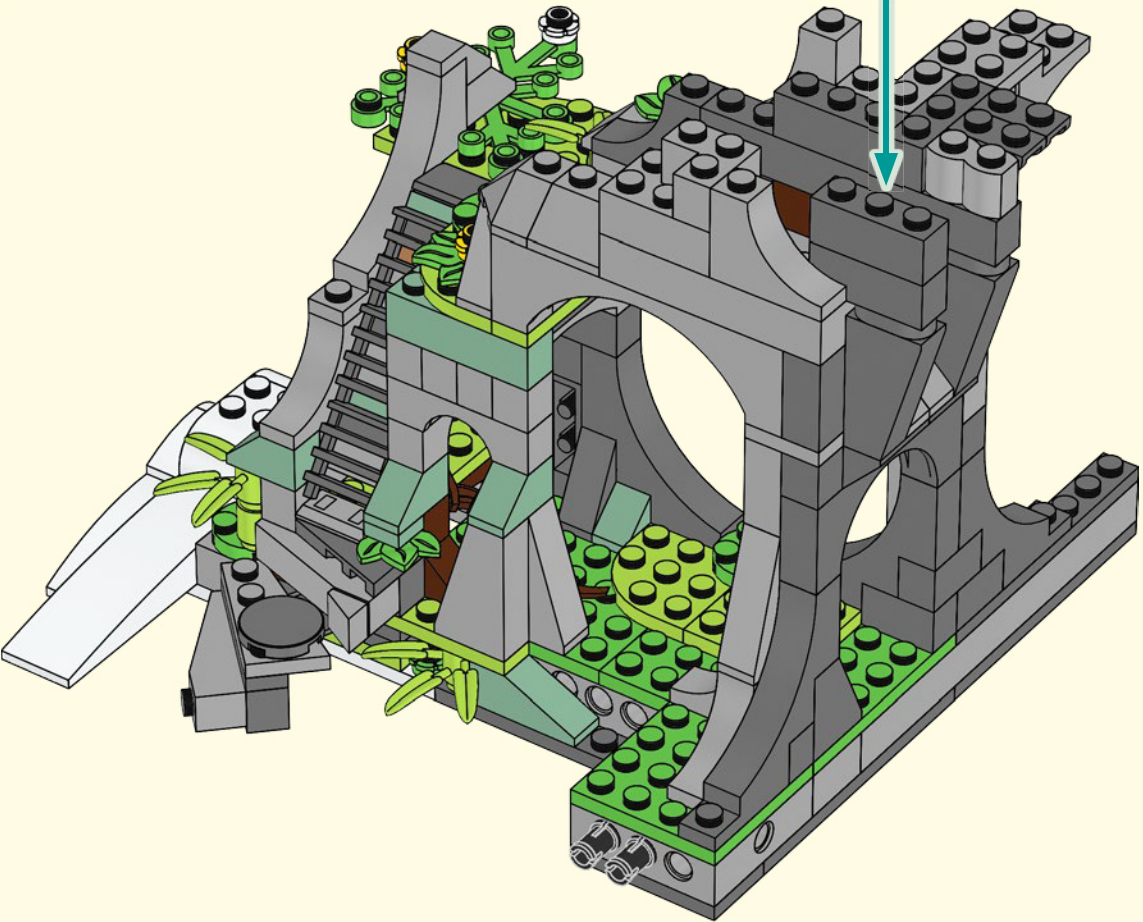
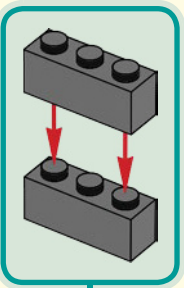



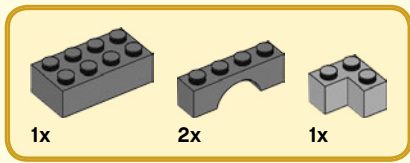

134

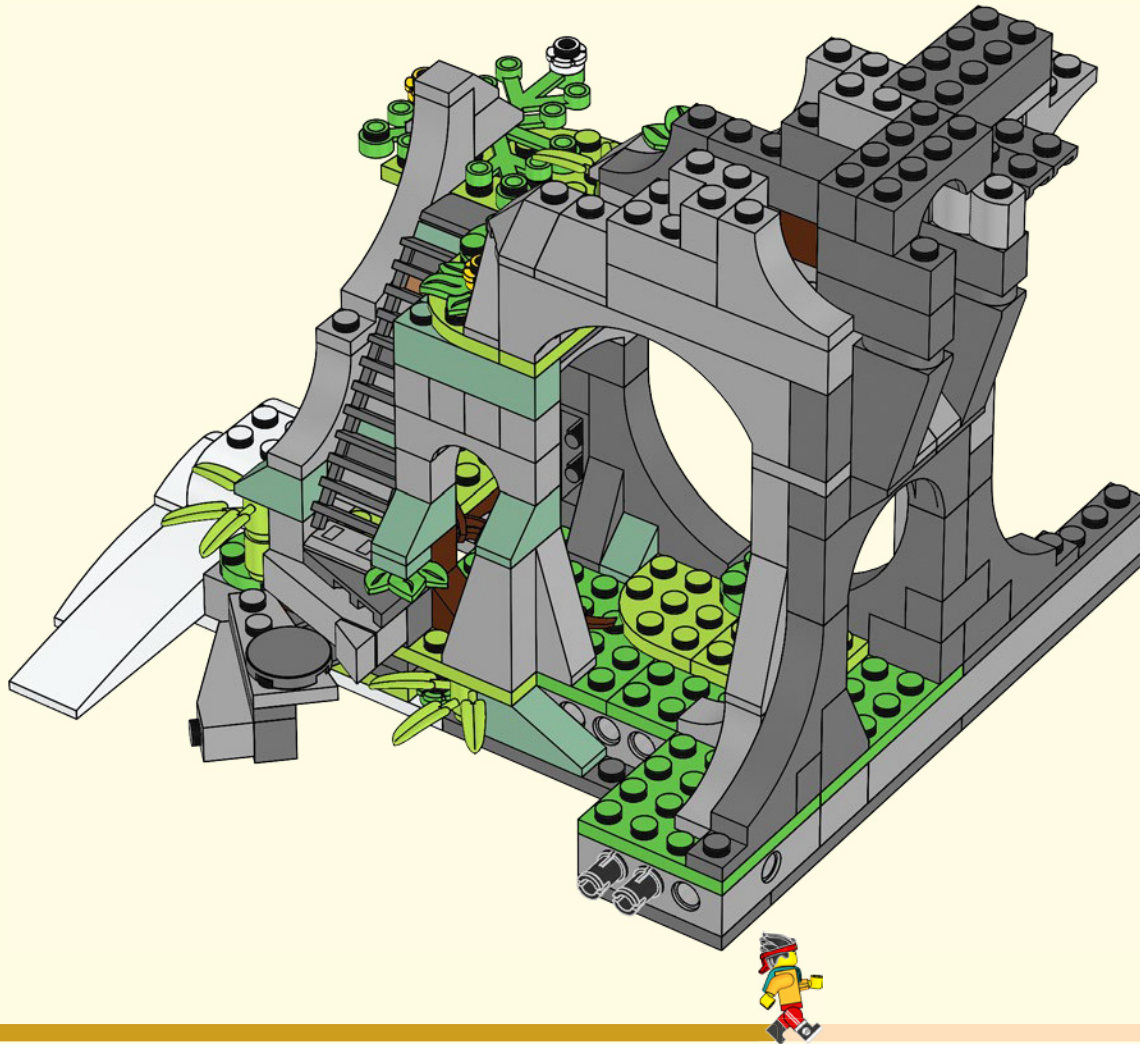

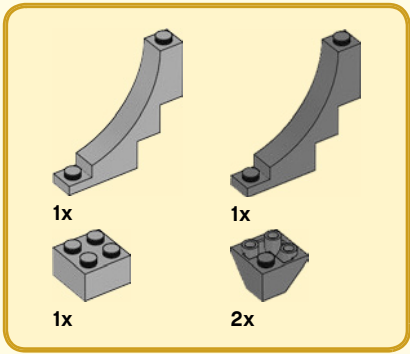

135

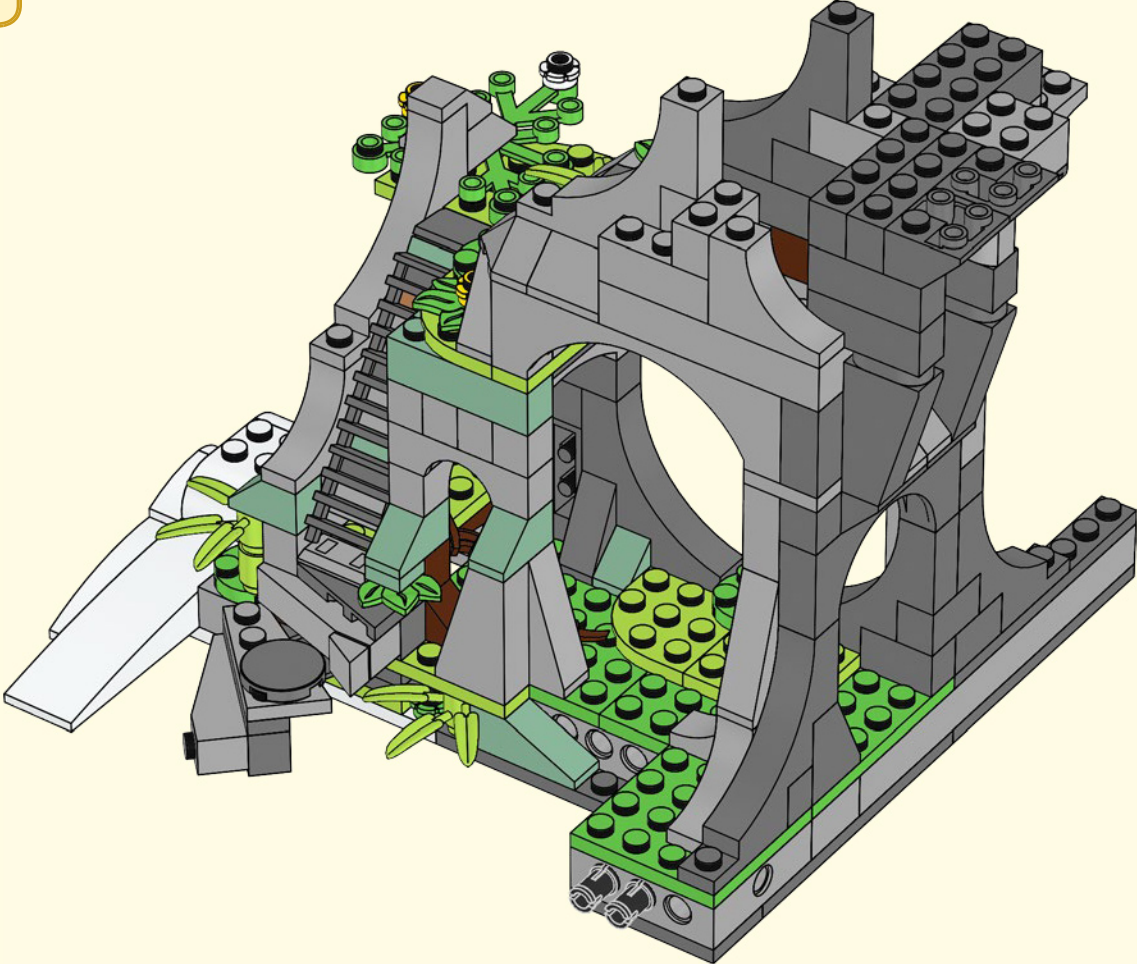

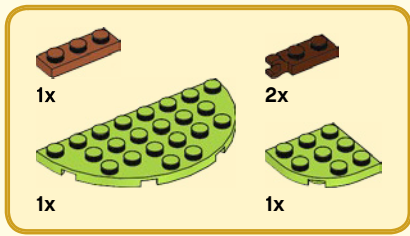

136

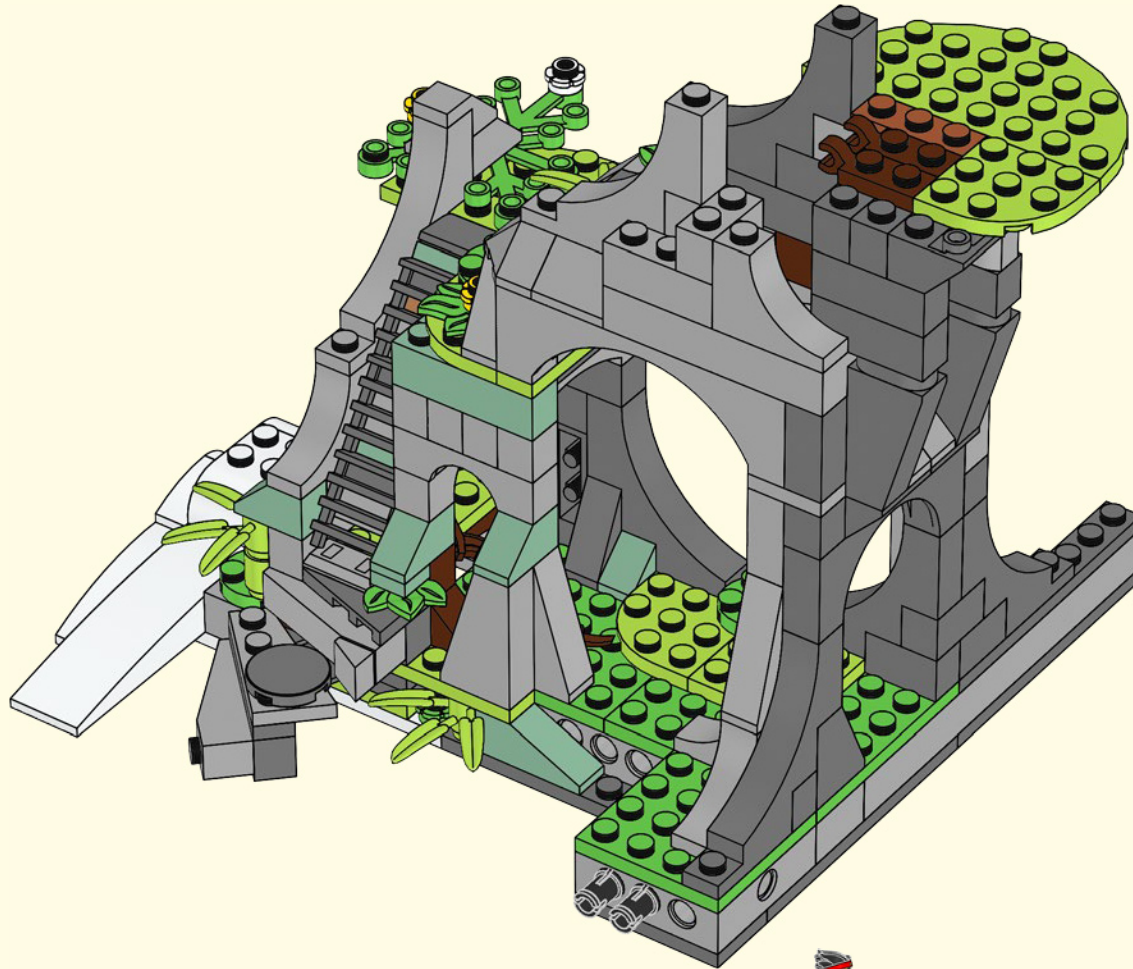

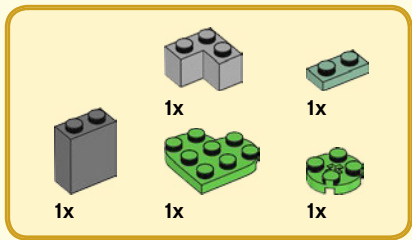

137

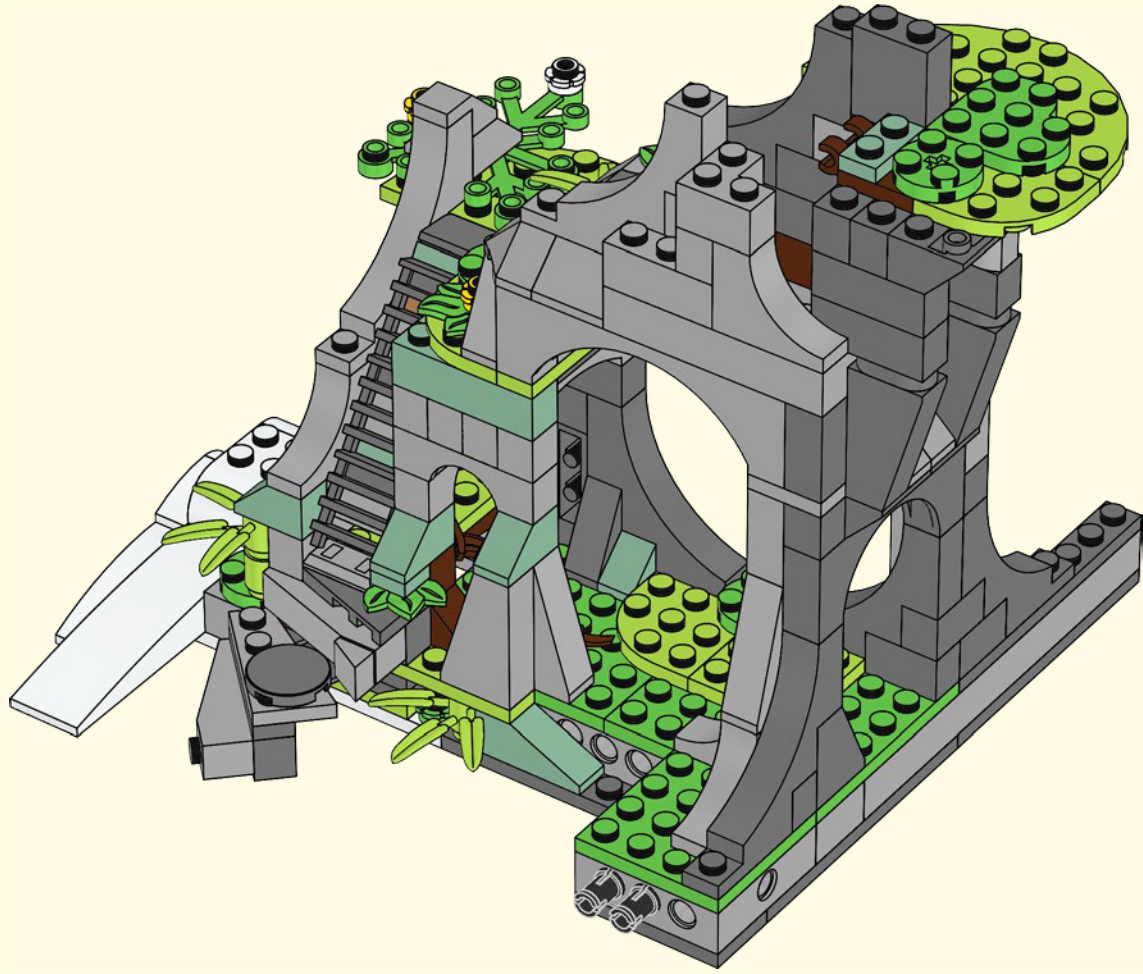



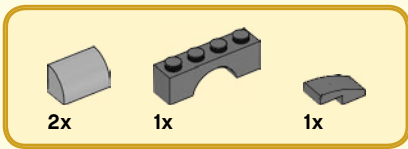

138

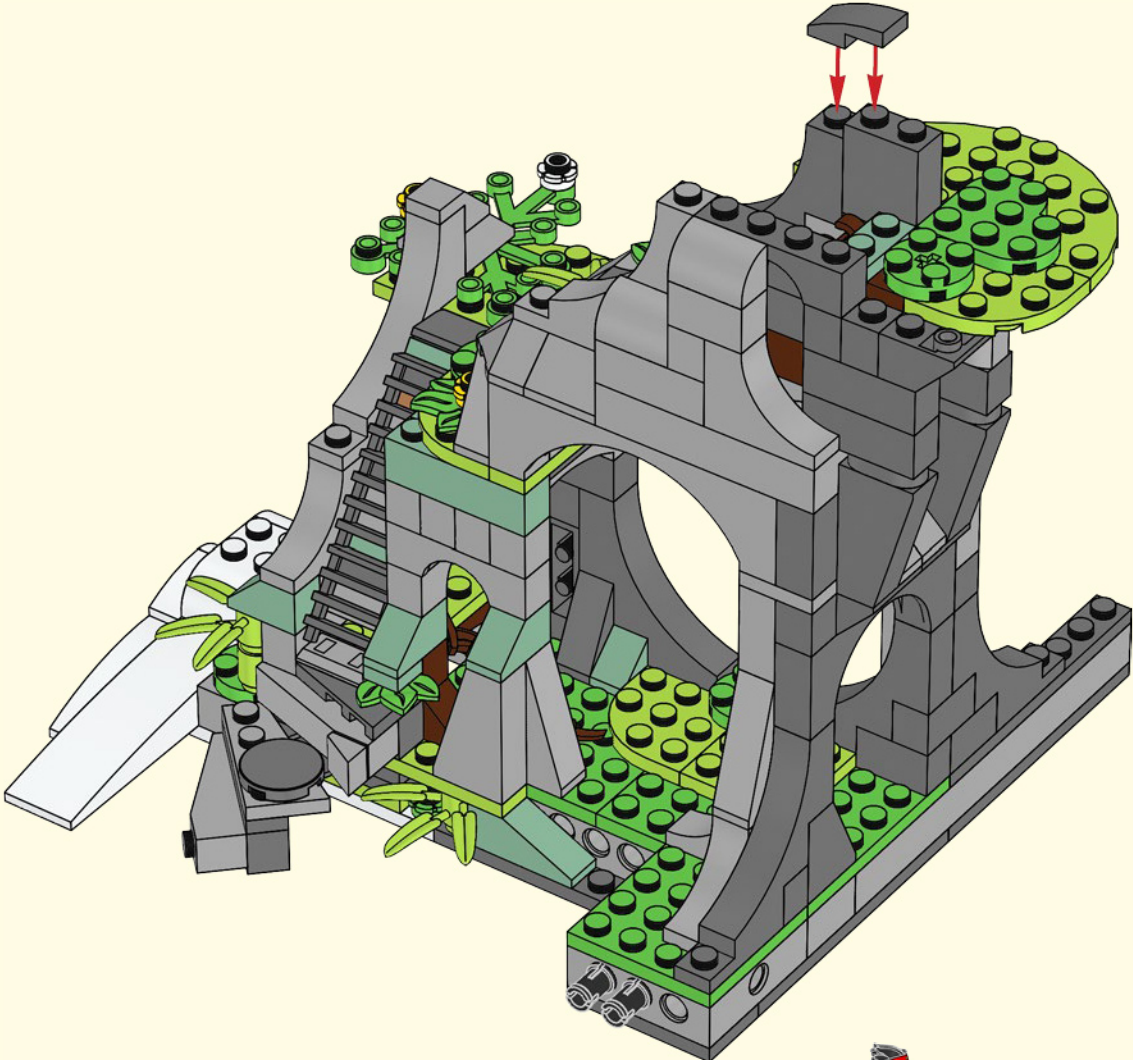



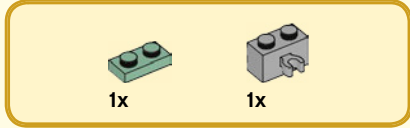
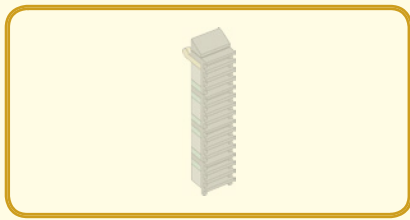

139

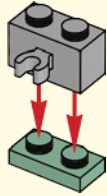

140

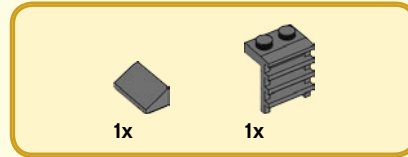
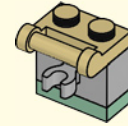

141

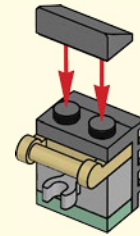

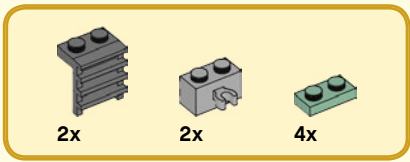

142

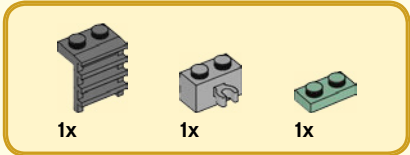
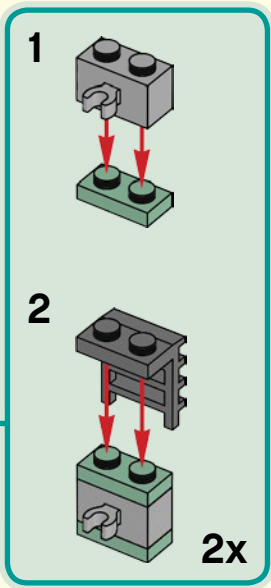
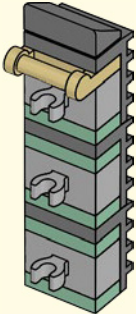

143

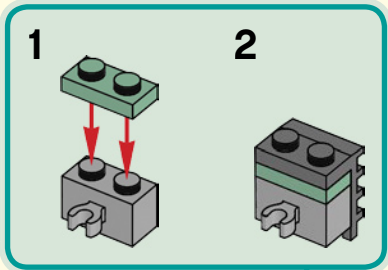
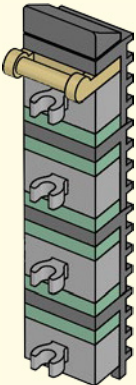

144

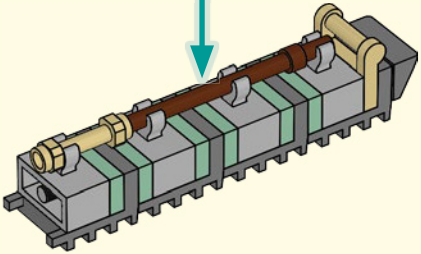
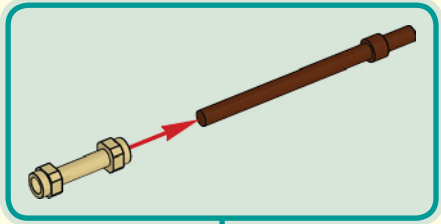



145

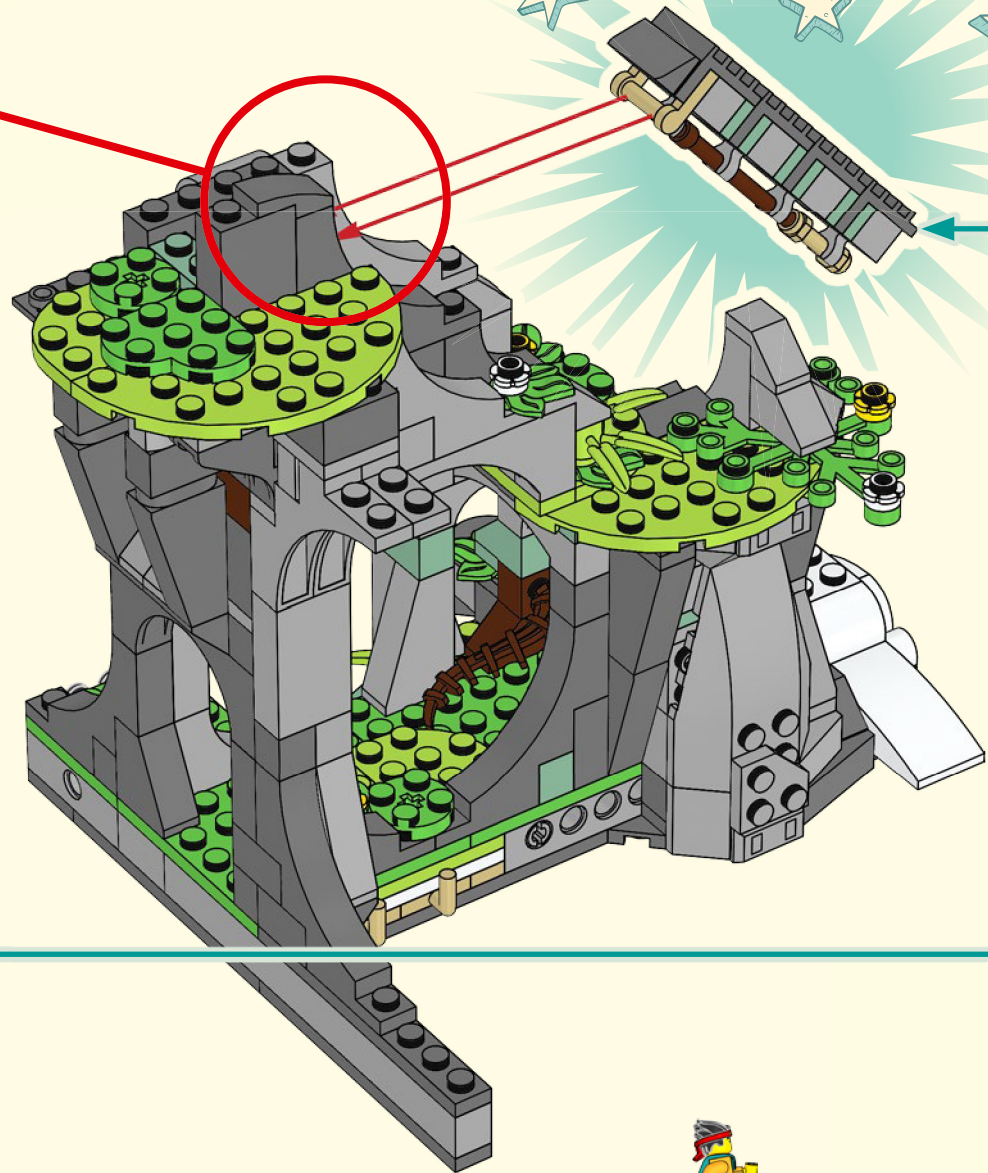
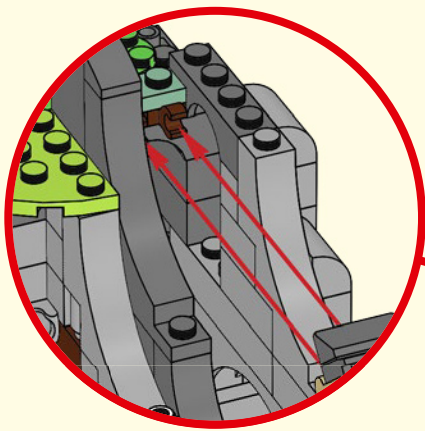

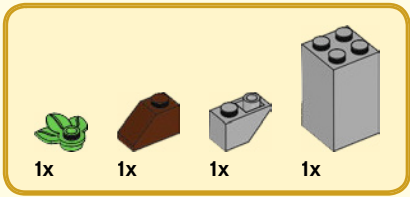

146

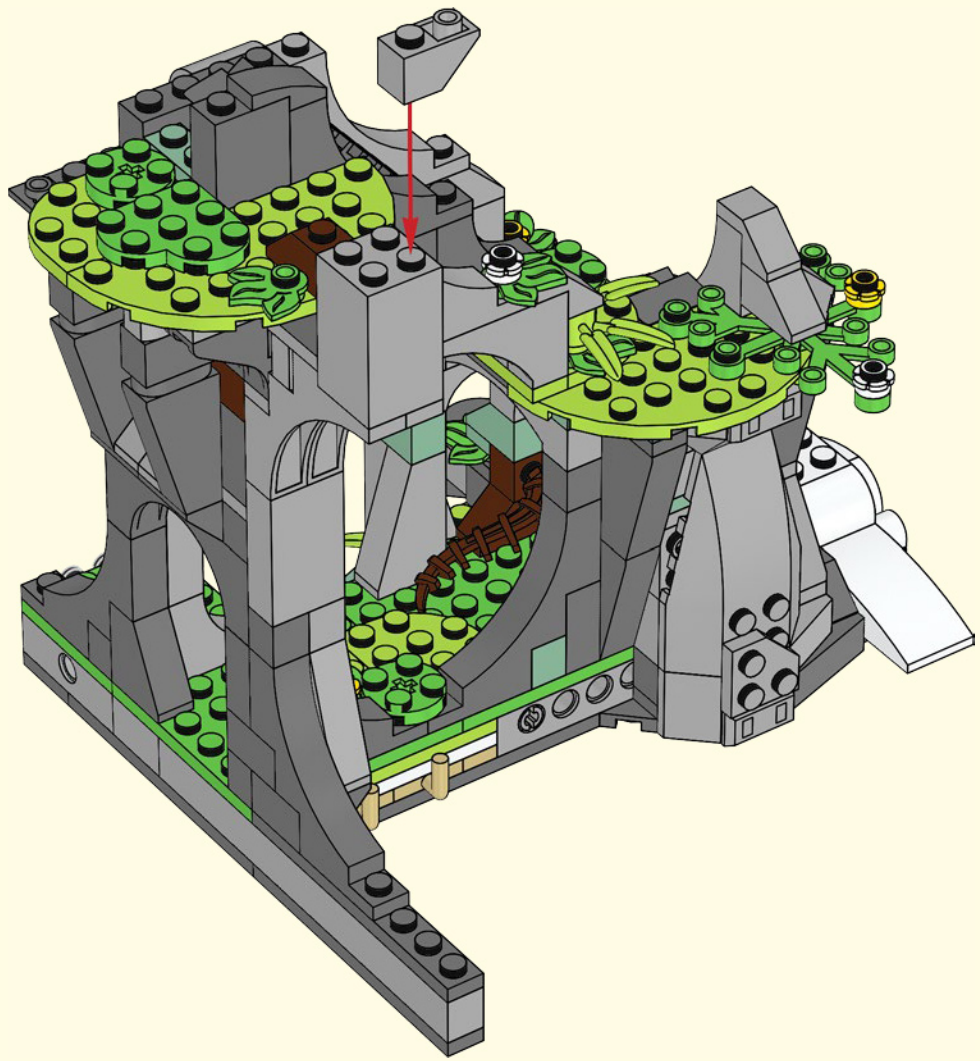

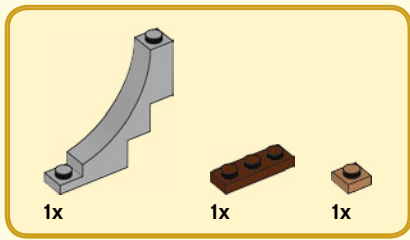

147

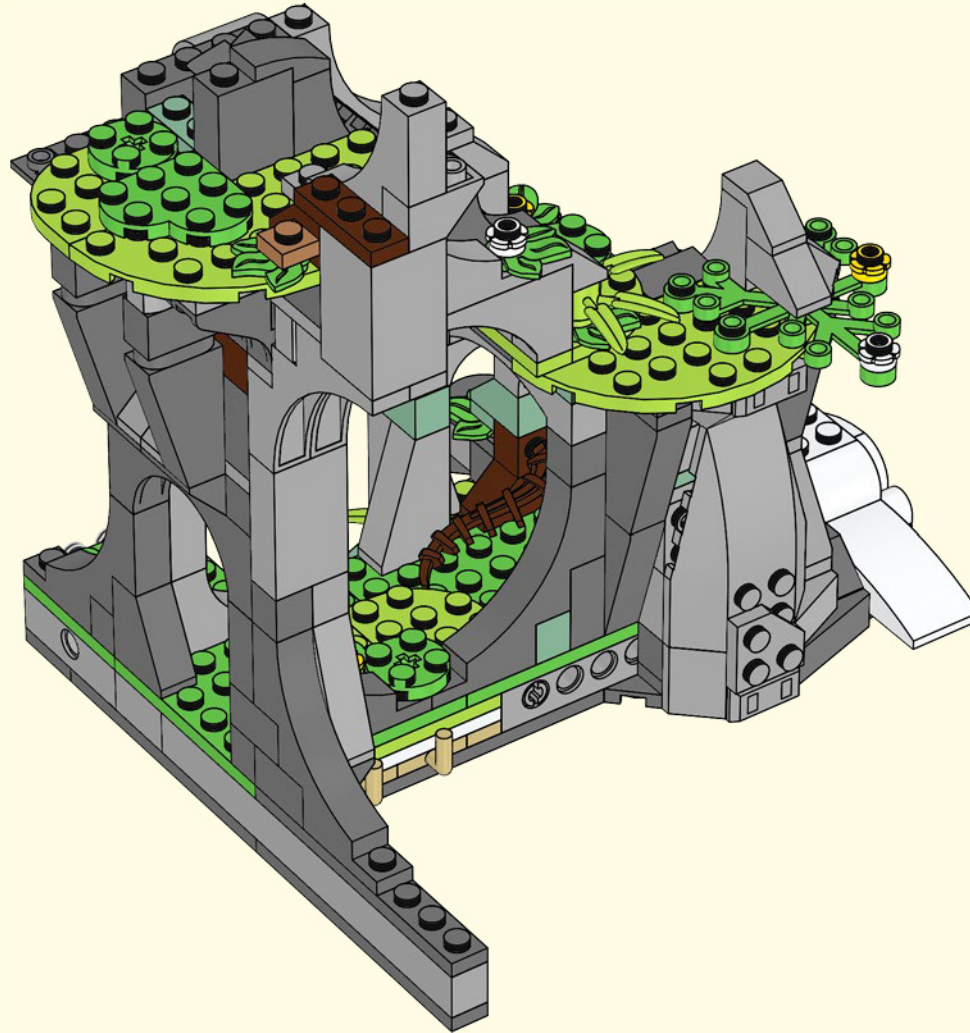

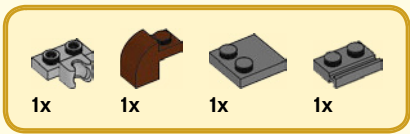

# 148

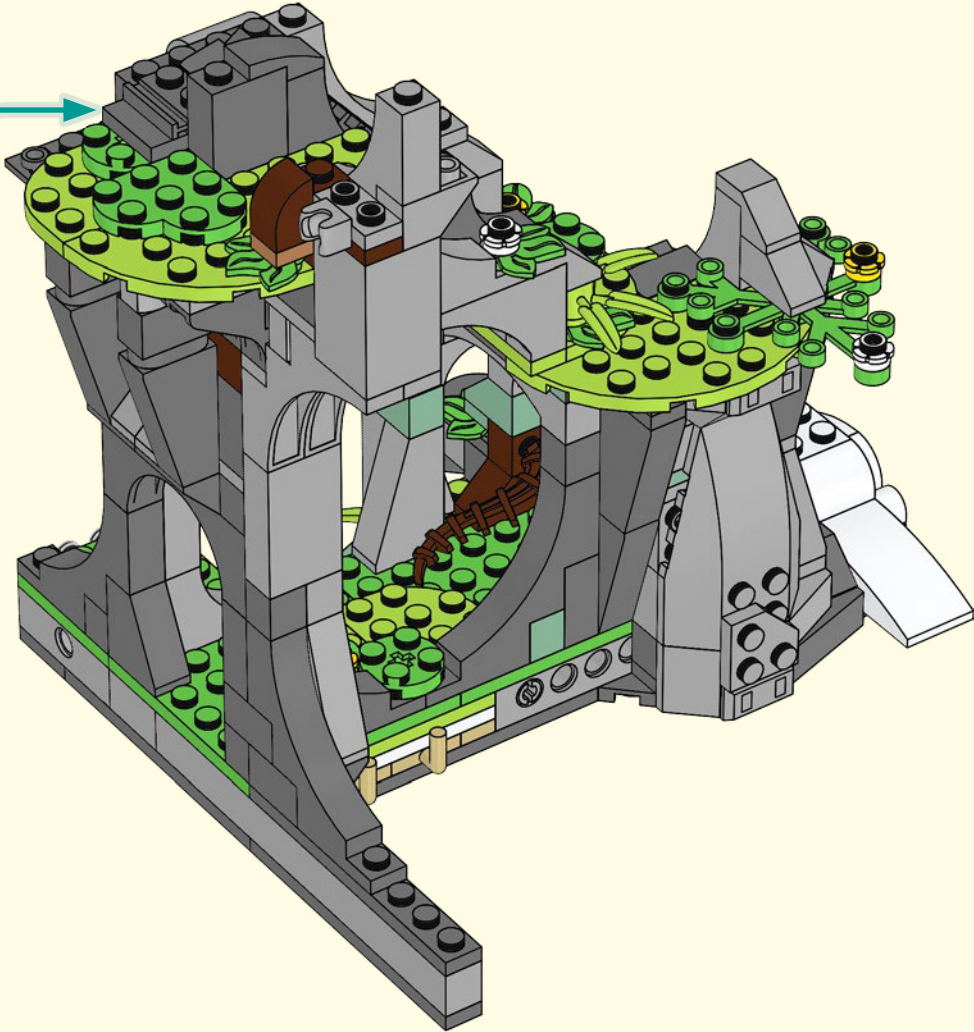
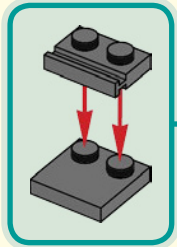



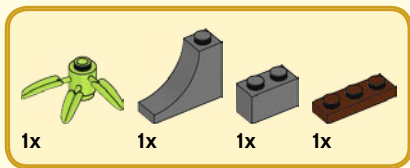

149

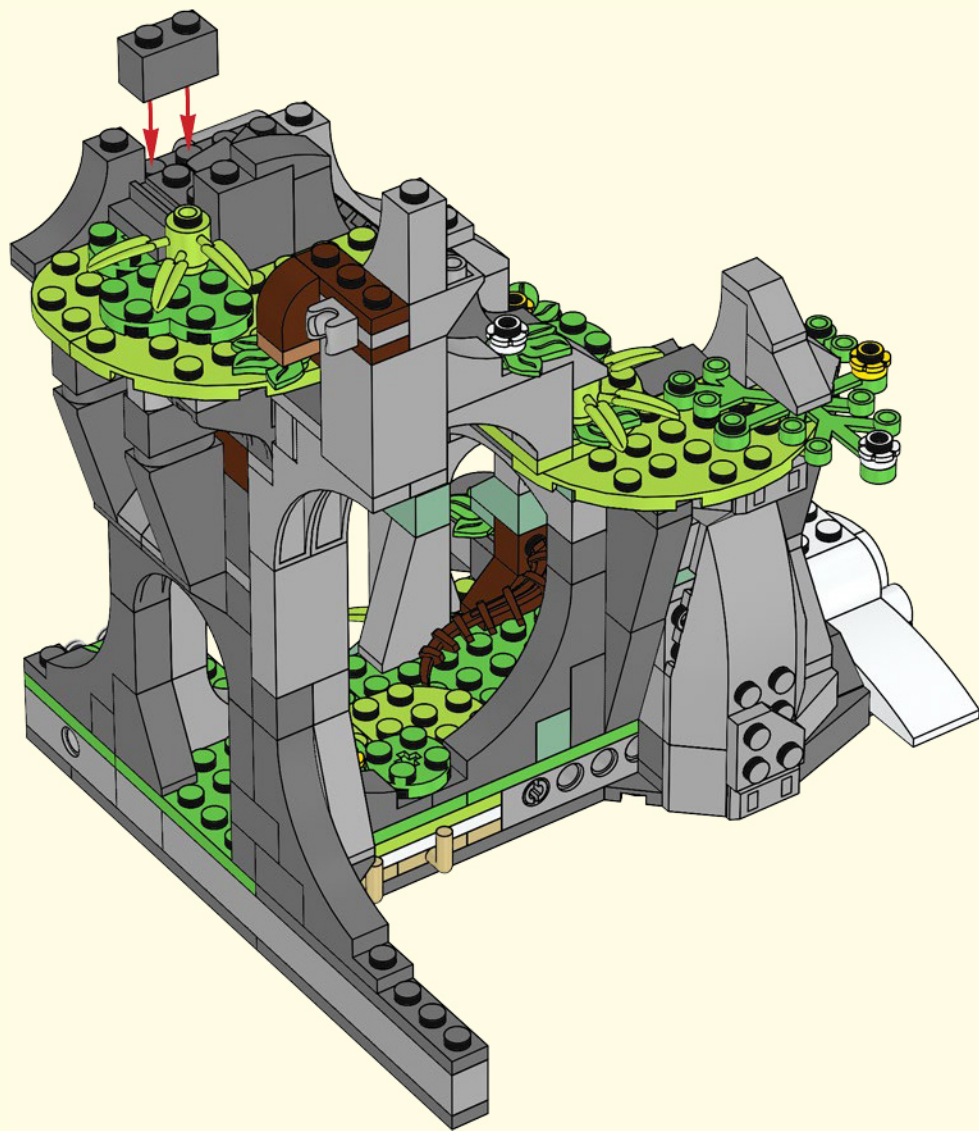

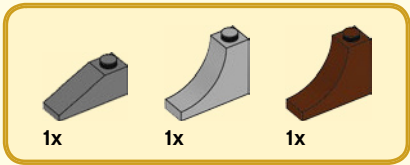

150

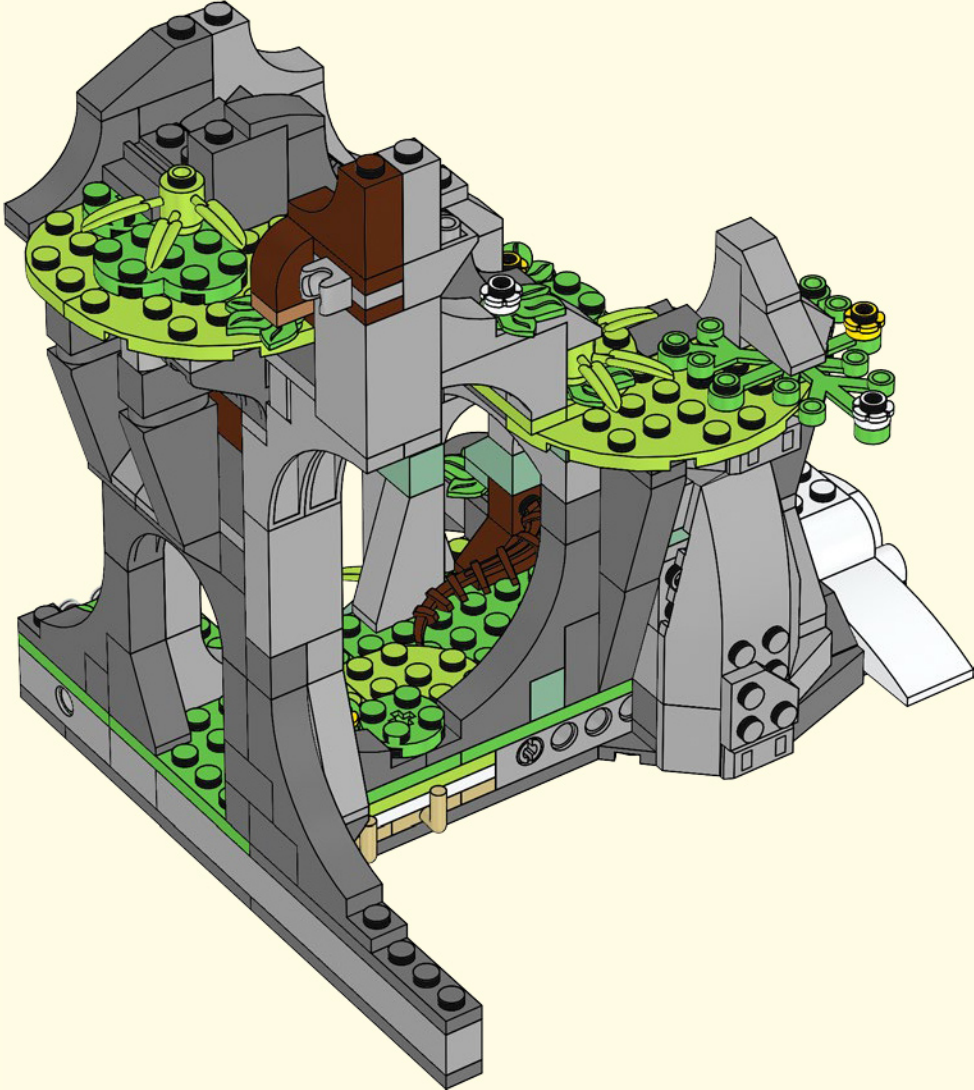

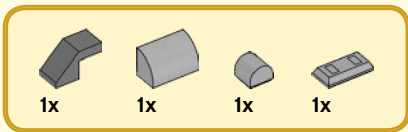

151

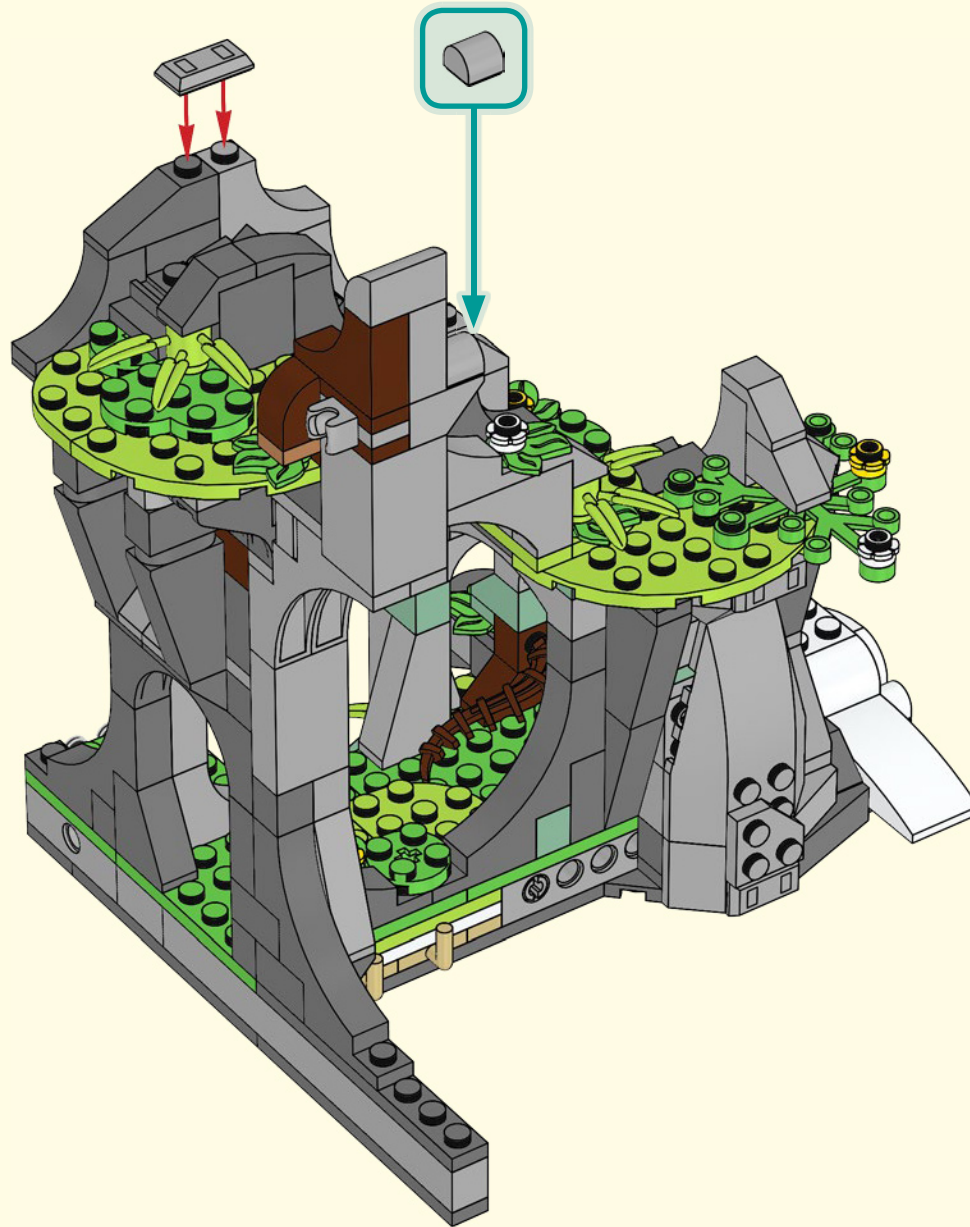



152

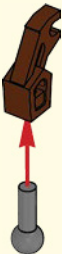

153

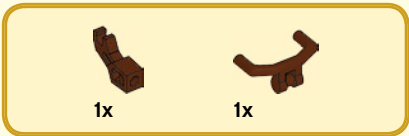
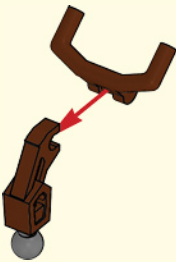

154

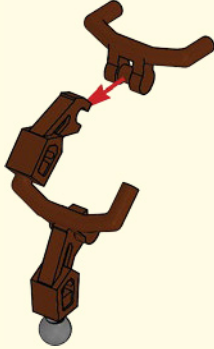

155

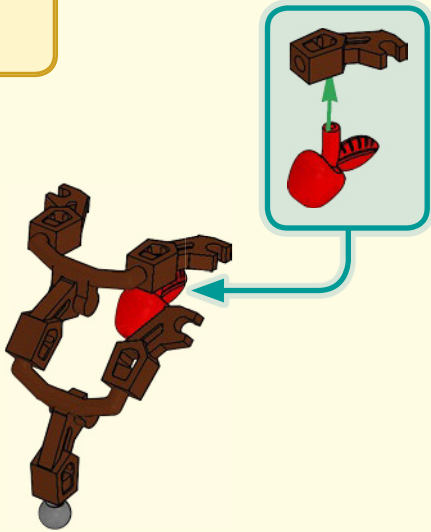



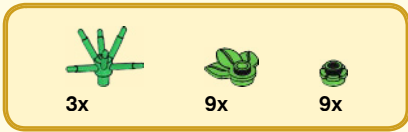

156

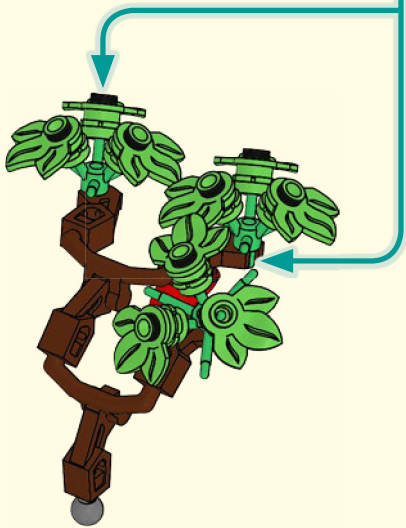
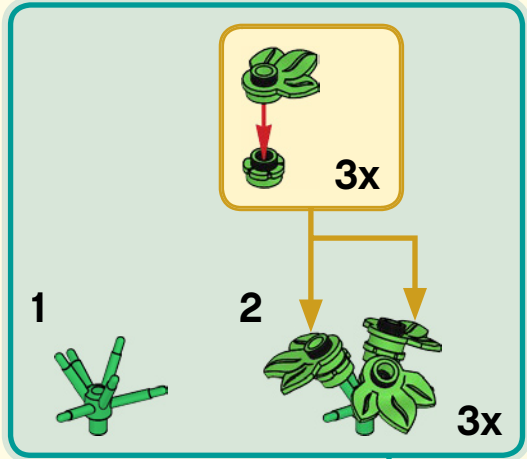

157

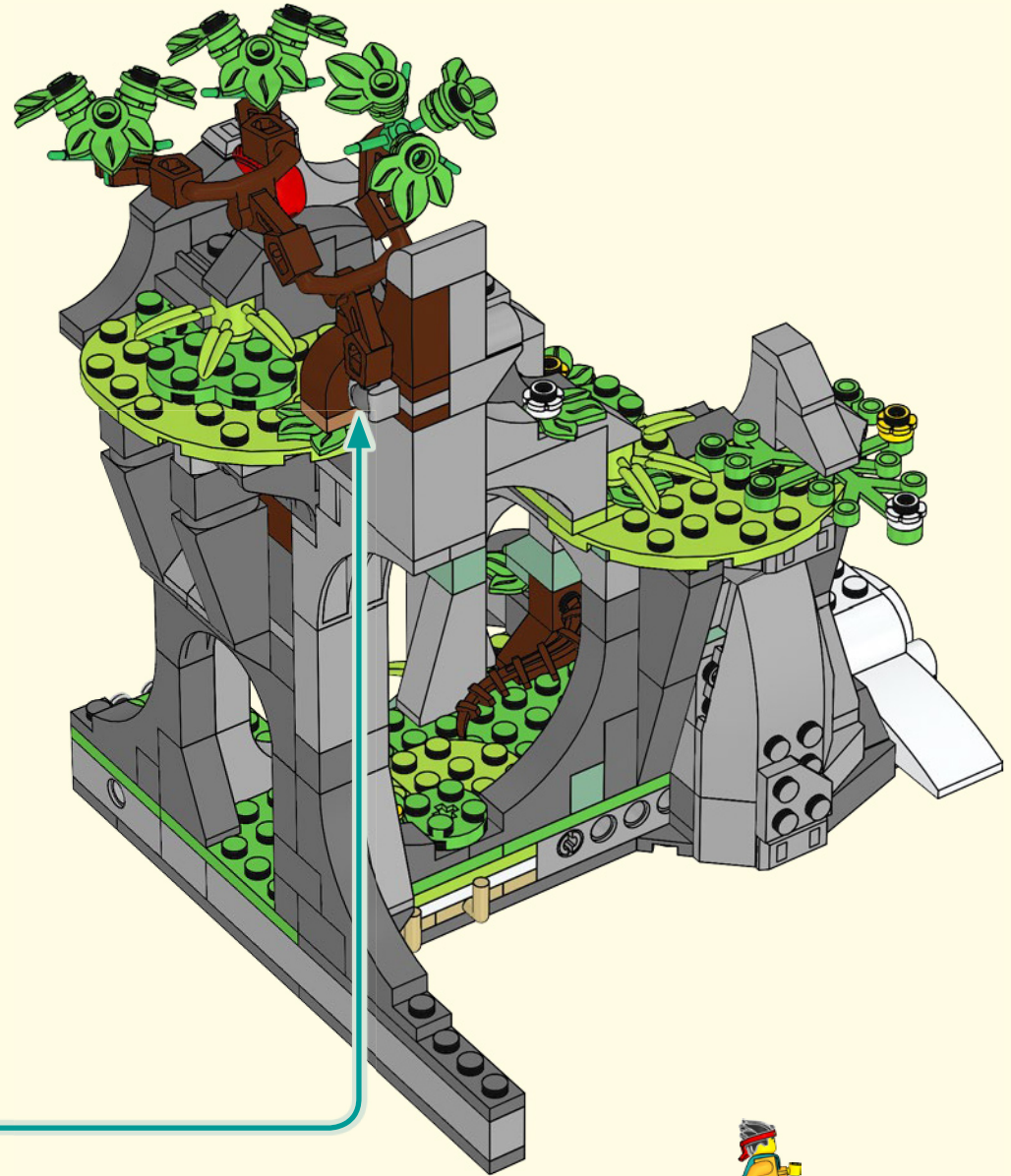



158

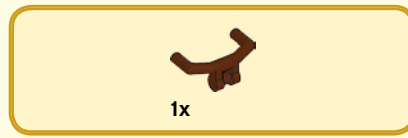
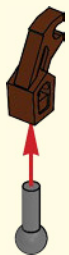

159

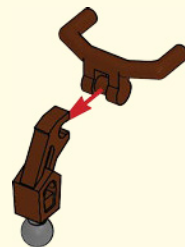

160

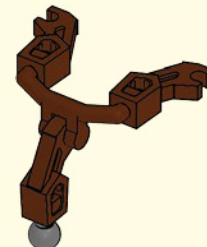

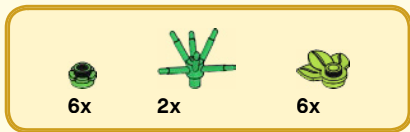

161

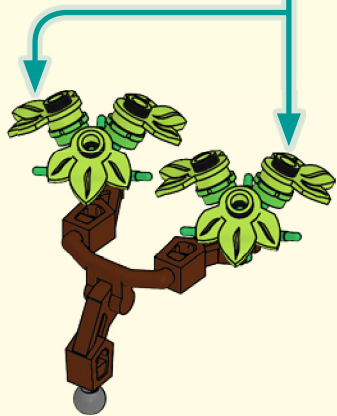
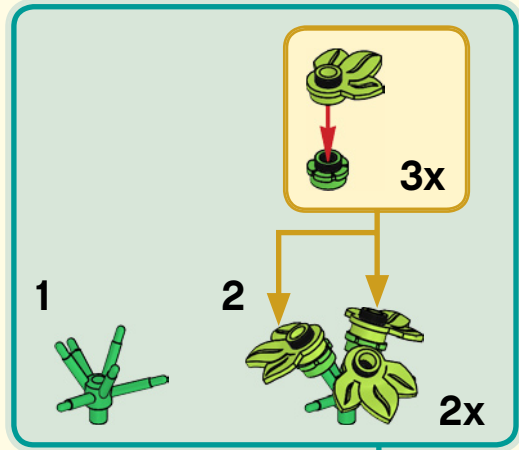

162

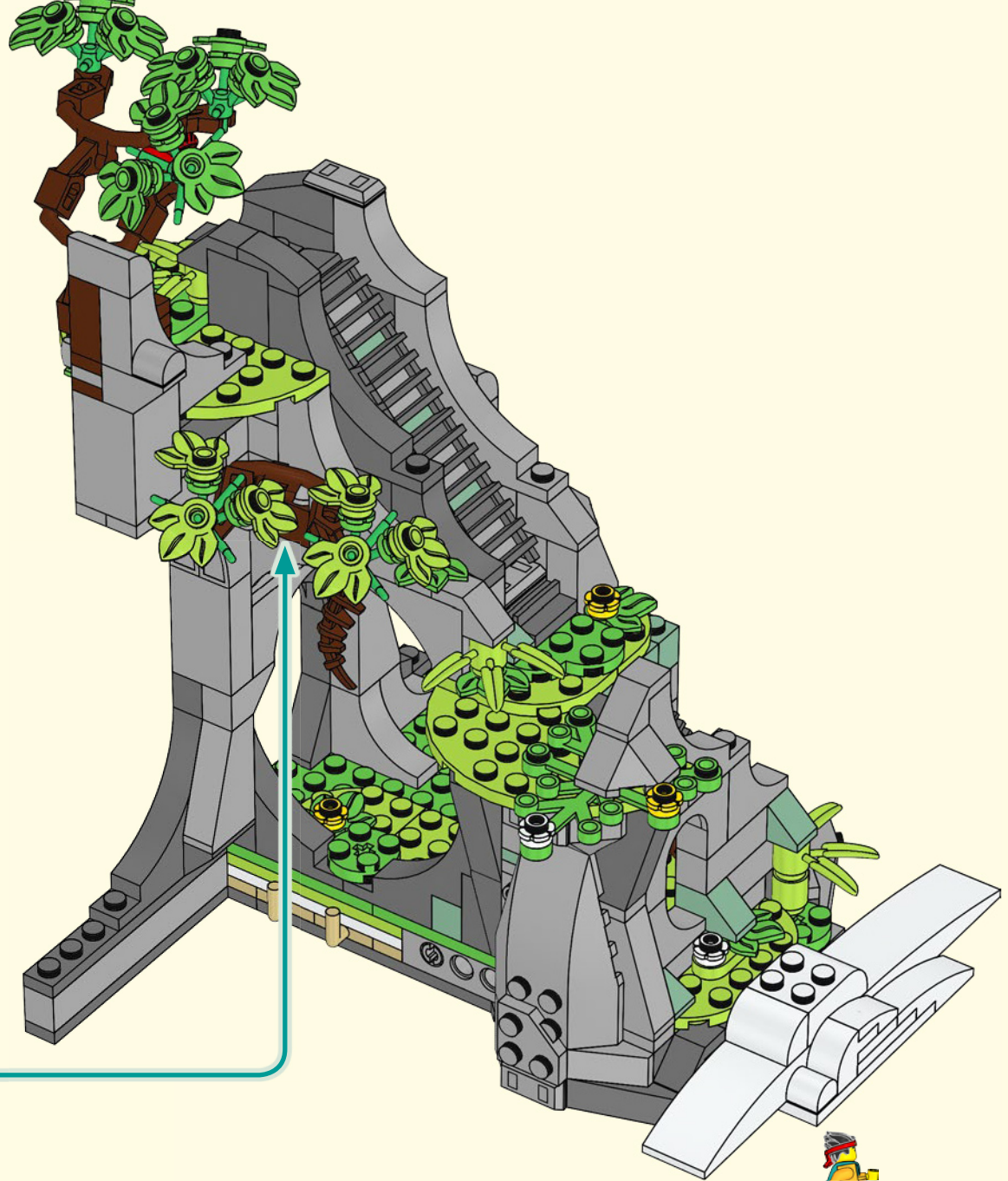



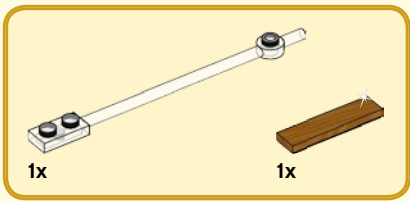

163

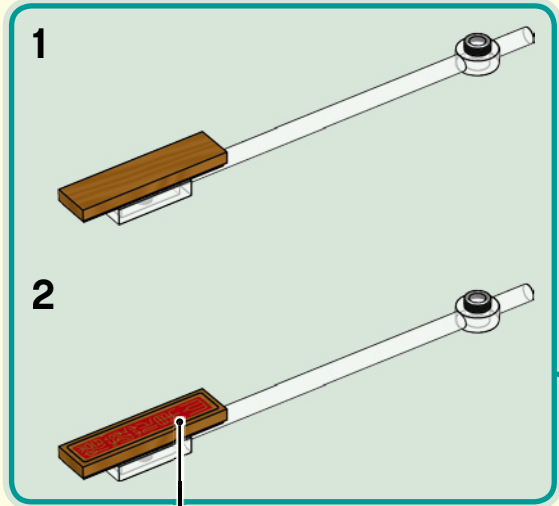



164

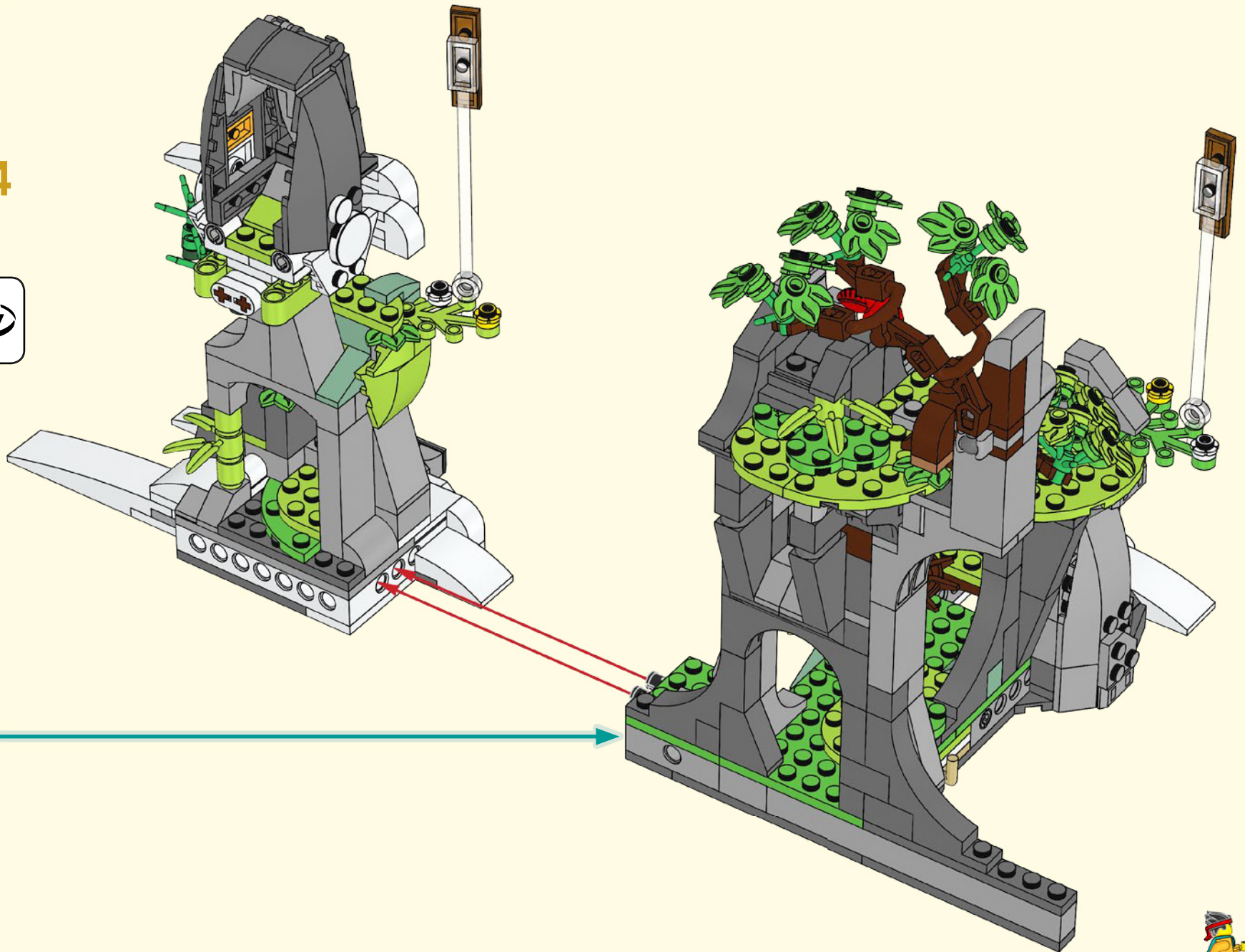



1x

165

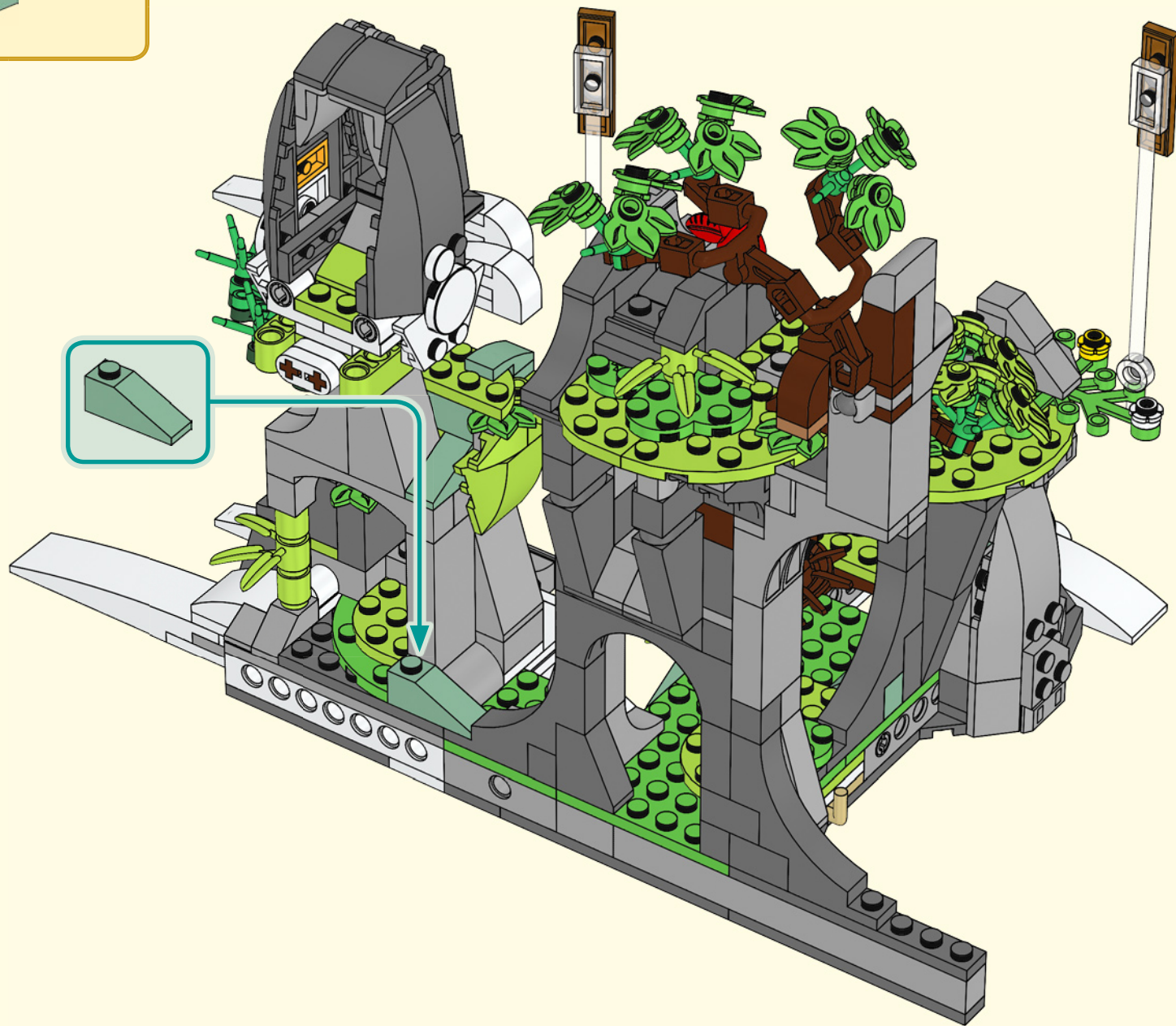



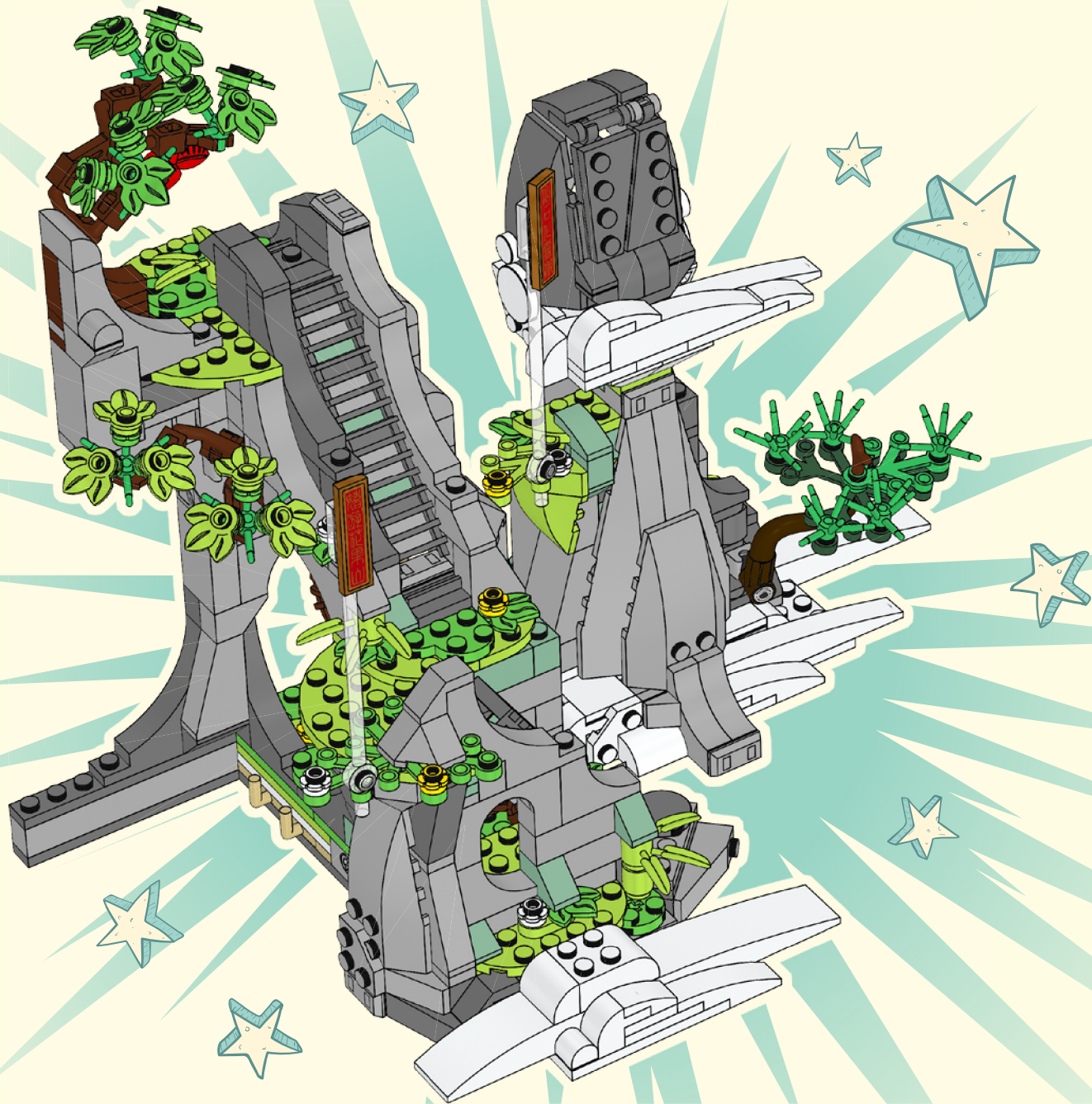

# WIN

GO TO [WWW.LEGO.COM/PRODUCTFEEDBACK](http://WWW.LEGO.COM/PRODUCTFEEDBACK) AND  
GIVE US YOUR SHORT **FEEDBACK** ABOUT THIS  
LEGO® SET FOR A CHANCE TO WIN  
A COOL LEGO PRIZE.

Terms & Conditions apply

## [LEGO.com/productfeedback](http://LEGO.com/productfeedback)

### GEWINNE

Erzähle uns auf  
[www.LEGO.com/productfeedback](http://www.LEGO.com/productfeedback)

etwas über die Erfahrungen, die  
du mit diesem LEGO® Set gemacht  
hast, und sichere dir die Chance  
auf einen coolen LEGO Preis!

Es gelten die  
Teilnahmebedingungen

### GAGNE

Rends-toi sur  
[www.LEGO.com/productfeedback](http://www.LEGO.com/productfeedback)

et donne-nous quelques com-  
mentaires sur ce produit LEGO®  
pour avoir une chance de gagner  
un prix LEGO !

Voir Conditions Générales

### GANAN

Visita  
[www.LEGO.com/productfeedback](http://www.LEGO.com/productfeedback)

y envíanos tu opinión acerca de  
este set LEGO®. ¡Participarás en el  
sorteo de un premio LEGO!

Términos y Condiciones aplicables

### 获取奖品

登录  
[www.LEGO.com/productfeedback](http://www.LEGO.com/productfeedback)

给出关于此乐高®套装的简短反馈，  
就有机会获得炫酷乐高奖品

《条款及条件》适用

### 경품 당첨 기회

[www.LEGO.com/productfeedback](http://www.LEGO.com/productfeedback)

페이지로 이동하여 이 레고® 세트에  
대한 간략한 피드백을 보내 주시고  
멋진 레고 경품을 탈 수 있는 기회도  
잡으십시오

약관 적용

### ЗАПОЛНИ АНКЕТУ И ПОЛУЧИ ПРИЗ

Перейди по ссылке  
[www.LEGO.com/productfeedback](http://www.LEGO.com/productfeedback)

ответь всего на несколько во-  
просов об этом наборе LEGO®,  
и у тебя появится шанс выиграть  
замечательный приз от компании  
LEGO.

Применяются Условия и правила  
участия