



Kingdoms

7949



WARNING: CHOKING HAZARD.
Small parts. Not for children under 3 years.

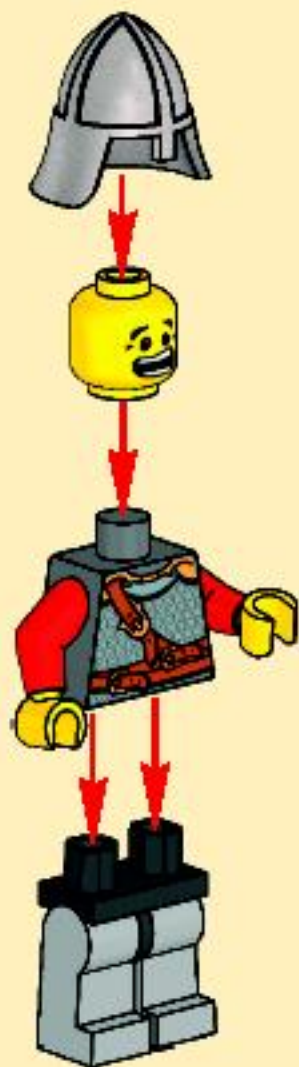

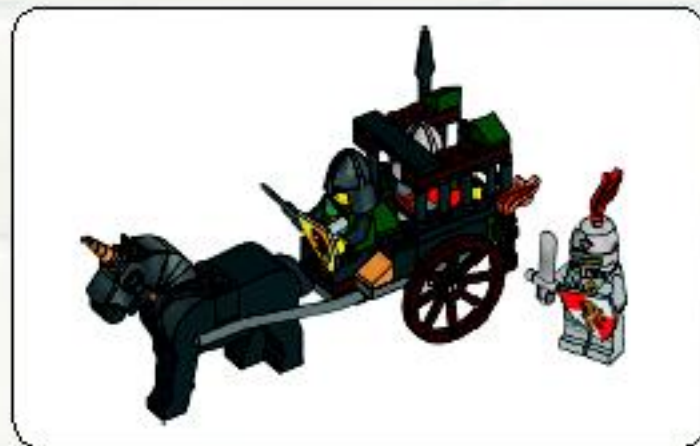

1



AVERTISSEMENT : RISQUE D'ÉTOUFFEMENT.
Contient des petites pièces. Ne convient pas aux enfants de moins de 3 ans.



ADVERTENCIA: PELIGRO DE ASFIXIA.
No recomendado para niños menores de 3 años. Contiene piezas pequeñas.

2

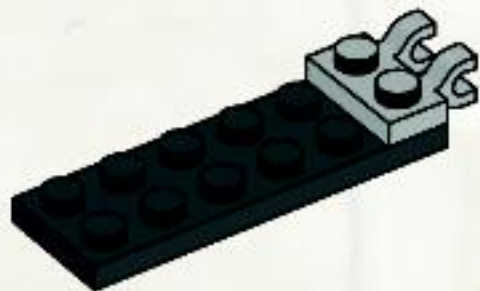

3

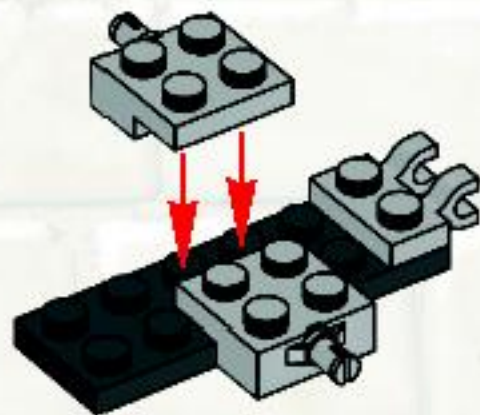

4

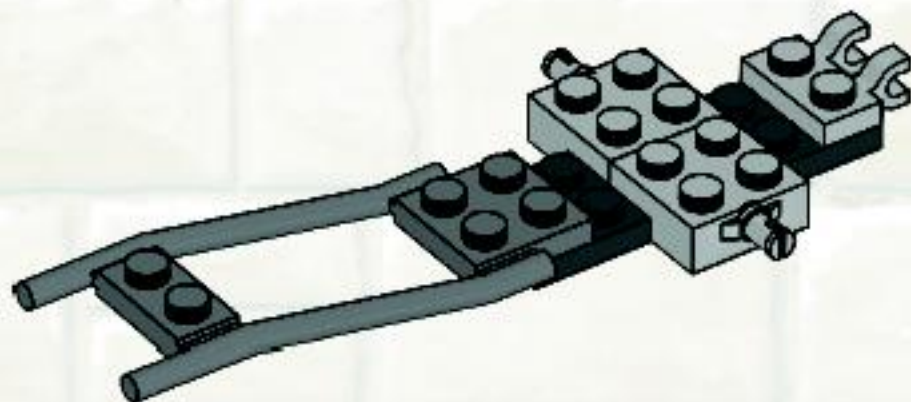

5

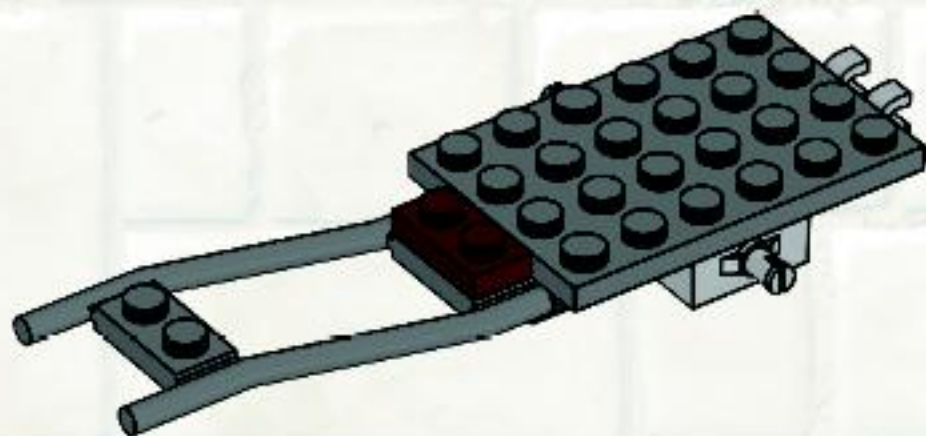

6

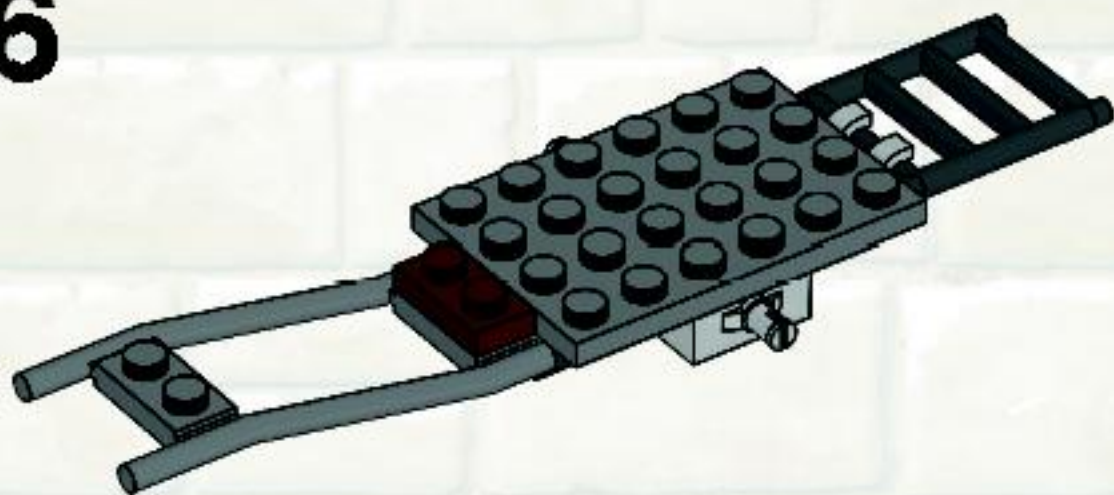

7

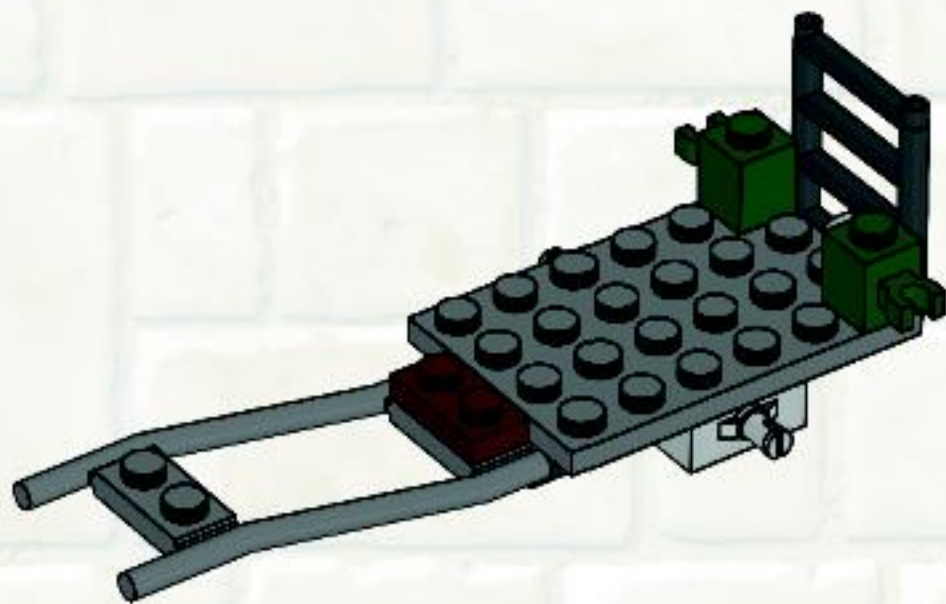

8

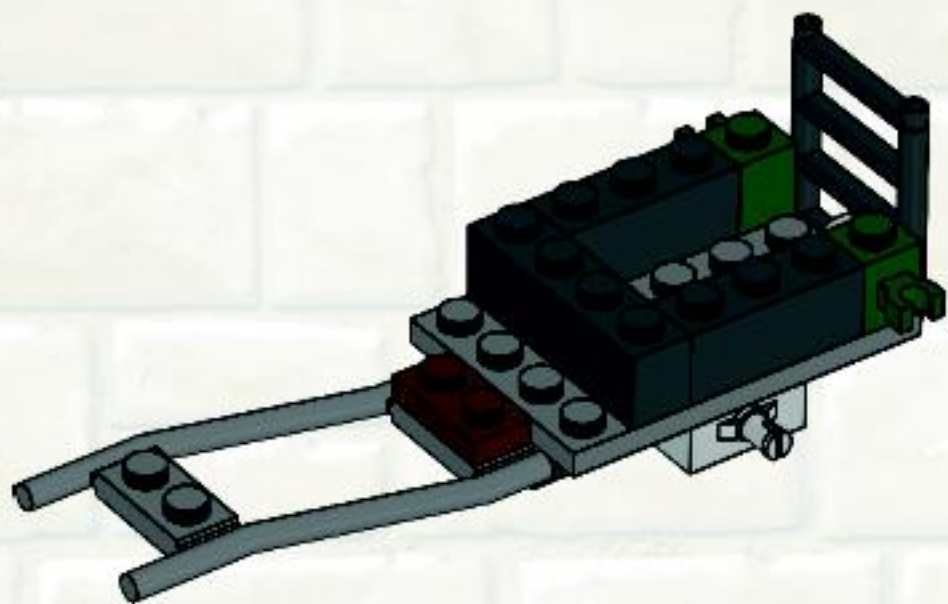

9

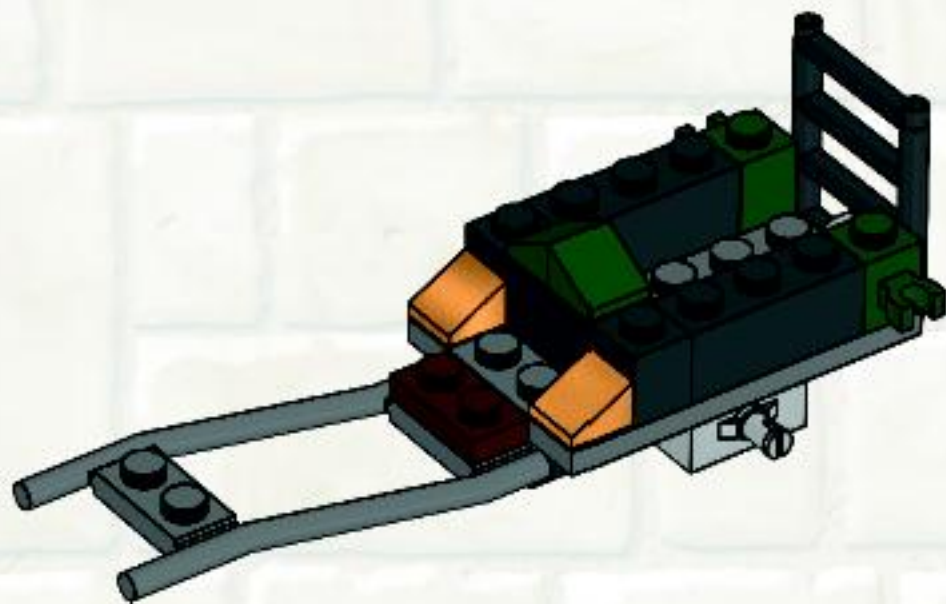

10

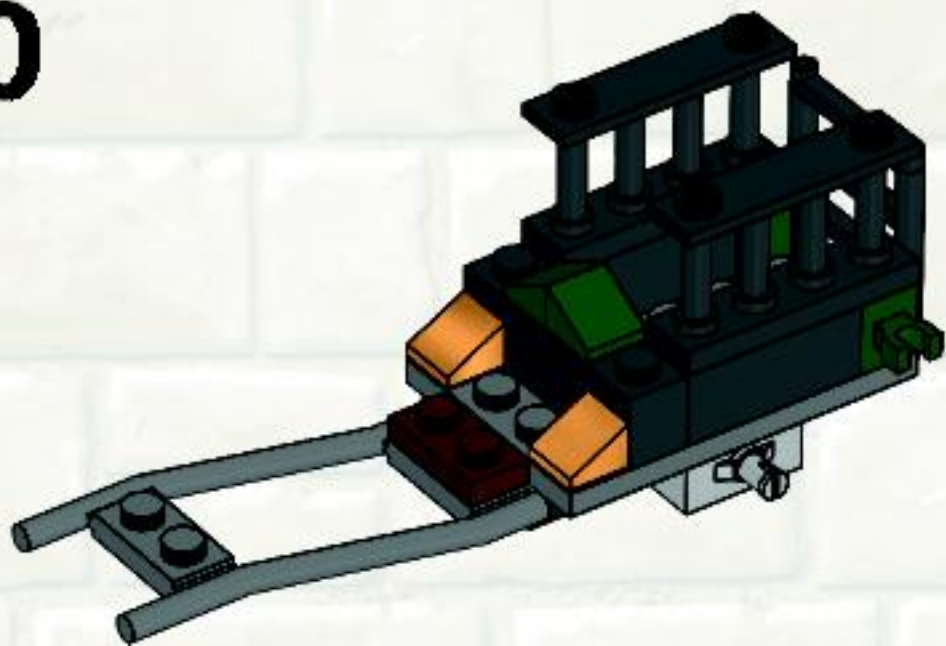

11

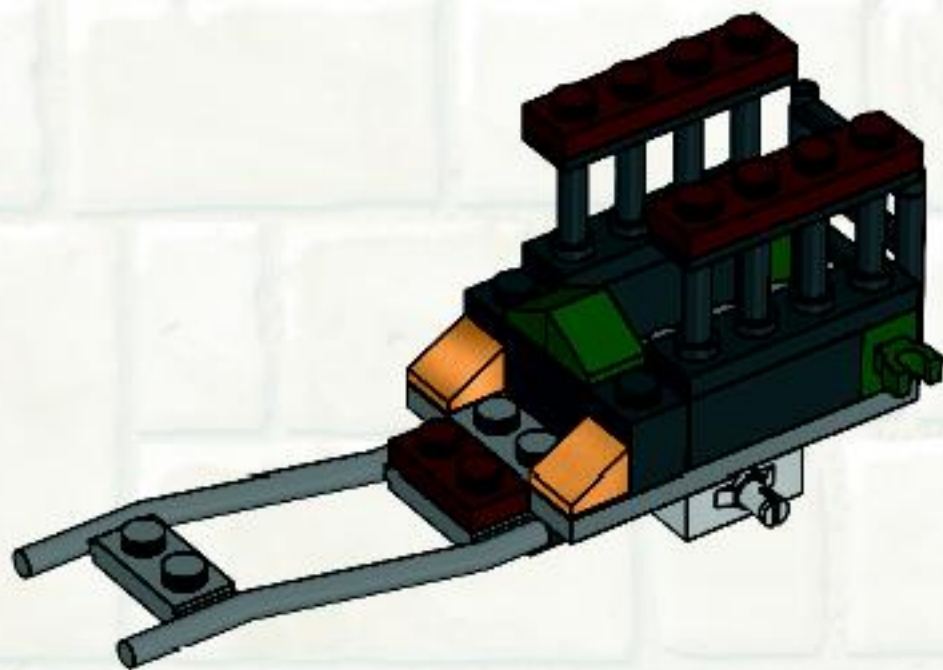

12

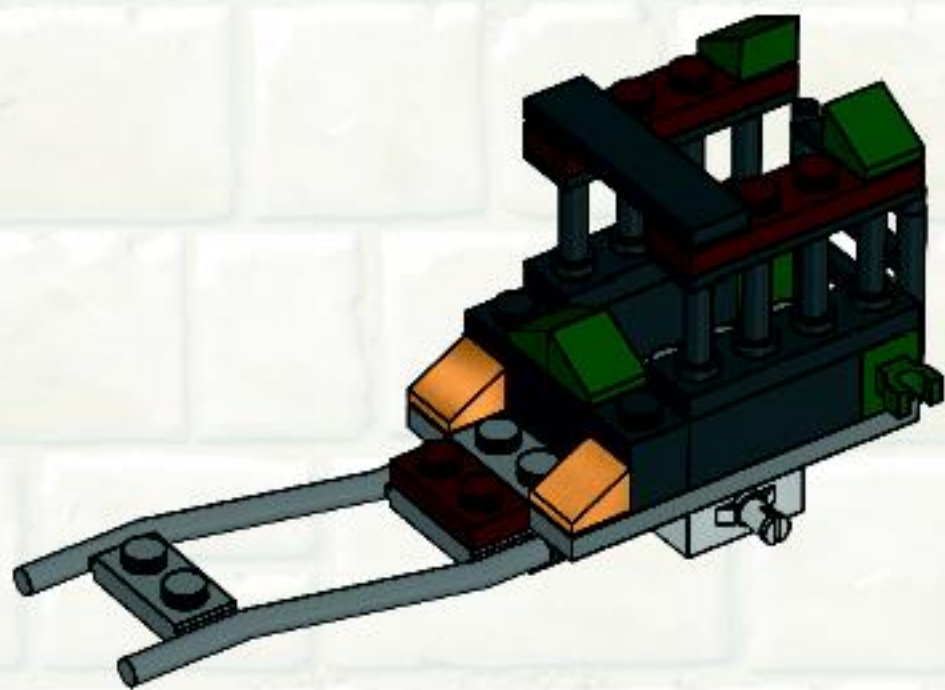

13

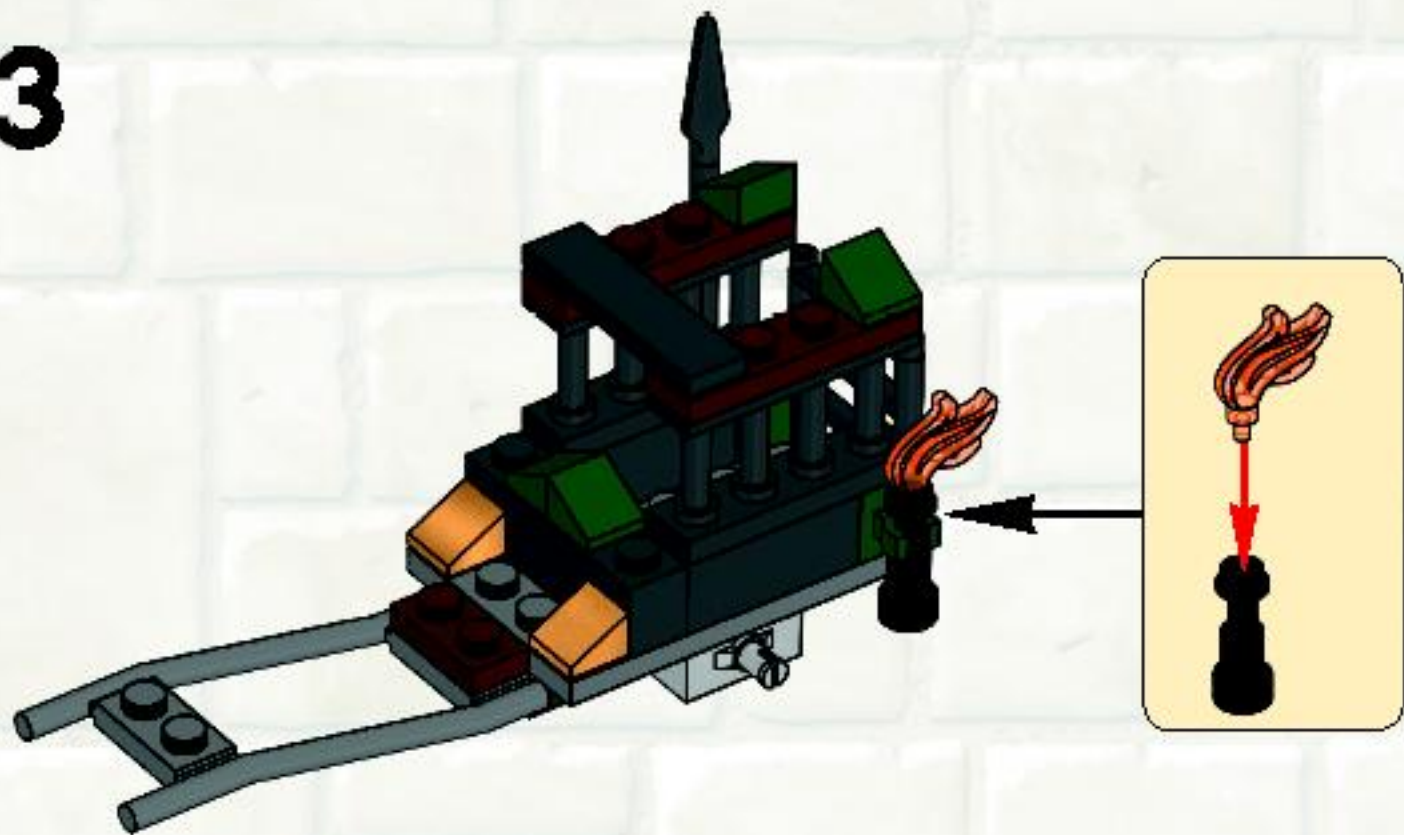

14

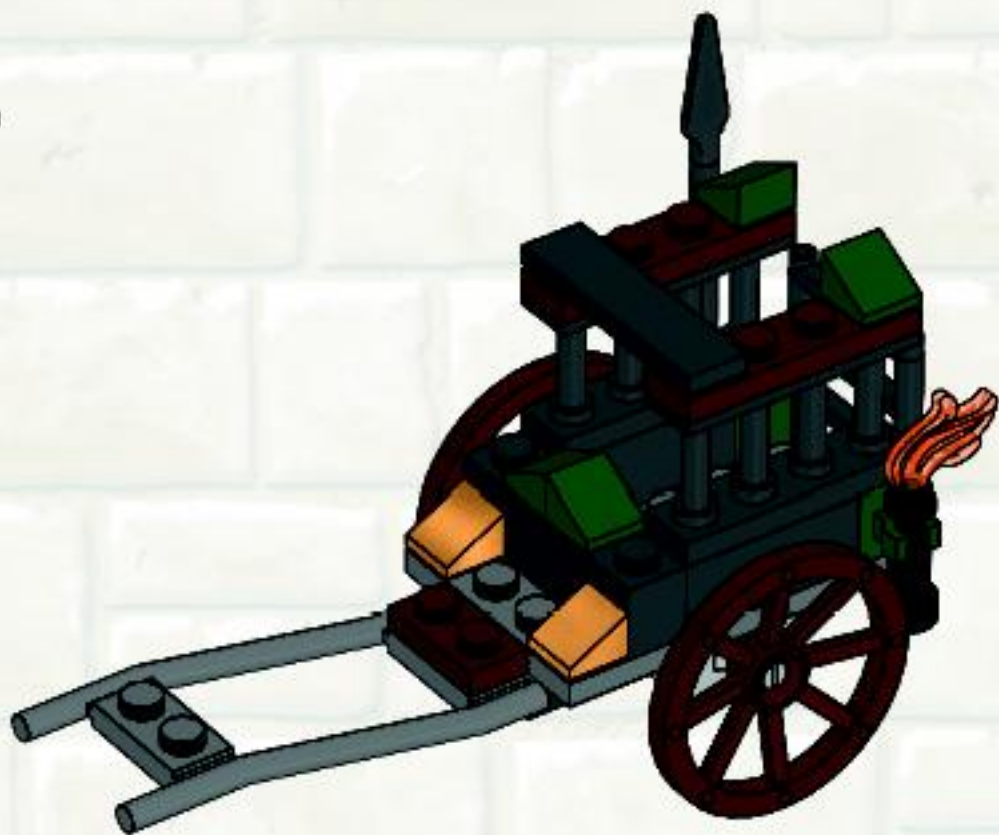

1



2



15

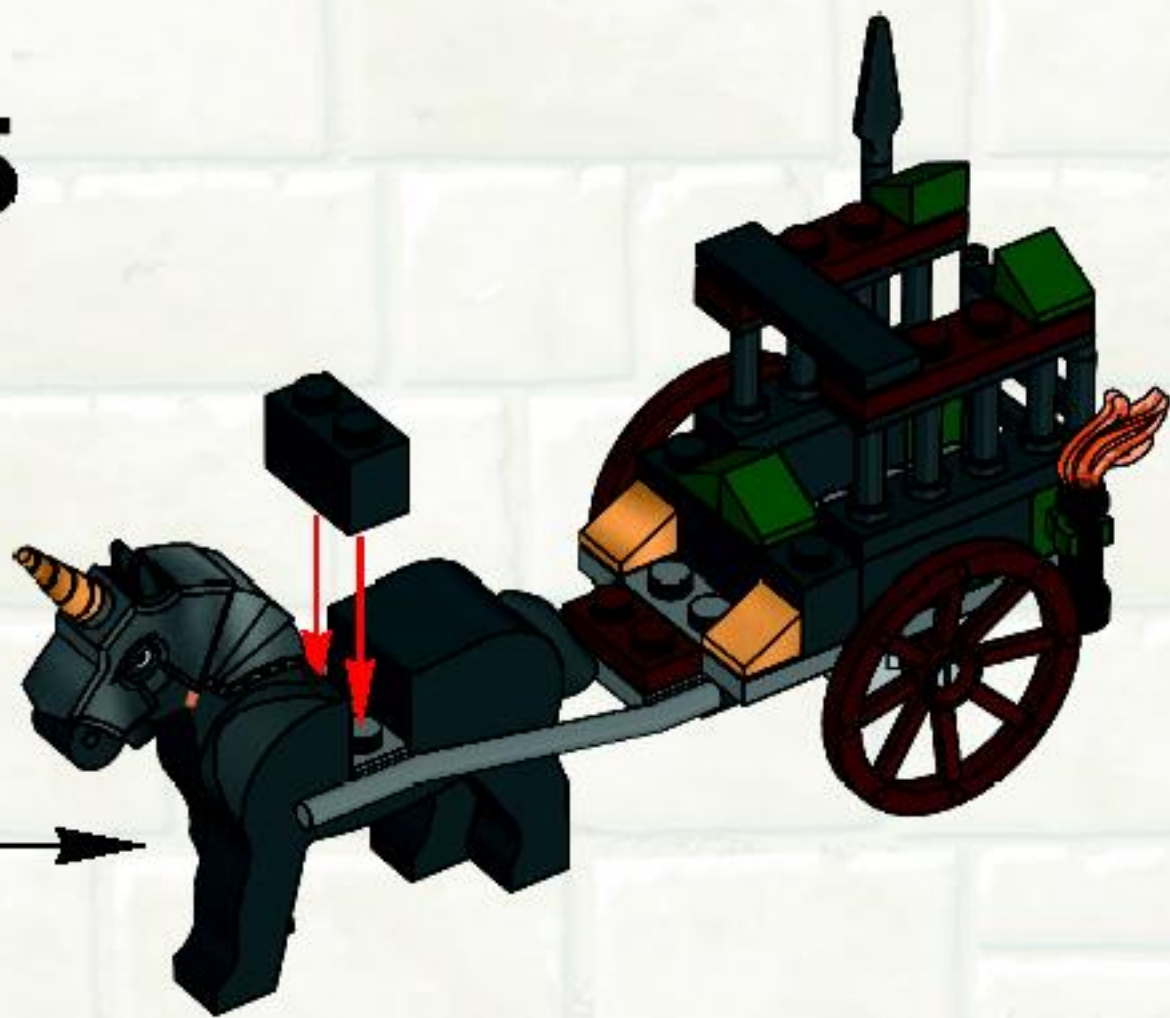





Kingdoms





1x
4586289



1x
4224479



1x
4584757



1x
4540552



1x
4587105



1x
4506011



1x
9339



1x
300426



2x
362226



1x
301026



1x
243126



1x
379526



1x
4521681



2x
4185652



1x
449726



1x
4587388



2x
4583846



4x
4504375



1x
4586500



1x
4211150



2x
4211190



2x
4211279



1x
4556157



2x
4211496



1x
4492335



1x
4586384



1x
4586504



1x
4586308



1x
4586334



2x
4587002



1x
4584762



1x
4506812



1x
4261572



1x
4528206



1x
4586498



1x
4211115



1x
4268684



1x
4540865



1x
4505002



1x
4538950



Customer Service

Kundenservice

Service Consommateurs

Servicio Al Consumidor

www.lego.com/service or dial



FREE! GRATIS! GRATUIT!



club
MAGAZINE™

www.LEGOclub.com



00800 5346 5555*        

  **1-866-534-6258 • 1-877-518-5346**

US & Canada only

Canada seulement

* Free phone. Mobile charges may apply. * Numéro sans Frais. Des Frais peuvent s'appliquer avec les téléphones cellulaires.

* Gebührenfrei. Kosten für Anrufe aus Mobilfunknetzen können anfallen. * Gratis telefonnummer voor vaste lijn.

* Deber este gratis número, aún le ringerá por cobraré. * Det är gratis, men du ringer för en kost telefon.



**VISIT THE WORLD'S
BIGGEST LEGO® SHOP!**

www.LEGOshop.com

7946



7947



7948



7949



7950





WIN!

Go to www.nielsen.com/LEGO to fill out a survey for a chance to win a cool LEGO® Product.

No purchase necessary.

Open to all residents where not prohibited.



www.nielsen.com/LEGO

GEWINNE!

Nimm an der Umfrage auf www.nielsen.com/LEGO teil und hab die Chance ein cooles LEGO® Produkt zu gewinnen!

Die Teilnahme am Gewinnspiel führt zu keinerlei Kaufverpflichtungen. Teilnahme in allen nicht ausgeschlossenen Ländern möglich.

WIN!

Ga naar www.nielsen.com/LEGO, vul een enquêteformulier in en maak kans op een cool LEGO® product.

Geen aankoopverplichting. Iedereen mag deelnemen, uitgezonderd ingezette landen van landen waar een enquêteverbod geldt.

GAGNE!

Visite www.nielsen.com/LEGO pour répondre à un questionnaire et avoir une chance de gagner un produit LEGO® très cool!

Aucune obligation d'achat. Ouvert à tous les résidents des pays autorisés.

当てよう!

www.nielsen.com/LEGO にアクセスして、アンケートにご記入ください。当選者にはレゴ製品を差し上げます。

お問い合わせの必要はありません。禁止されている国あり。すべての詳細をご利用ください。

4597960

LEGO and the LEGO logo are trademarks of the LEGO Group. ©2010 The LEGO Group. ©2010 LucasFilm Ltd. & TM. All rights reserved. Used under authorization.