



**SPEED**  
CHAMPIONS

76923



LEGO® Builder



### **Get excited about our new packaging!**

We're switching from plastic to paper-based packaging. That's why you might find a mix of paper and plastic in our boxes!

### **Nos nouveaux emballages vous emballeront !**

Nous passons des emballages en plastique aux emballages à base de papier. C'est pourquoi vous pourriez trouver un mélange de papier et de plastique dans nos boîtes !

### **¡Te presentamos nuestros nuevos empaques!**

Estamos sustituyendo las bolsas de plástico por bolsas con base de papel. ¡Por eso, puedes encontrar una mezcla de papel y de plástico en nuestras cajas!

**[LEGO.com/sustainable-packaging](https://www.lego.com/sustainable-packaging)**

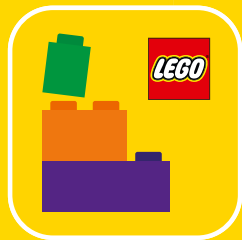

Q LEGO® Builder

# BUILDER



Apple and the Apple logo are trademarks of Apple Inc., registered in the U.S. and other countries and regions. App Store is a service mark of Apple Inc. Google Play and the Google Play logo are trademarks of Google LLC. Tencent and the Tencent logo are trademarks of Tencent Inc.

Q [LEGO.com/devicecheck](https://lego.com/devicecheck)

**EN** Ask parents' permission before going online | **DE** Eltern um Erlaubnis bitten, bevor du online gehst | **FR** Demande l'autorisation d'un parent avant d'aller en ligne | **IT** Chiedi il permesso ai tuoi genitori prima di andare online | **ES** Pídeles permiso a tus papás antes de conectarte a Internet | **PT** Pede autorização aos pais antes de acederes online | **ZH** 上网前应先征得父母的同意 | **PL** Poproś rodziców o zgodę, zanim wejdziesz do Internetu | **CS** Než půjdeš na internet, požádej rodiče o svolení | **SK** Skôr než pôjdeš na internet, vypýtaj si povolenie od rodičov | **HU** Kérj szülői engedélyt, mielőtt online csatlakoznál! | **RO** Cere permisiunea părinților înainte de a te conecta online | **BG** Поискайте разрешение от родител, преди да влезете онлайн | **LV** Pirms došanās tiešsaistē palūdz atļauju vecākiem | **ET** Enne Interneti kasutamist küsi vanematelt luba | **LT** Prieš prisijungdami prie interneto, atsiklauskite tėvų



1

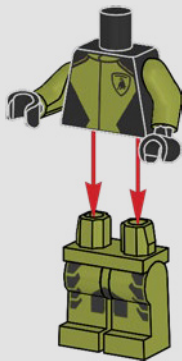

2





3

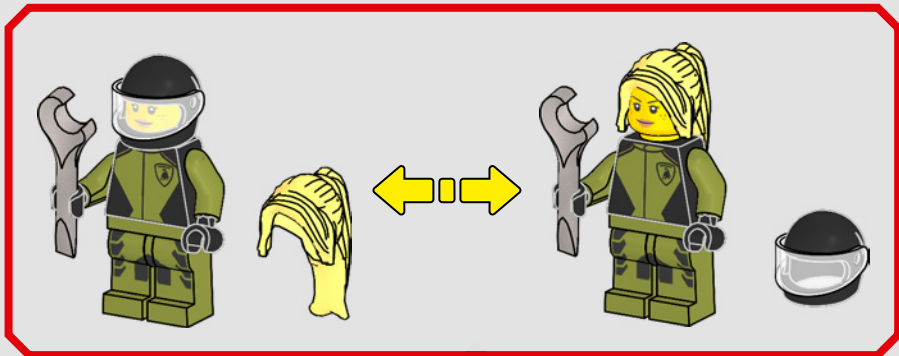

4



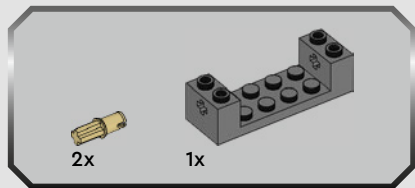

1

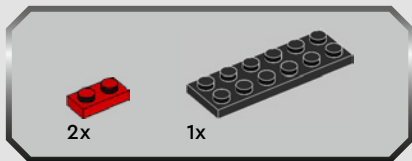
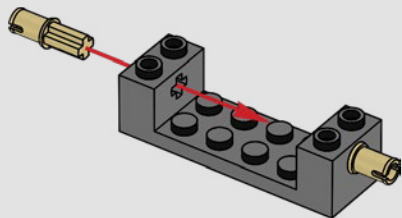

2

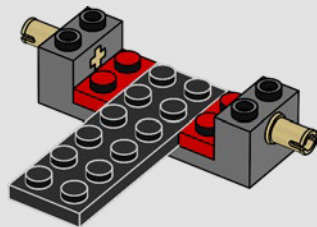

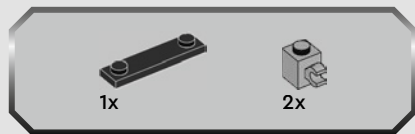

3

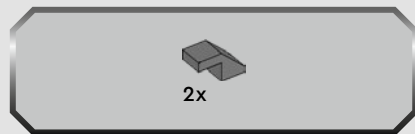
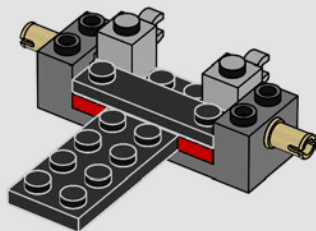

4

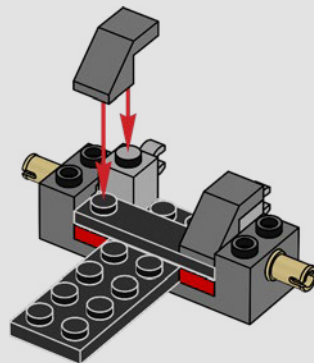

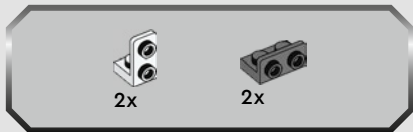

5

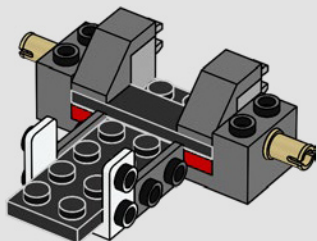

6

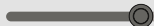
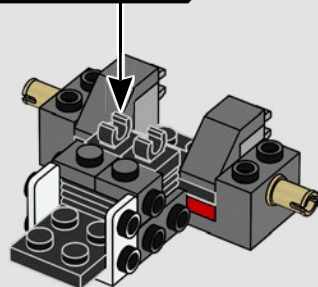
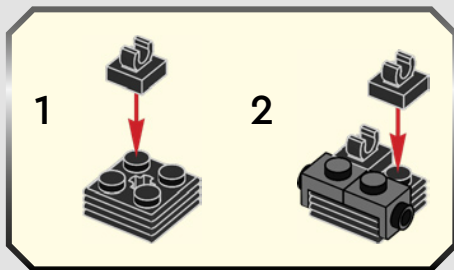



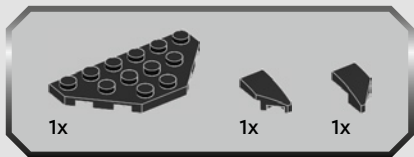

7

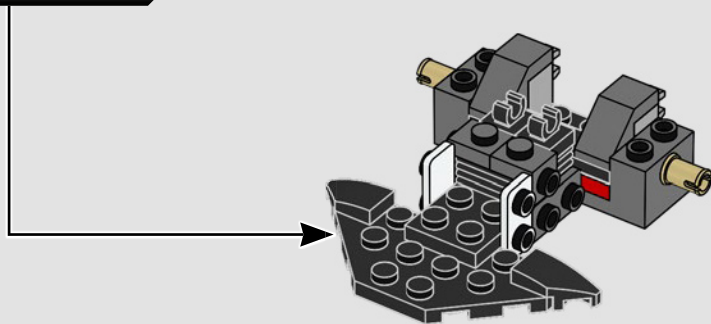
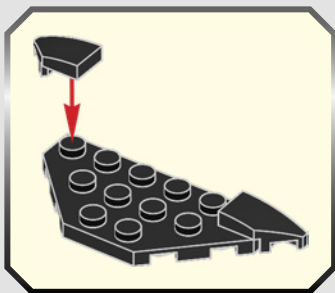

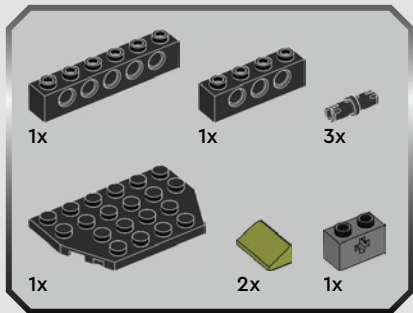

8

1

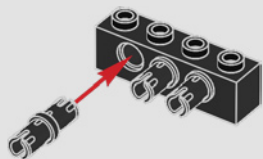

2

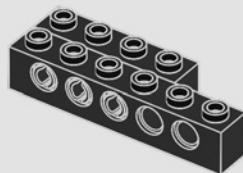

3

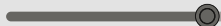
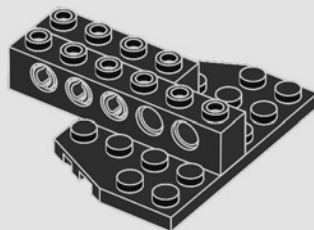

4

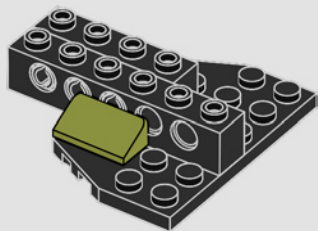

5

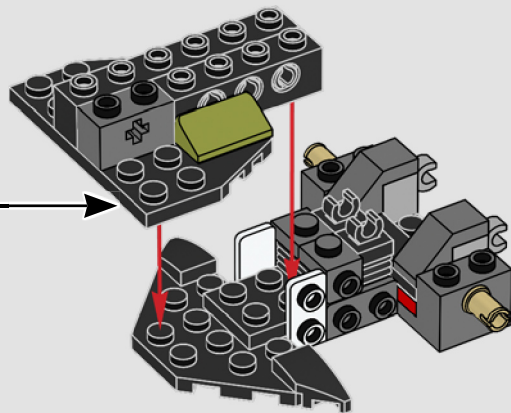



9

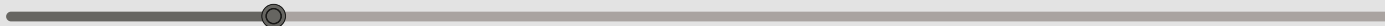
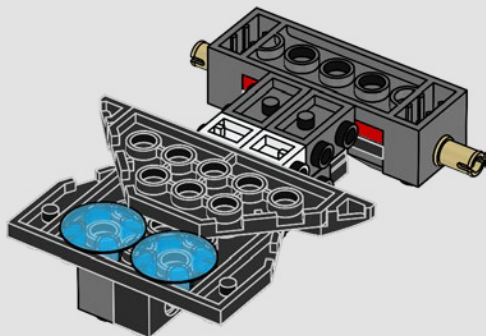

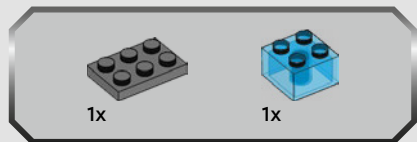

10

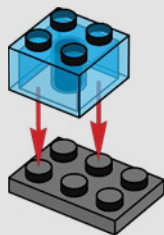

11

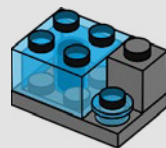

12

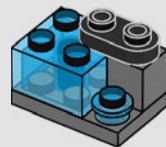



1x



1x

13

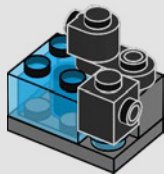

2x

14

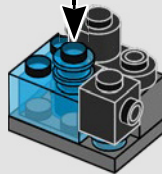
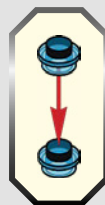

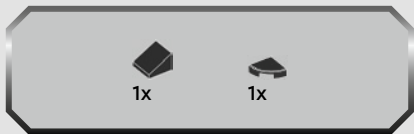

15

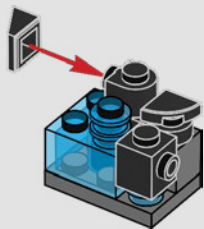

16

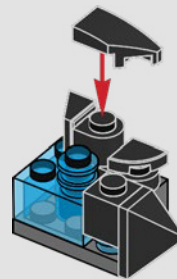



17

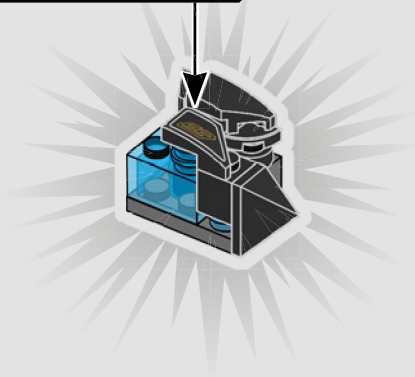
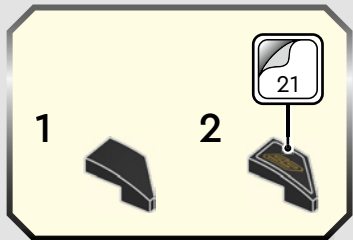

18

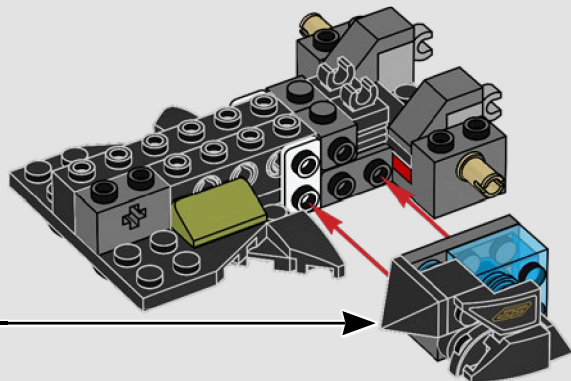



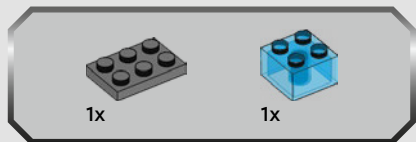
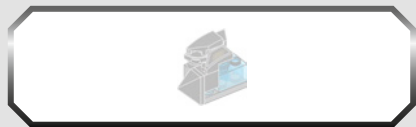

19

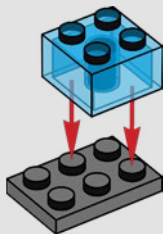

20

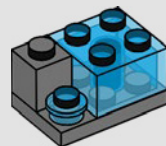

21

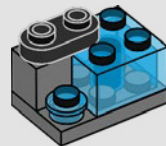



1x



1x

22

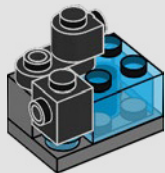

2x

23

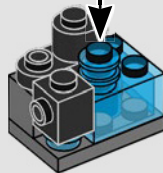
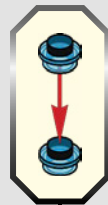

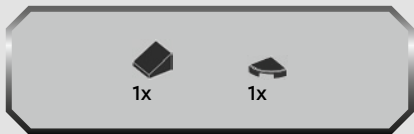

24

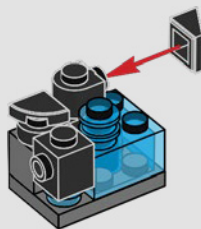

25

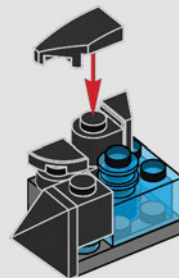



26

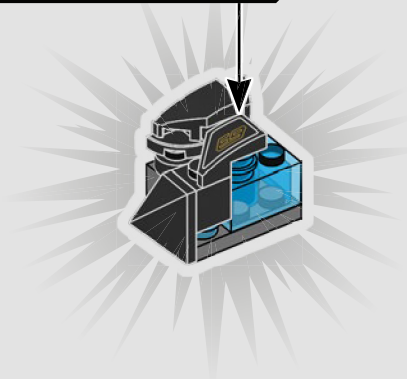
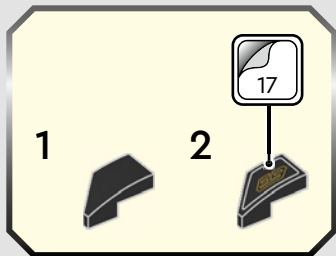

27

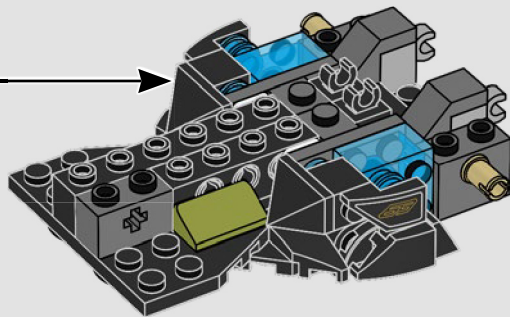

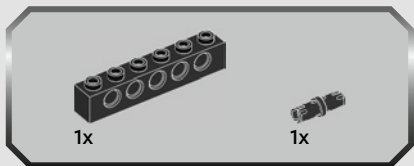
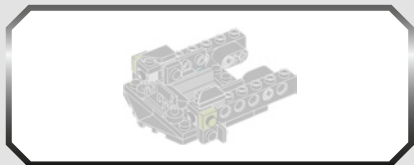

28

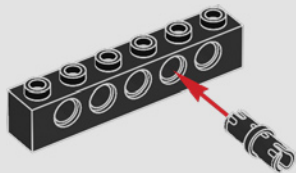

29

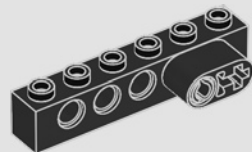

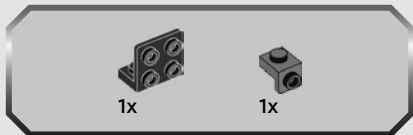

30

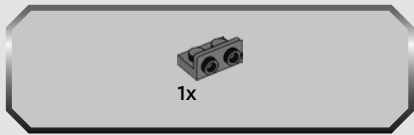
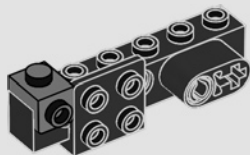

31

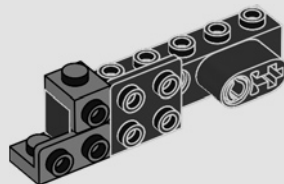



32

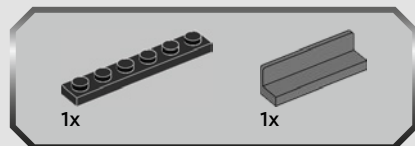
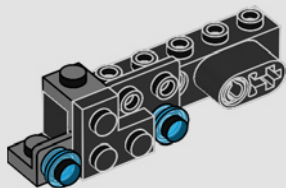

33

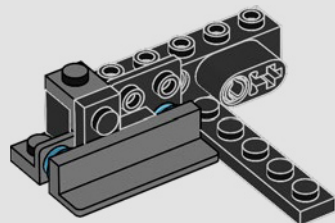

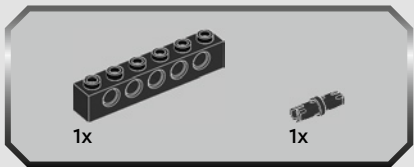

34

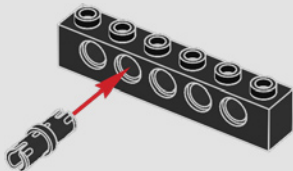

35

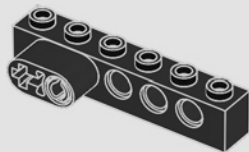

36

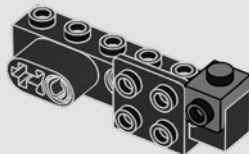



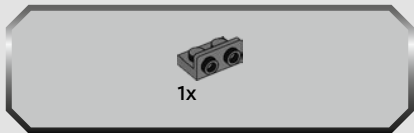

37

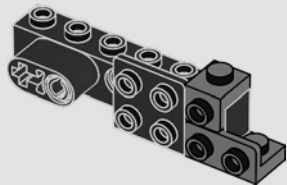

38

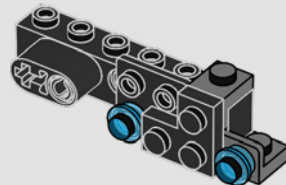

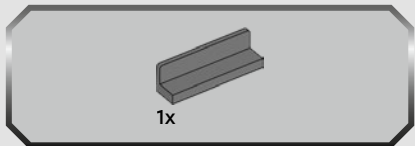

39

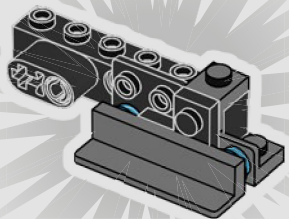

40

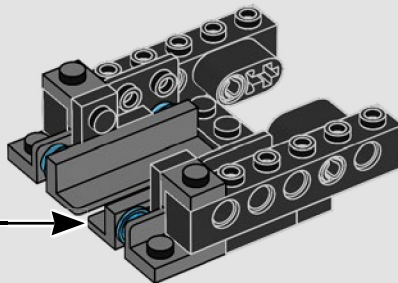

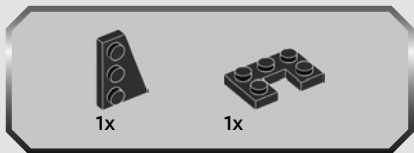

41

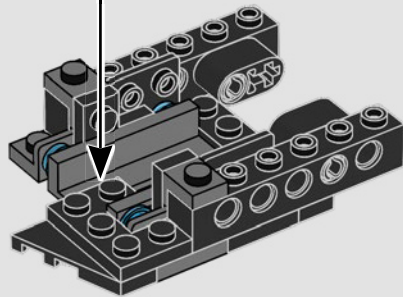
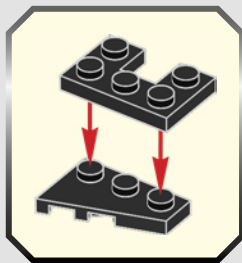

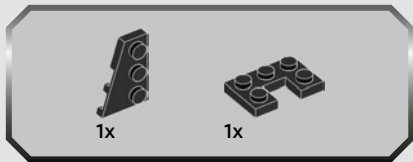

42

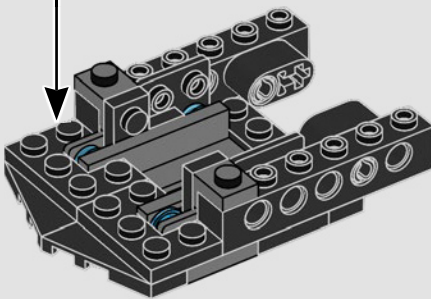
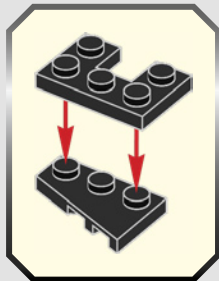



43

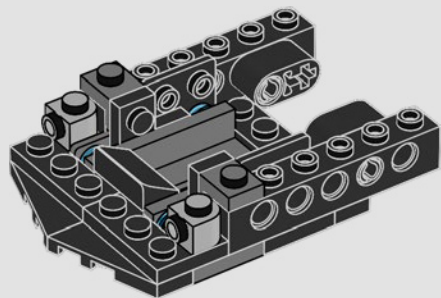

44

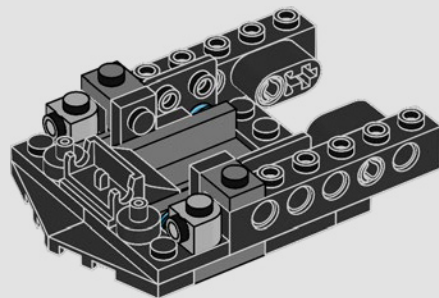



45

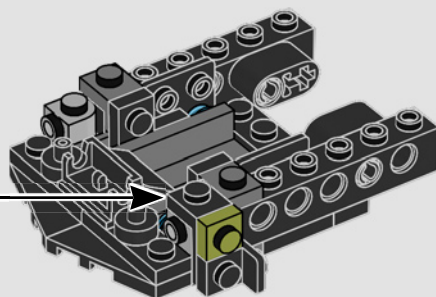
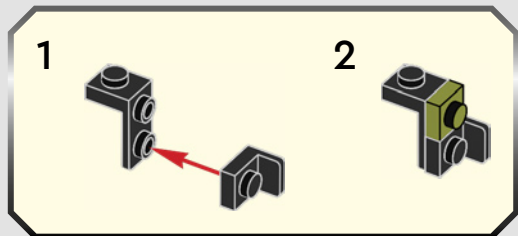



46

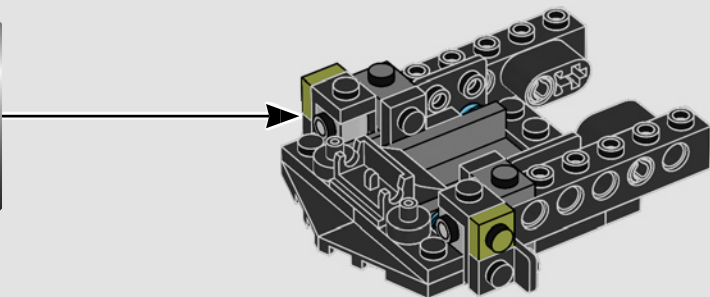
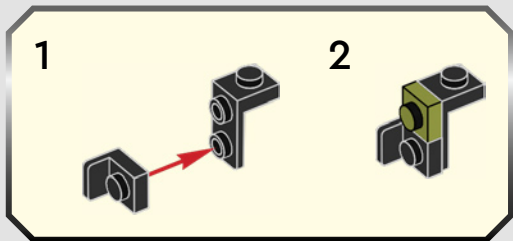



47

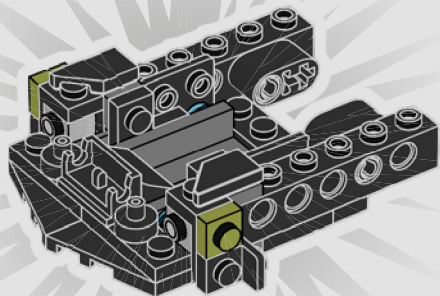

48

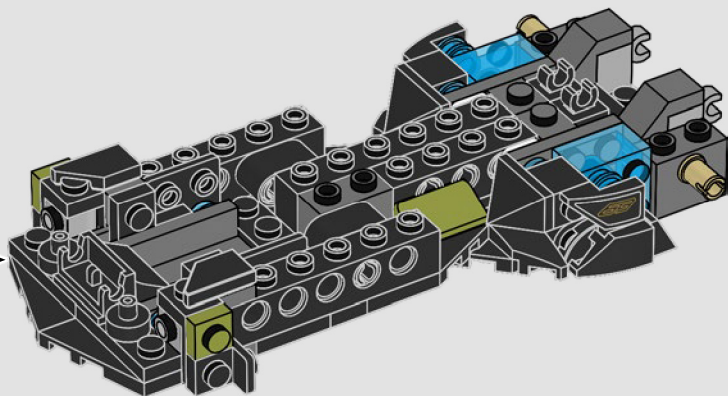



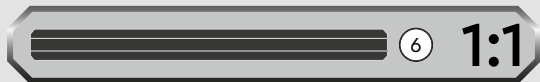
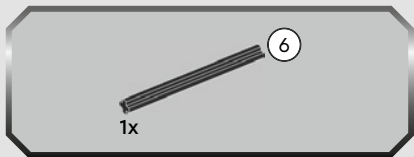

49

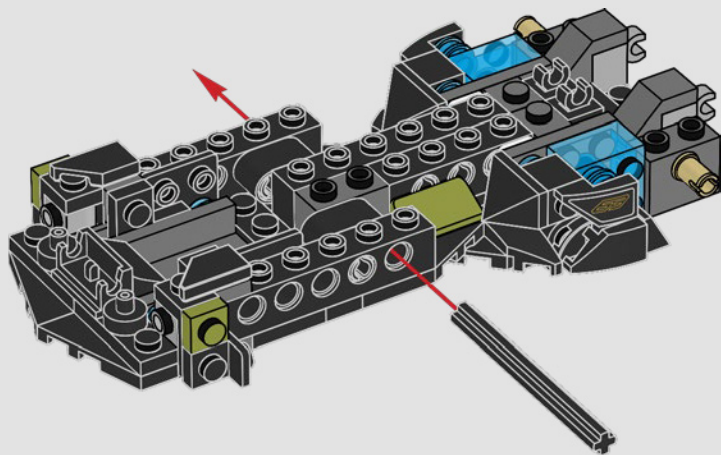

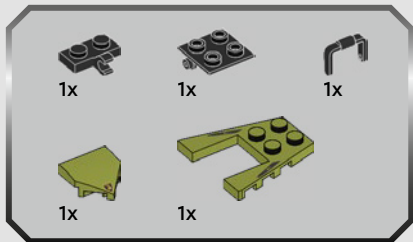

50

1

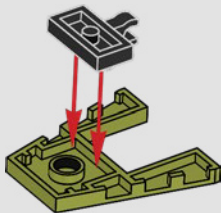

2

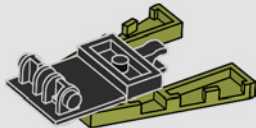

3

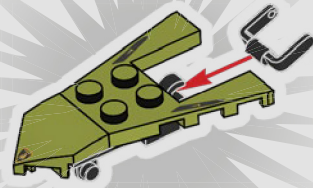

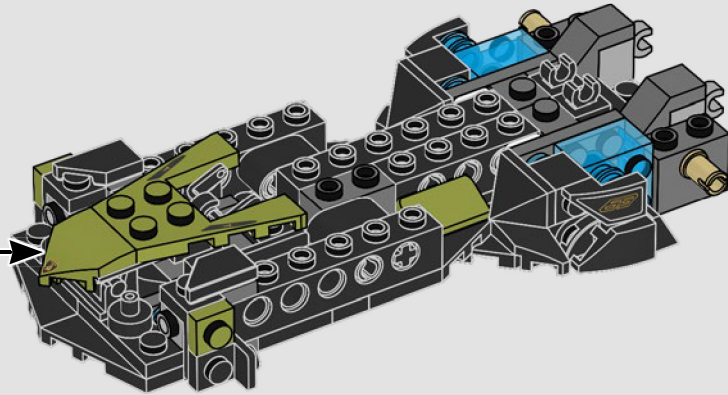

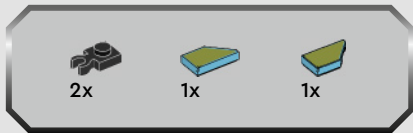

51

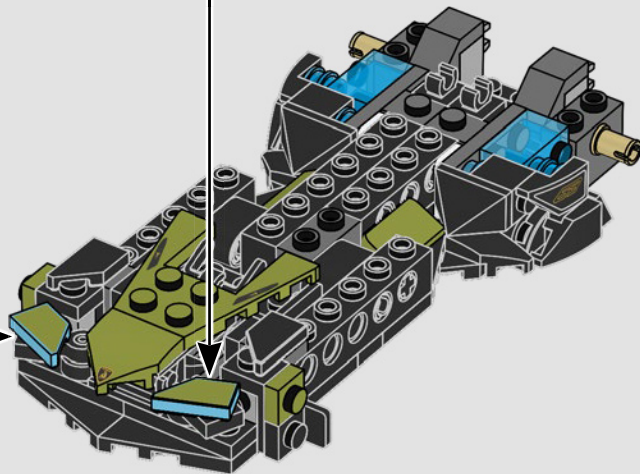

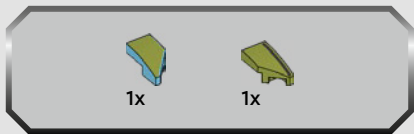

52

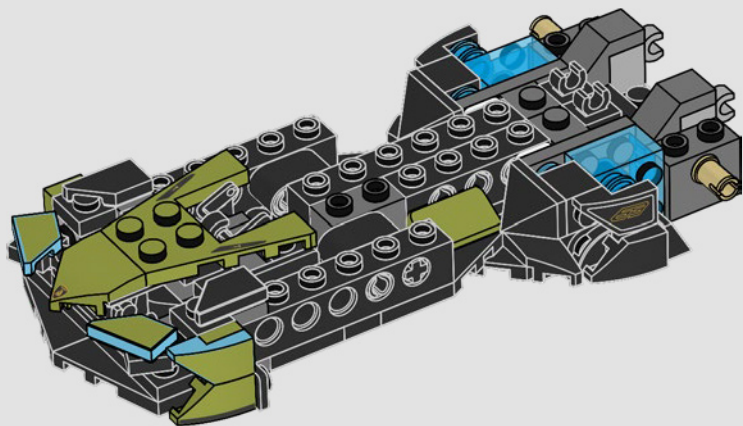



1x



1x

53

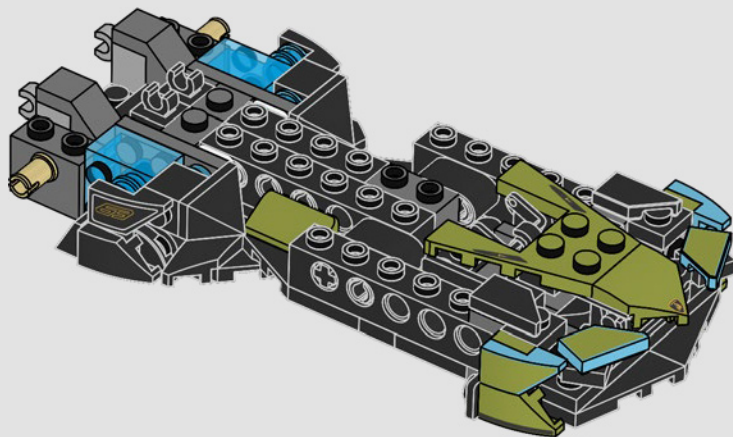



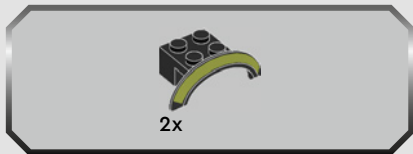

54

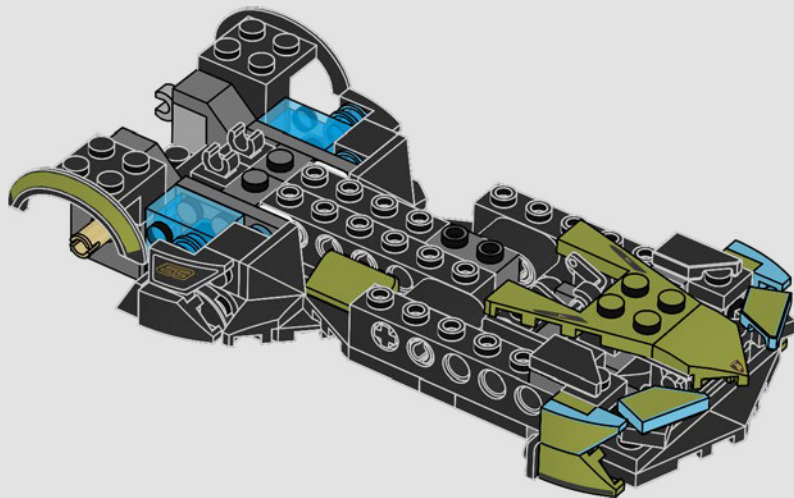





55

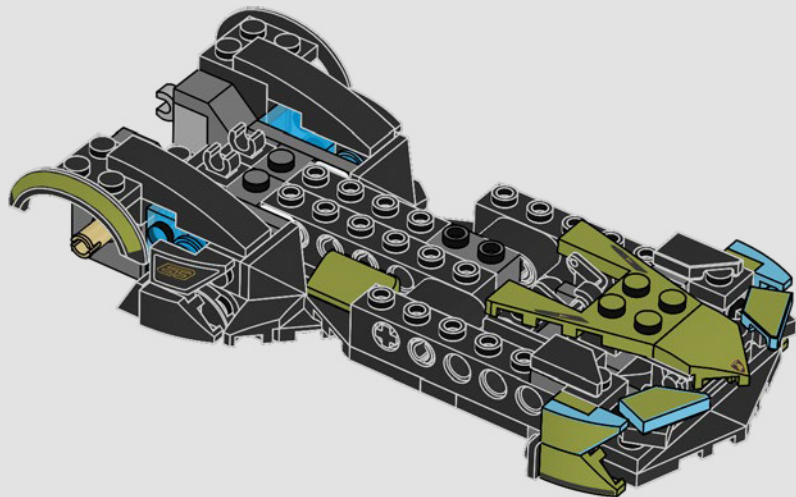

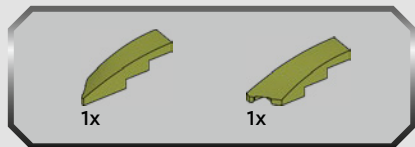

56

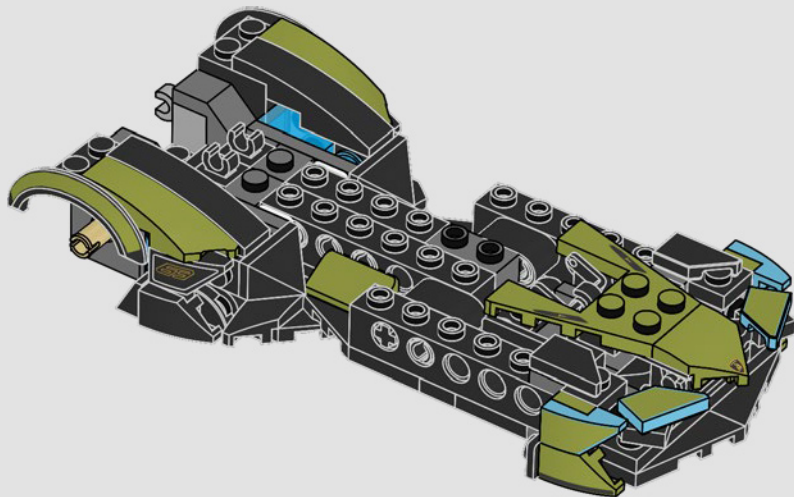

57

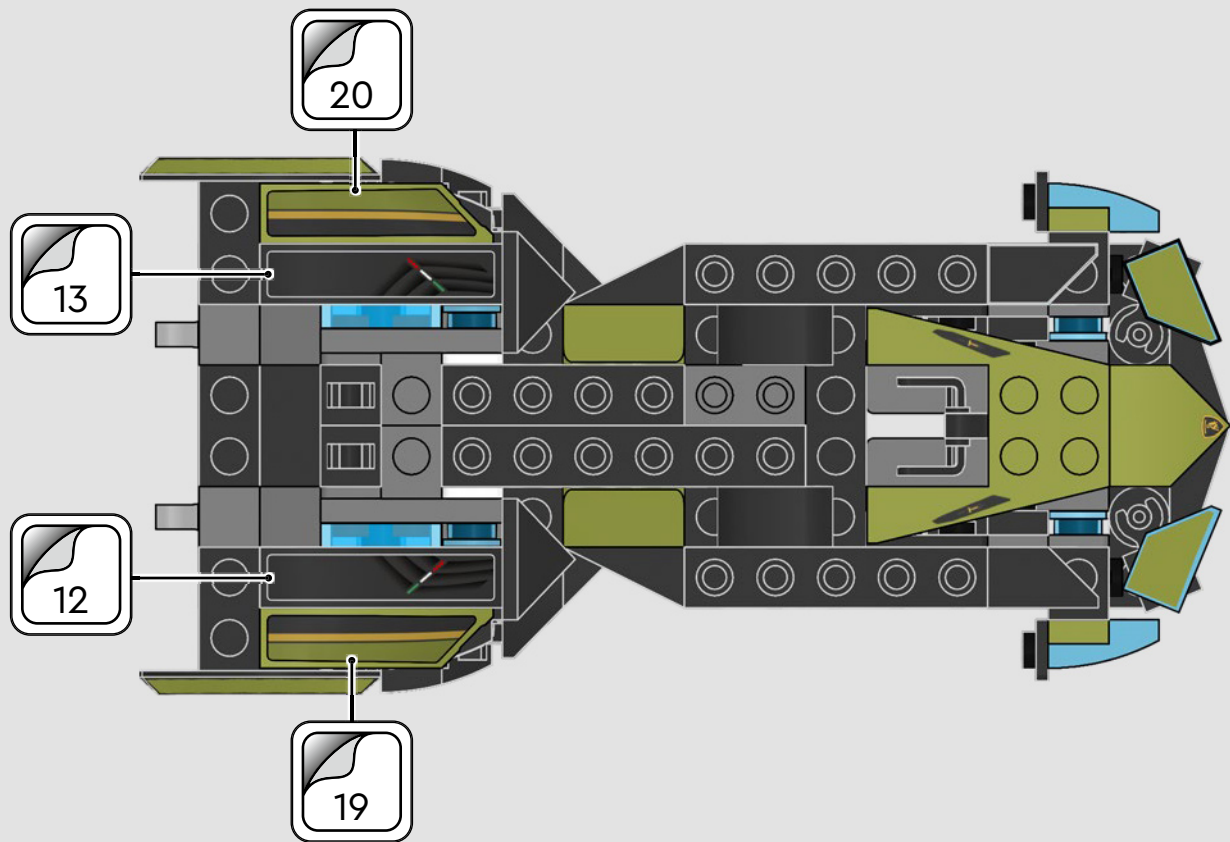

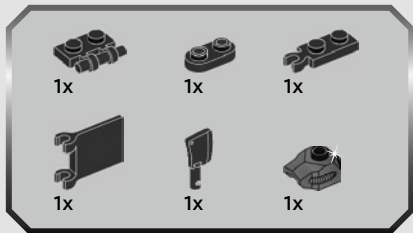

58

1

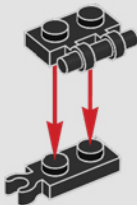

2

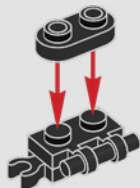

3



4

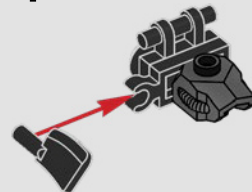

5



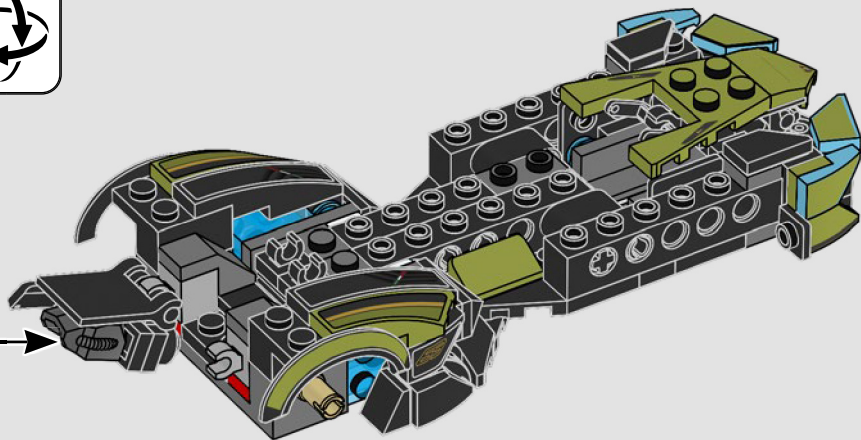

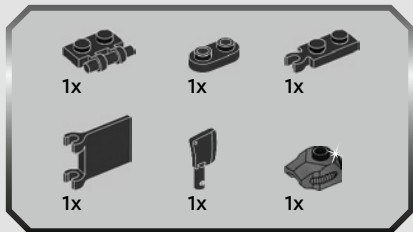

59

1

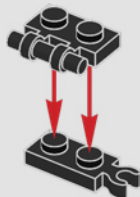

2

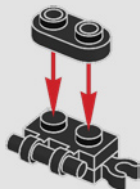

3



4

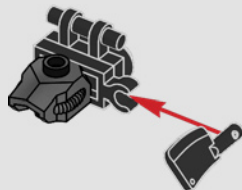

5



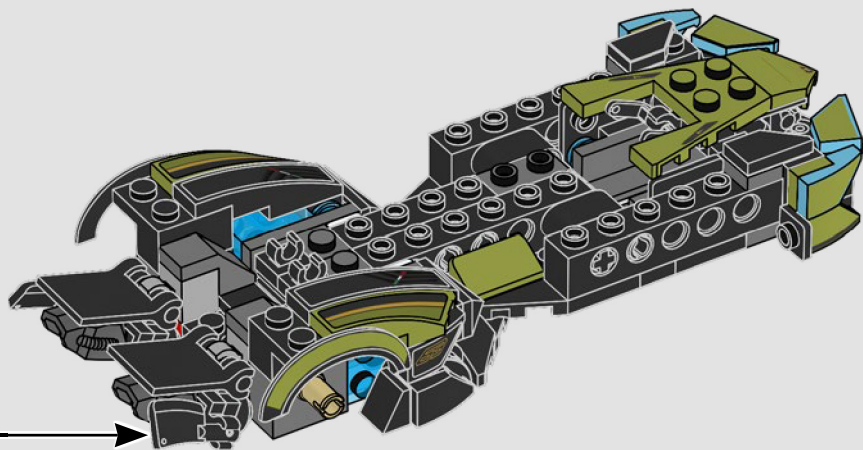

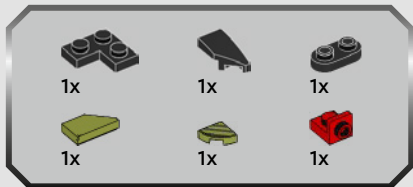

60

1

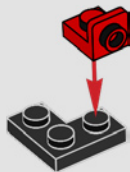

2



3

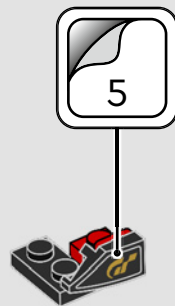



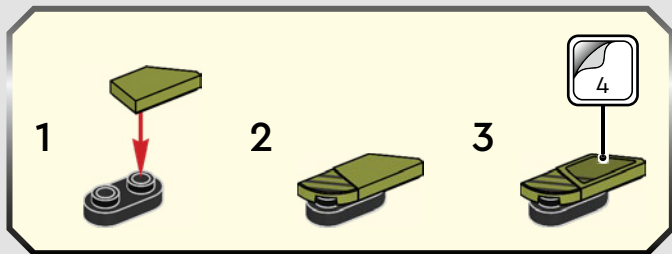

4

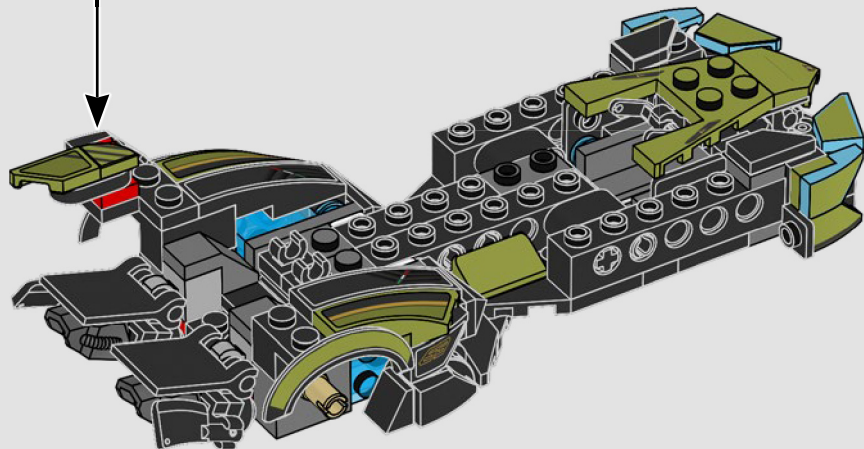
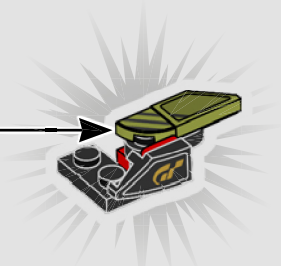

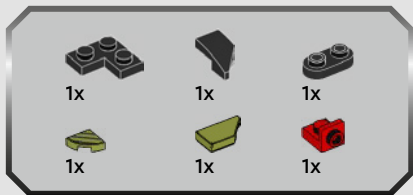

61

1

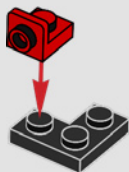

2



3



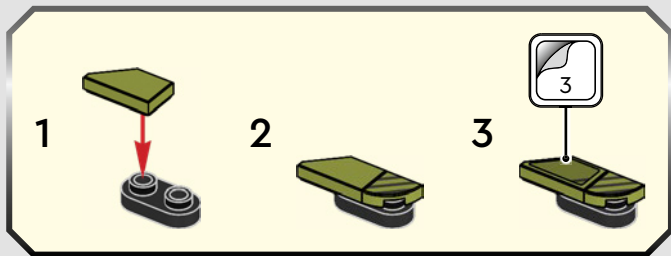

4

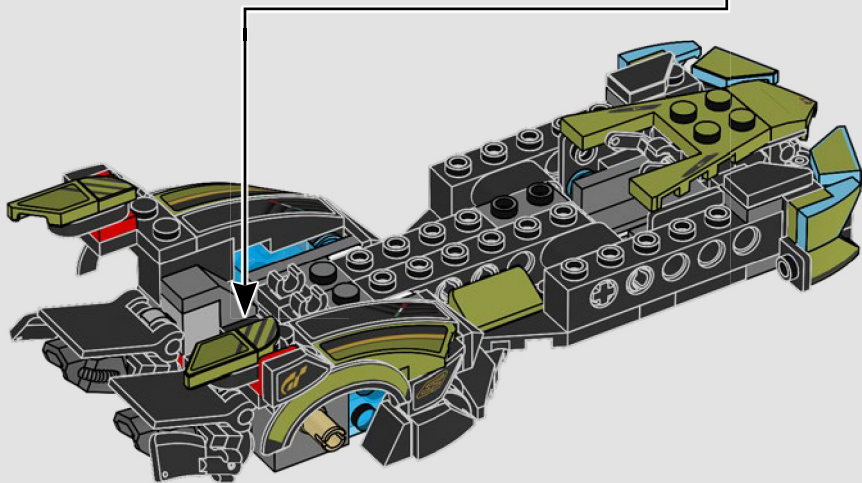
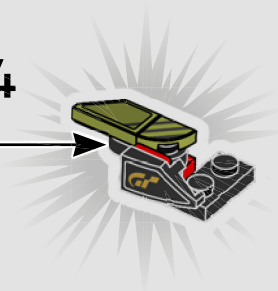



2x

62

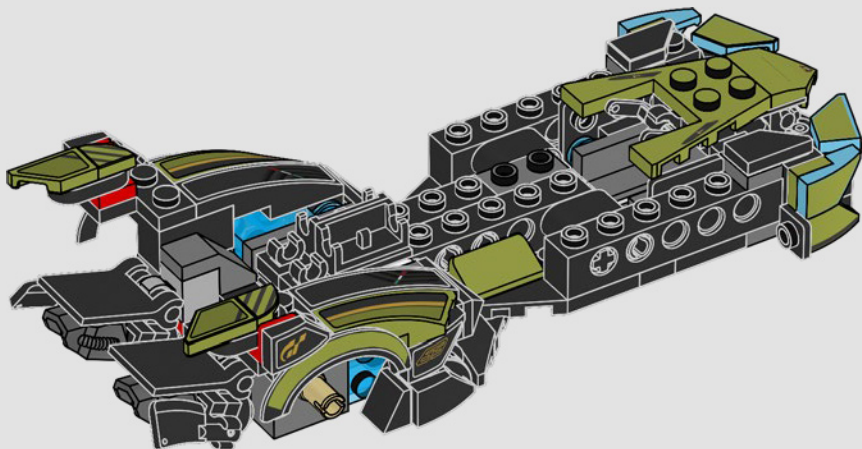

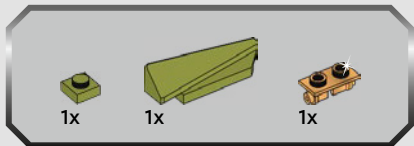

63

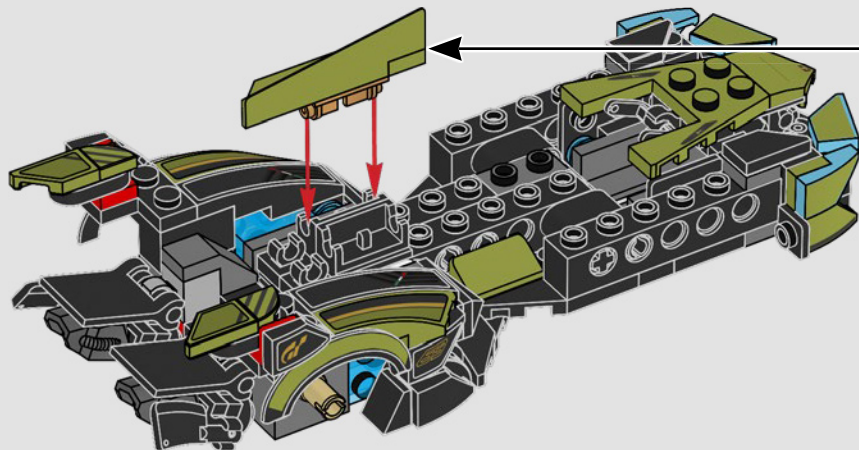
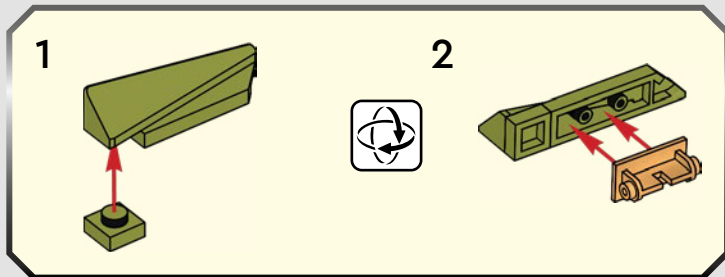

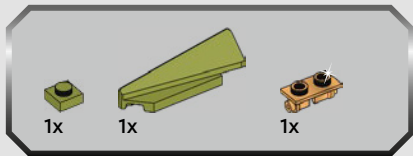

64

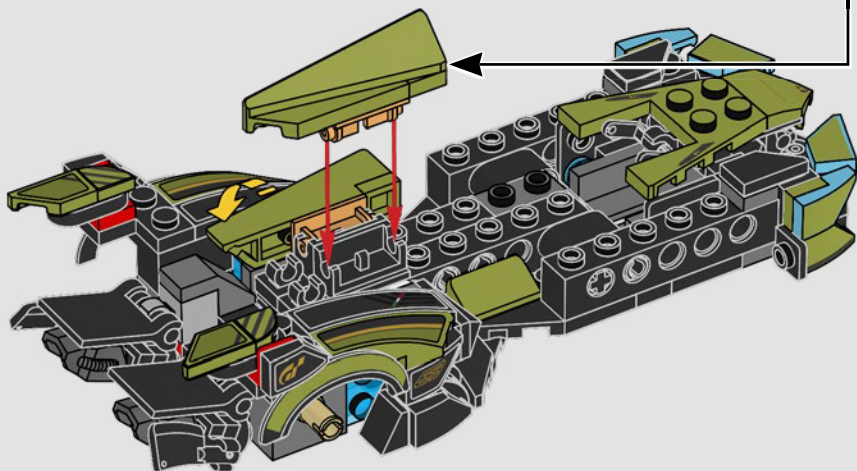
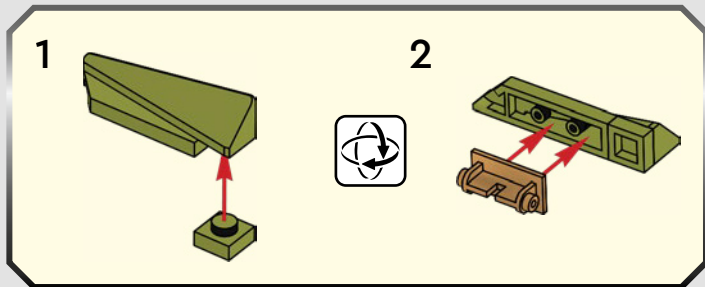



65

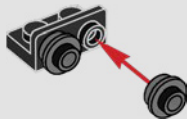

66

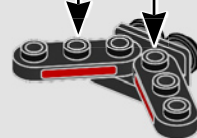
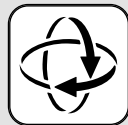
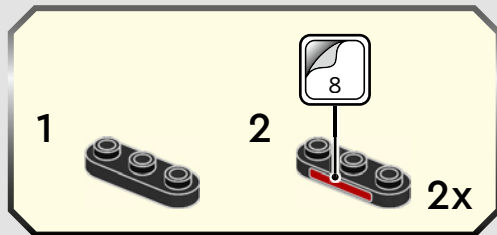

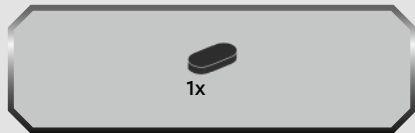

67



68





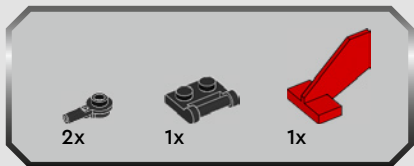

69

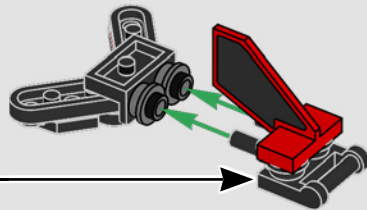
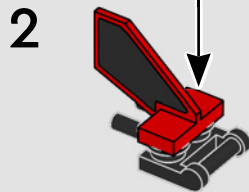
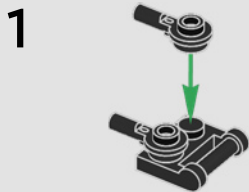
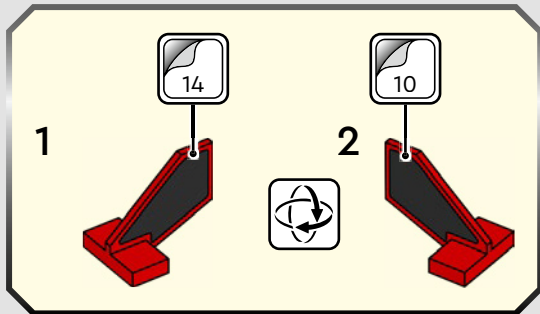

70

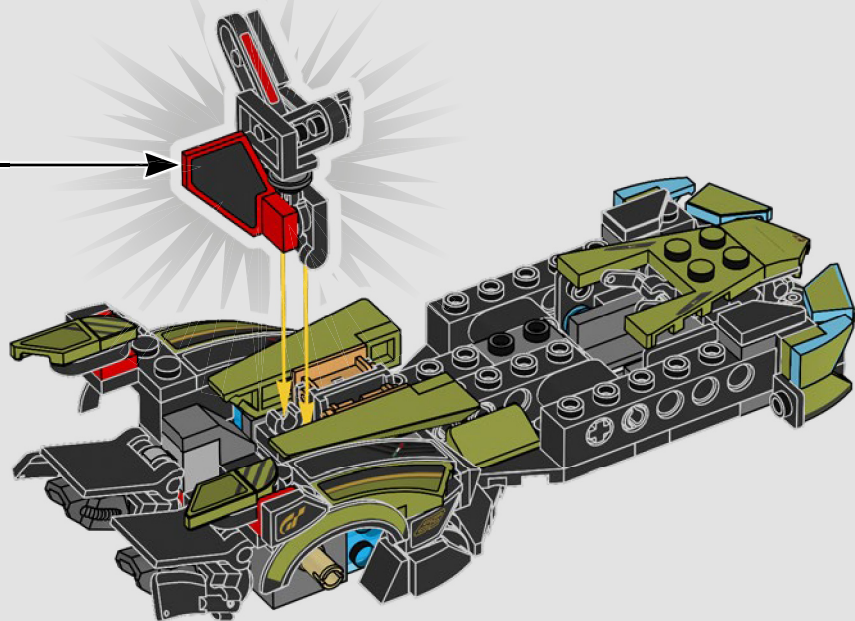

71

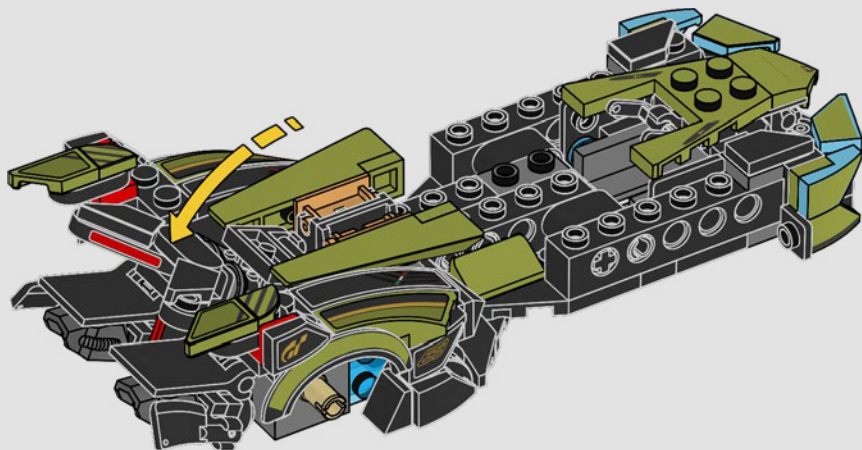

72

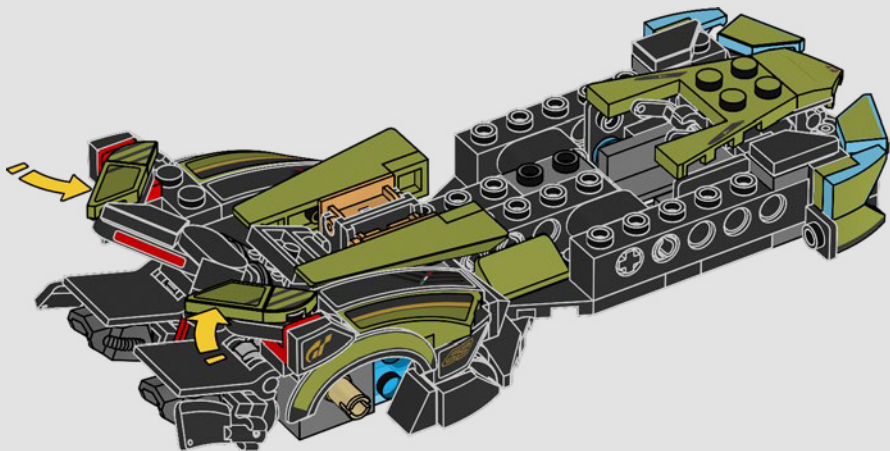



73

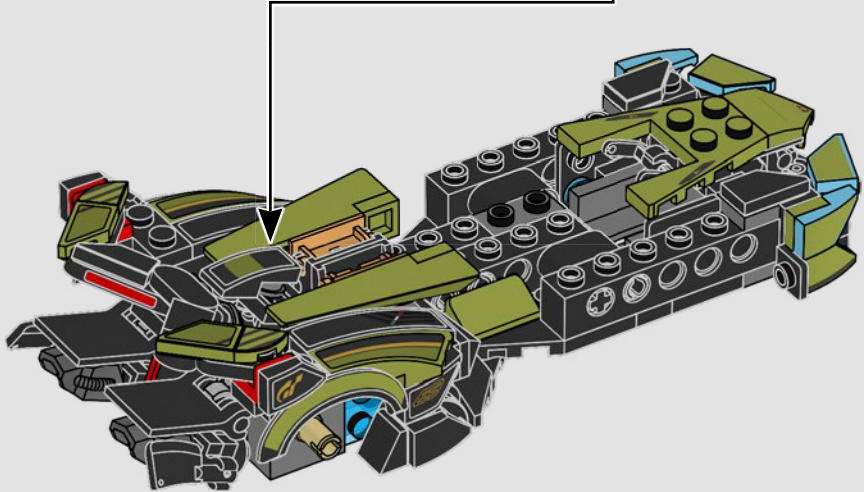
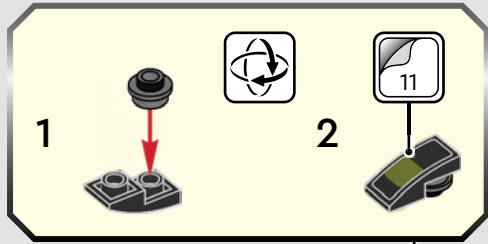



74

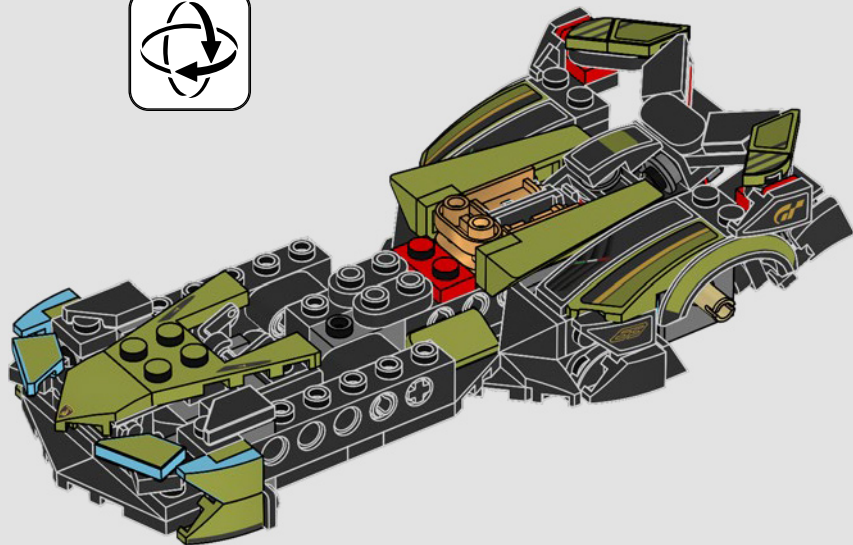

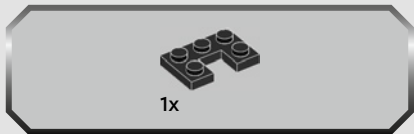

75

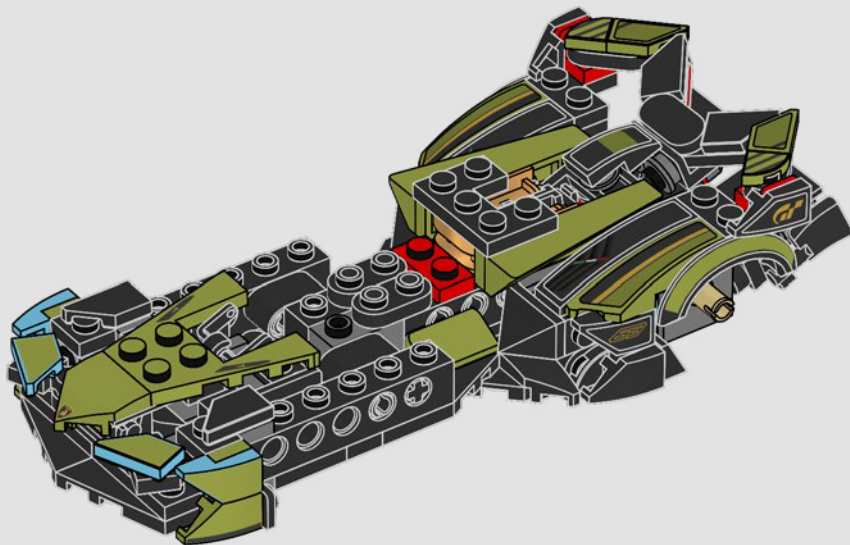



76

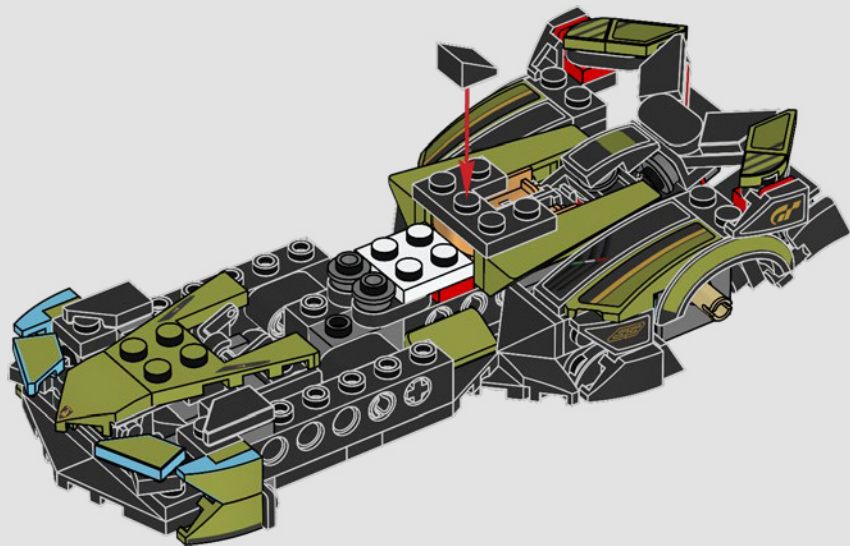



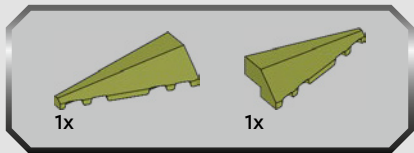

77

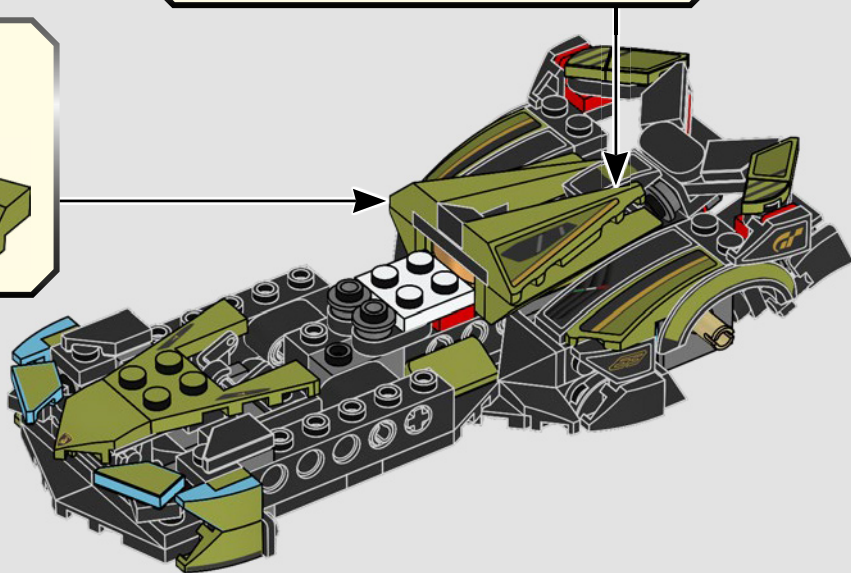
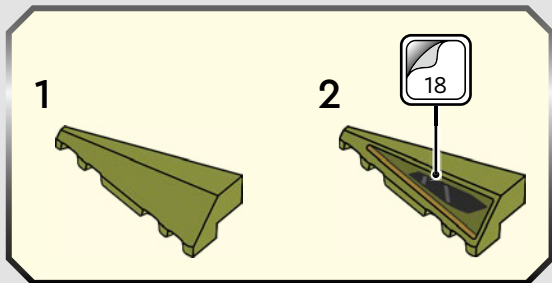
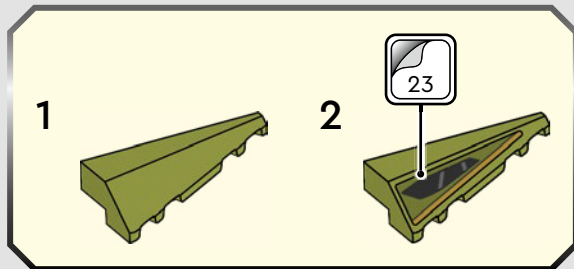

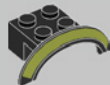

2x

78

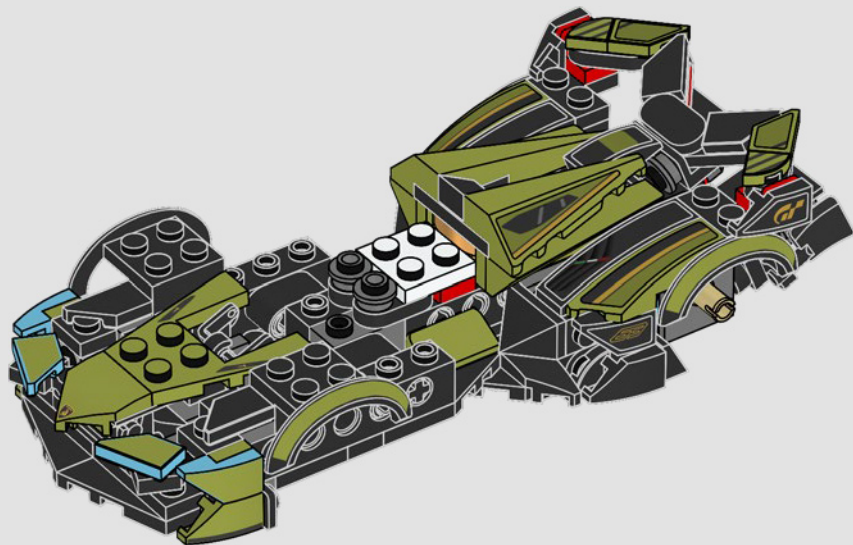

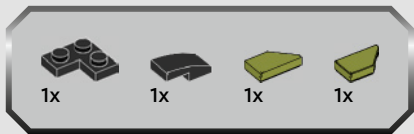

79

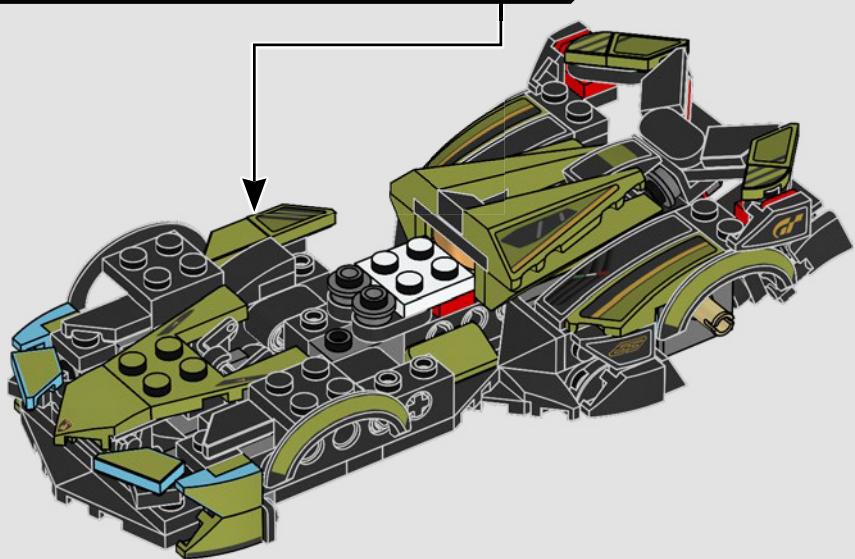
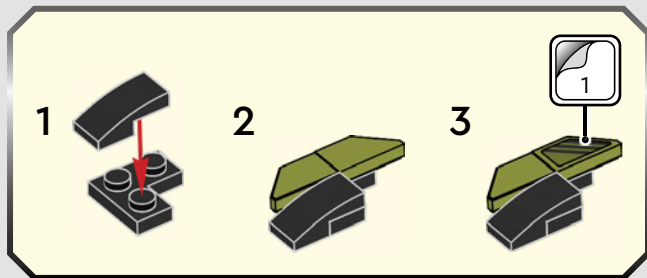



80

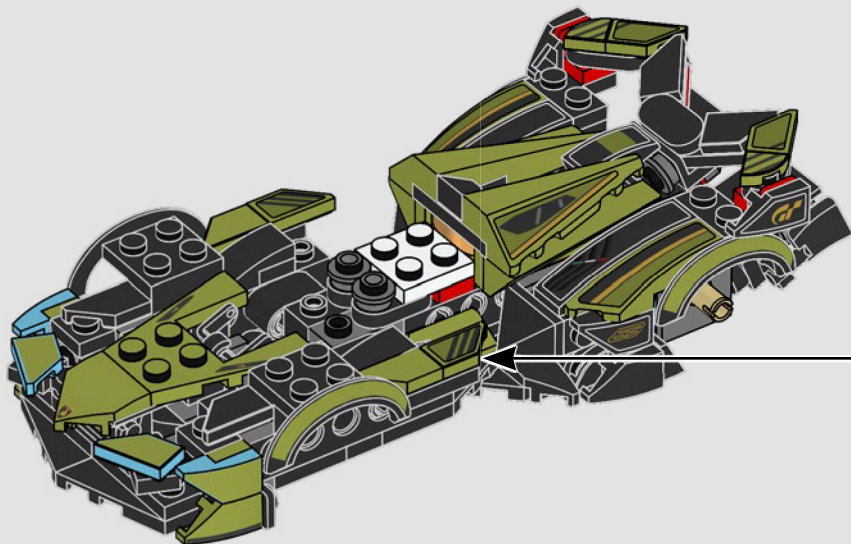
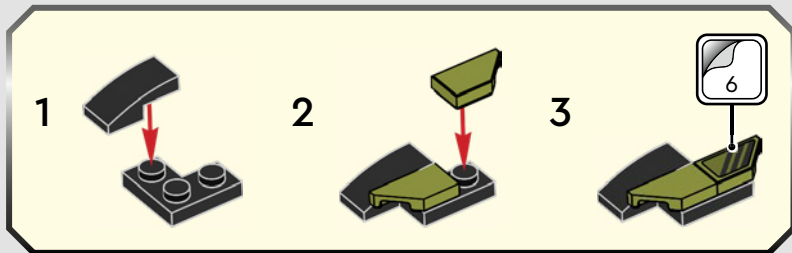

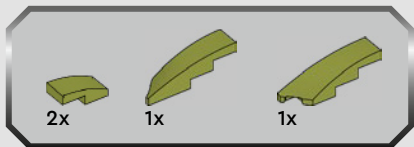

81

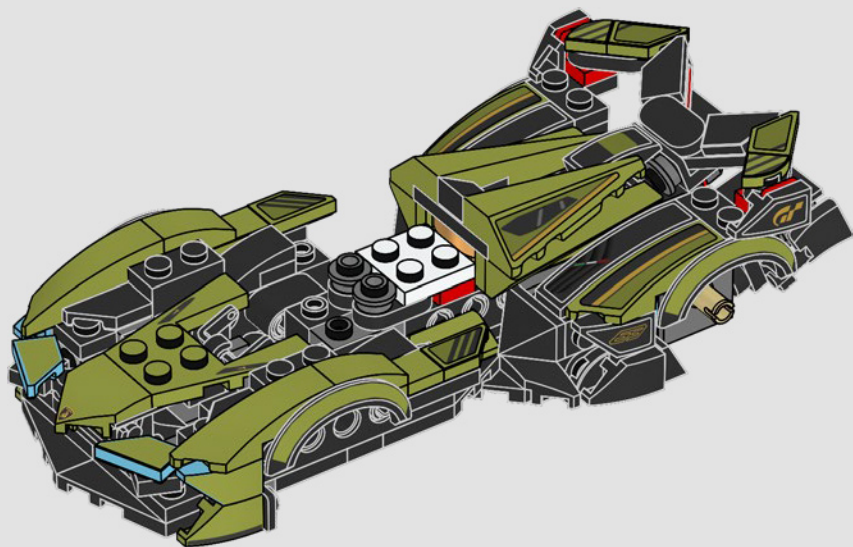

82

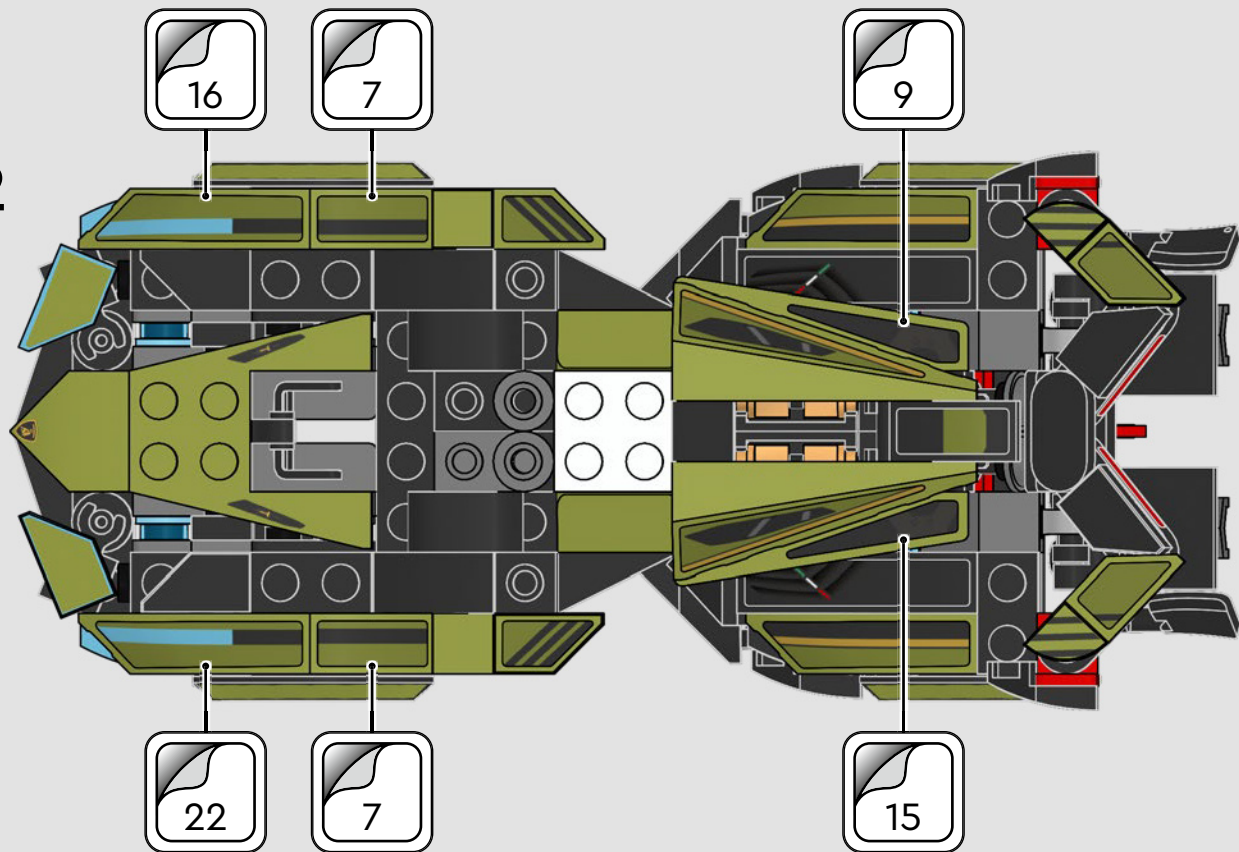



2x



1x

# 83

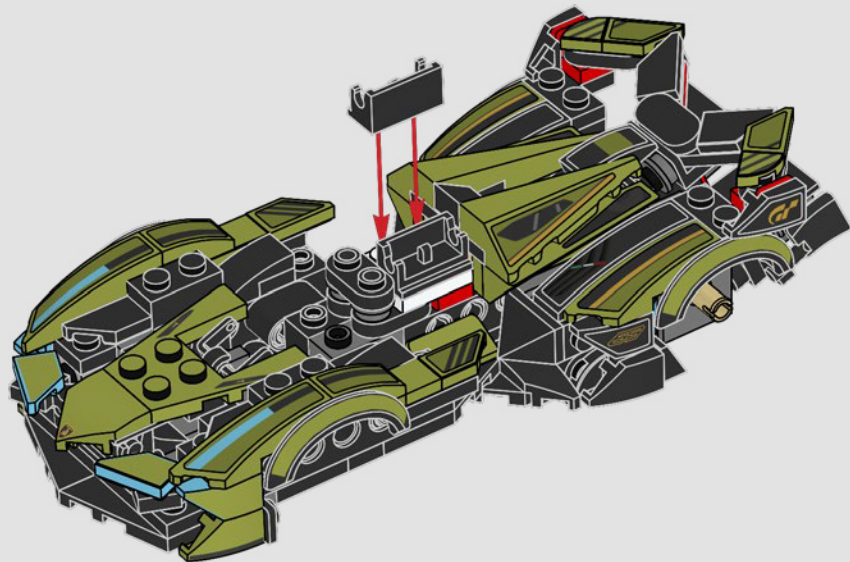



84

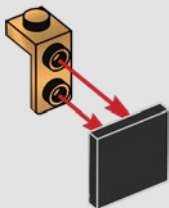

85

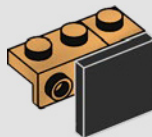





86

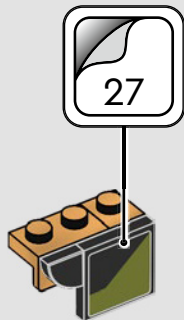

87

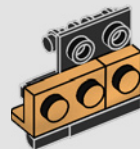



88



89



90

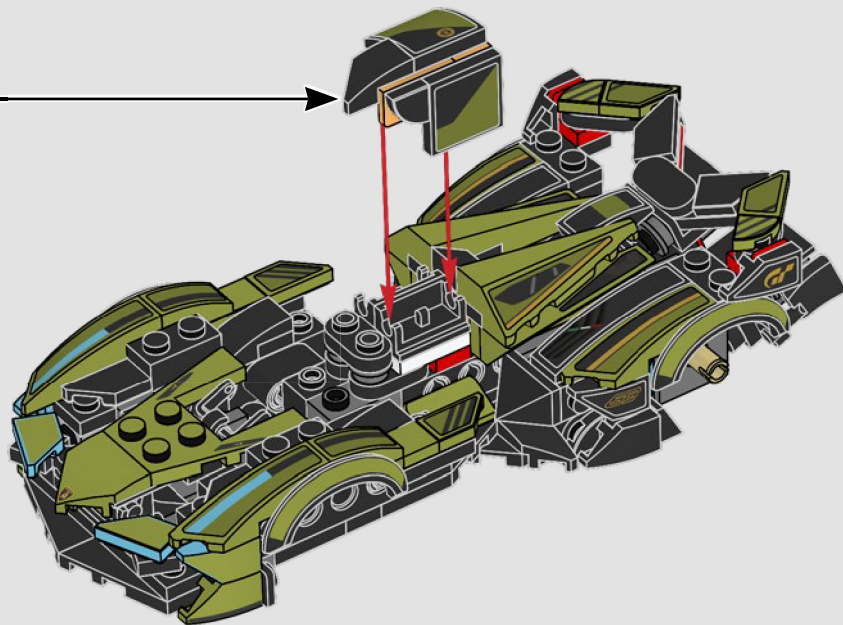



91

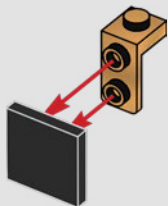

92

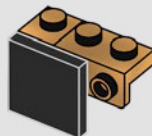

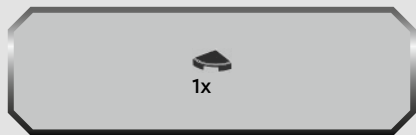

93



94

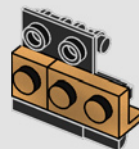
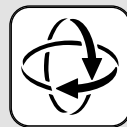



95



96



97

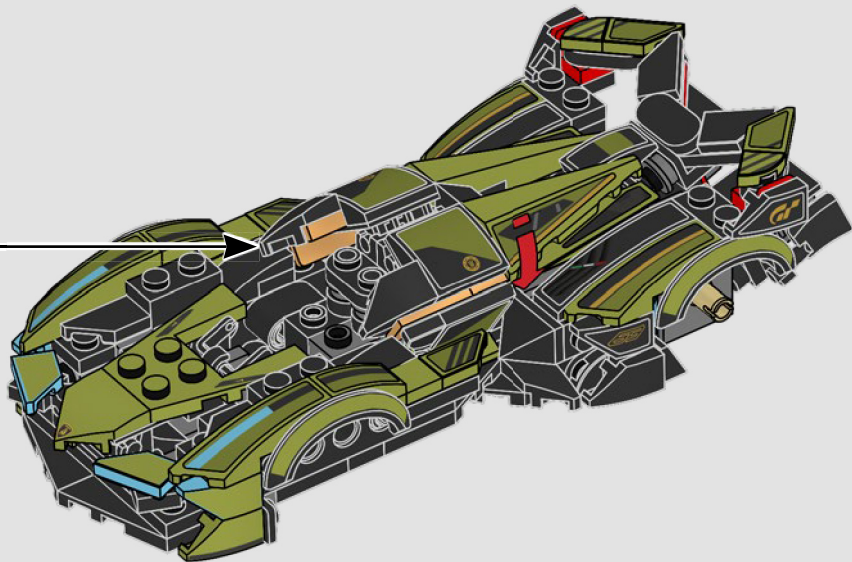



98

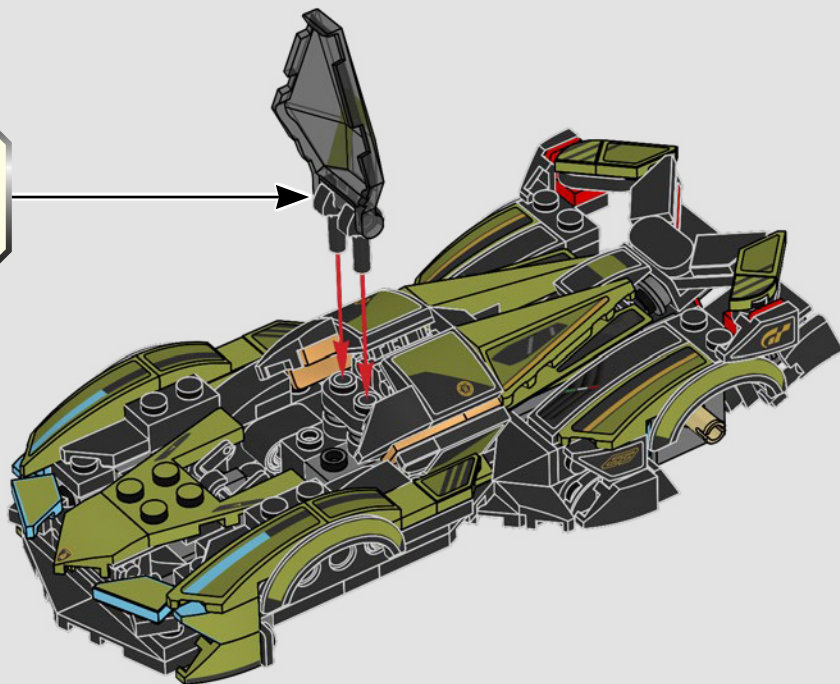
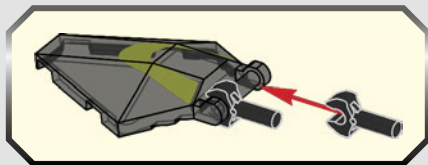





99

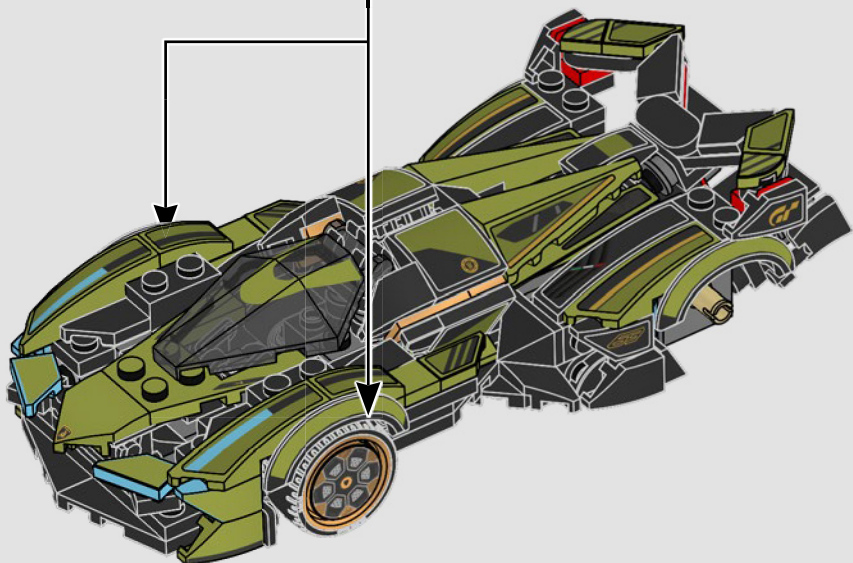
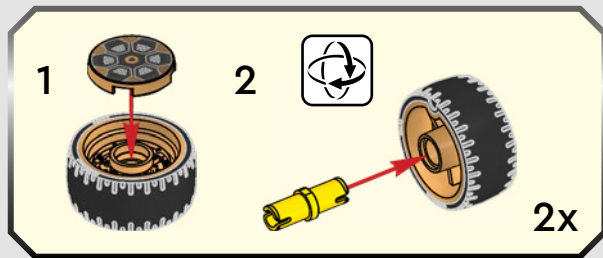



100

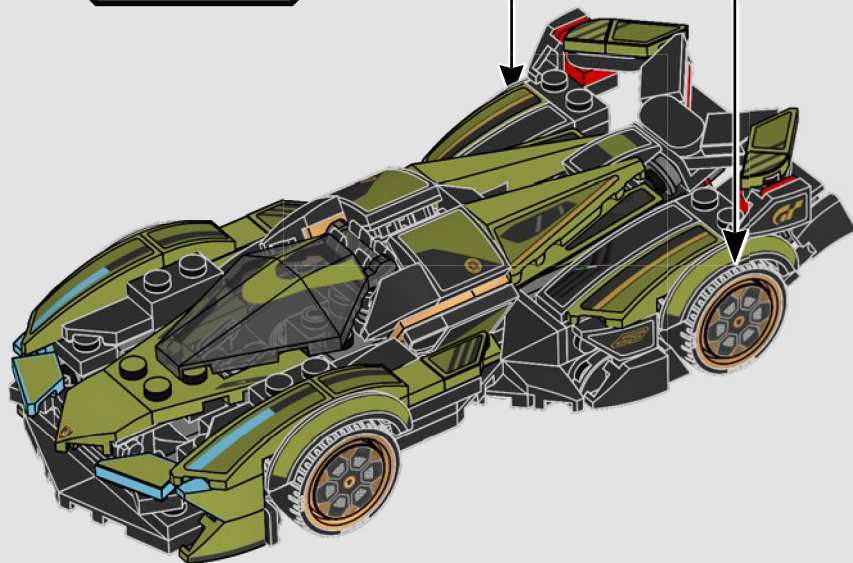

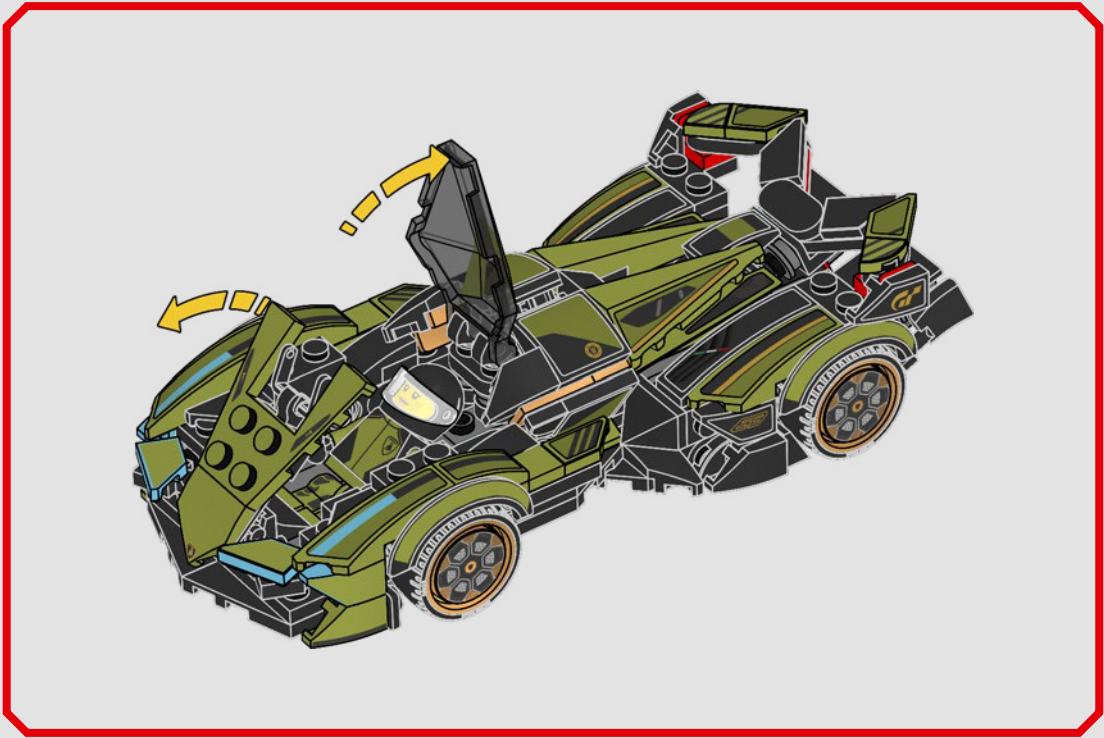

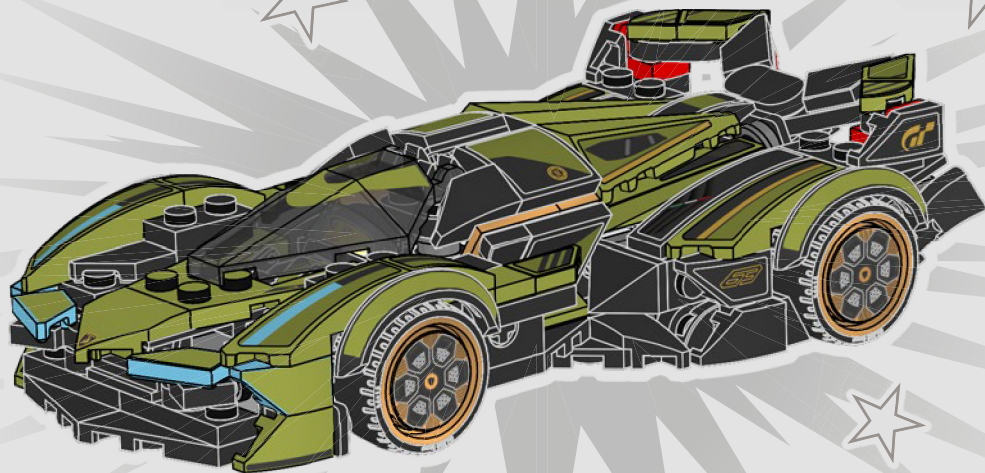



# SPEED CHAMPIONS

76923



76924

AMG



The "Lamborghini" and "Lamborghini Bull and Shield" trademarks, copyrights, designs and models are used under license from Automobili Lamborghini S.p.A, Italy.

//////AMG, „Mercedes-Benz" and "Three-pointed star in a ring" are the intellectual property of Mercedes-Benz Group AG. They are used by The LEGO Group under license.



2x  
6337079



1x  
302201



2x  
4666579



2x  
6249907



3x  
302321



1x  
6493693



1x  
6303499



2x  
6331822



2x  
6186675



2x  
6395769

86



2x  
6439039



2x  
6424674



5x  
6181720



4x  
6172383



3x  
4504382



2x  
4558954



2x  
6335388



2x  
6380236



2x  
6234695



1x  
6245281



2x  
6510139



1x  
4298619



1x  
6507792



9x  
6210270



2x  
6196548



5x  
6181713



1x  
4180508



1x  
4180536



2x  
6330189



1x  
4548180



2x  
6051508



5x  
6279875



2x  
6510125



2x  
6265091



5x  
393726



2x  
6047276



1x  
6313116



1x  
6147050



2x  
6000650



1x  
6020193



2x  
6363034



2x  
4140588



2x  
6428168



1x  
4225201



2x  
6350725



1x  
6325254



6x  
242026



3x  
4124096



2x  
6053077



2x  
306826



1x  
6507221



3x  
6493691



4x  
6504865



1x  
6254045



1x  
370126



1x  
370126



2x  
6037746



1x  
370626



3x  
389426



1x  
241926

6

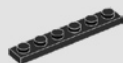

1x  
366626



1x  
379526

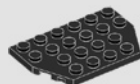

1x  
4129572



1x  
6244787



10x  
6240214



2x  
6171732



2x  
6238043



2x  
6448793



2x  
6320306



5x  
6231765



2x  
4211098



4x  
6413106



1x  
6178919



2x  
6168776



4x  
6000606



2x  
4211043



2x  
6092649



1x  
6454959



1x  
6288690



2x  
6493686



1x  
6370621



4x  
6472269



2x  
6493687



4x  
6503580



2x  
6495153



1x  
6167576



2x  
6168708



1x  
6504777



1x  
6510954



1x  
6472273



1x  
6510760



2x  
6504781



1x  
6472272



4x  
6058245



3x  
6493683



1x  
6504778



2x  
6016468



3x  
6493682



1x  
6472267



2x  
6031787



1x  
6472270



2x  
6493675



2x  
6493676



1x  
6493680



1x  
6493678



1x  
6493679



1x  
6504780



1x  
6493677



1x  
6504779



LEGO.com/service

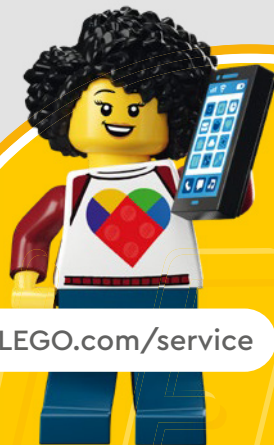

YOU COULD  
**WIN**

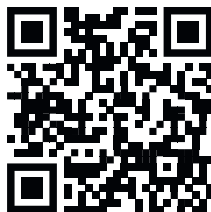

Scan this QR code or go to  
**LEGO.COM/PRODUCTFEEDBACK** and give us  
your short feedback about this LEGO® set for  
a chance to win a cool LEGO prize.

Terms and Conditions apply\*

**EN: YOU COULD WIN.** Terms and Conditions apply\* **DE: Du könntest GEWINNEN.** Es gelten die Teilnahmebedingungen\* **FR: Tu pourrais GAGNER.** Des conditions s'appliquent\* **IT: Potresti VINCERE tu.** Termini e condizioni sono applicabili\* **ES: Puedes GANAR.** Aplican términos y condiciones\* **PT: Poderá GANHAR.** Aplicam-se termos e condições\* **ZH: 轻松获奖. 条款和条件适用\*** **PL: Szansa na WYGRANĄ.** Obowiązują warunki korzystania\* **CS: Máte šanci VYHRÁT.** Platí všeobecné smluvní podmínky\* **SK: Máte šancu VYHRÁŤ.** Platia všeobecné zmluvné podmienky\* **HU: TE IS NYERHETSZ.** Felhasználási feltételek érvényesek\* **RO: Ai putea CÂȘTIGA.** Se aplică termenii și condiții\* **BG: Можете да СПЕЧЕЛИТЕ.** Има определени правила и условия\* **LV: Tu vari LAIMĒT.** Ir spēka noteikumi un nosacījumi.\* **ET: Sul on võimalus VÕITA.** Kehtivad tingimused\* **LT: Jūs galite LAIMĖTI.** Taikomos sąlygos\*

\*[LEGO.com/productfeedback/terms](https://www.lego.com/productfeedback/terms)

LEGO and the LEGO logo are trademarks of the/son des marques de commerce du/son marcas registradas de LEGO Group. ©2024 The LEGO Group.

The "Lamborghini" and "Lamborghini Bull and Shield" trademarks, copyrights, designs and models are used under license from Automobili Lamborghini S.p.A, Italy.

Vision GT logo is a registered trademark or trademark of Sony Interactive Entertainment Inc.

6522907