



76271

BATMAN

1



Booklet available in English on
Livret disponible en français sur
Folleto disponible en español en



WE'RE MAKING OUR PACKAGING MORE SUSTAINABLE

We're transitioning from single-use plastic to paper-based packaging. As we progress, you may find a mix of paper and plastic in our boxes.

NOUS RENDONS NOS EMBALLAGES PLUS DURABLES

Nous passons des emballages en plastique à usage unique aux emballages à base de papier. Durant la transition, vous pourriez trouver un mélange de papier et de plastique dans nos boîtes.

QUEREMOS HACER MÁS SUSTENTABLES NUESTROS MATERIALES DE EMBALAJE

Estamos cambiando las bolsas de plástico desechables por bolsas con base de papel. Conforme avanzamos en este propósito, puedes encontrar una mezcla de papel y de plástico en nuestras cajas.

LEGO.com/sustainable-packaging



BUILDER



Apple and the Apple logo are trademarks of Apple Inc., registered in the U.S. and other countries and regions. App Store is a service mark of Apple Inc. Google Play and the Google Play logo are trademarks of Google LLC. Tencent and the Tencent logo are trademarks of Tencent Inc.

LEGO.com/devicecheck



LEGO® Builder

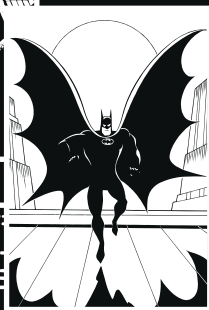
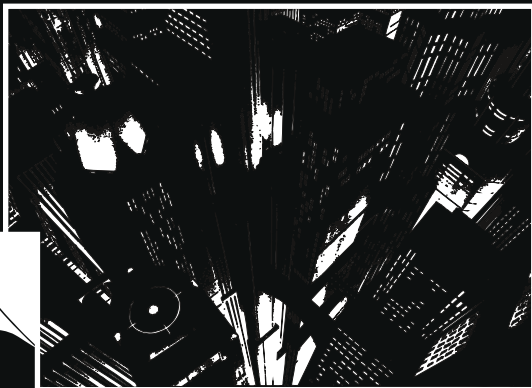

“GOOD PEOPLE
STILL LIVE IN
CRIME ALLEY.”

– BATMAN™

● *Batman: The Animated Series* (1992–1995) became an instant hit when it first aired and is still loved by critics and fans of all ages for its award-winning writing, animation and original soundtrack. Inspired by the original DC Batman™ comic book storylines, BTAS

offered fans elaborate backstories of every villain in the Caped Crusader™ Rogues Gallery. The show featured popular voice actors, guest stars, dramatic haunting music, iconic character design and the inspirational 'Dark Deco' art style. The depth of the show's impact on pop culture cannot be overstated – it can still be seen to this day.

« DES GENS MERVEILLEUX
CONTINUERONT À Y VIVRE
POUR TOUJOURS. »

– BATMAN™

● *Batman : La série animée* (1992–1995) connaît un succès immédiat lors de sa première diffusion et est toujours appréciée tant par les critiques que par les amateurs de tous âges pour ses scénarios, son animation et sa bande-son originale primés. Inspirée par les histoires originales des bandes dessinées Batman™ de DC, elle offre aux amateurs des histoires complexes sur tous les ennemis du justicier masqué. La série présente des doubleurs populaires, des vedettes invitées, une musique dramatique captivante, une conception de personnages emblématique et le fameux style artistique « Dark Deco ». L'énorme impact de la série sur la culture populaire est encore perceptible aujourd'hui.

BATMAN

“BUENAS PERSONAS
AÚN VIVEN EN LOS
CALLEJONES DEL CRIMEN”.

– BATMAN™



● *Batman: La Serie Animada* (BLSA) (1992–1995) se convirtió en un éxito instantáneo cuando se emitió por primera vez y sigue siendo amada por críticos y fans de todas las edades por su impecable guion, su cuidada animación y su imponente banda sonora, elementos que le han valido múltiples galardones. Inspirada en las historias originales de los cómics de Batman™ de DC, BLSA ofrecía a los fans profundas narrativas del origen de cada integrante de la galería de villanos del Cruzado de la Capa. La serie contaba con populares actores de doblaje, estrellas invitadas, música dramática e inquietante, un diseño de personajes icónico y el inspirador estilo artístico “dark deco”. La repercusión de la serie en la cultura popular es indudable, y aún hoy puede apreciarse.



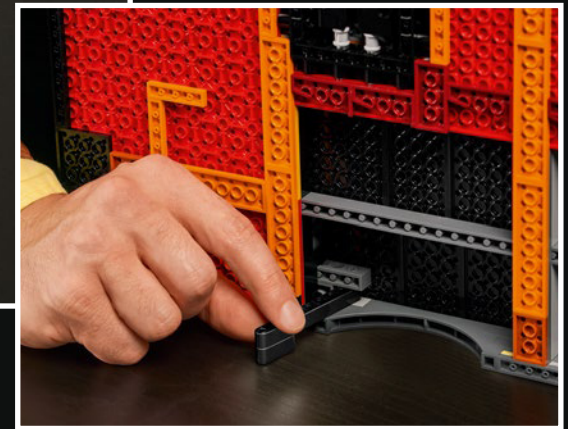

BUILDING THE LEGO® GOTHAM CITY™ SKYLINE

● Inspired by the 85 original episodes of *Batman: The Animated Series*, the LEGO® *Batman: The Animated Series* Gotham City™ skyline recreates the dynamic colors, iconic buildings, characters and events from the show. Every detail, vehicle, structure and decoration has been taken from a

specific scene, episode or moment between the show's heroes and villains. Just like in the show, the 'Dark Deco' city hides a vast underworld where dastardly dealings and cunning coups unfold in the shadows. The display itself is designed to be a nostalgic and fun building

experience packed with hidden references and details. Team up with your favorite sidekick or fellow BTAS fan for a two-person building experience. Unless, like Batman™ sometimes prefers, you want to be a solitary hero.

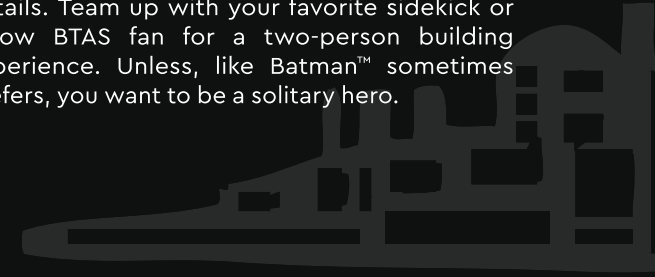

CONSTRUIRE LA SILHOUETTE DE LEGO® GOTHAM CITY™

● Basée sur les 85 épisodes originaux de *Batman : La série animée*, la silhouette de Gotham City™ de *Batman : La série animée* recrée les couleurs dynamiques, les bâtiments emblématiques, les personnages et les événements de la série. Chaque détail, véhicule,

structure et décoration est tiré d'une scène, d'un épisode ou d'un moment précis entre les héros et les méchants de la série. Comme dans la série, la ville « Dark Deco » cache un vaste monde souterrain où se déroulent, dans l'ombre, d'ignobles transactions et opérations. La pièce d'exposition elle-même est conçue comme une expérience de construction nostalgique et amusante, truffée de références et de détails cachés. Faites équipe avec votre acolyte préféré ou un autre amateur de la série animée pour partager l'expérience de construction. À moins que, comme Batman™ le préfère parfois, vous ne souhaitiez être un héros solitaire.

CONSTRUYE EL HORIZONTE DE GOTHAM CITY™ AL ESTILO LEGO®

● Inspirado en los 85 episodios originales de *Batman: La Serie Animada*, el set LEGO® Gotham City™ de *Batman: La Serie Animada* recrea los colores dinámicos, los edificios icónicos, los personajes y los acontecimientos de la serie. Cada detalle, vehículo, estructura y decoración se ha tomado de

una escena, episodio o momento específico entre los héroes y villanos. Al igual que en la serie, la ciudad al estilo "dark deco" esconde un vasto submundo en el que se desarrollan negocios ruines y astutos golpes de estado bajo las sombras. Esta pieza de exhibición está diseñada para ofrecer una

experiencia de construcción nostálgica y divertida, repleta de referencias y detalles ocultos. Haz equipo con tu cómplice favorito o con otro fan de BLSA para disfrutar de una experiencia de construcción para dos personas. A menos que, como a veces prefiere Batman™, quieras ser un héroe solitario.



FROM THE DESIGN TEAM

● "'Dark Deco' art style was the inspiration behind the idea. The emotional sophistication and dramatic visual simplicity was a fun challenge to emulate with bricks. To convey the style, only 15 colors are used, except where characters have left their mark."

- Joel Baker, LEGO® DC Batman™ Senior Designer

UN MOT DE L'ÉQUIPE DE CONCEPTION

● « Le style artistique 'Dark Deco' est à l'origine du projet. La sophistication émotionnelle et la simplicité visuelle spectaculaire ont été amusantes à transposer en briques. Pour refléter le style, seulement 15 couleurs sont utilisées, sauf aux endroits où les personnages ont laissé leur trace. »

- Joel Baker, concepteur principal LEGO® DC Batman™

IMPRESIONES DEL EQUIPO DE DISEÑO

● "El estilo artístico 'dark deco' fue la fuente de inspiración. Supuso todo un desafío emular con bricks su profunda sofisticación emocional y la dramática simplicidad visual que lo caracteriza. Para transmitir la esencia de esta corriente, solo se utilizan 15 colores, excepto donde los personajes han dejado su huella".

- Joel Baker, diseñador sénior de LEGO® DC Batman™



The crowded cells of Arkham Asylum™
 Les cellules bondées de l'asile d'Arkham
 Las atestadas celdas del Asilo Arkham

Batignal™
 Le bat-signal™
 Batiseñal

BATMAN

Wayne Enterprises™
 Empresas Díaz

GCPD Blimps
 Les dirigeables de la police
 Dirigibles del DPGC

Batwing™
 Le Batwing™
 Batiplano

Arkham Asylum™
 L'asile d'Arkham
 Asilo Arkham



GOTHAM CITY™ Greenhouse
 La serre de GOTHAM CITY™
 Invernadero de GOTHAM CITY™



The Penguin™ Duck Boat
 Le bateau canard du Pingouin
 Barco con forma de pato del Pingüino

The Joker™ Amusement Area
 L'aire de jeu du Joker™
 Área de entretenimiento del Guasón



GOTHAM CITY™ Police Department
 La police de GOTHAM CITY™
 Departamento de Policía de GOTHAM CITY™



Wayne Manor
 Le Manoir Wayne
 Mansión Díaz



Batmobile™
 La Batmobile™
 Batimóvil



ACE Chemicals™



Batman™: Title sequence moment
 Batman™: Moment du générique d'ouverture
 Momento de la secuencia del título de Batman™

Batcave™
 La Batcave™
 Baticueva



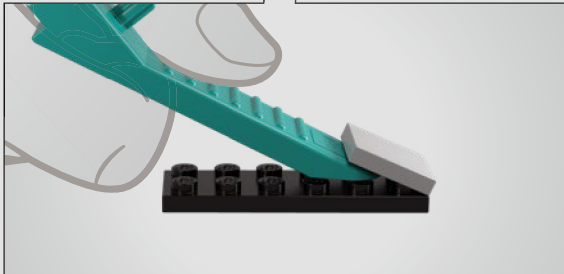
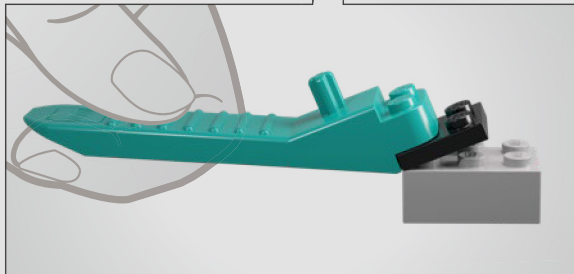
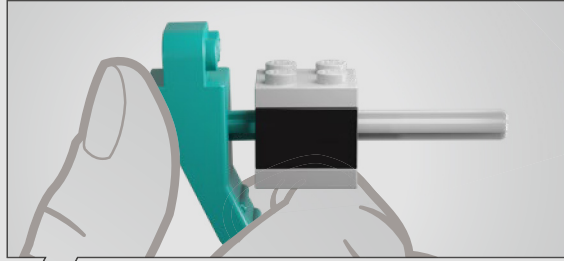
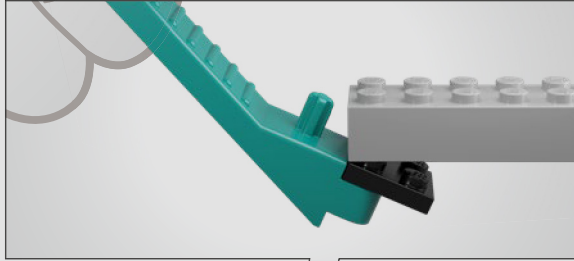

Episode: *The Strange Secret of Bruce Wayne*
Épisode : *L'étrange machine du Docteur Strange*
Episodio: *El extraño secreto de Bruno Díaz*



1

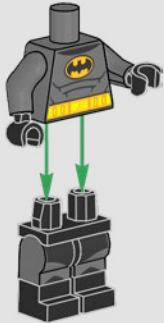

2



3

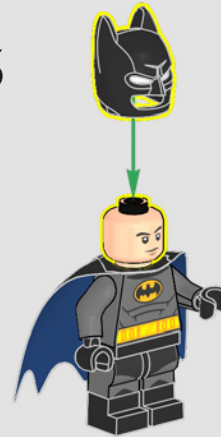

4



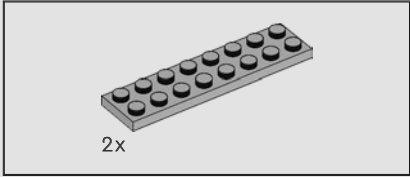
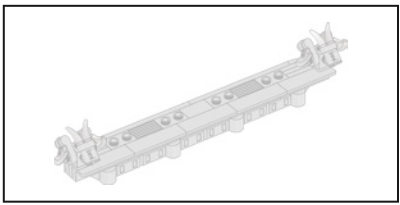

2x

1

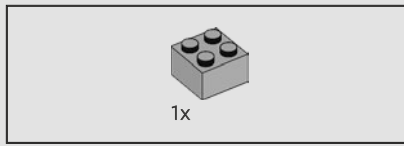
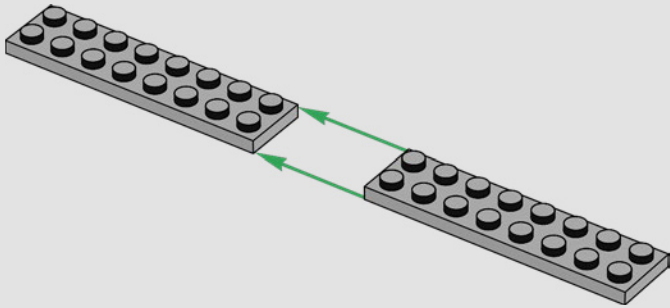

1x

2

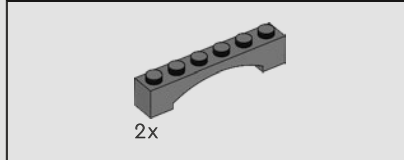
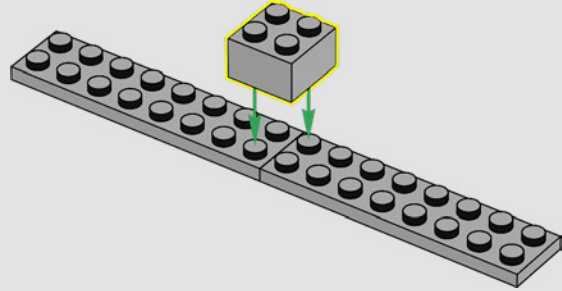

2x

3

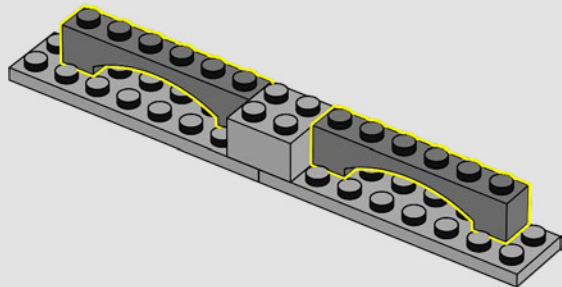

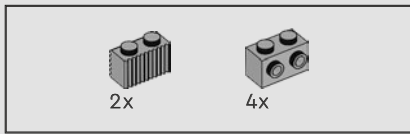

4

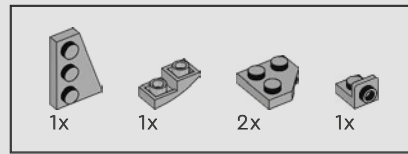
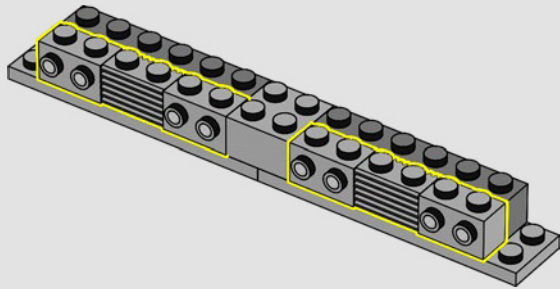

5

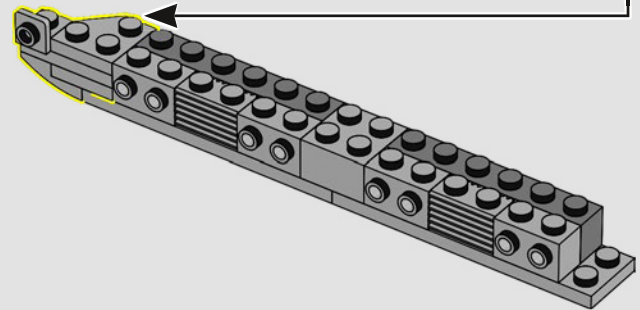
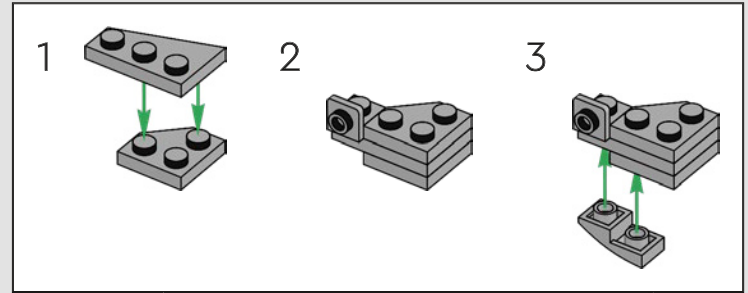

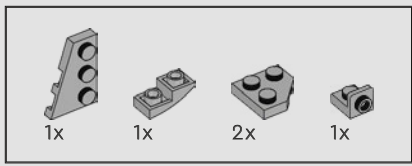

6

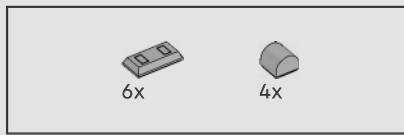
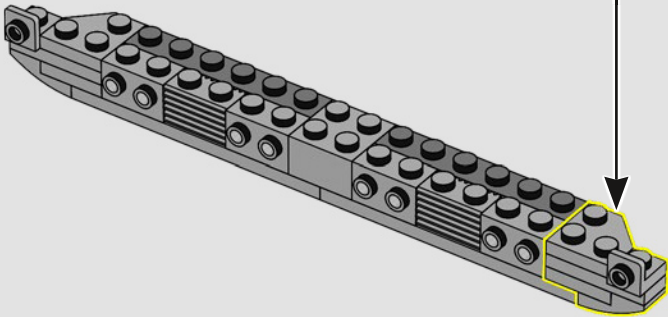
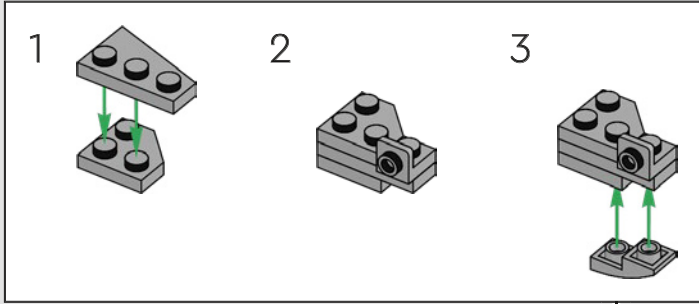

7

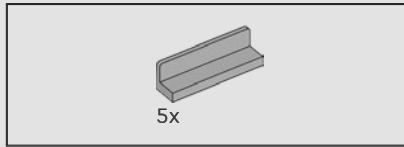
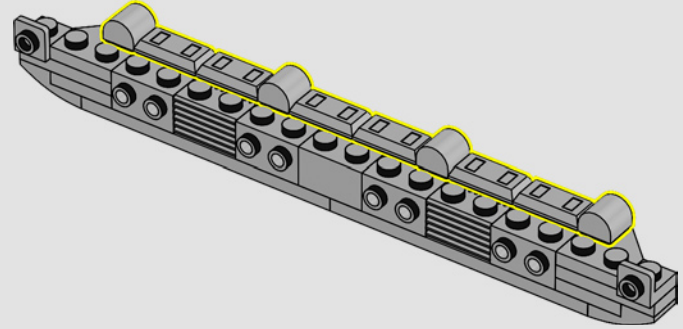

8

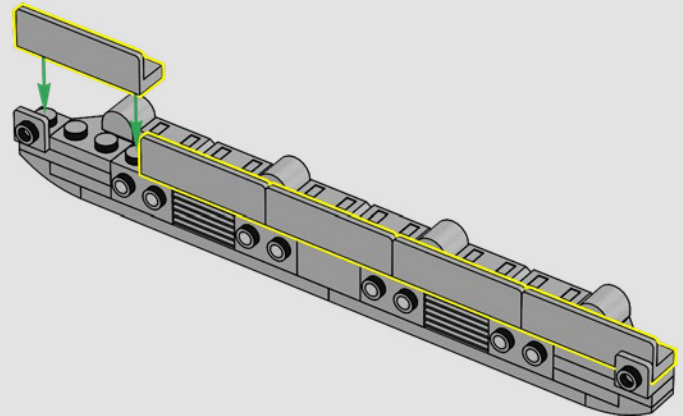



9

1

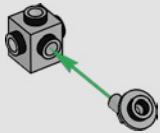

2



3

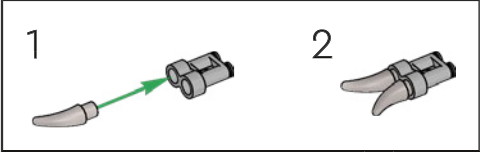
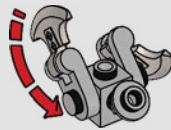

4



2x

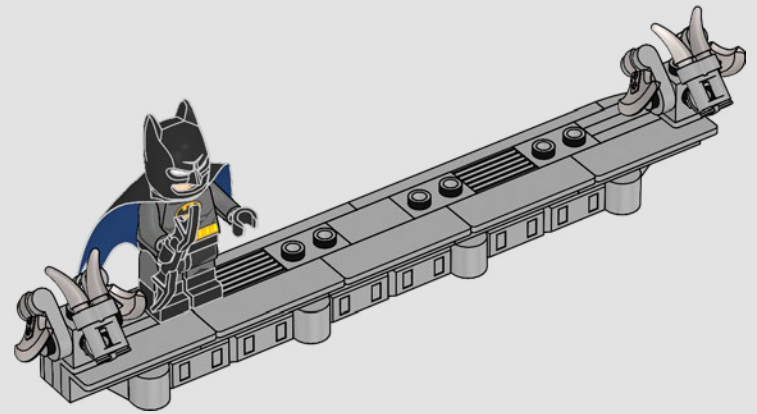
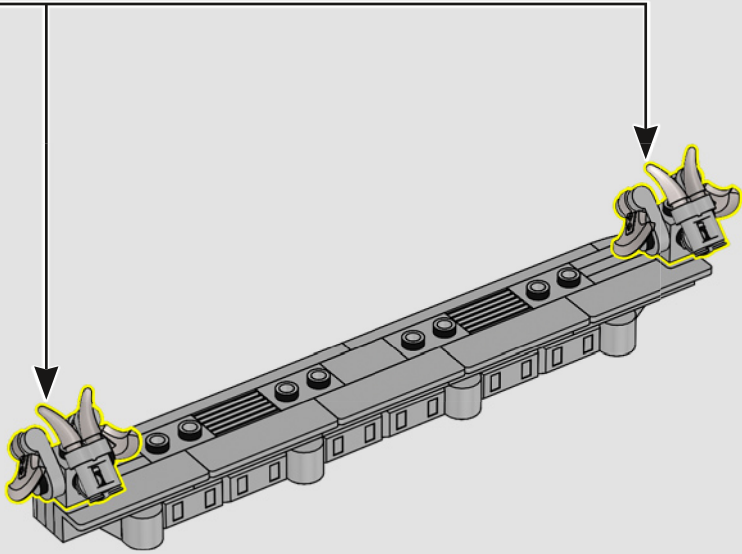

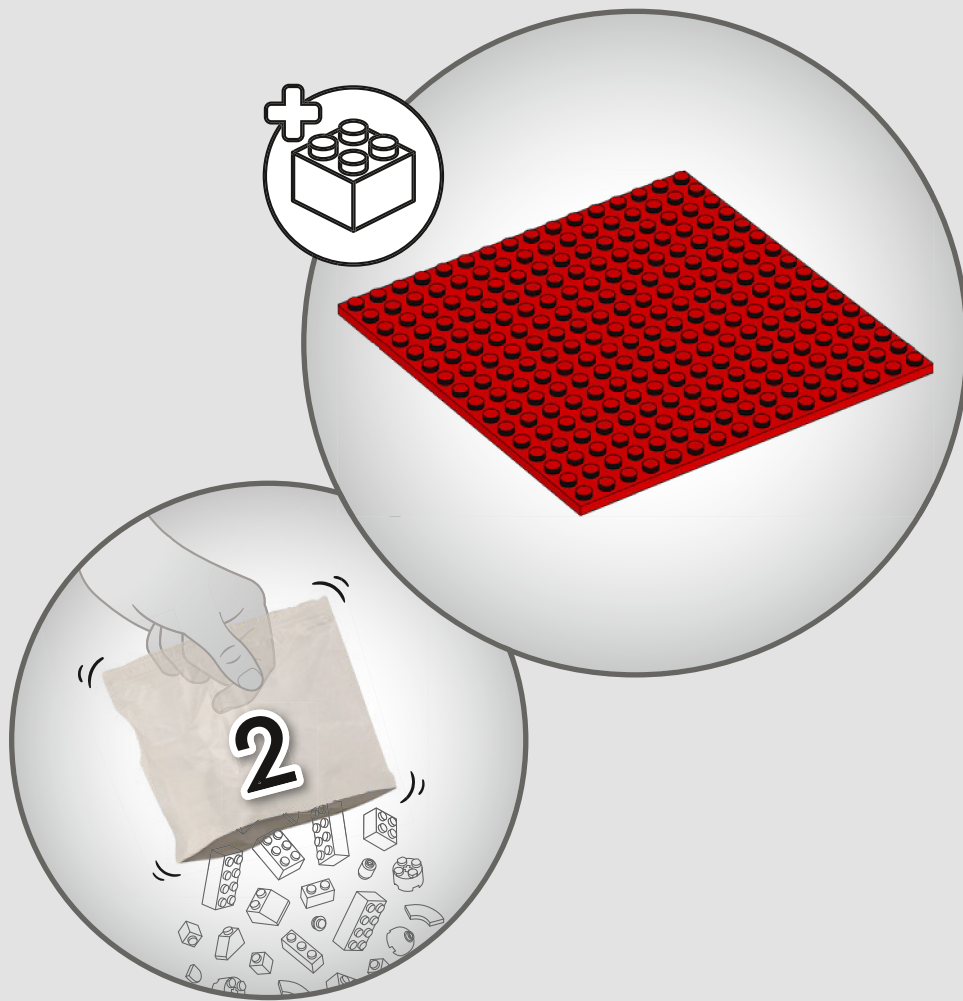

Episode: *On Leather Wings*
Épisode : *Le duel*
Episodio: *Alas de piel*

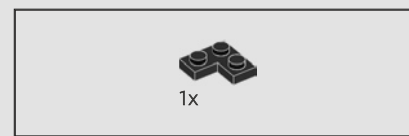

1

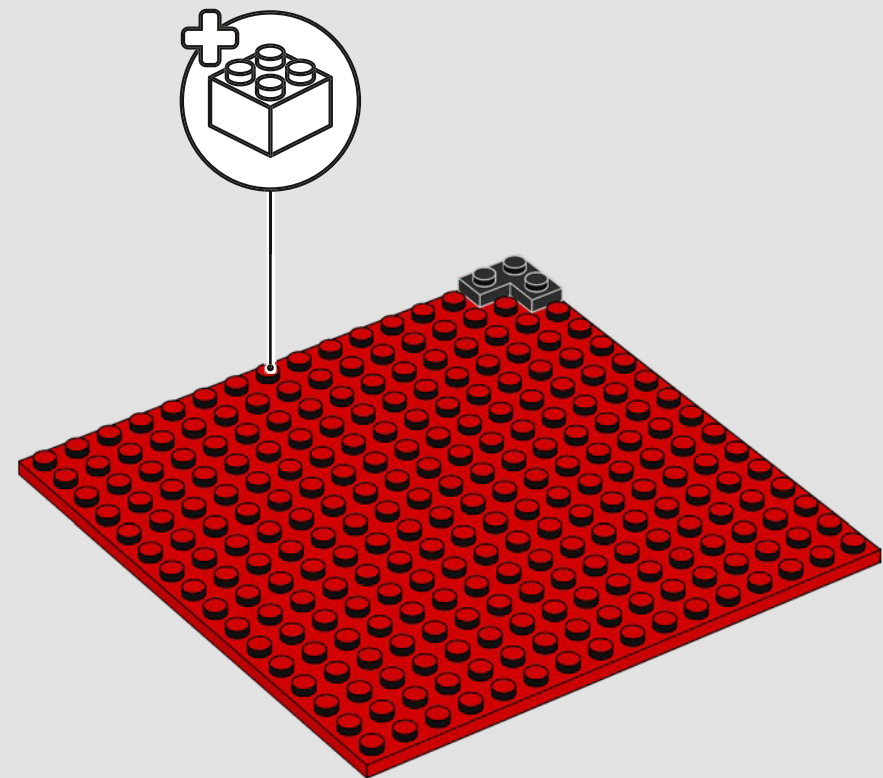

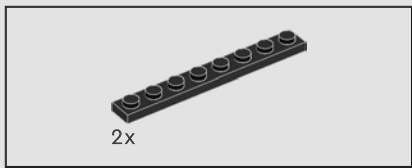

2

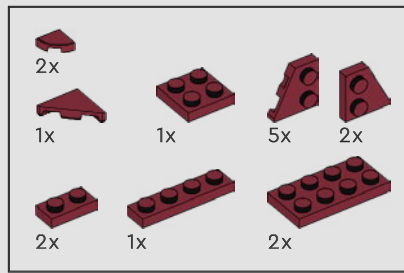
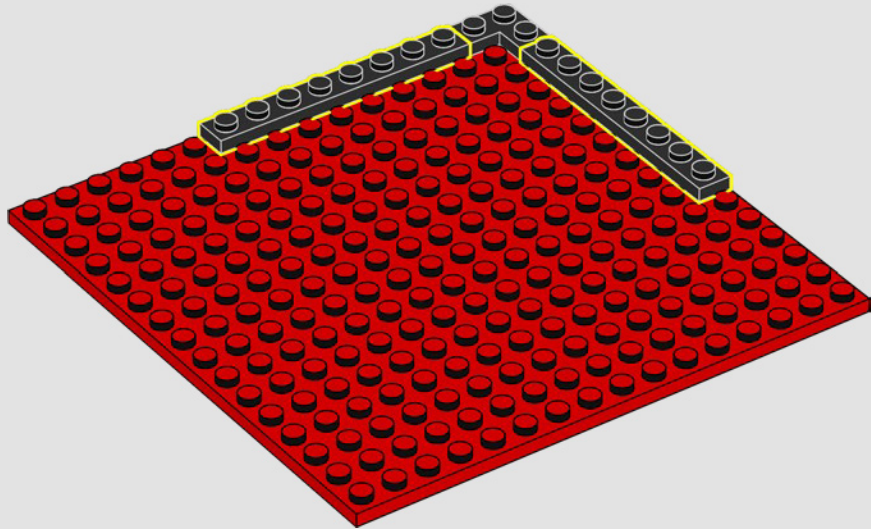

3

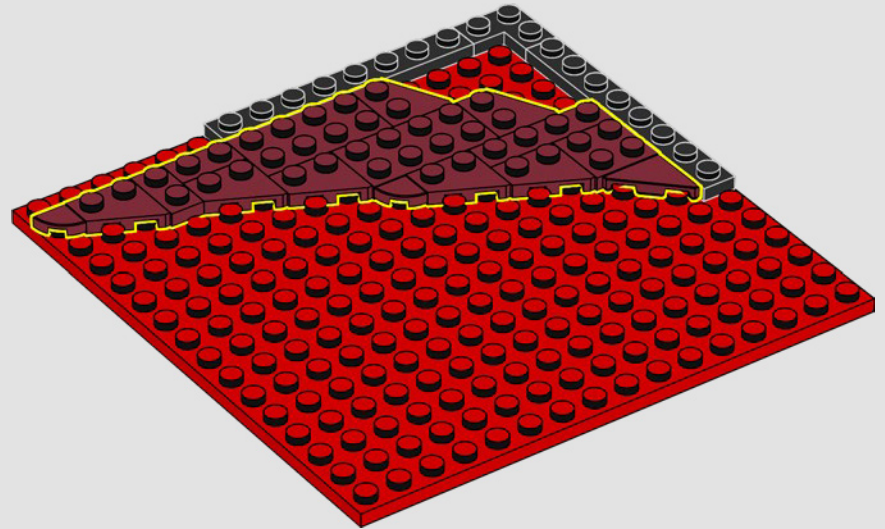

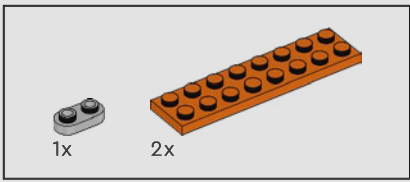

6

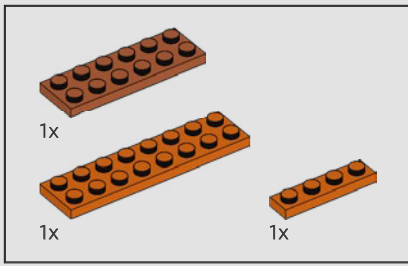
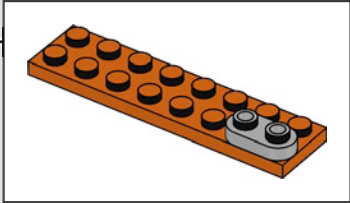
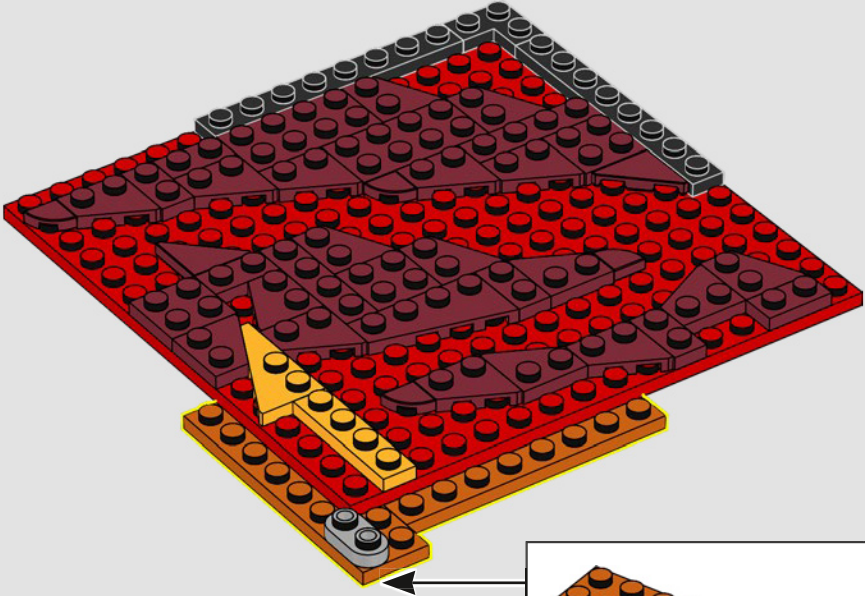

7

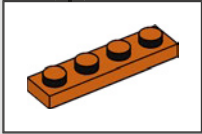

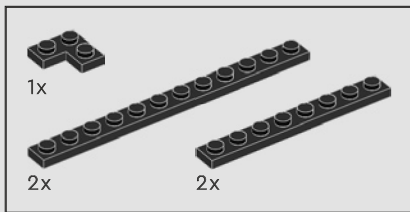

8

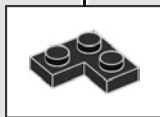

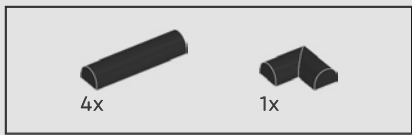

9

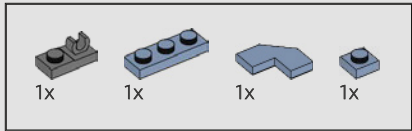
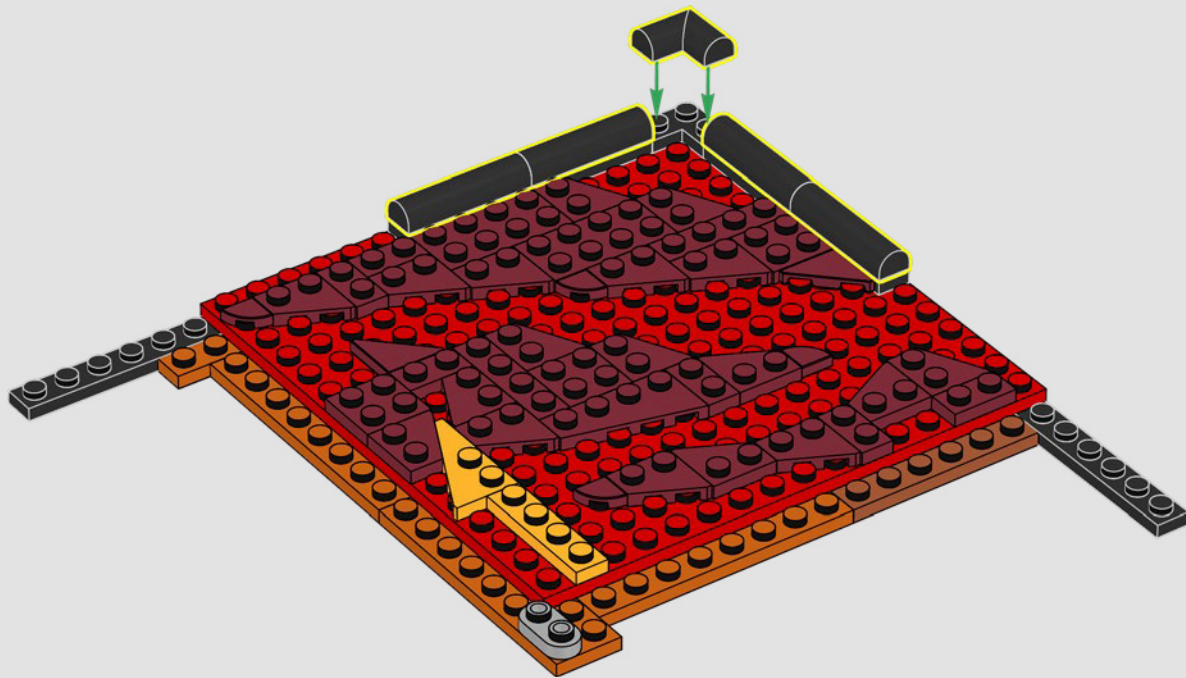

10



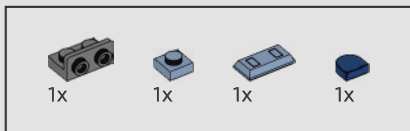

11

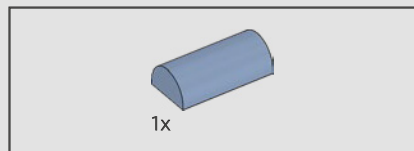
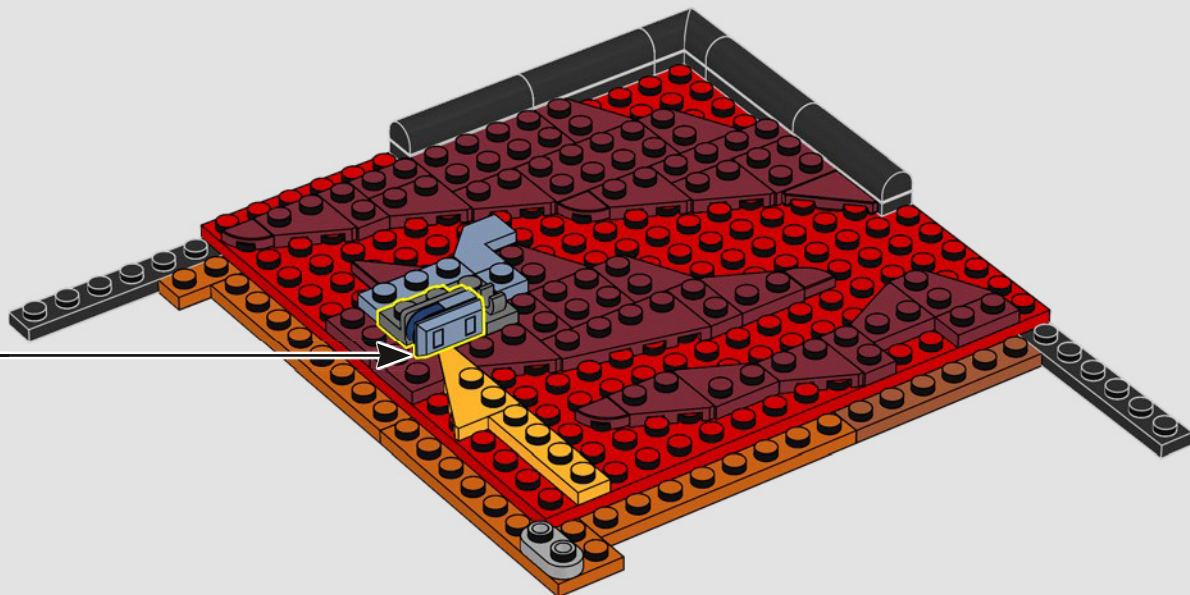
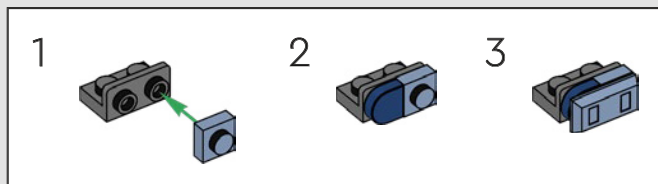

12

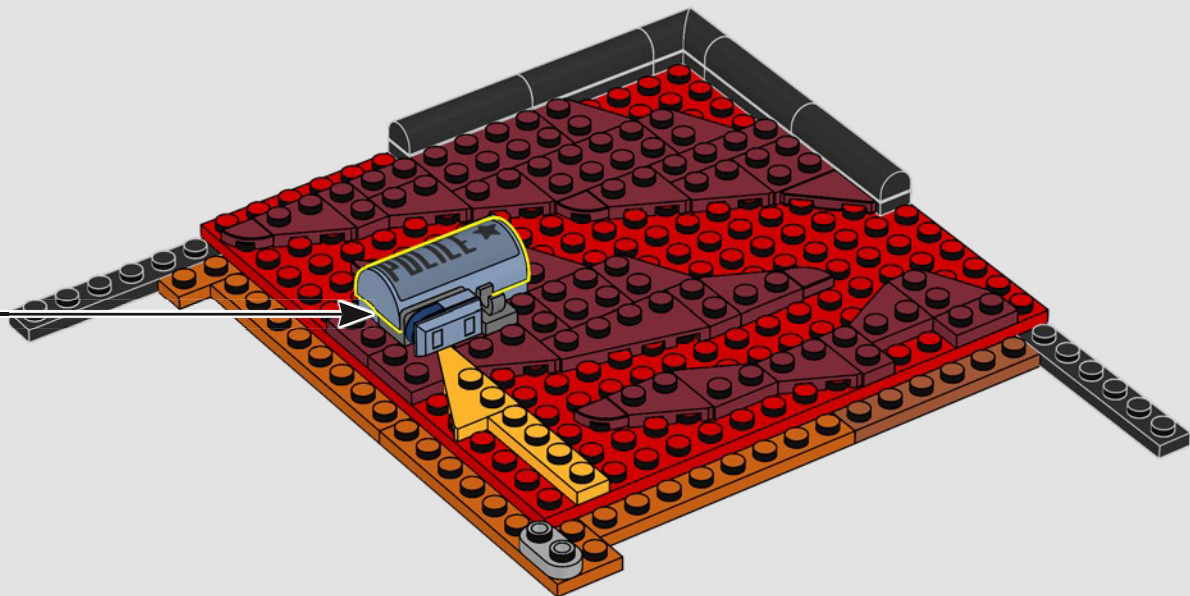
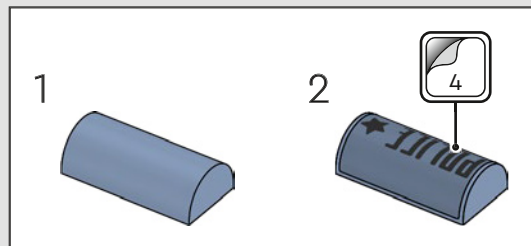

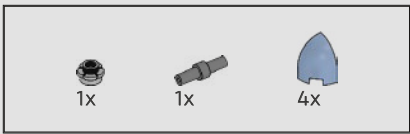

13

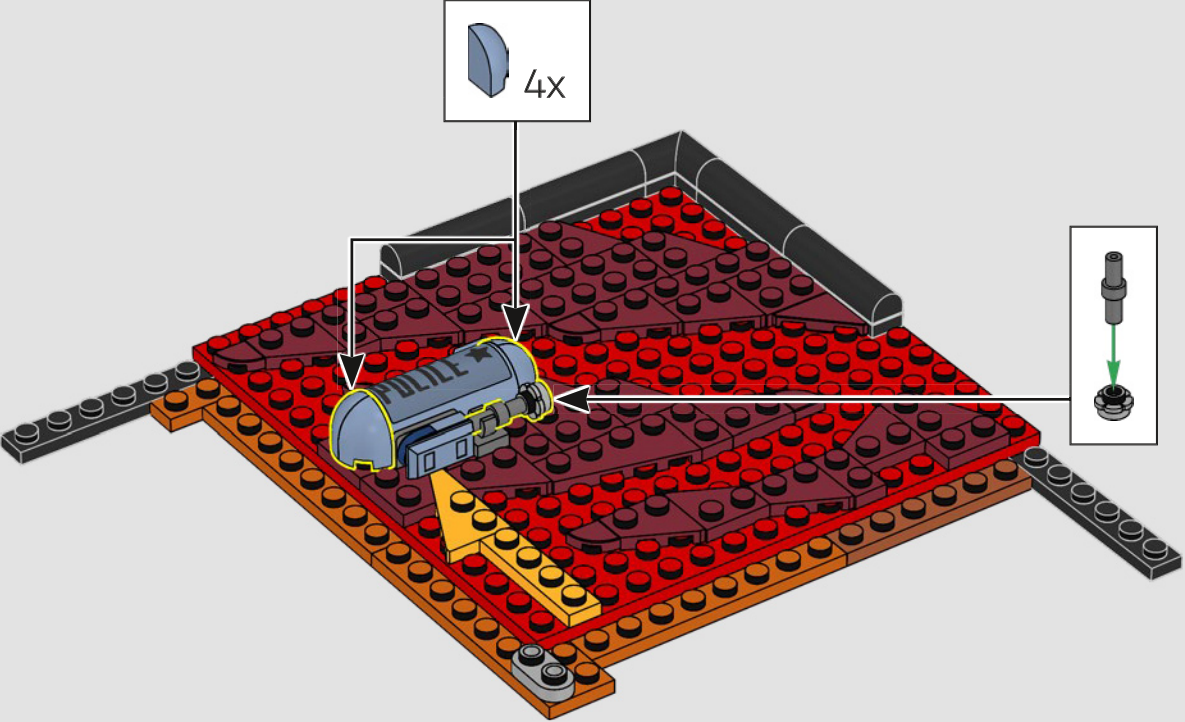

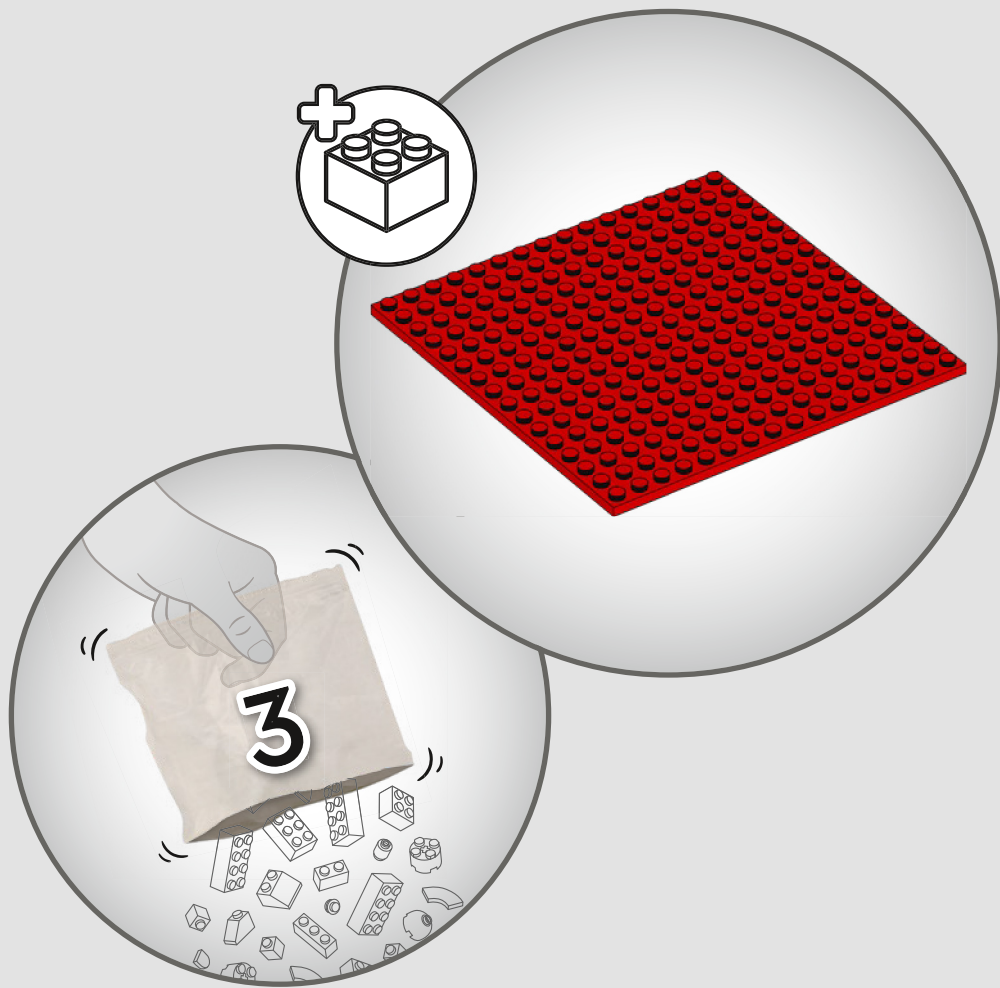

Episode: *The Last Laugh*
Épisode : *Morts de rire*
Episodio: *La última risa*

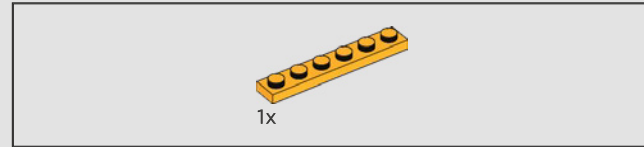
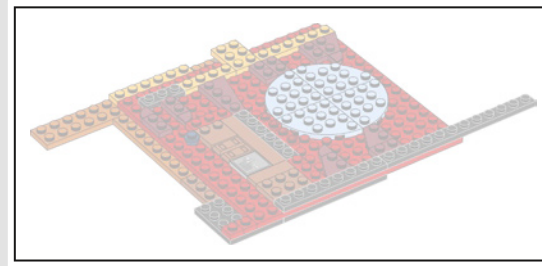

14

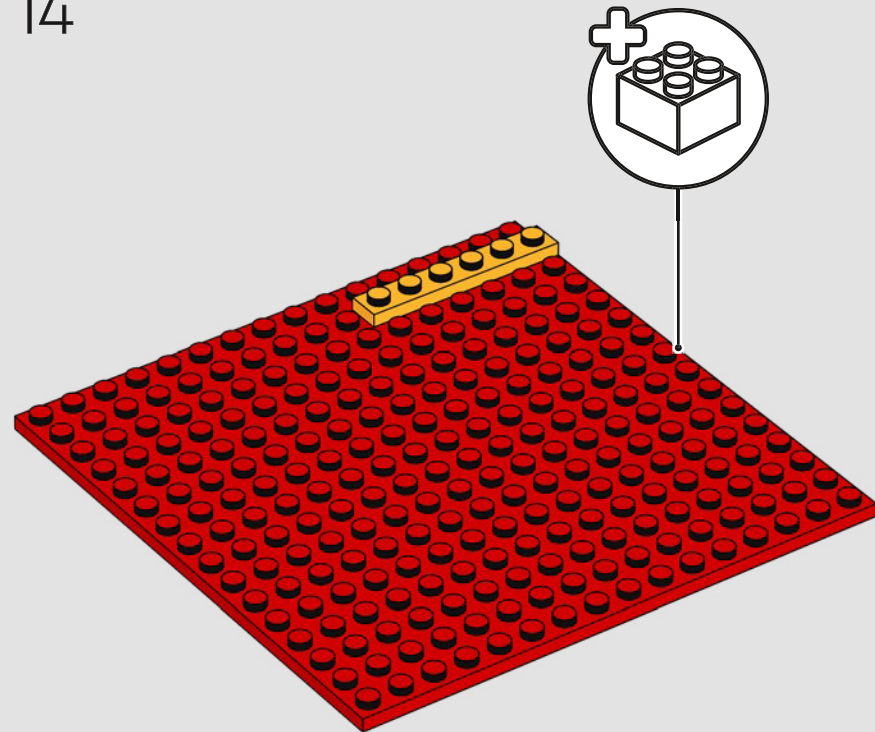

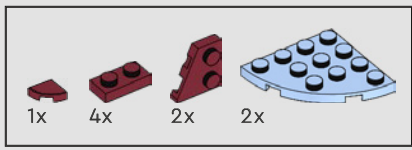

15

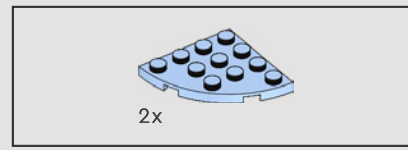
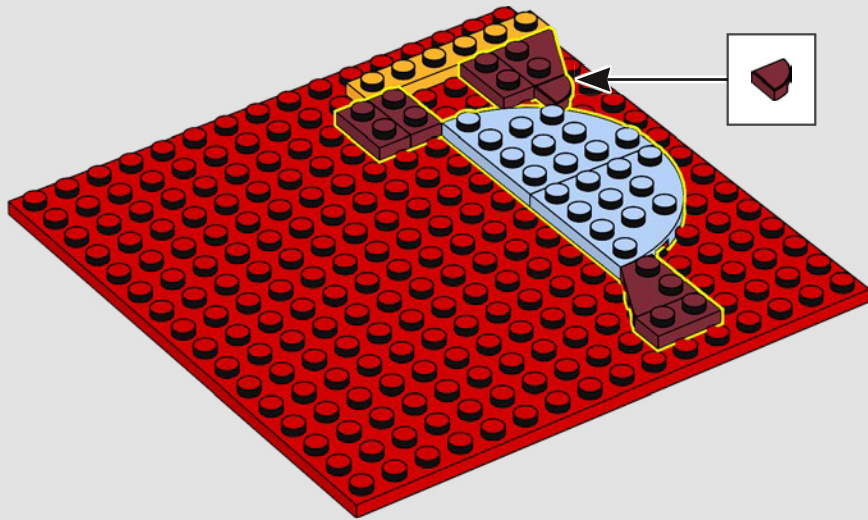

16

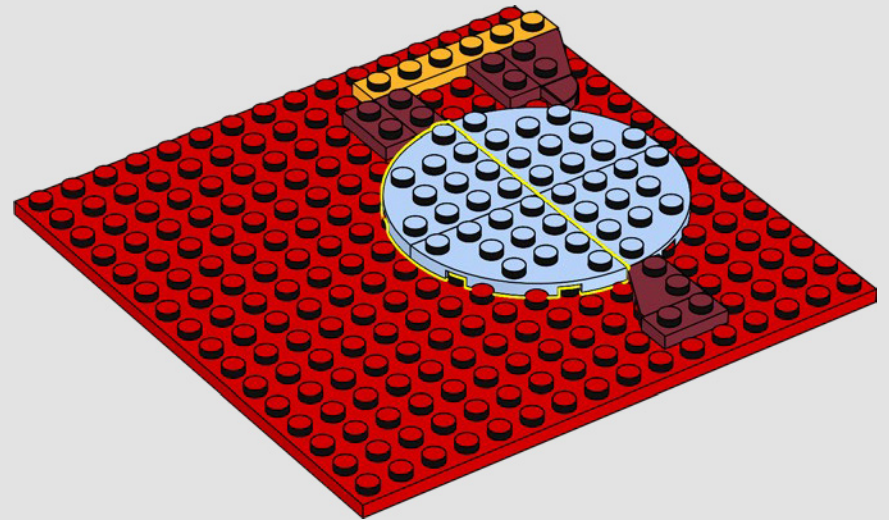

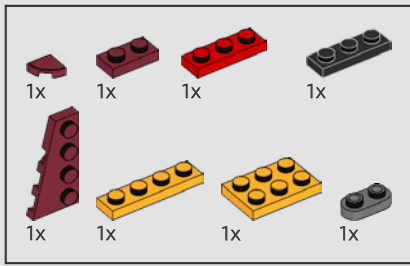

17

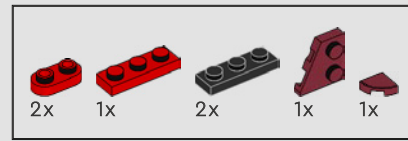
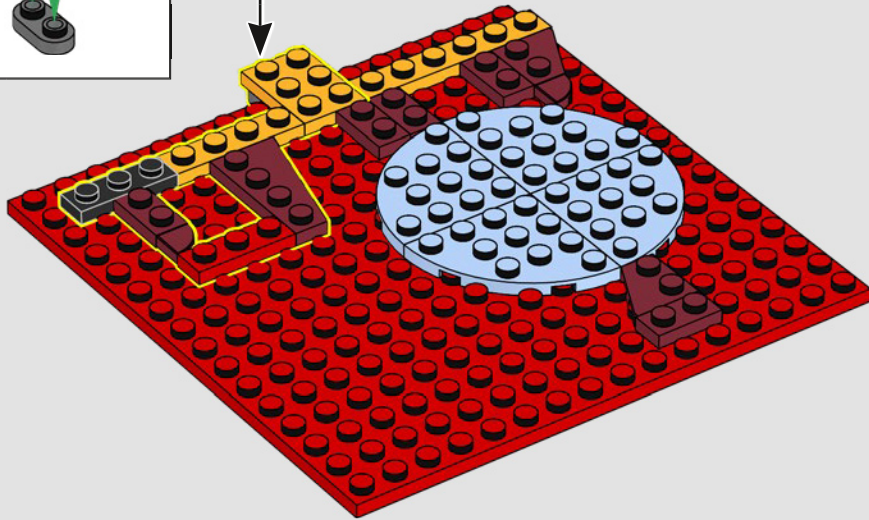
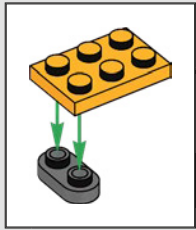

18

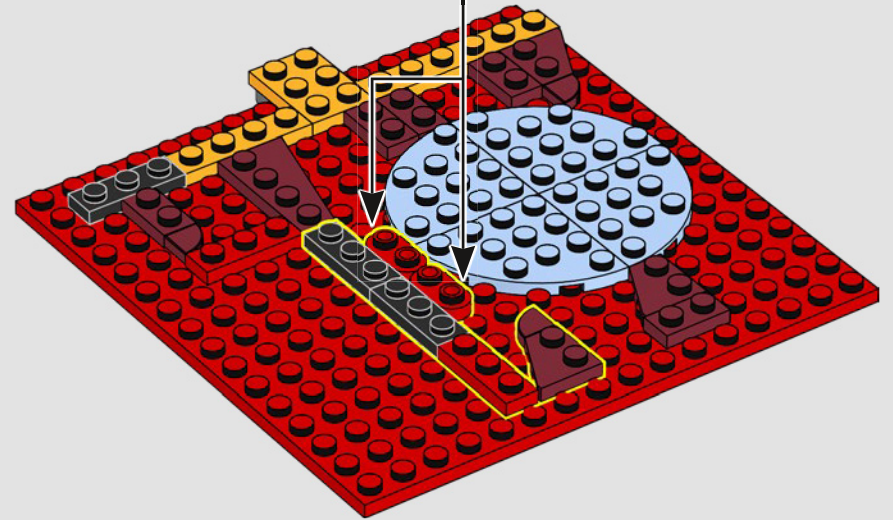

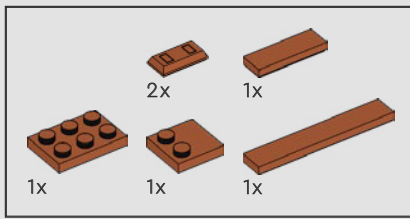

19

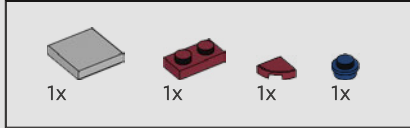
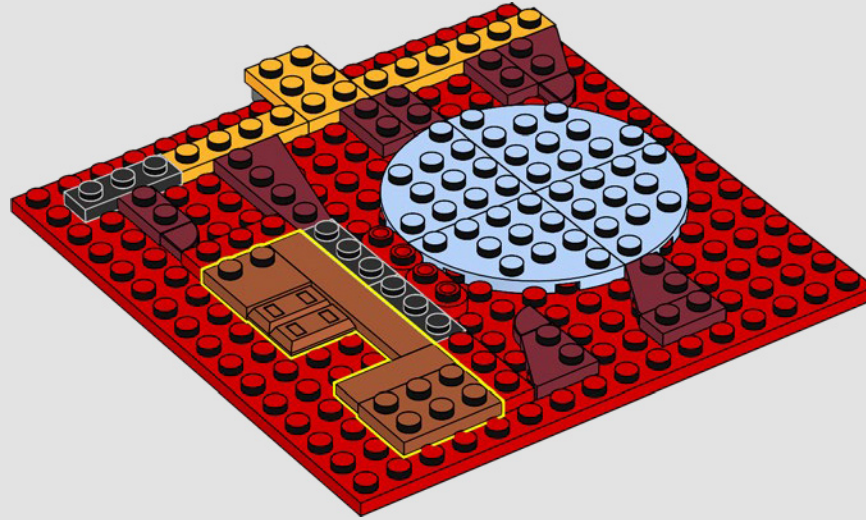

20

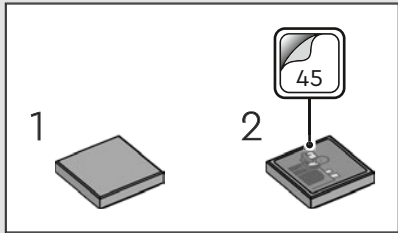
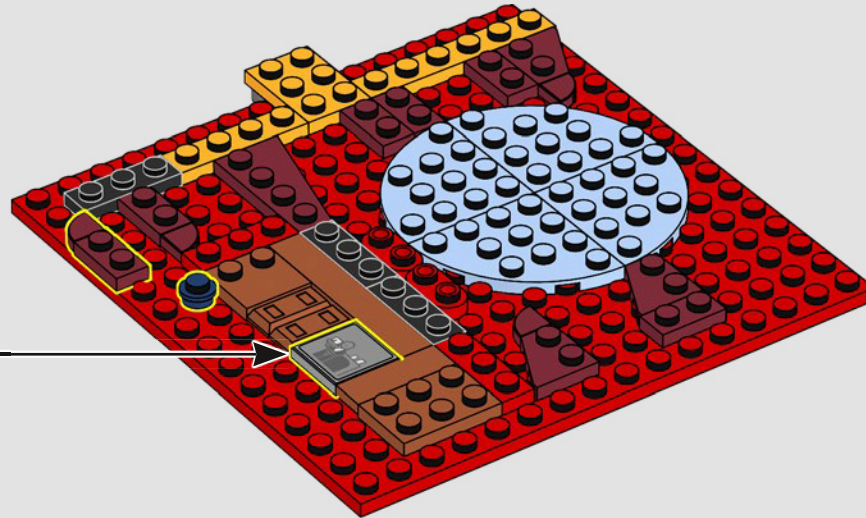

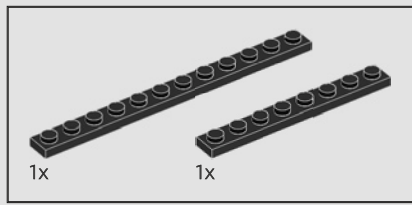

21

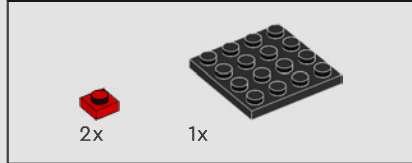
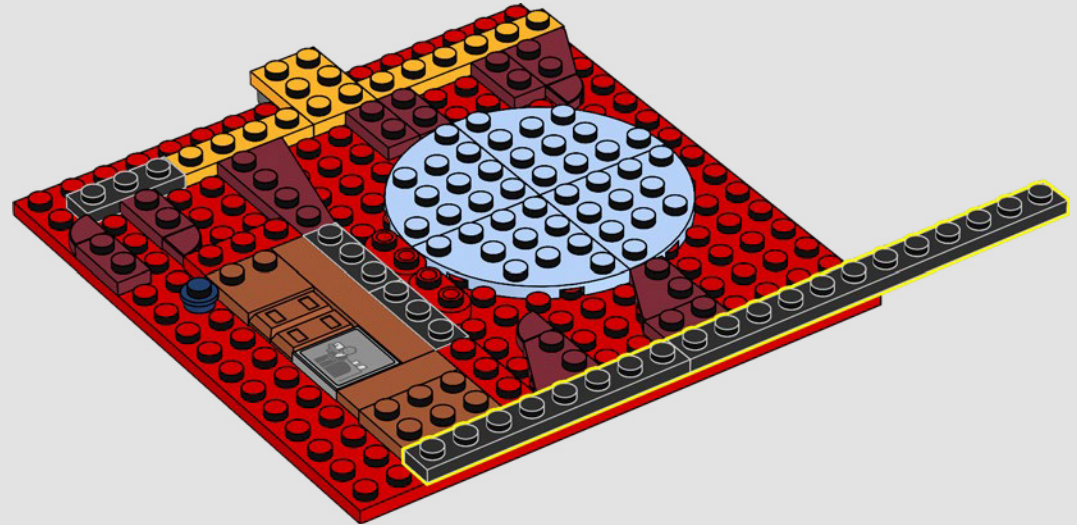

22

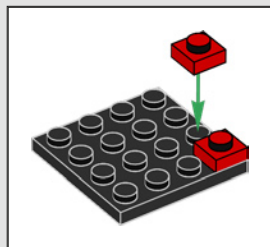
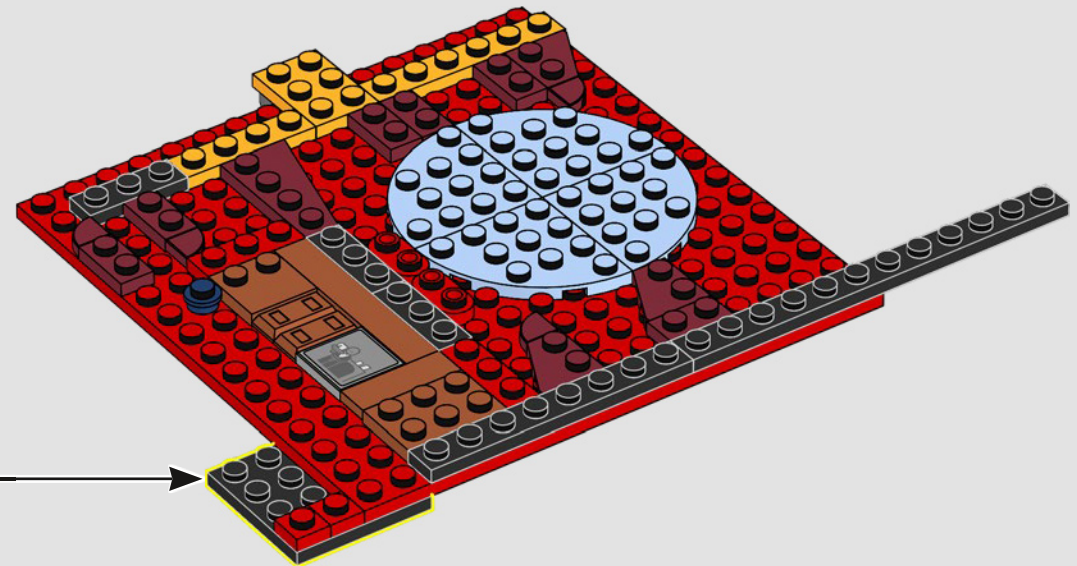

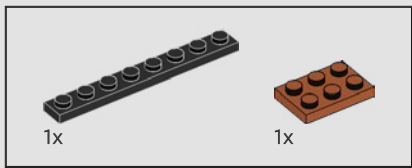

23

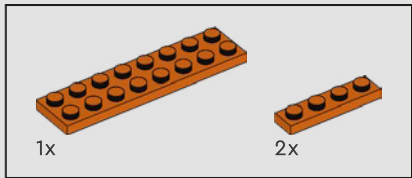
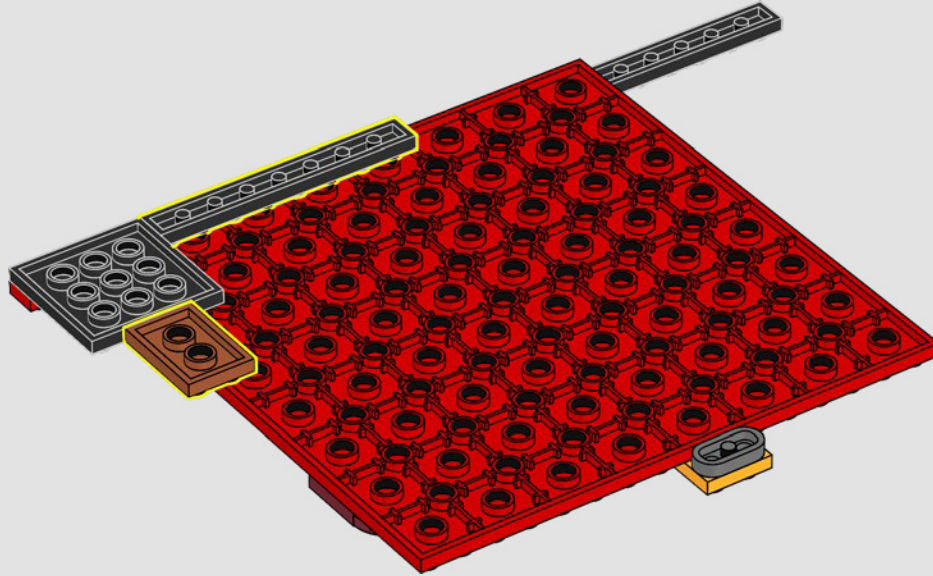

24

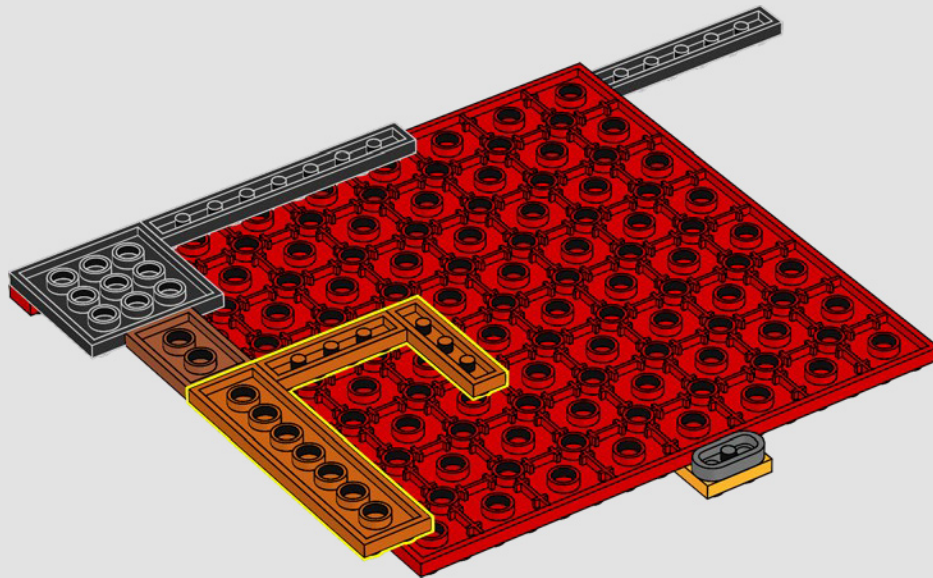

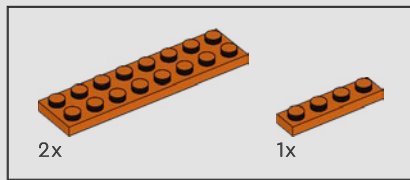

25

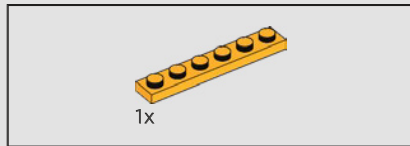
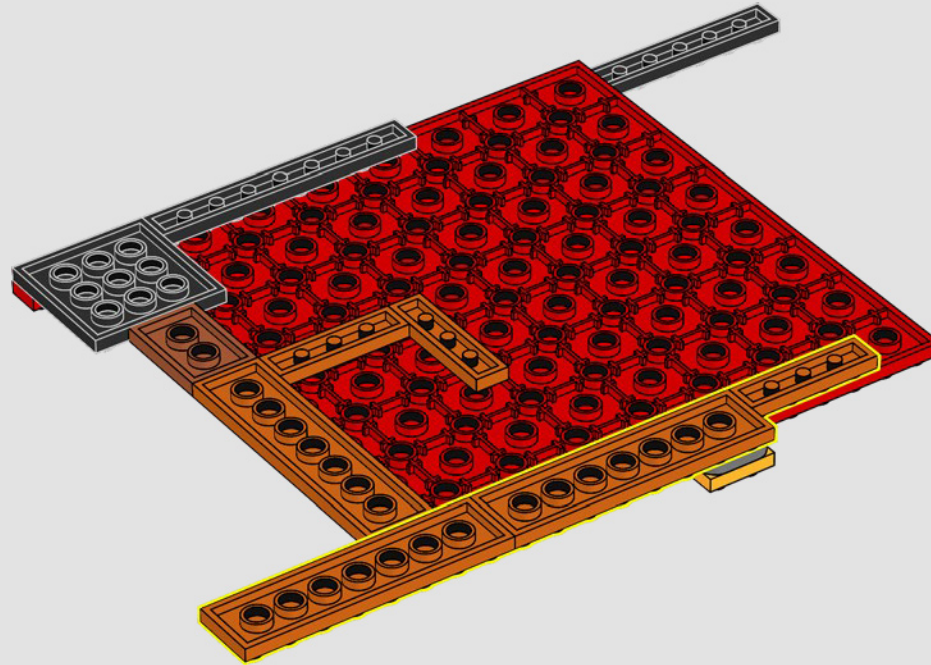

26



27

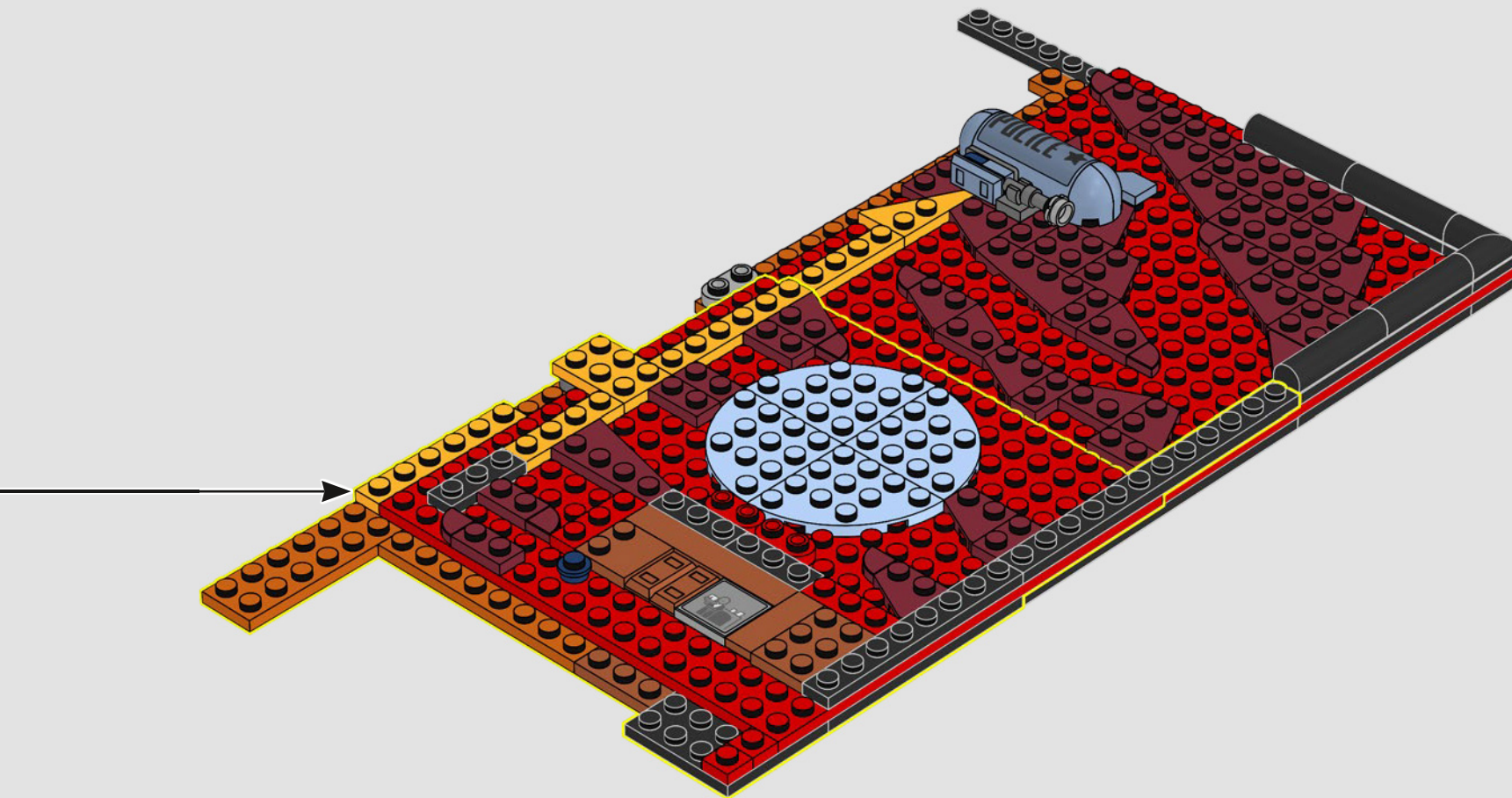



28

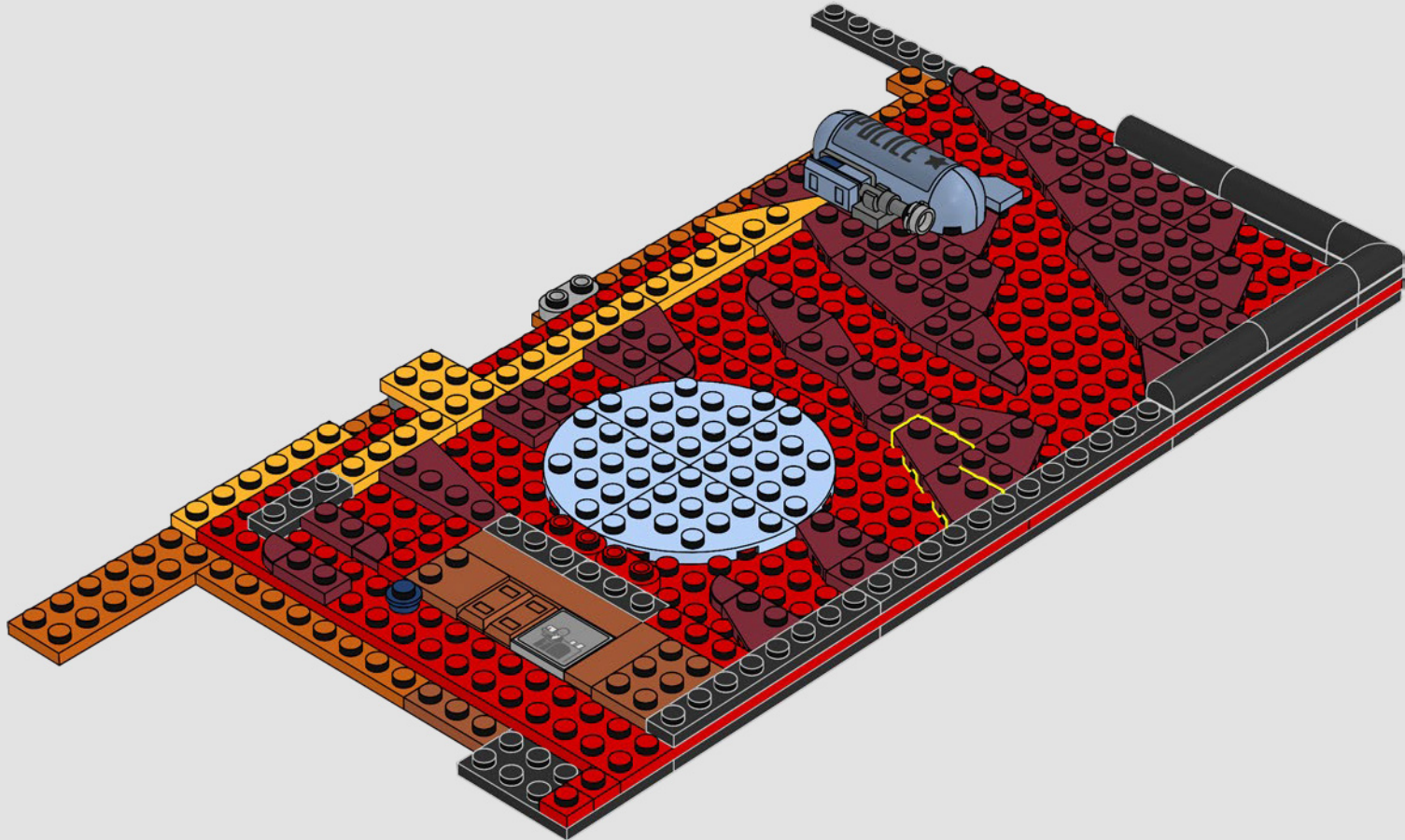



29

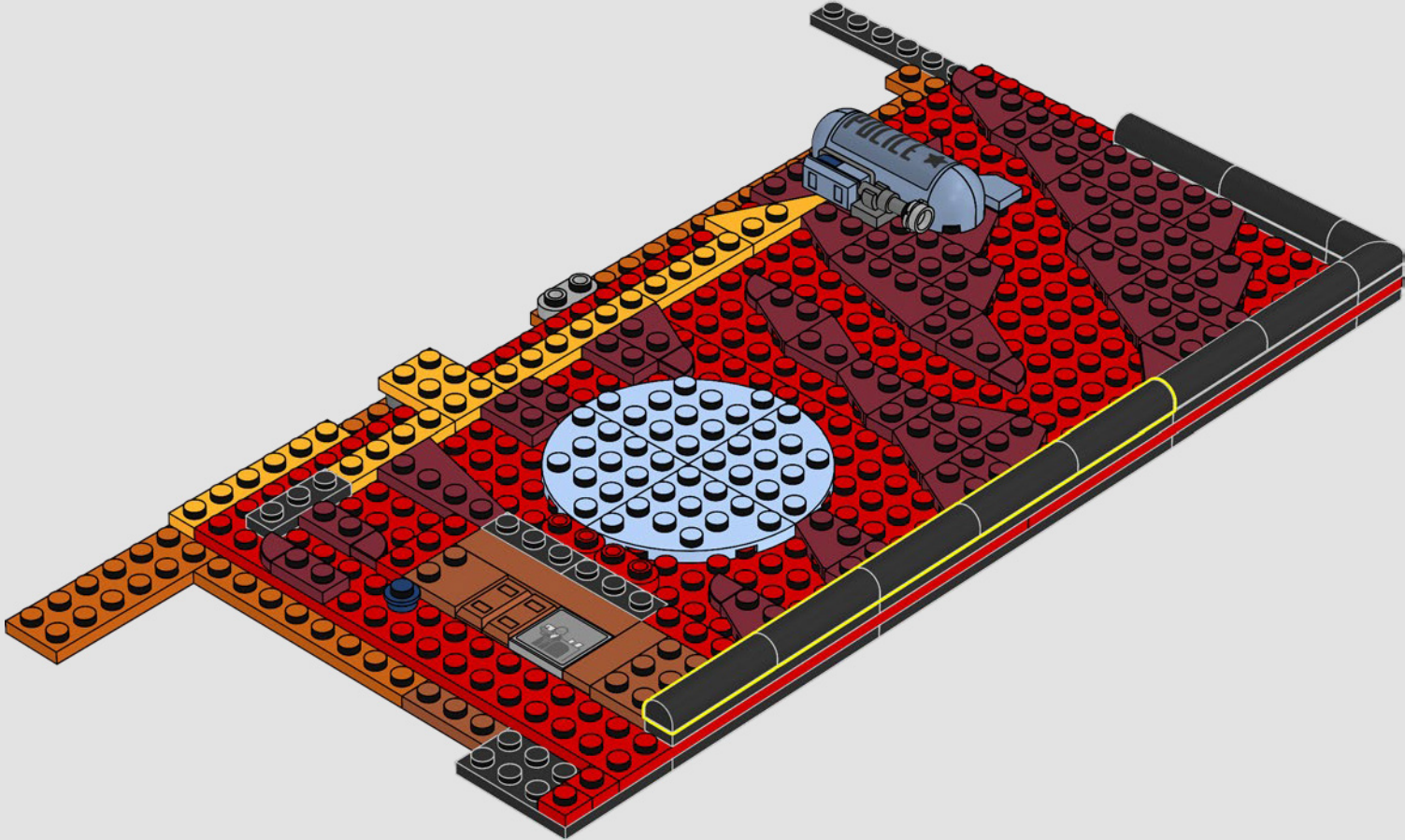

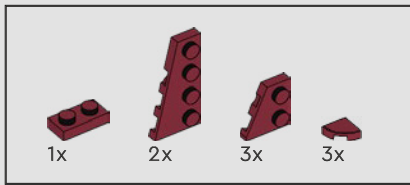

30

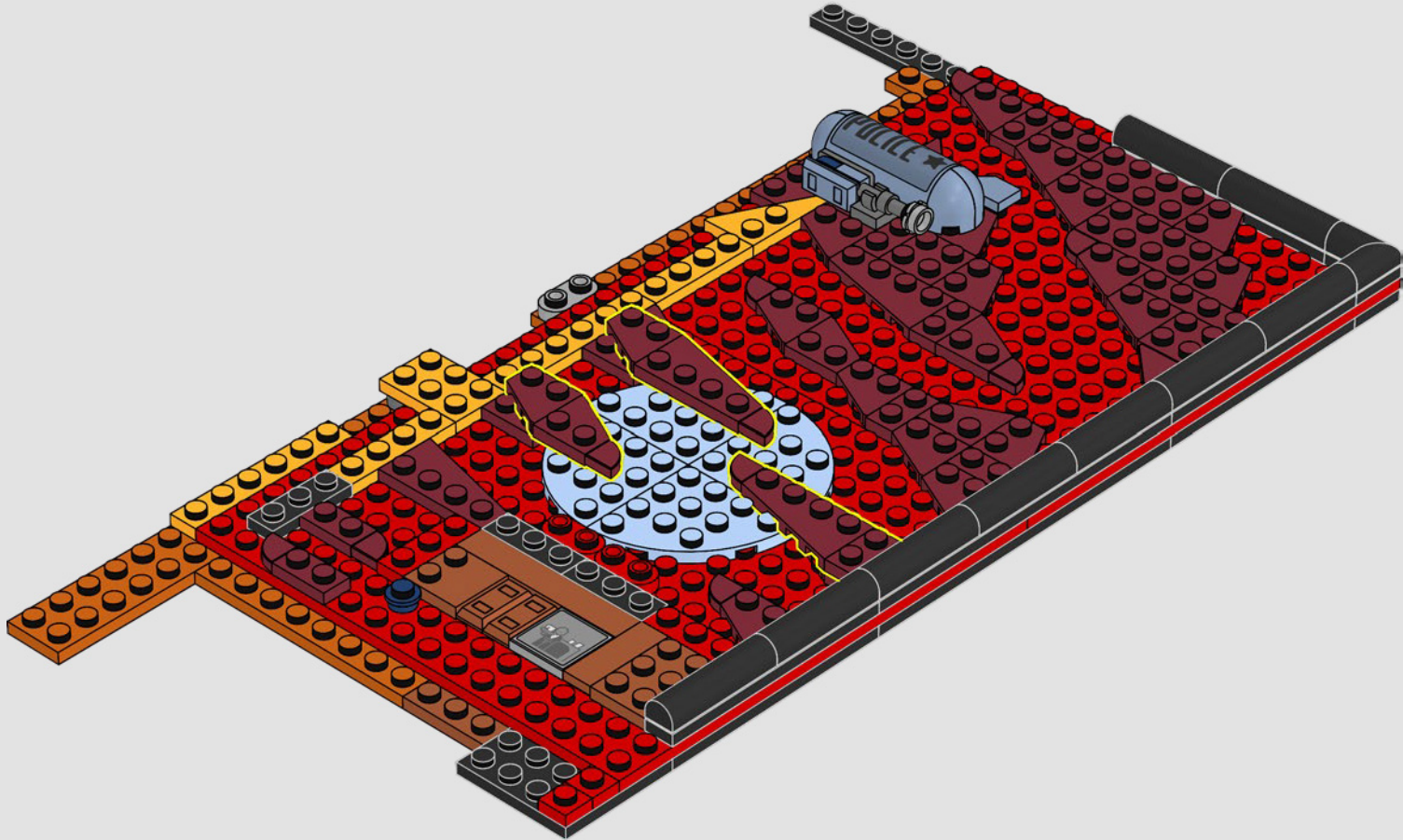

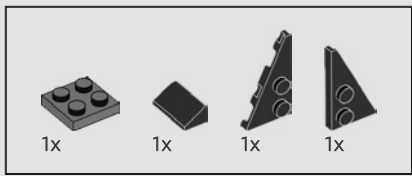

31

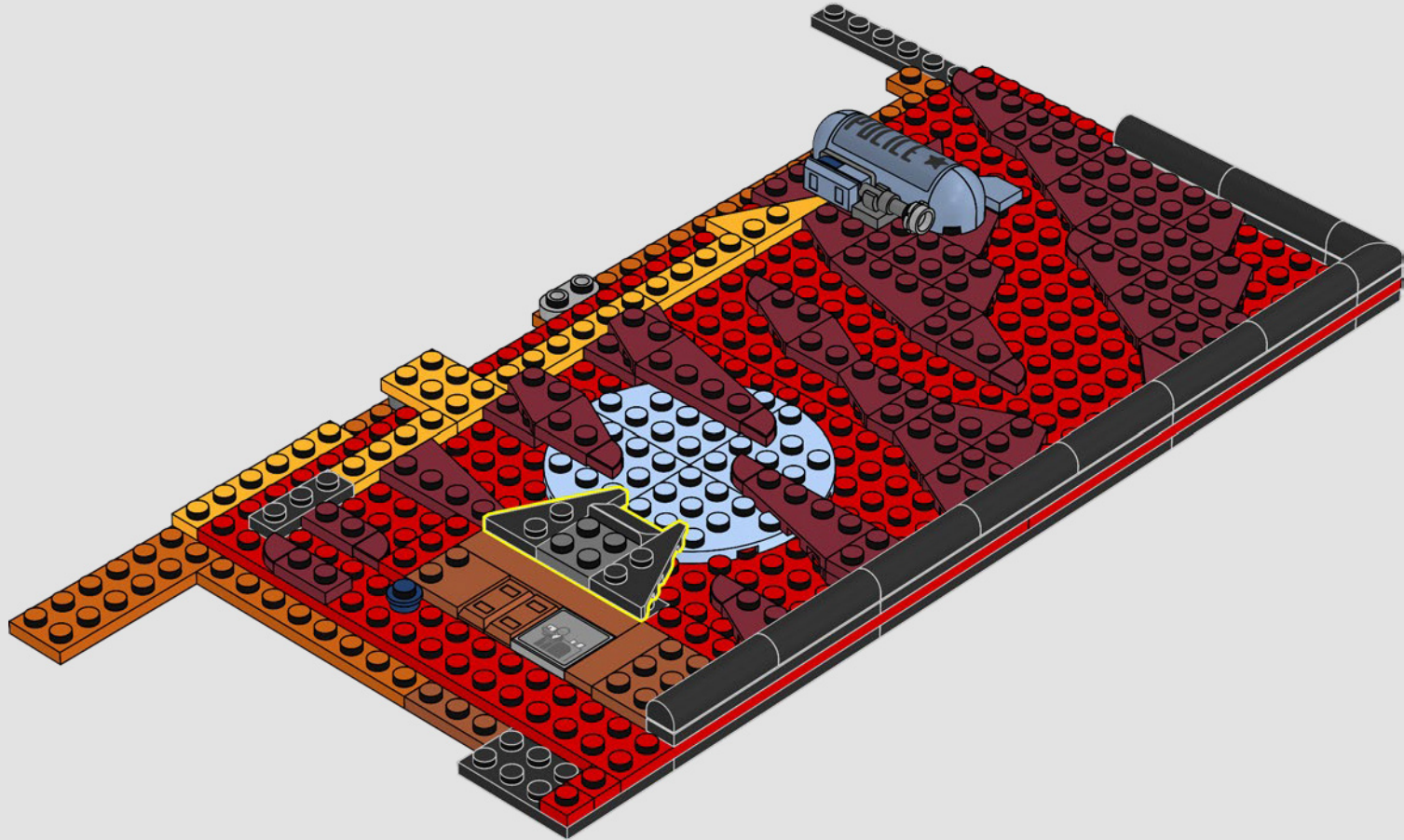

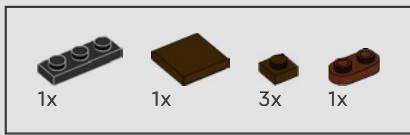

32

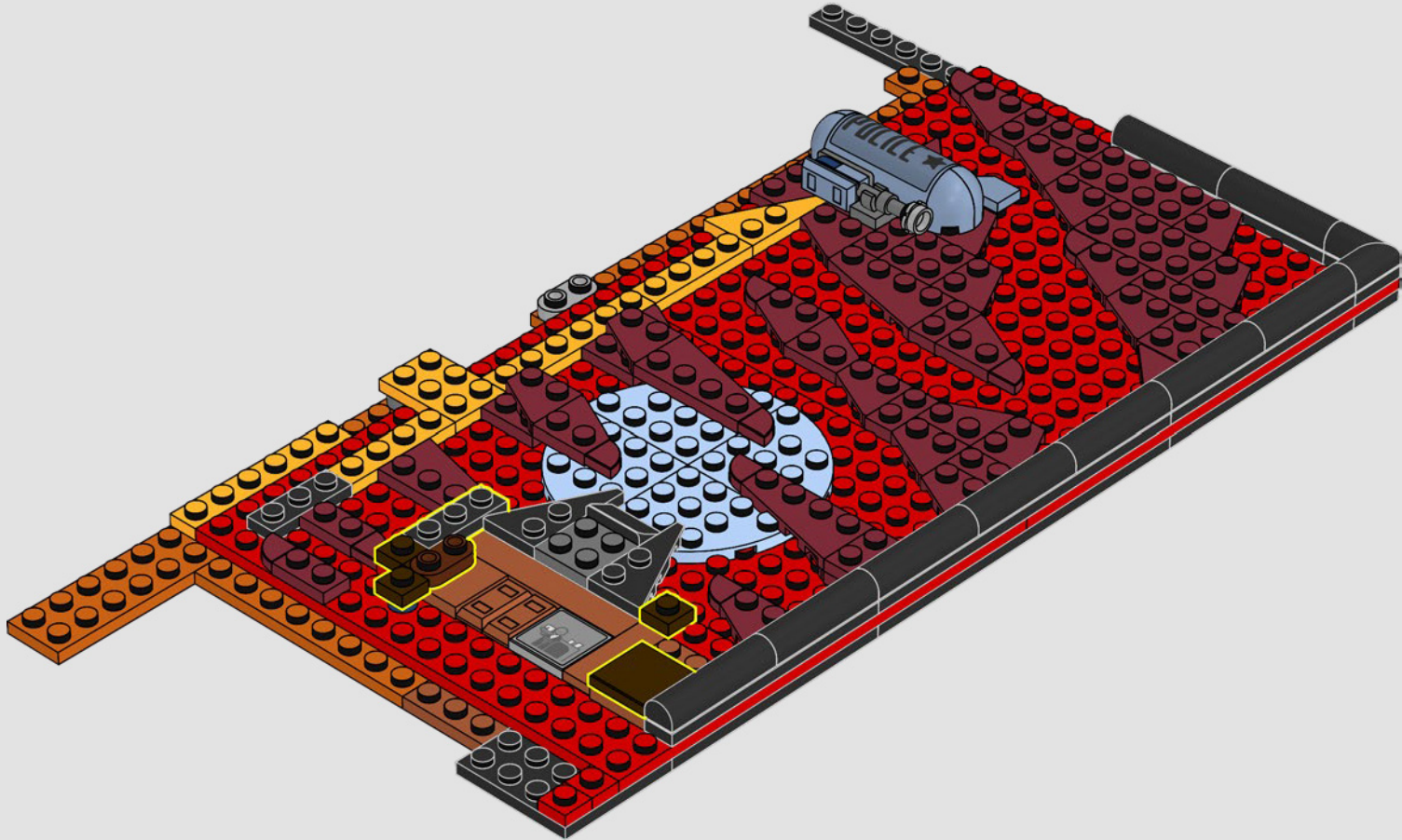

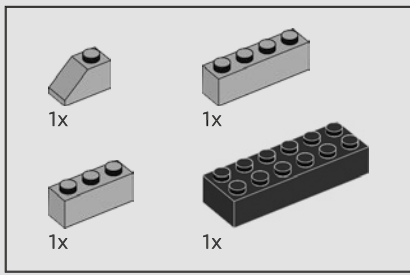

34

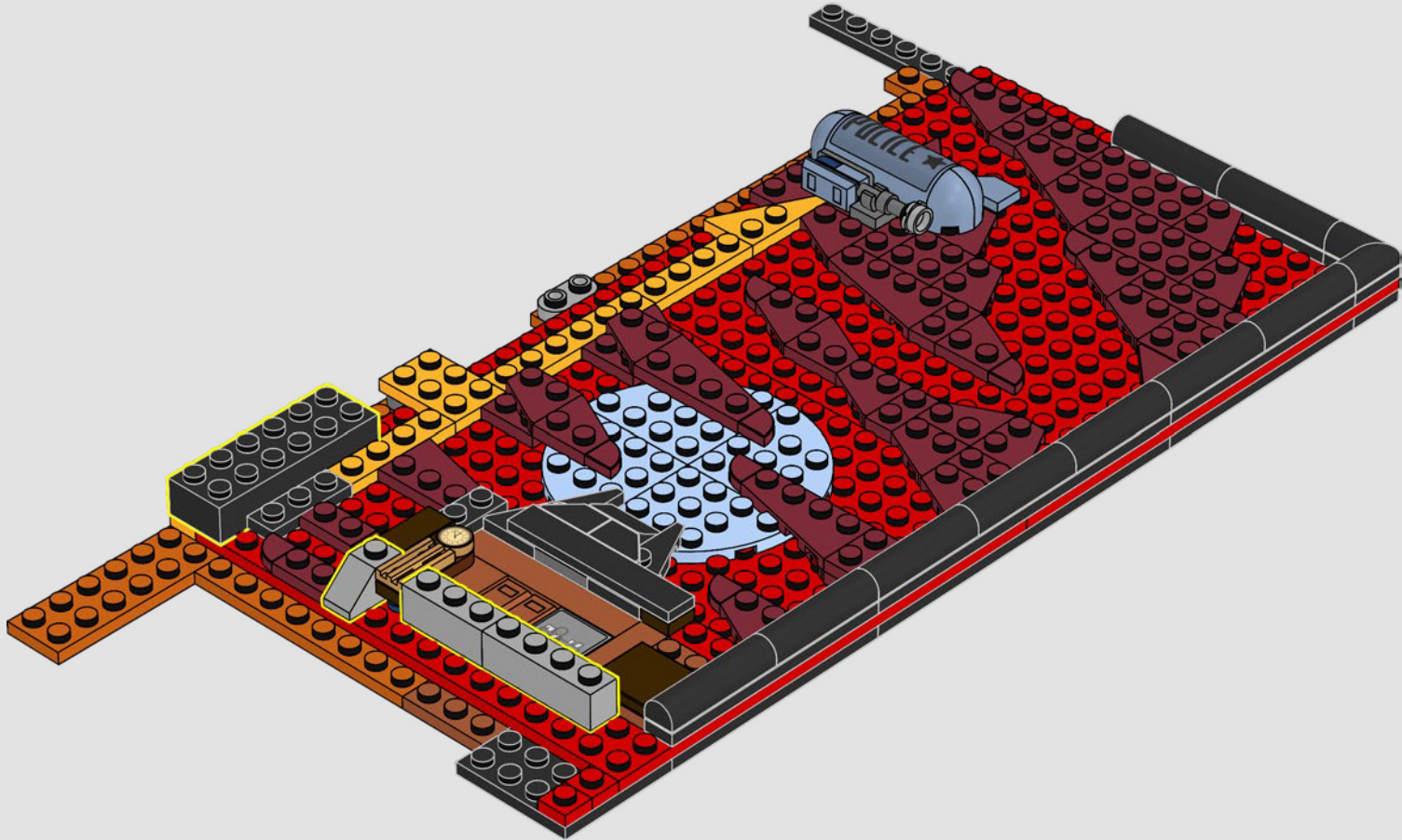



1x



1x



2x



3x



1x



2x



1x



3x

35

1

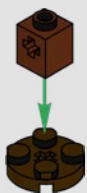

2



3

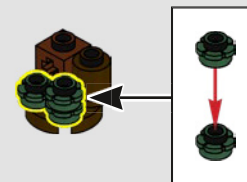

4



5

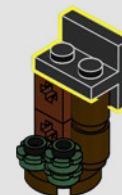

6

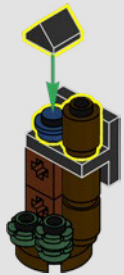

7

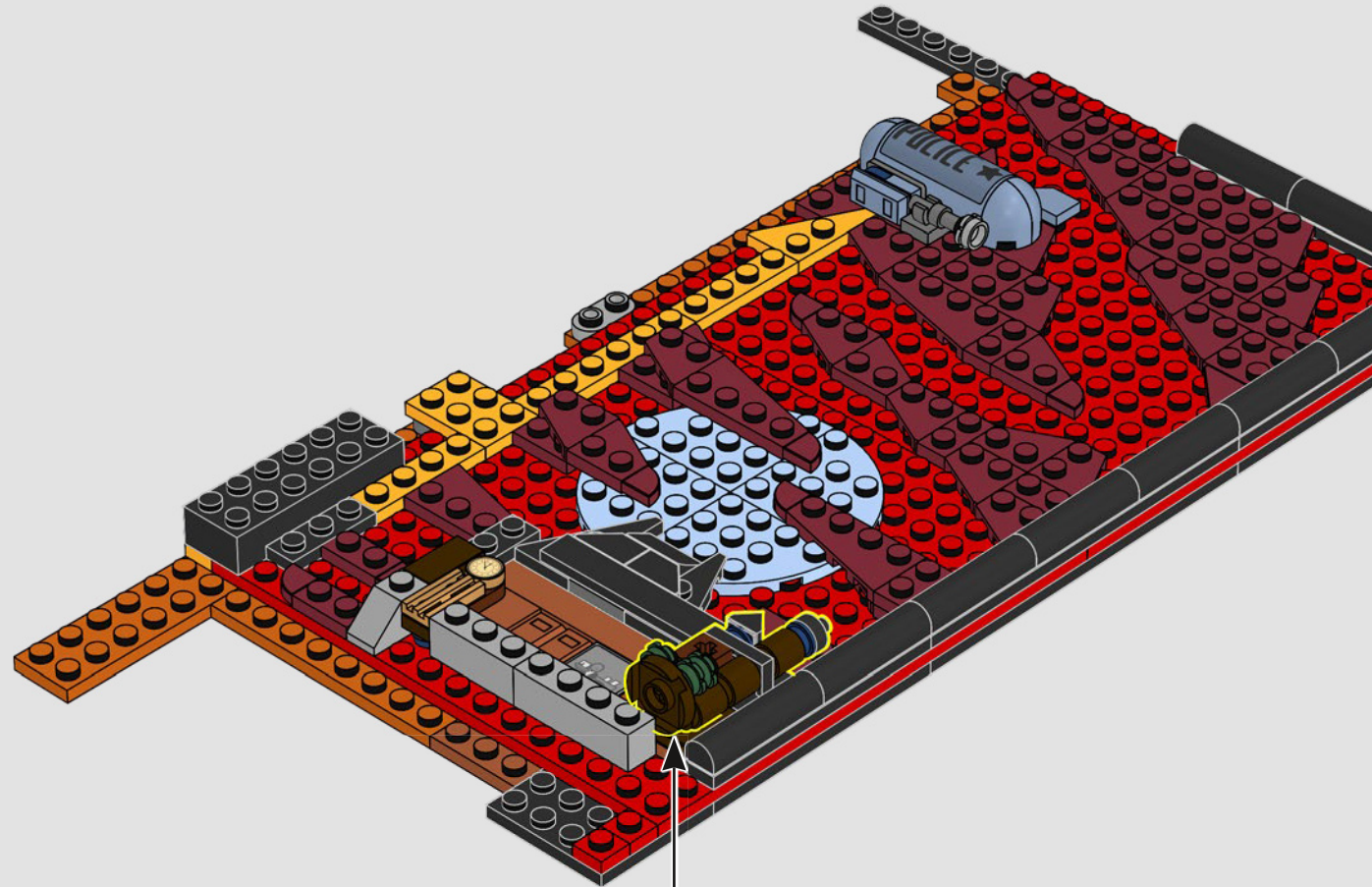

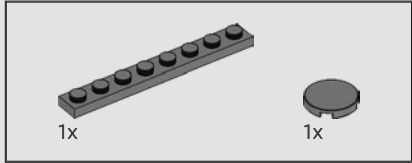
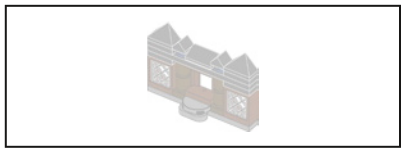

36

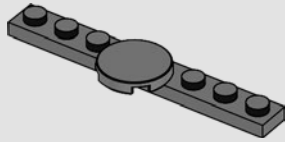

37

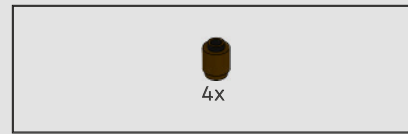
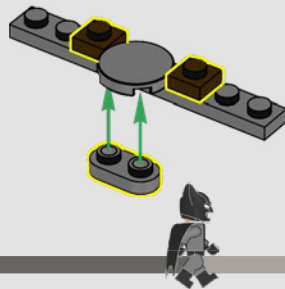

38

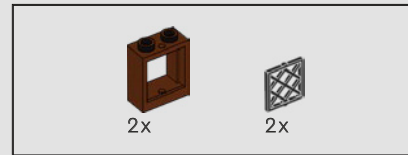
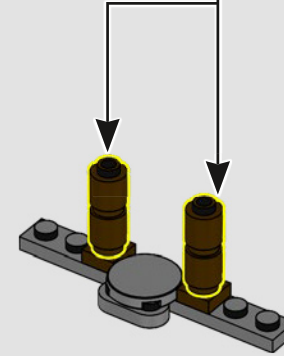
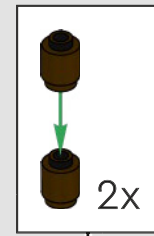

39

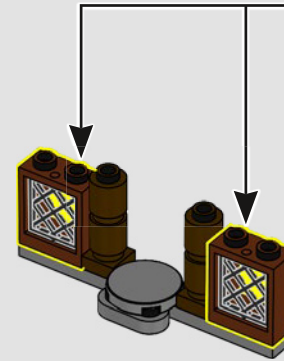
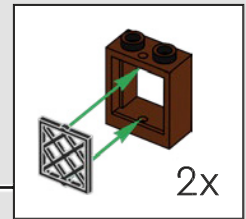

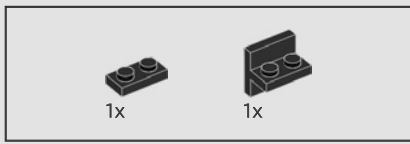

40

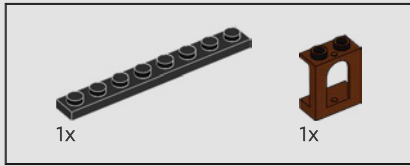
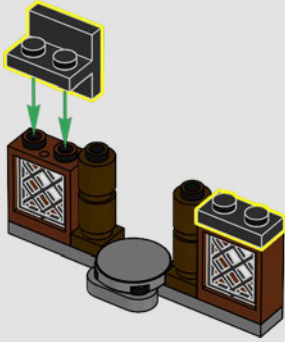

41

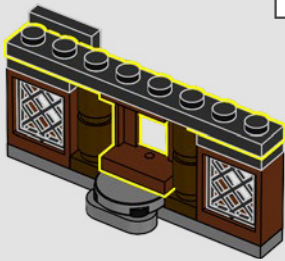
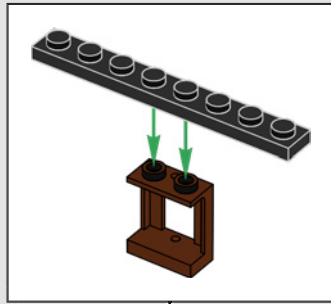

42

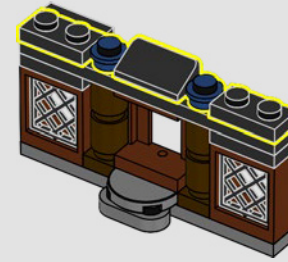

43

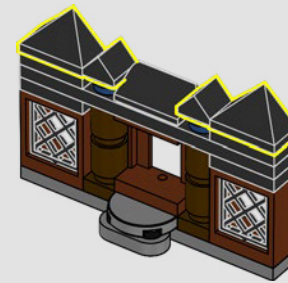

44

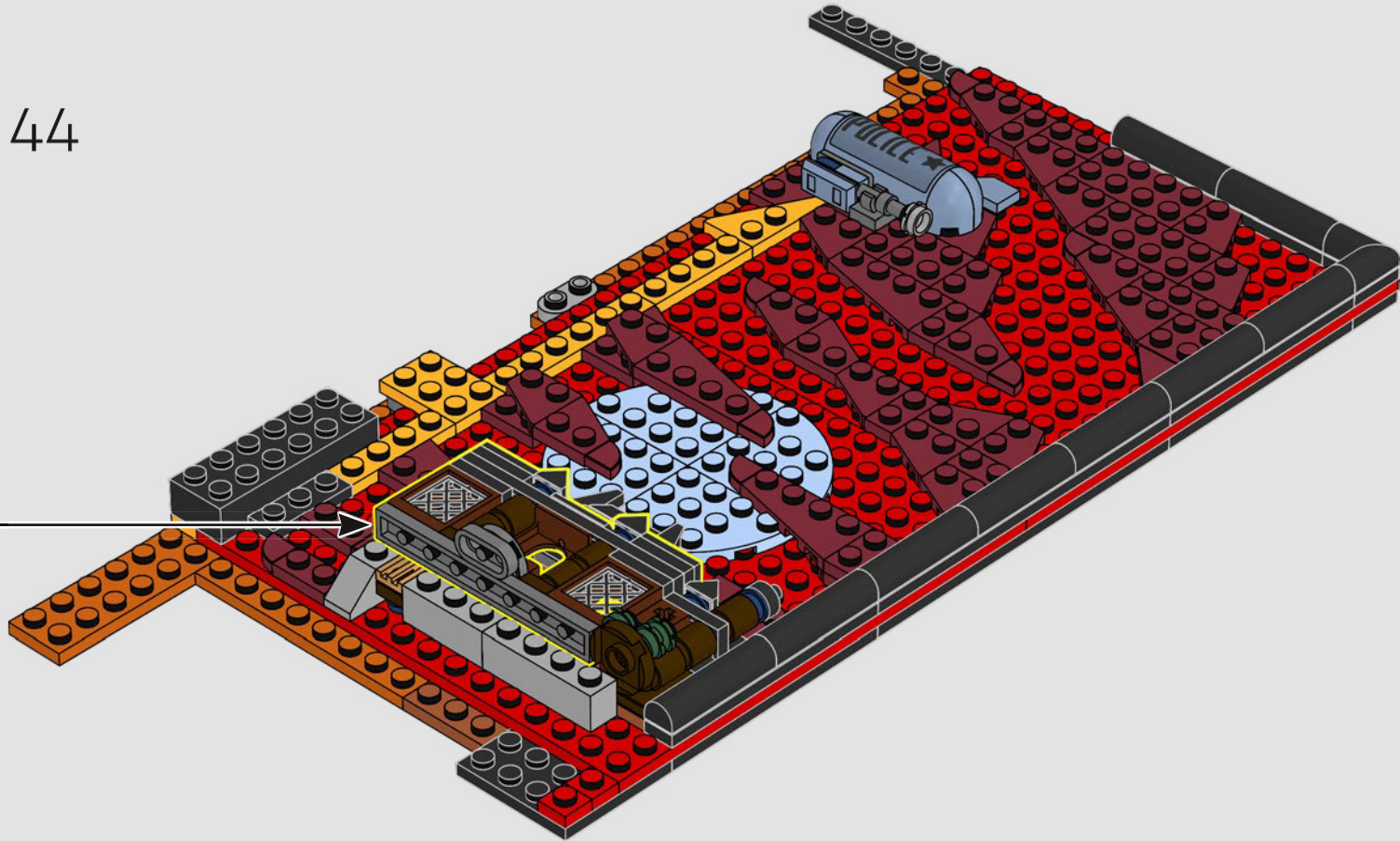

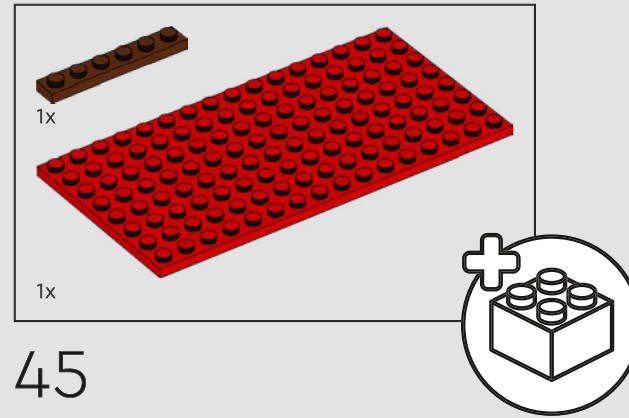
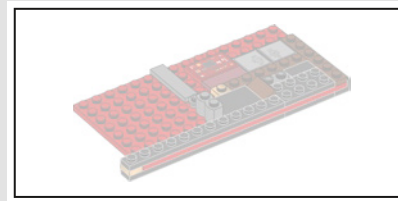
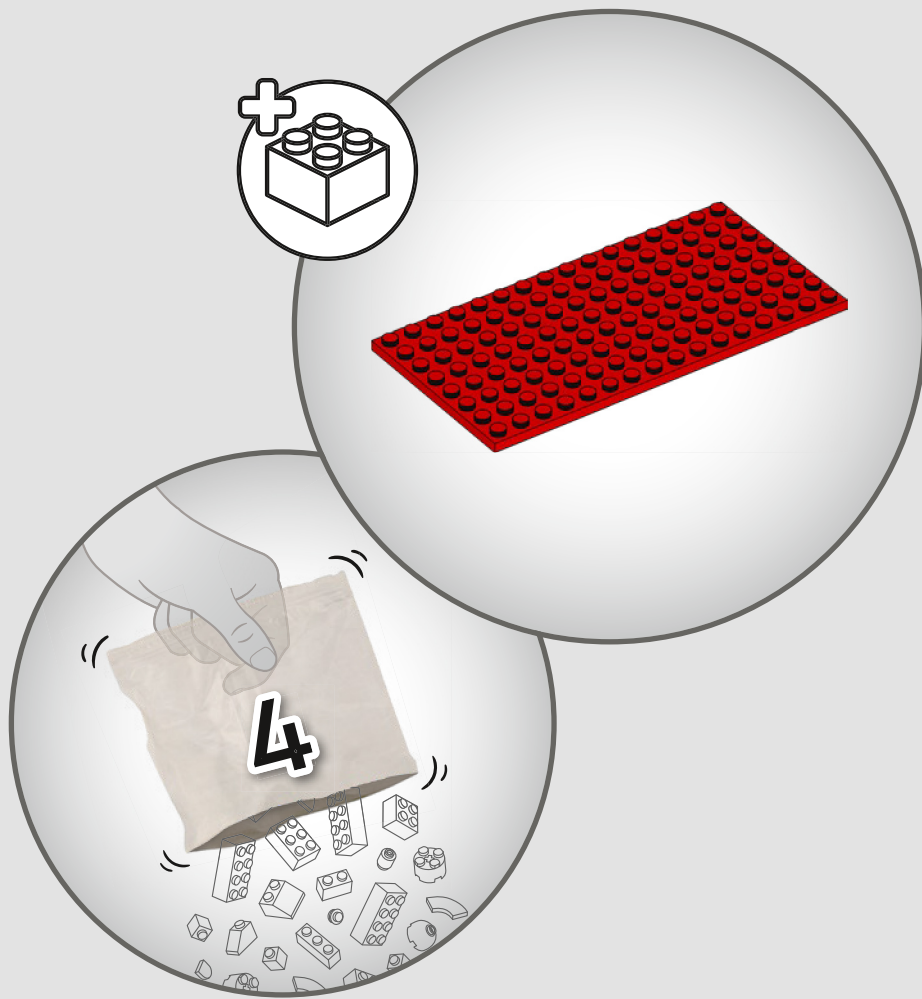

45

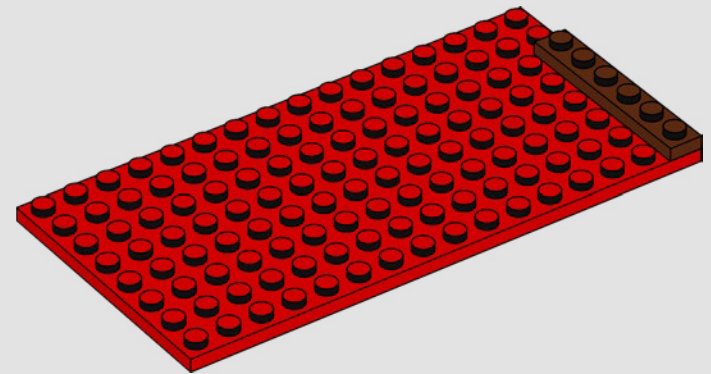

Episode: *Shadow of the Bat: Part I*
Épisode : *Jeux d'ombres (1^{re} partie)*
Episodio: *La sombra del murciélago: Parte 1*

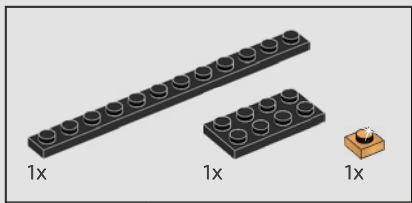

46

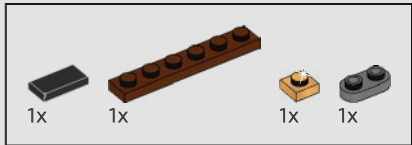
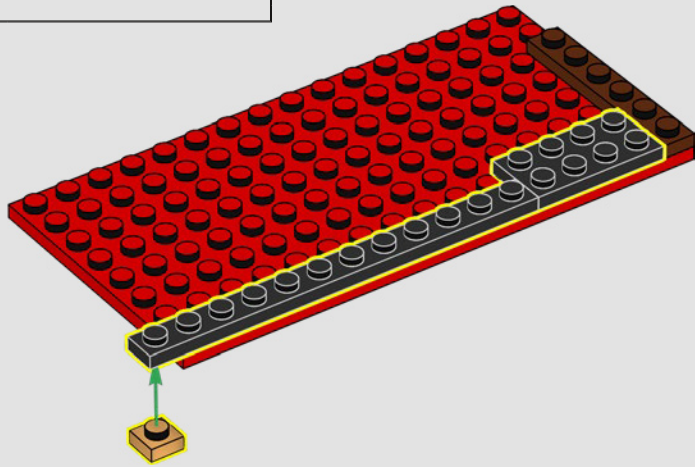

47

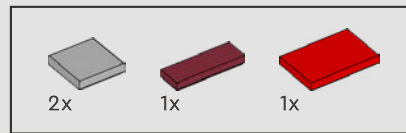
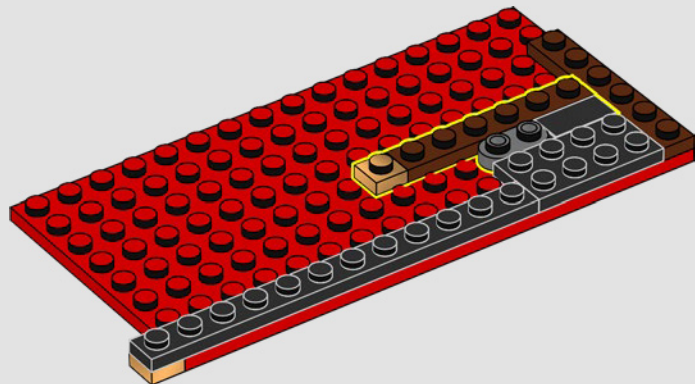

48

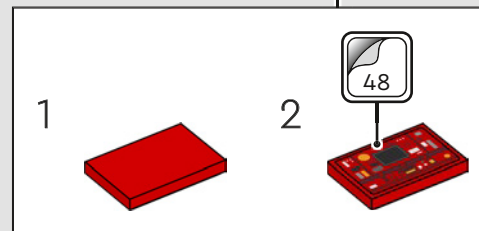
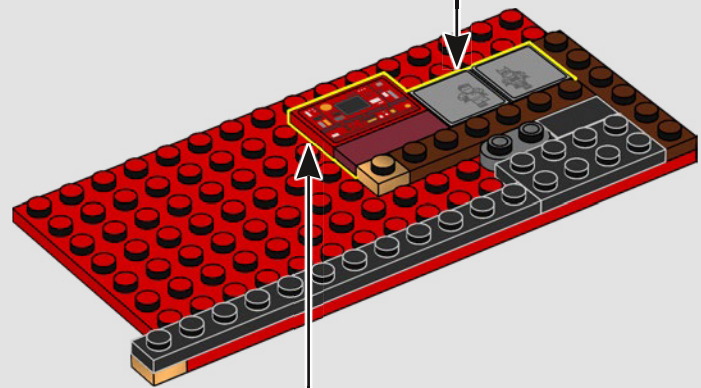
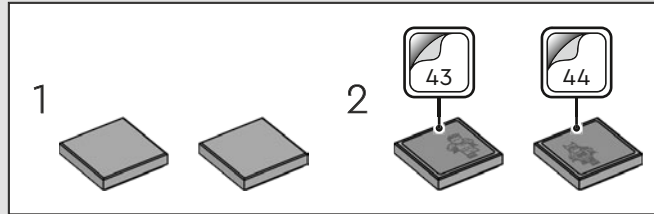

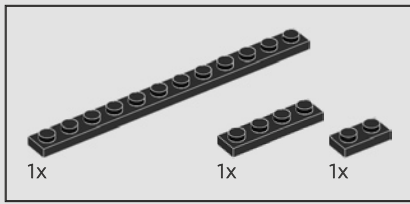

49

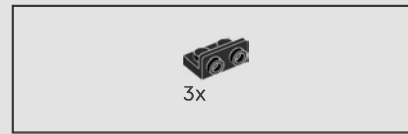
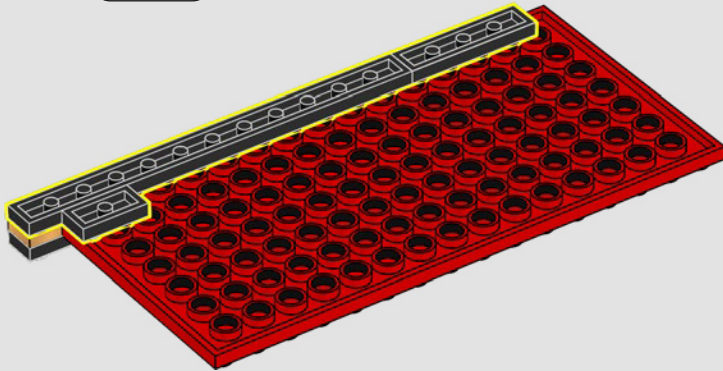

50

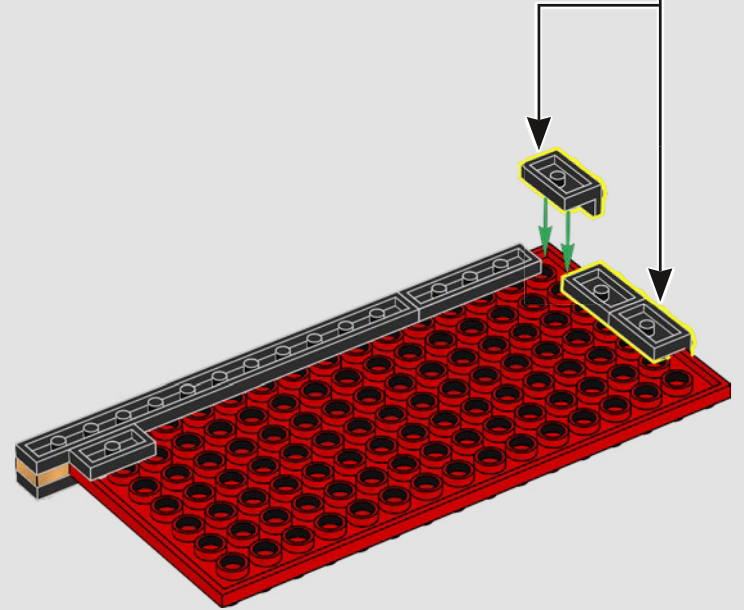

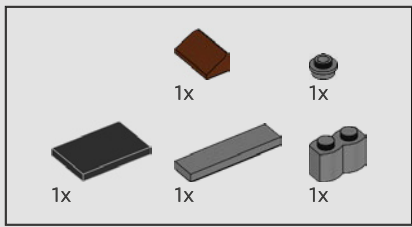

51

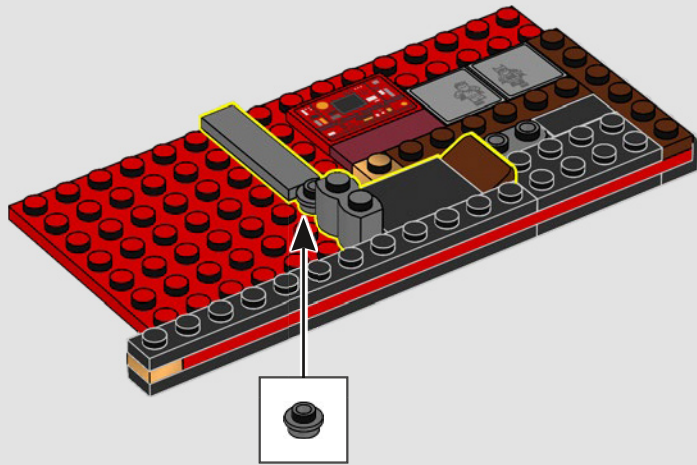

52

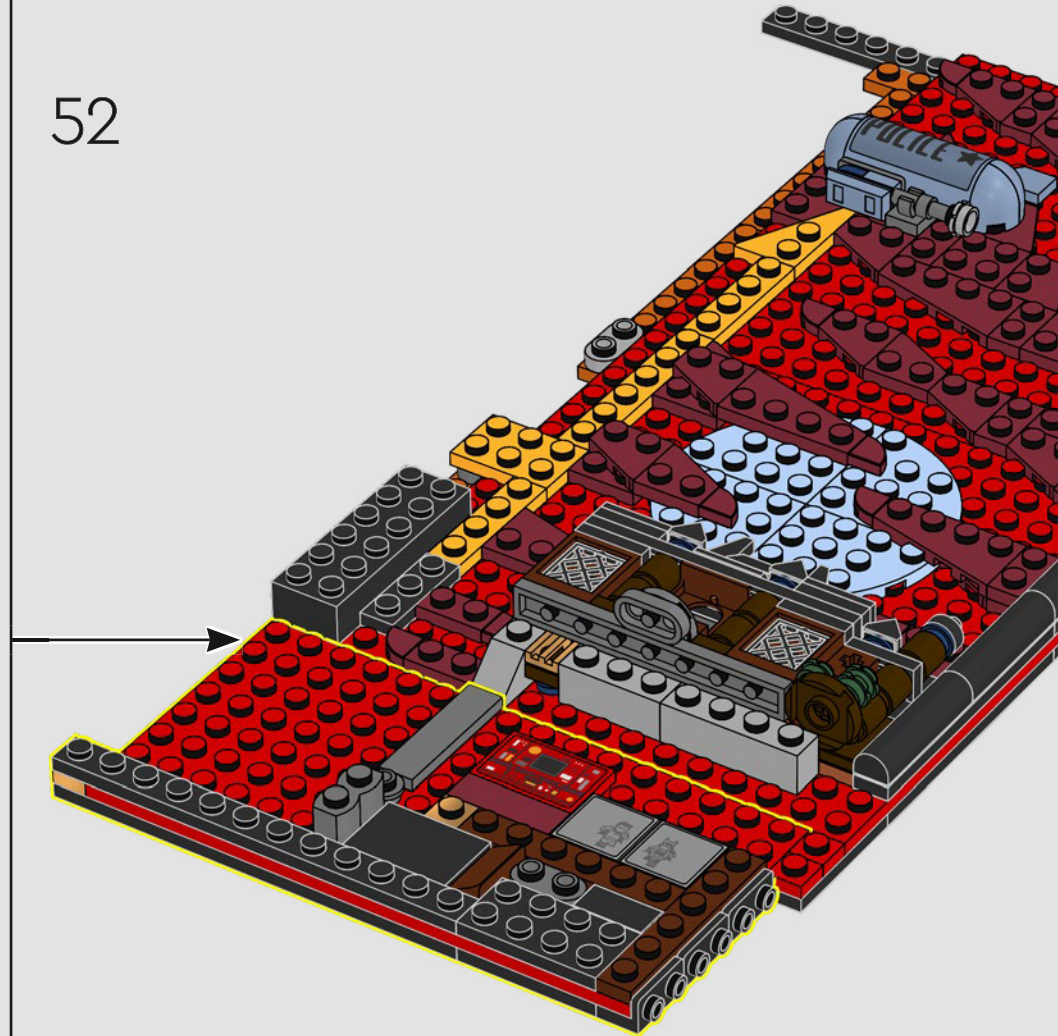

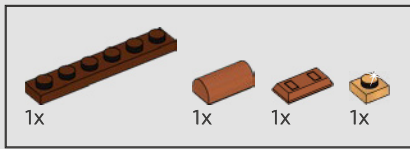

53

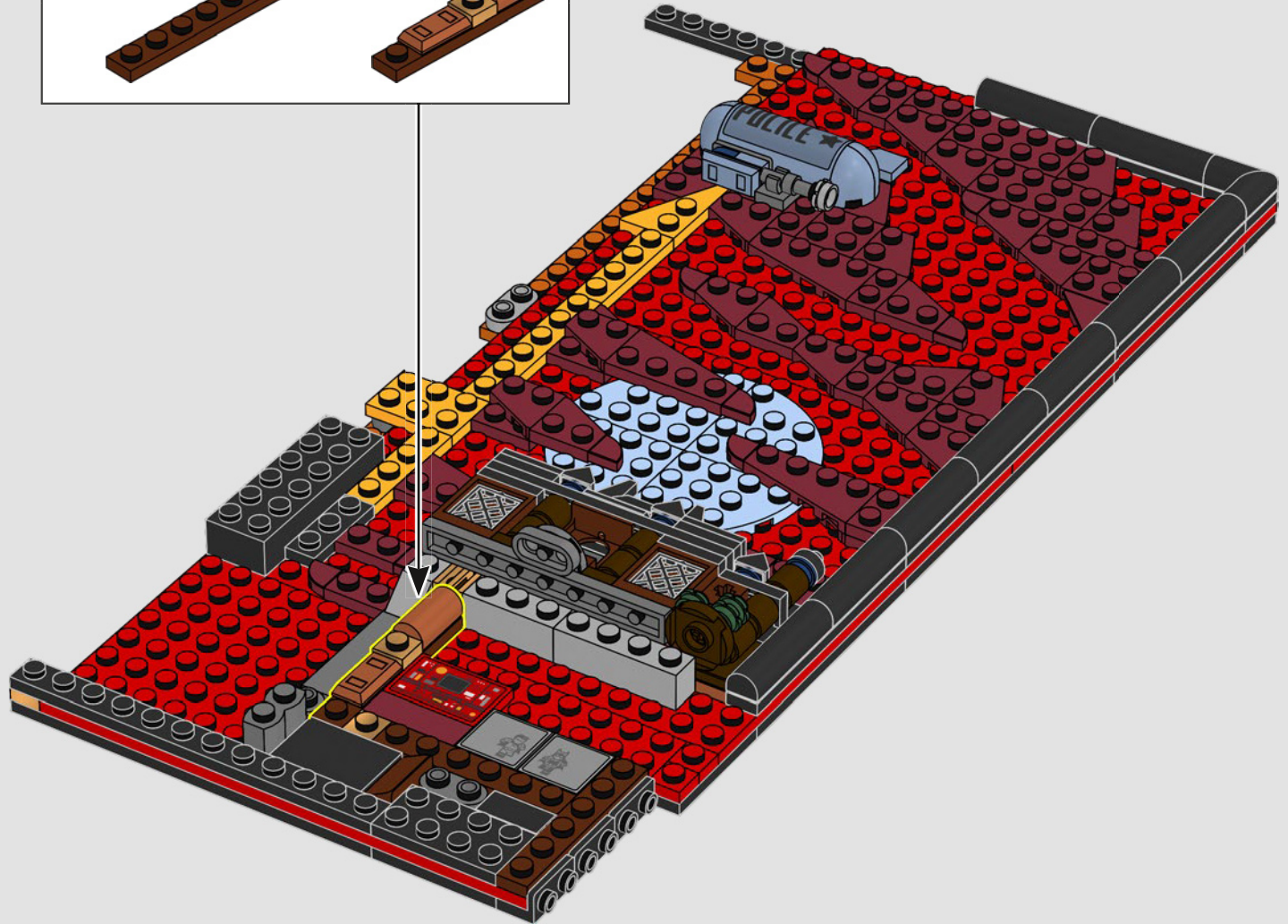
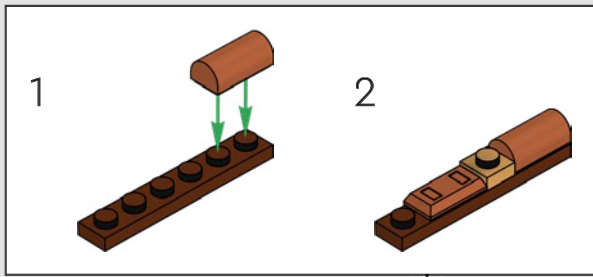

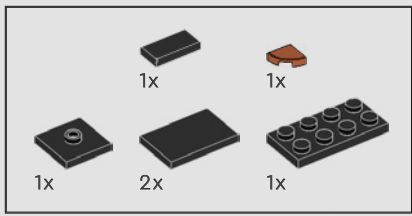

54

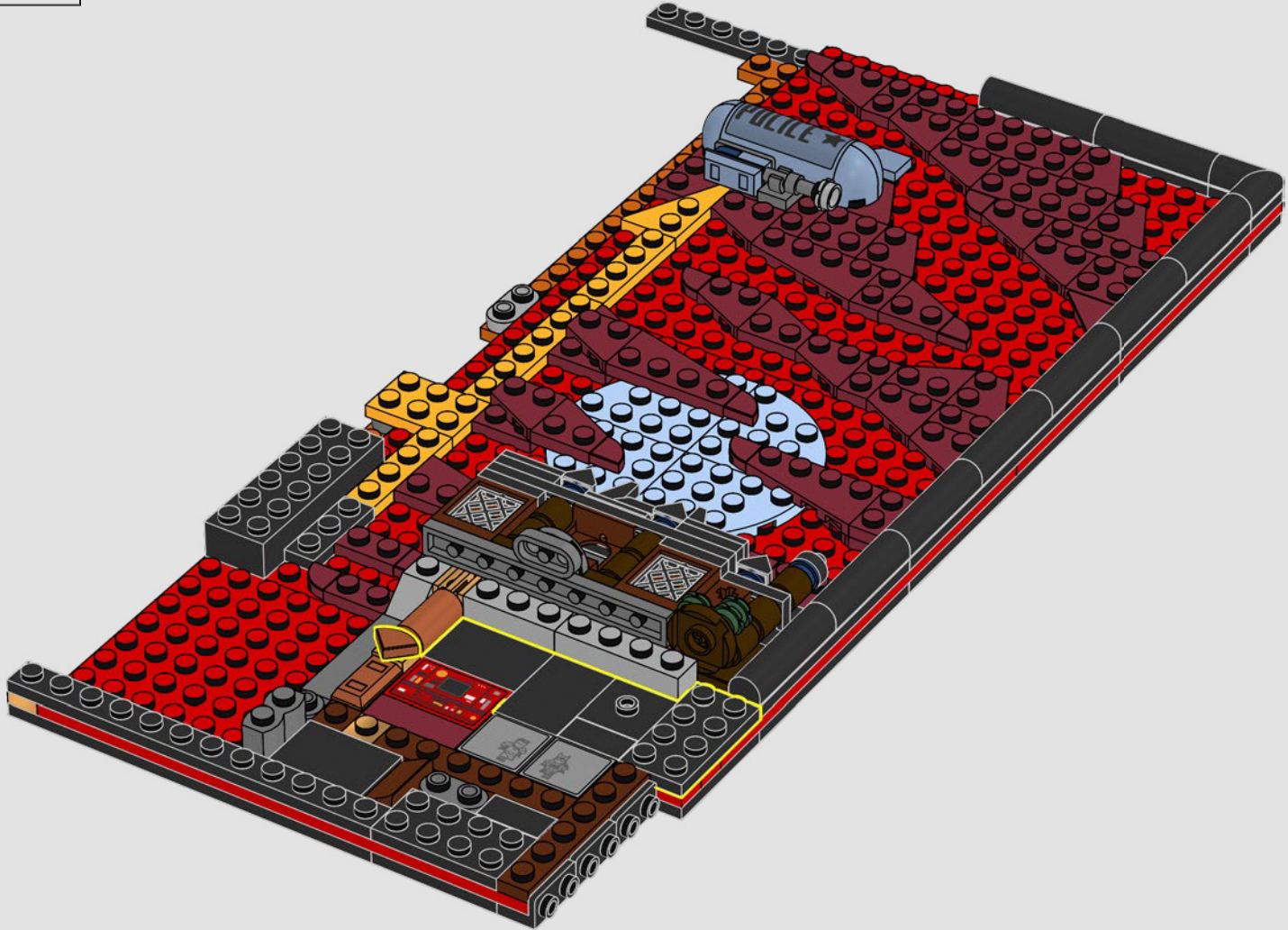

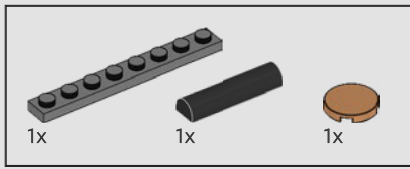

55

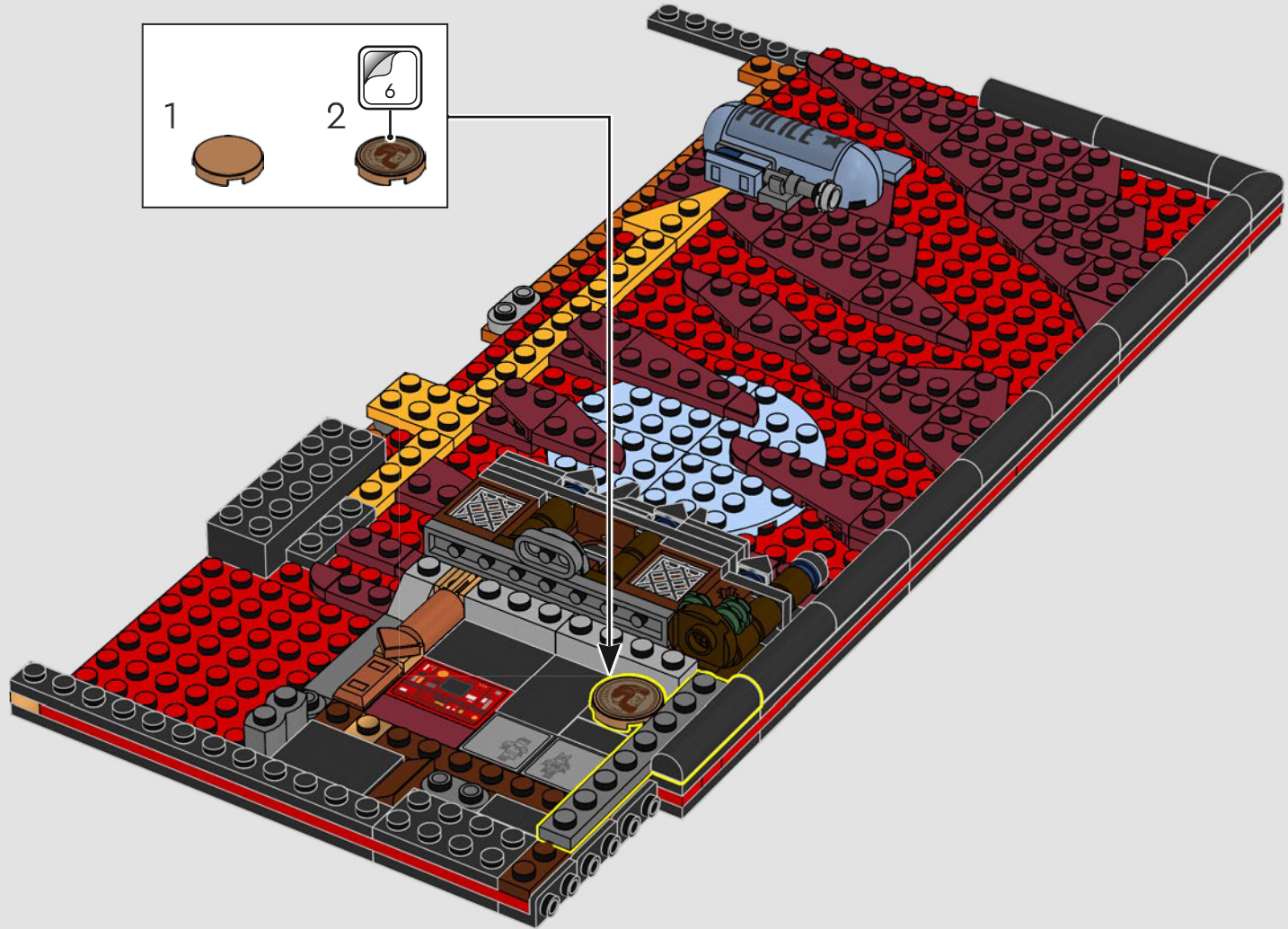
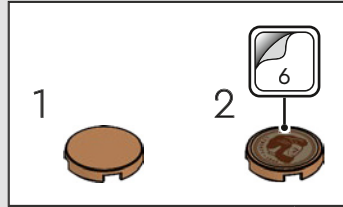

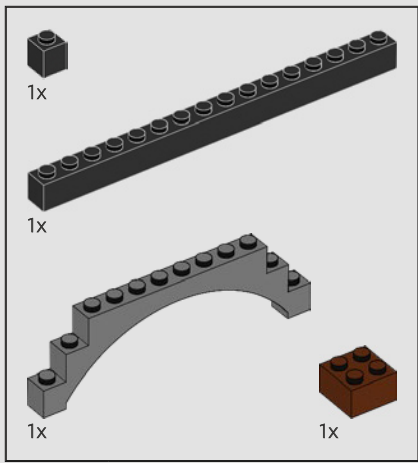

56

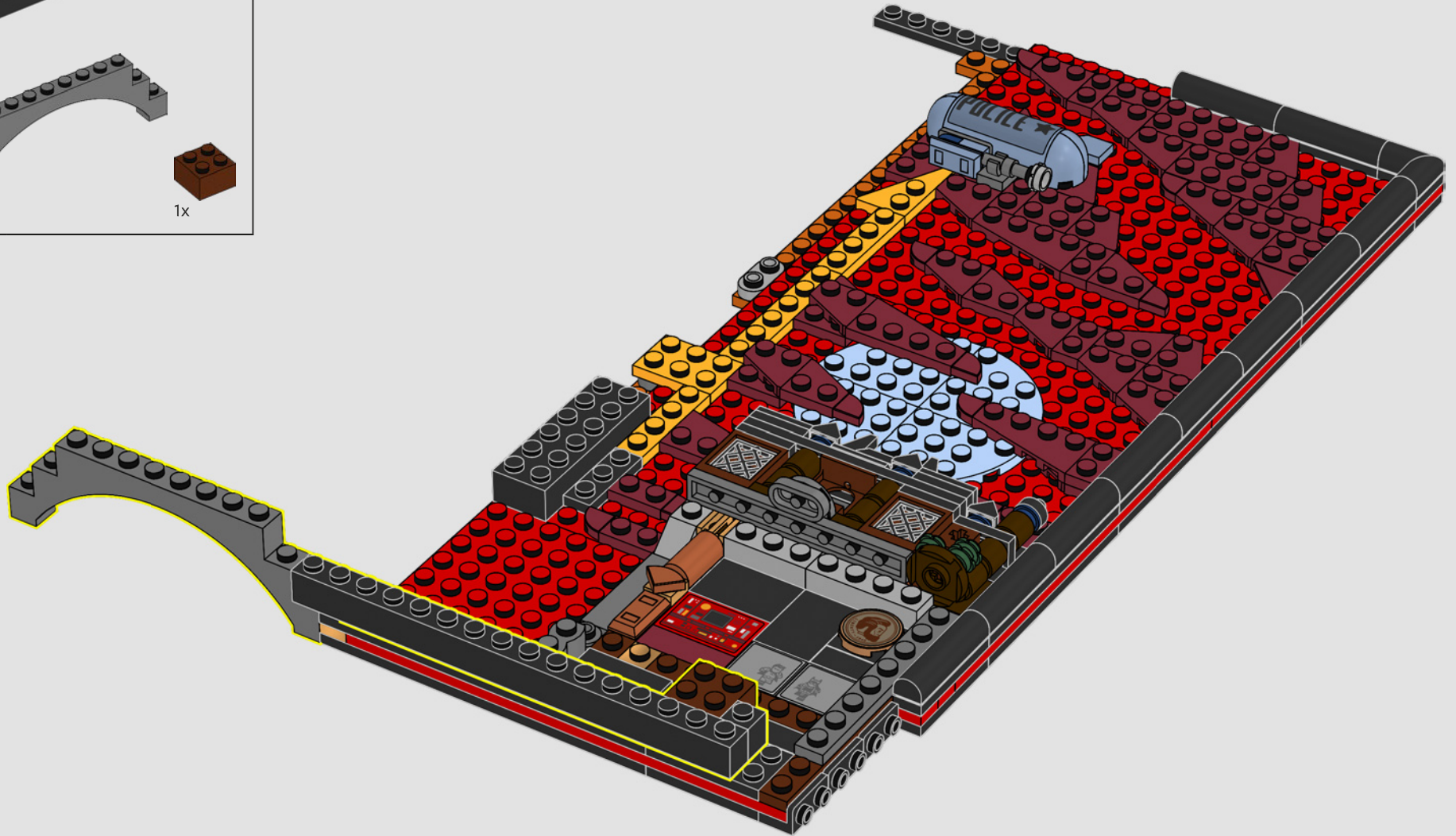

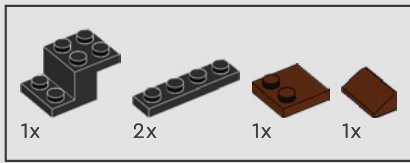

57

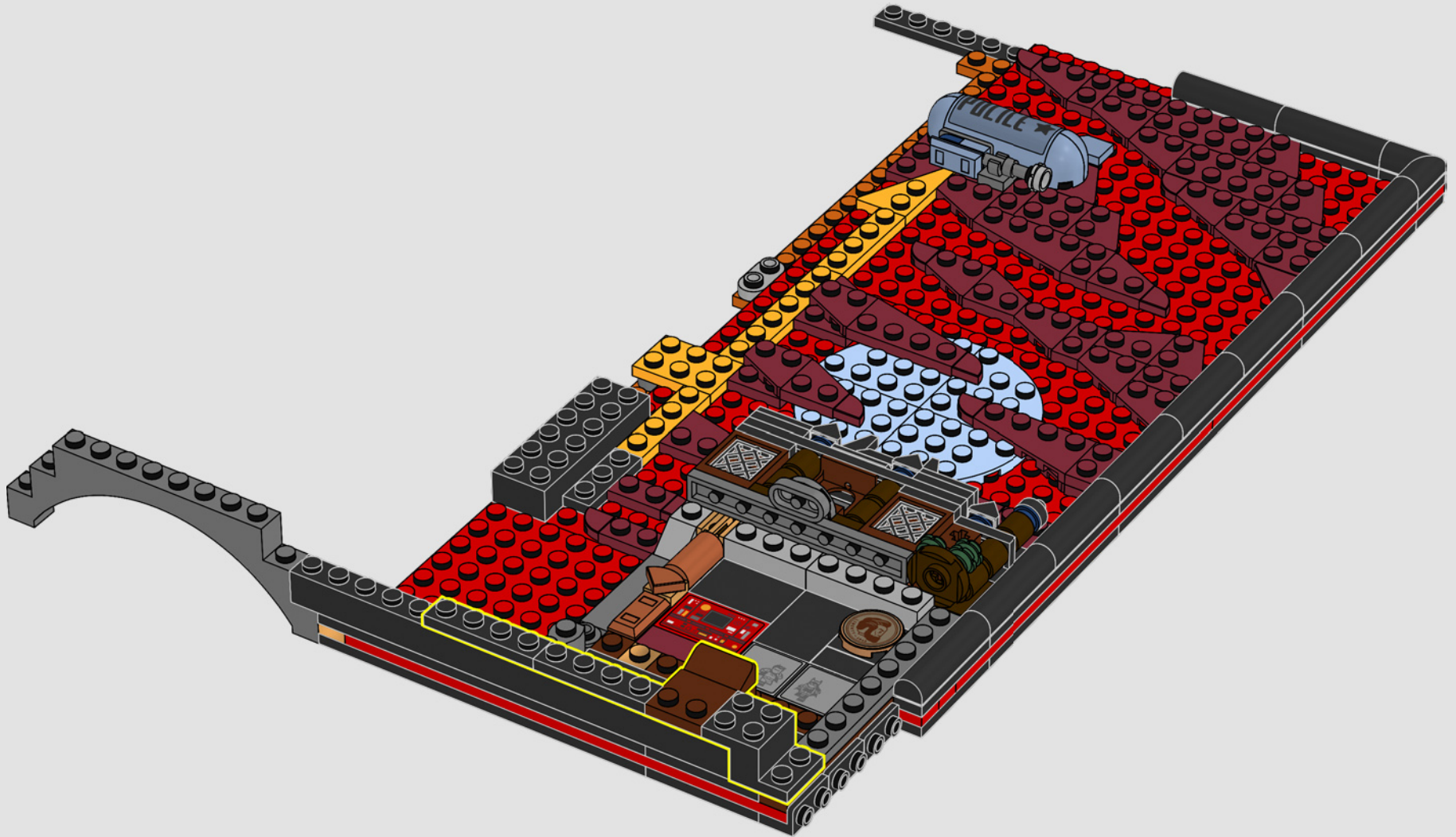

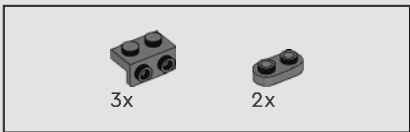

58

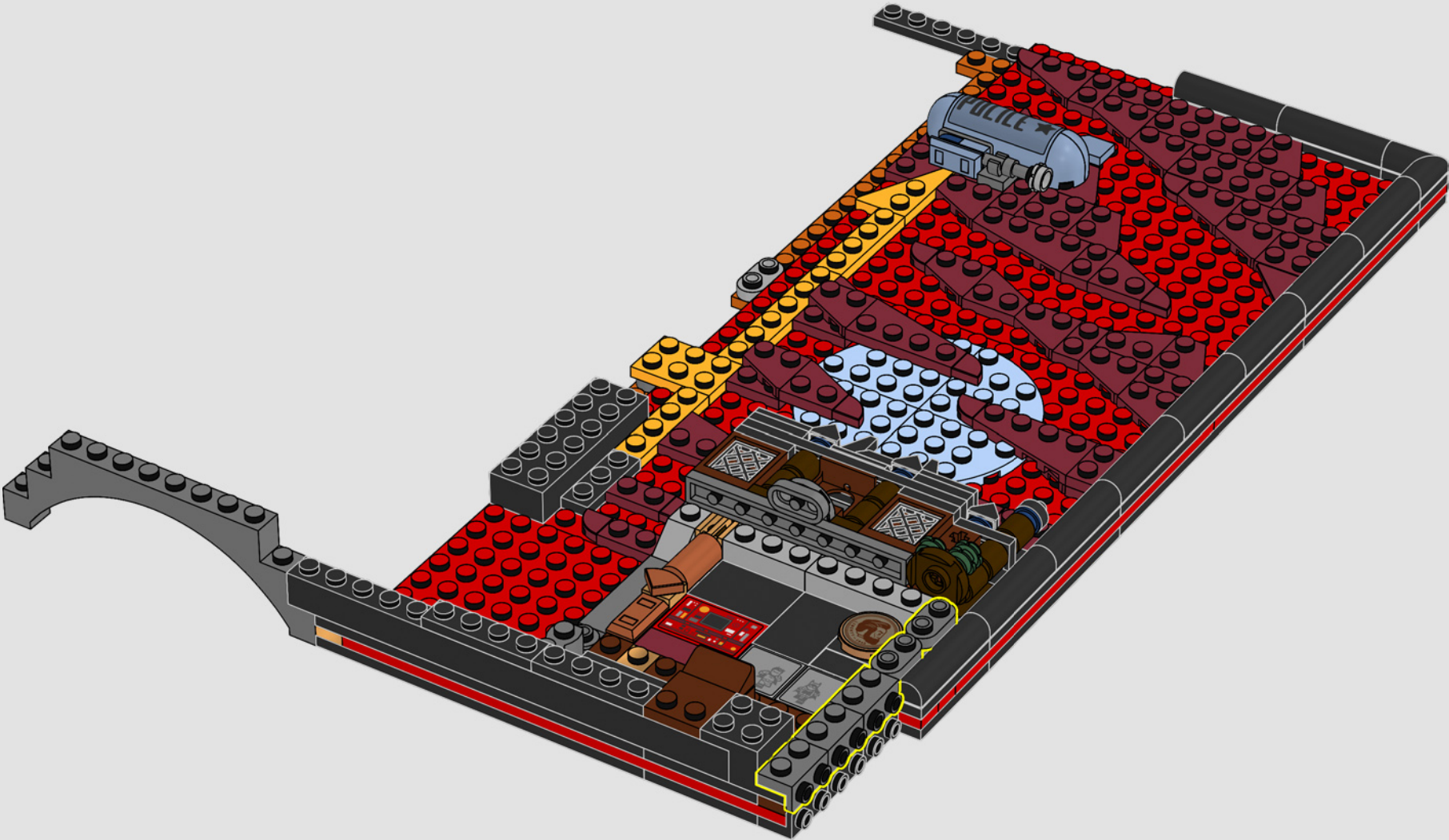

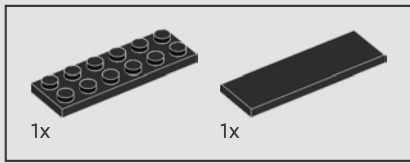

59

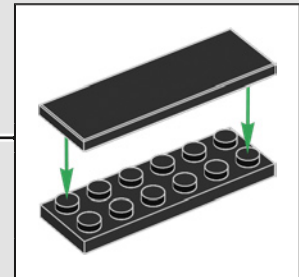
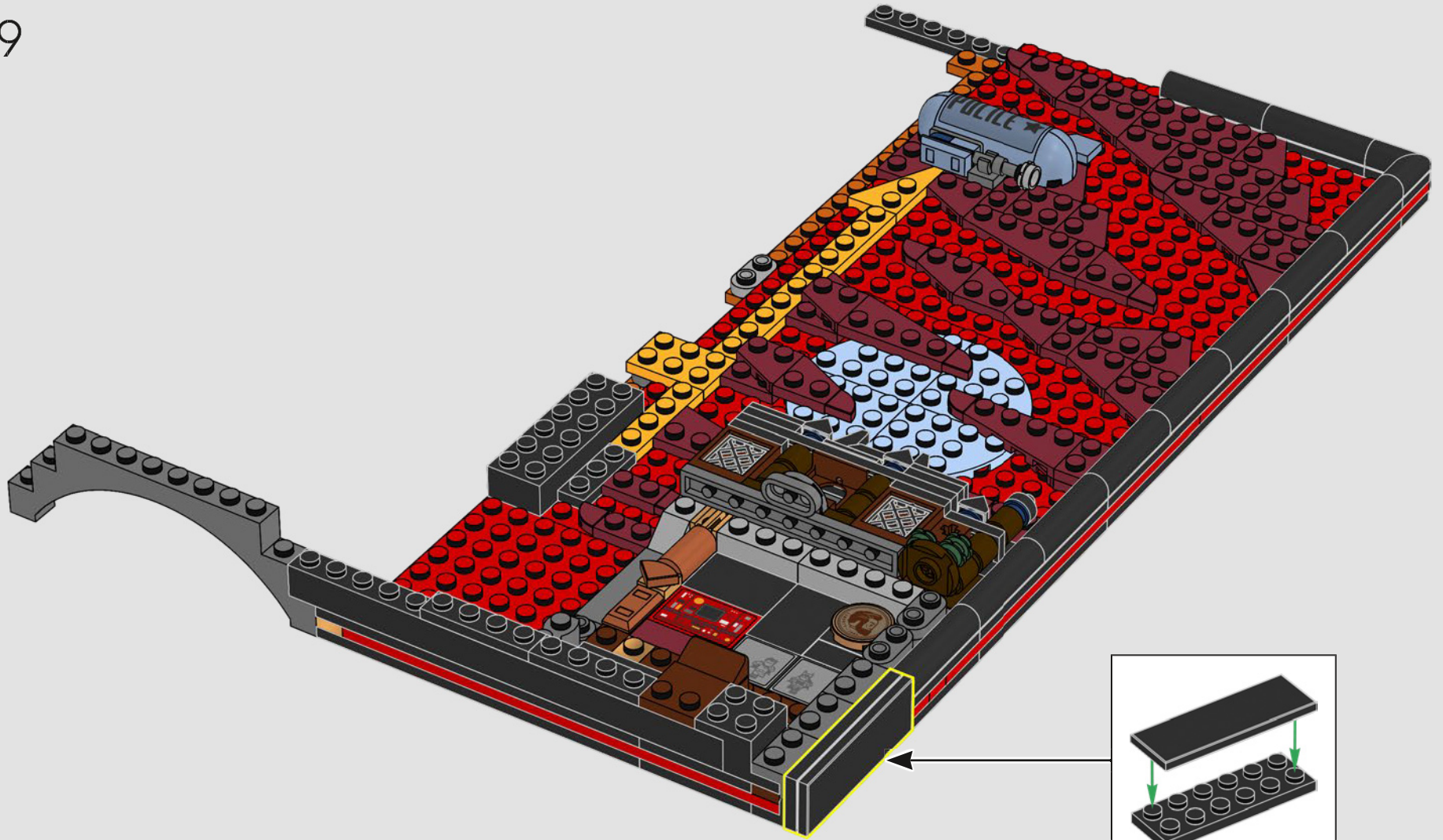

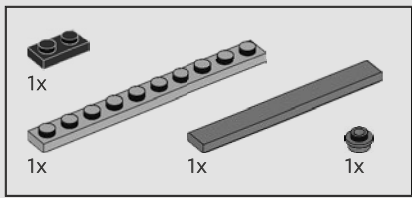

60

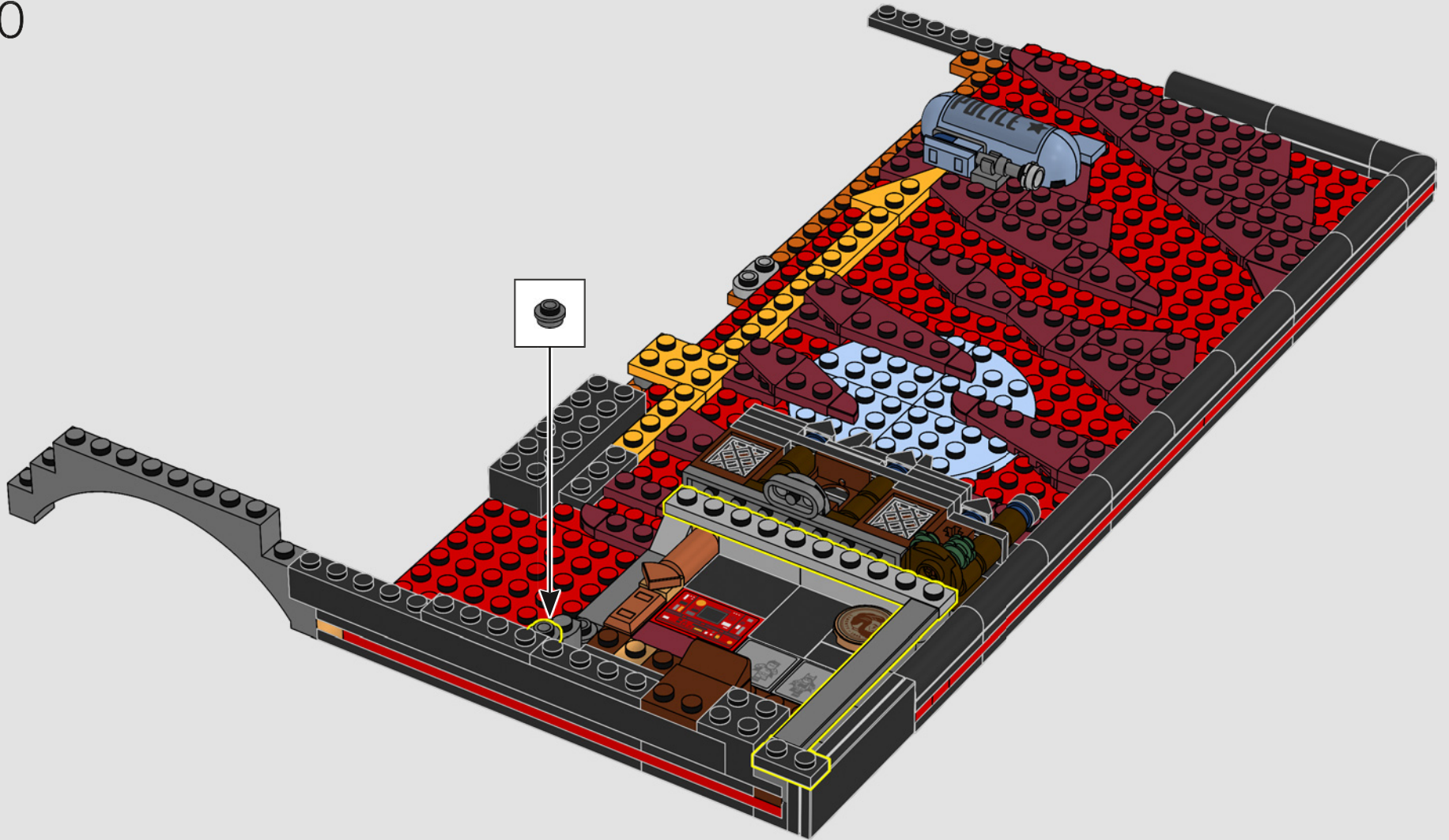

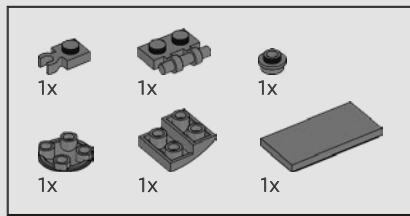

61

1

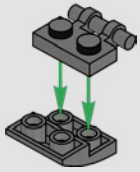

2

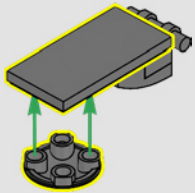

3

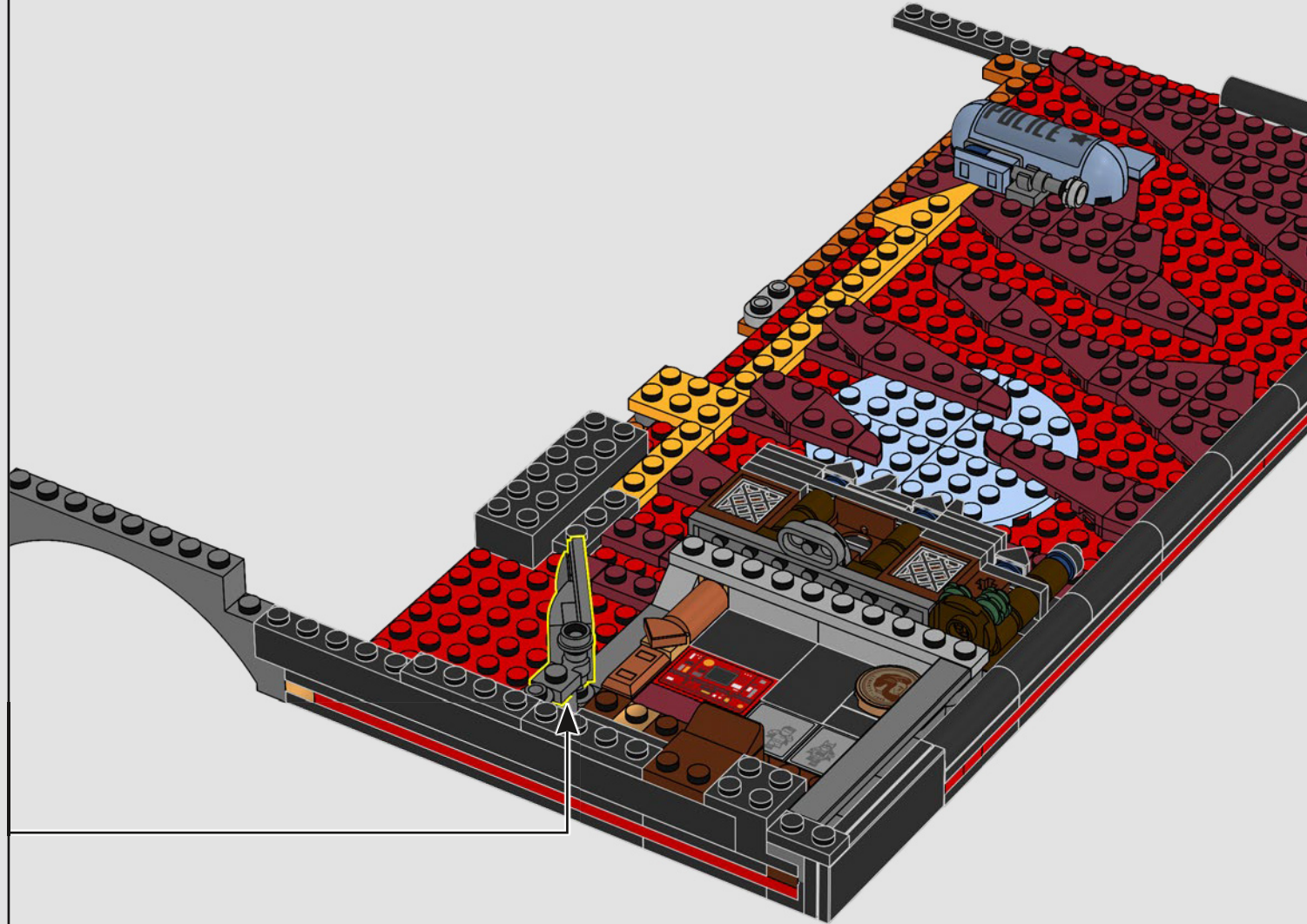
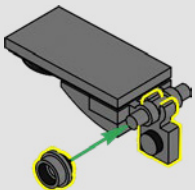

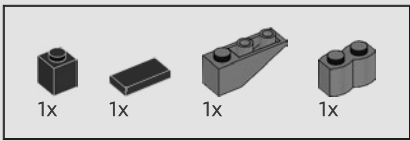

62

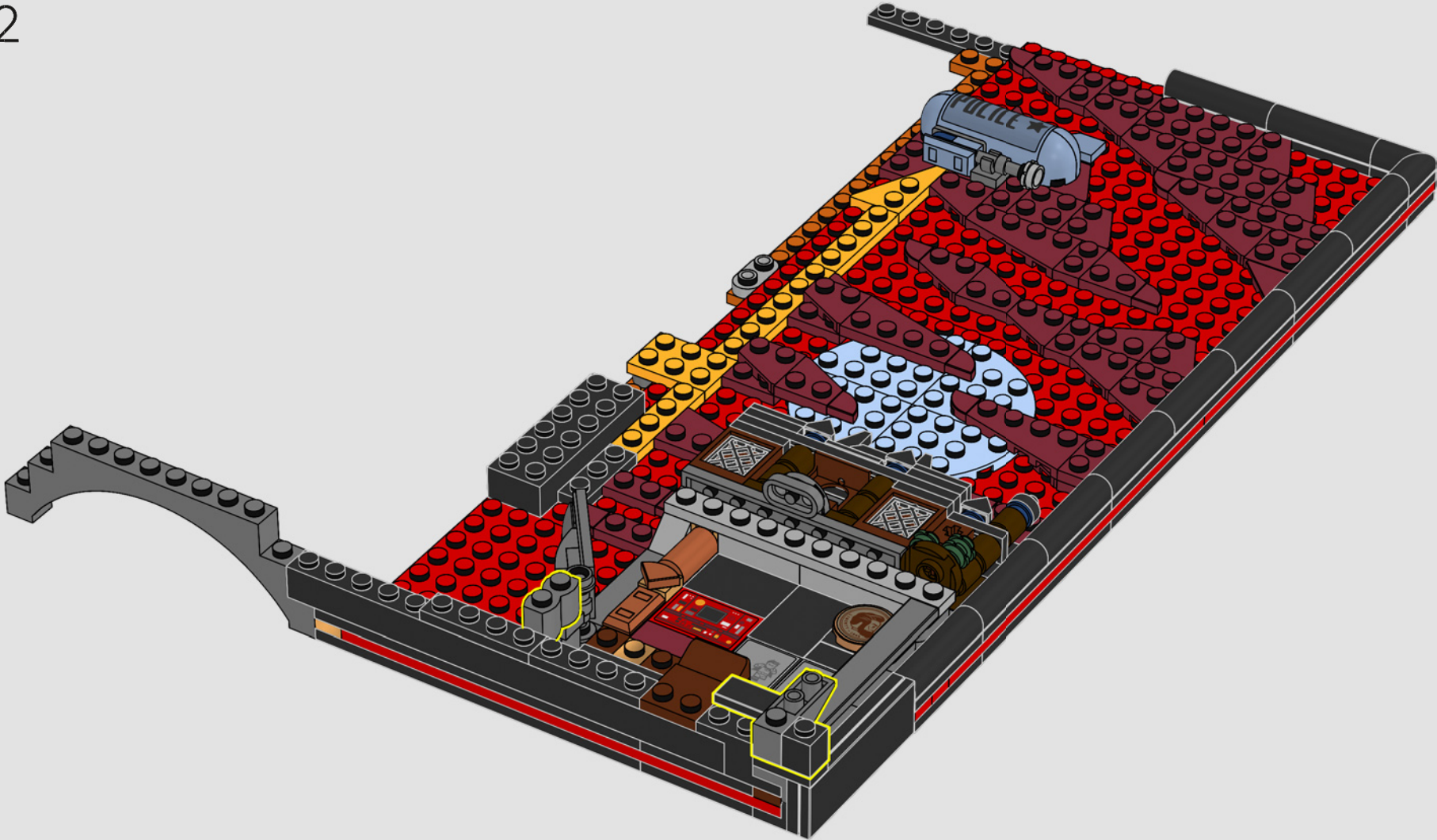

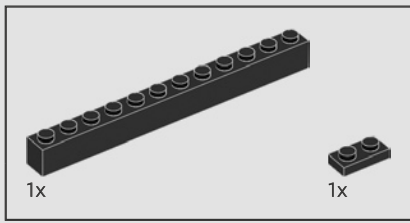

63

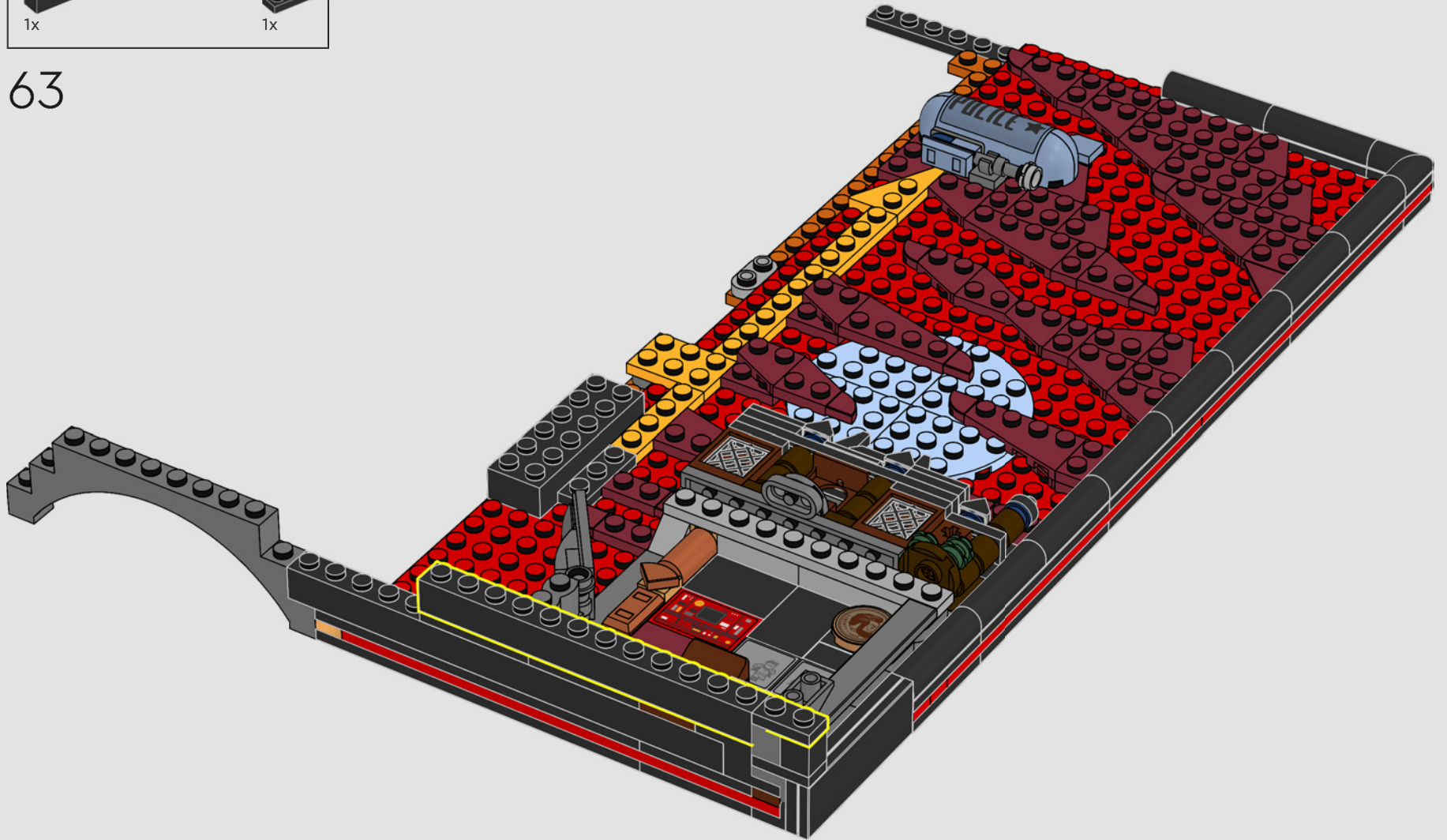

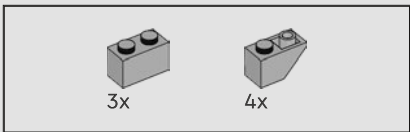

64

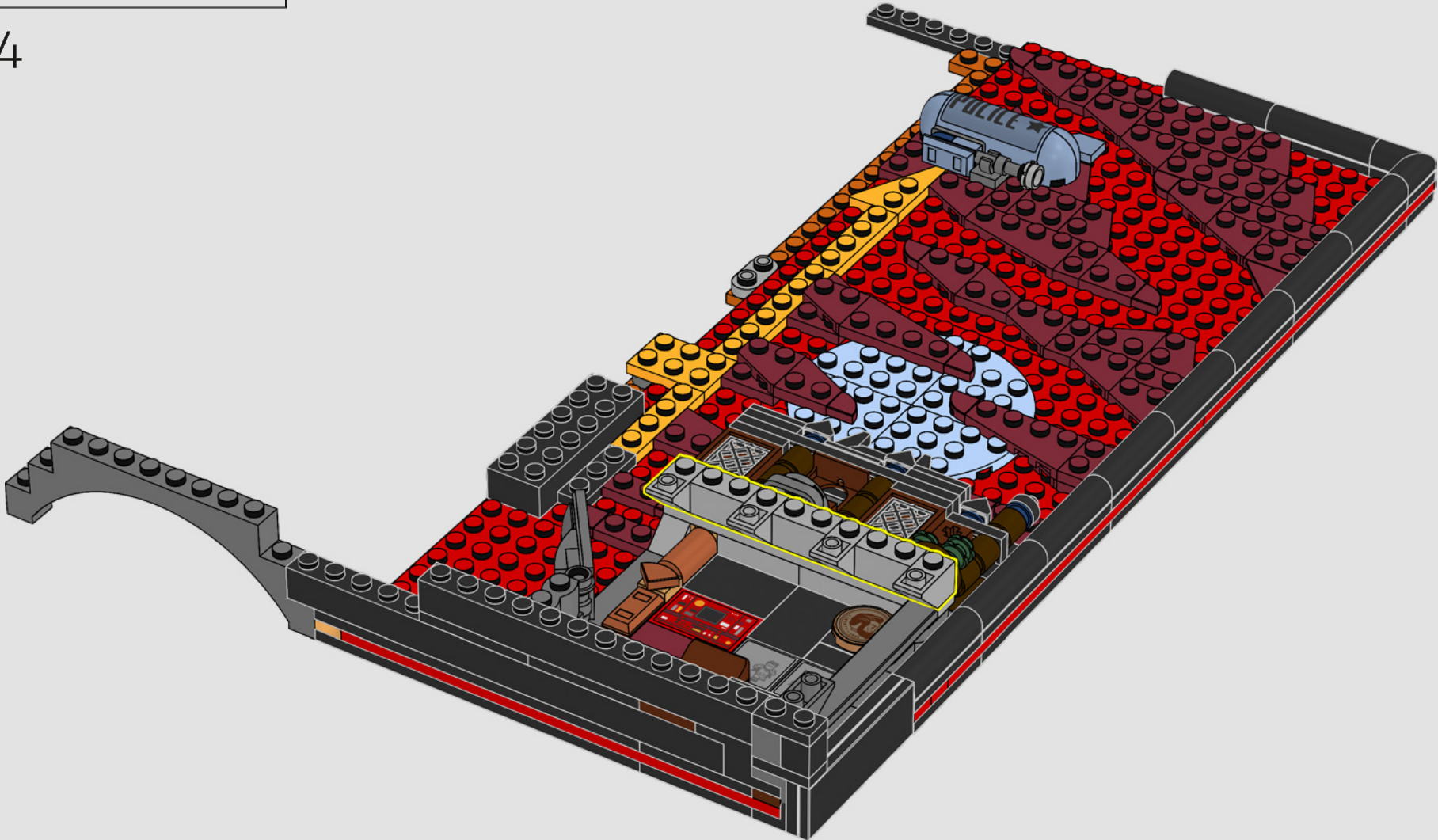

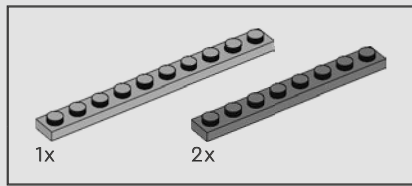

65

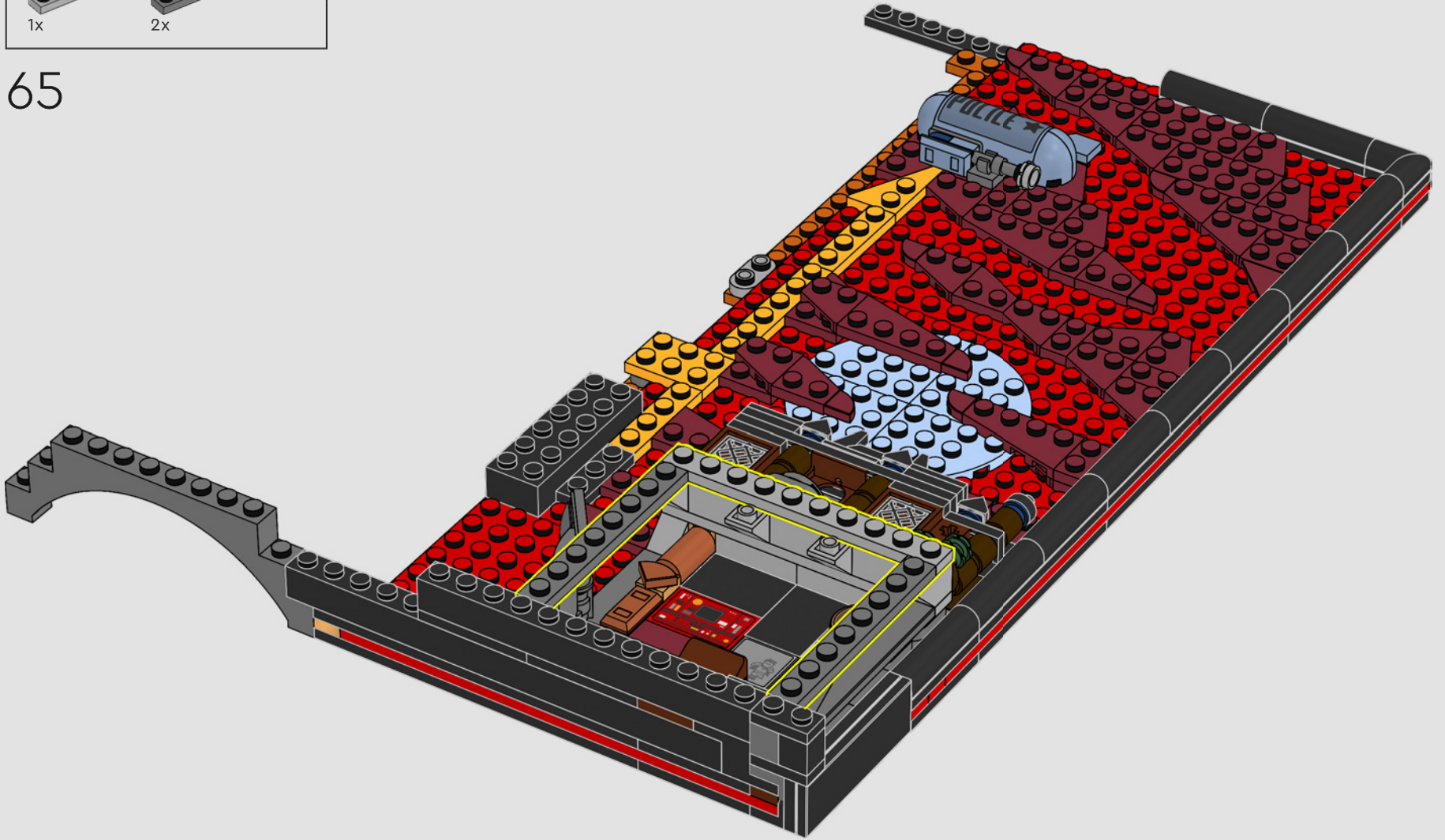

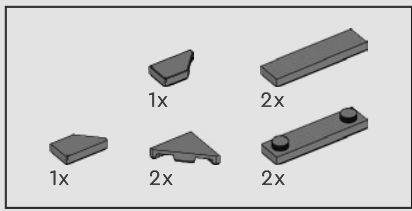

66

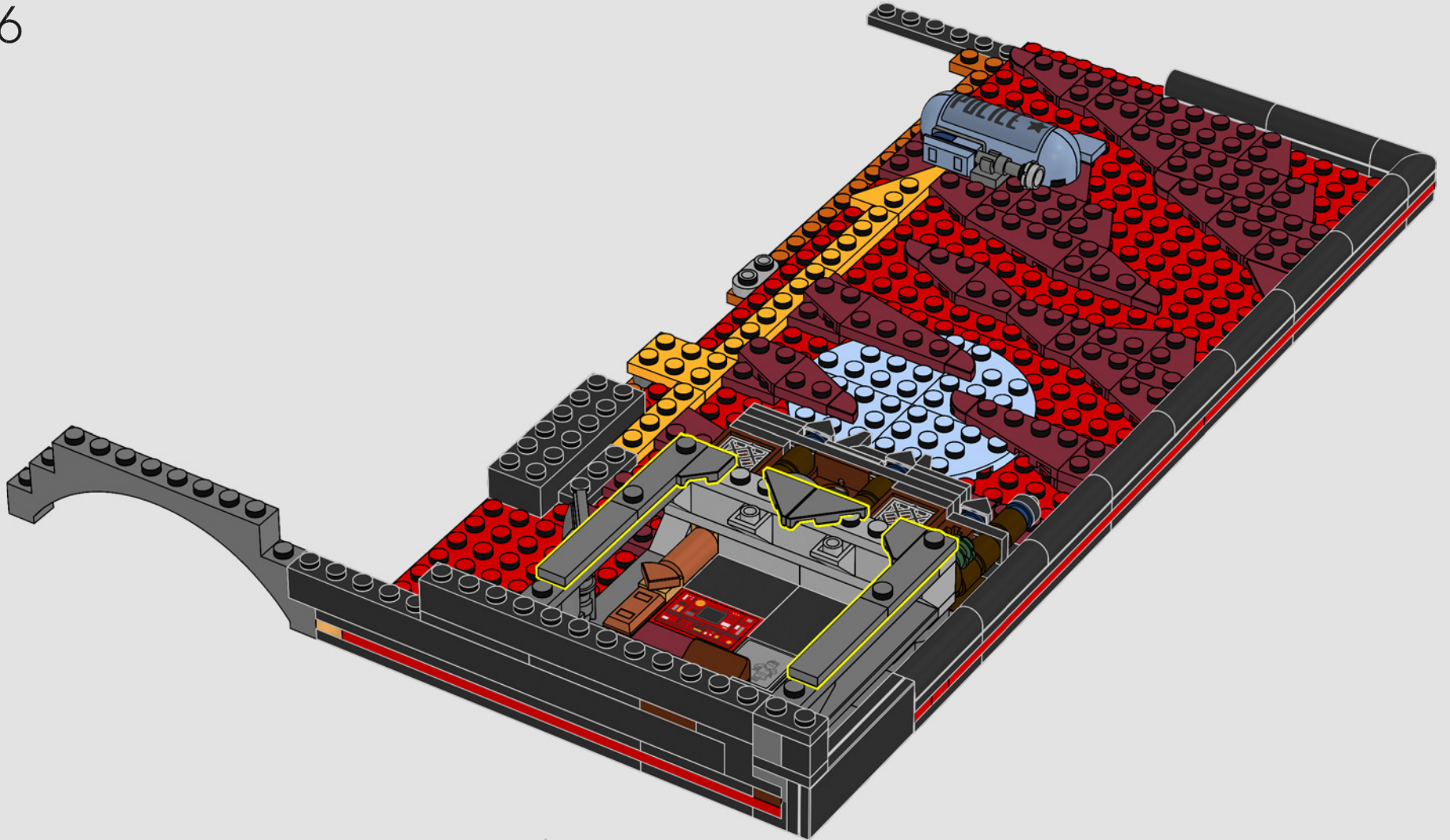

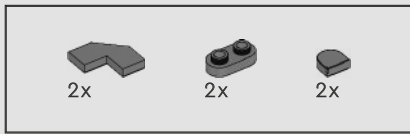

67

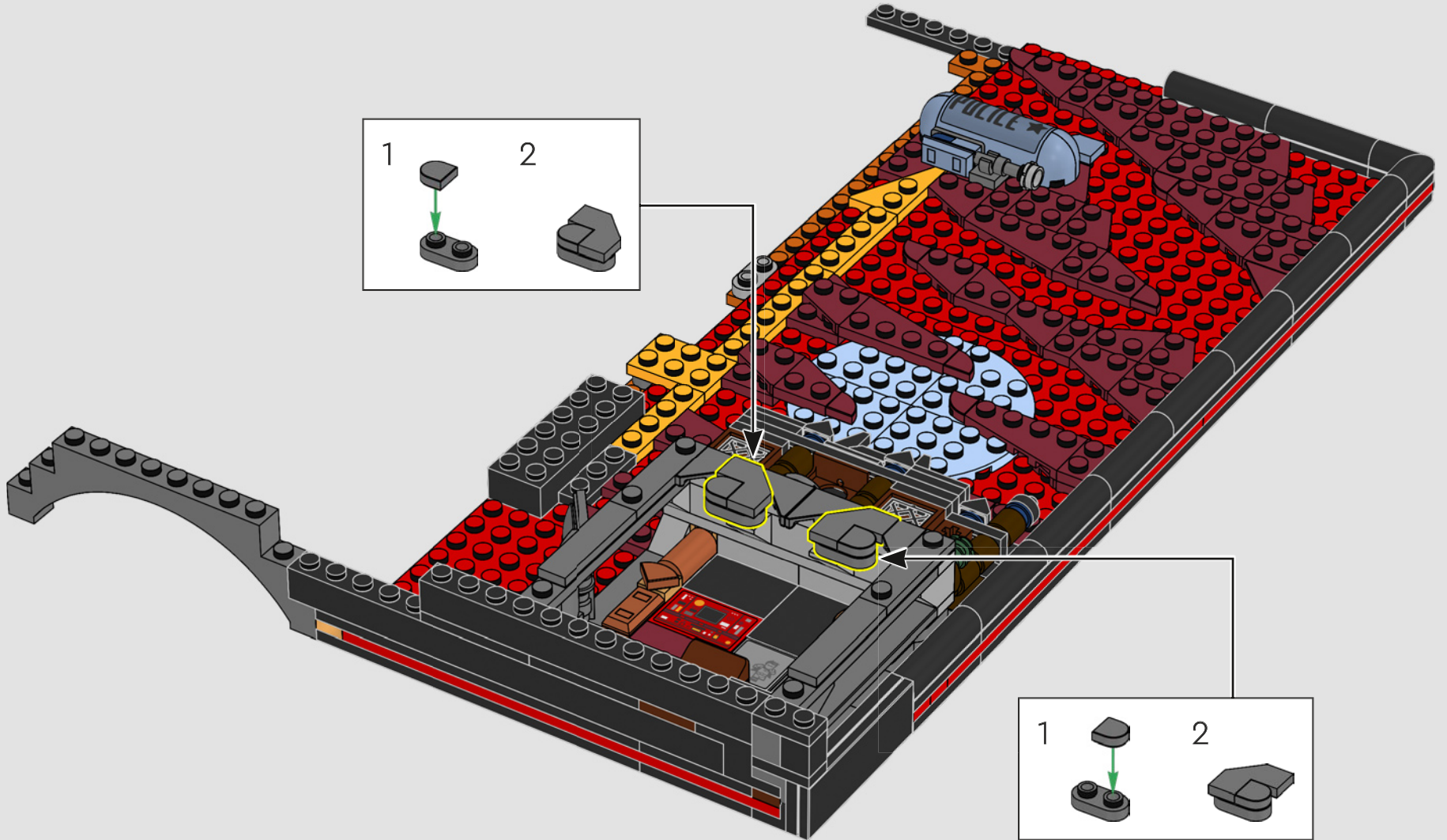

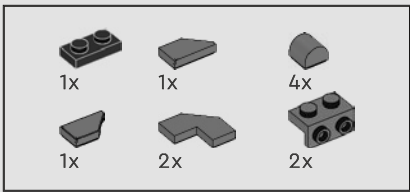

68

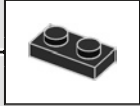
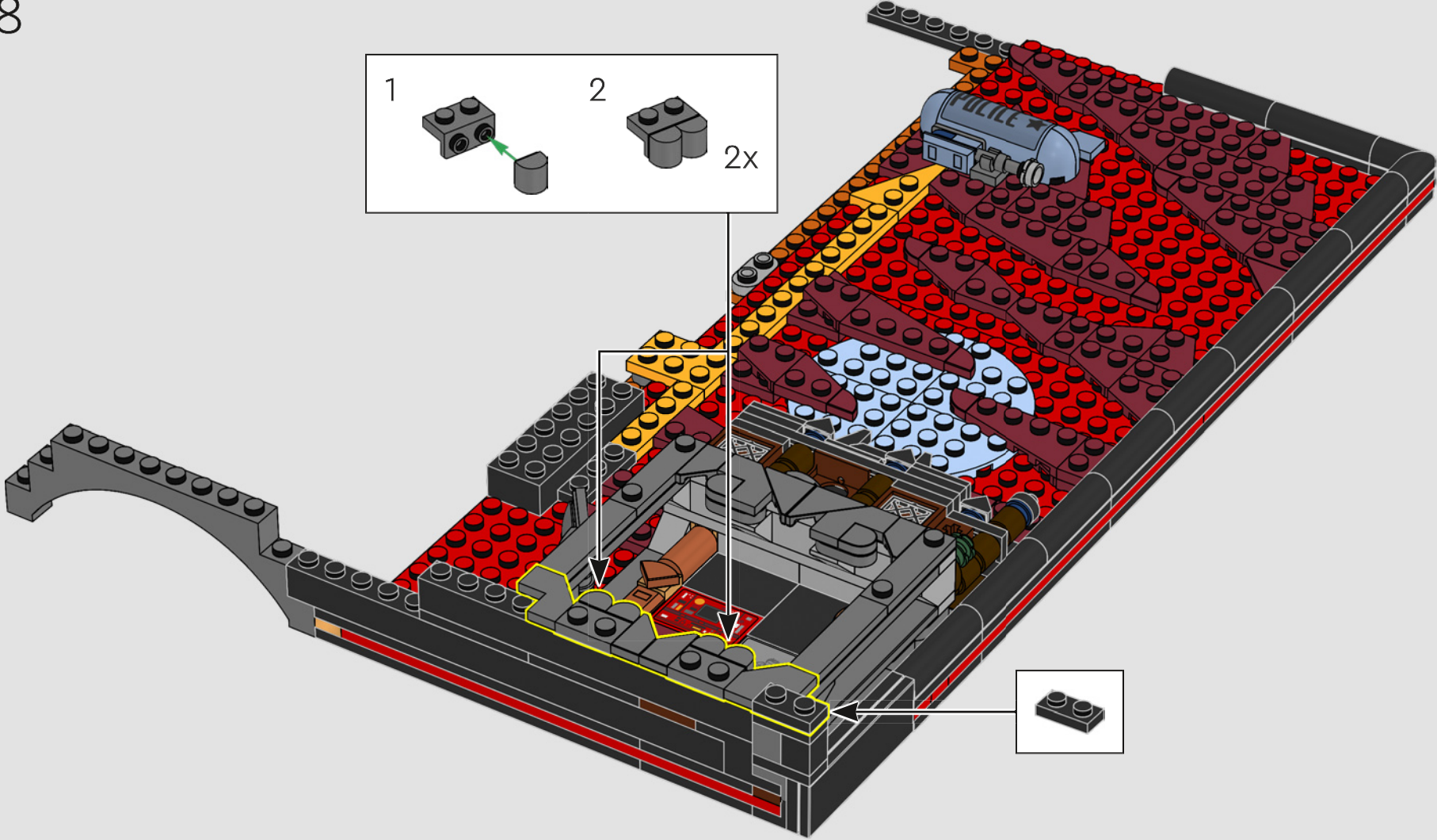
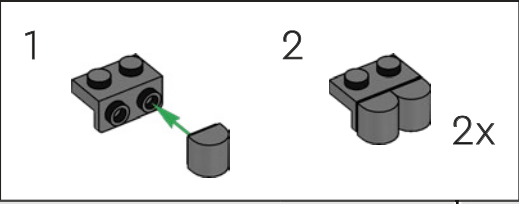

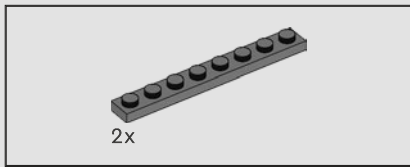

69

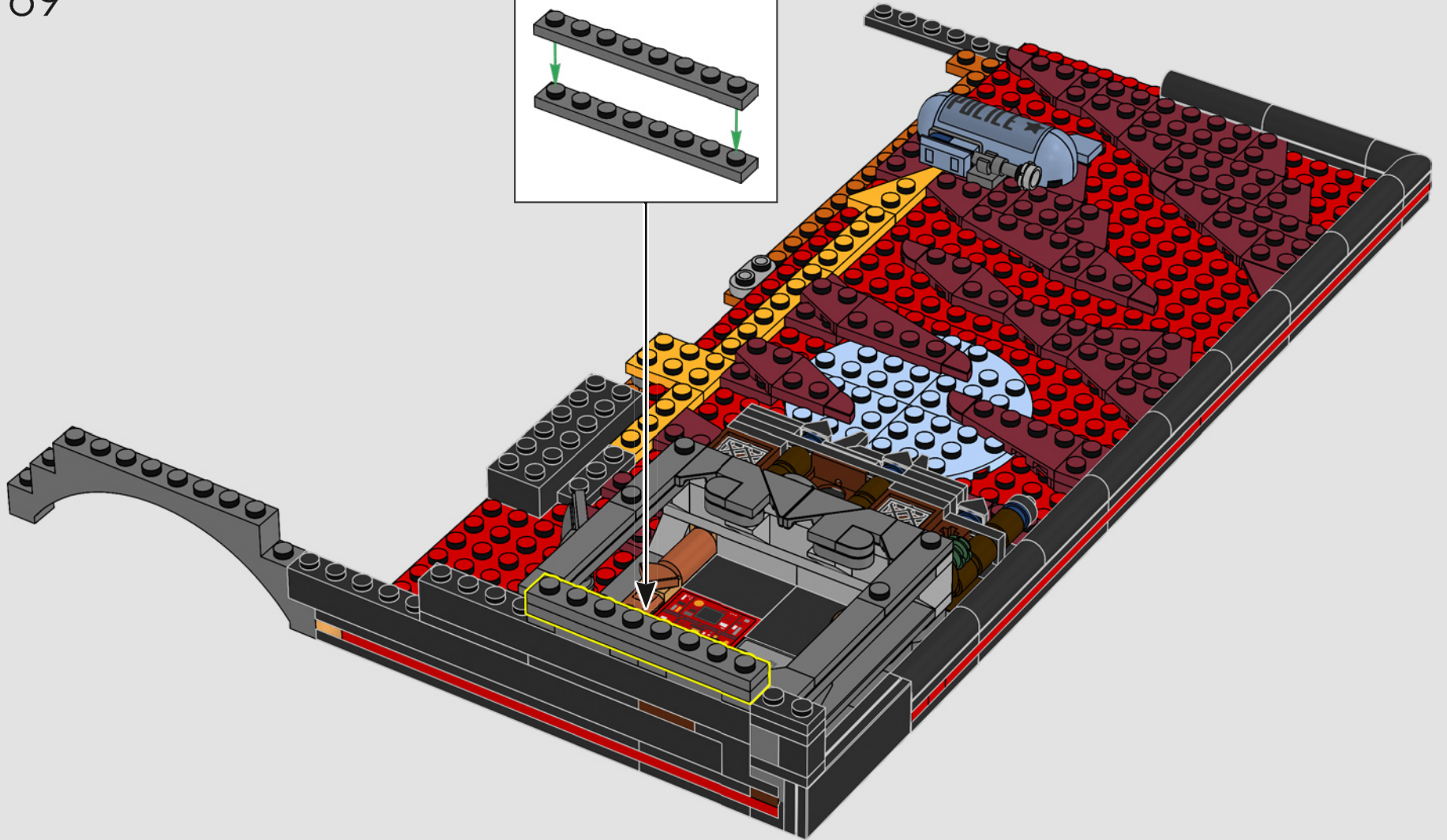
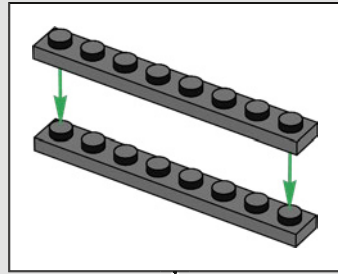

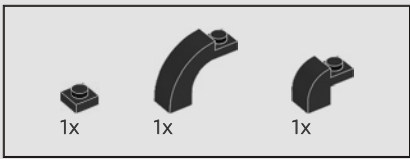

70

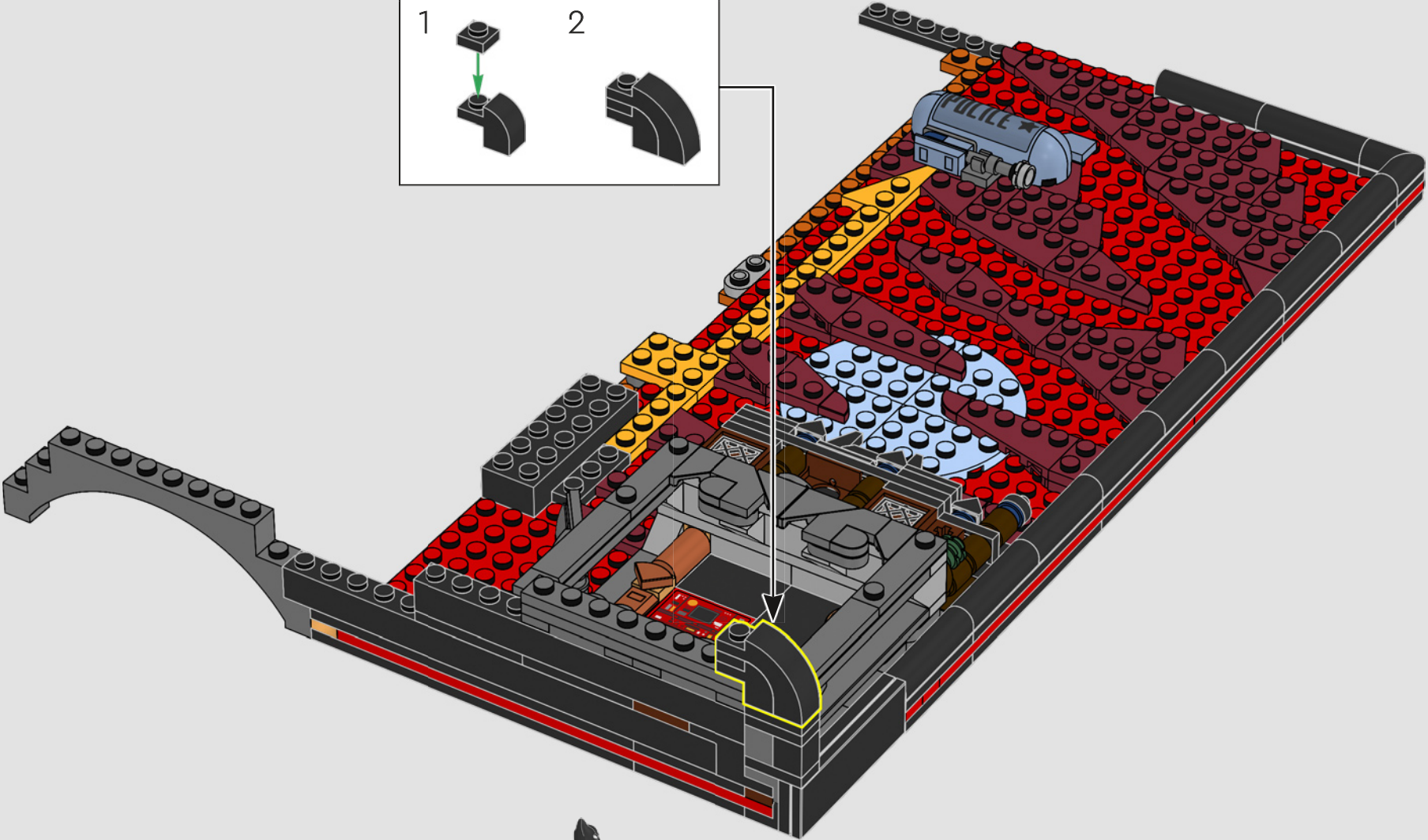
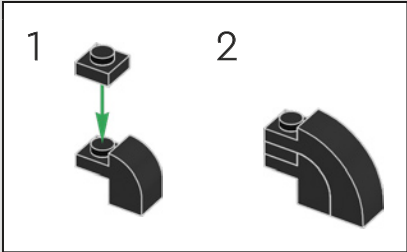

Episode: *The Mechanic*
Épisode : *Le super mécanicien*
Episodio: *El mecánico*

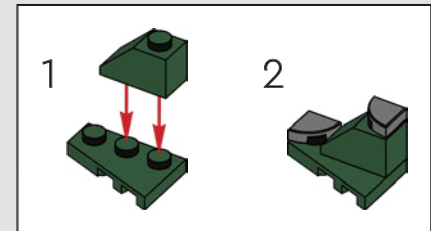
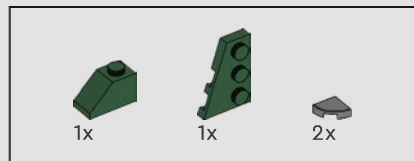

71



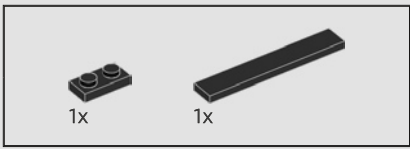

72

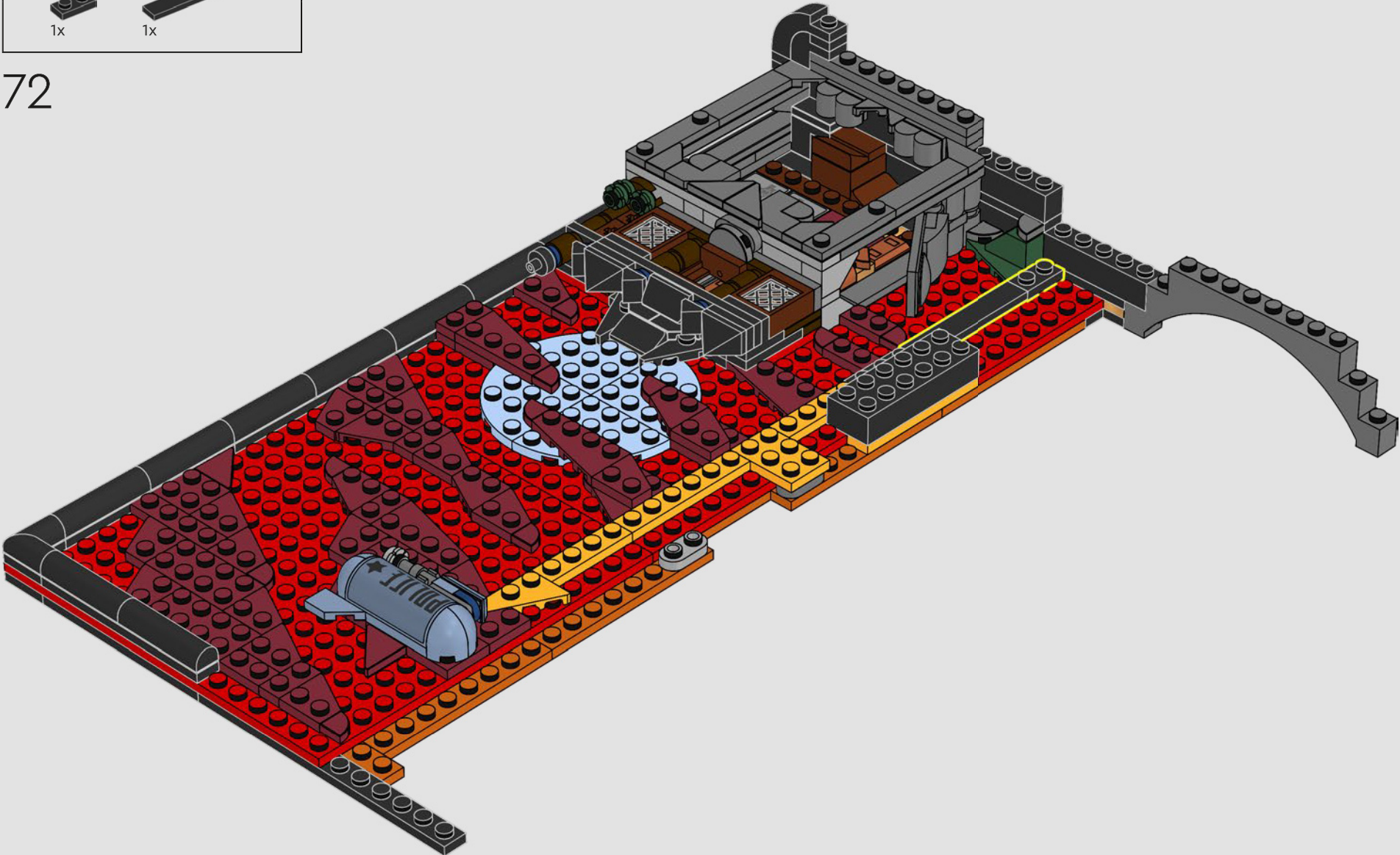

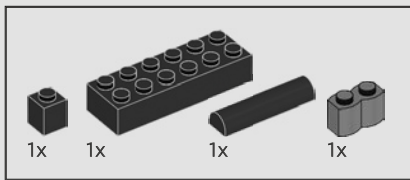

73

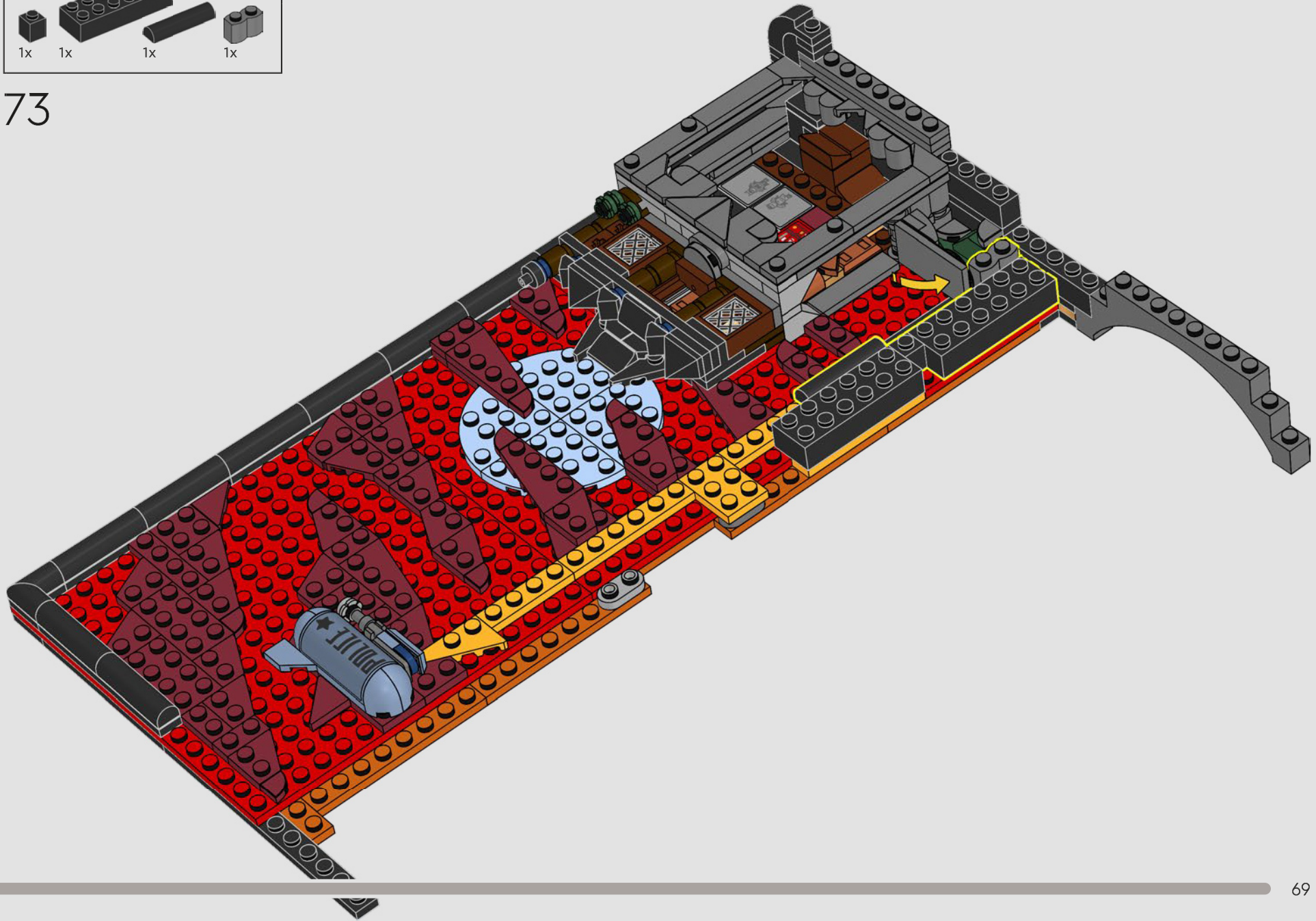

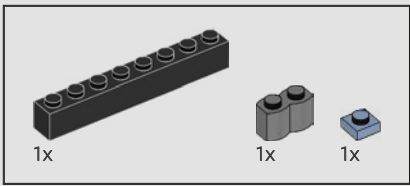

74

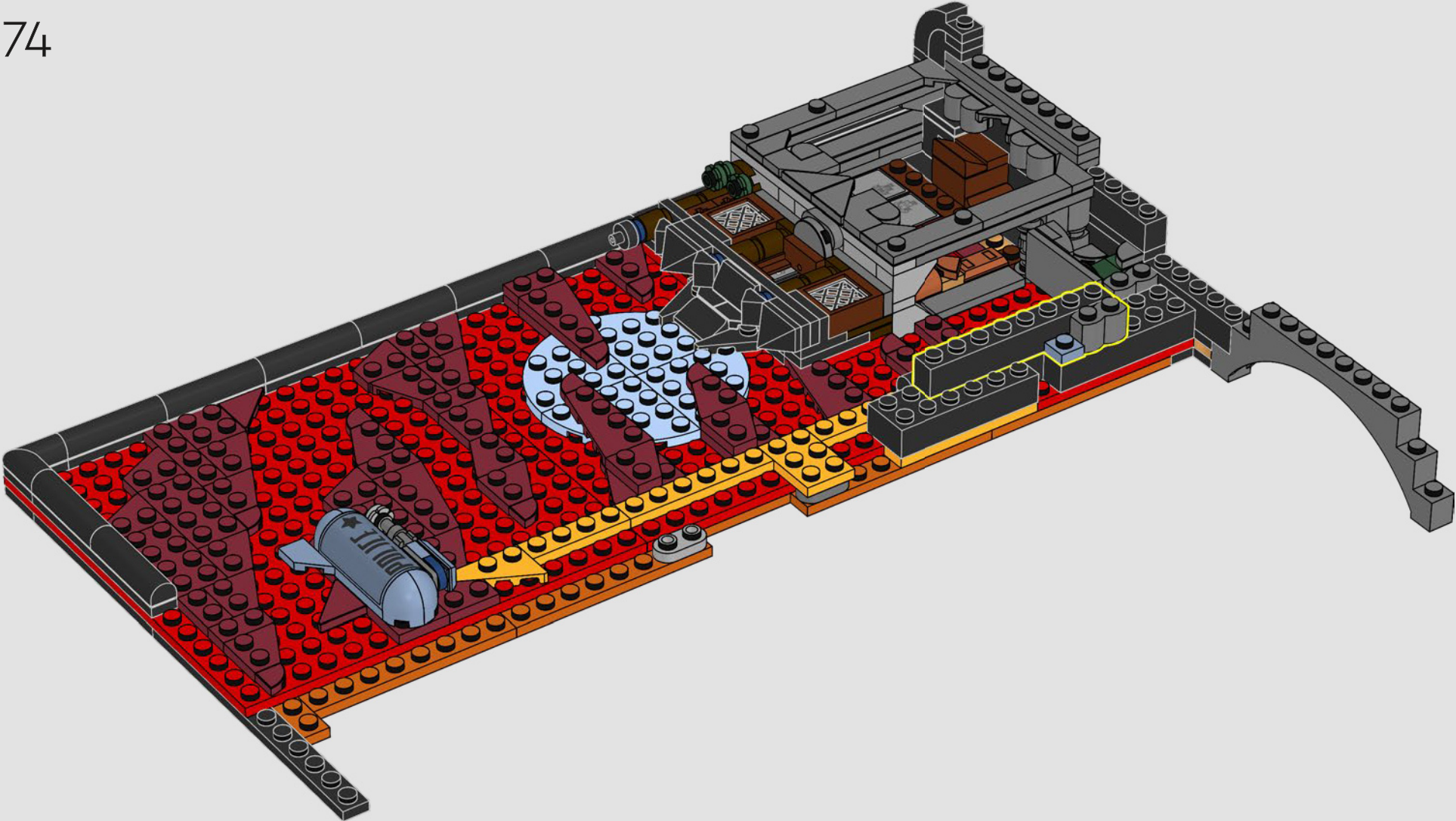

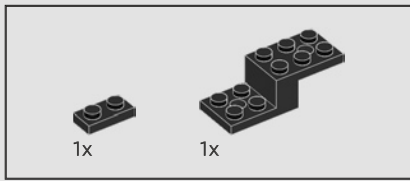

75

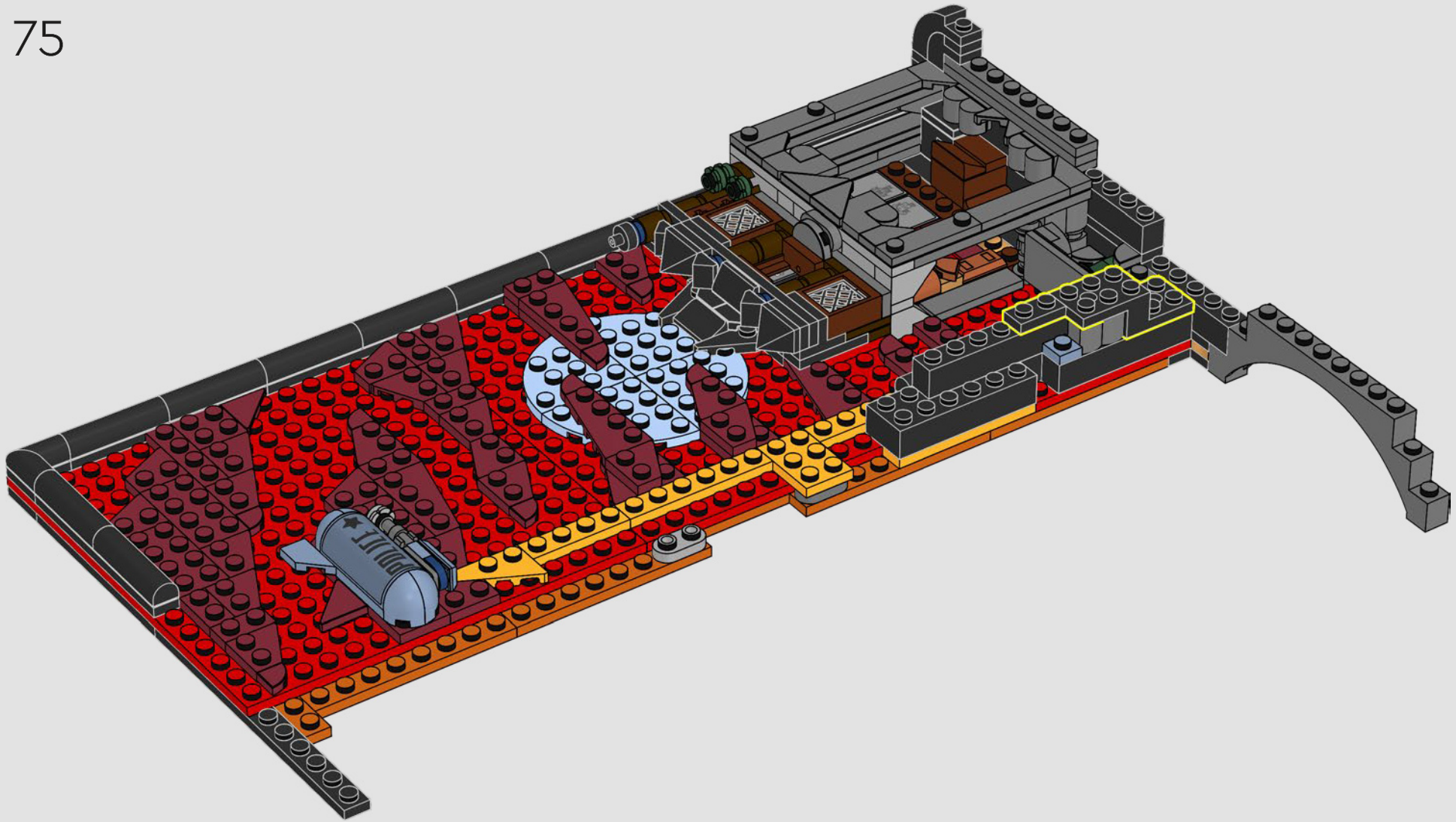

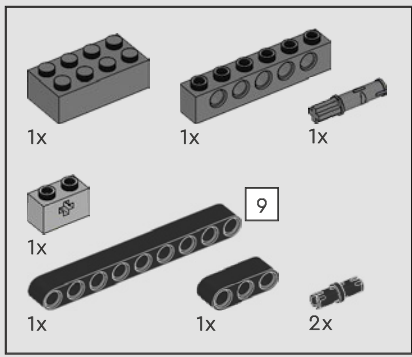

76

1

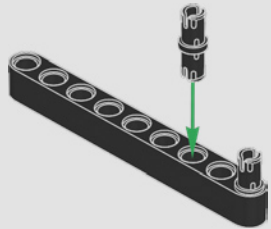

2

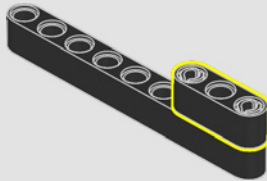

3

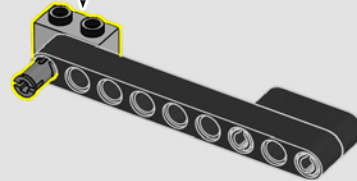
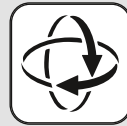
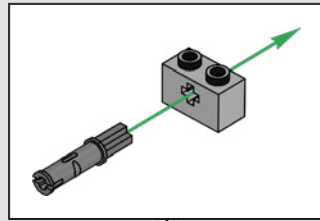

4

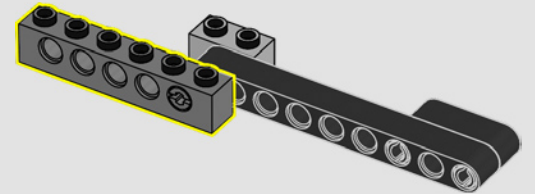

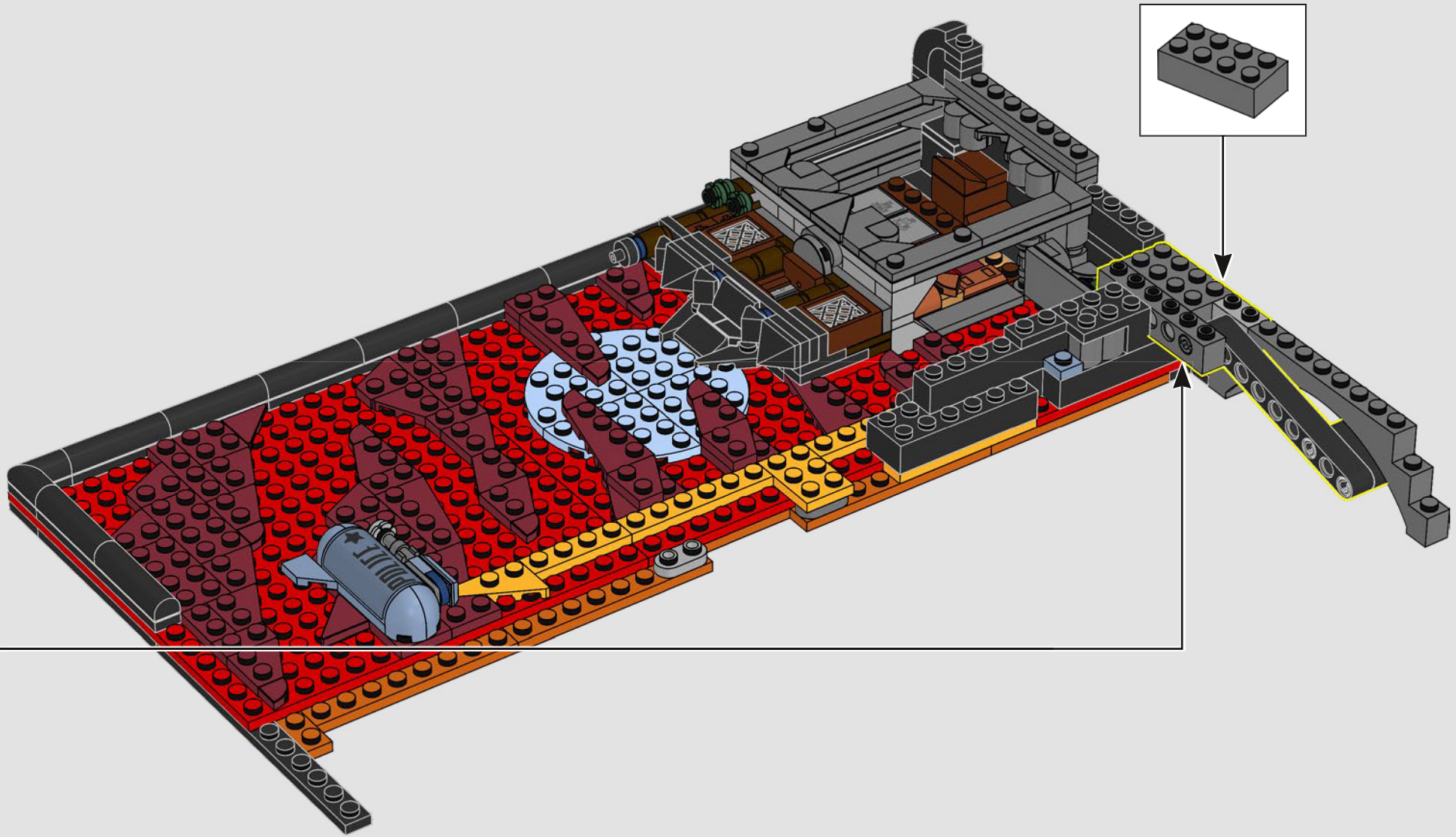

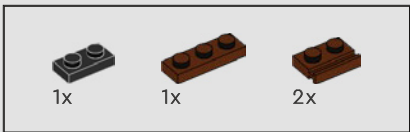

77

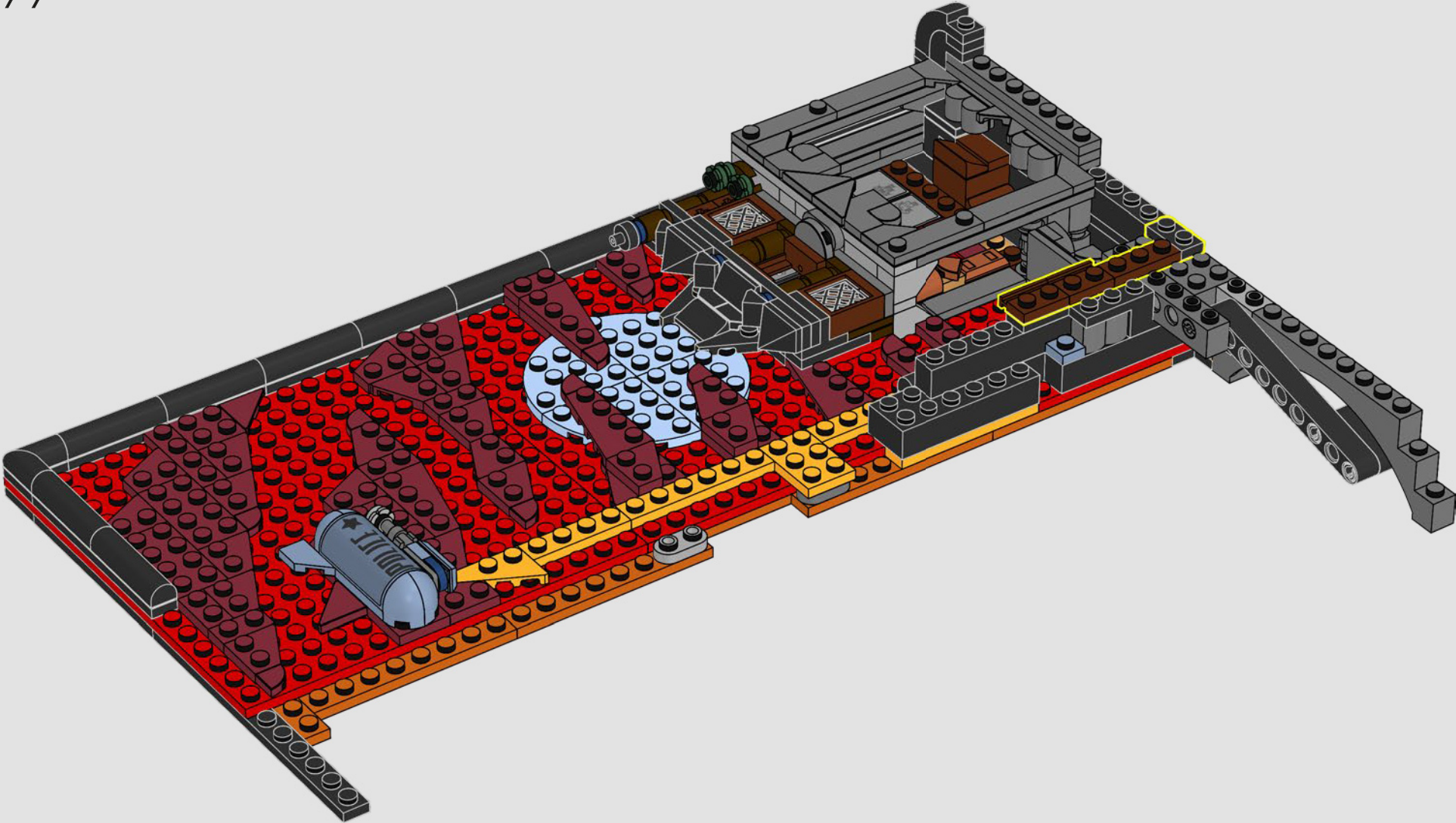



78

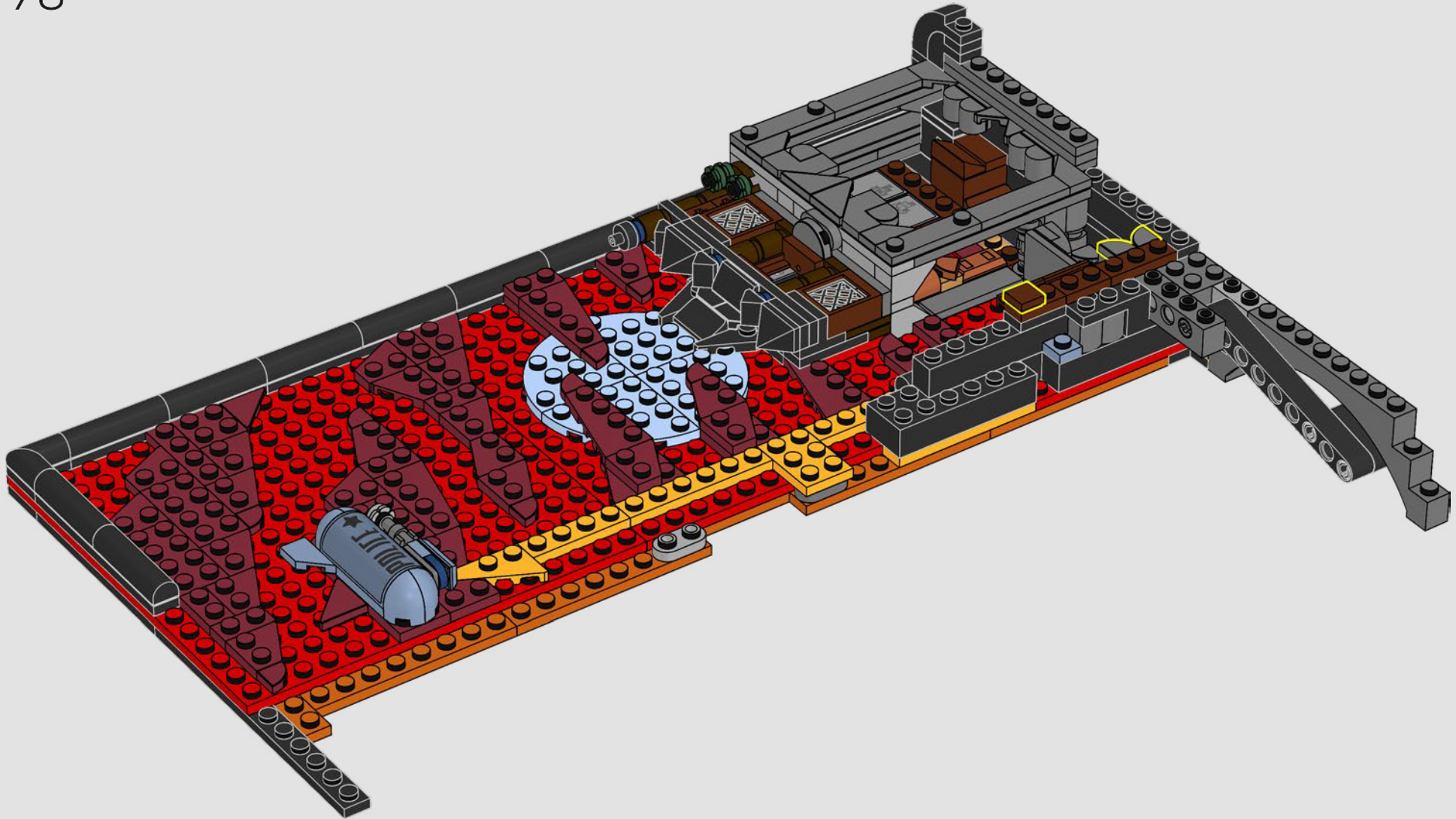

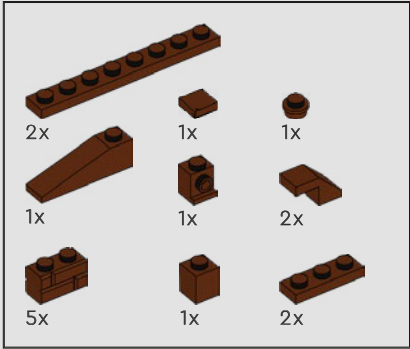
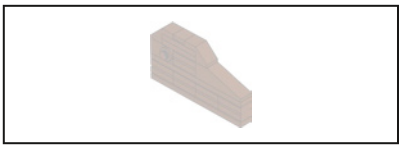

79

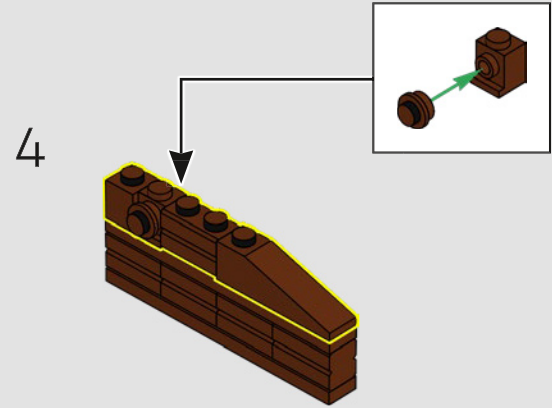
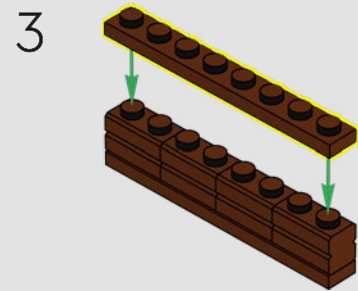
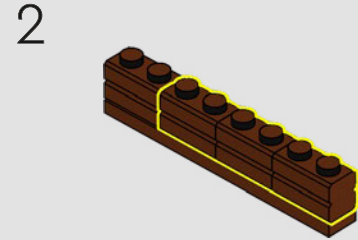
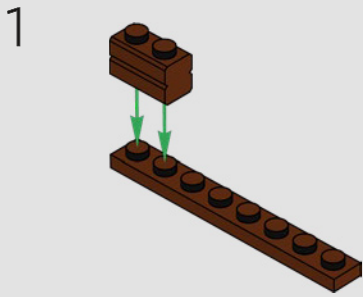

5

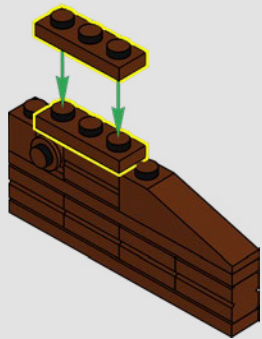

6

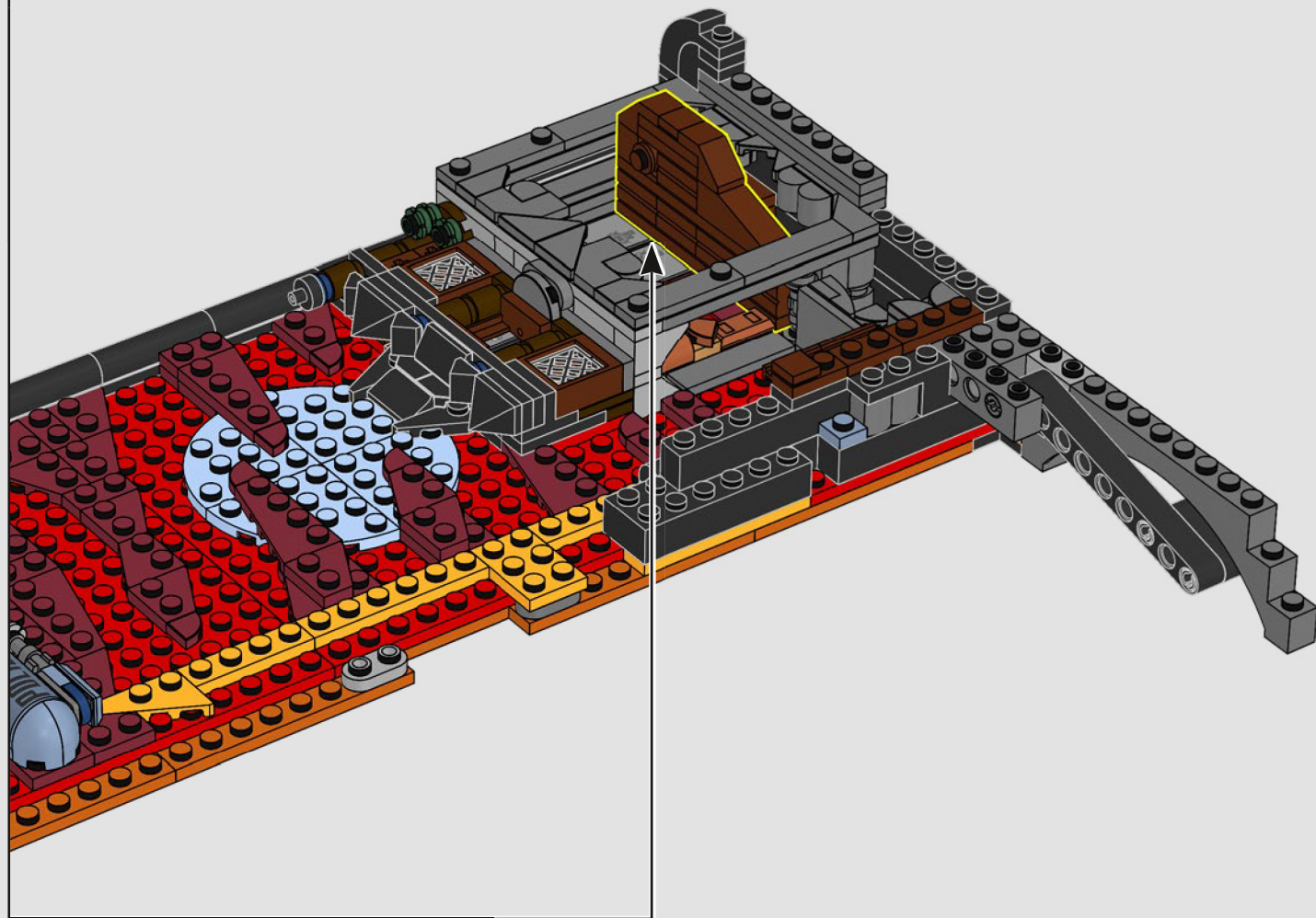
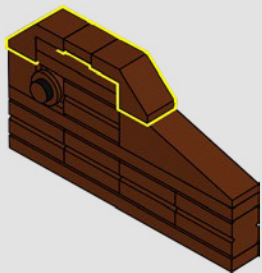

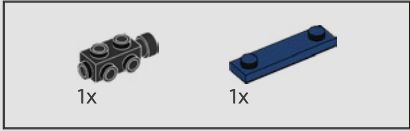
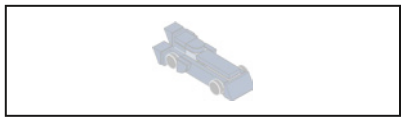

80

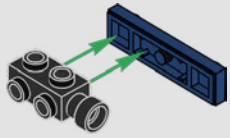

81

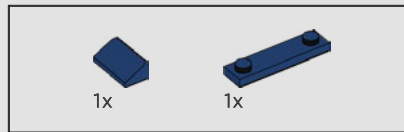
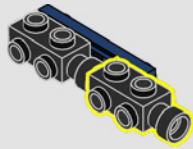

82

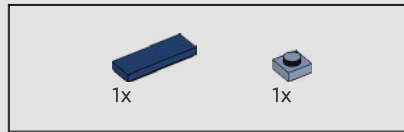
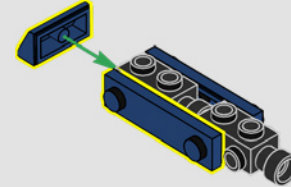

83

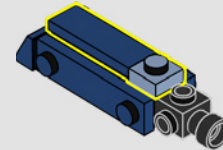

84

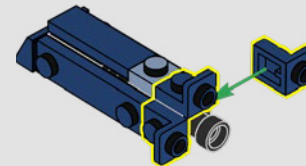



85

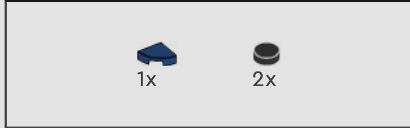
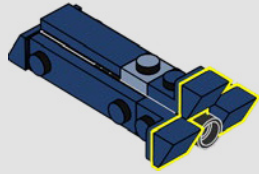

86

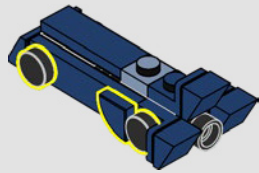

87

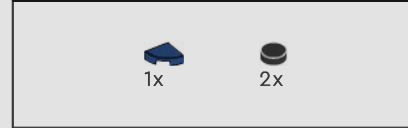
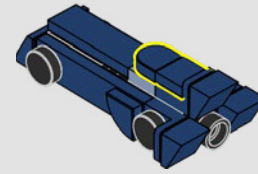

88

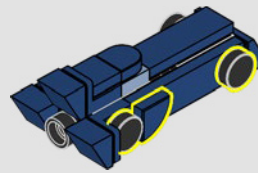

89

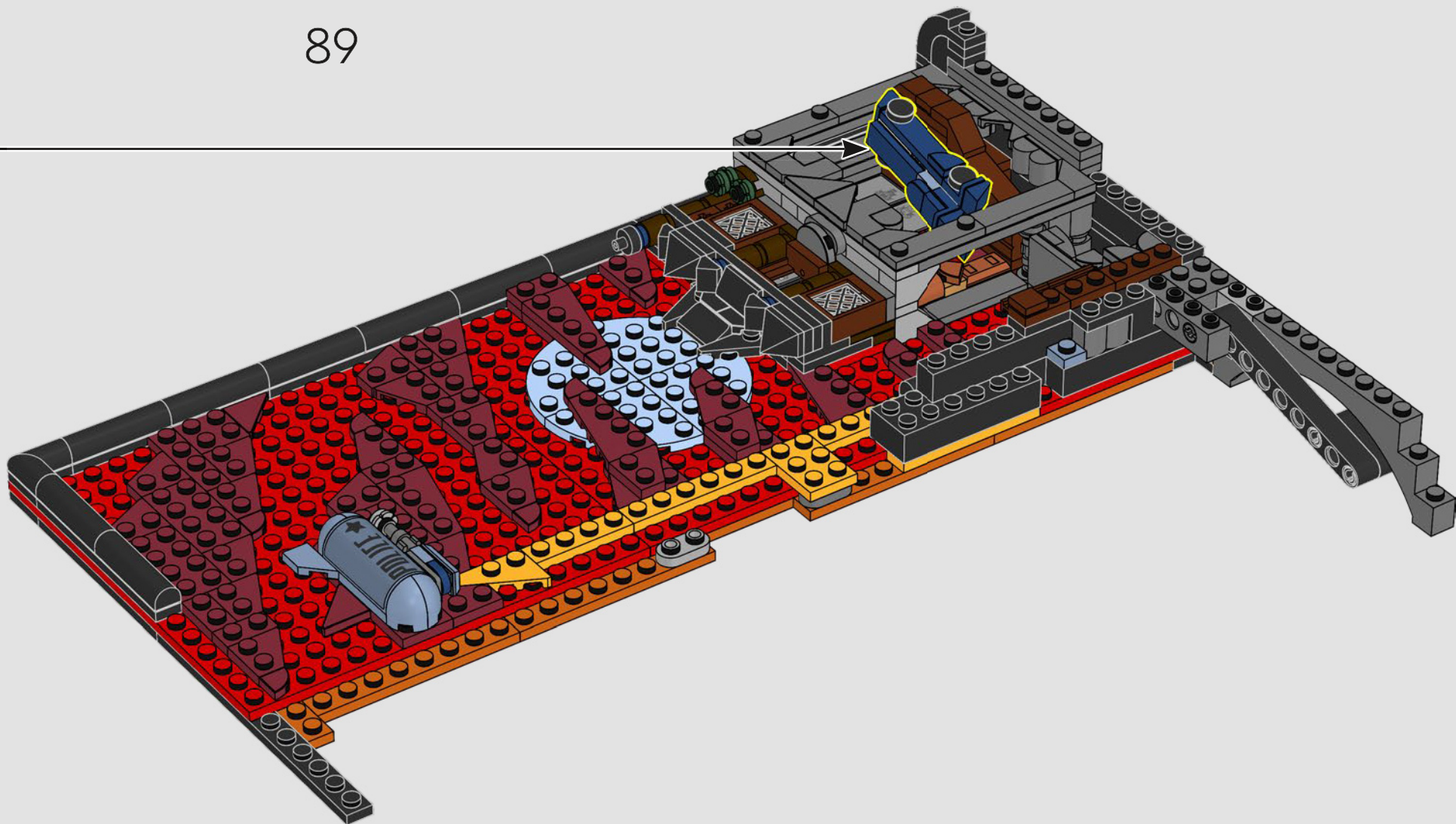



Episode: *Batgirl Returns*
Épisode : *Le retour de Batgirl*
Episodio: *El regreso de Batichica*

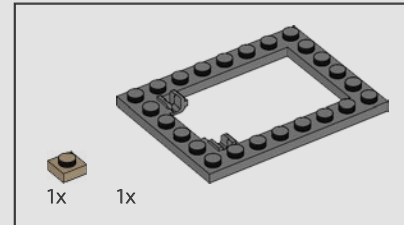
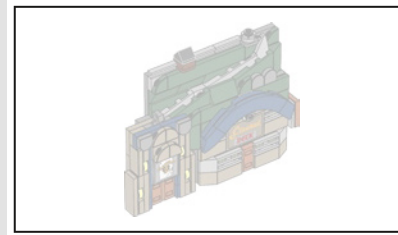

90

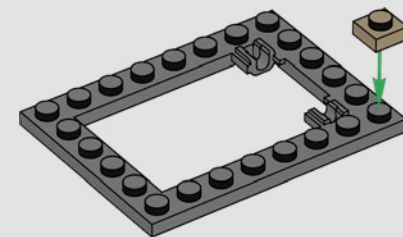

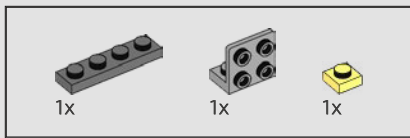

91

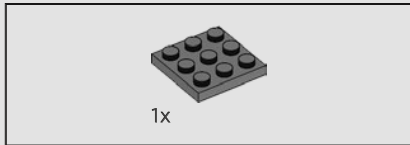
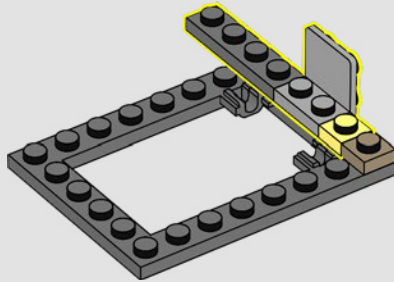

92

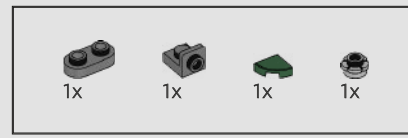
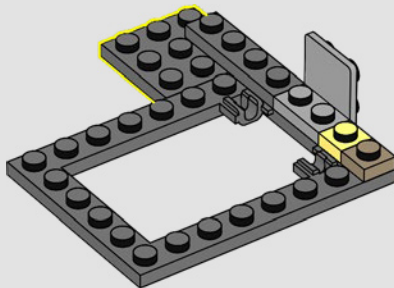

93

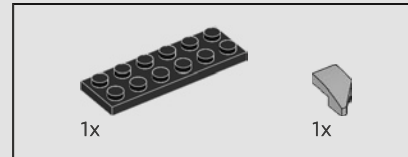
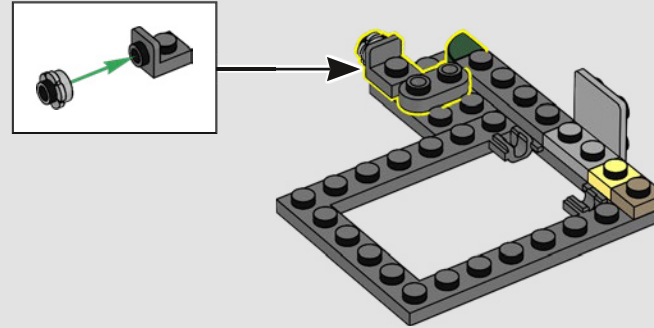

94

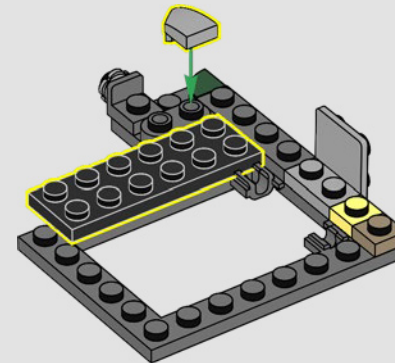

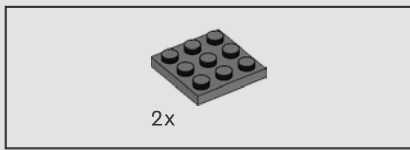

95

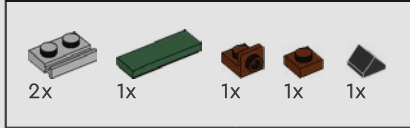
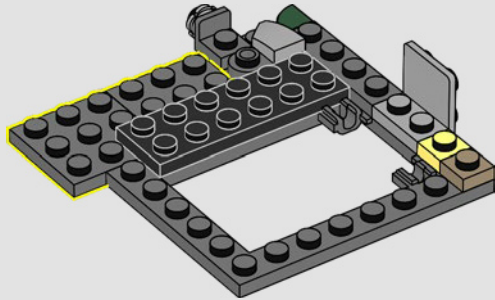

96

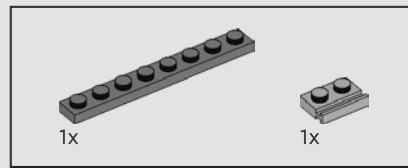
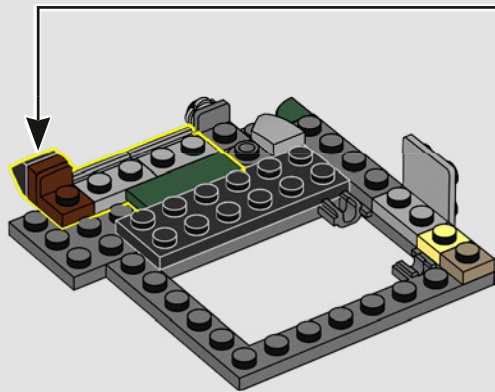
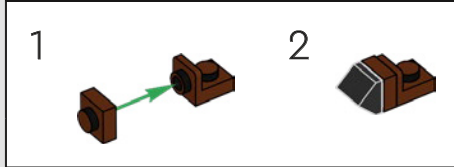

97

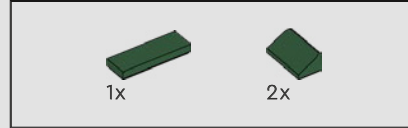
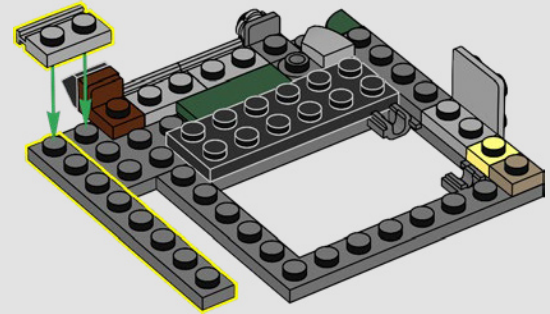

98

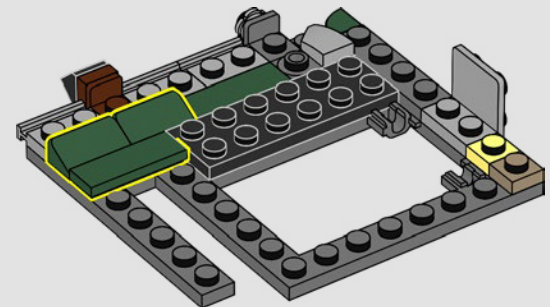

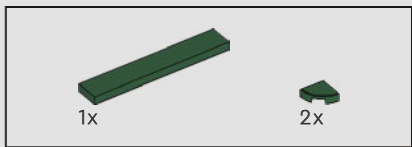

99

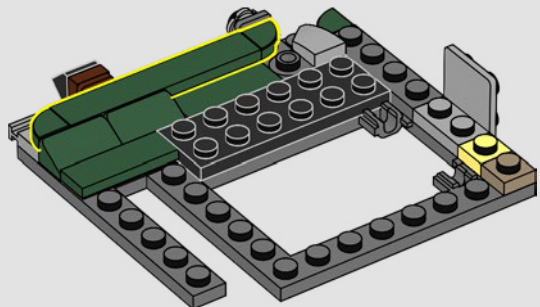

100

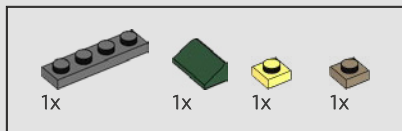
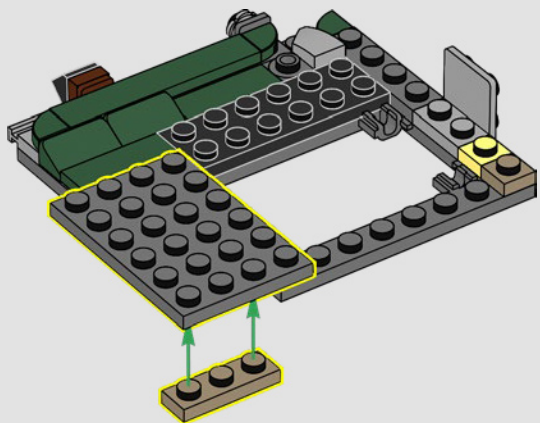

101

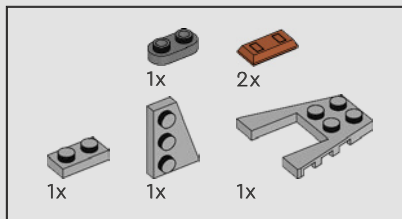
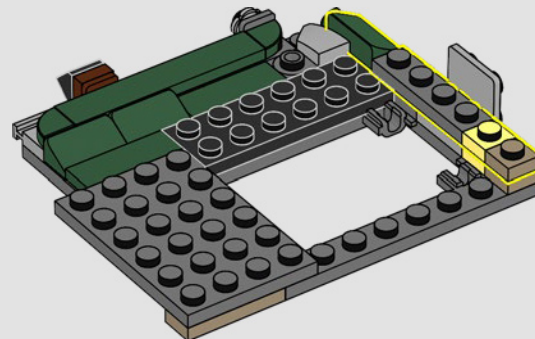

102

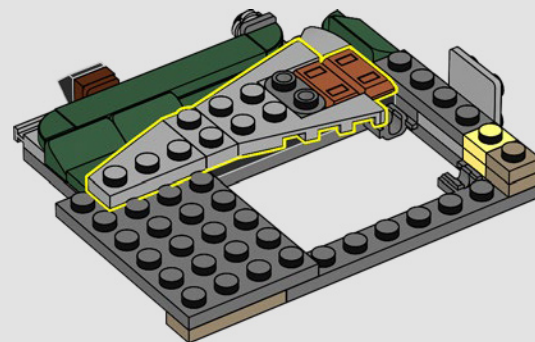

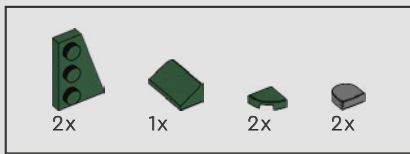

103

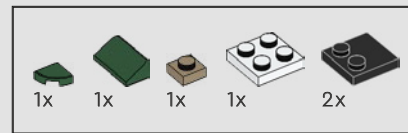
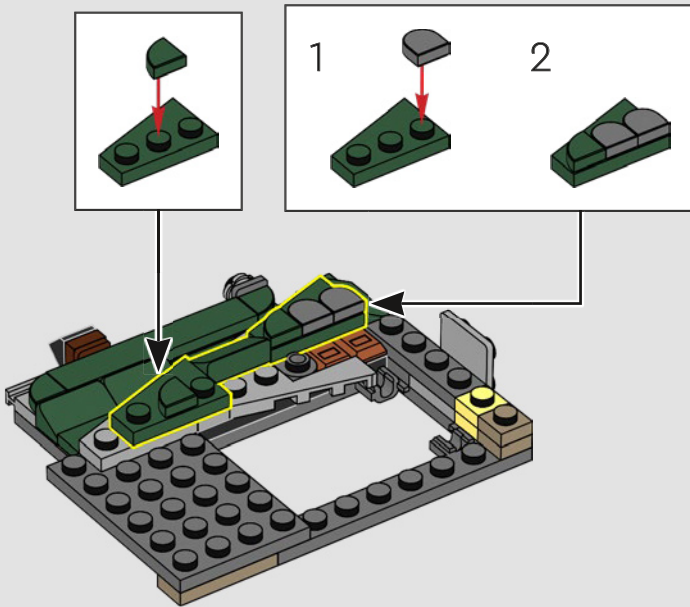

104

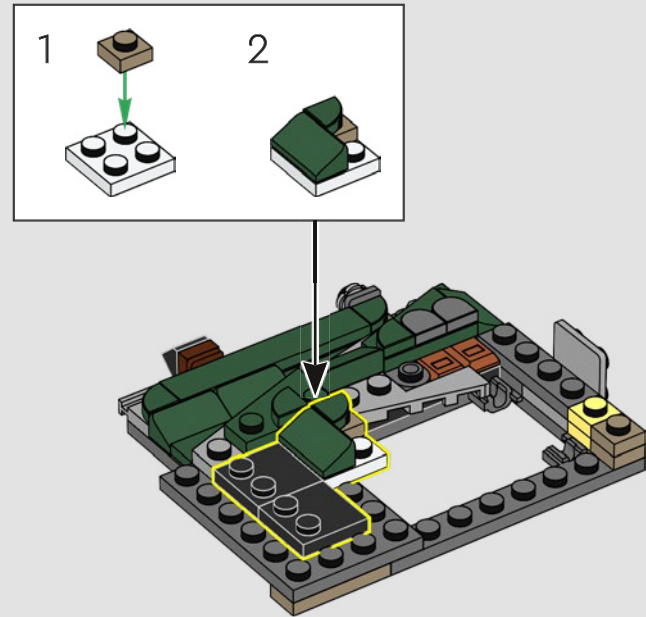

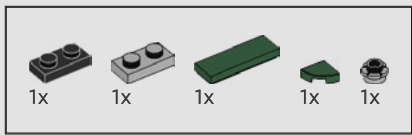

105

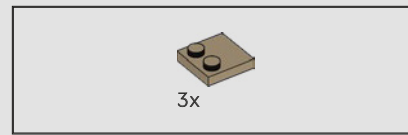
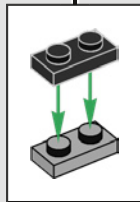
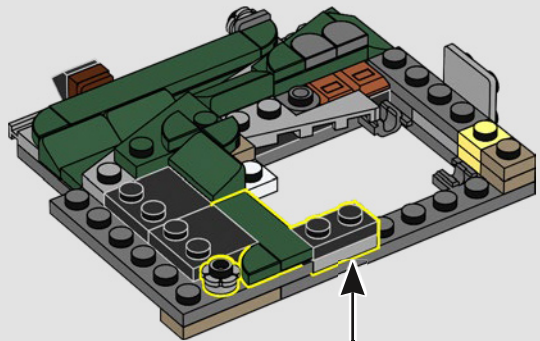

106

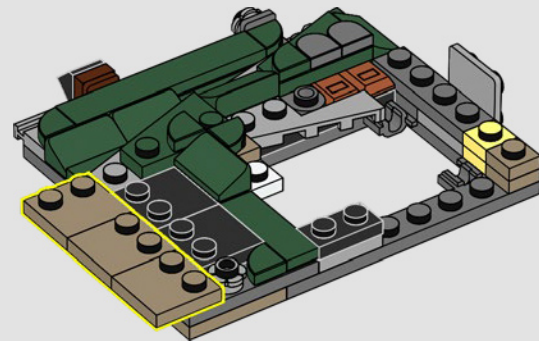

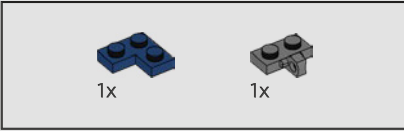
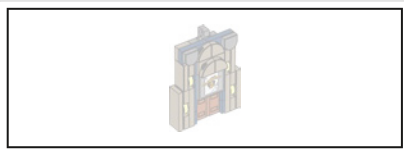

107

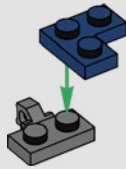

108

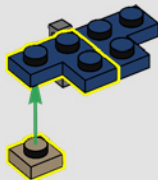

109

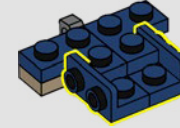

110

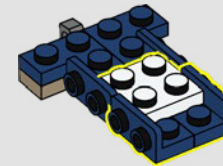

111

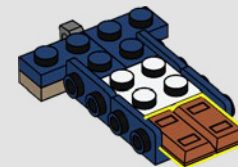



2x

112

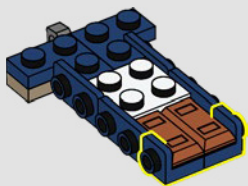

2x



2x

113

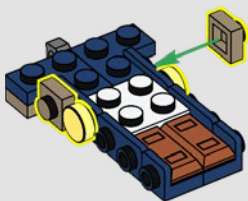

2x

114

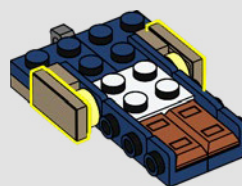

4x



2x



2x



2x

115

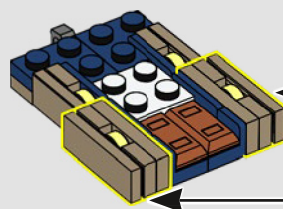
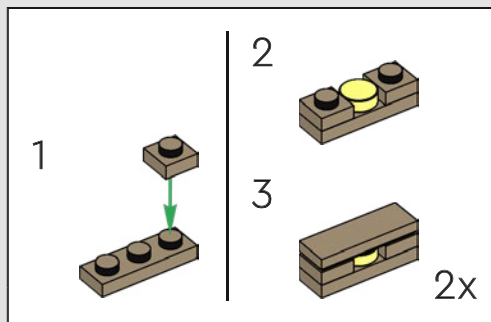



116

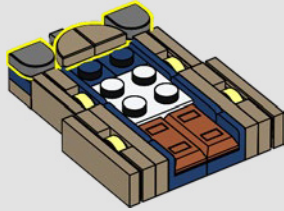

117

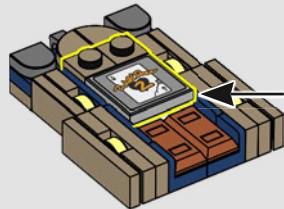
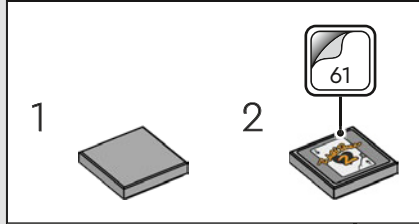

118

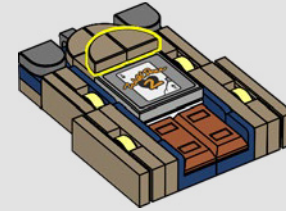

119

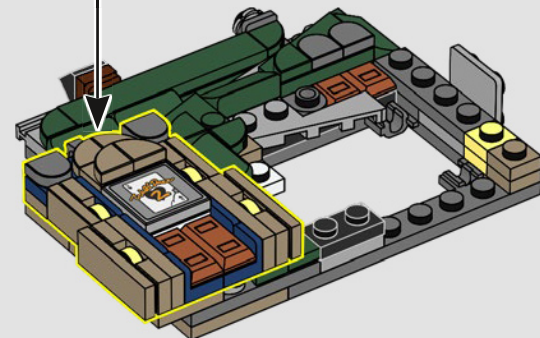

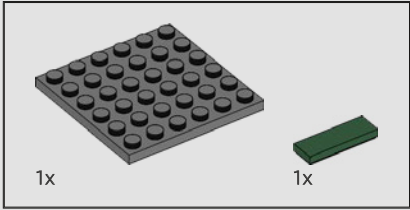

120

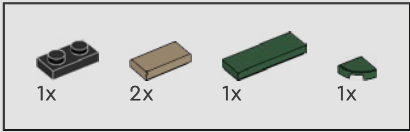
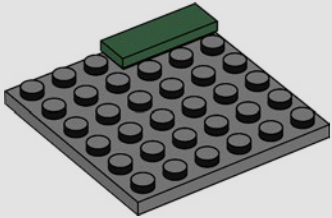

121

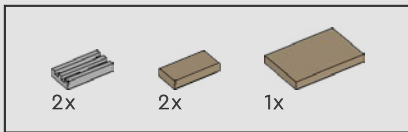
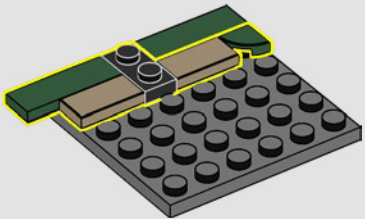

122

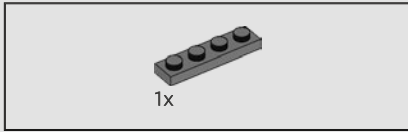
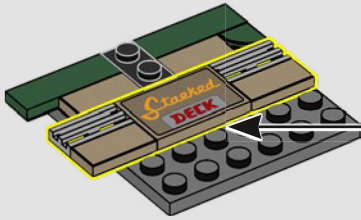
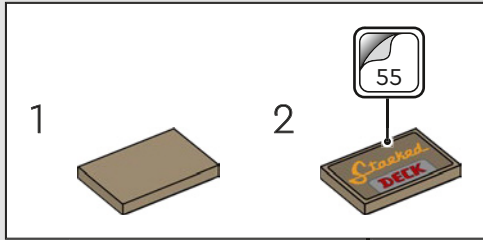

123

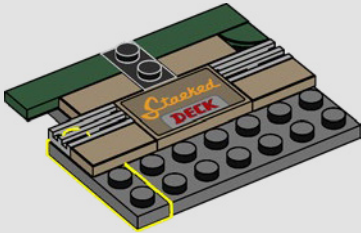



124

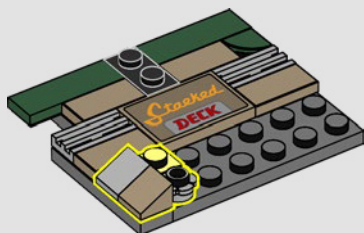

125

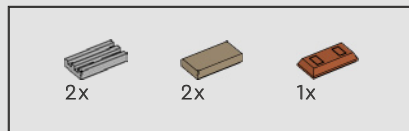
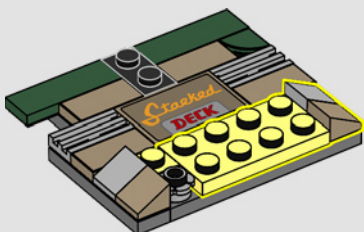

126

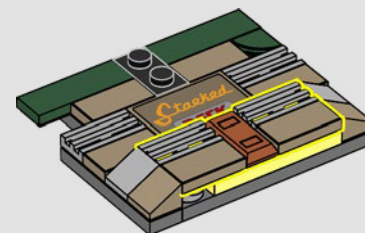

127

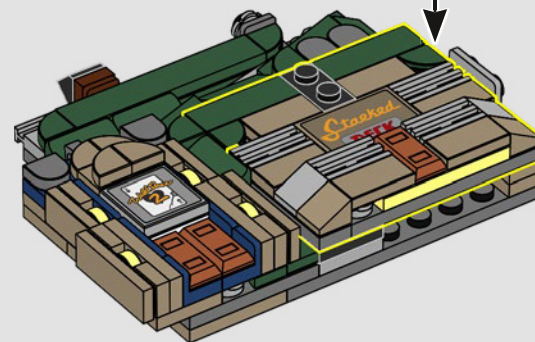

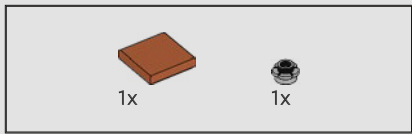

128

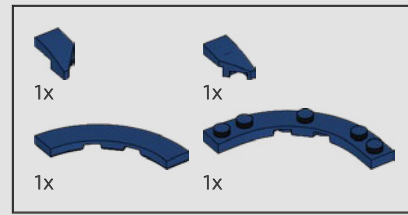
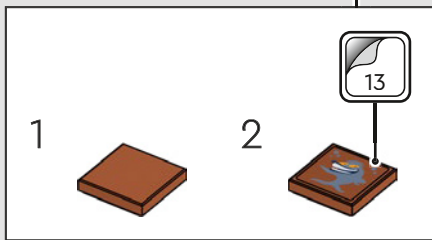
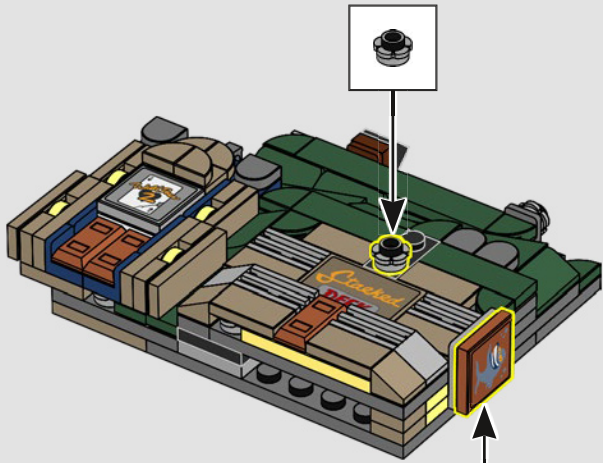

129

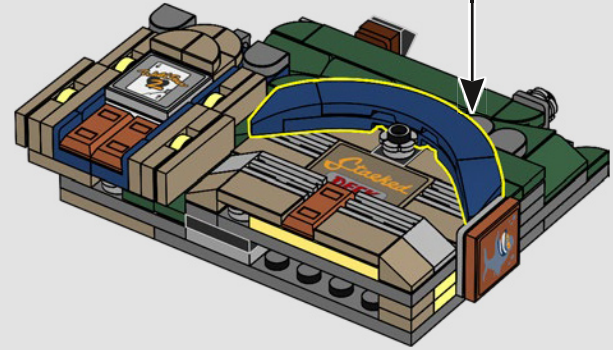
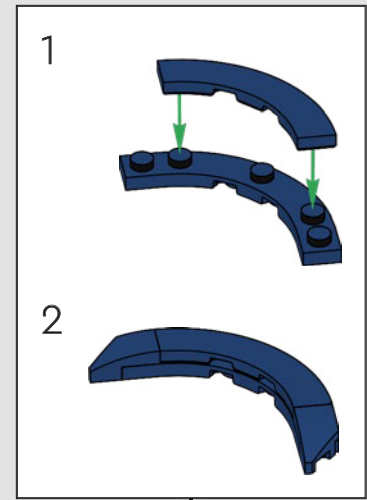

130

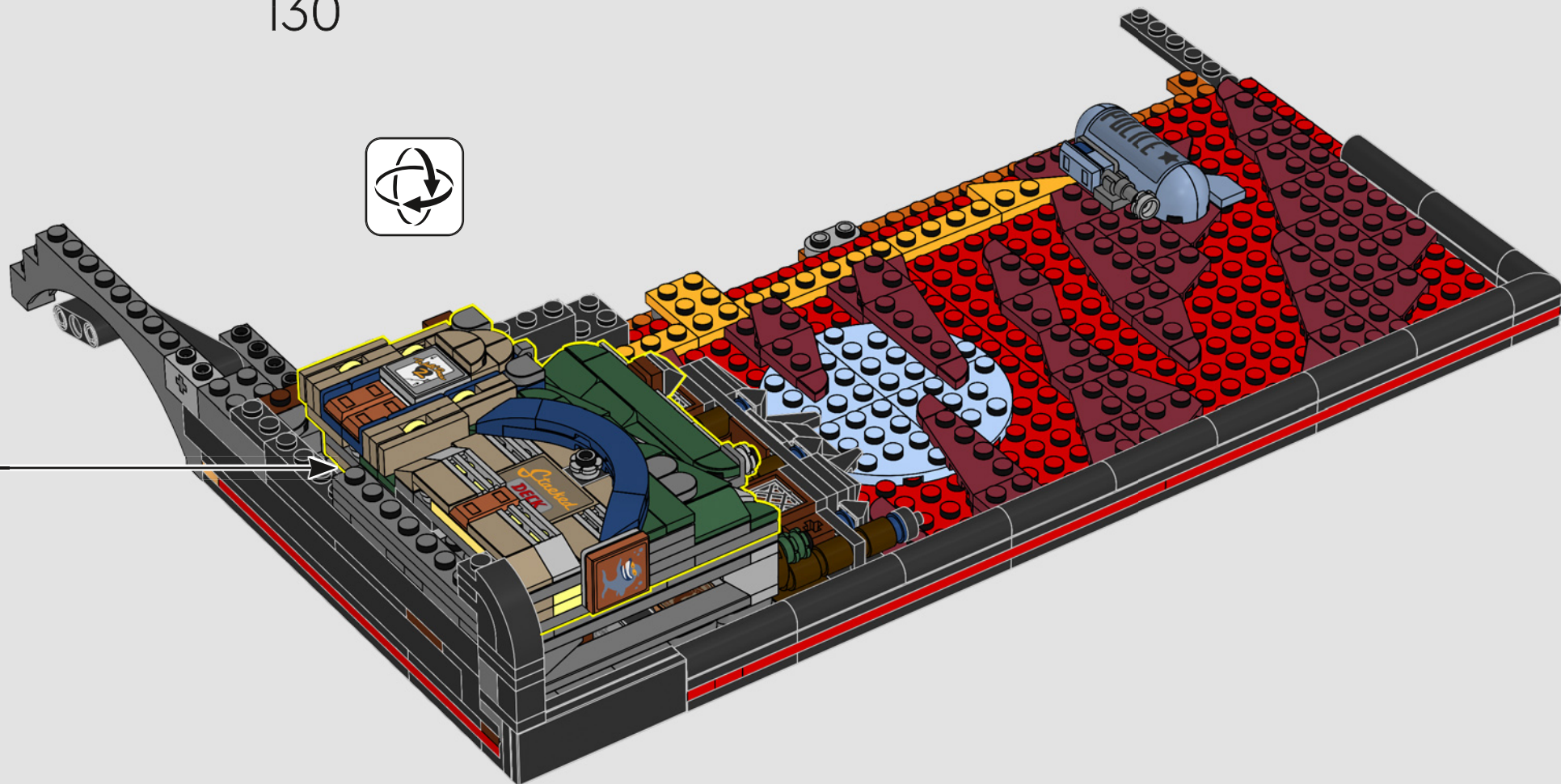

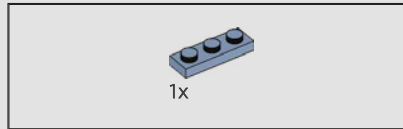
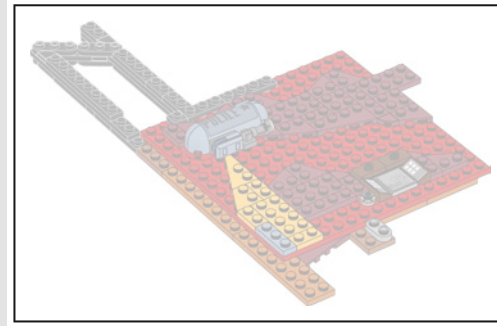
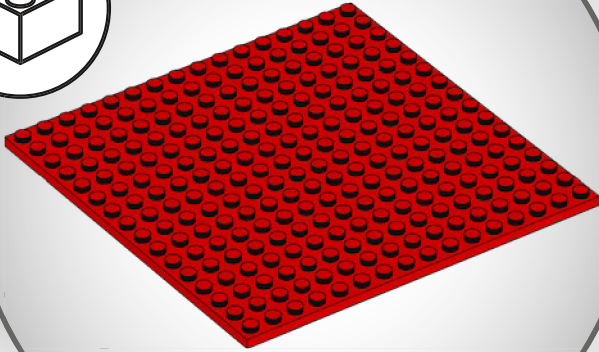
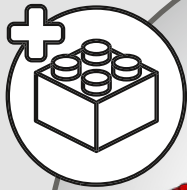

131

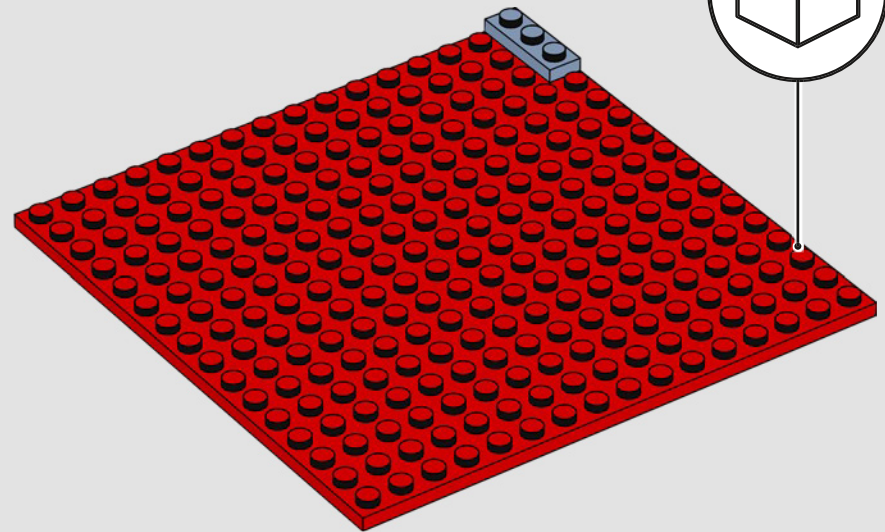
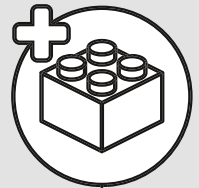

Episode: *Feat of Clay: Part I*
Épisode : *Bas les masques (1^{re} partie)*
Episodio: *Ilusión fatal: Parte 1*



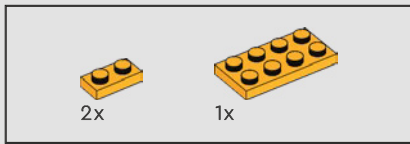

132

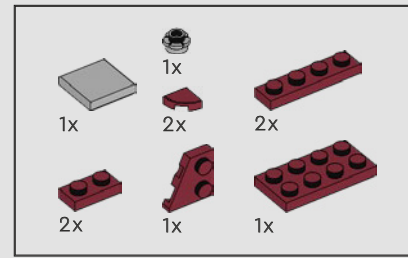
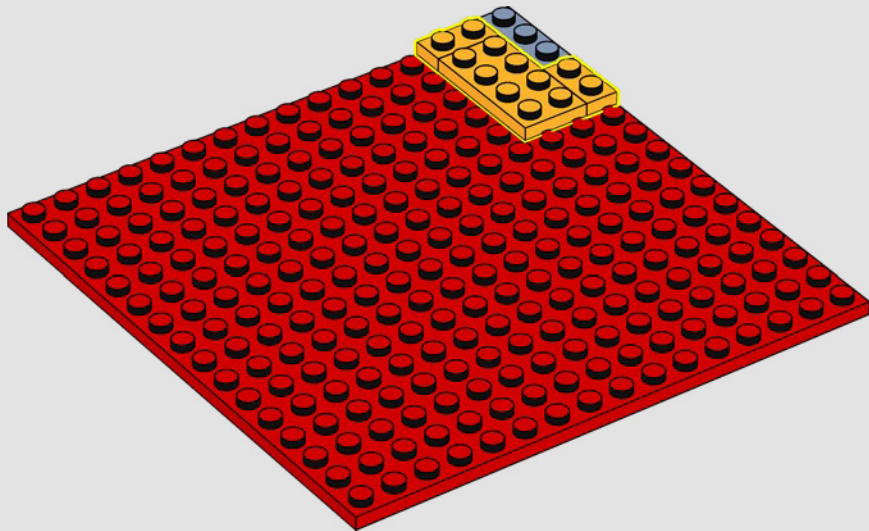

133

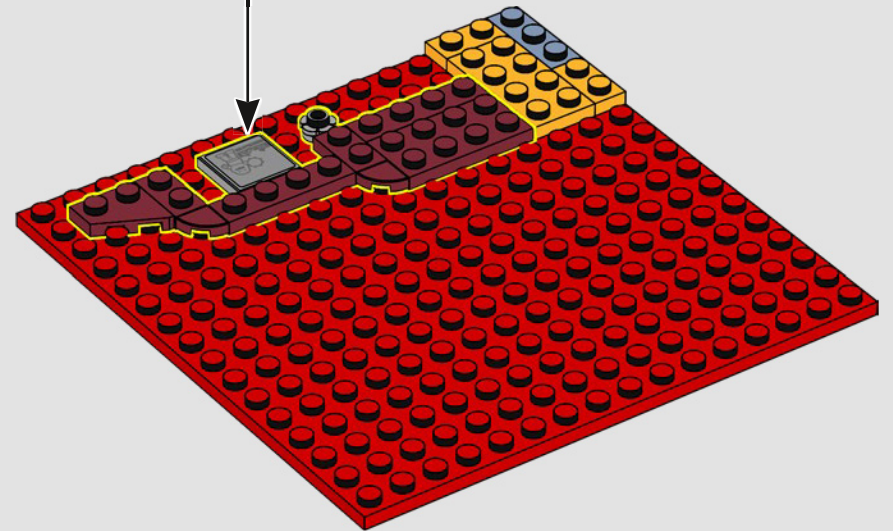
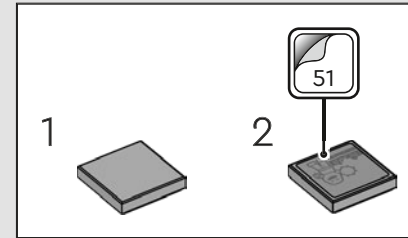

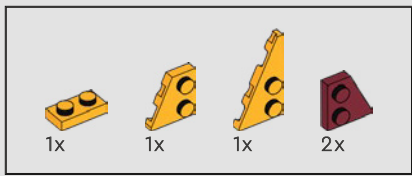

134

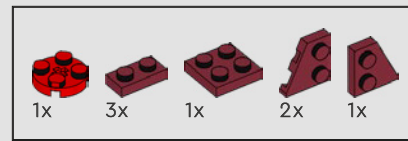
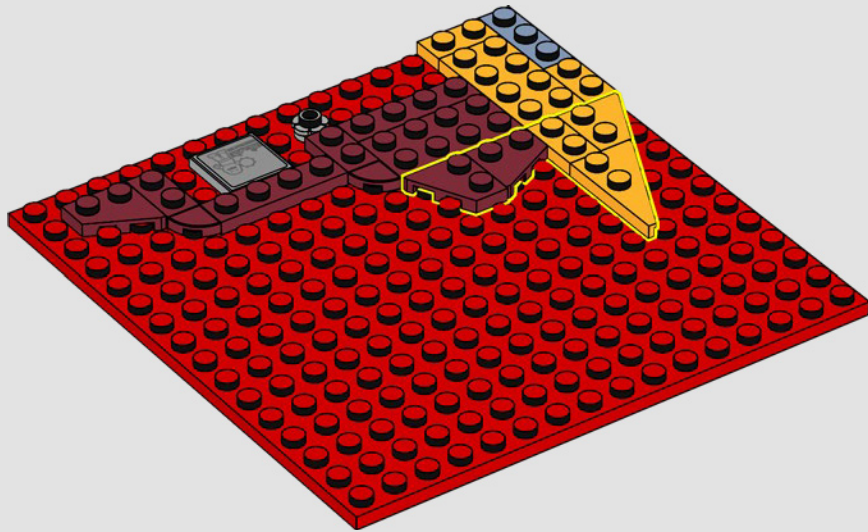

135

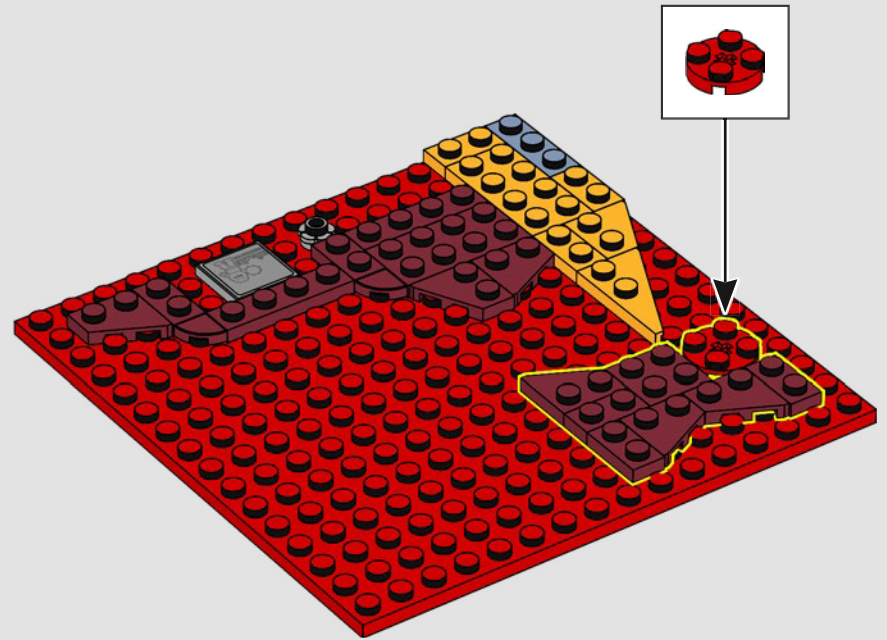

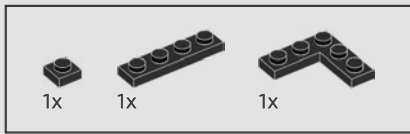

136

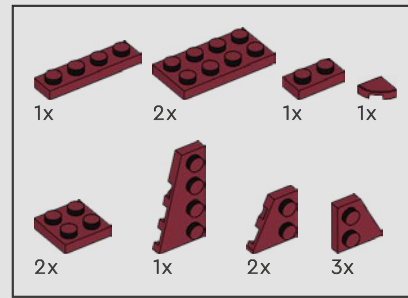
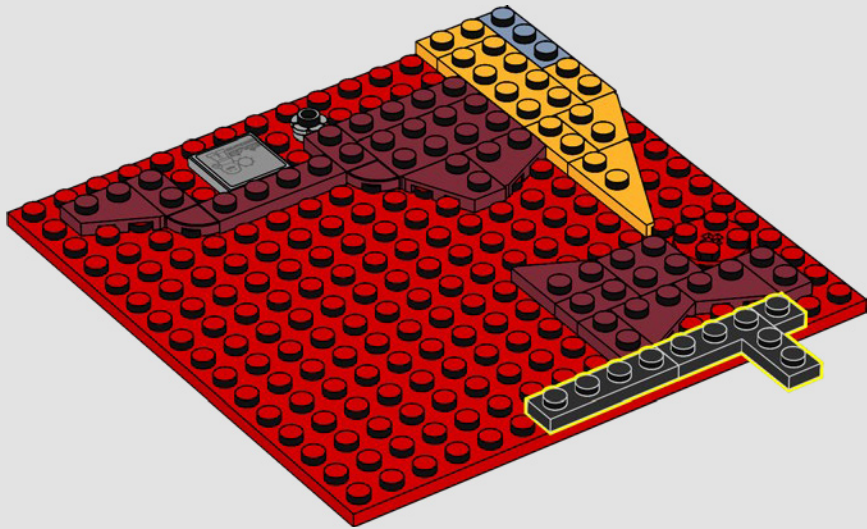

137

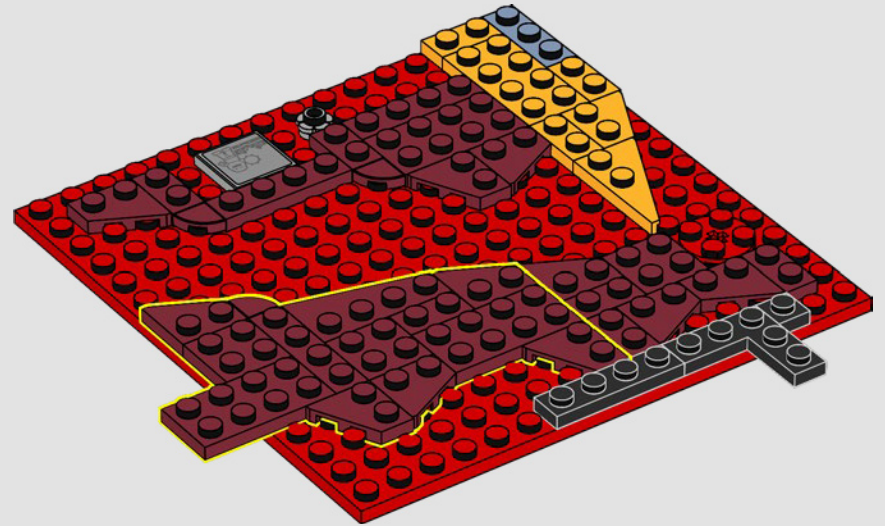

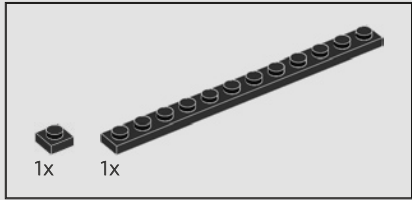
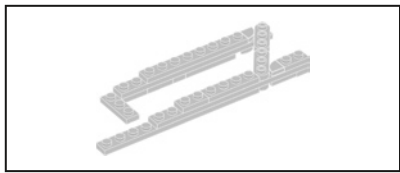

138

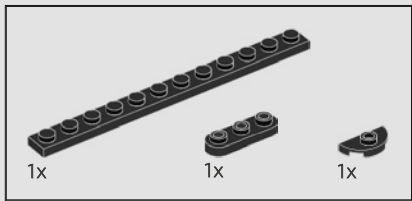
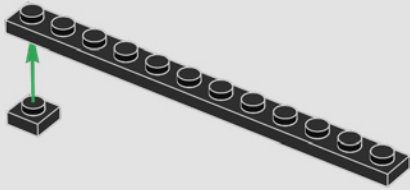

139

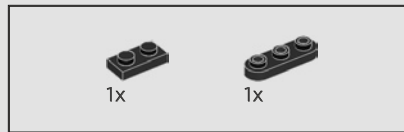
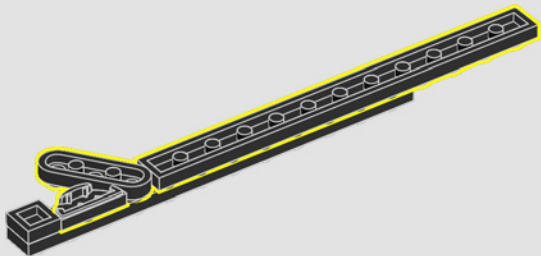

140

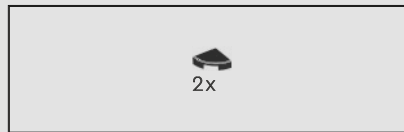
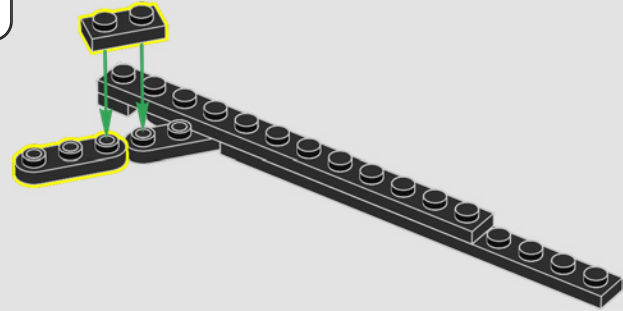

141

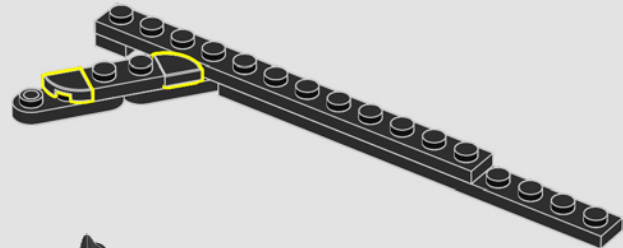

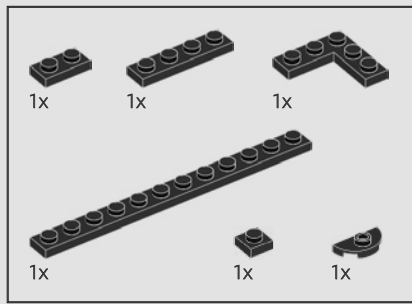

142

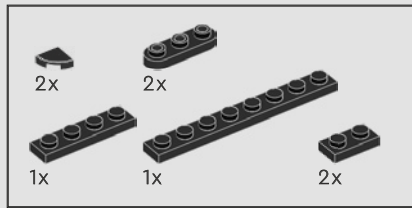
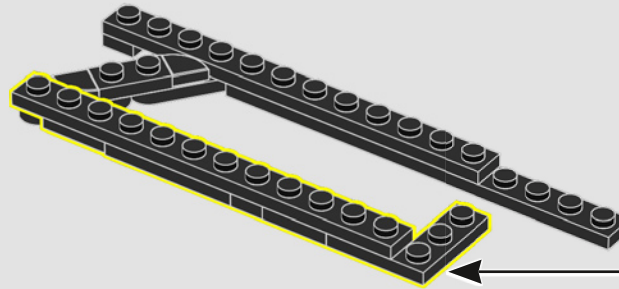
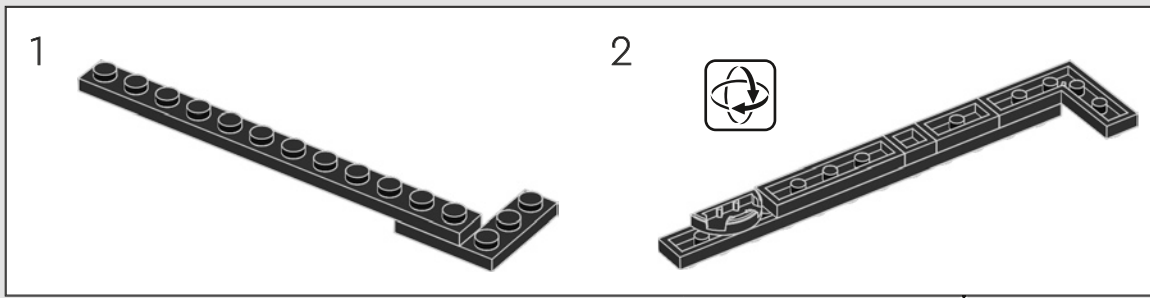

143

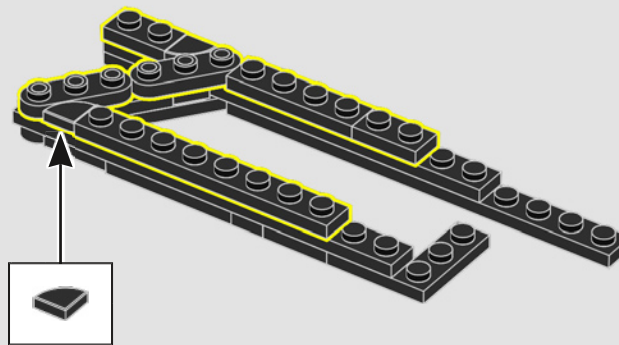

144

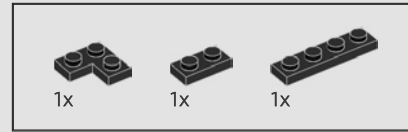
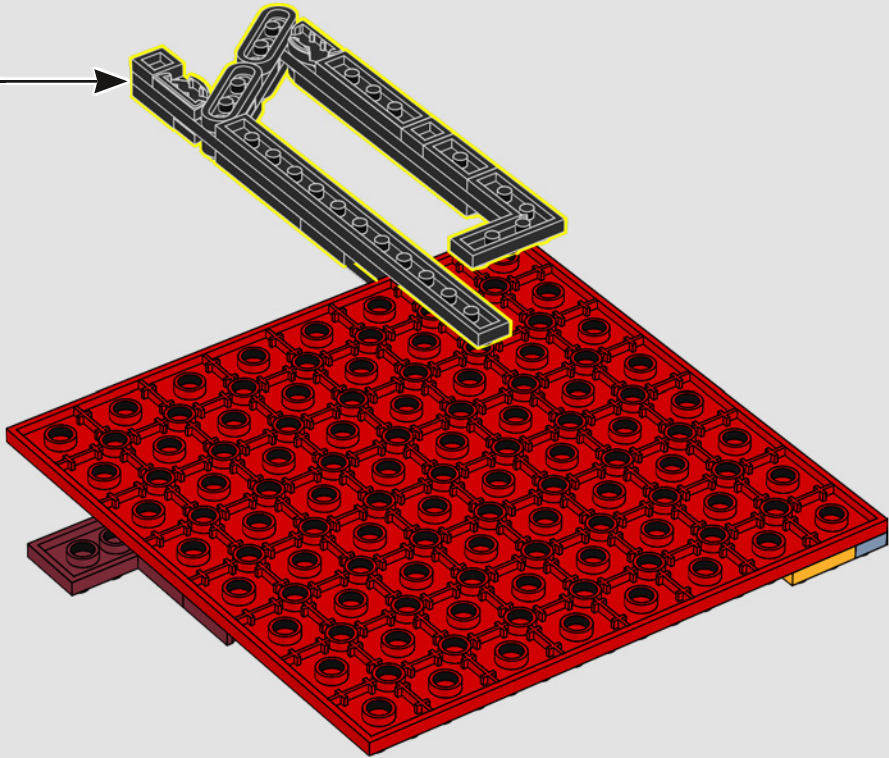

145

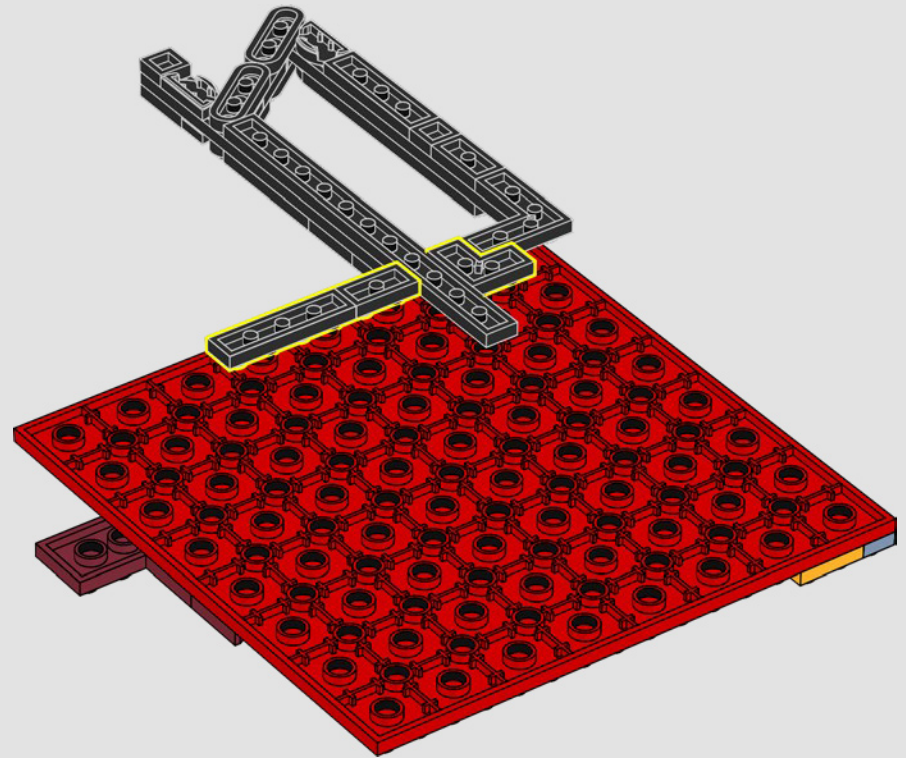

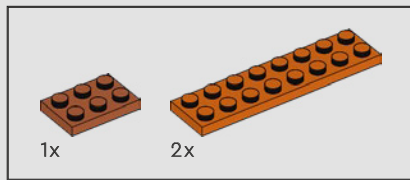

146

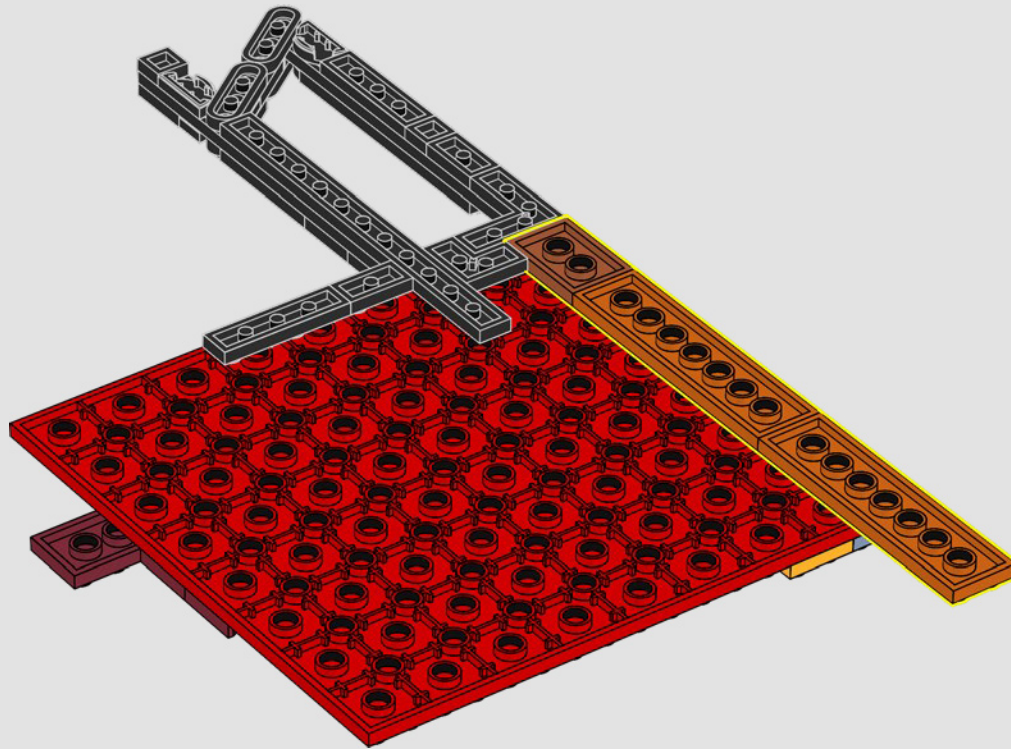

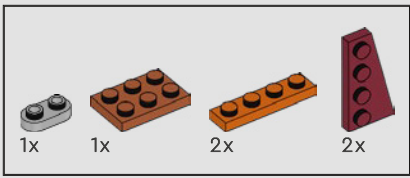

147

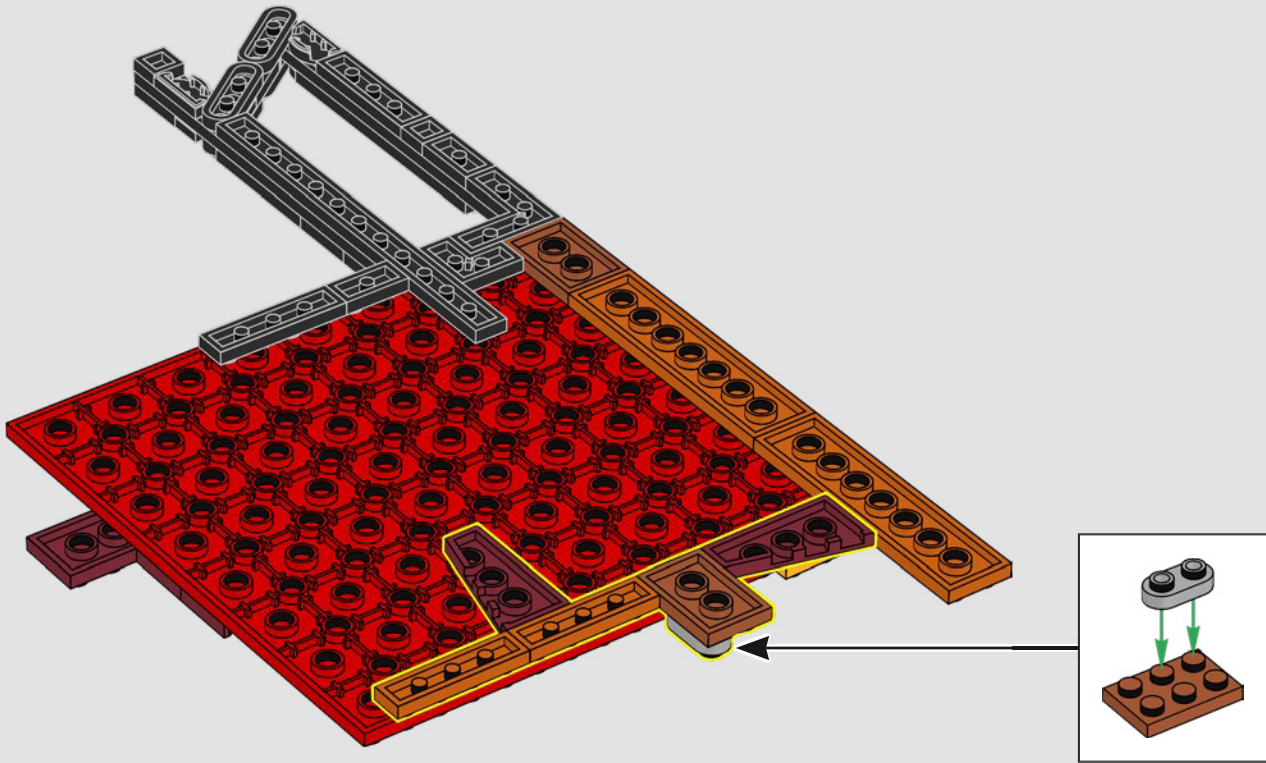

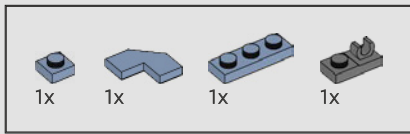

148

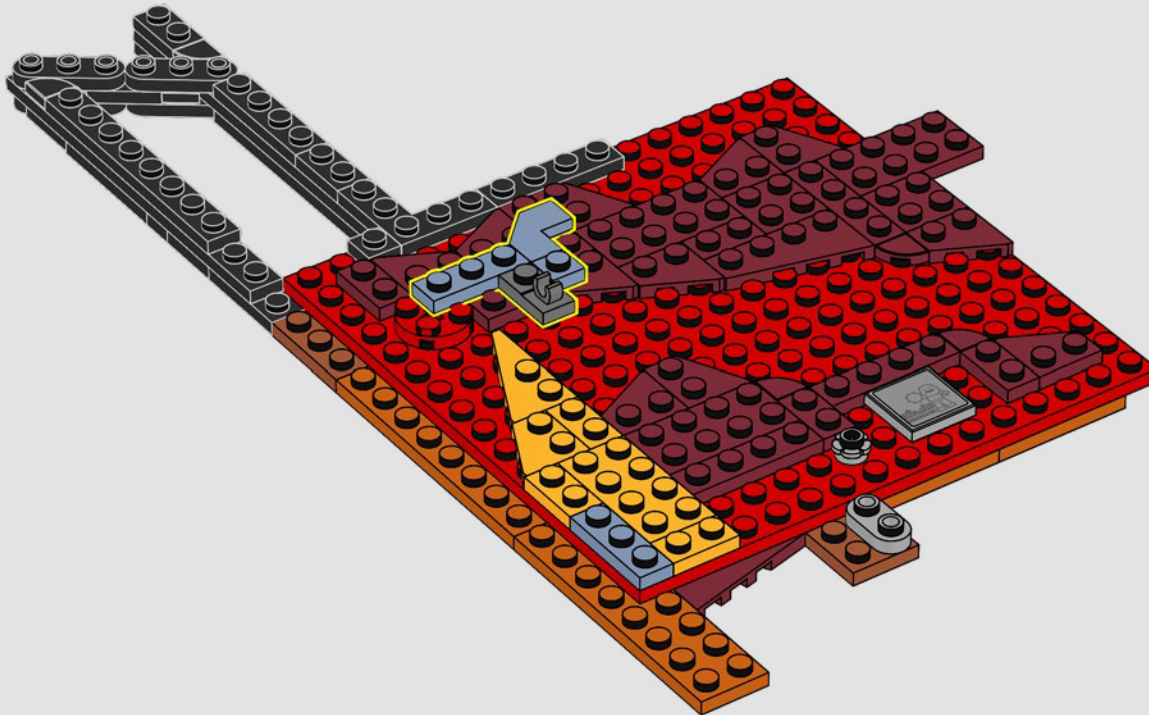

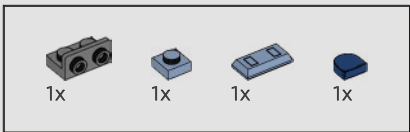

149

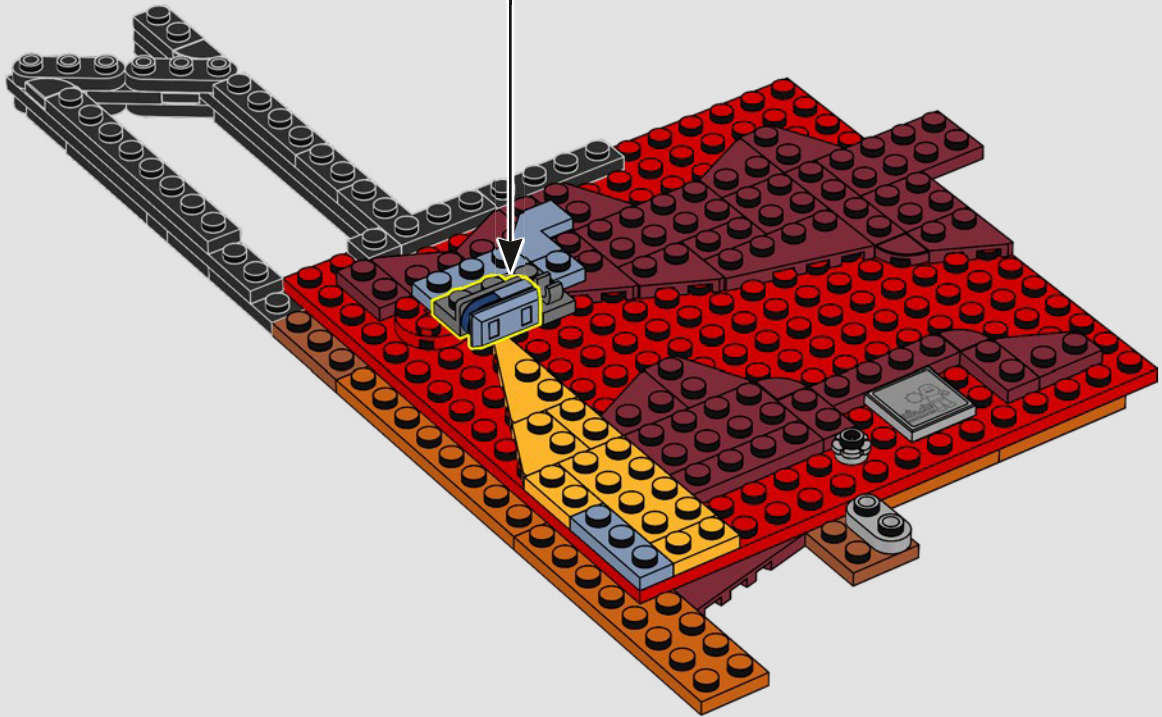
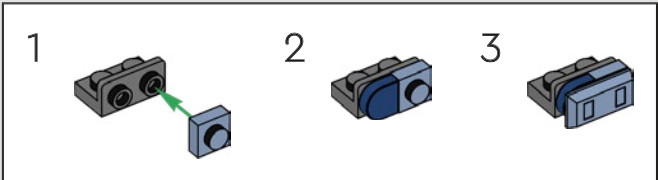

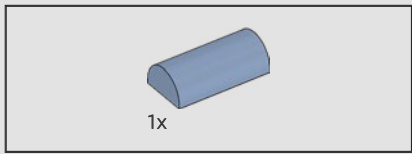

150

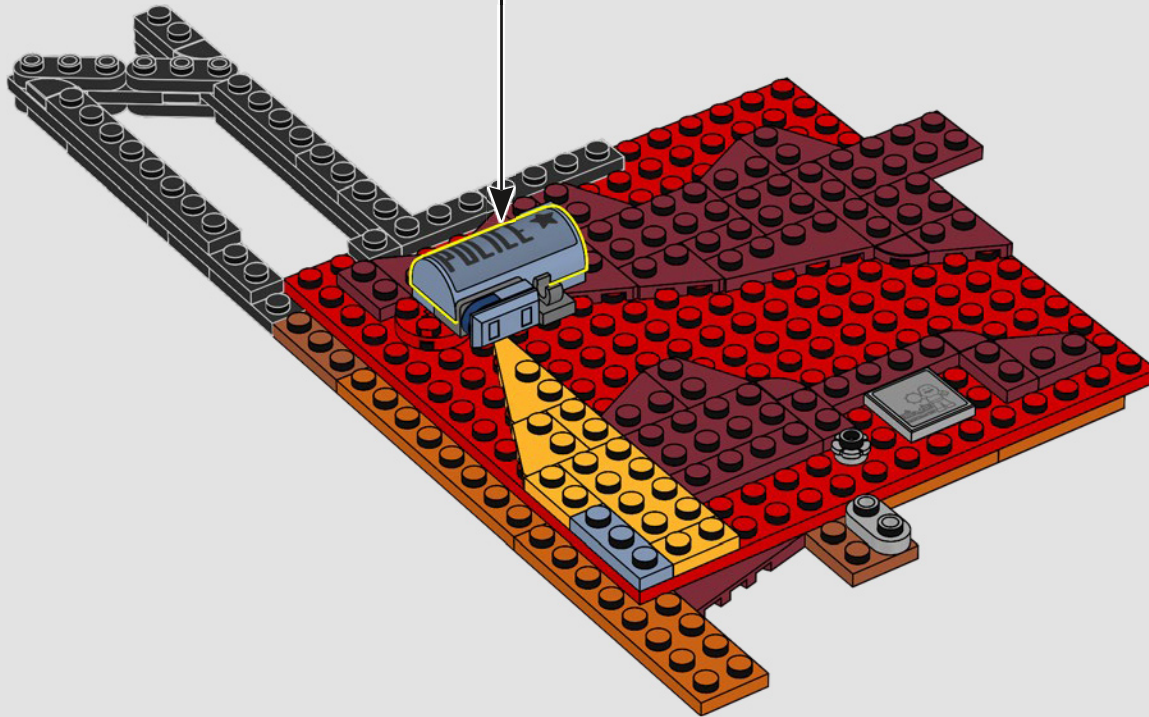
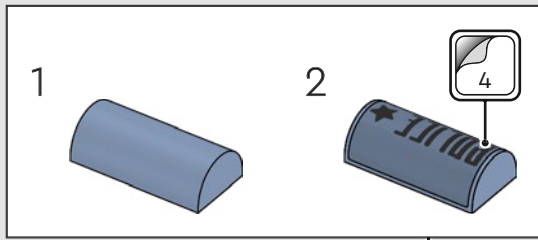

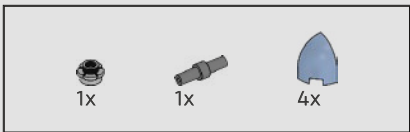

151

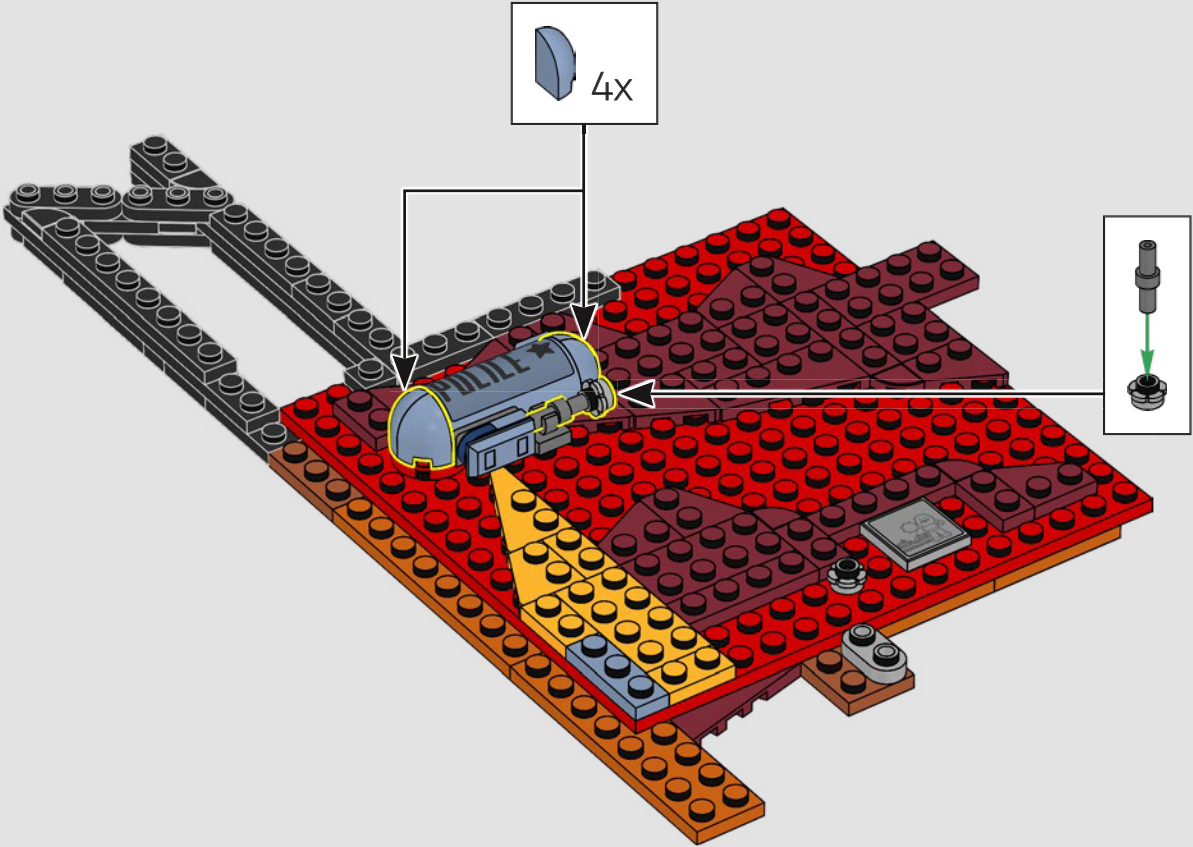

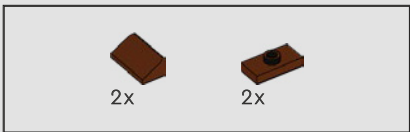

152

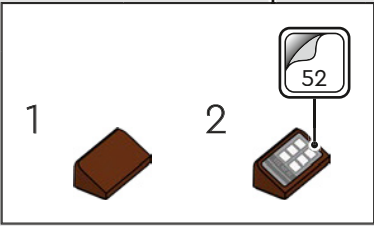
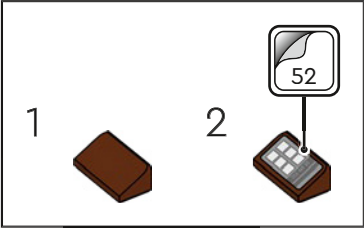
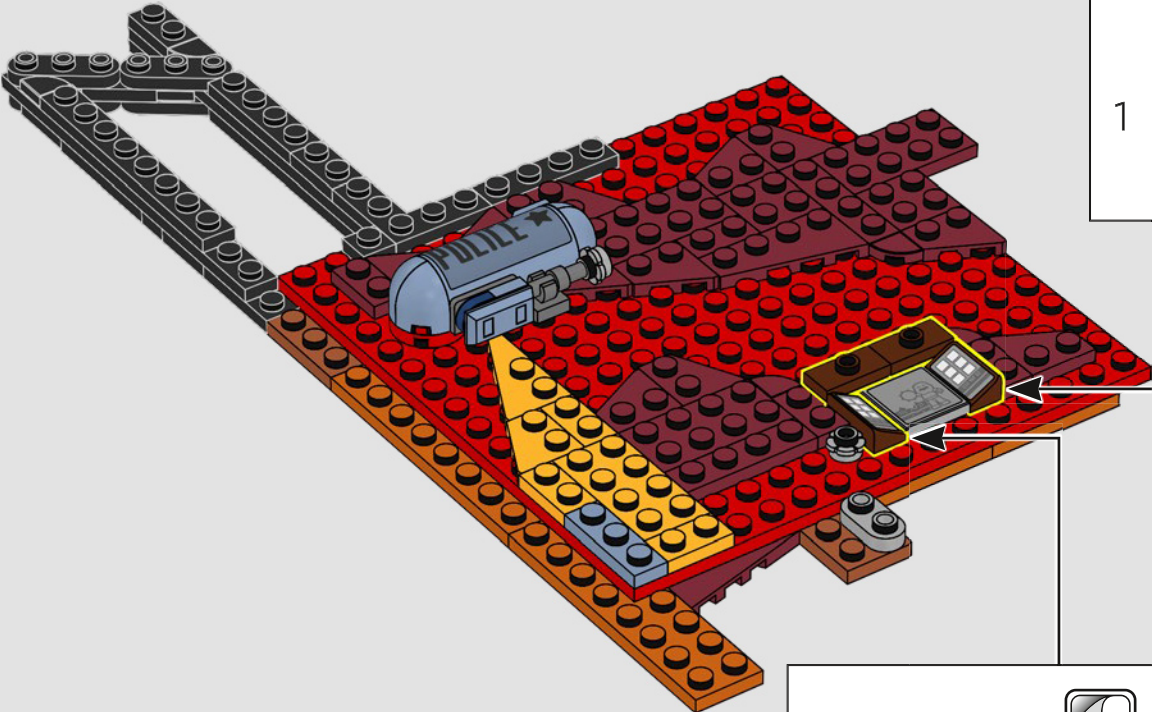

153

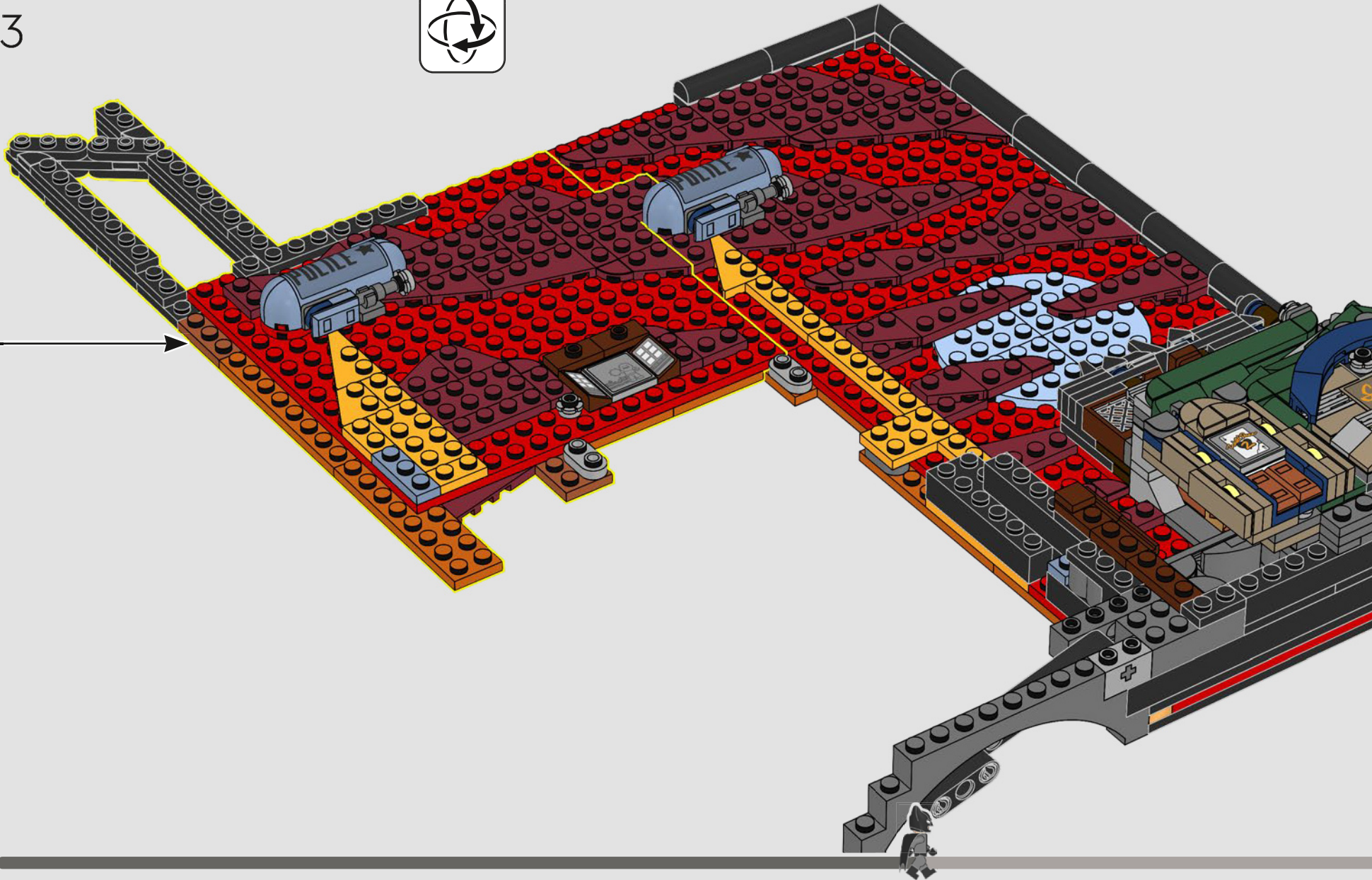

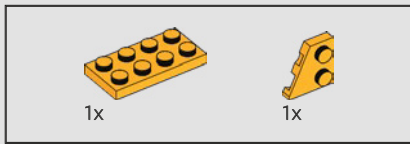

154

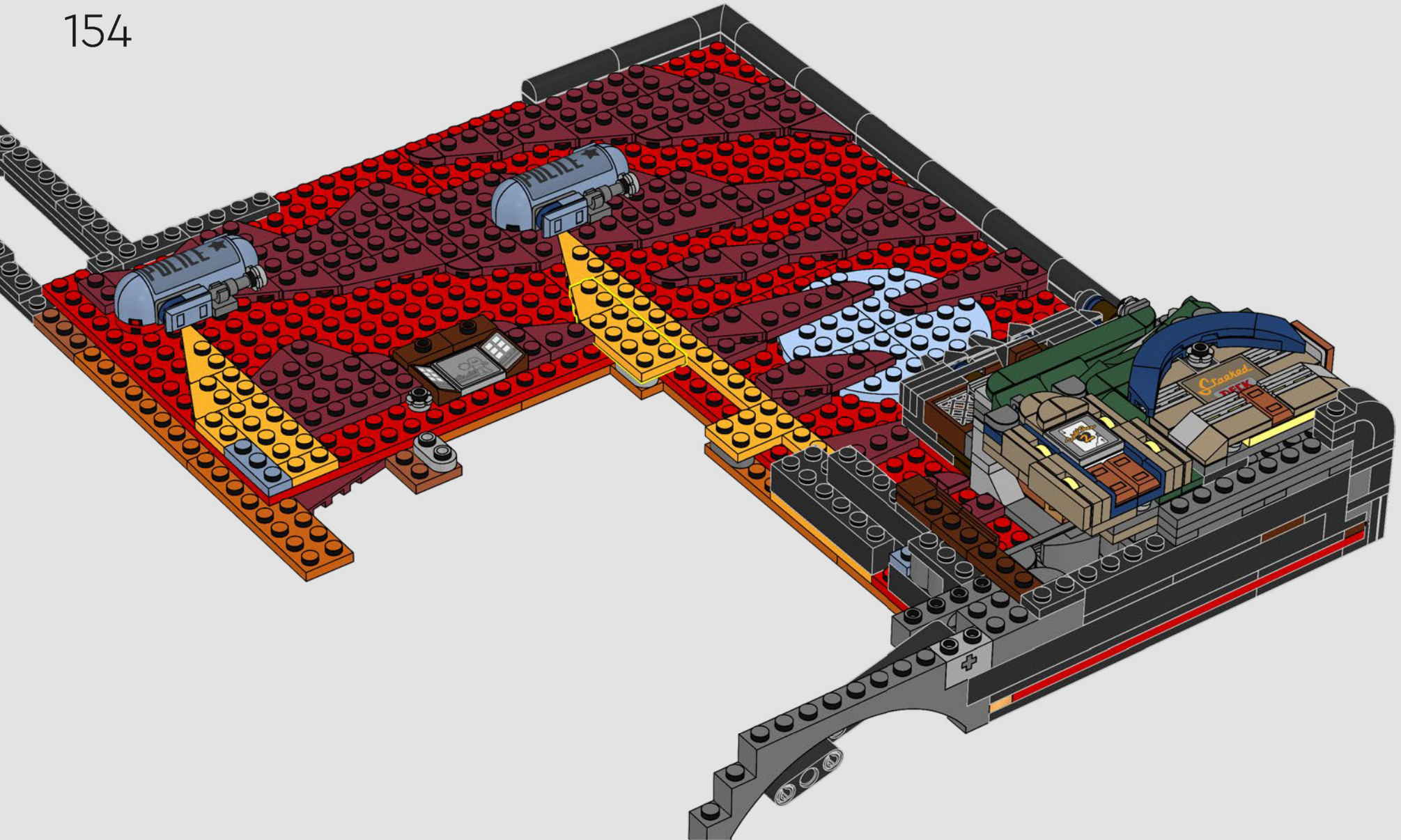

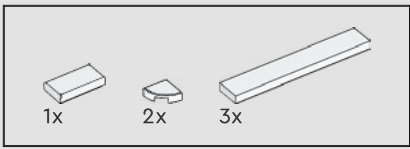

155

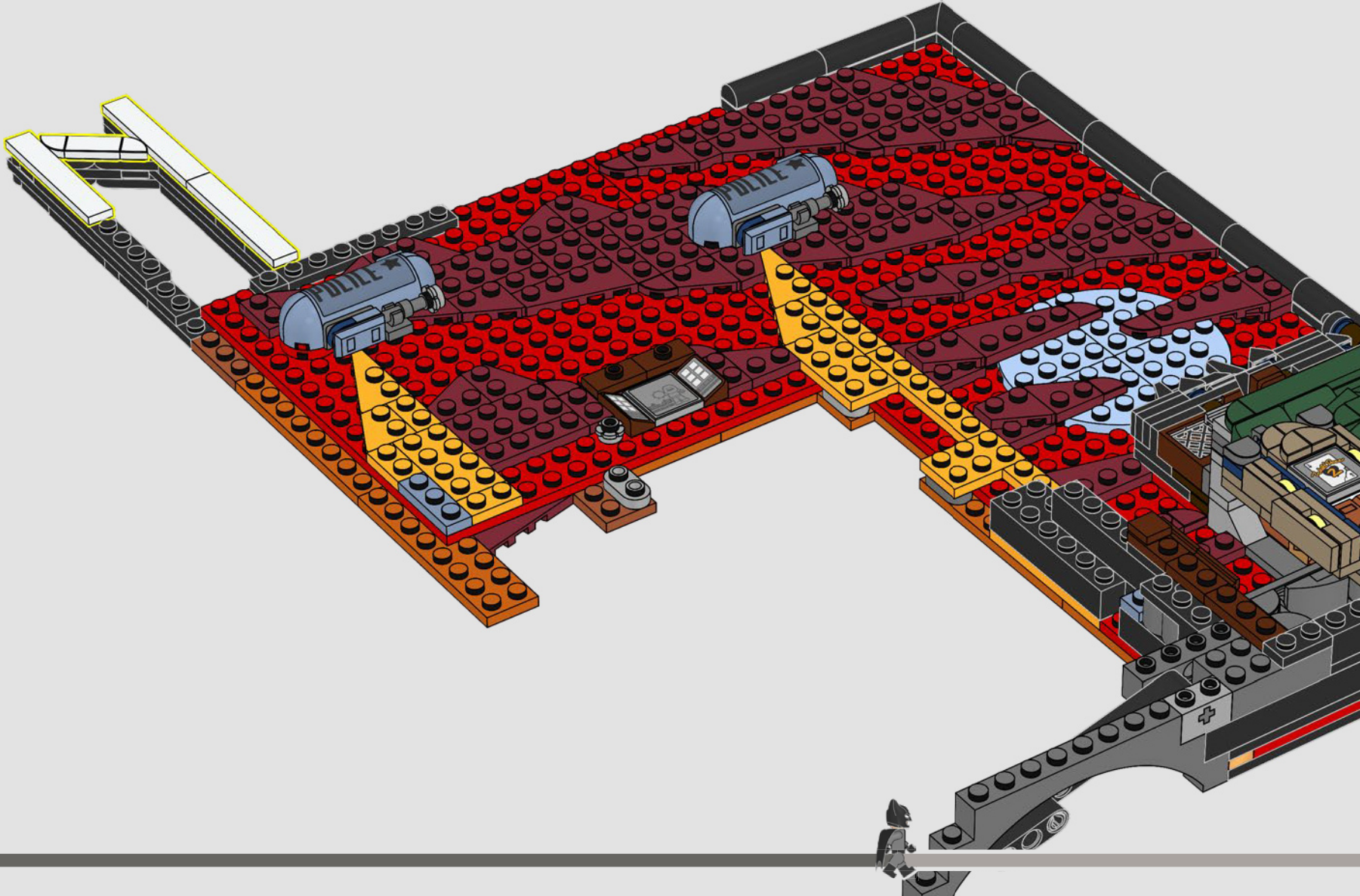

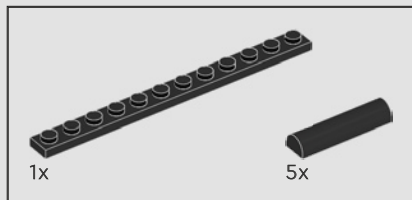

156

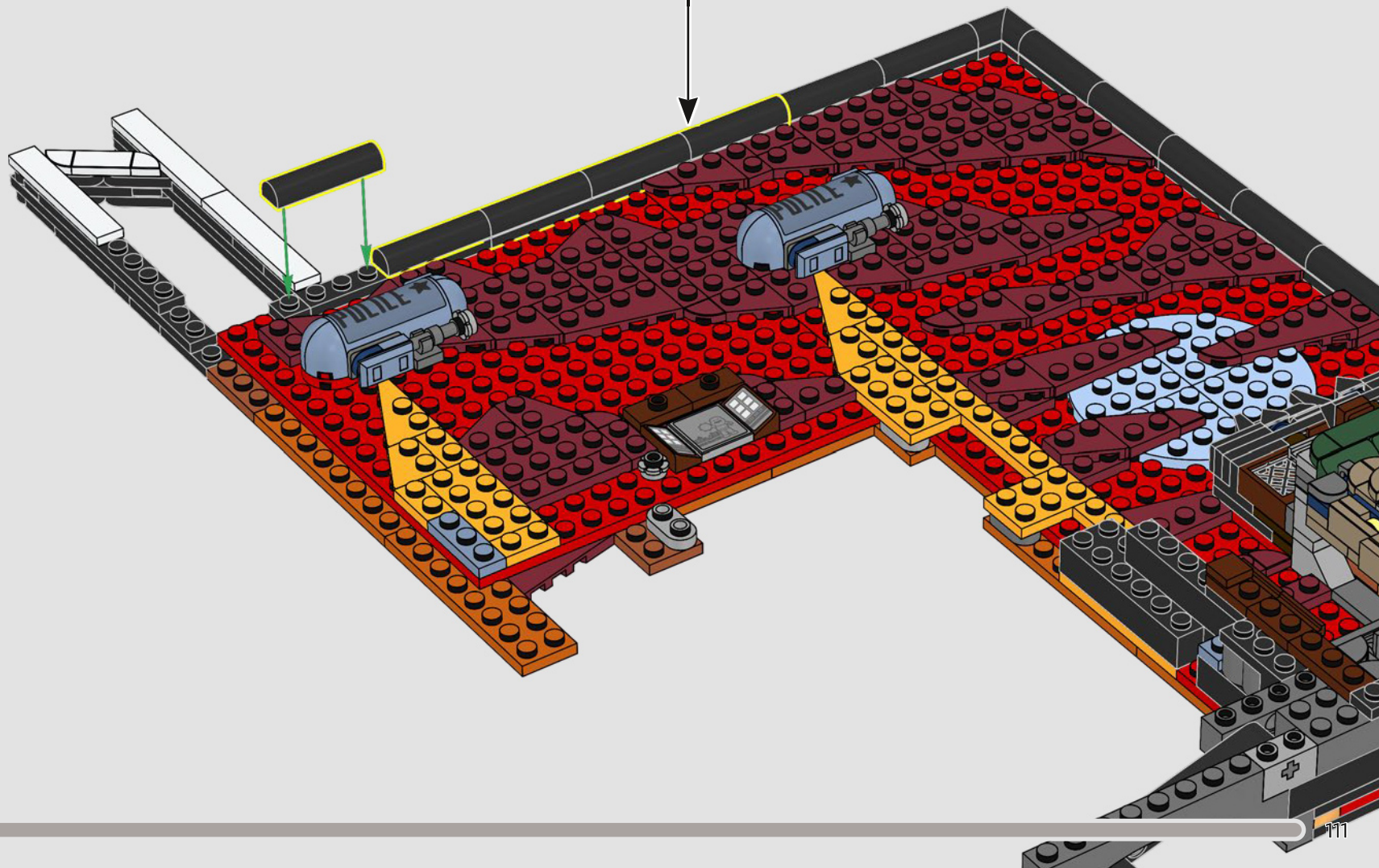
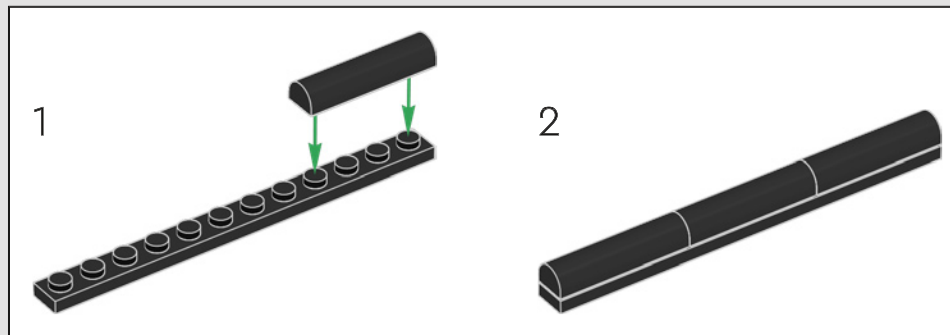

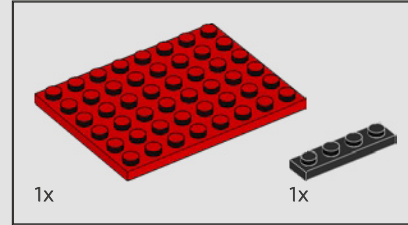
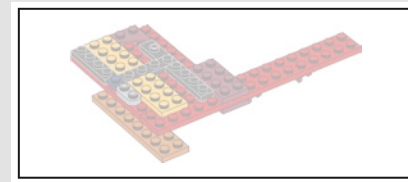

157

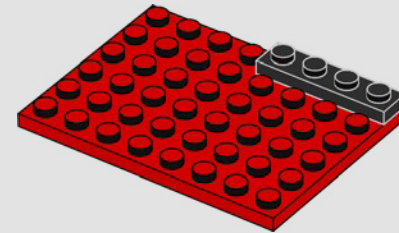

Episode: *If You're So Smart, Why Aren't You Rich?*
Épisode : *L'énigme du Minotaure*
Episodio: *Si eres tan inteligente, ¿por qué no eres rico?*



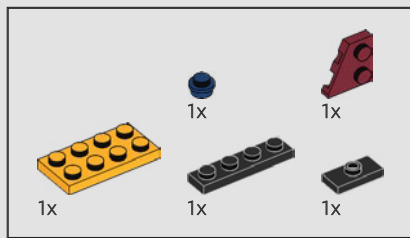

158

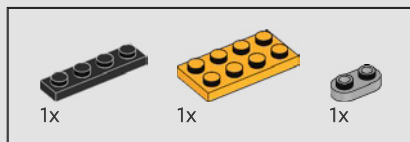
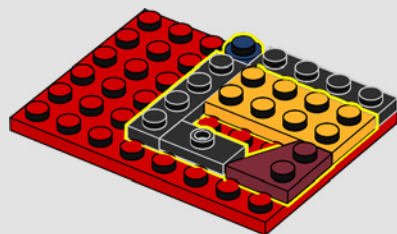

159

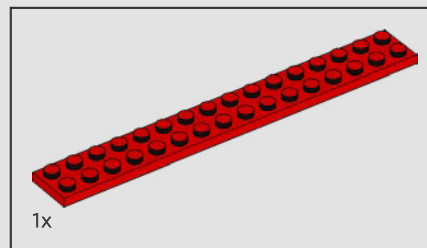
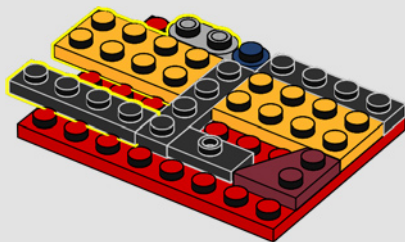

160

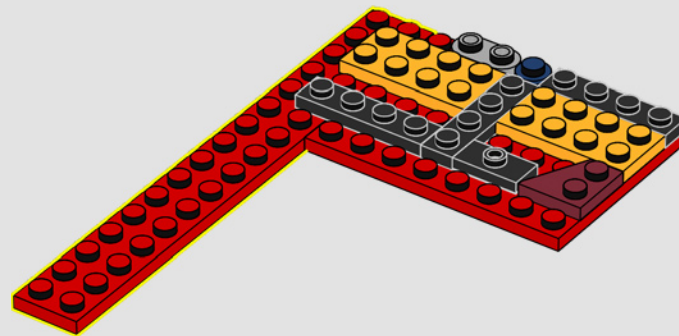

161

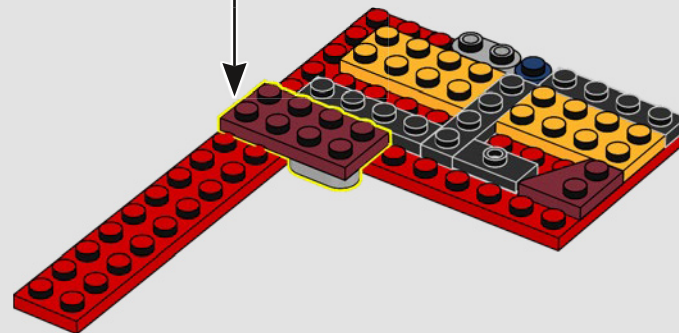
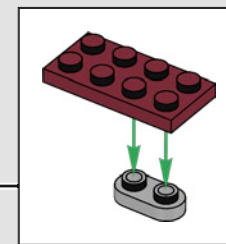

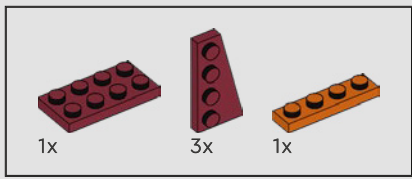

162

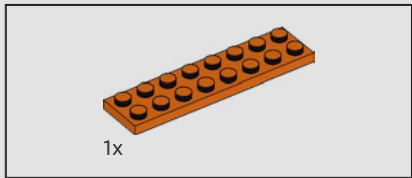
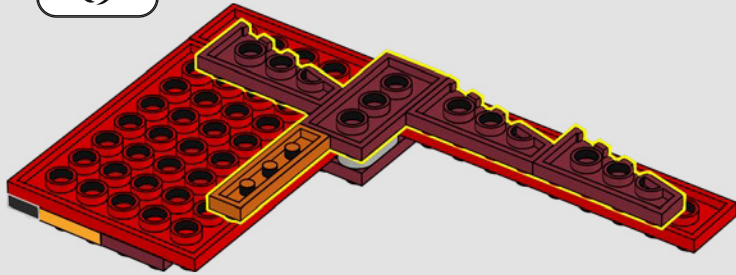

163

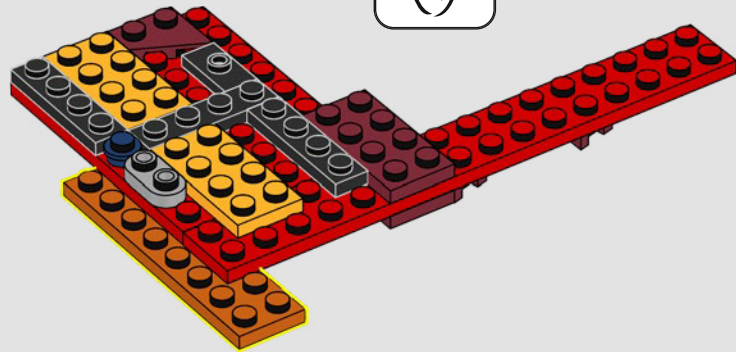

164

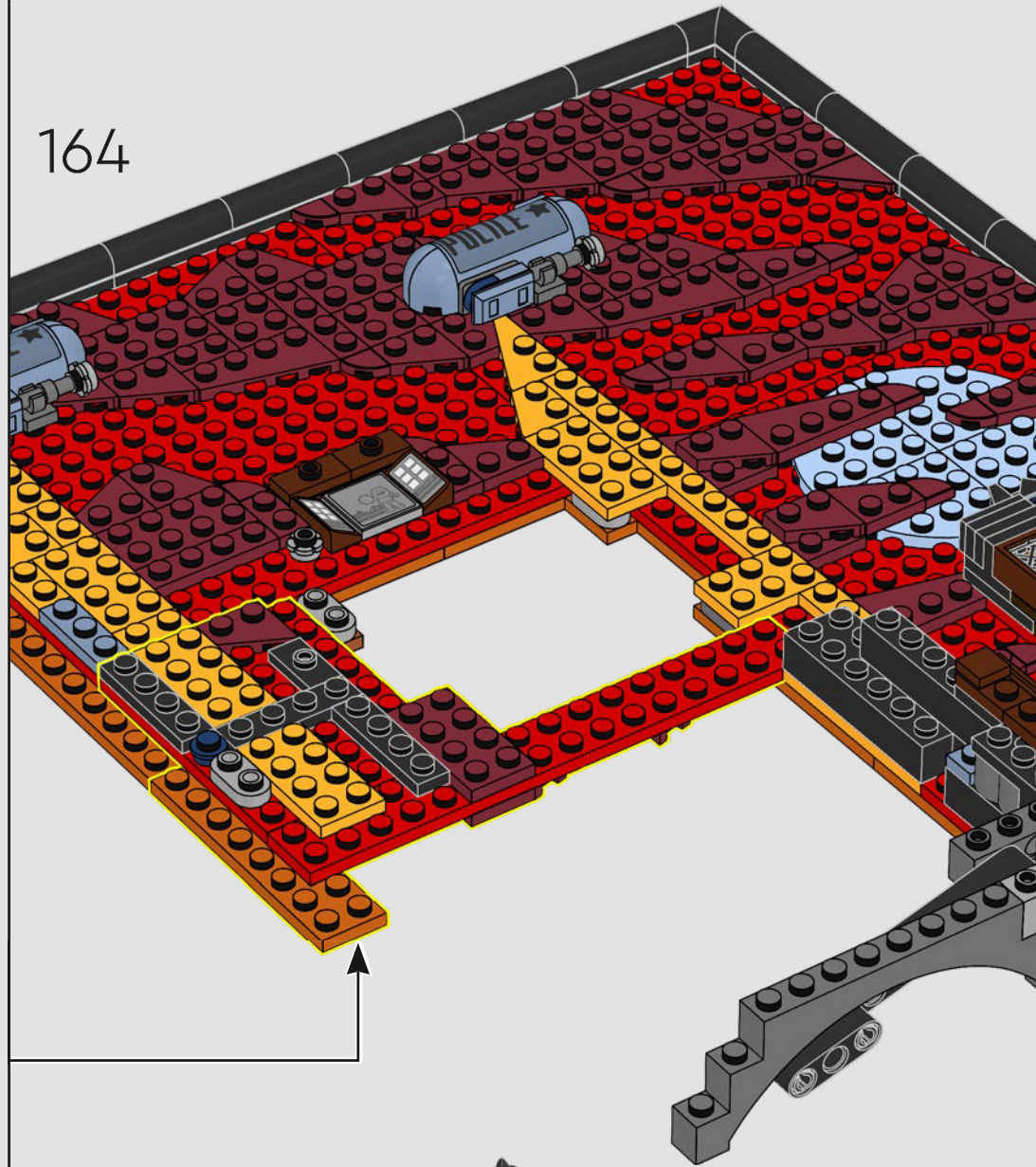

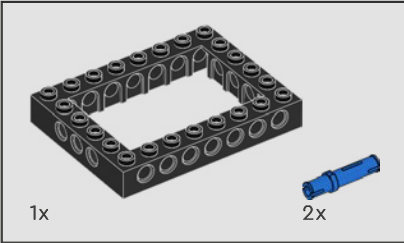
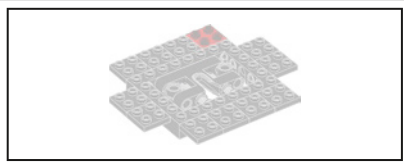

165

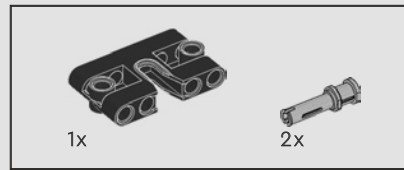
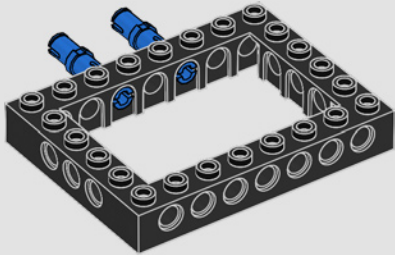

166

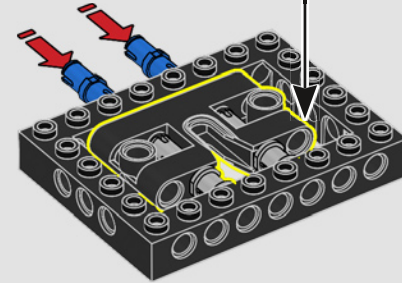
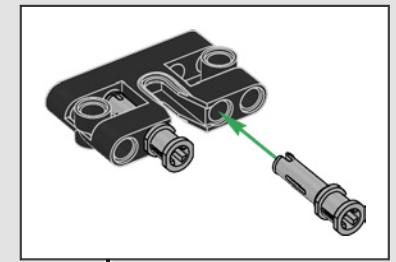

167

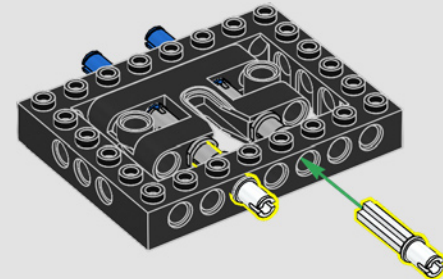



168

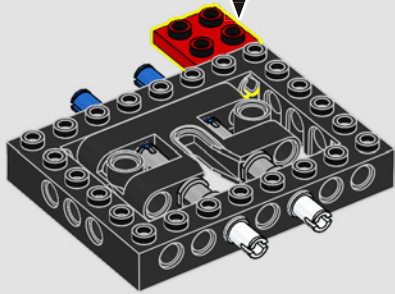
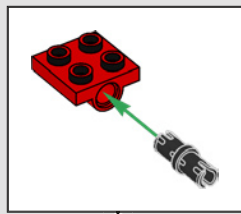

169

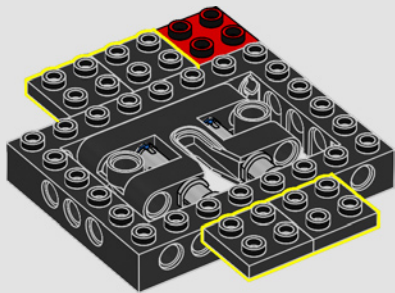

170

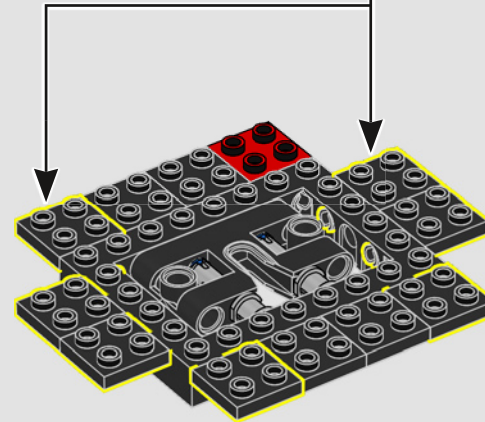
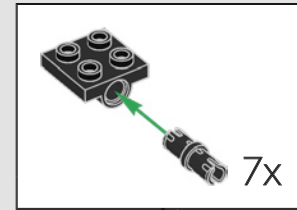

171

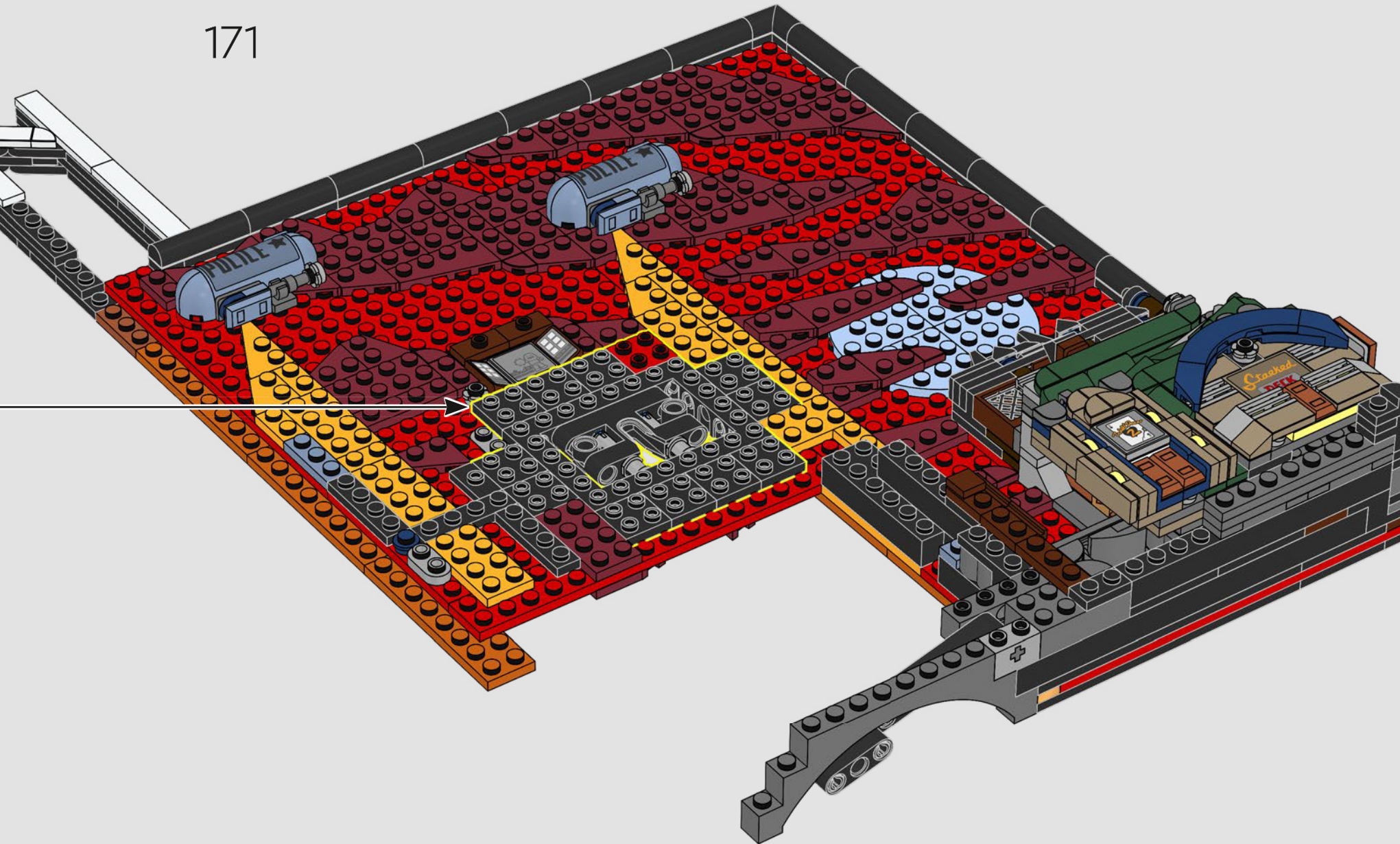

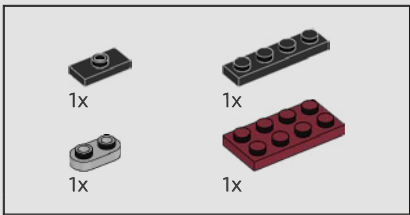

172

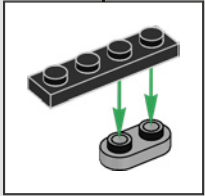
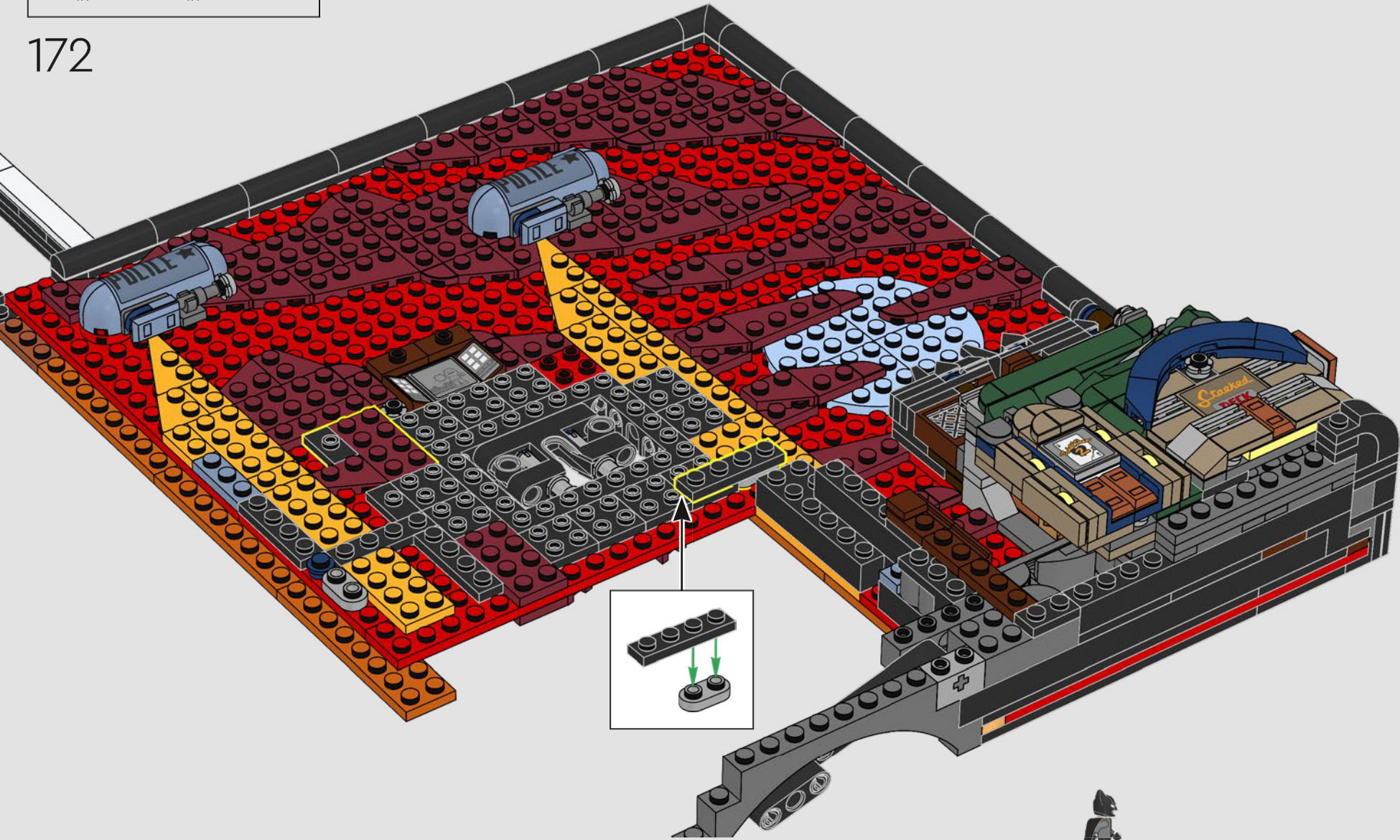

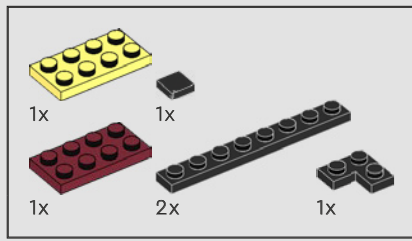

173

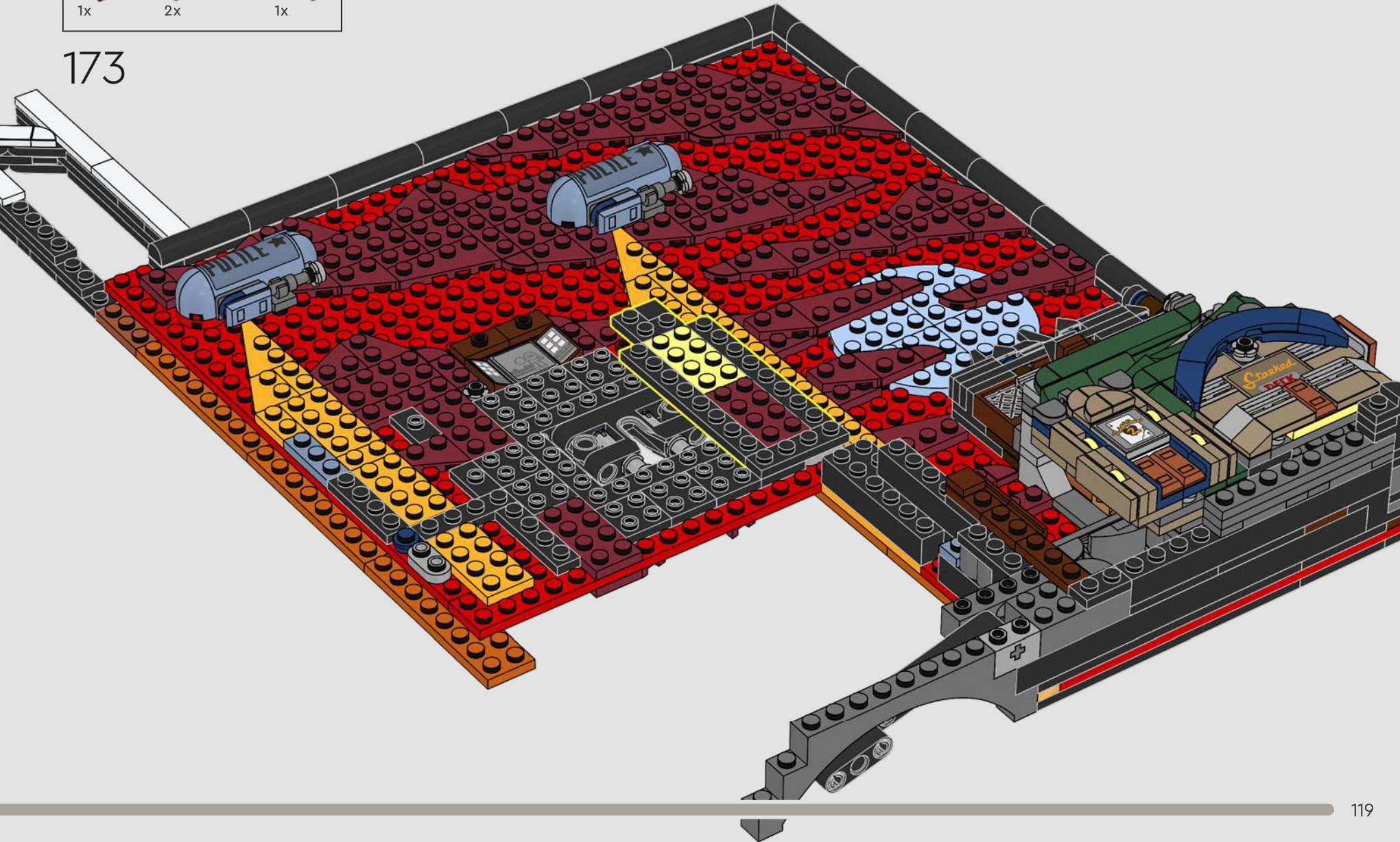

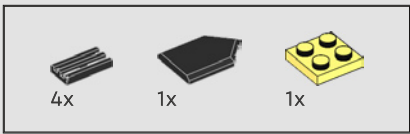

174

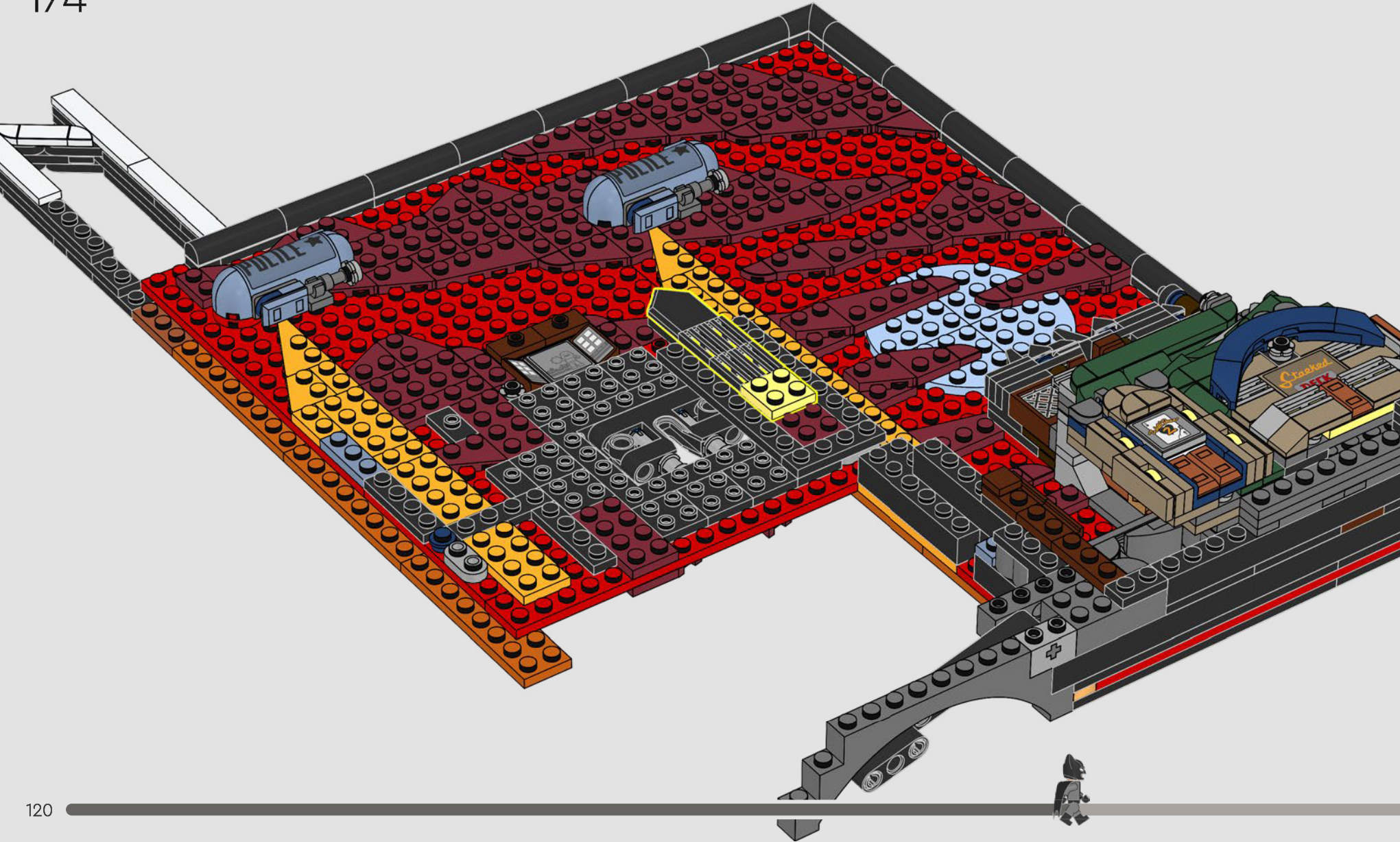



175

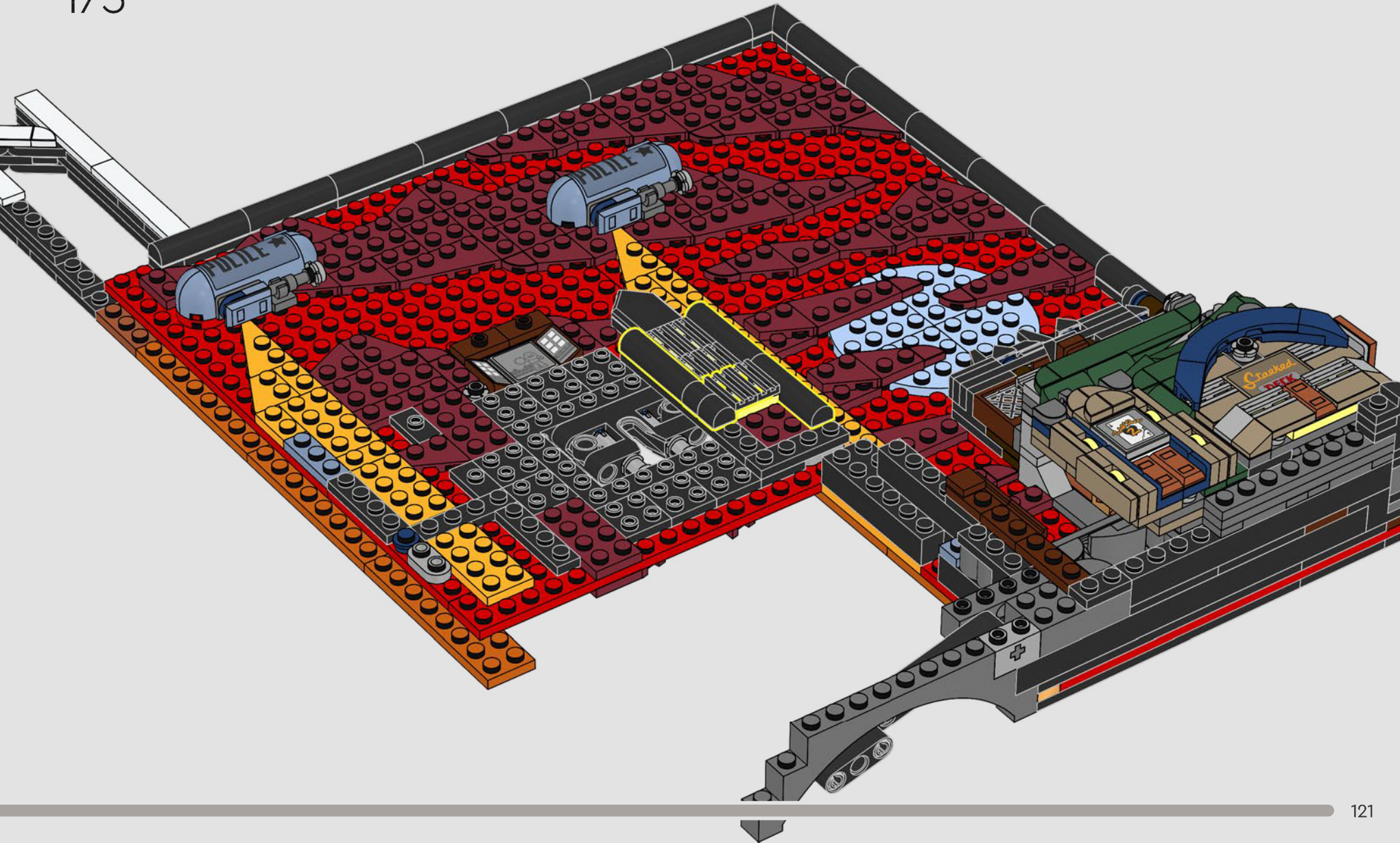

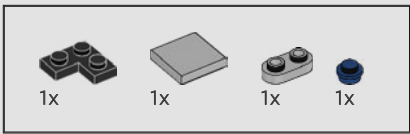

176

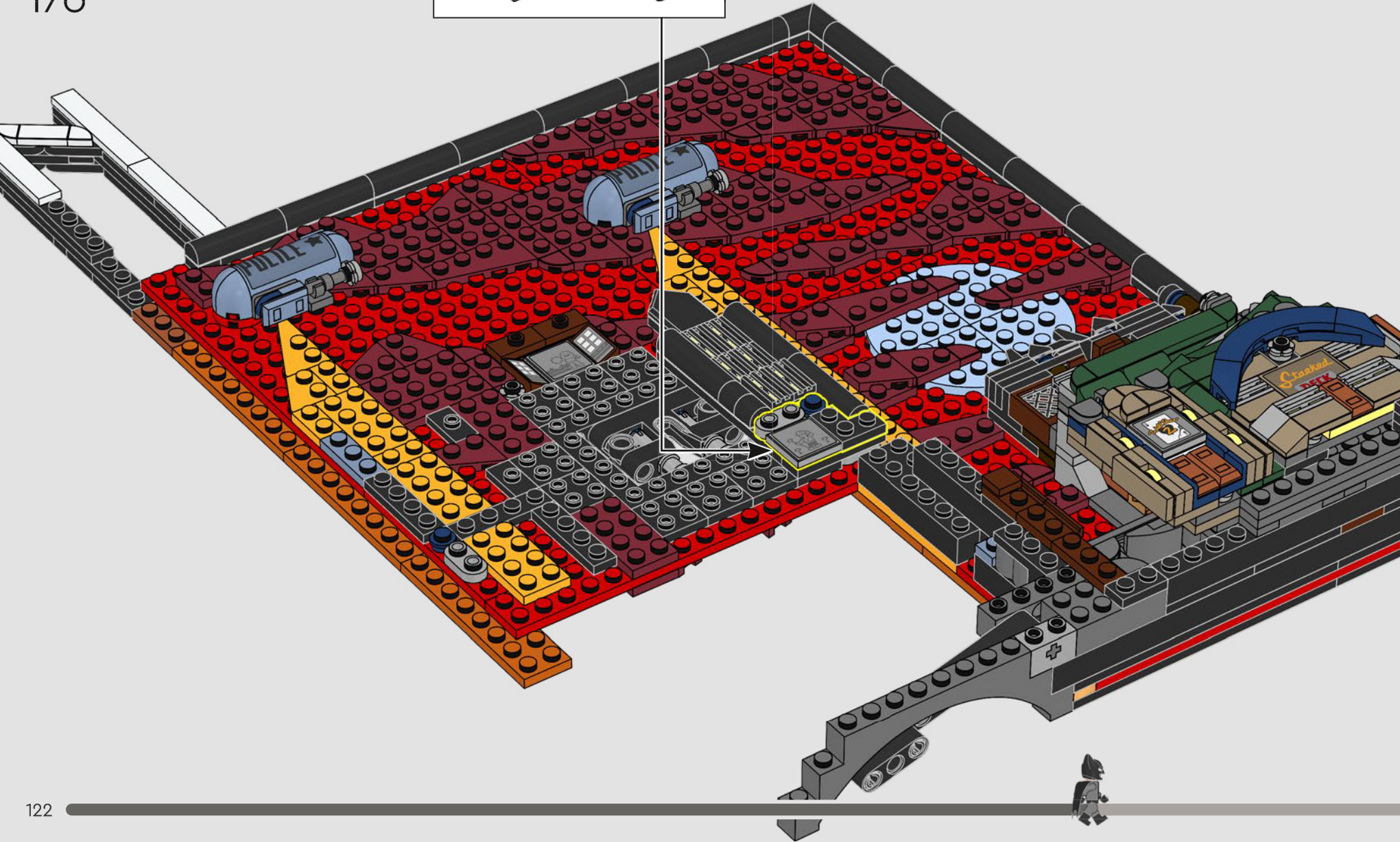
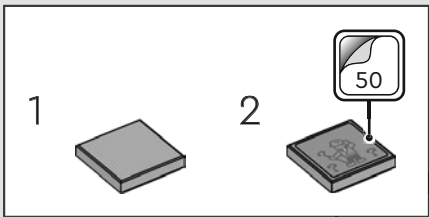

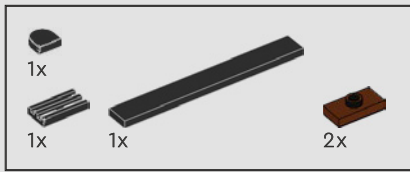

177

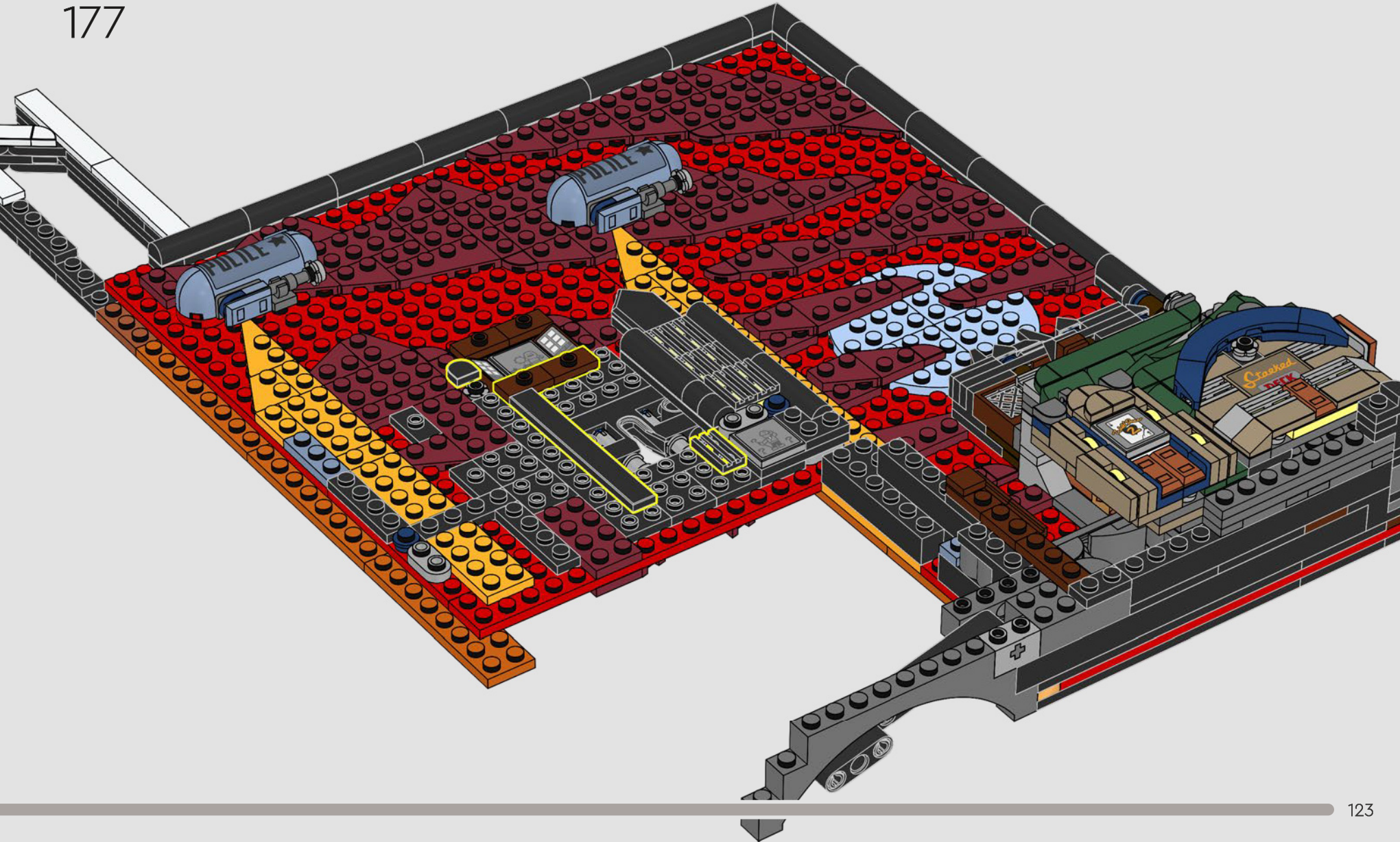

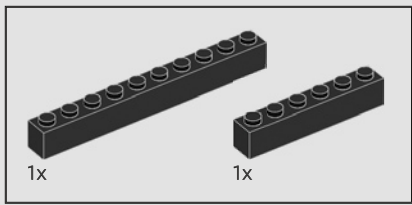

178

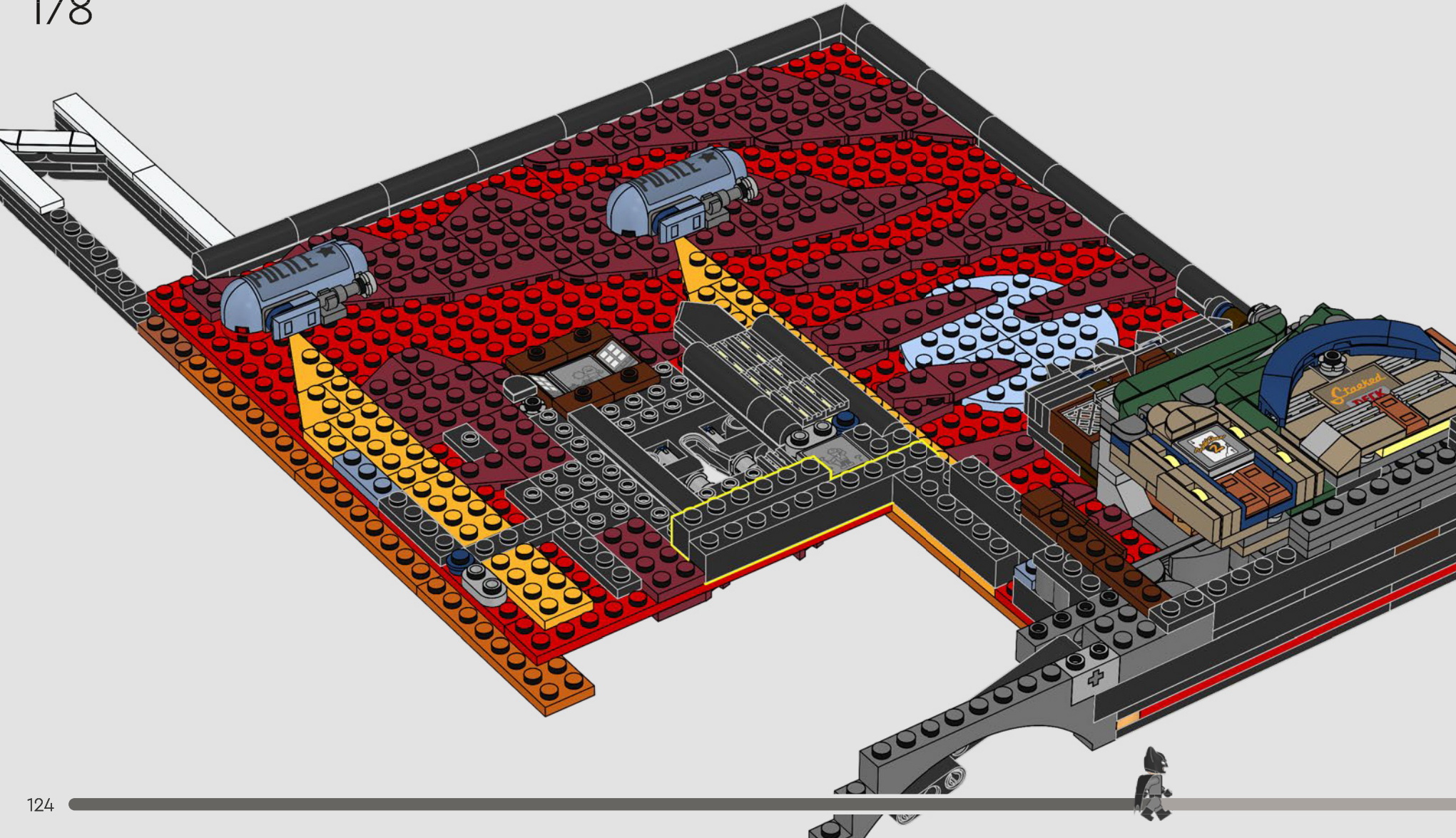

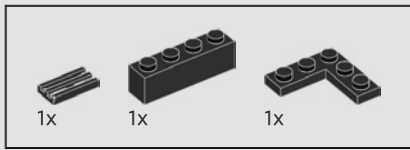

179

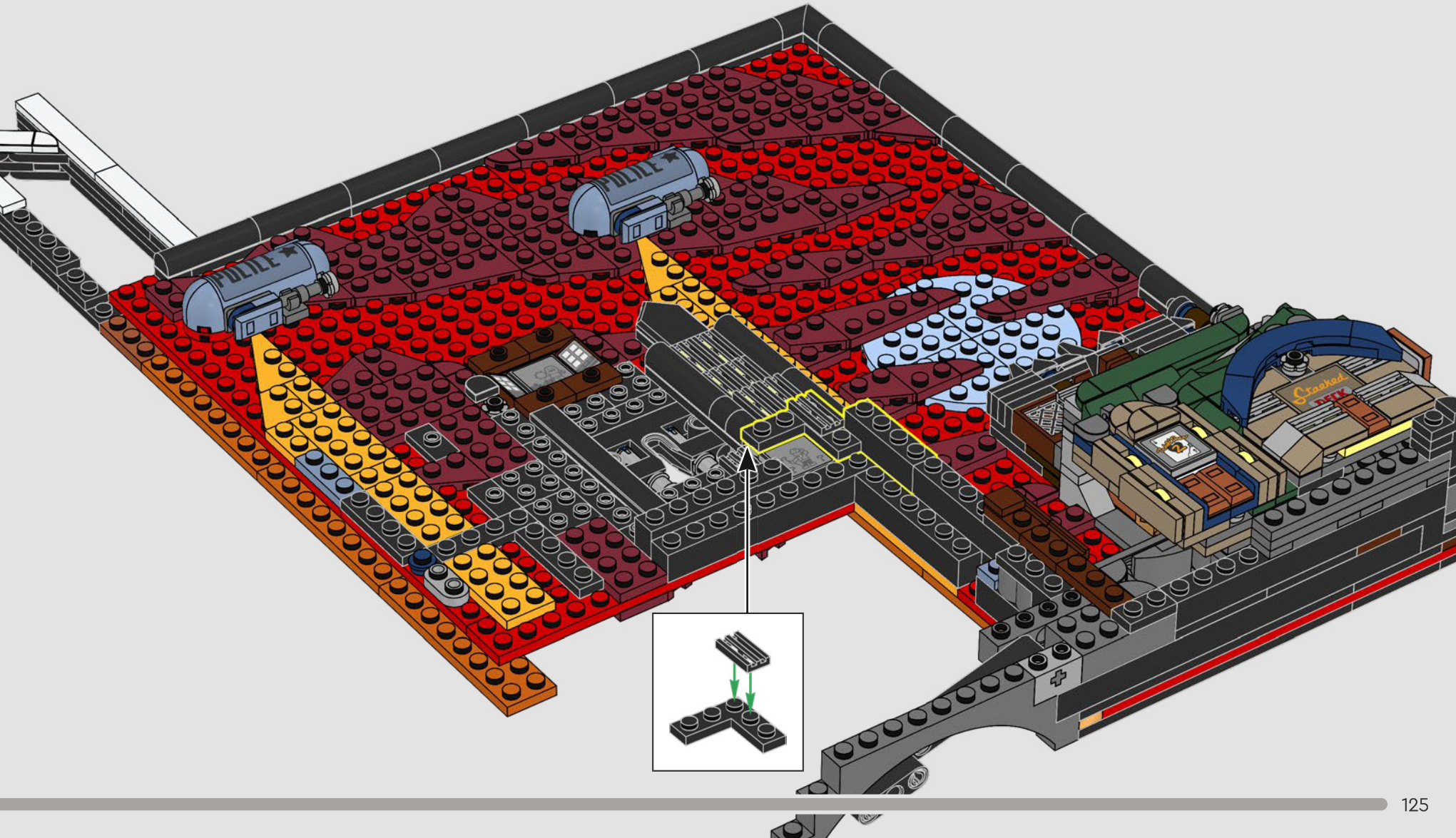

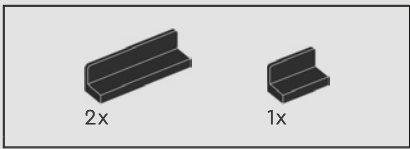

180

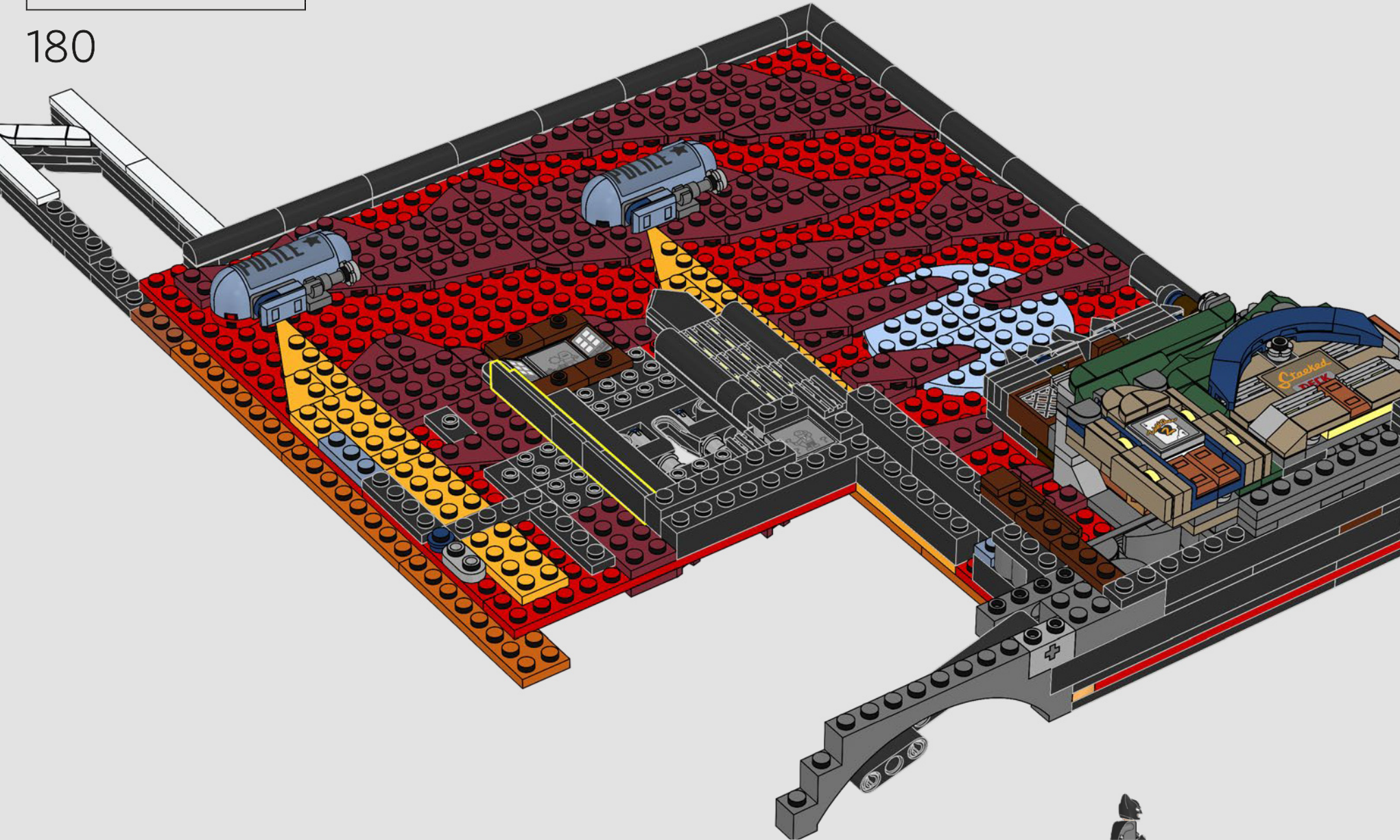

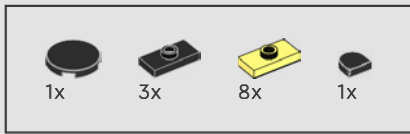

181

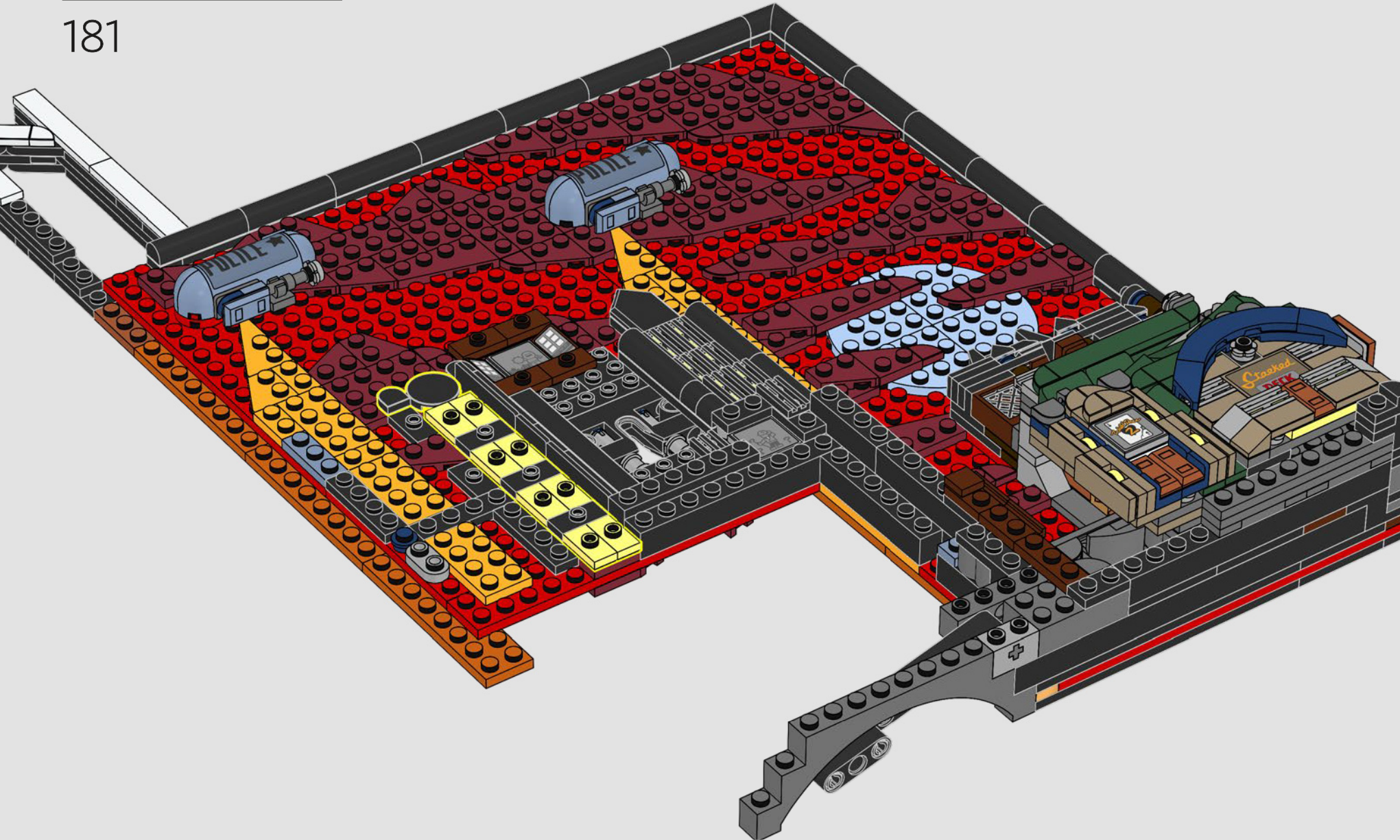

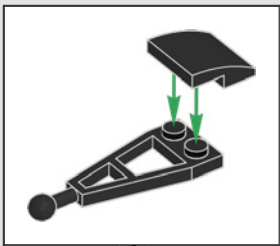
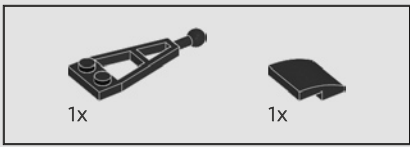

182

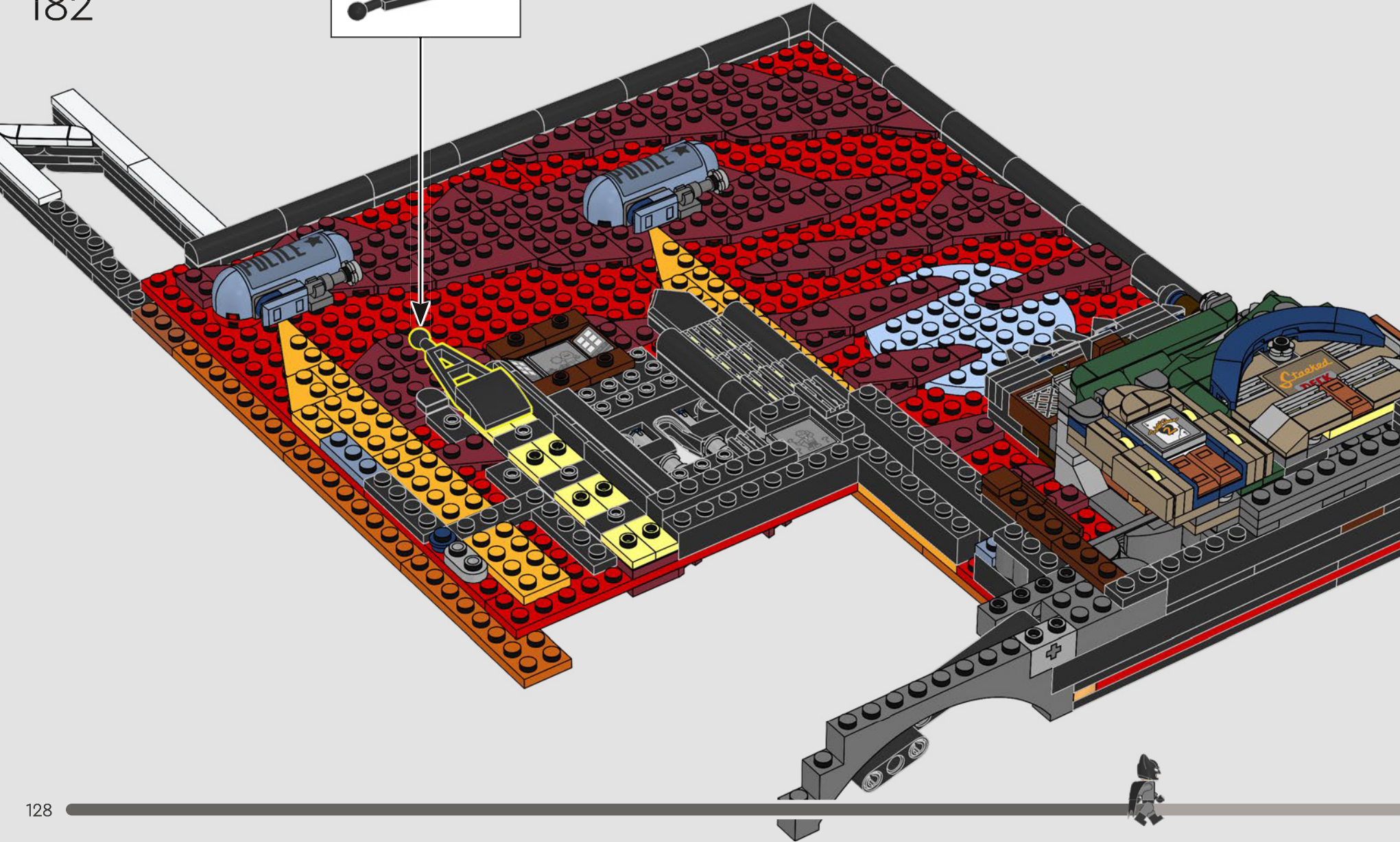

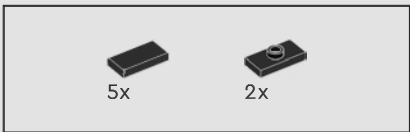

183

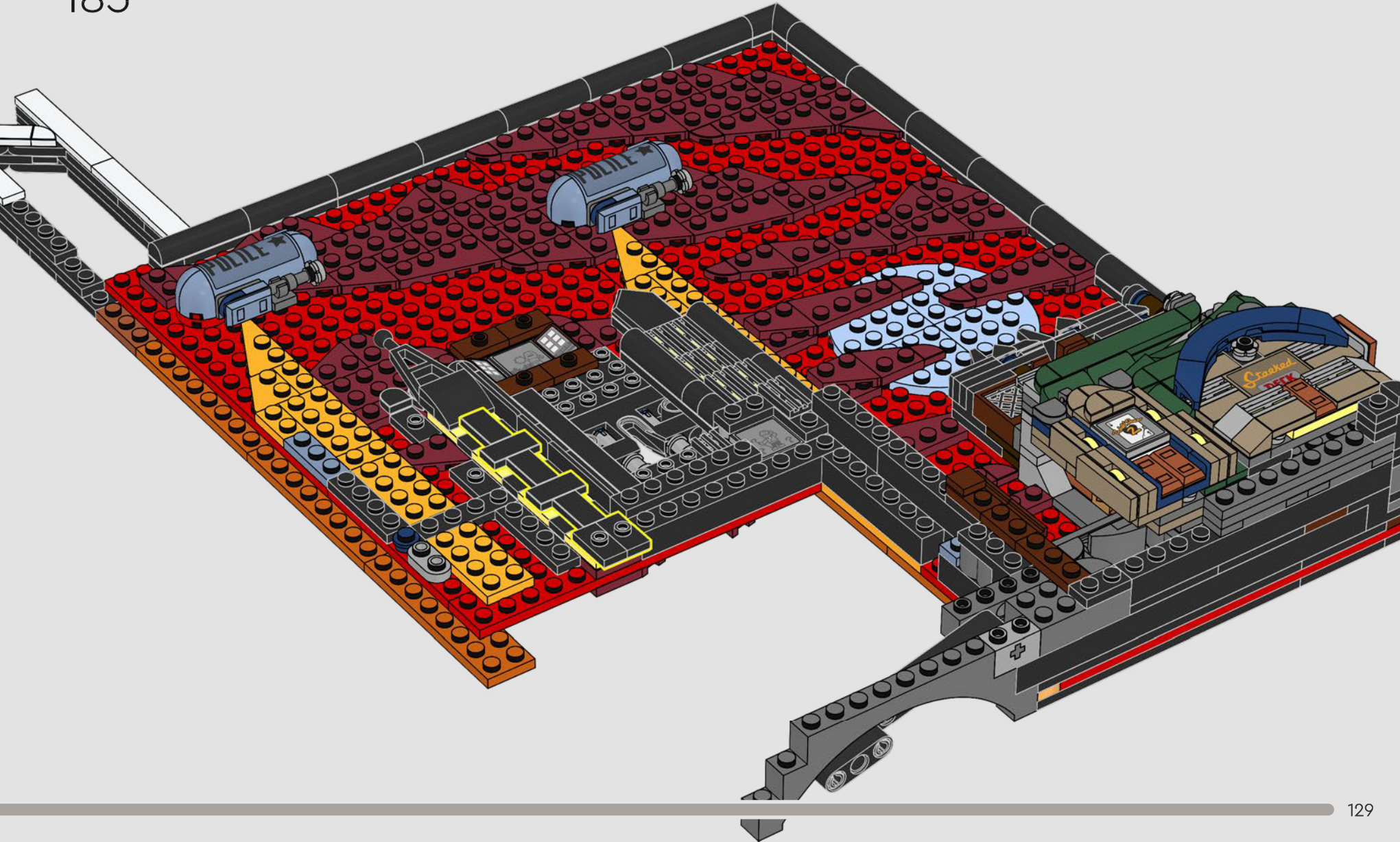

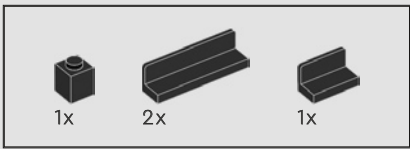

184

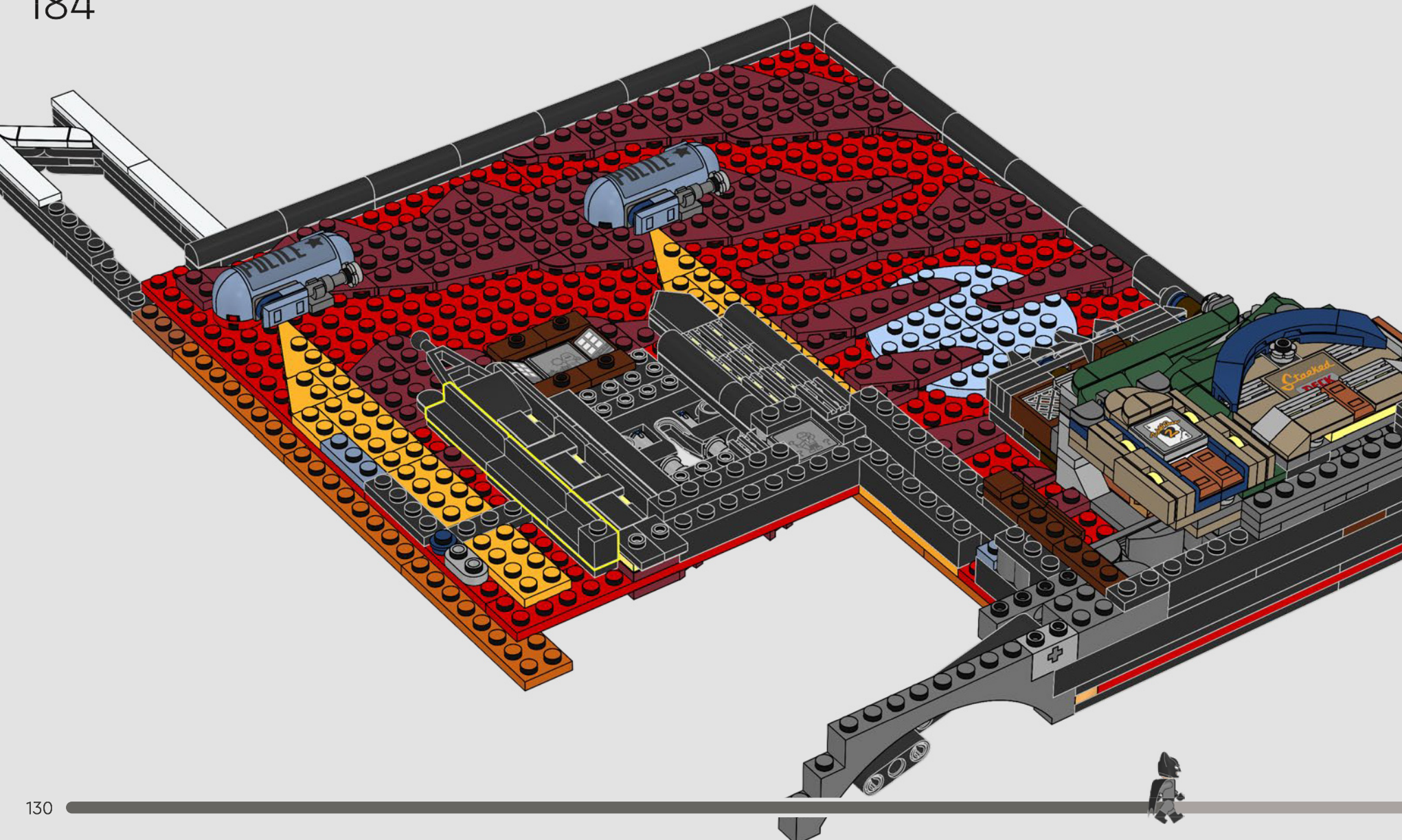

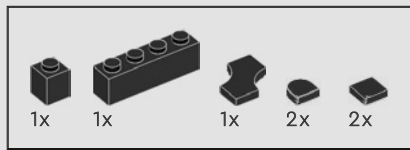

185

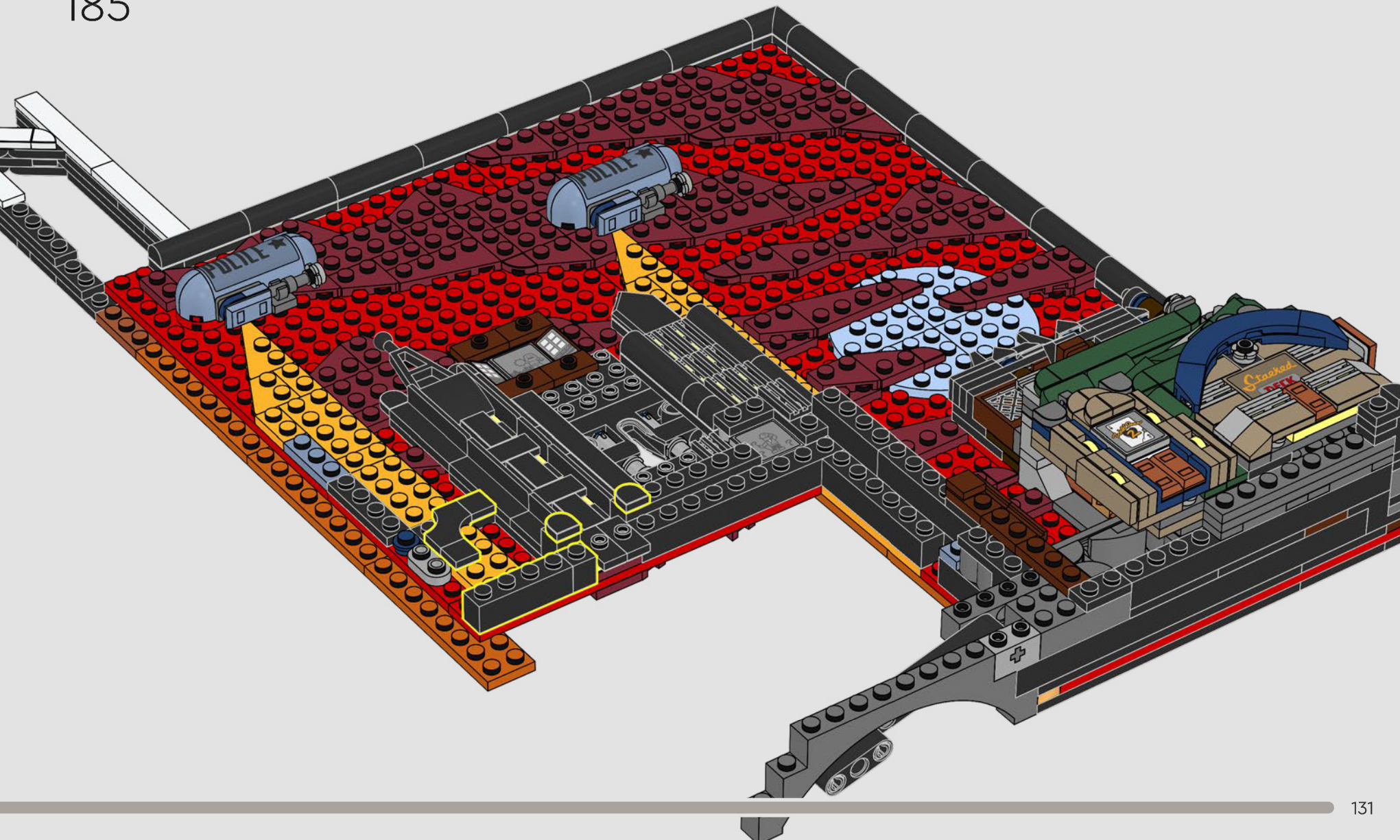

Episode: Catwalk
Épisode : À pas de velours
Episodio: A ritmo de una gata

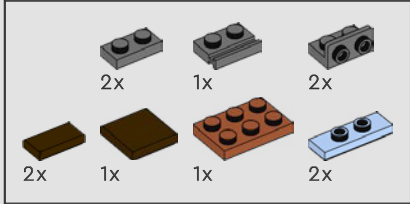

186

- 1
- 2
- 3
- 4
- 5



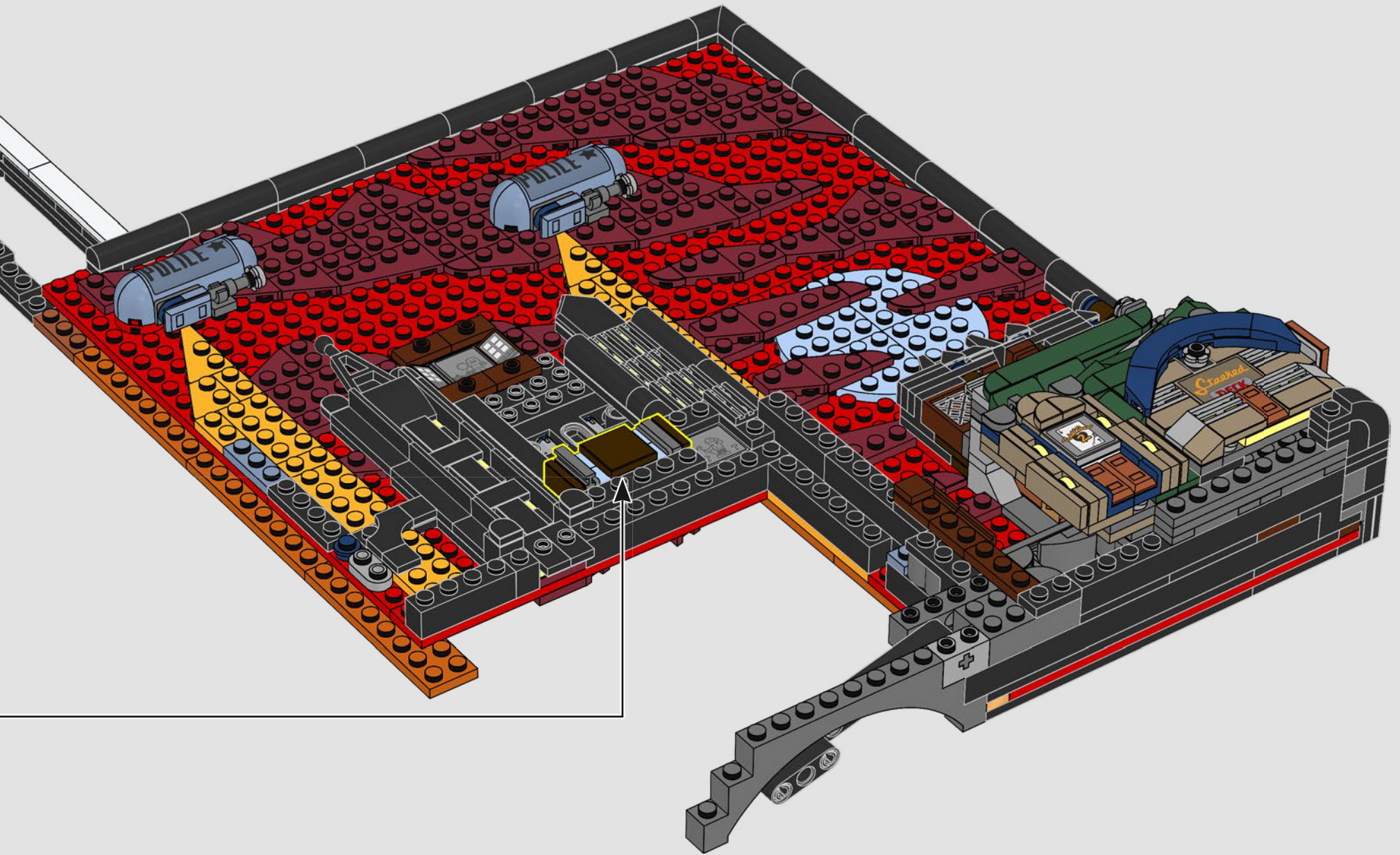

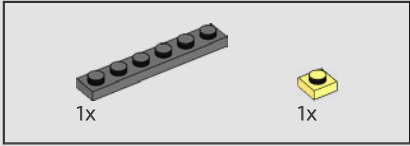
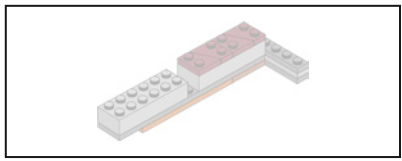

187

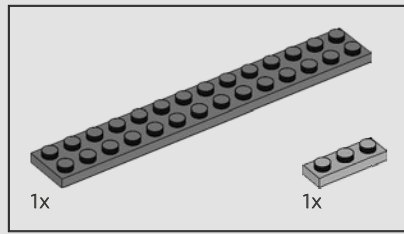
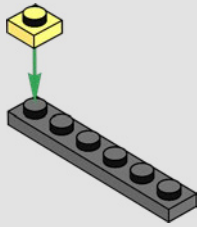

188

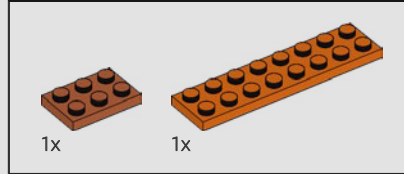
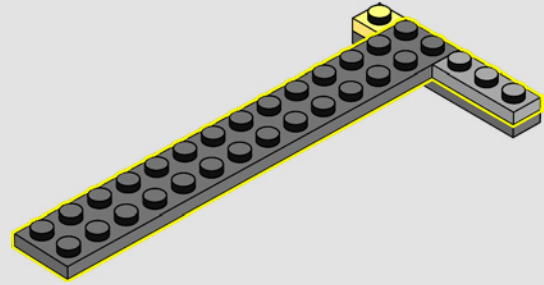

189

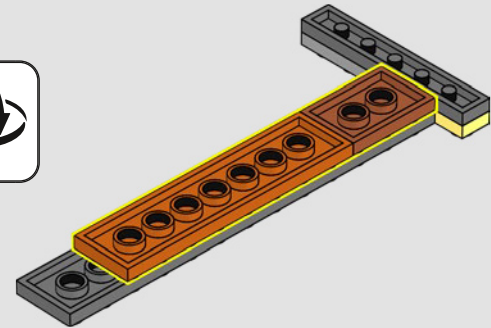

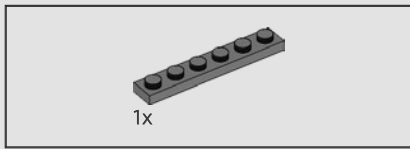

190

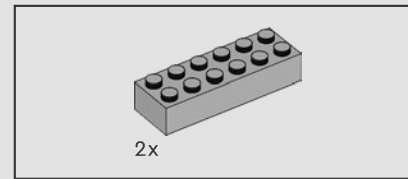
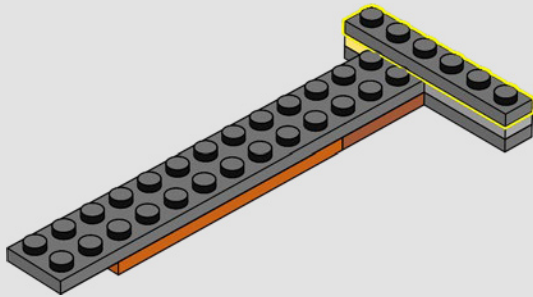

191

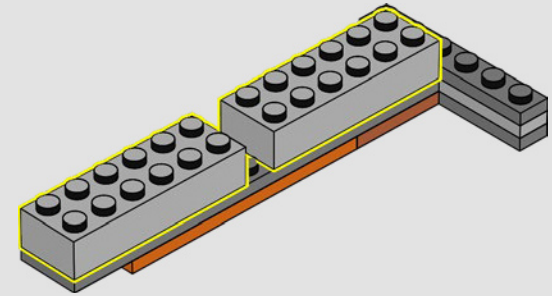

192

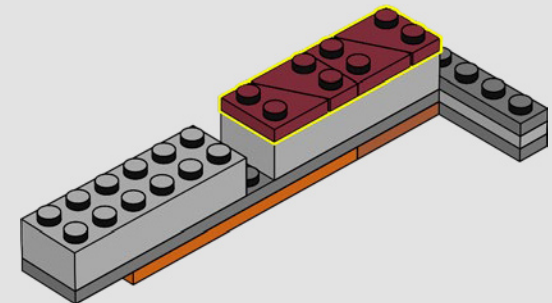

193

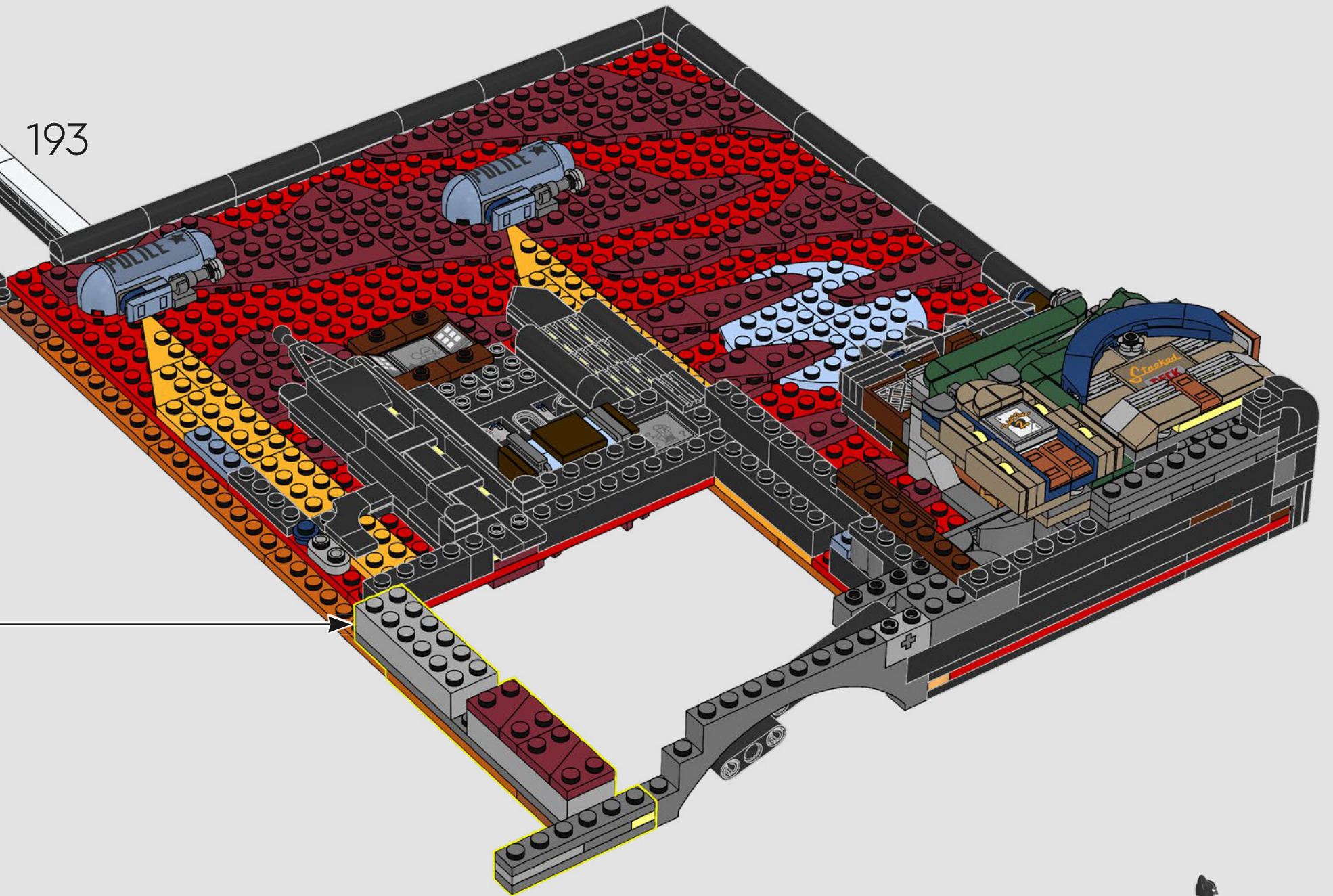

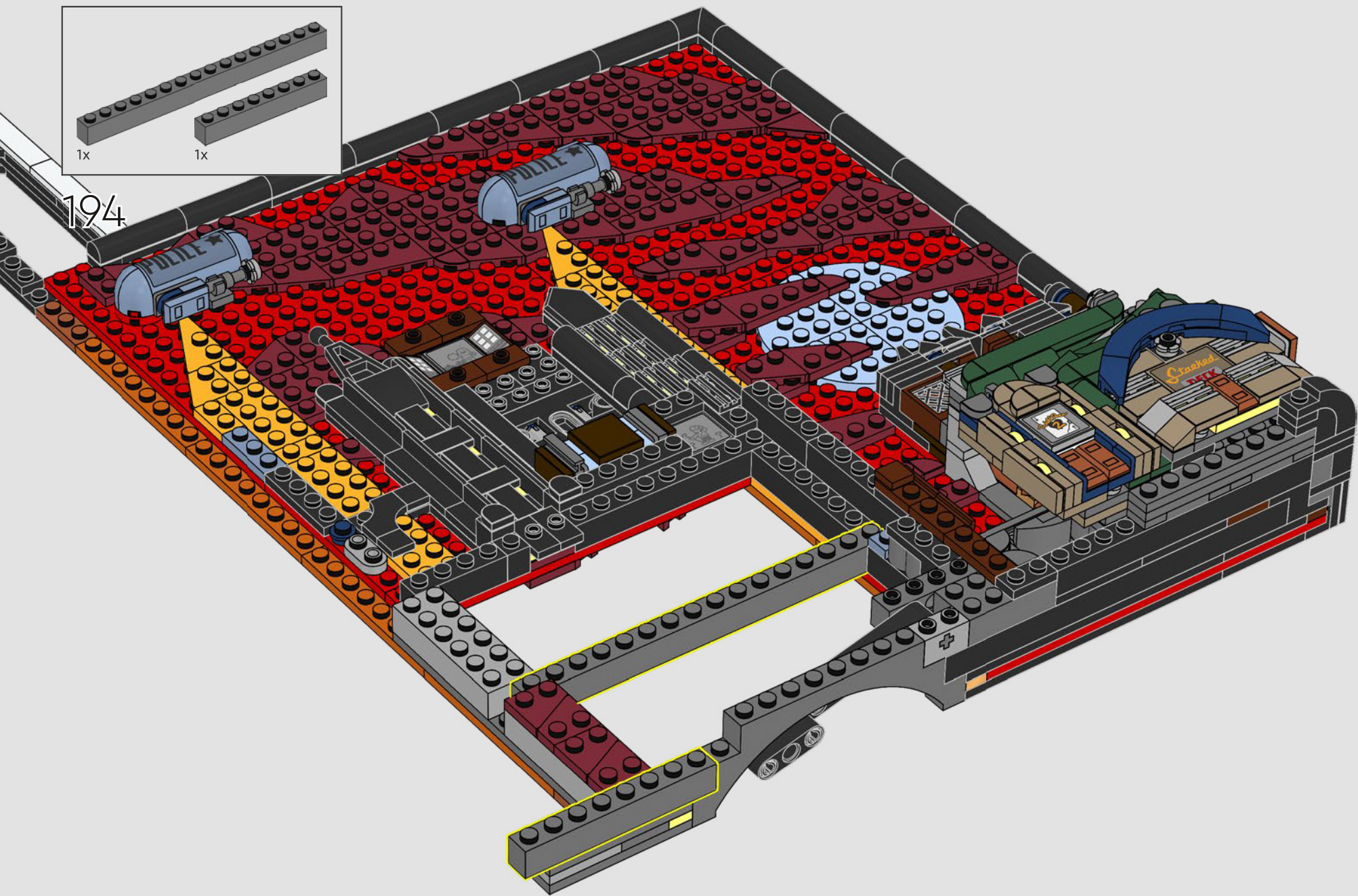

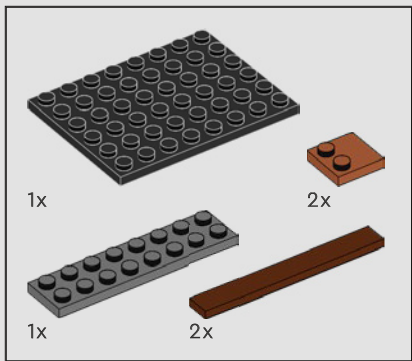

195

1

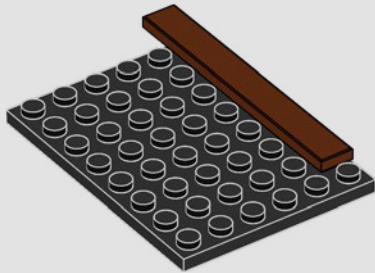

2

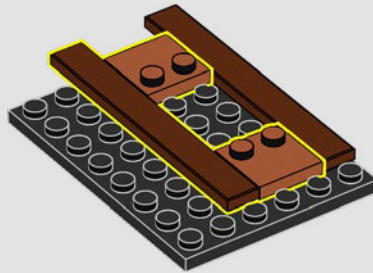

3

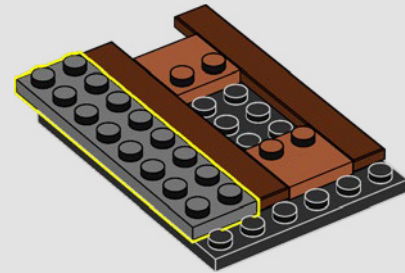

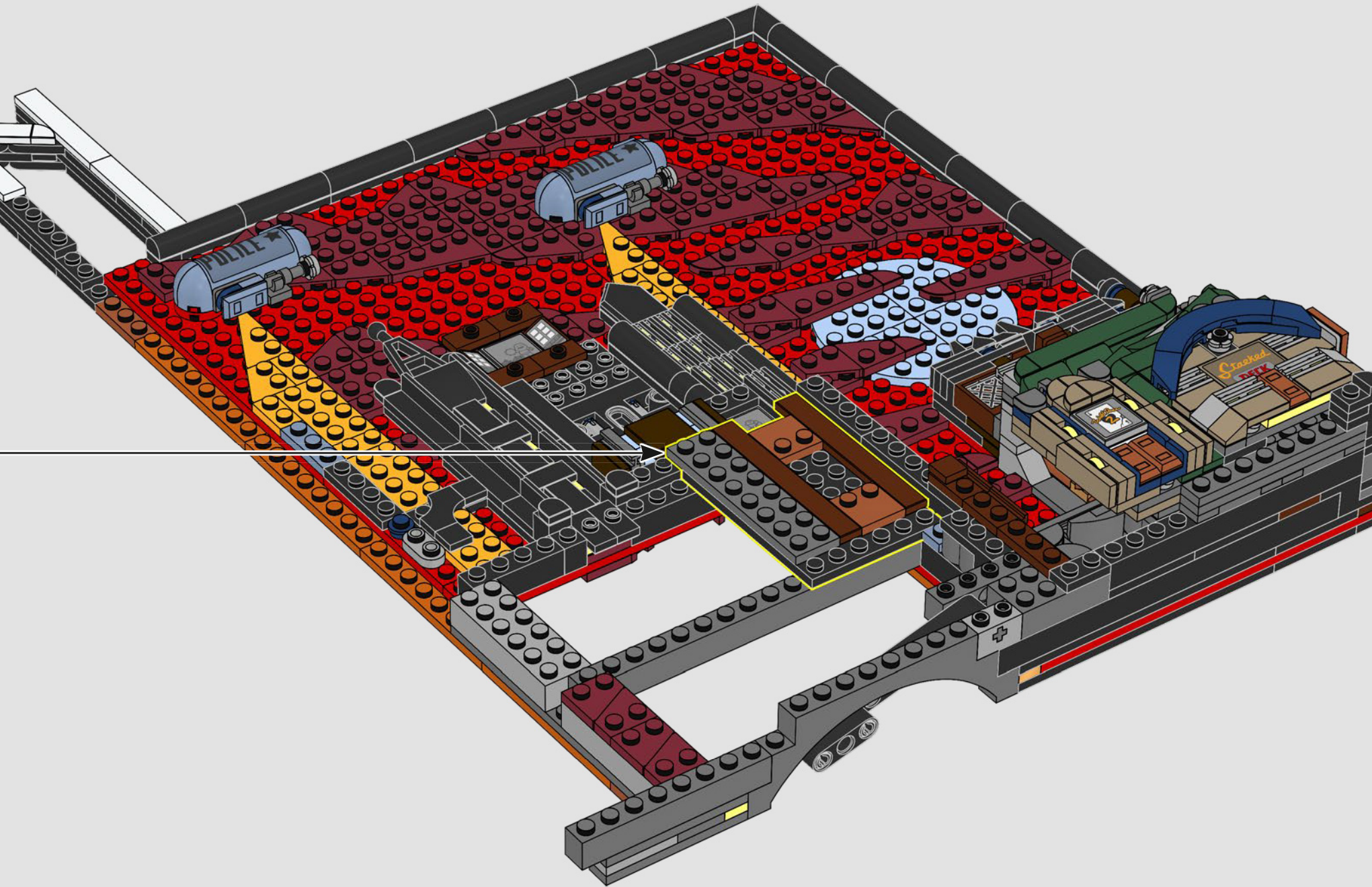

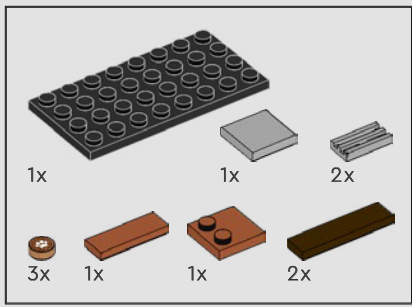

196

1

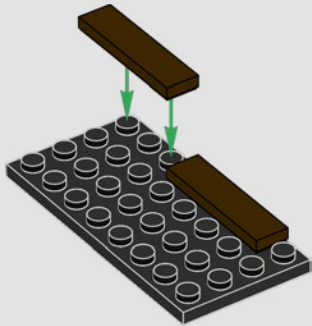

2

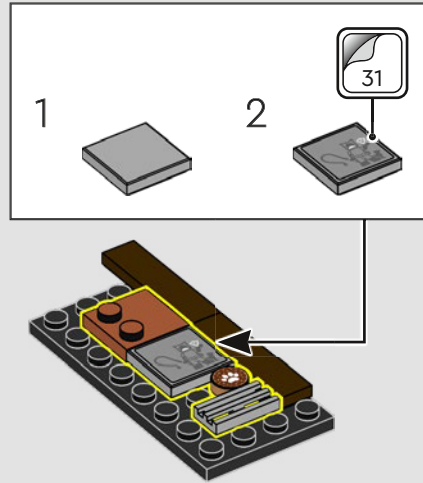

3

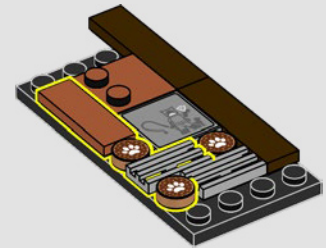

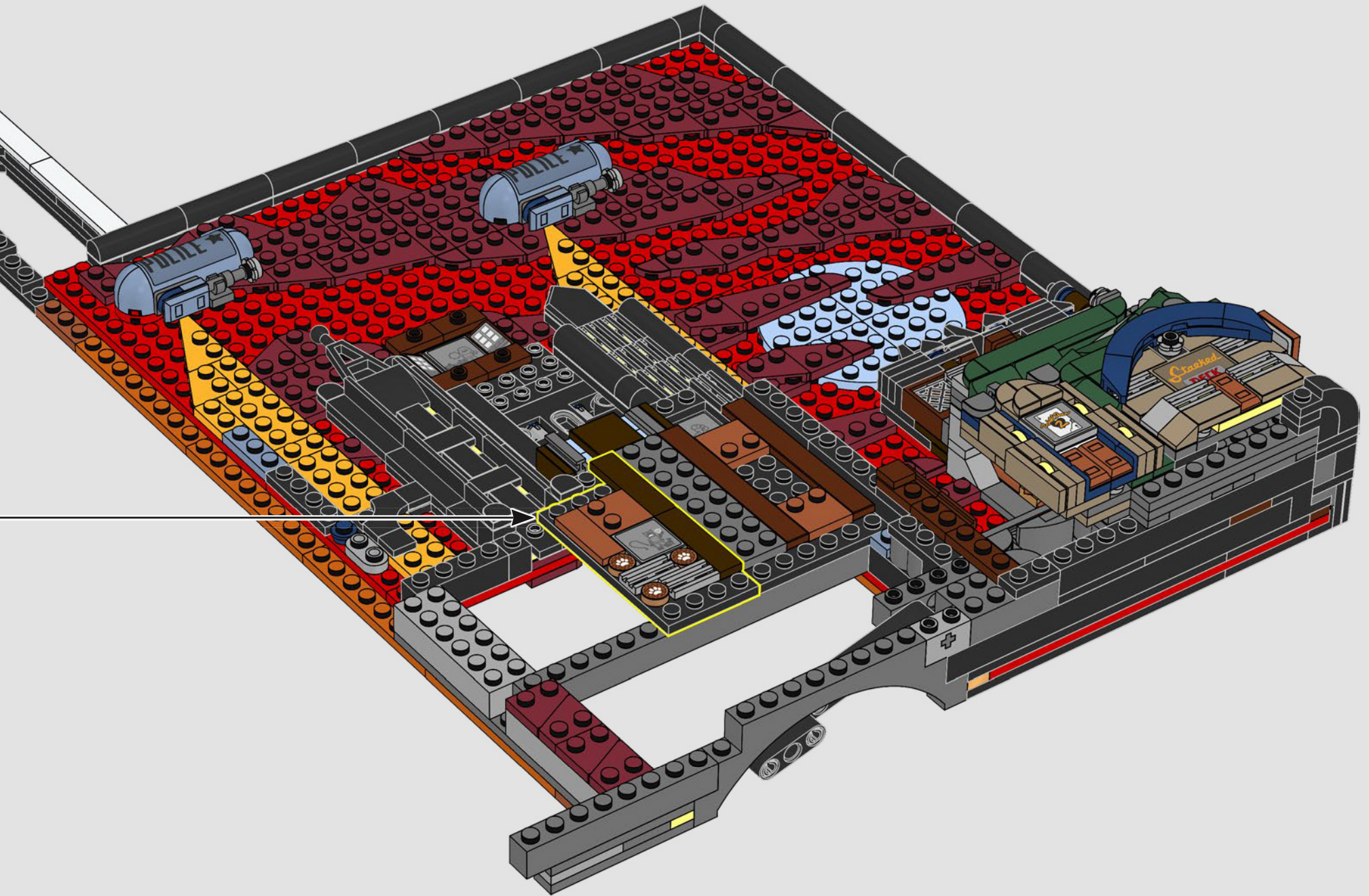

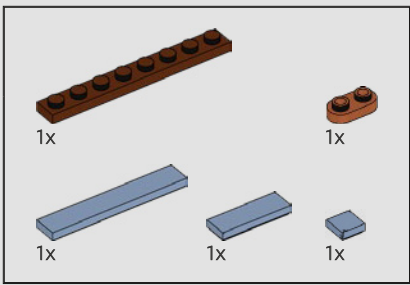

197

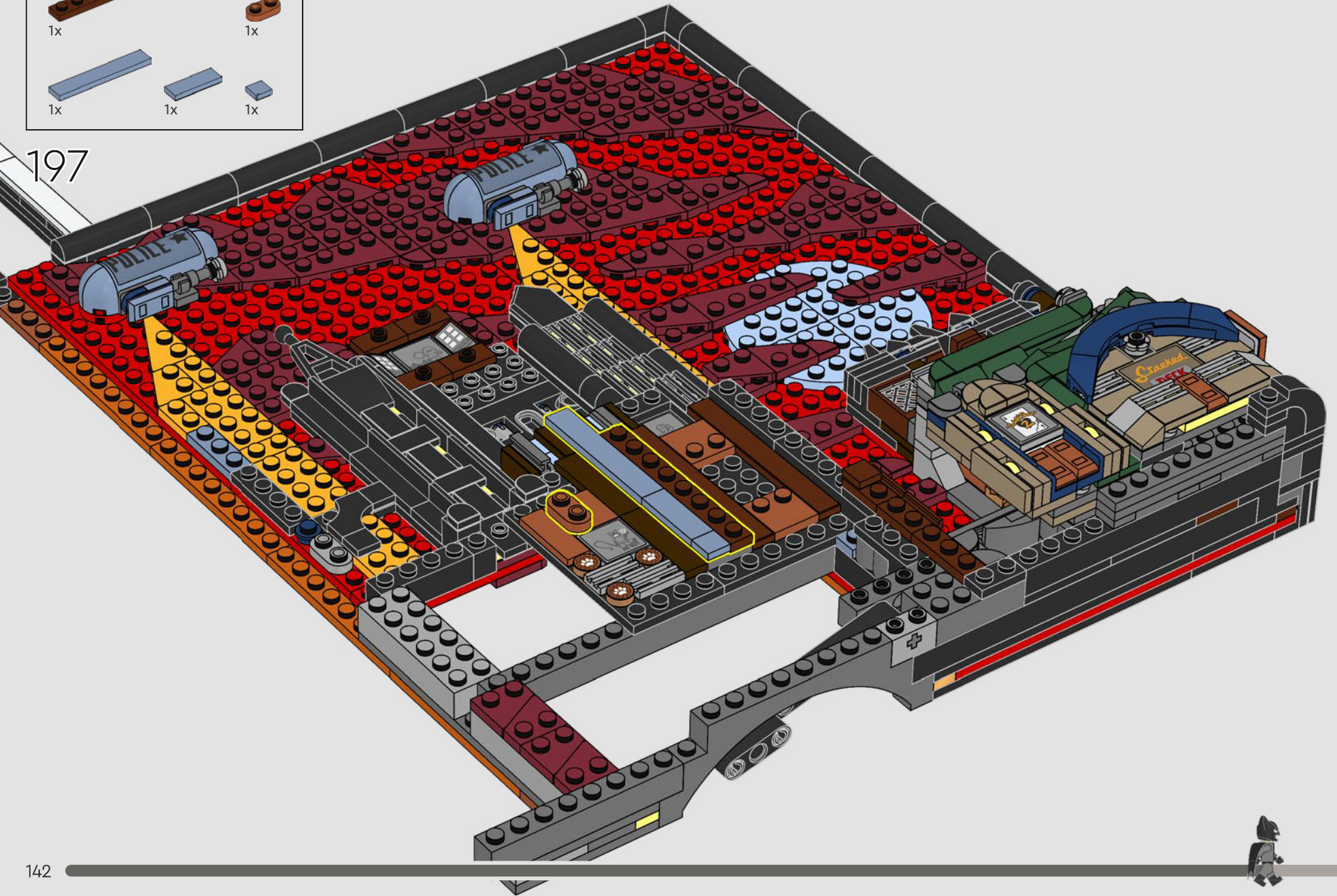

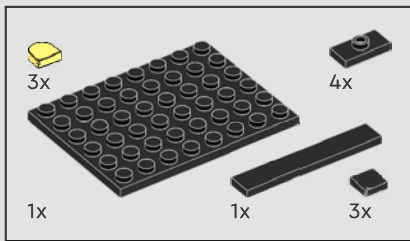

198

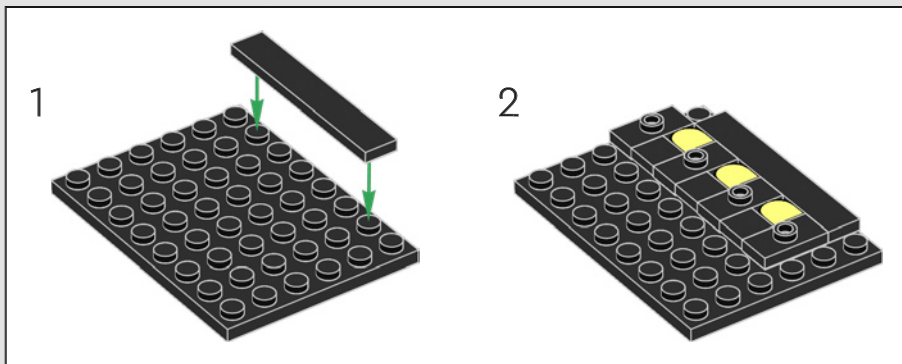
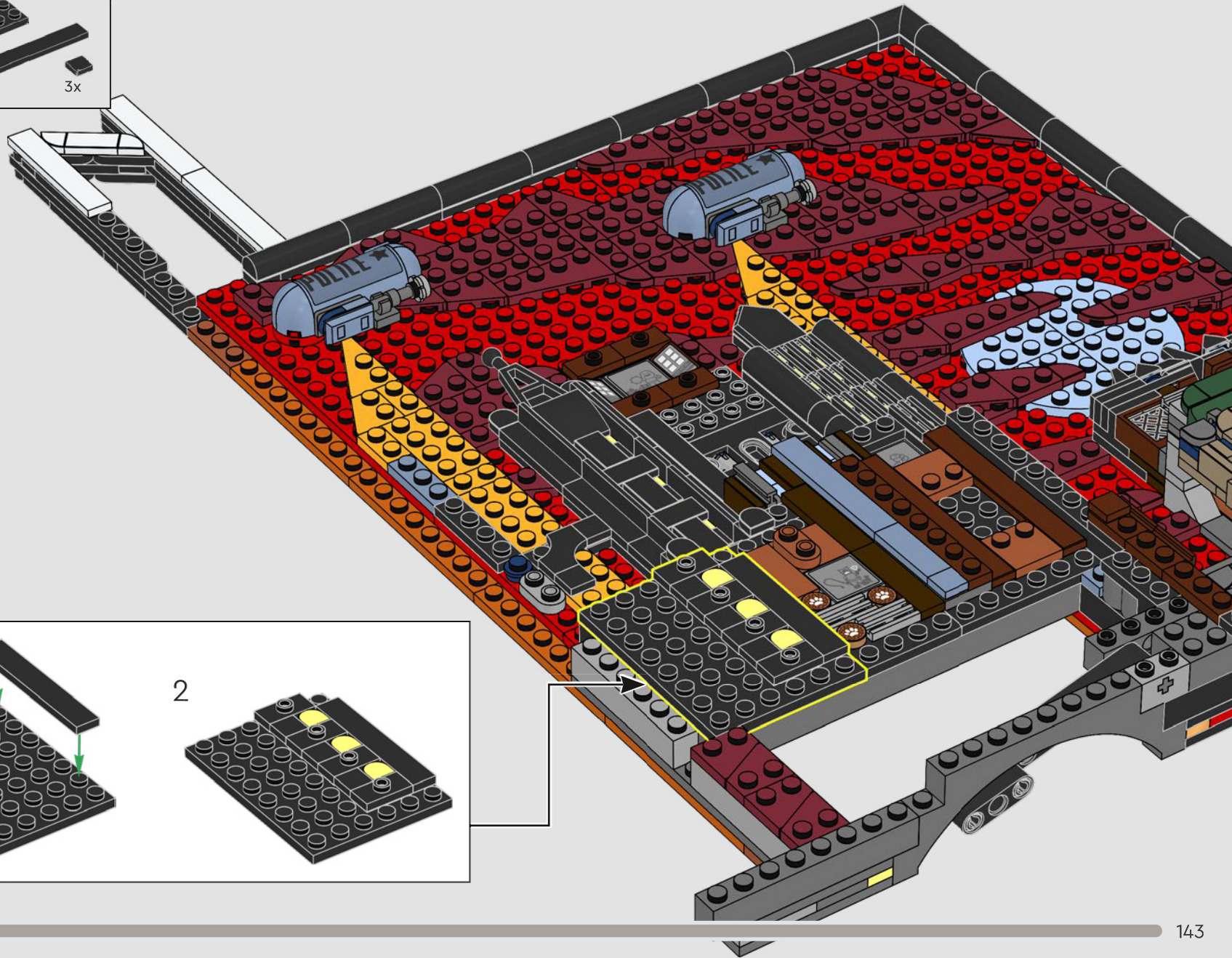

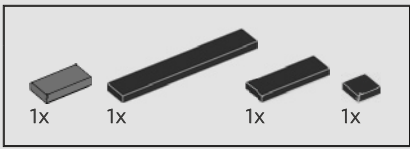

199

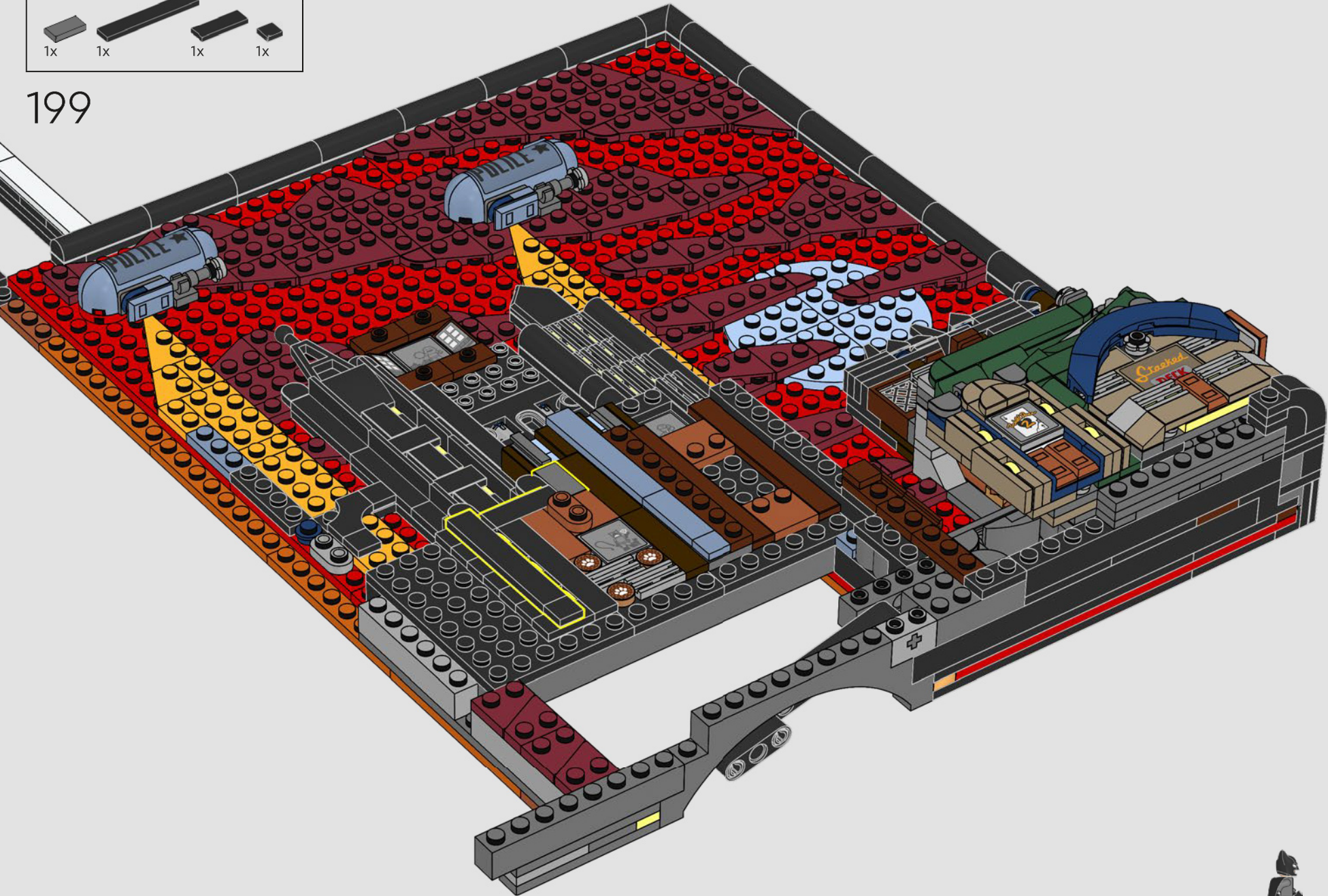

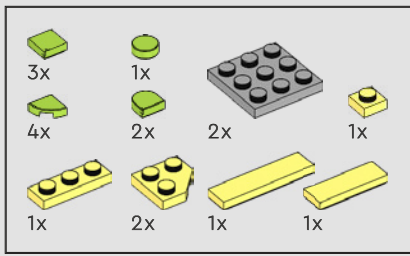

200

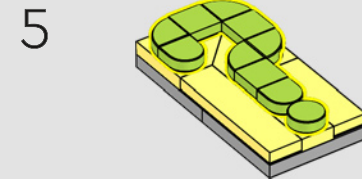
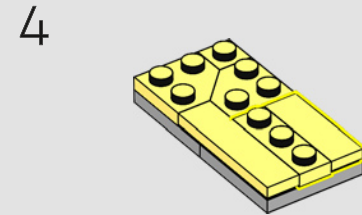
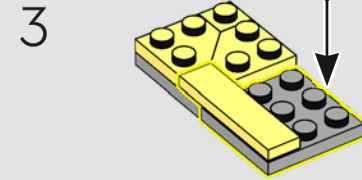
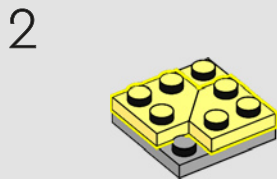
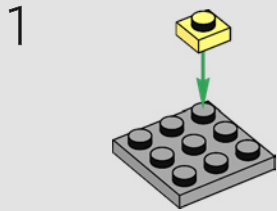

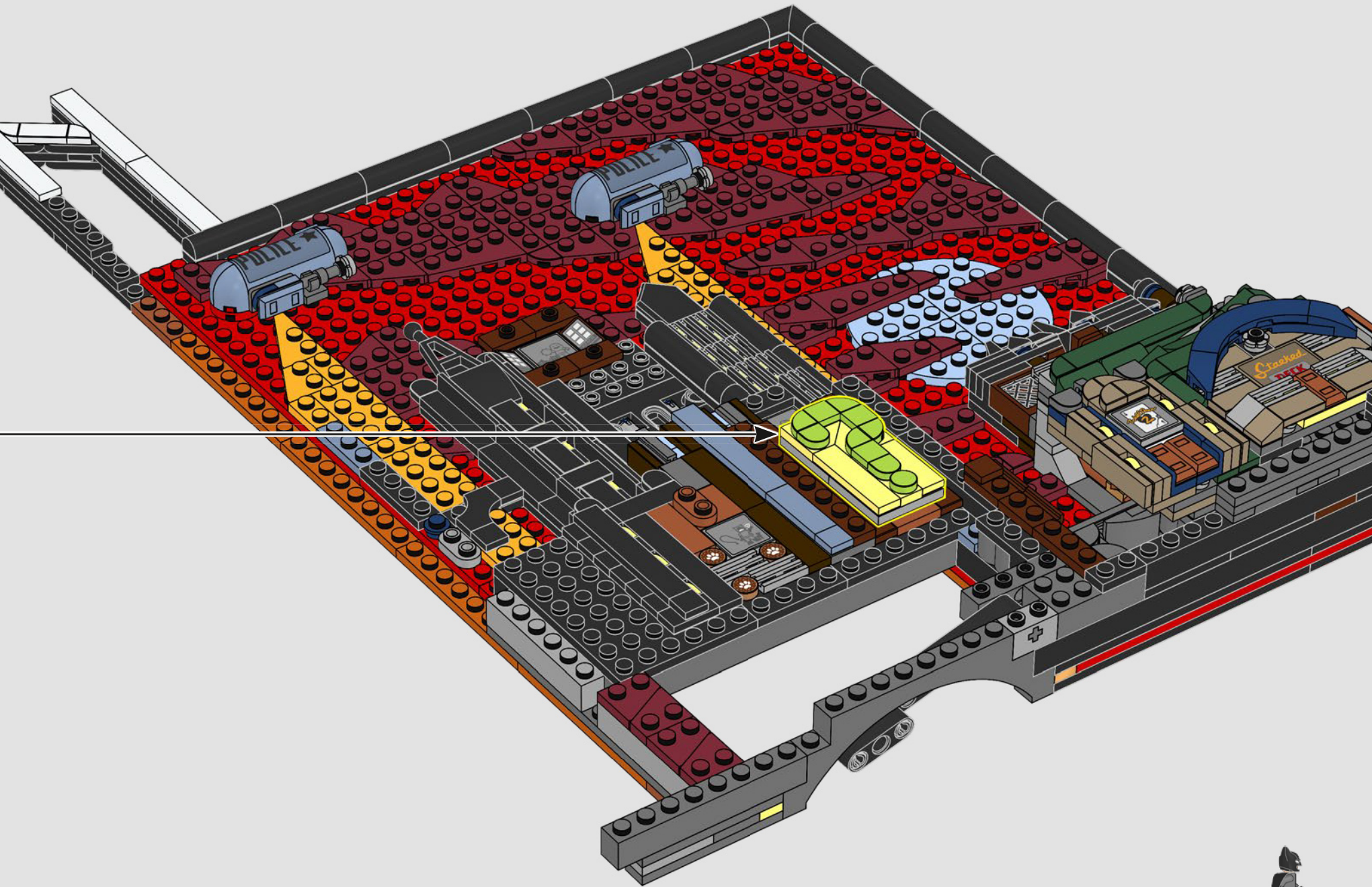

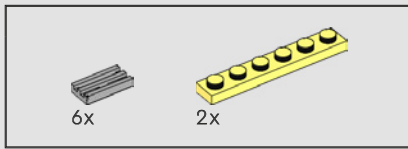

201

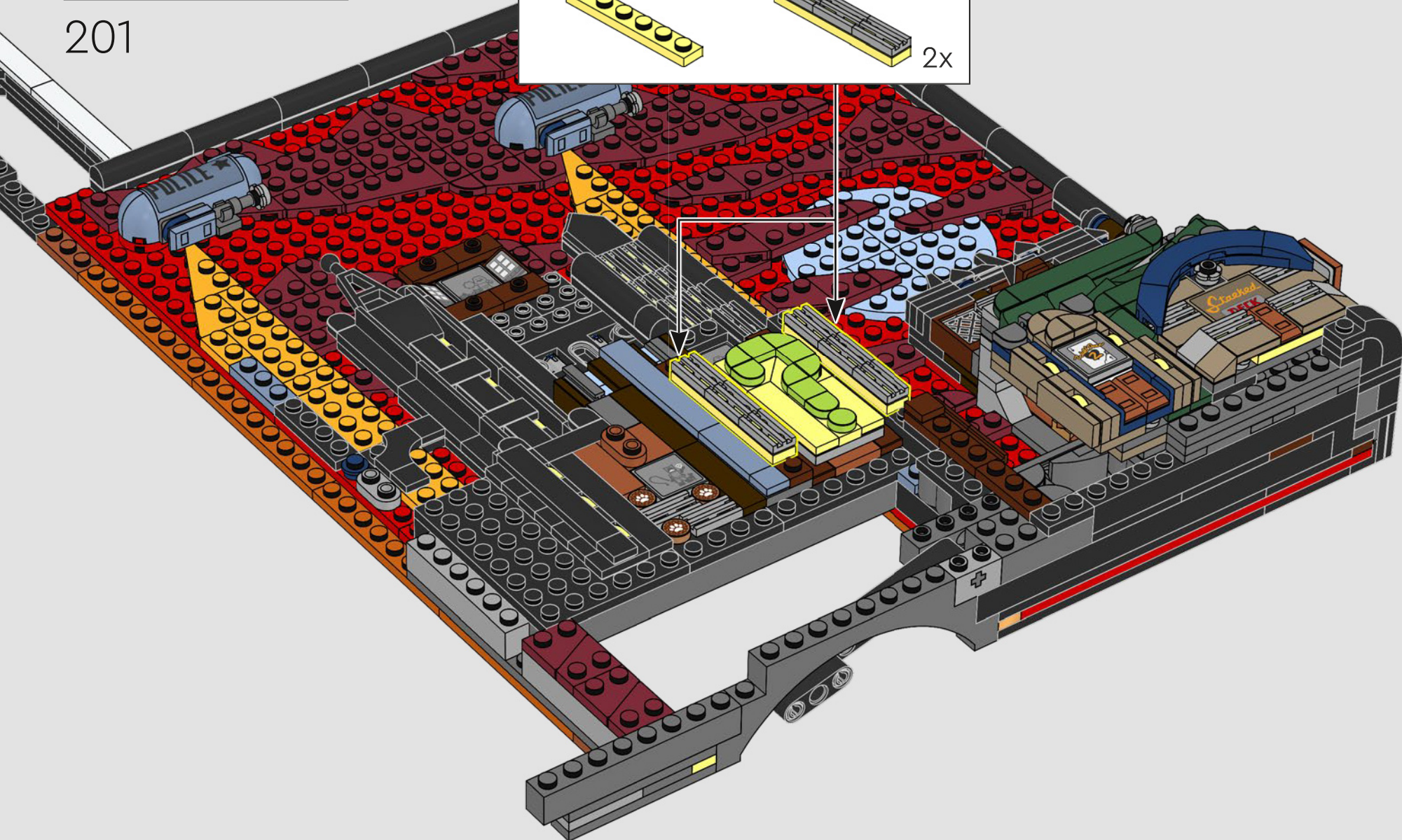
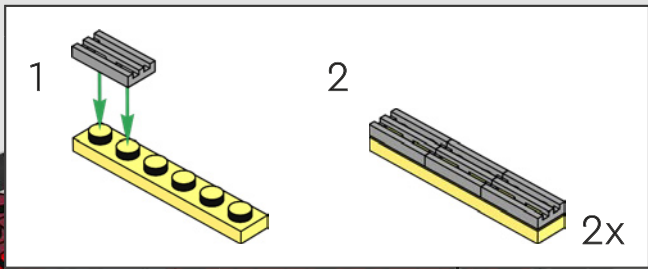

4x 4x

202

2x

2x

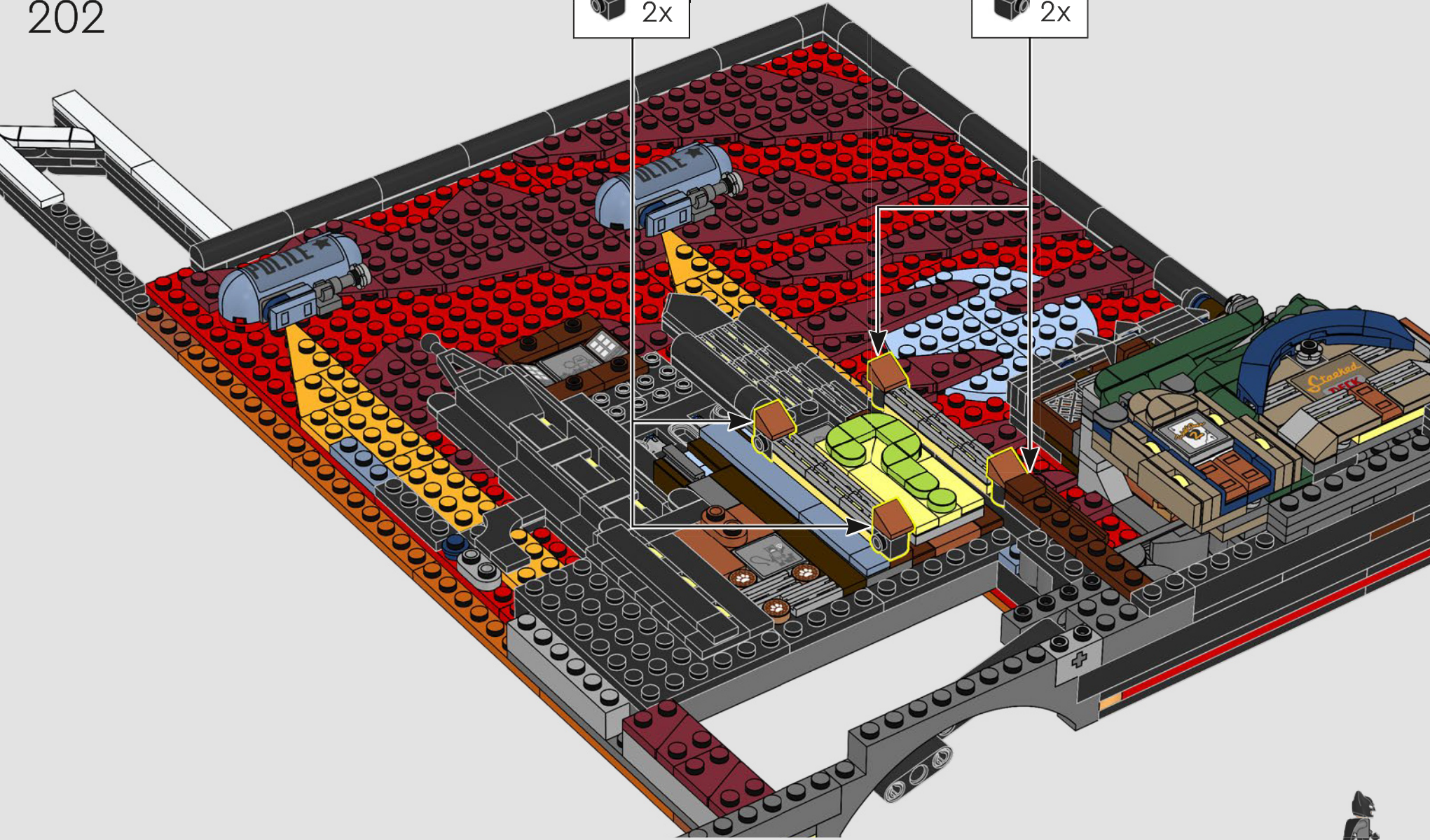

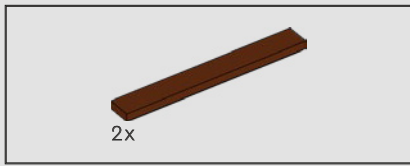

203

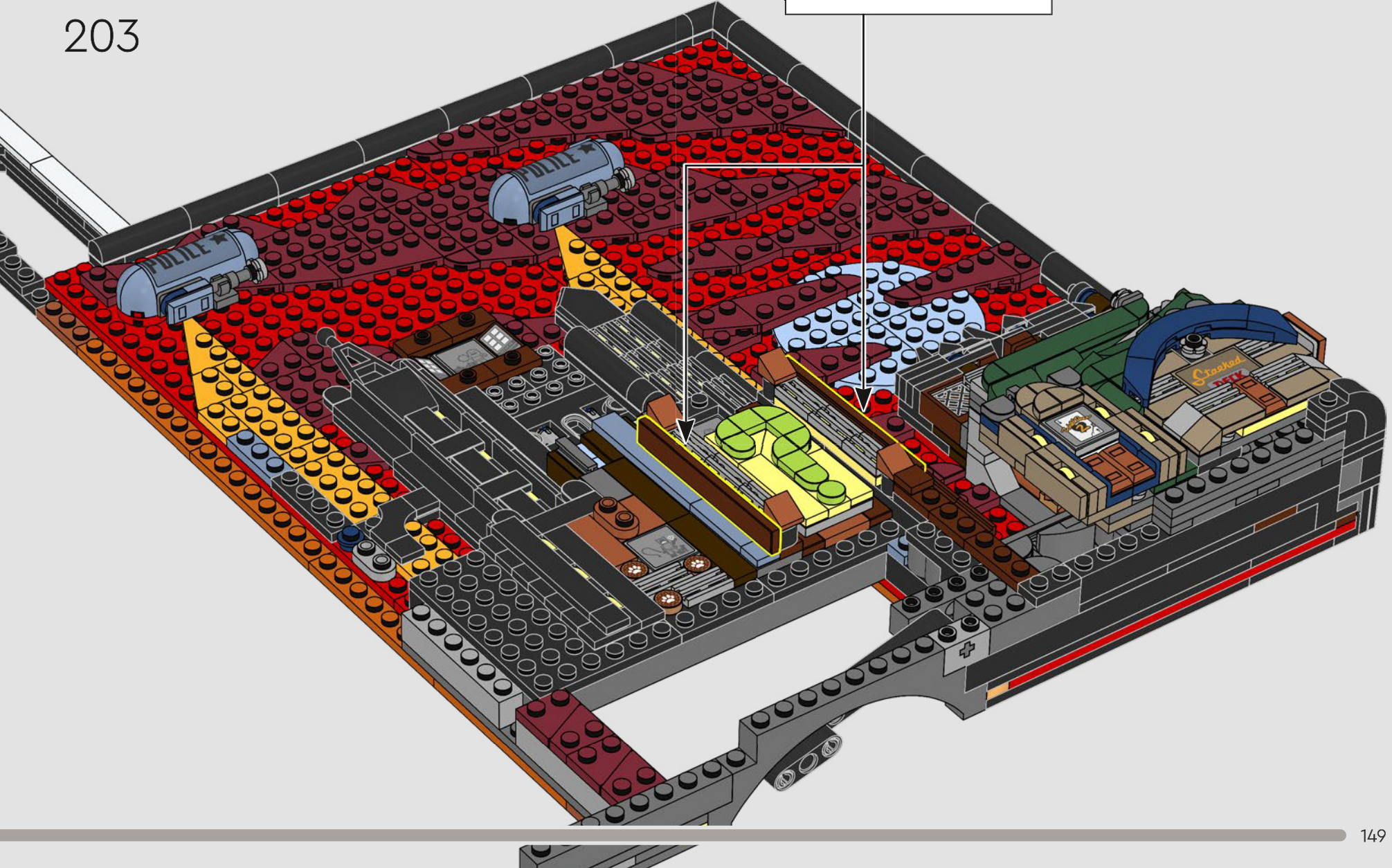
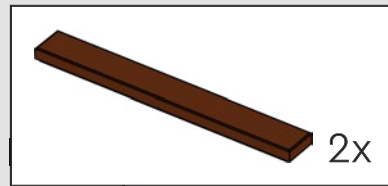

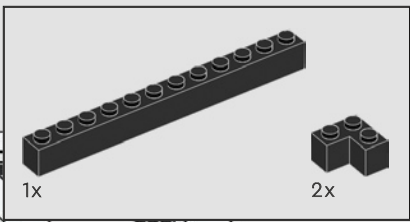

204

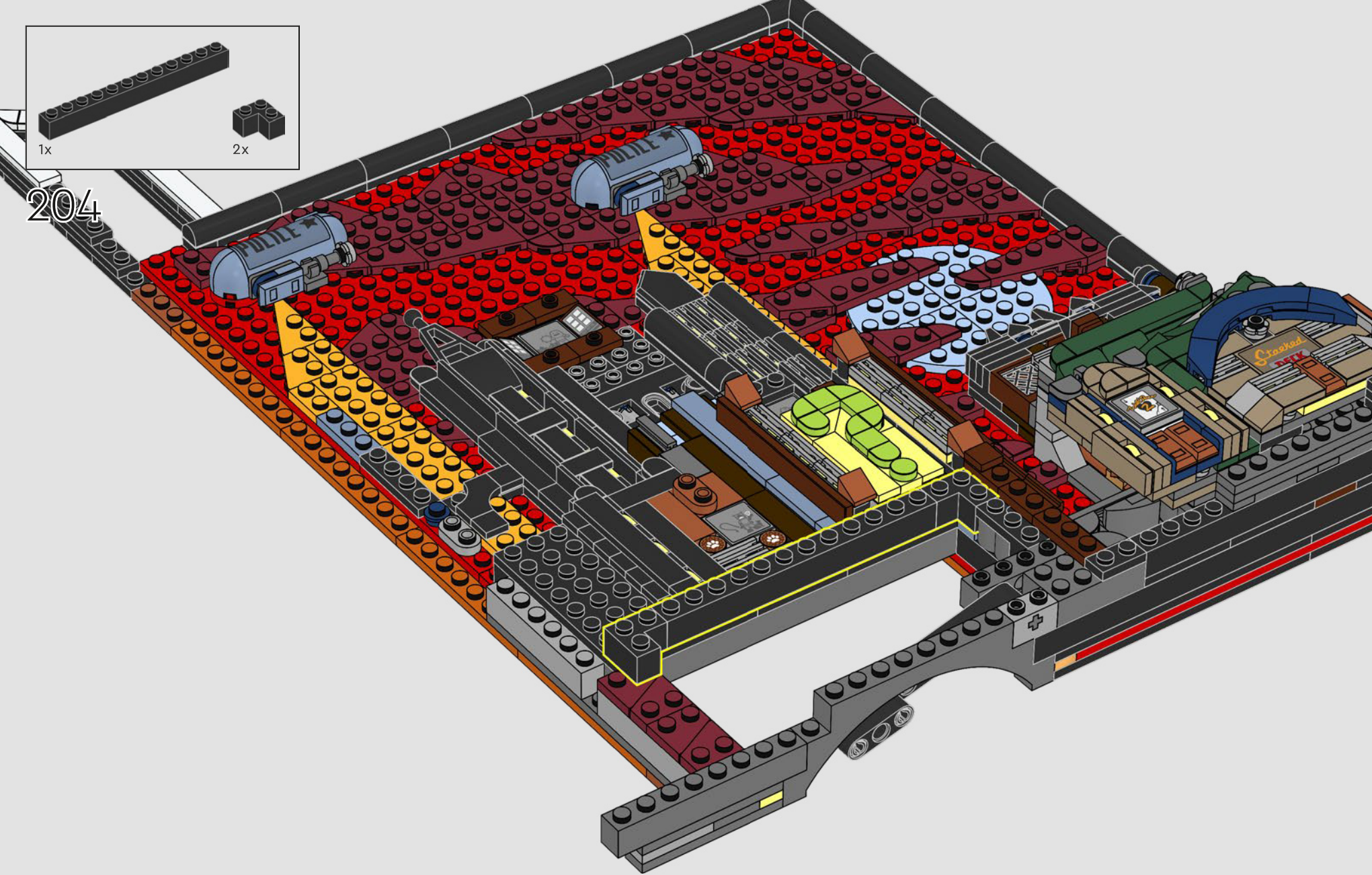

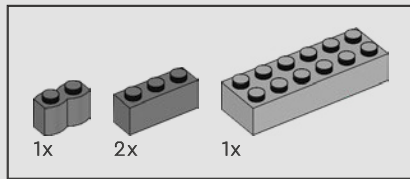

205

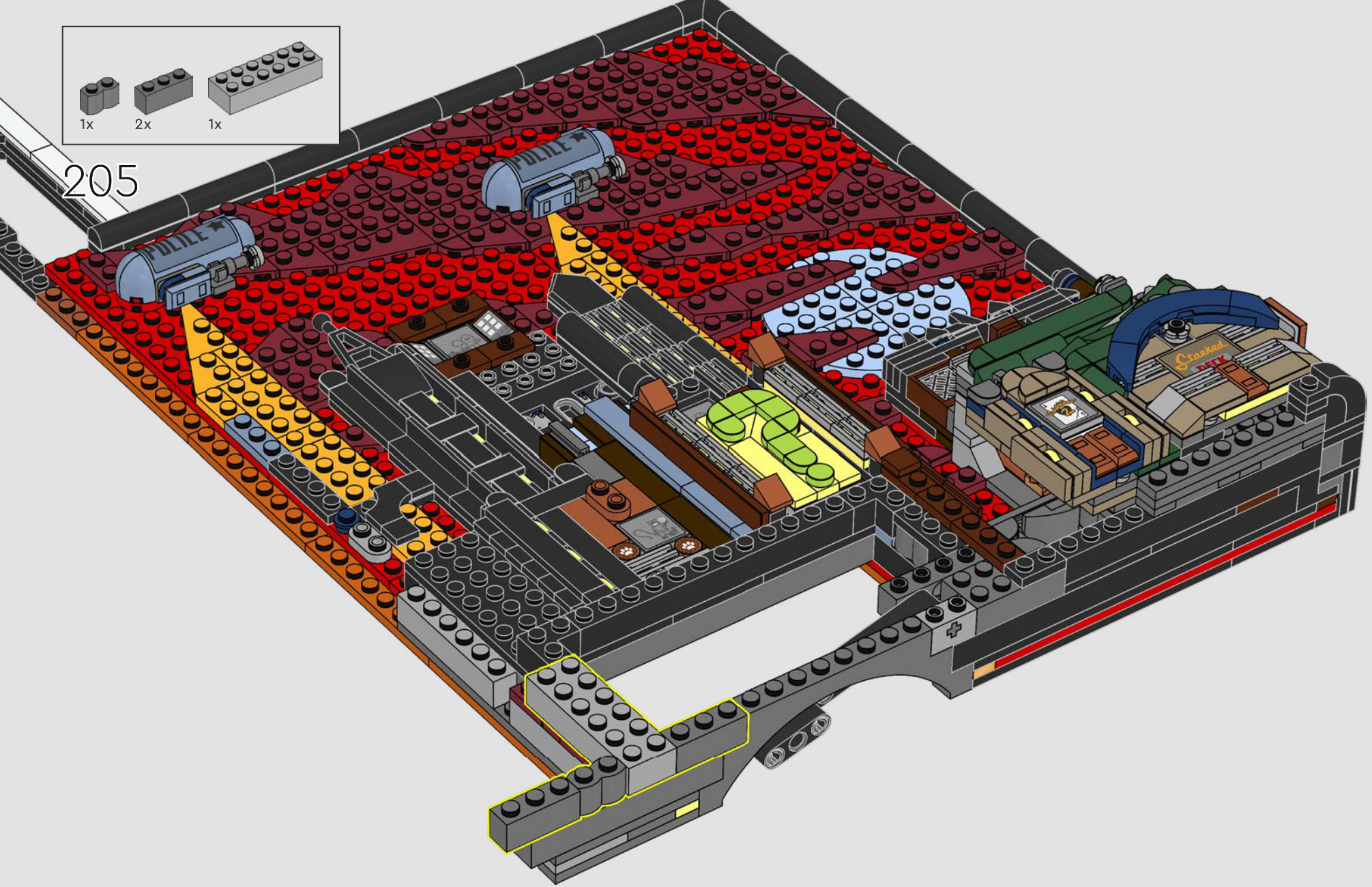

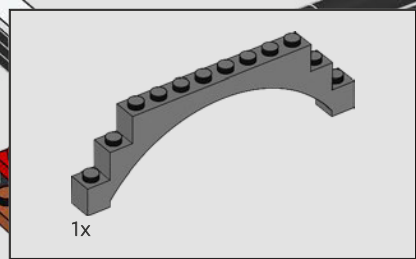

206

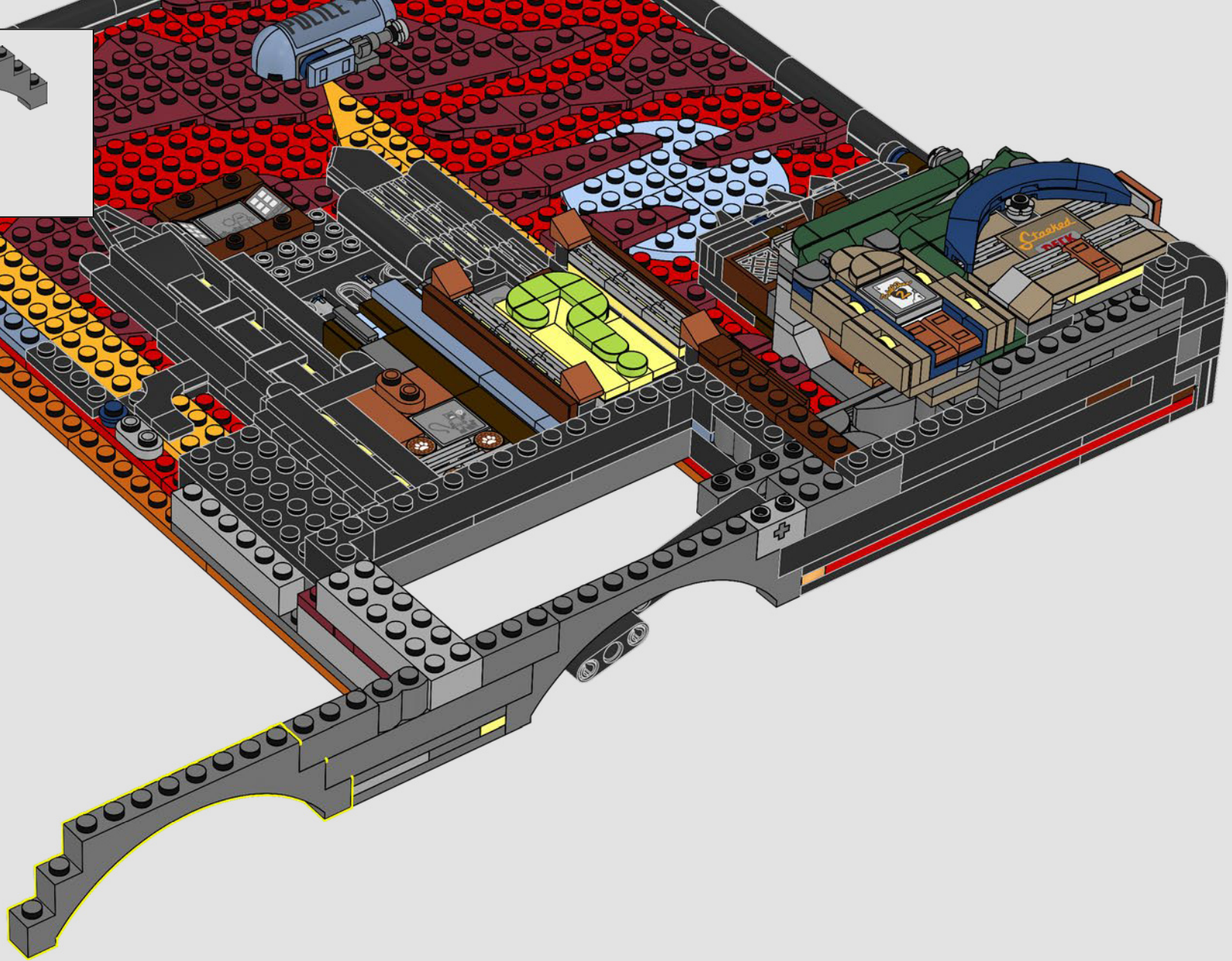



Episode: *Shadow of the Bat: Part II*
Épisode : *Jeux d'ombres (2^e partie)*
Episodio: *La sombra del murciélago: Parte 2*

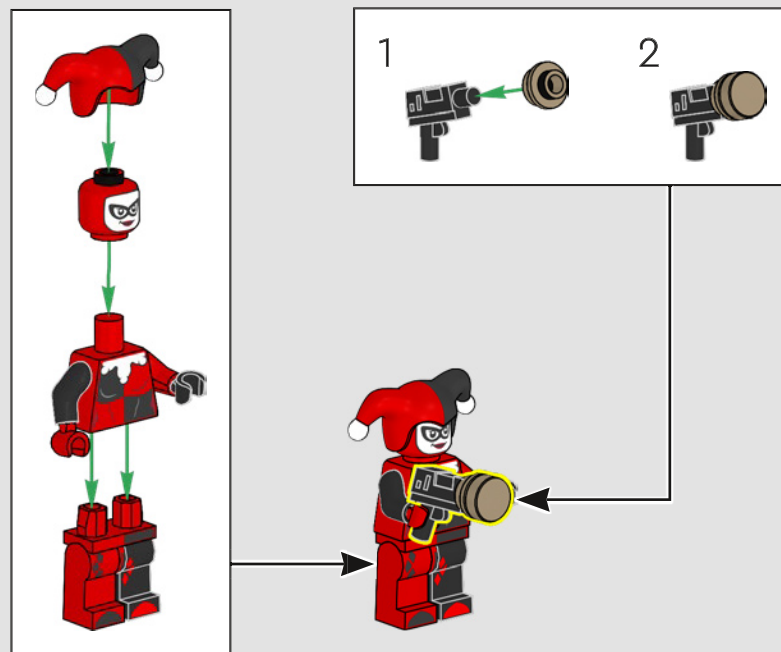

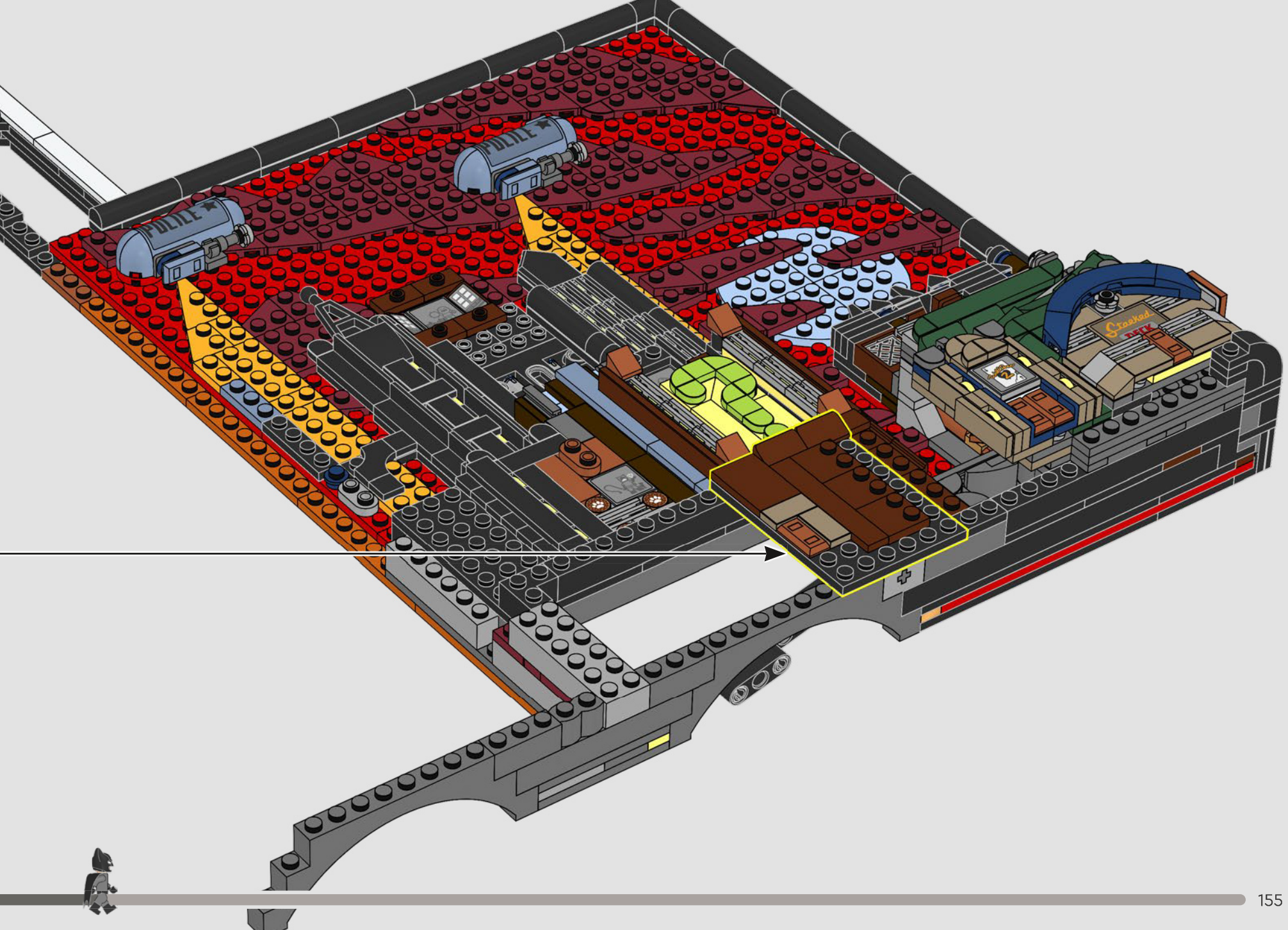

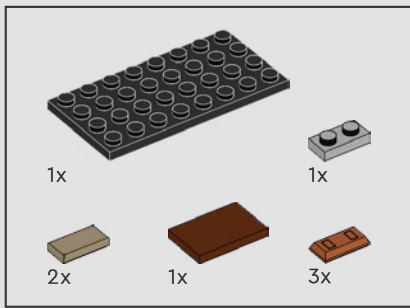

209

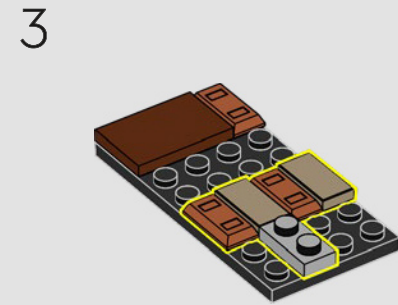
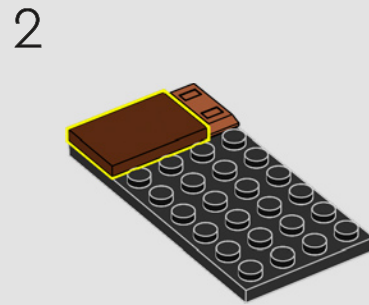
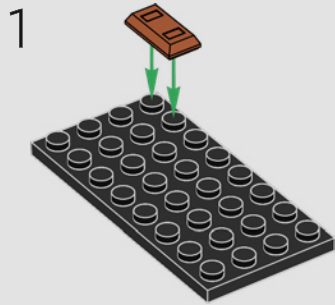

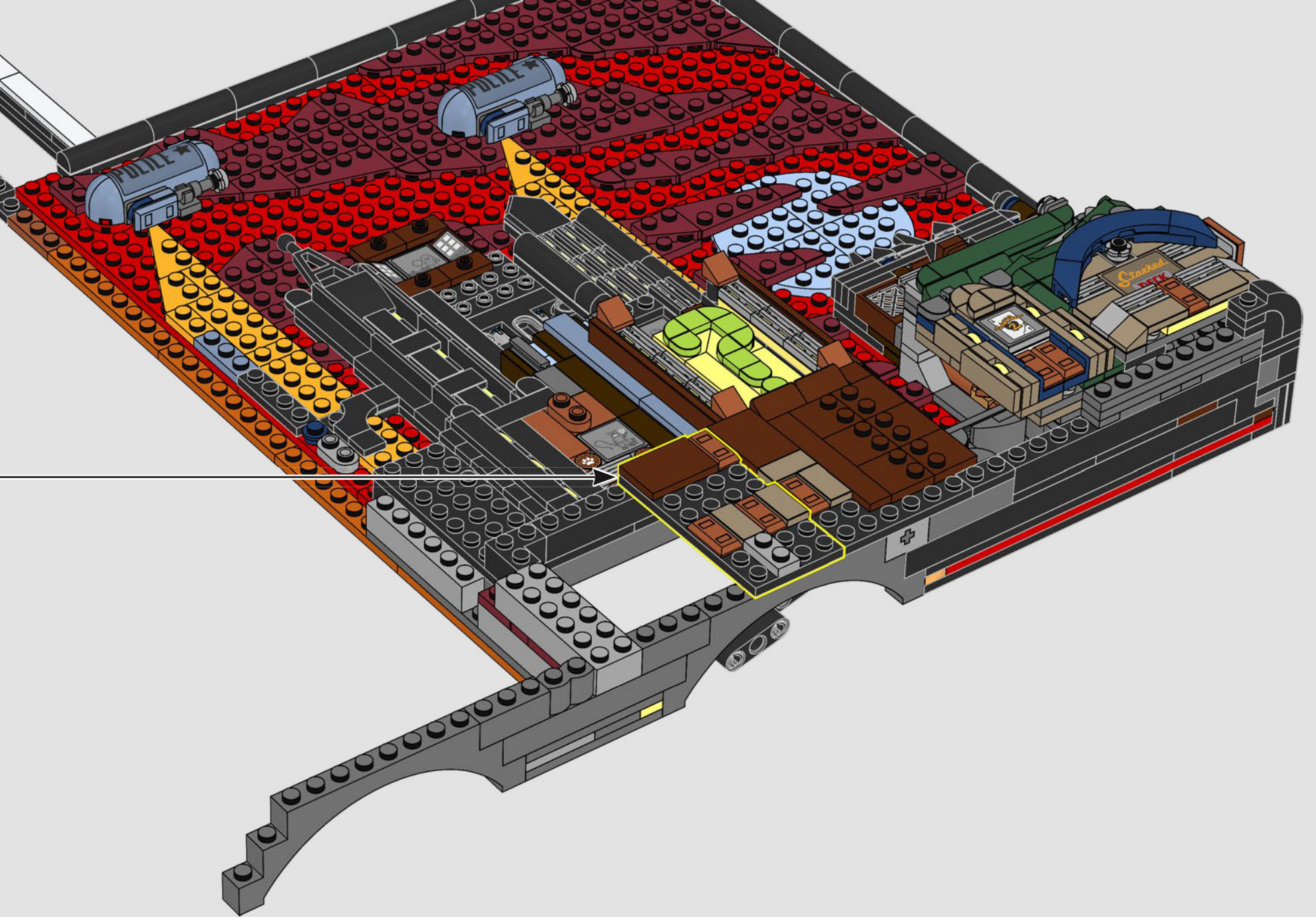

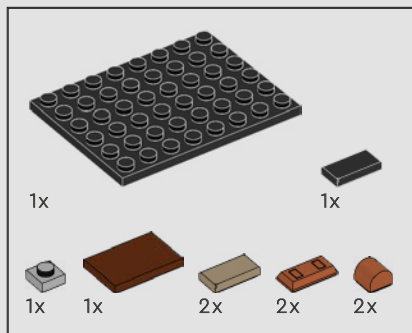

210

1

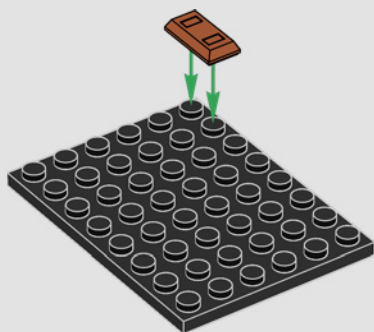

2

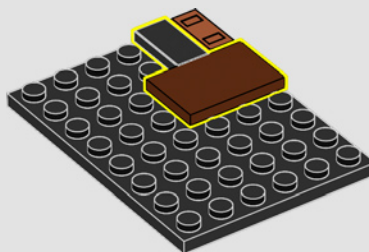

3

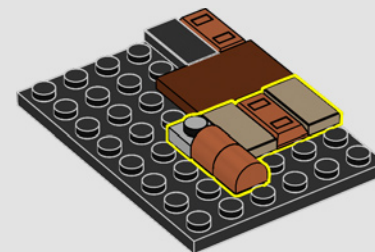

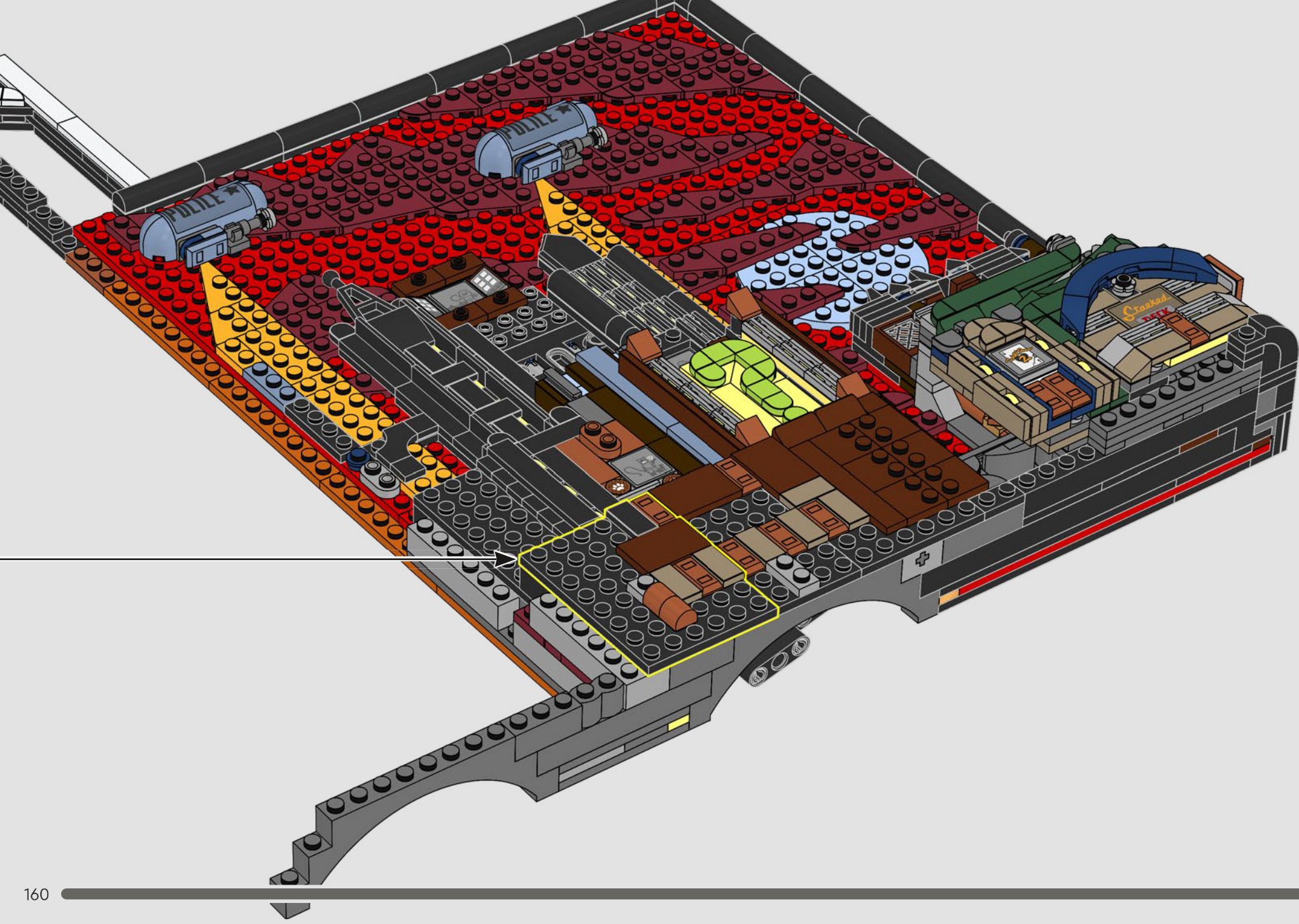

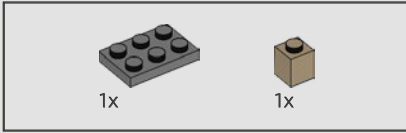
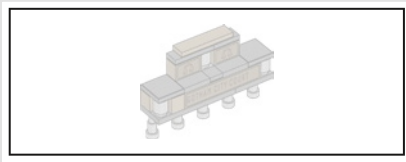

211

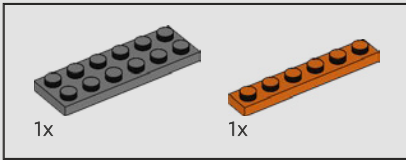
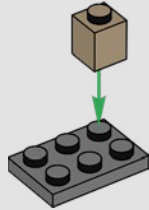

212

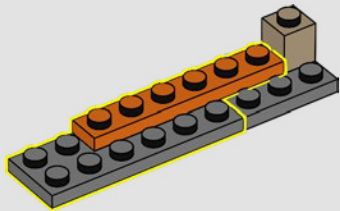

213

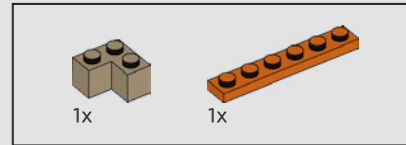
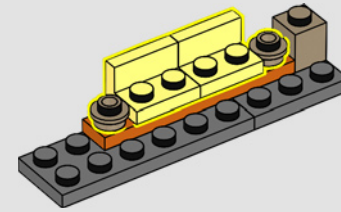

214

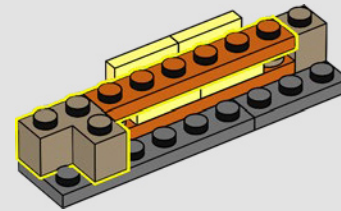

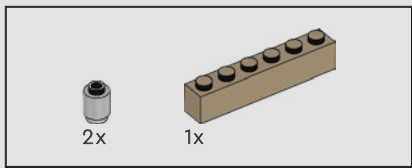

215

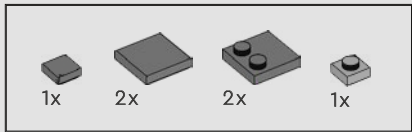
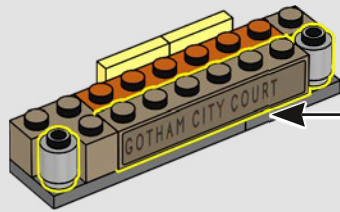
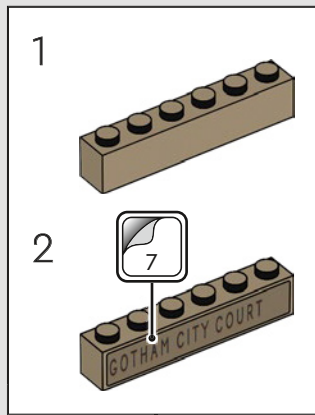

216

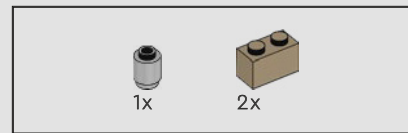

217

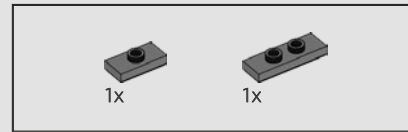
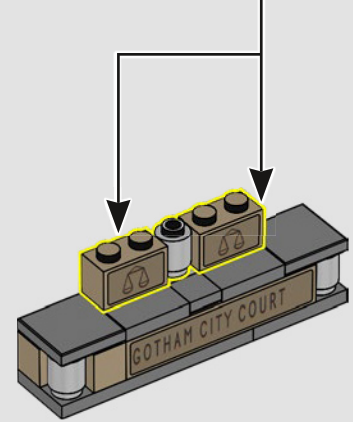
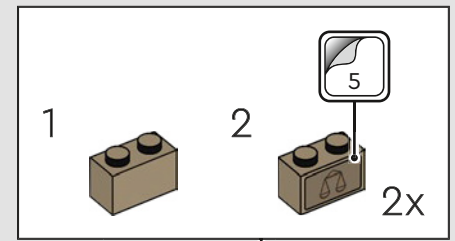

218

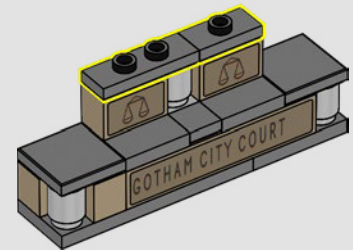

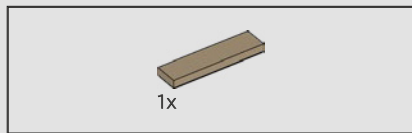

219

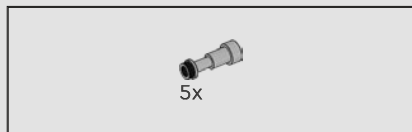
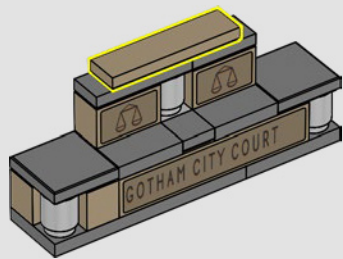

220

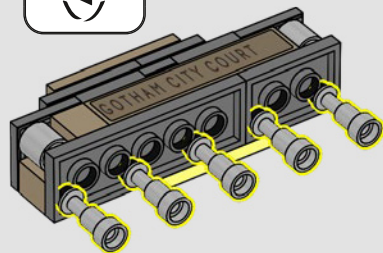

221

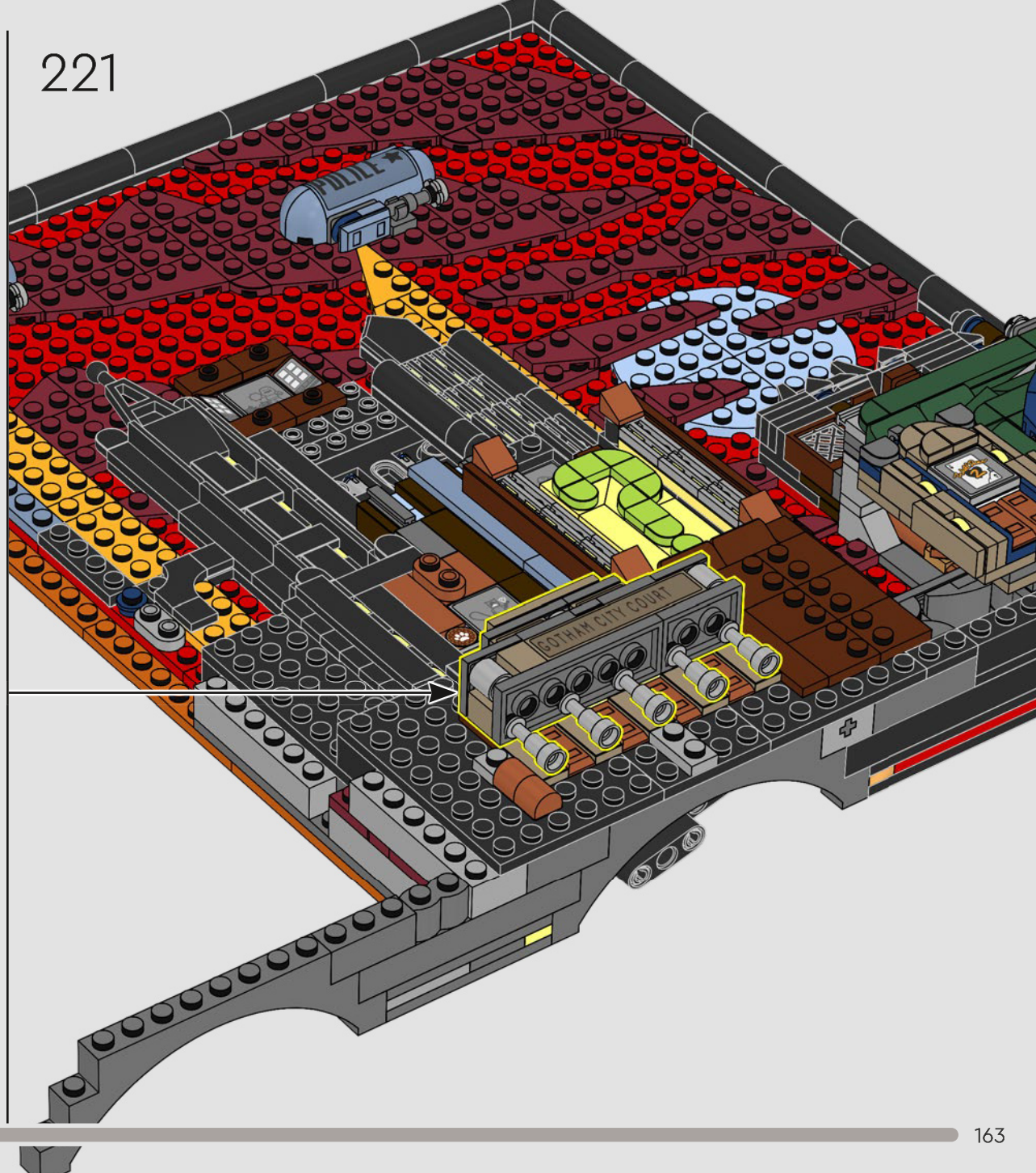

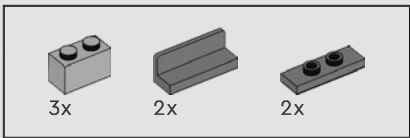

222

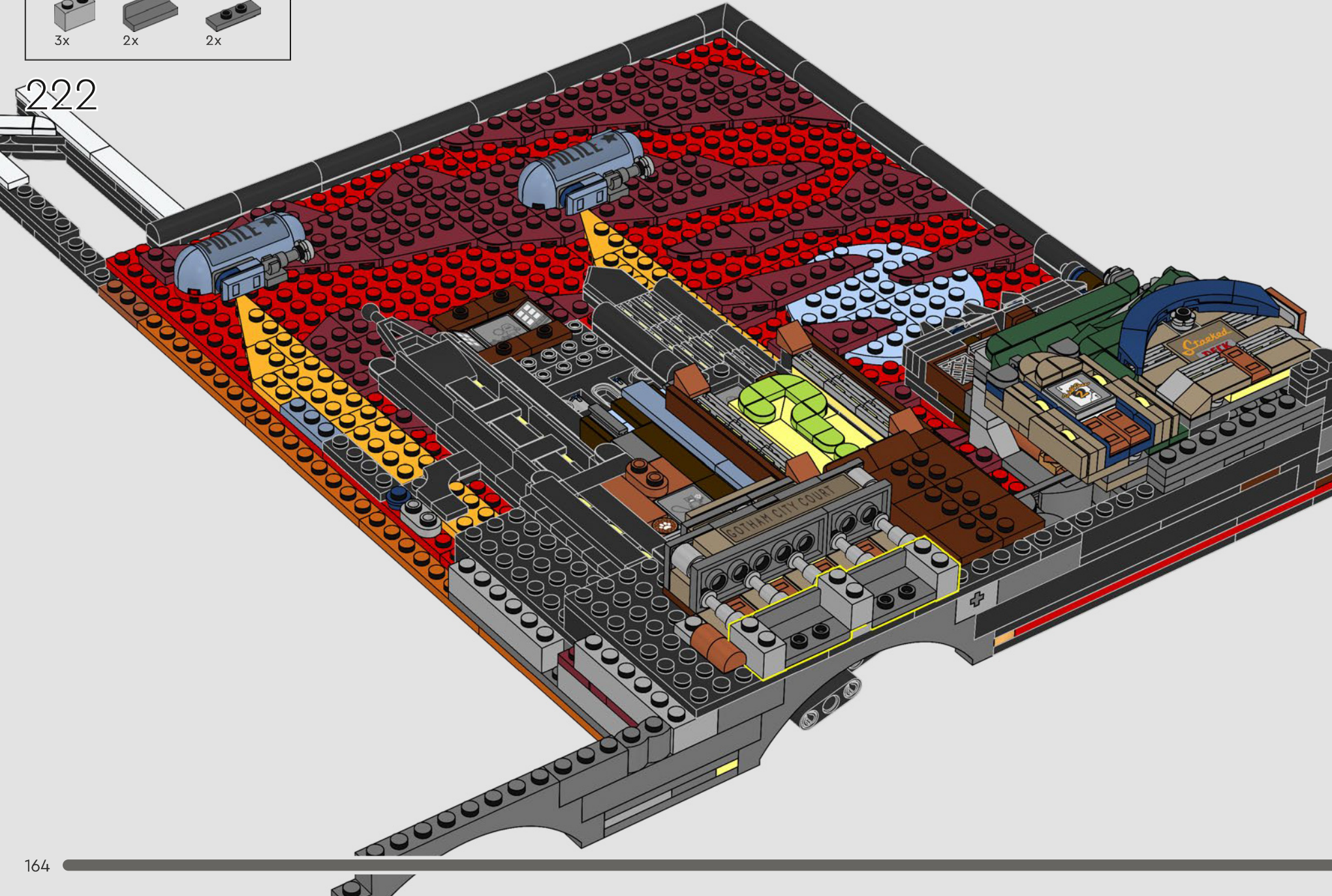

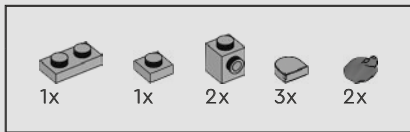

223

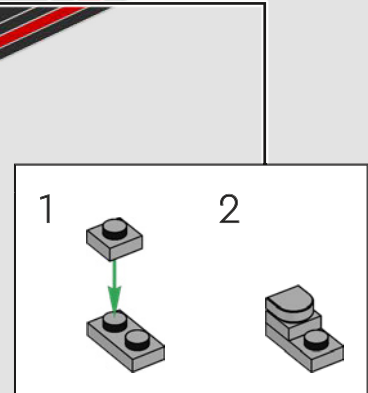
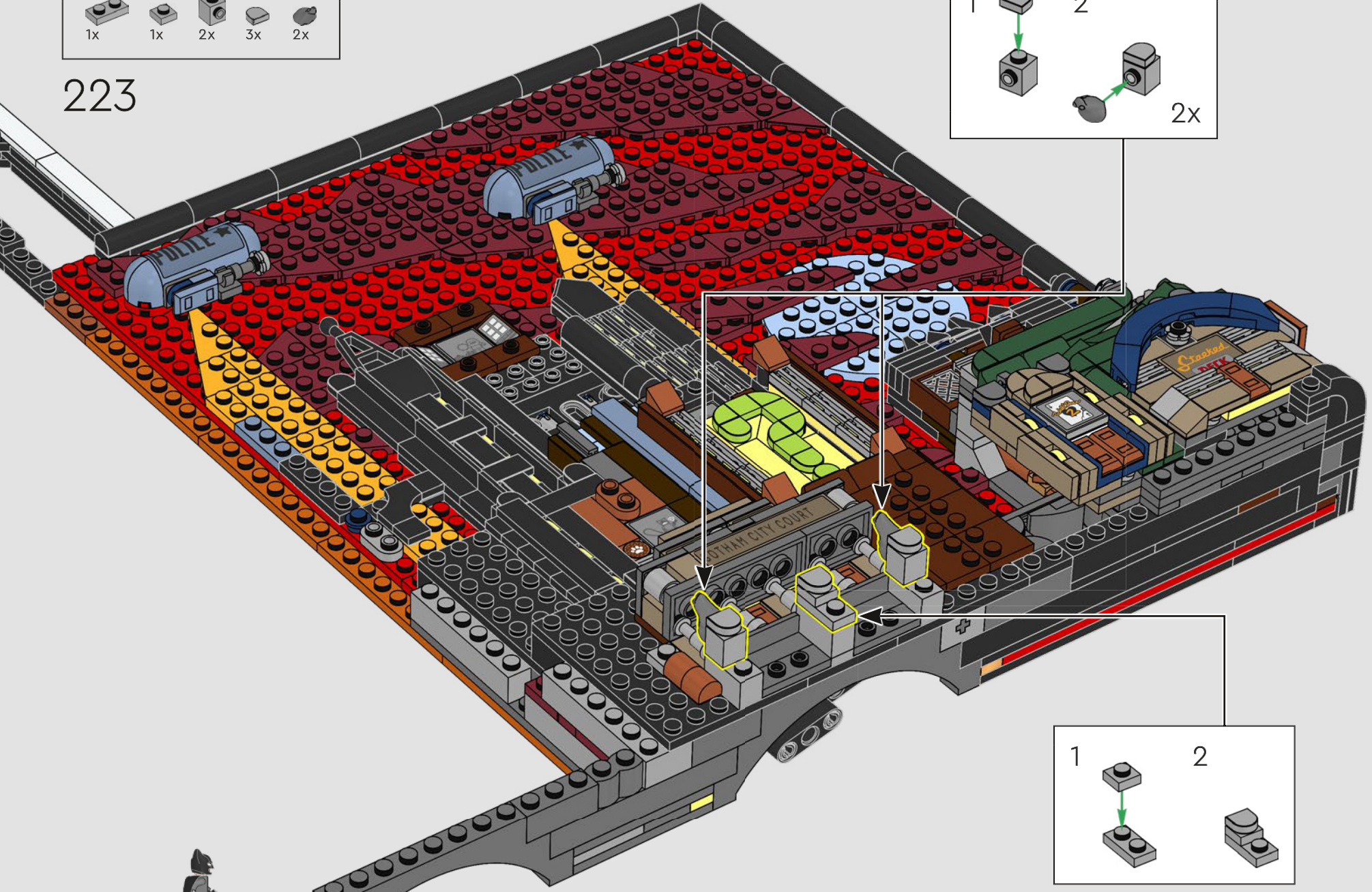
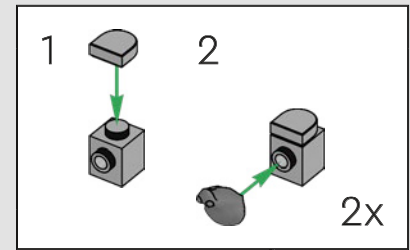

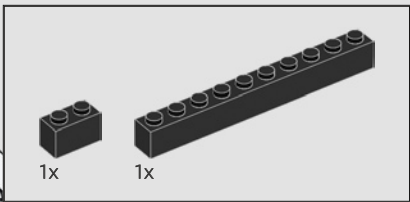

224

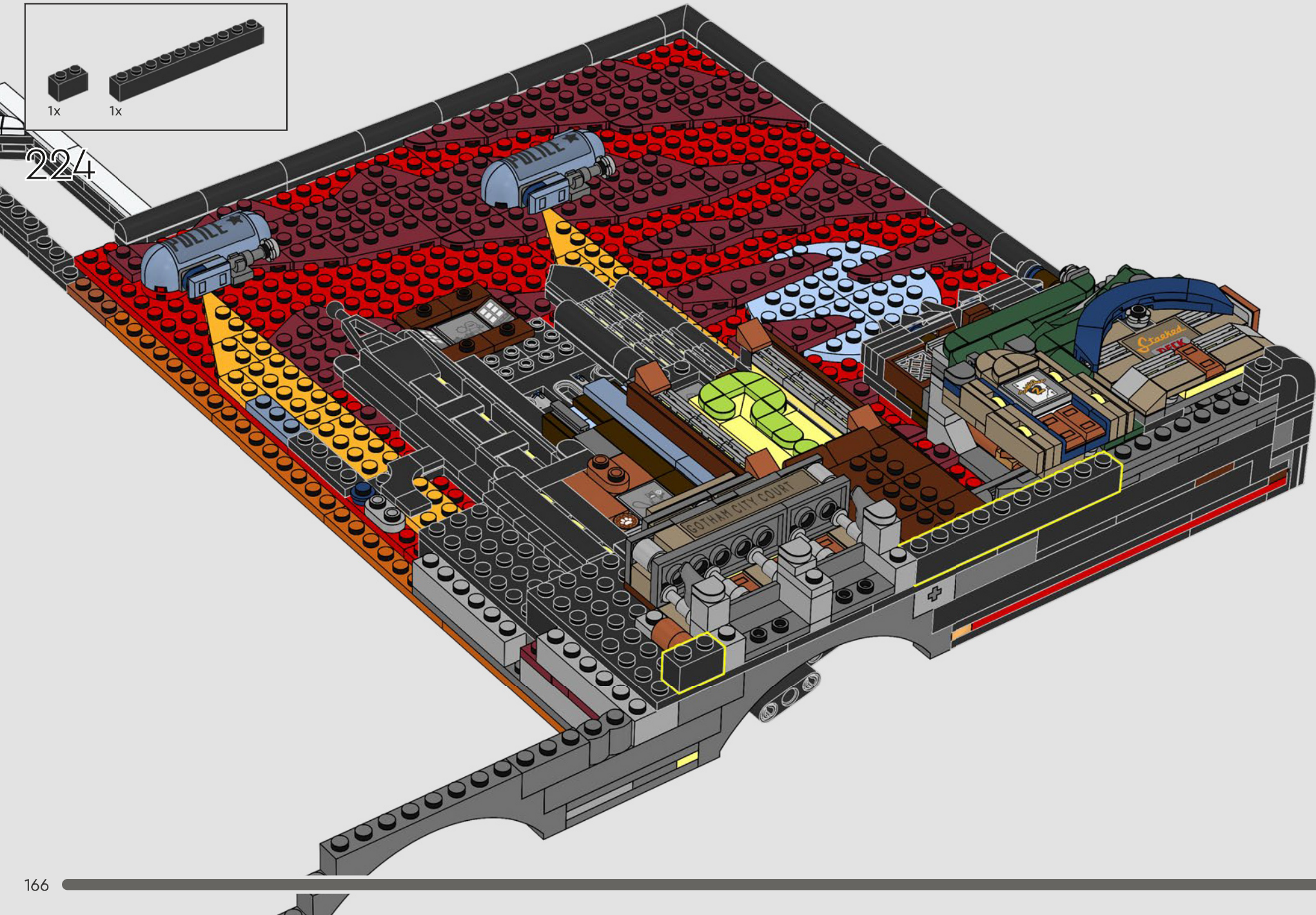

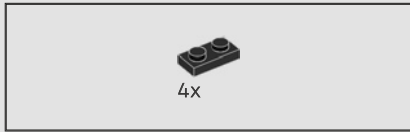

225

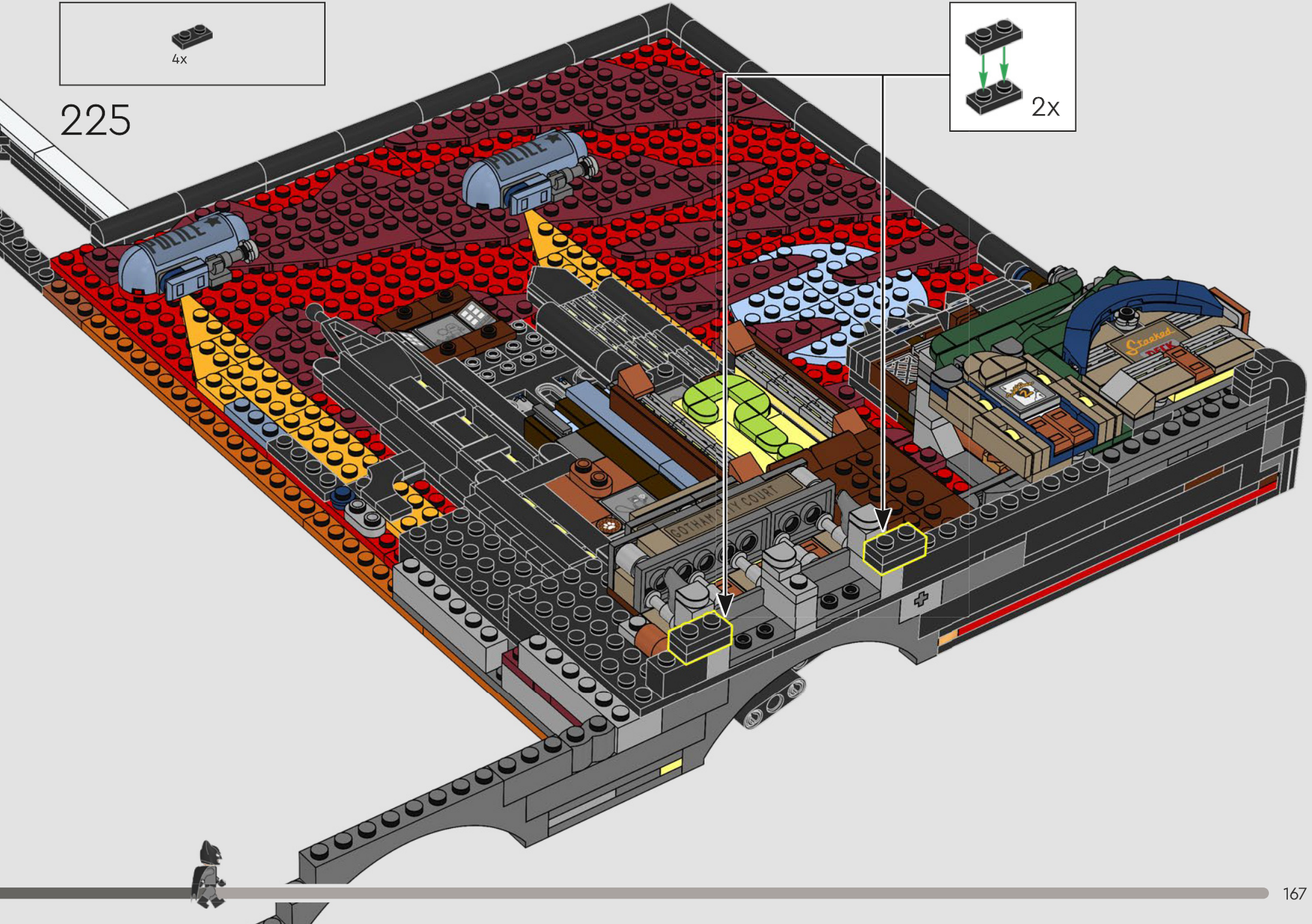
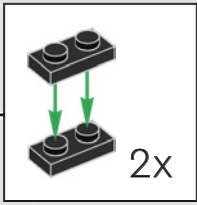

226

1x

1x

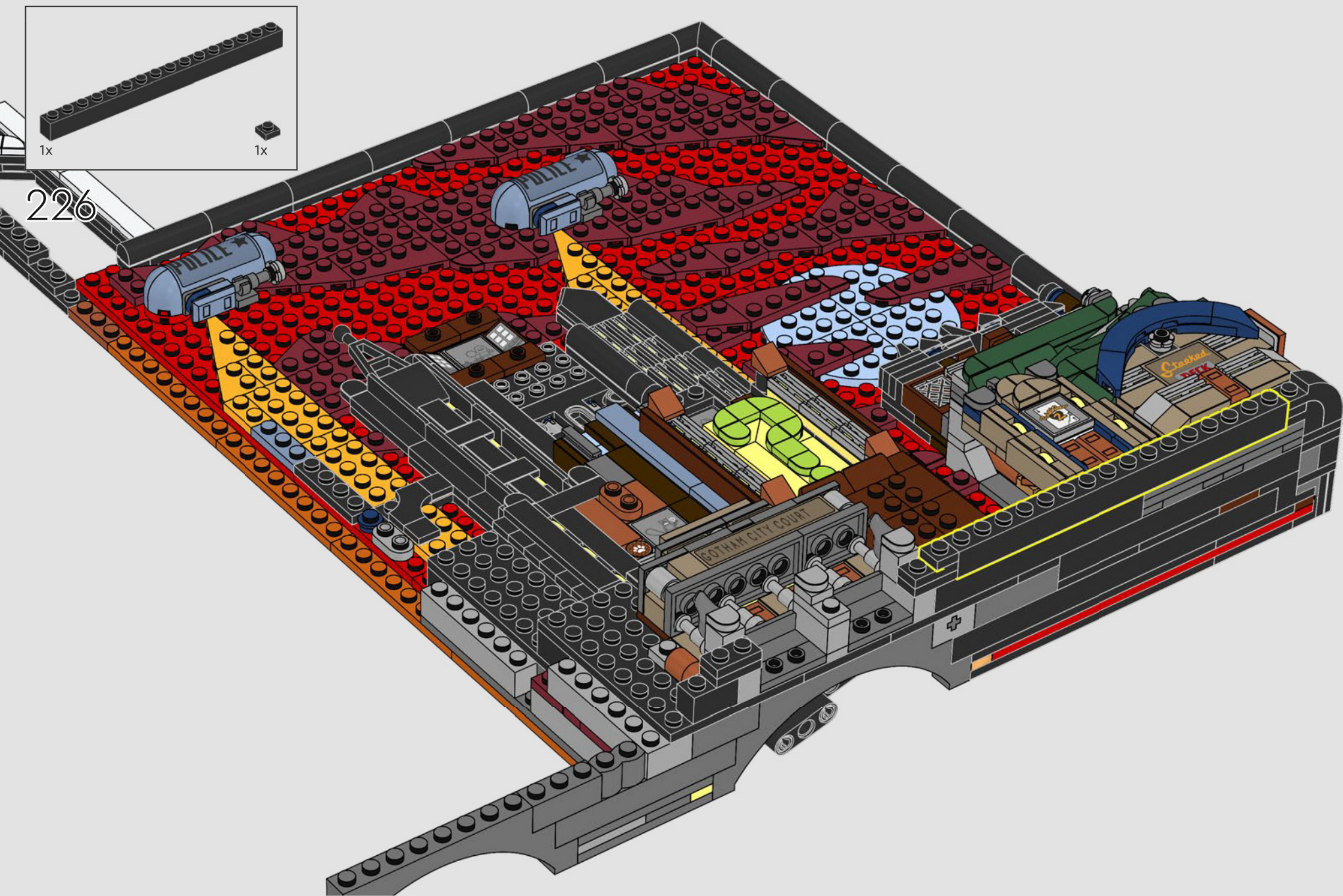

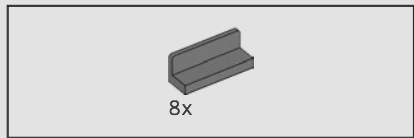

227

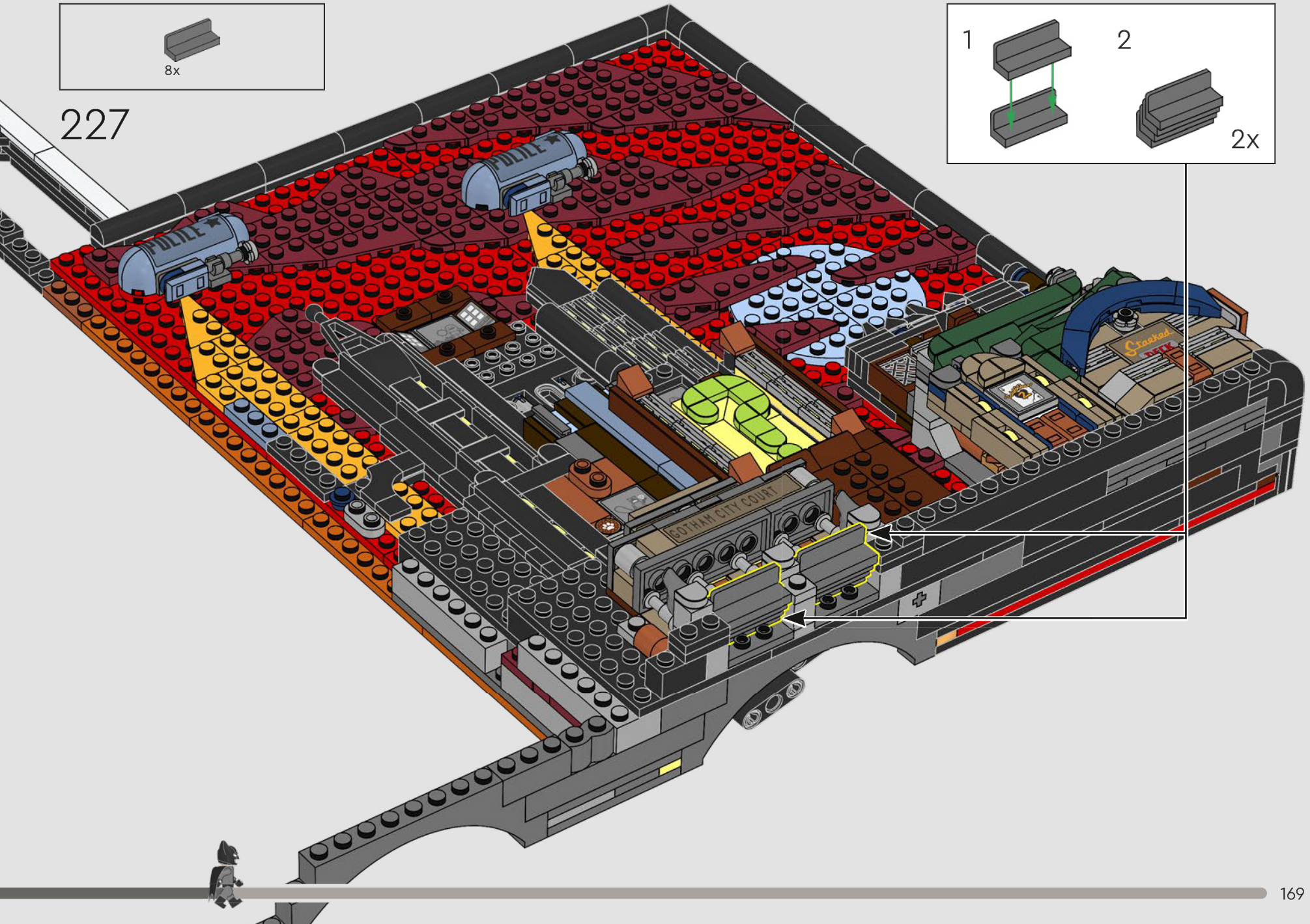
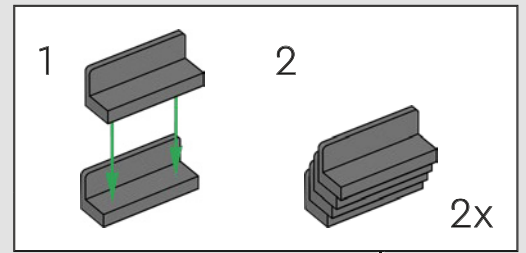

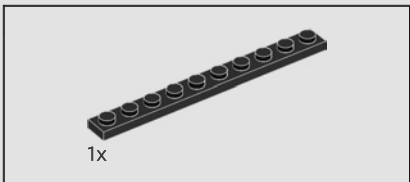

228

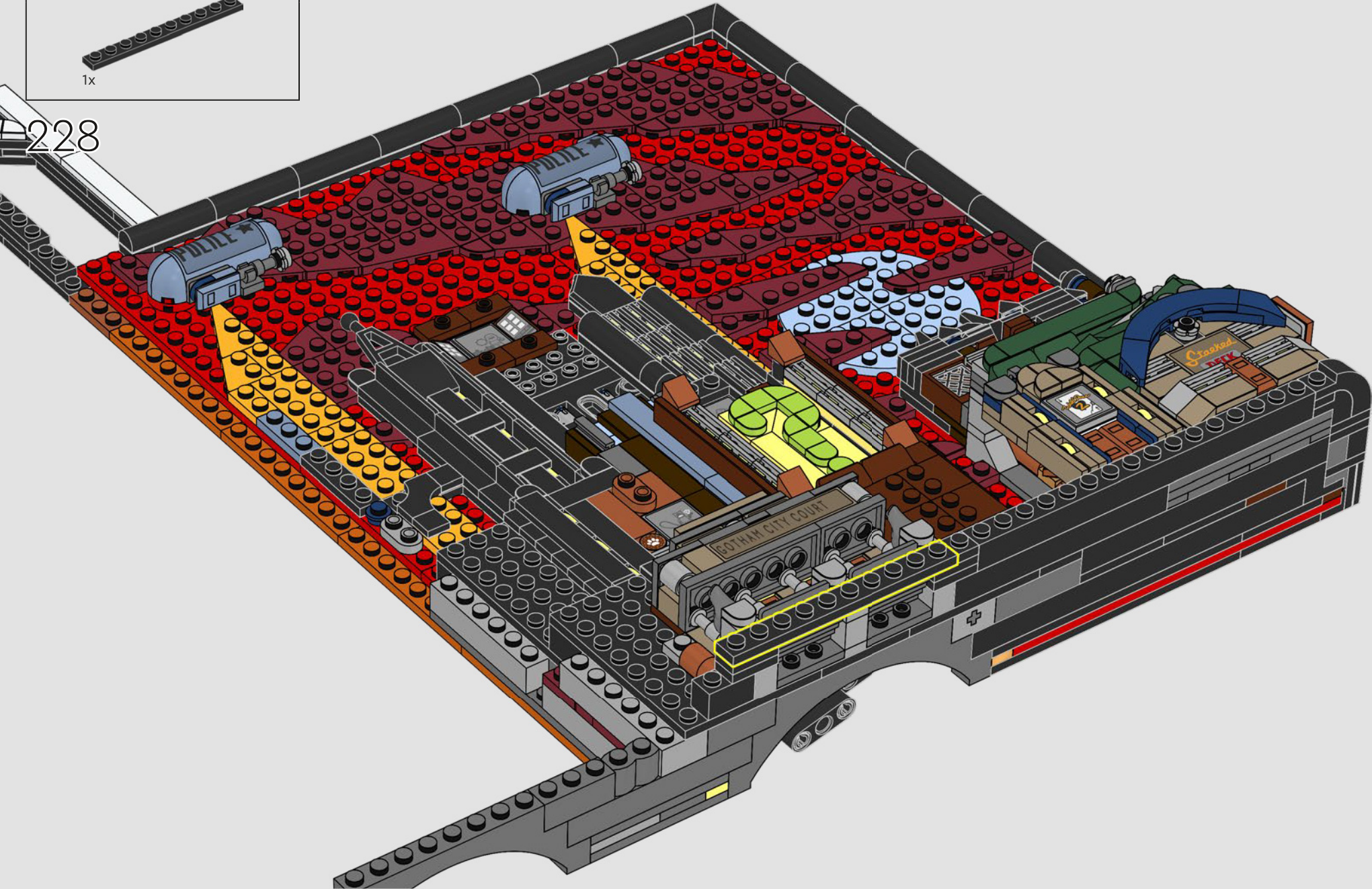

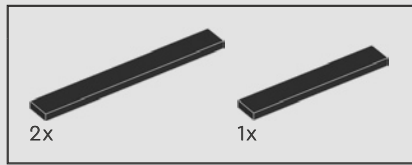

229

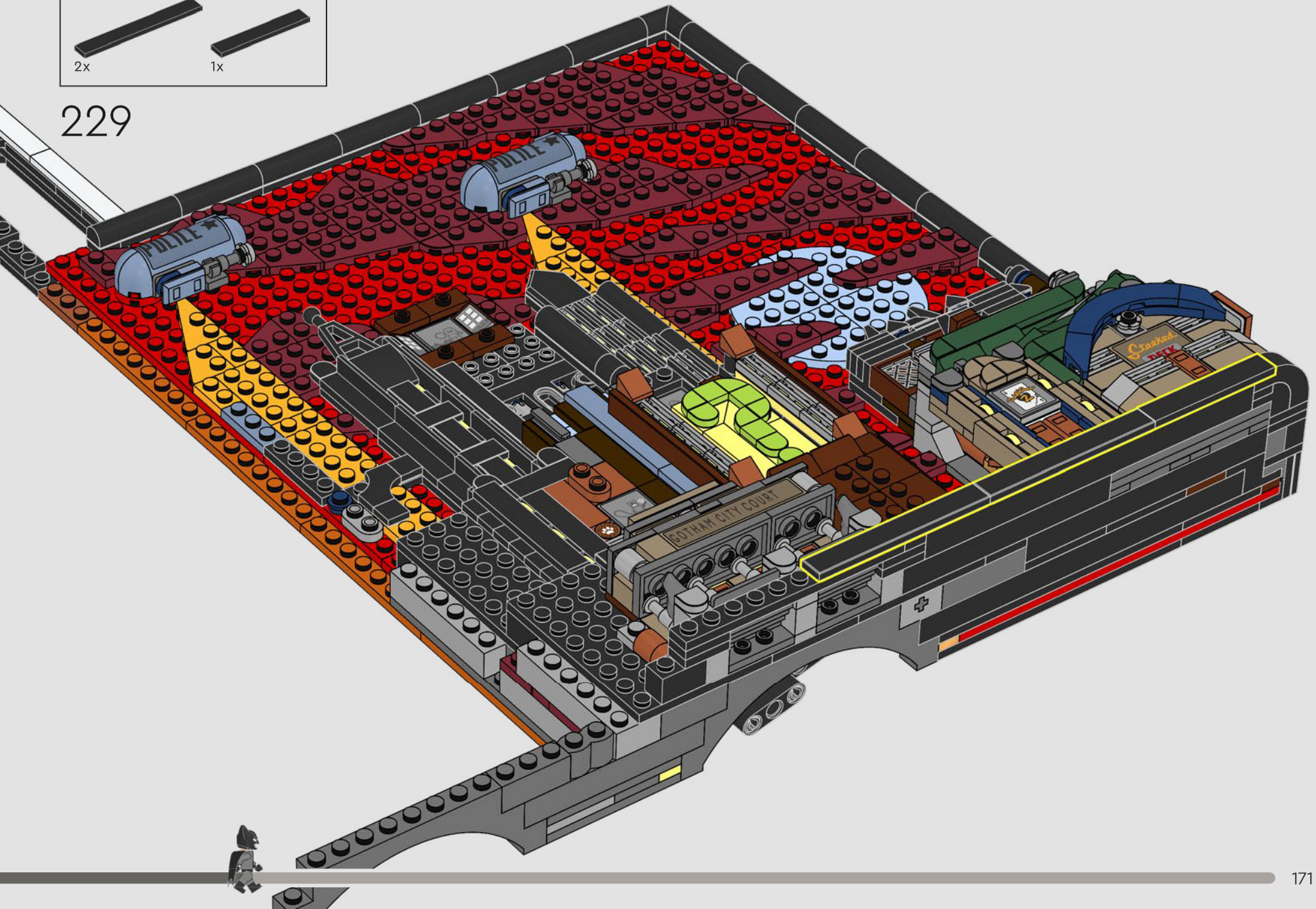



Episode: *Riddler's Reform*
Épisode : *La réinsertion de l'Homme-mystère*
Episodio: *La reforma del Acertijo*

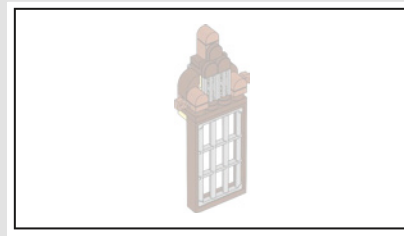

230

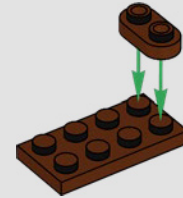

231





232

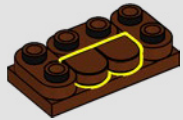

233



234



235

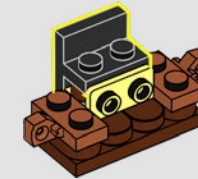

236

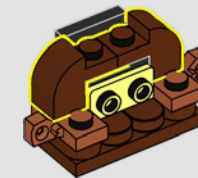



1x

237

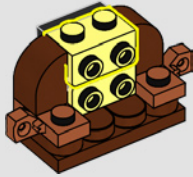

2x

239

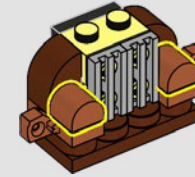

2x

238

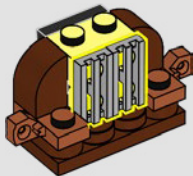

1x



1x



2x

240

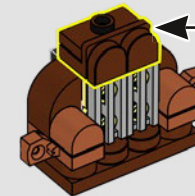
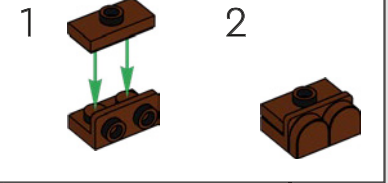

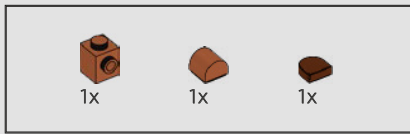

241

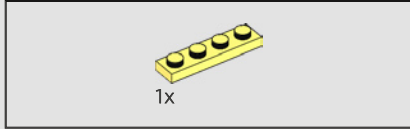
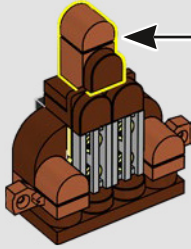
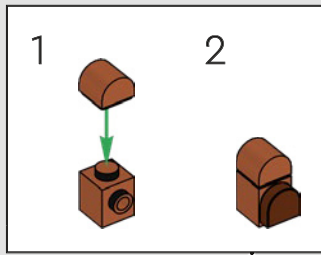

242

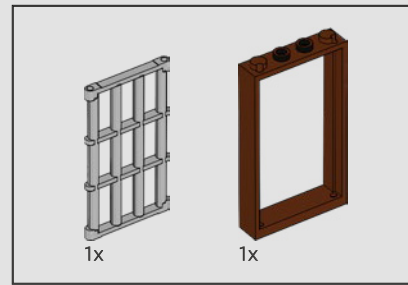
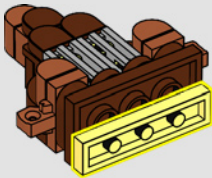

243

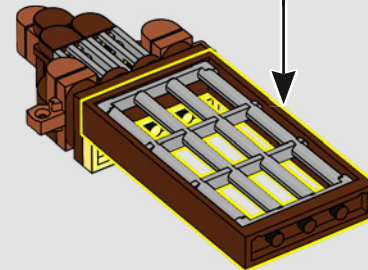
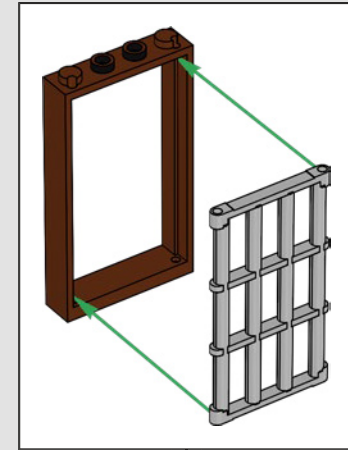

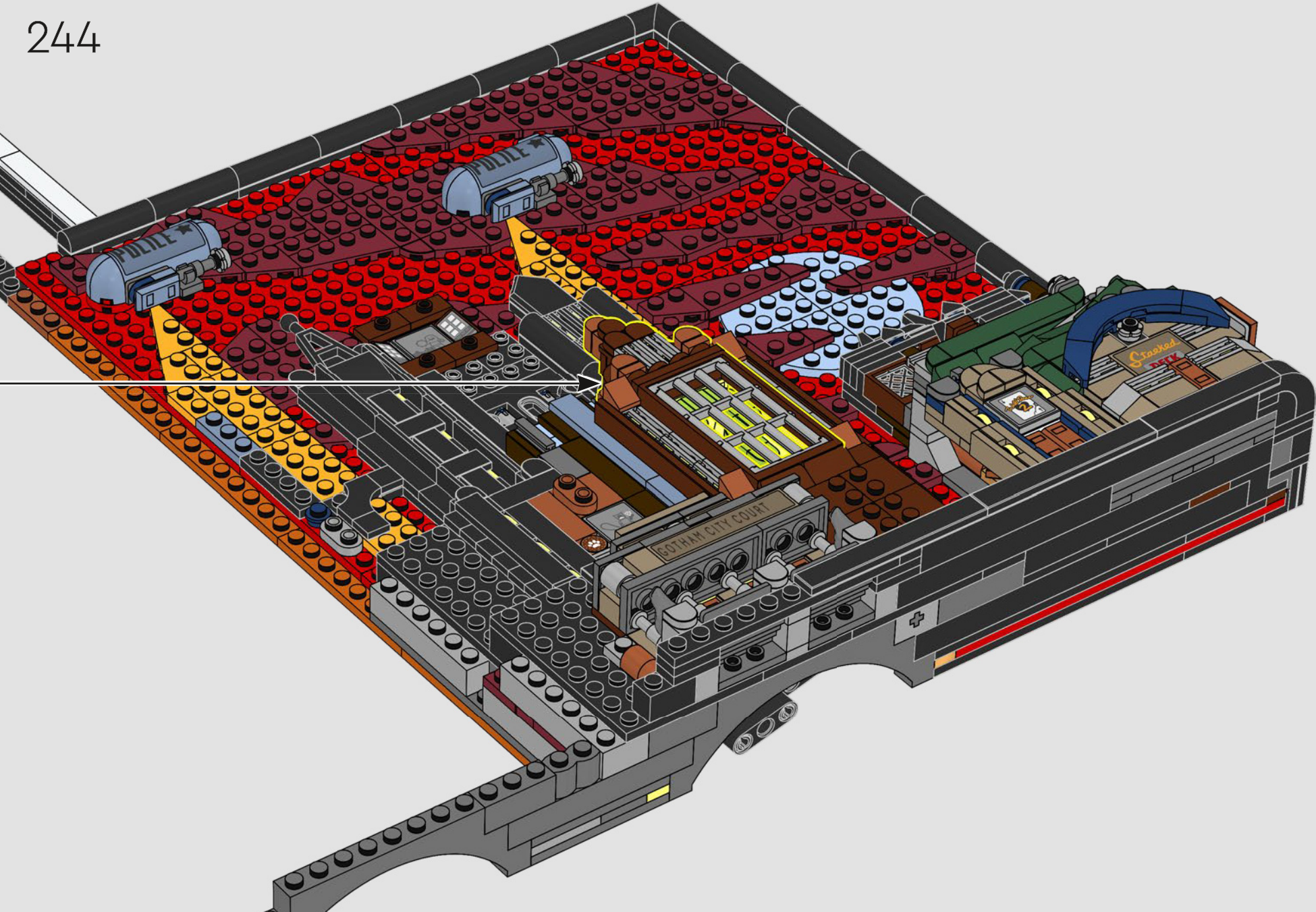

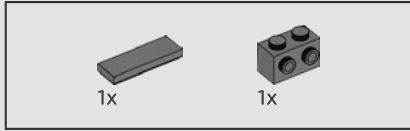
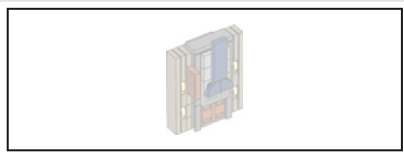

245

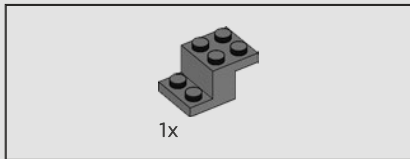
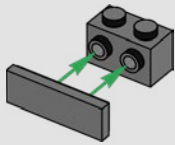

246

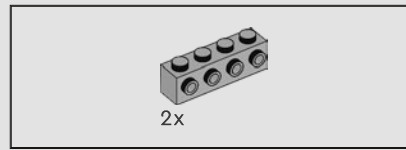
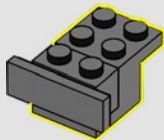

247

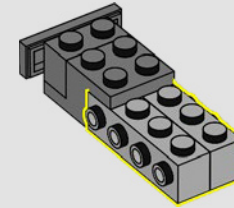

248

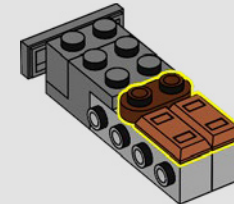

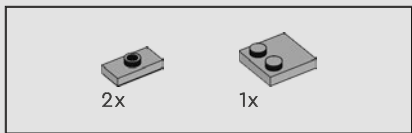

249

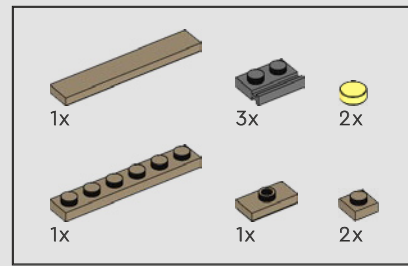
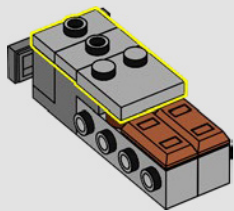

250

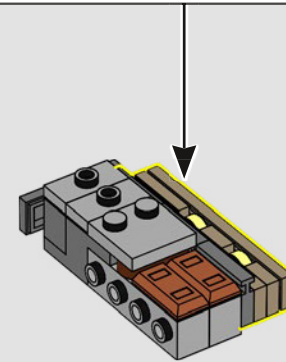
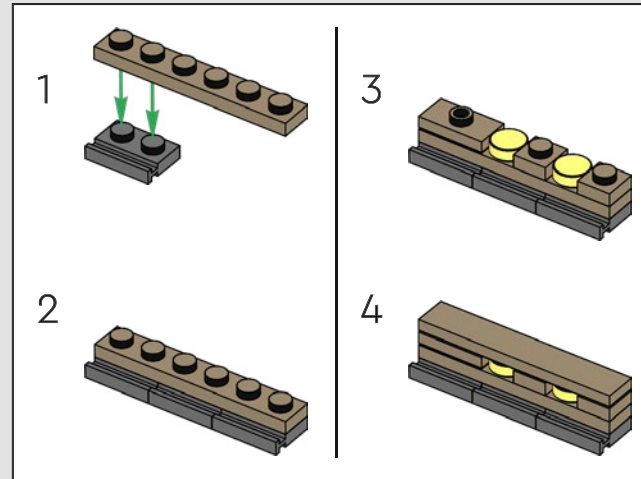

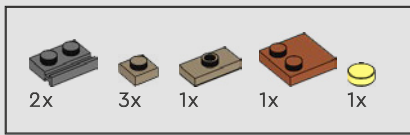

251

1

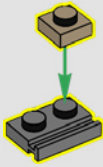

2

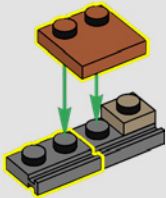

3

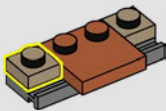

4

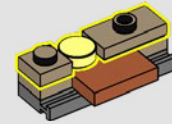

5

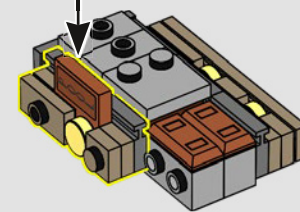
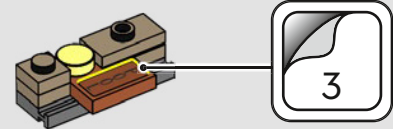



252

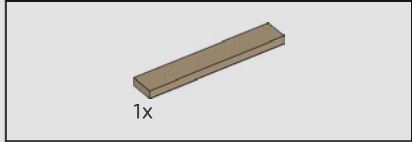
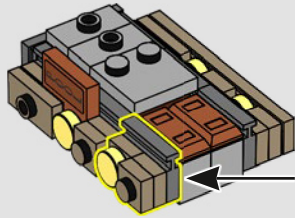
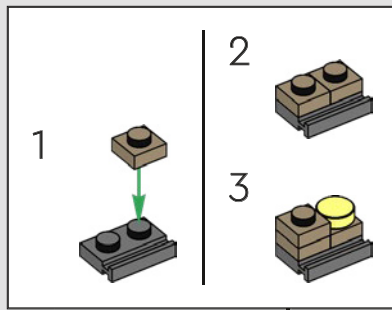

253

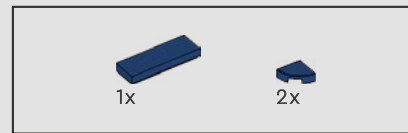
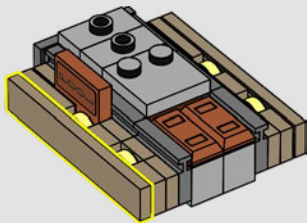

254

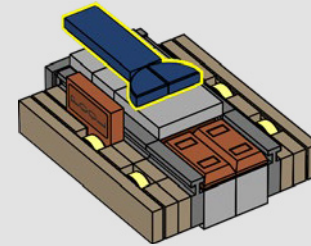

255

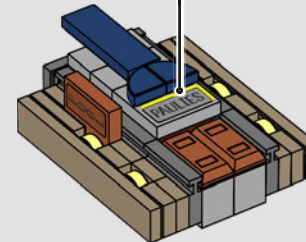

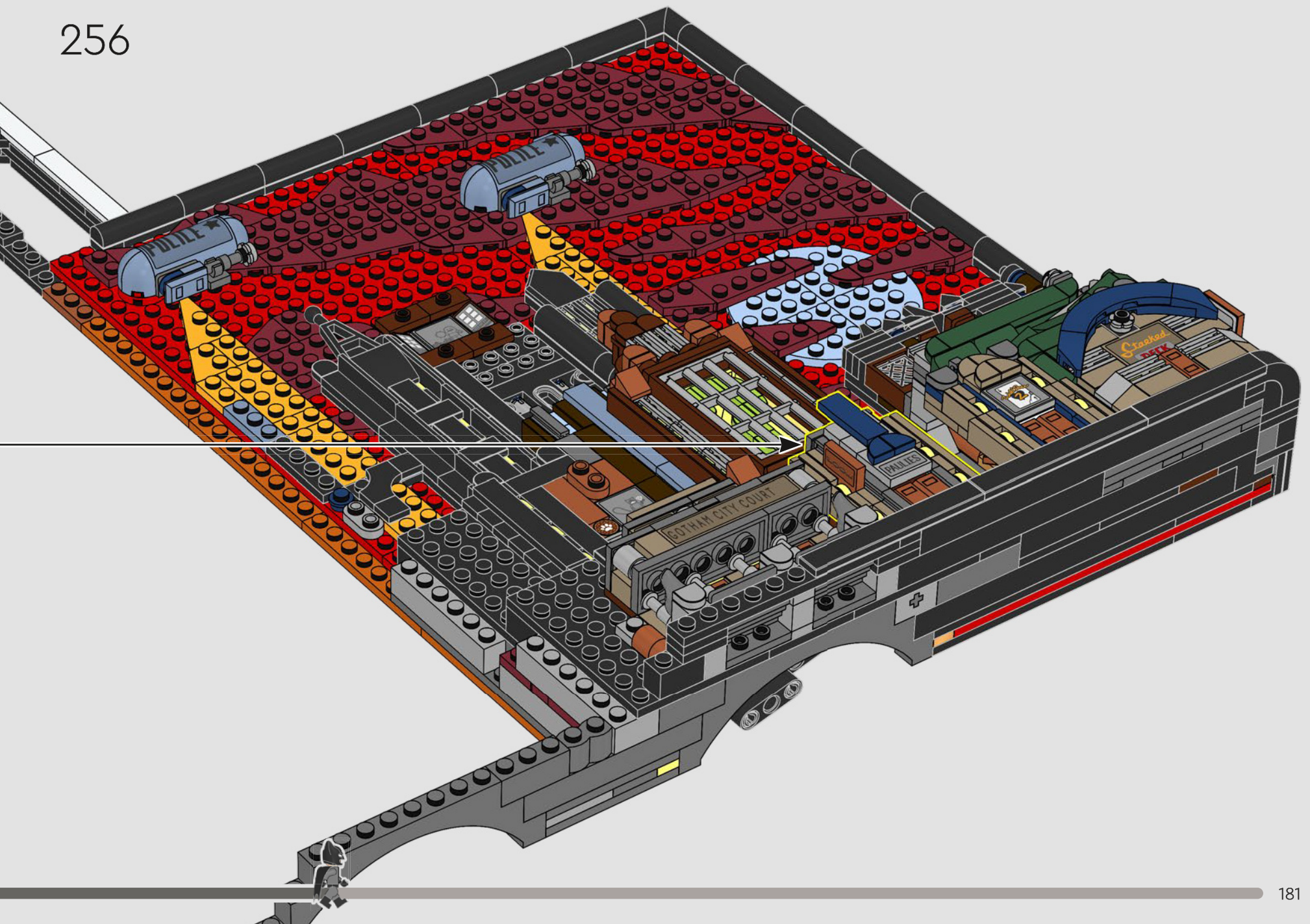

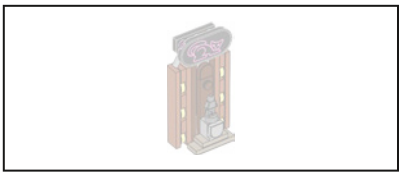

257

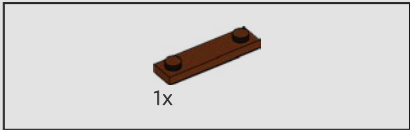
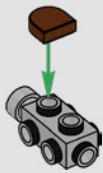

258

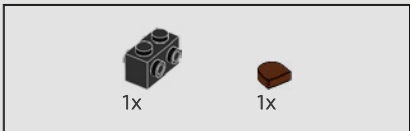
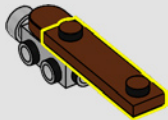

259

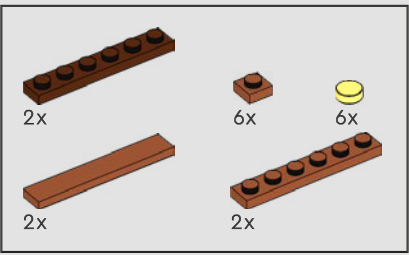
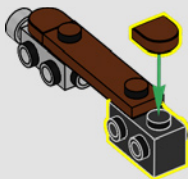

260

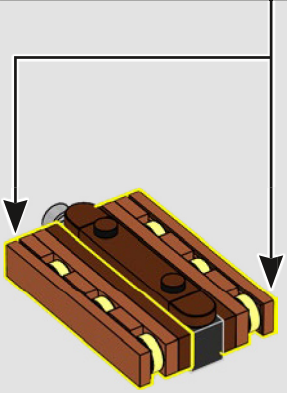
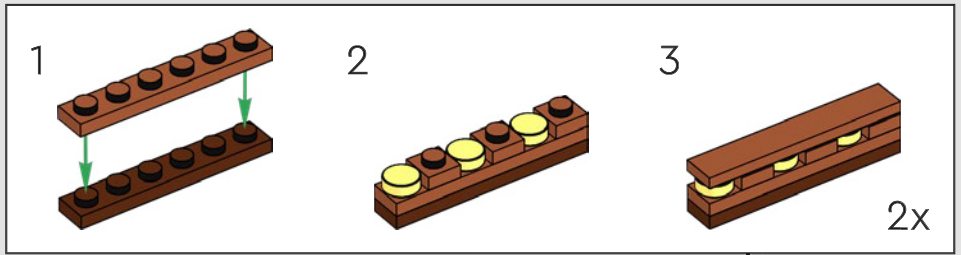

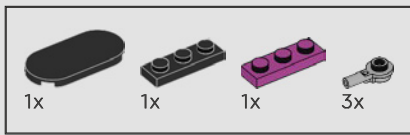

261

1

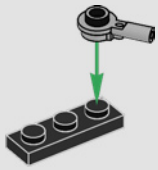

2

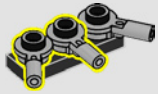

3

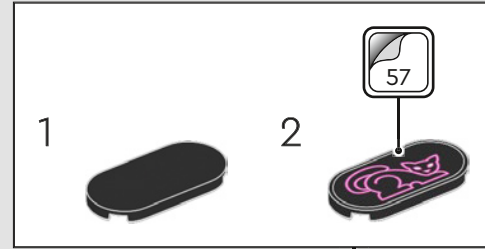
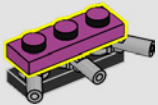

4



262

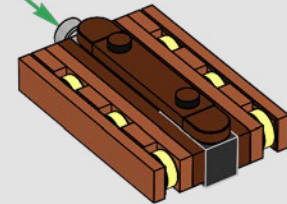

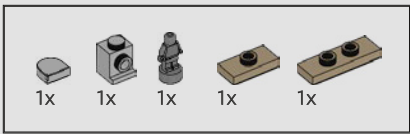

263

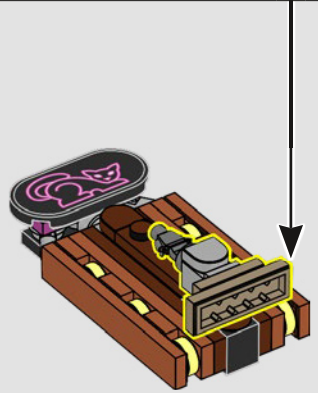
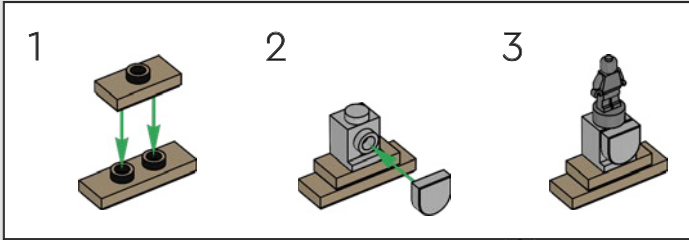

264

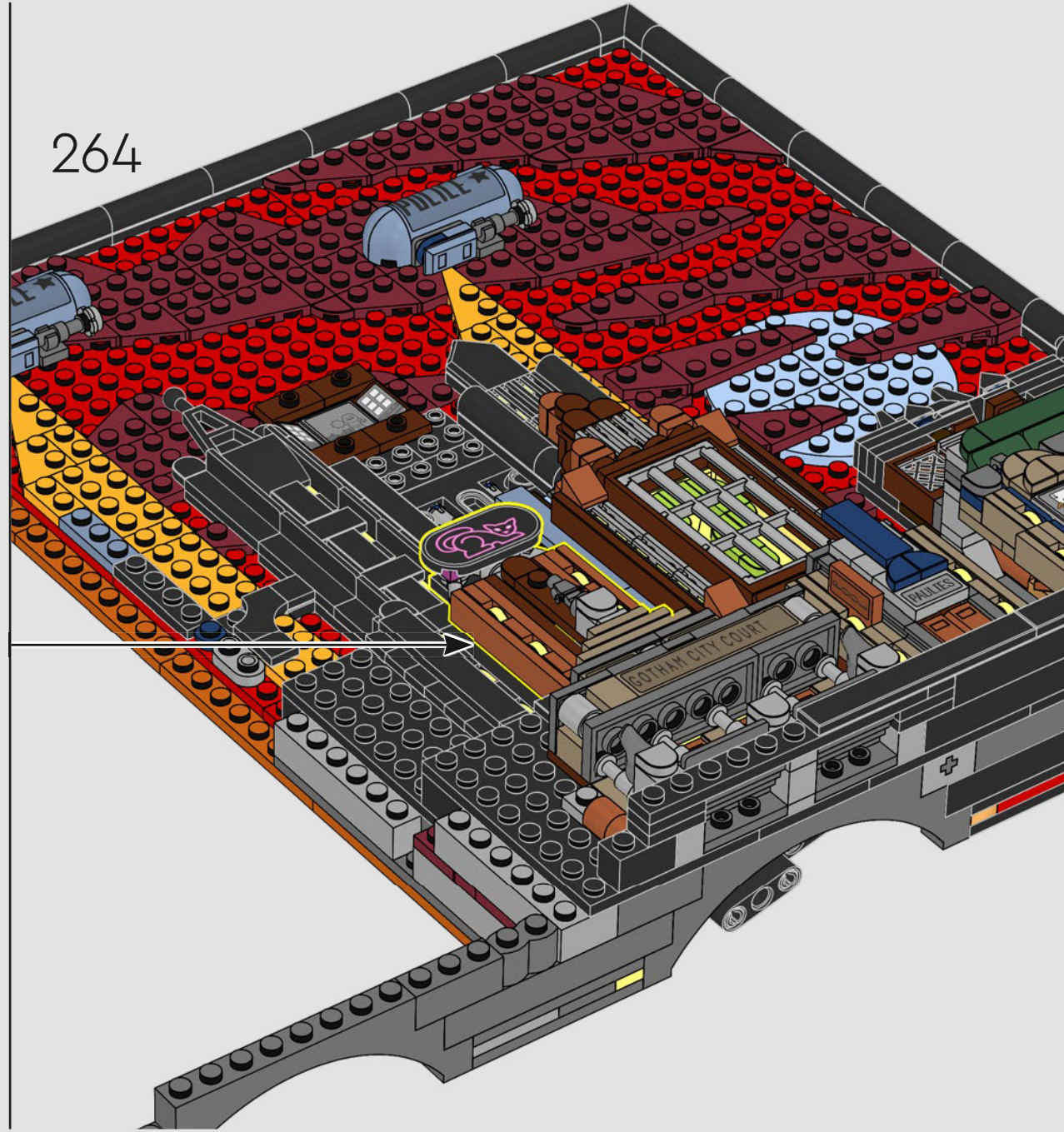



Episode: *Feat of Clay: Part II*
 Épisode : *Bas les masques*
 (2^e partie)
 Episodio: *Ilusión fatal: Parte 2*

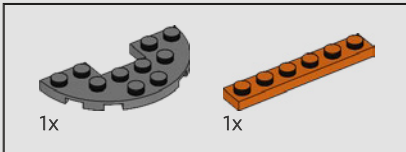
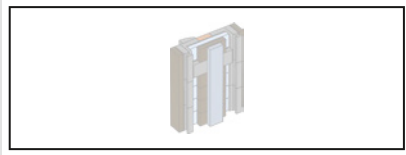

265

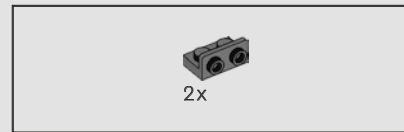
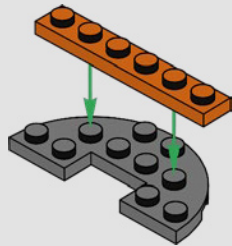

266

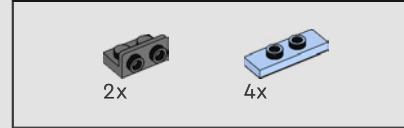
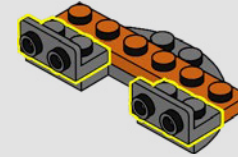

267

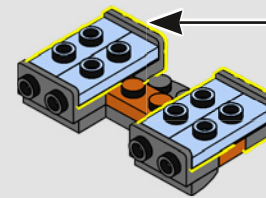
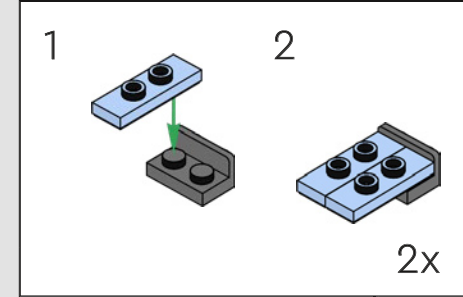

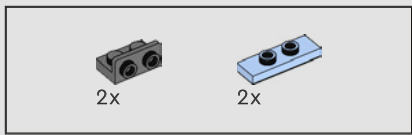

268

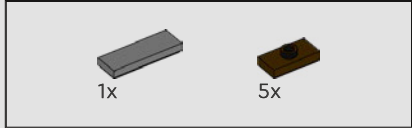
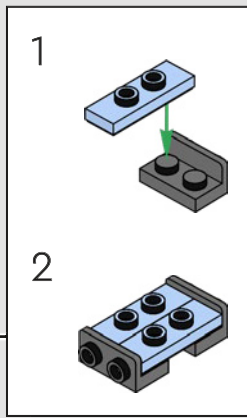
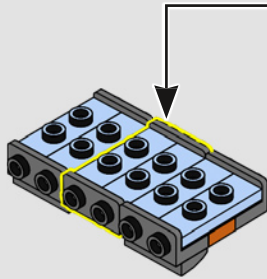

269

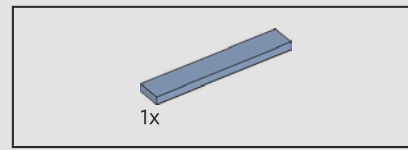
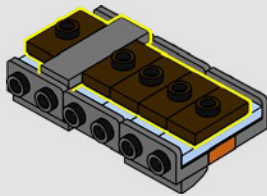

270

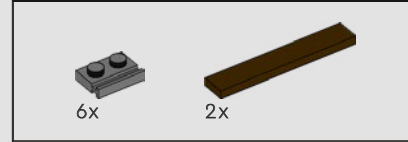
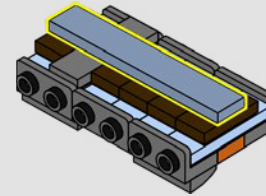

271

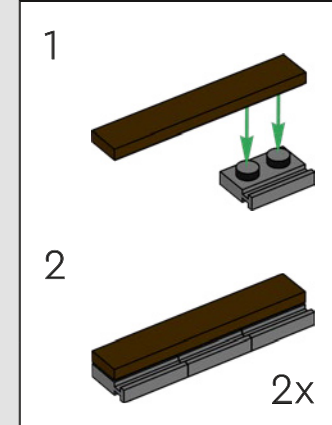
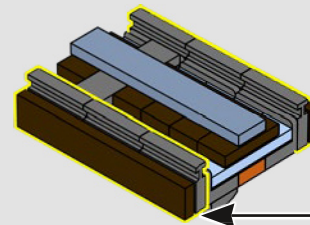

272

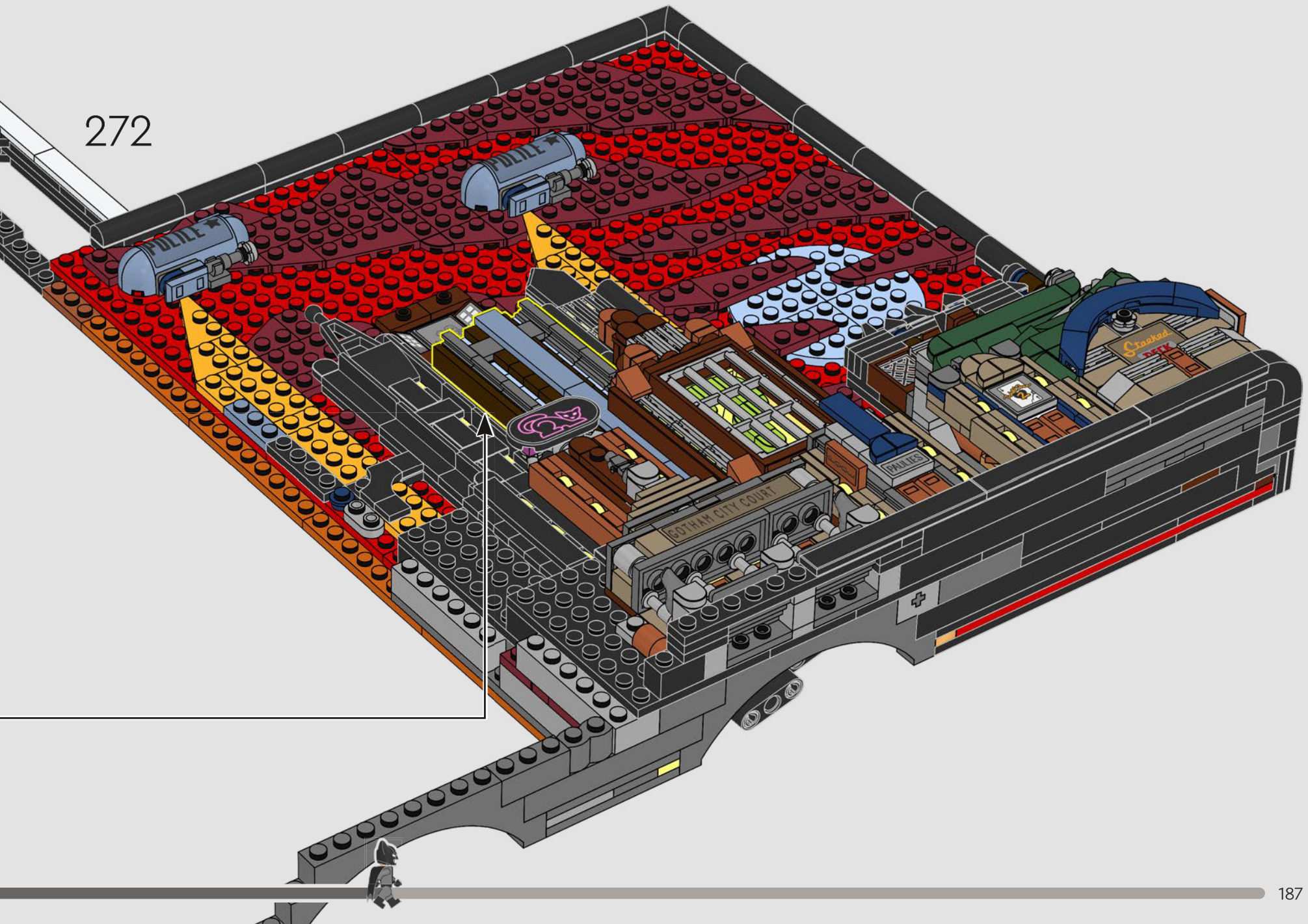

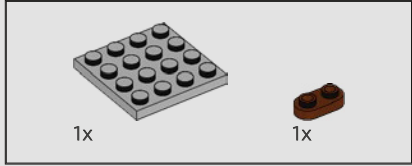
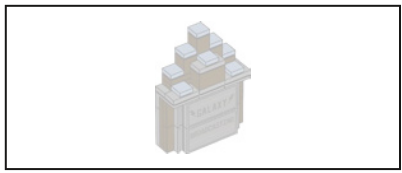

273

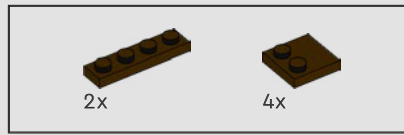
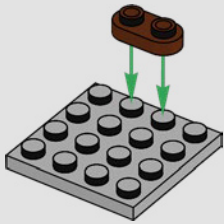

274

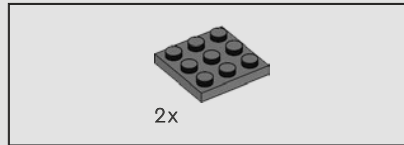
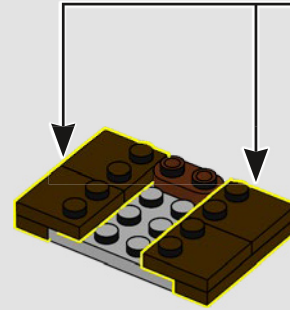
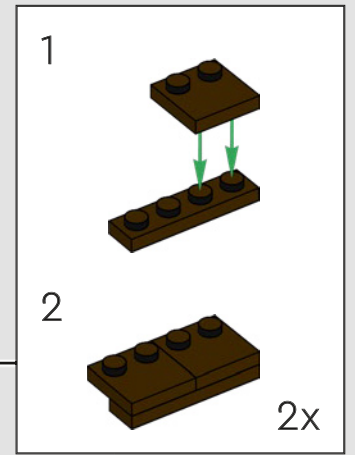

275

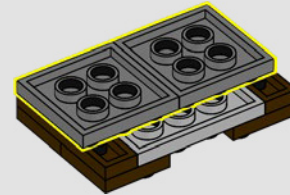

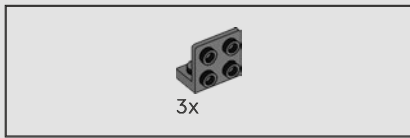

276

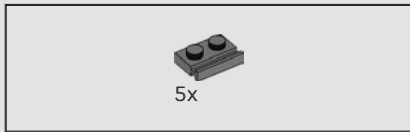
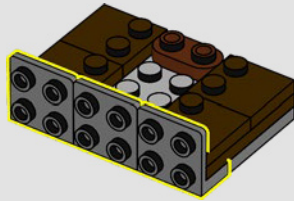

277

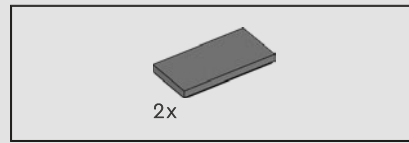
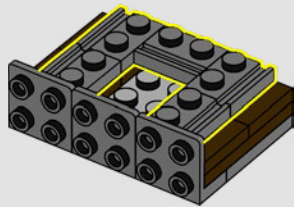

278

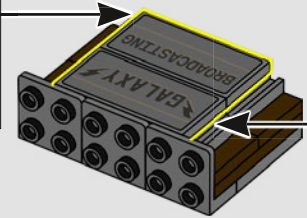
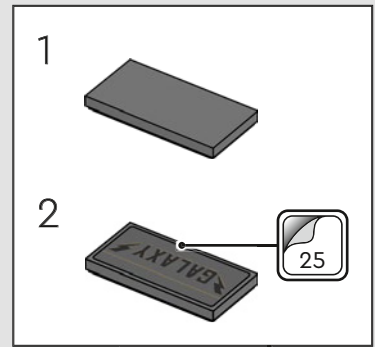
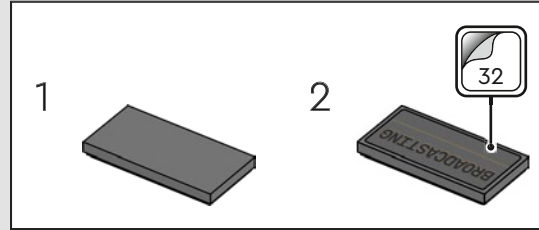

279

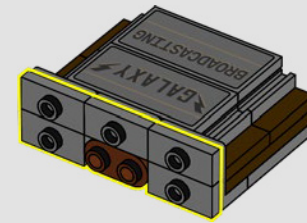

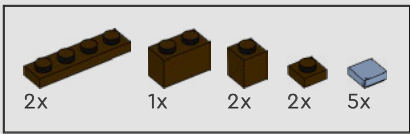

280

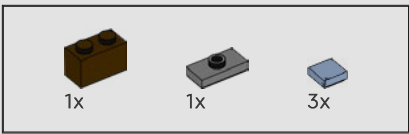
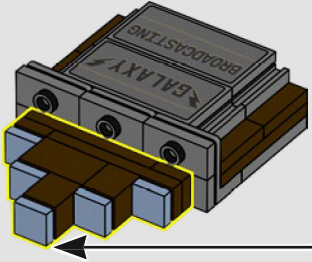
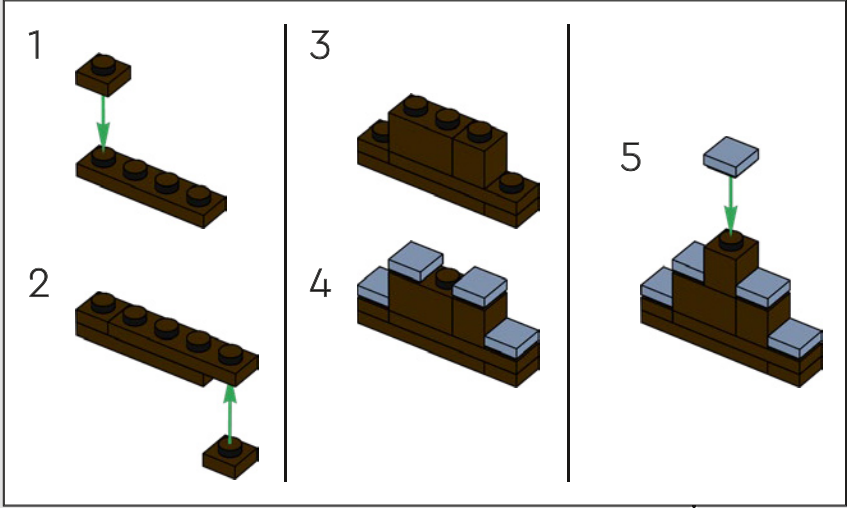

281

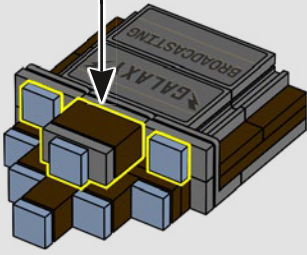
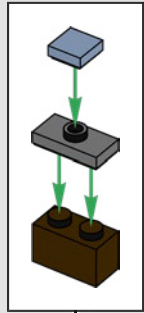

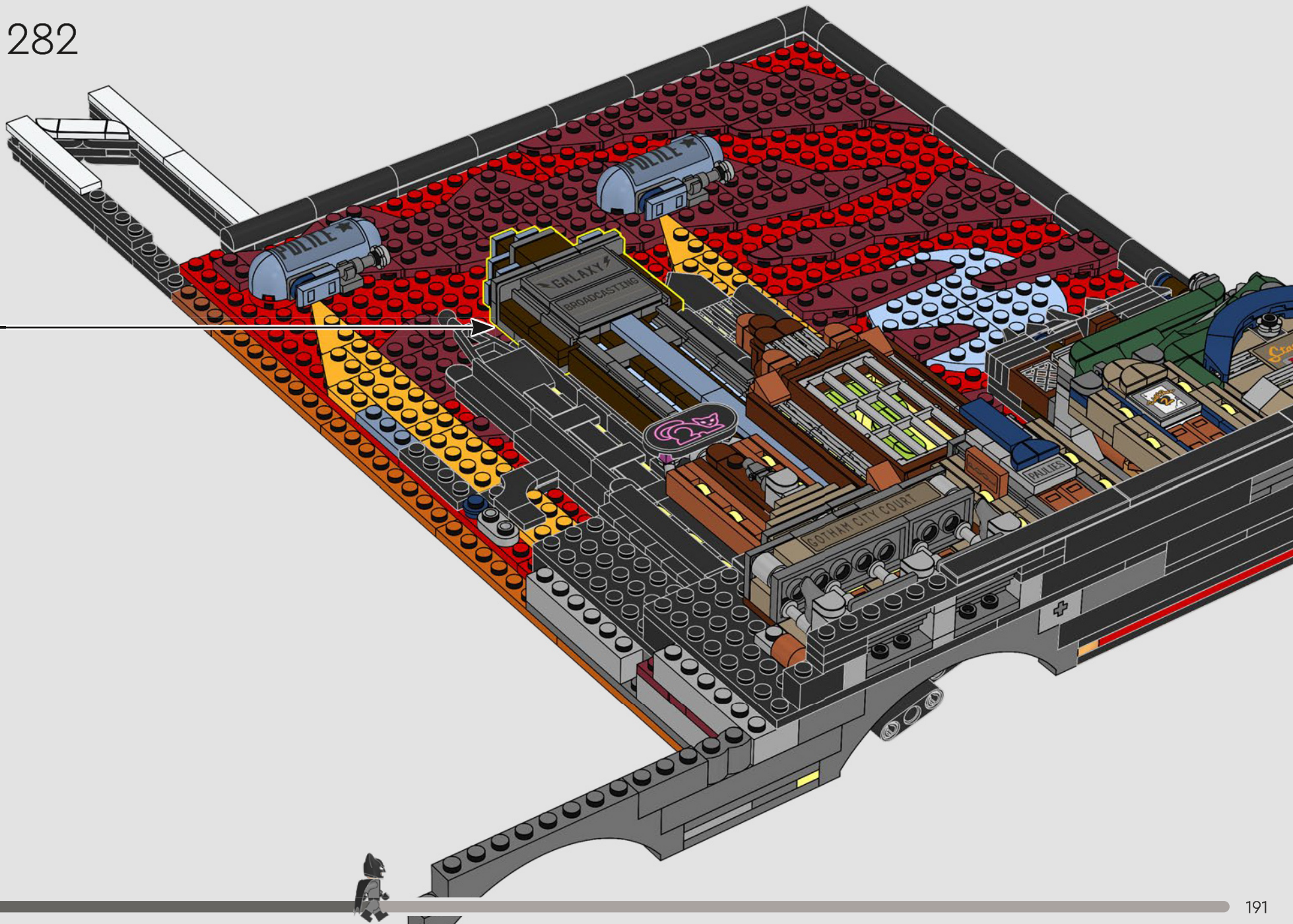

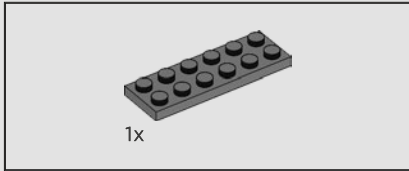
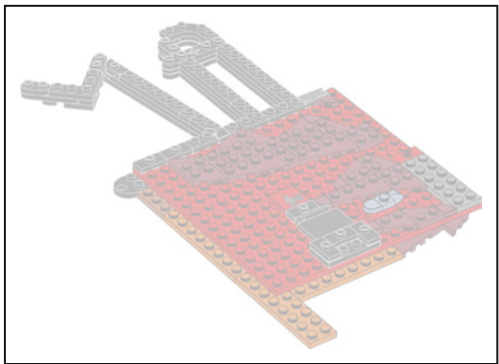
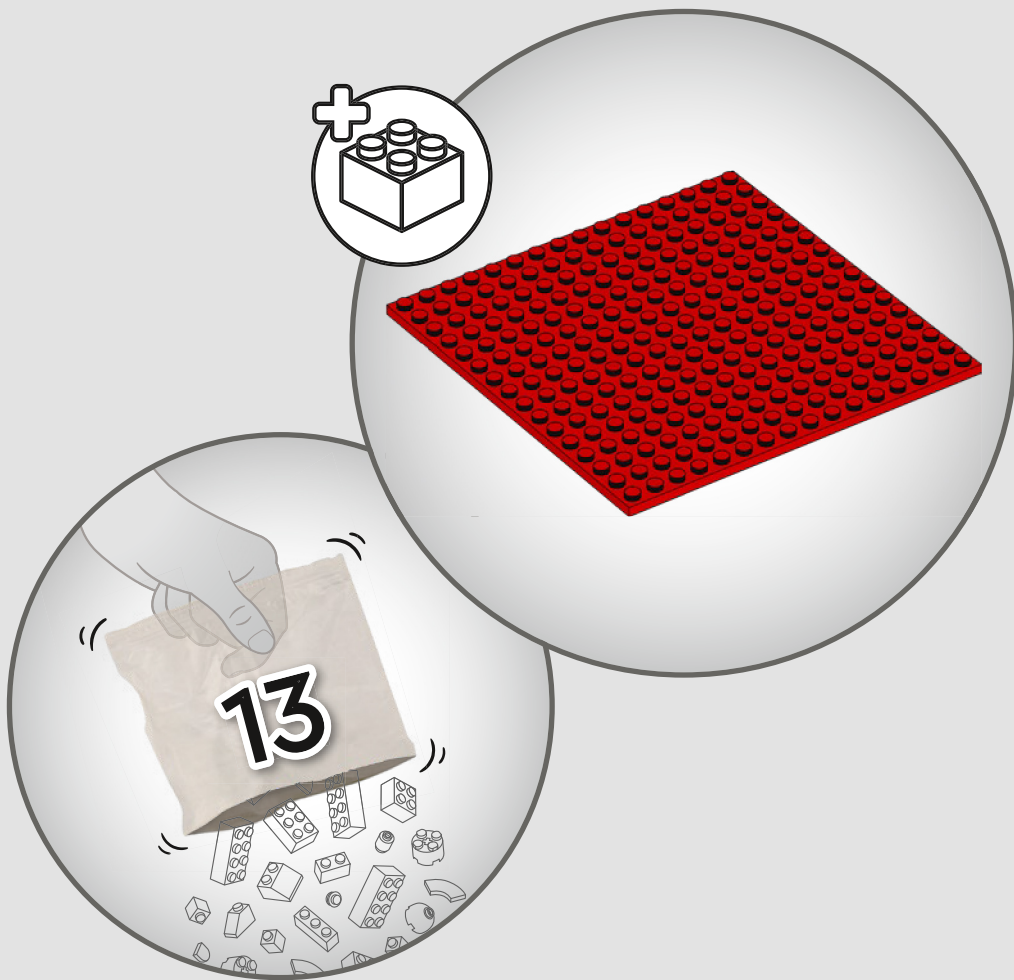

283

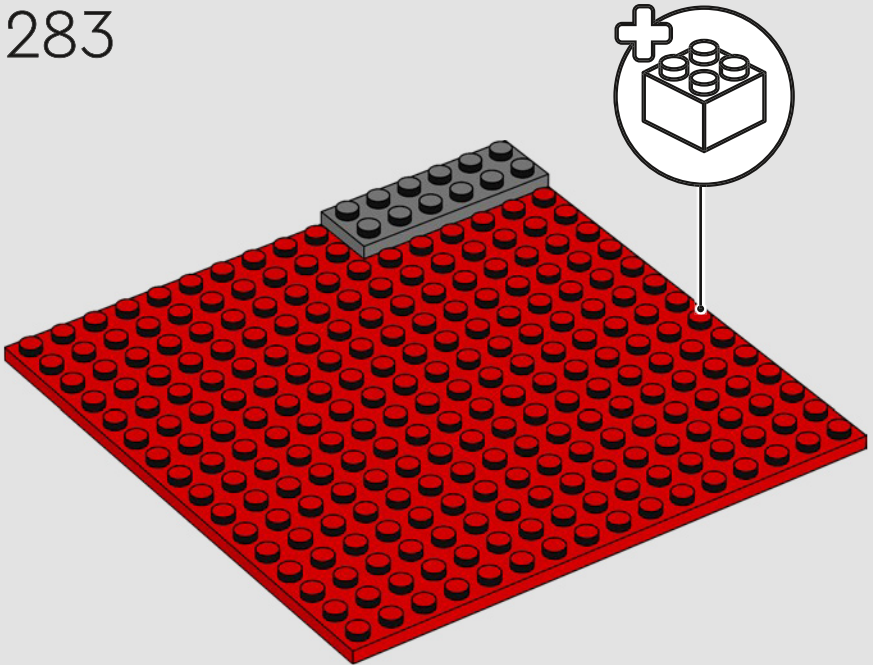

Episode: *Blind as a Bat*
Épisode : *Ombres et ténèbres*
Episodio: *Ciego como un murciélago*

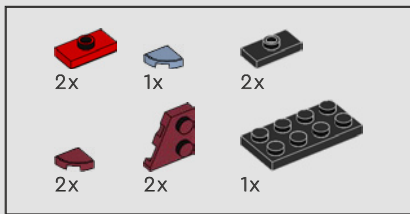

284

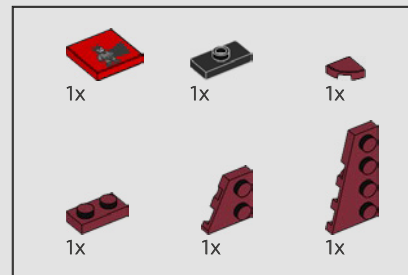
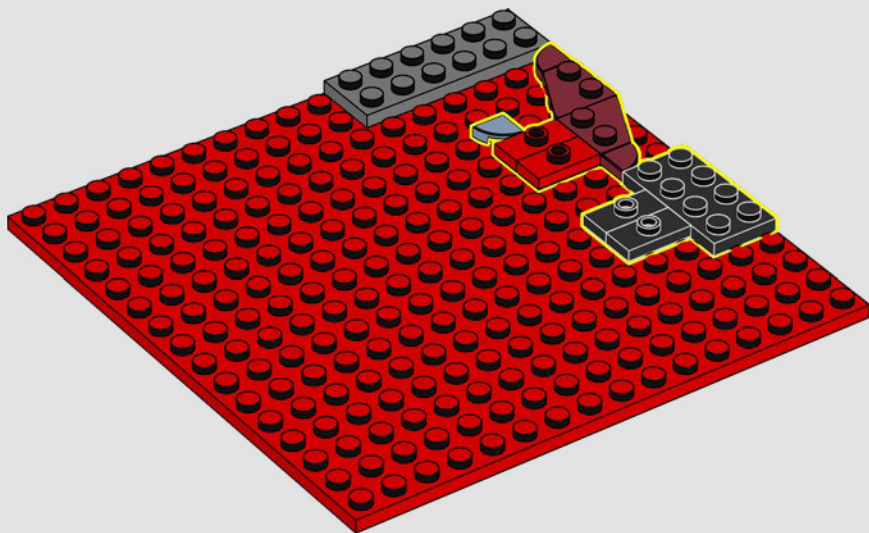

285

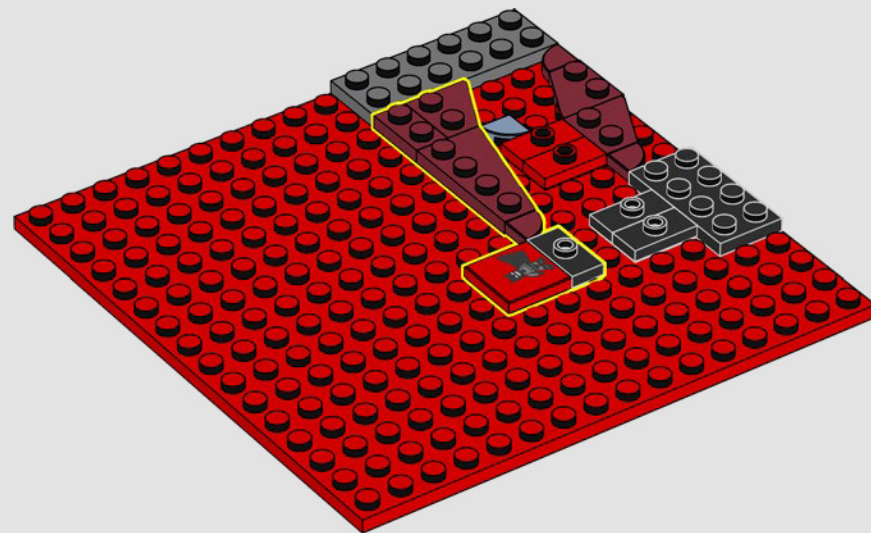

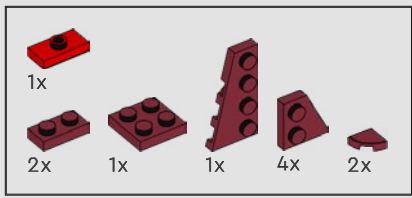

286

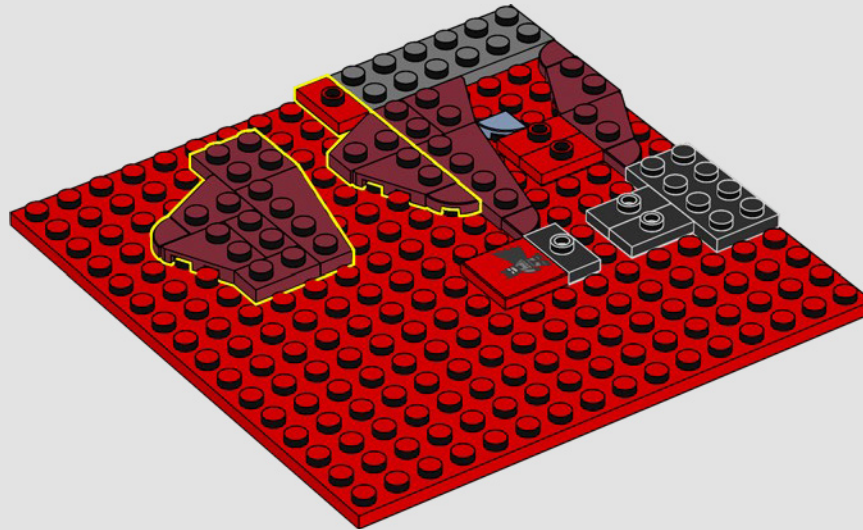

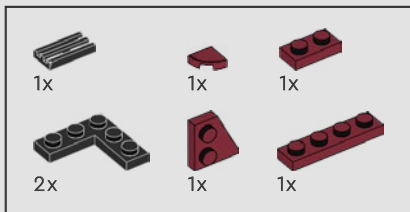

287

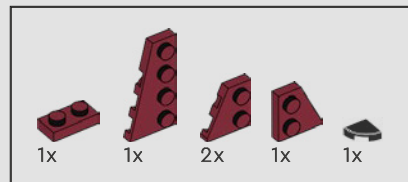
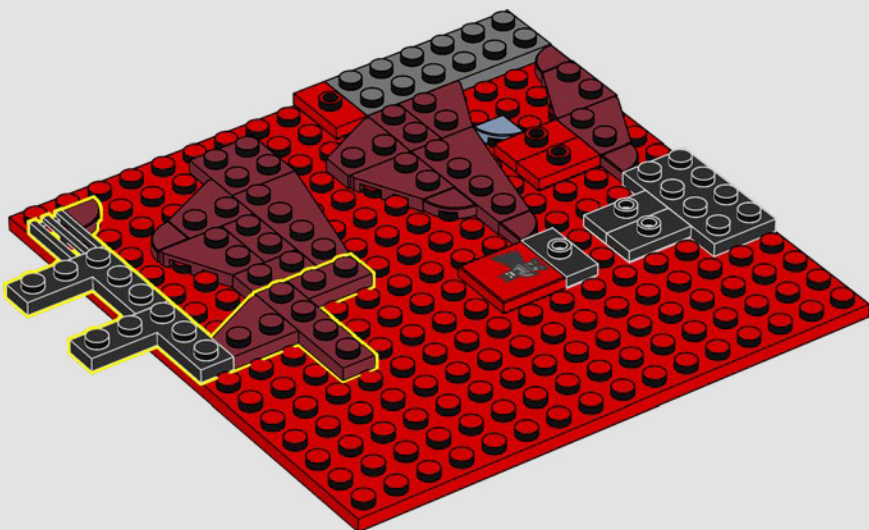

288

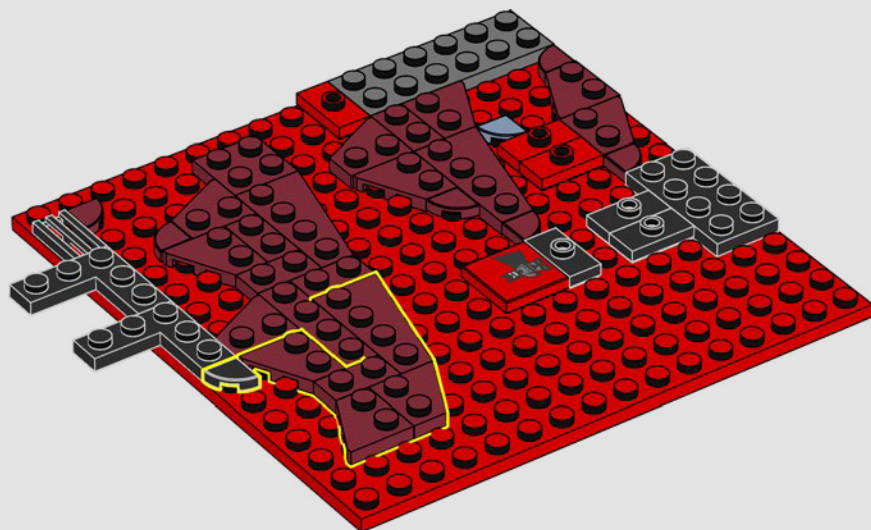

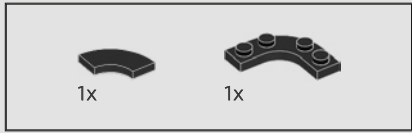
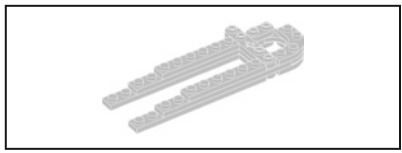

289

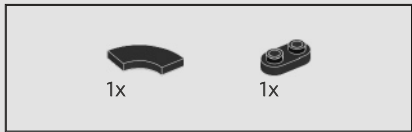
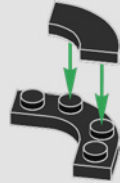

290

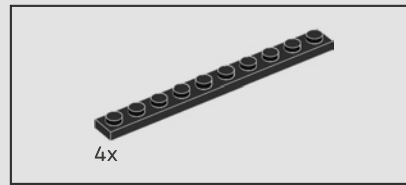
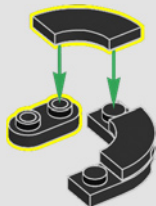

291

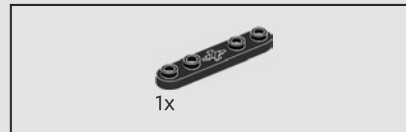
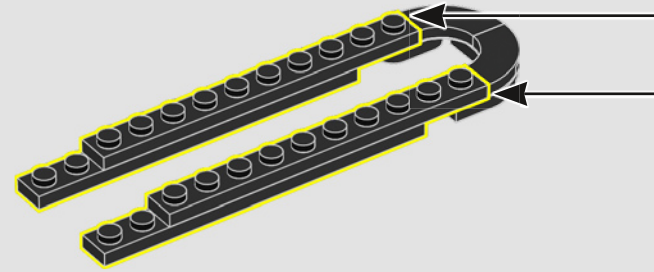
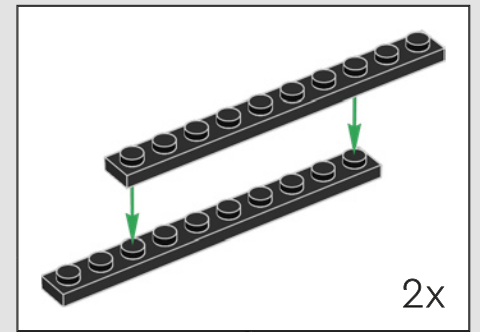

292

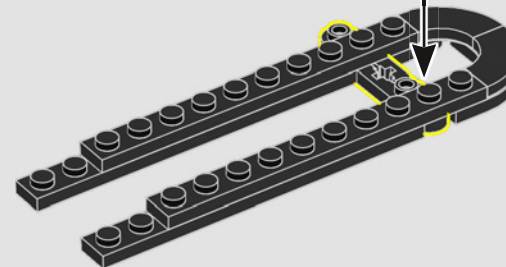

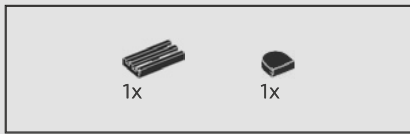

293

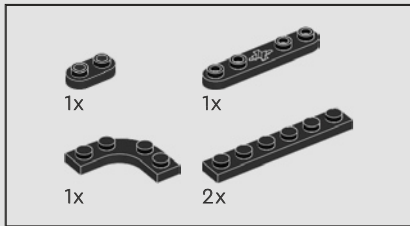
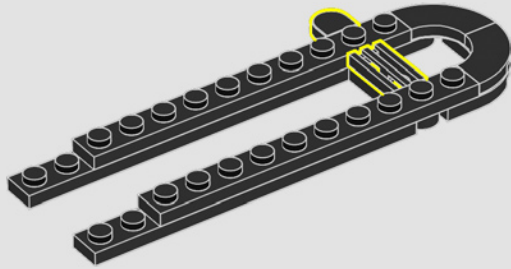

294

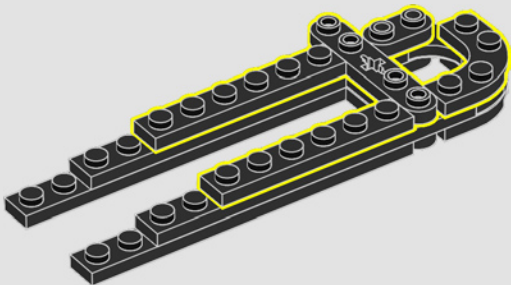

295

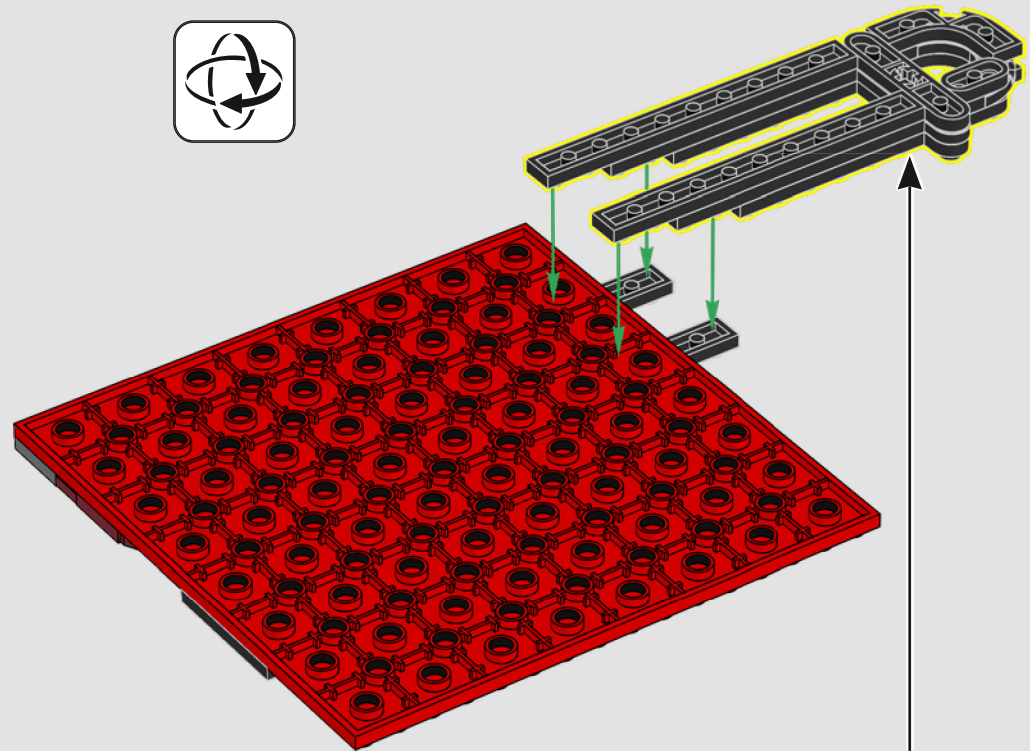

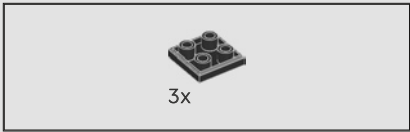

296

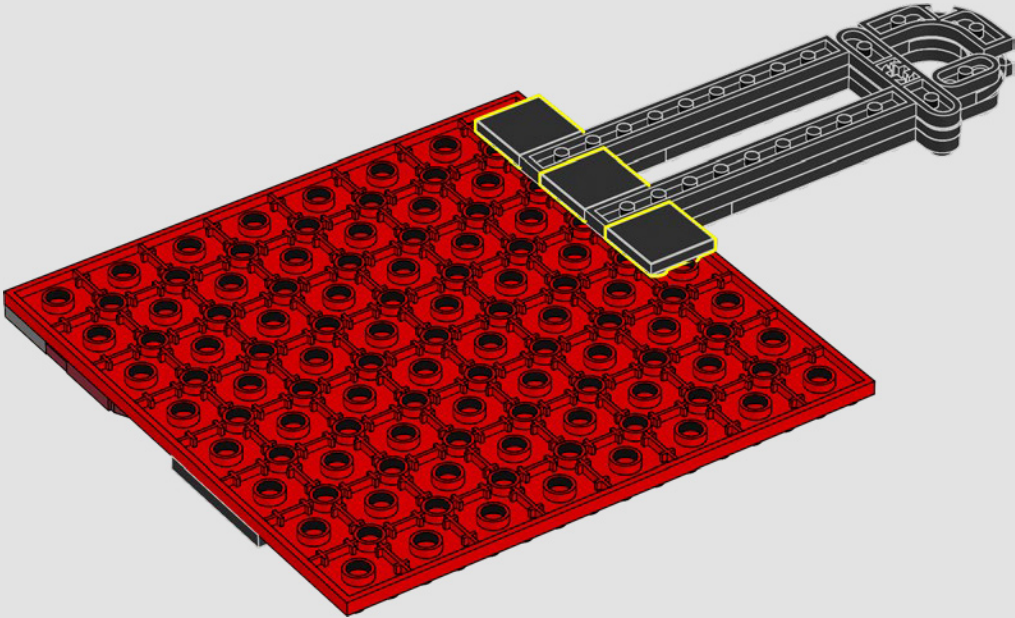

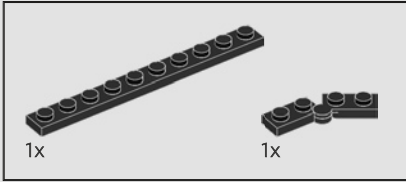
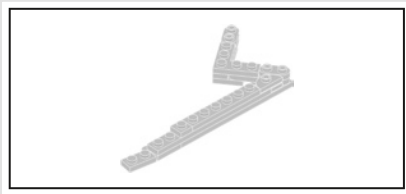

297

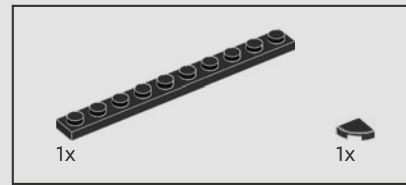
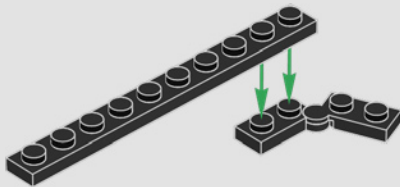

298

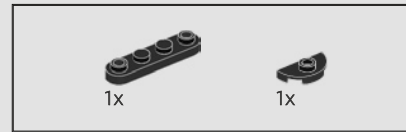
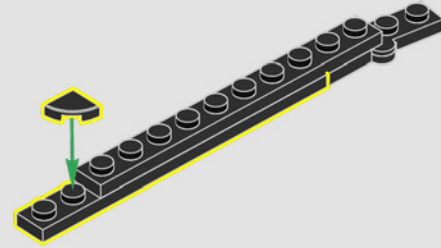

299

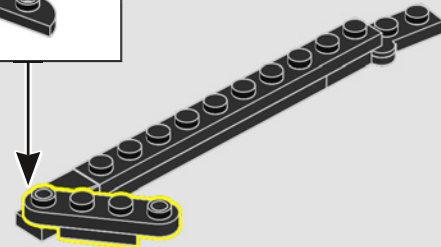
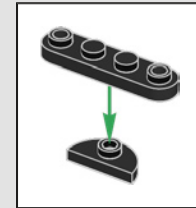



300

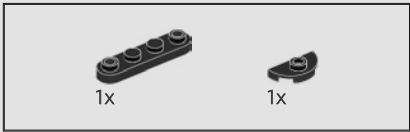
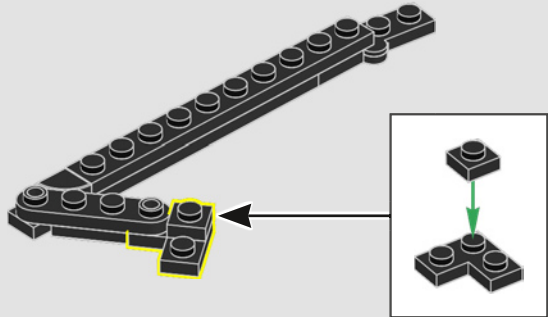

301

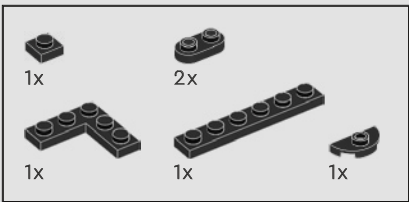
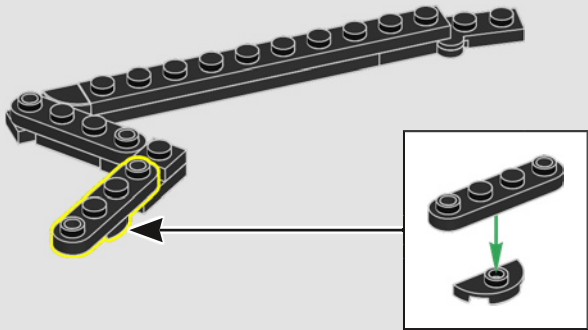

302

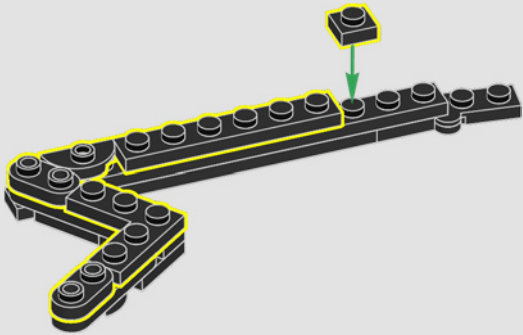

303

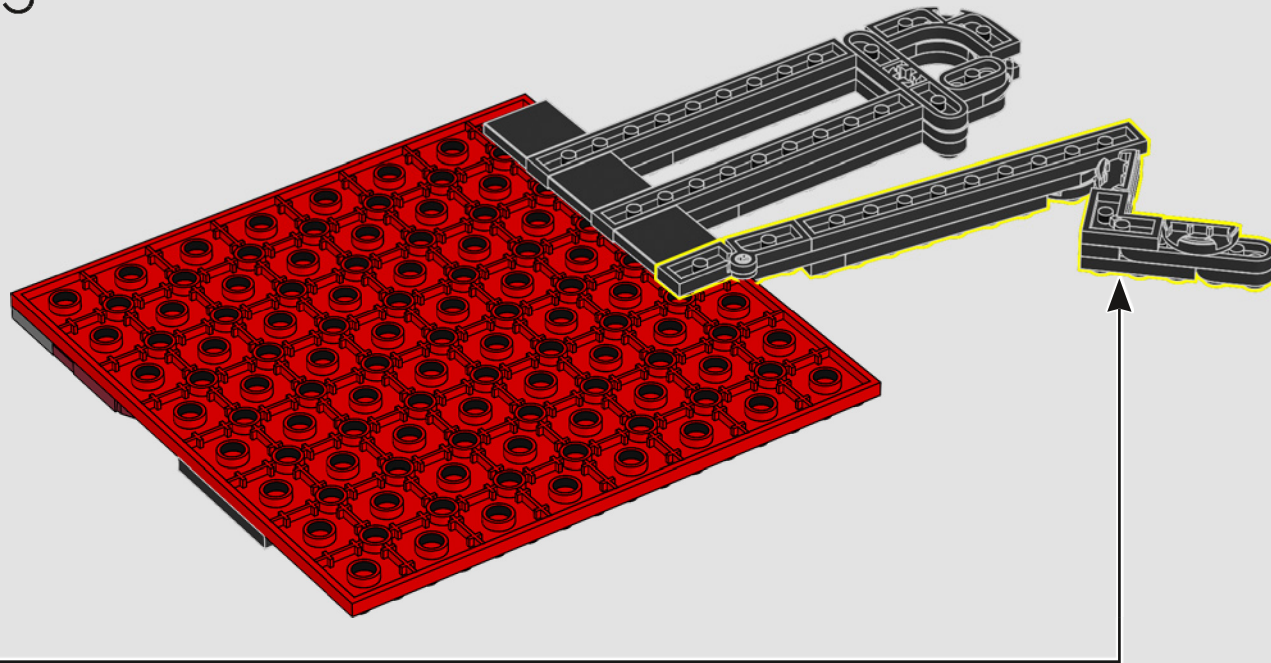

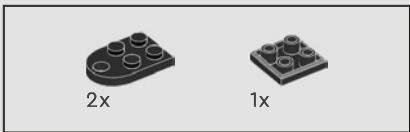

304

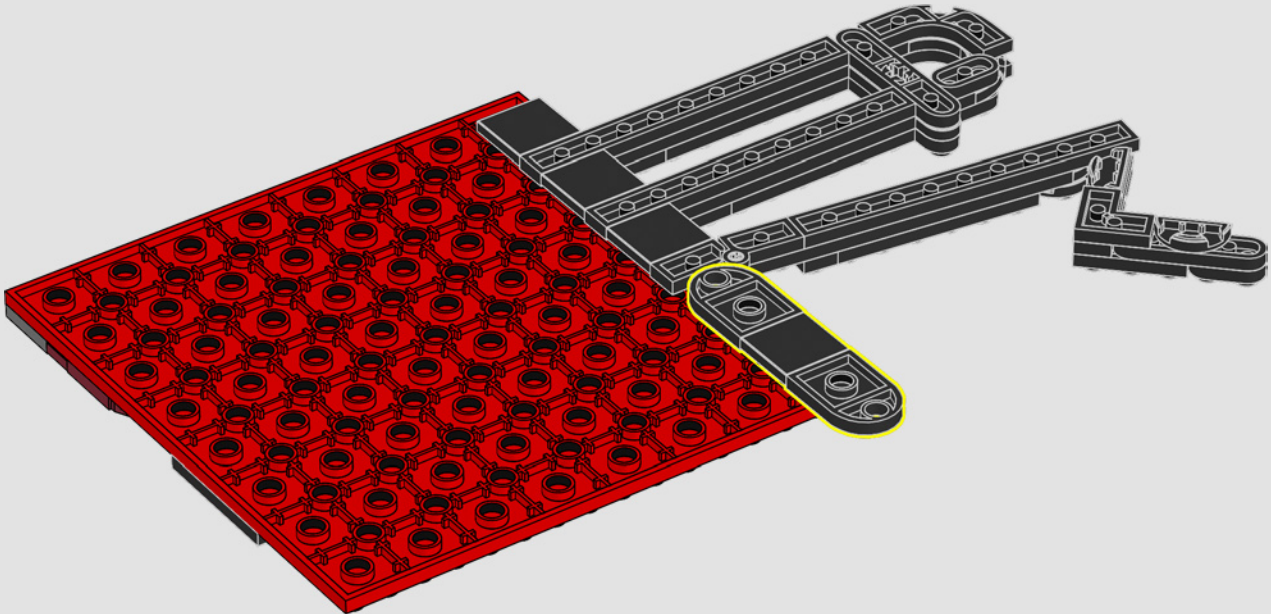

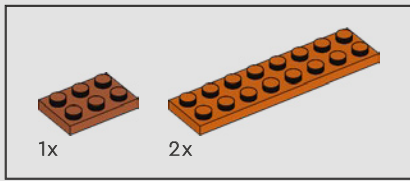

305

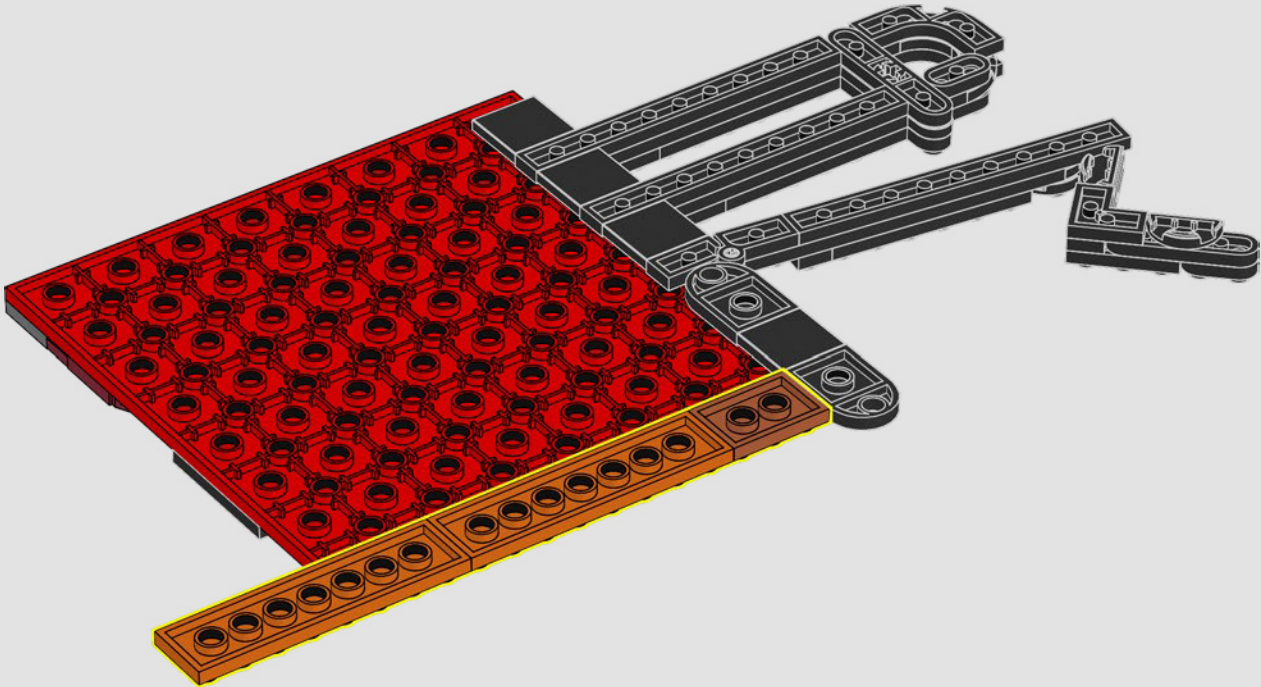

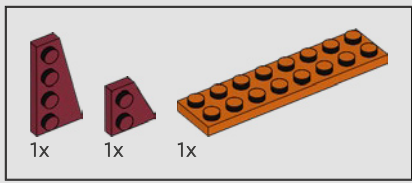

306

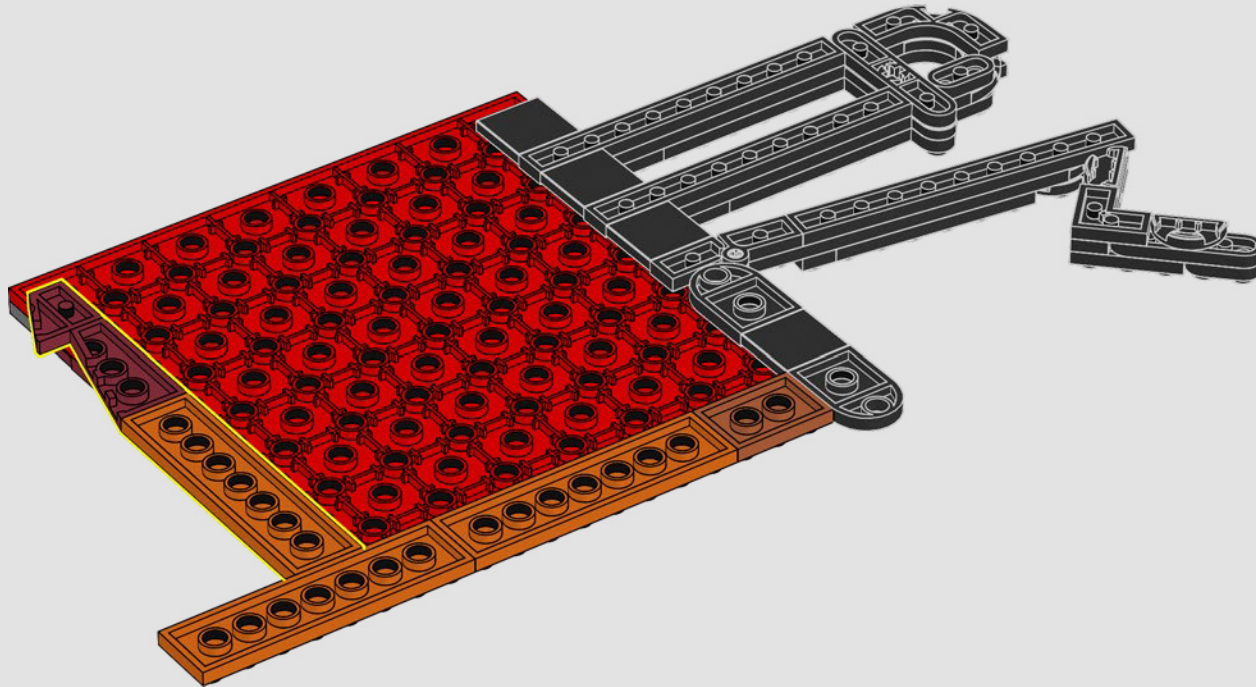

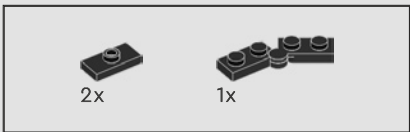

307

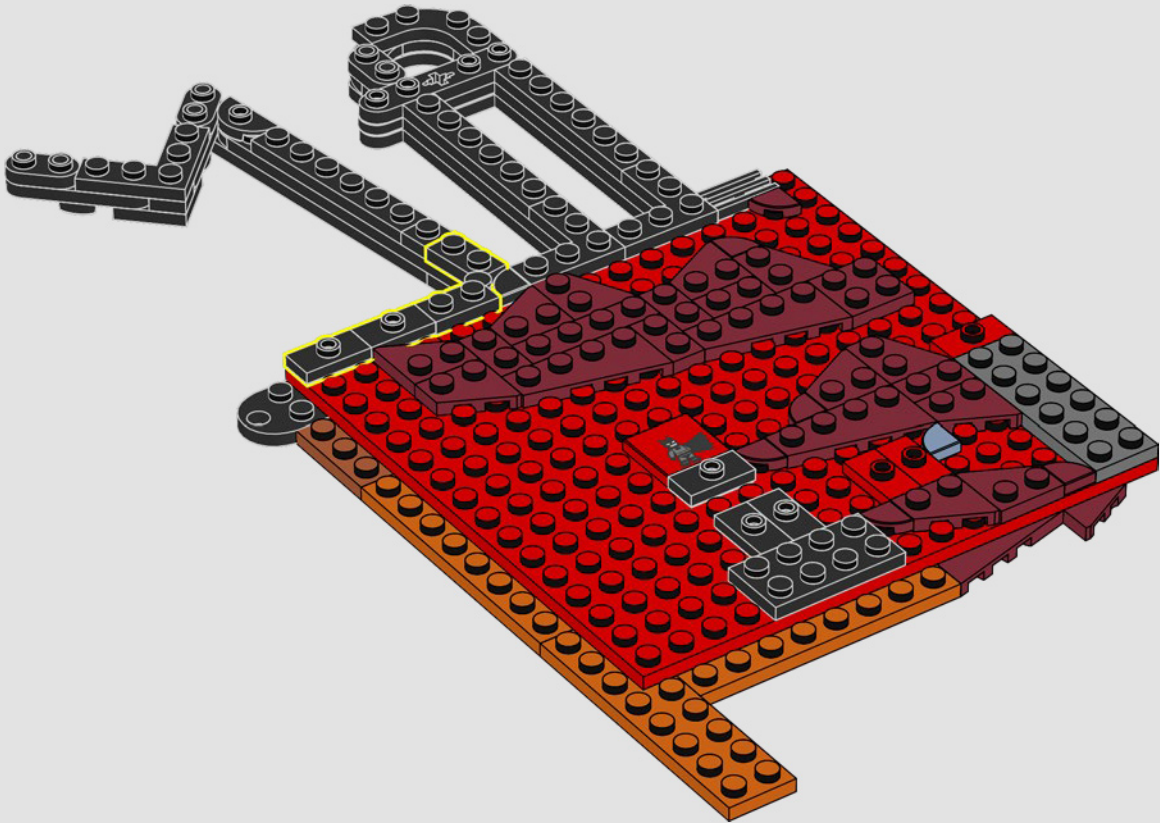

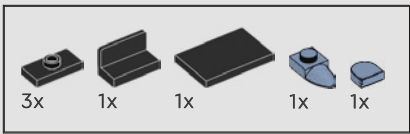

308

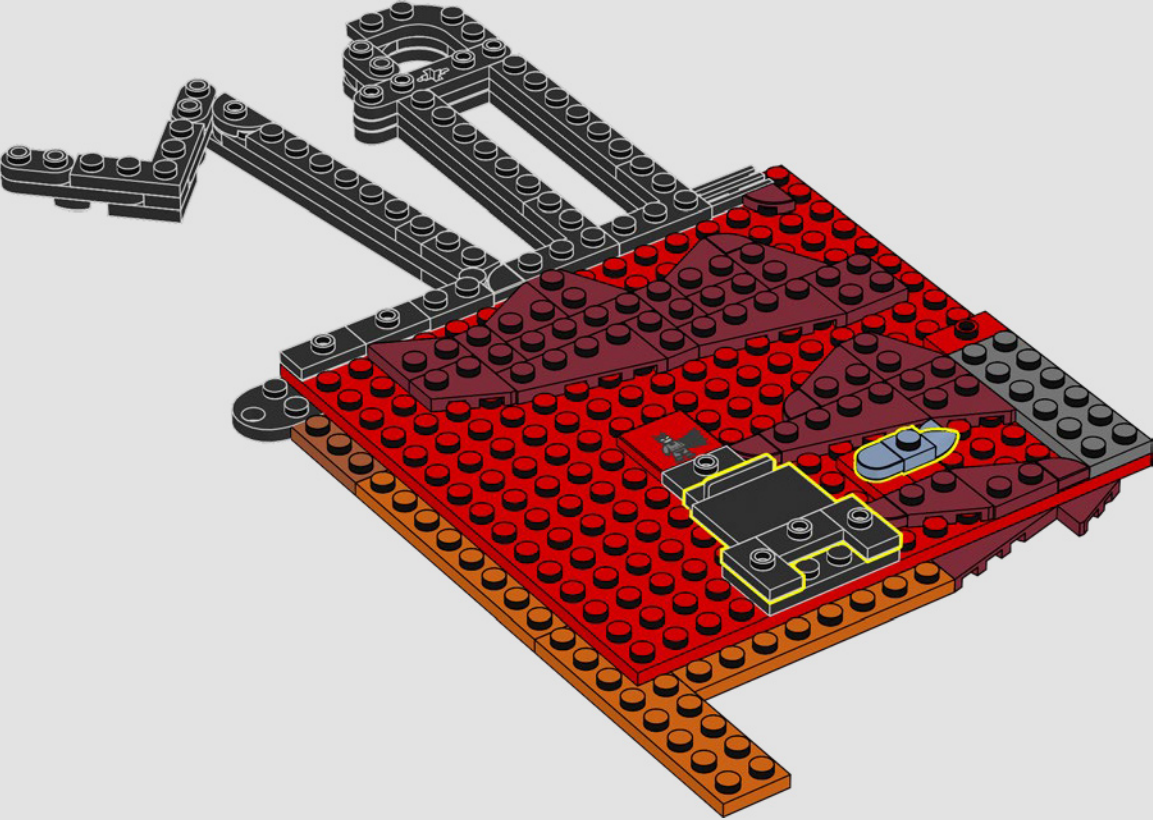

309

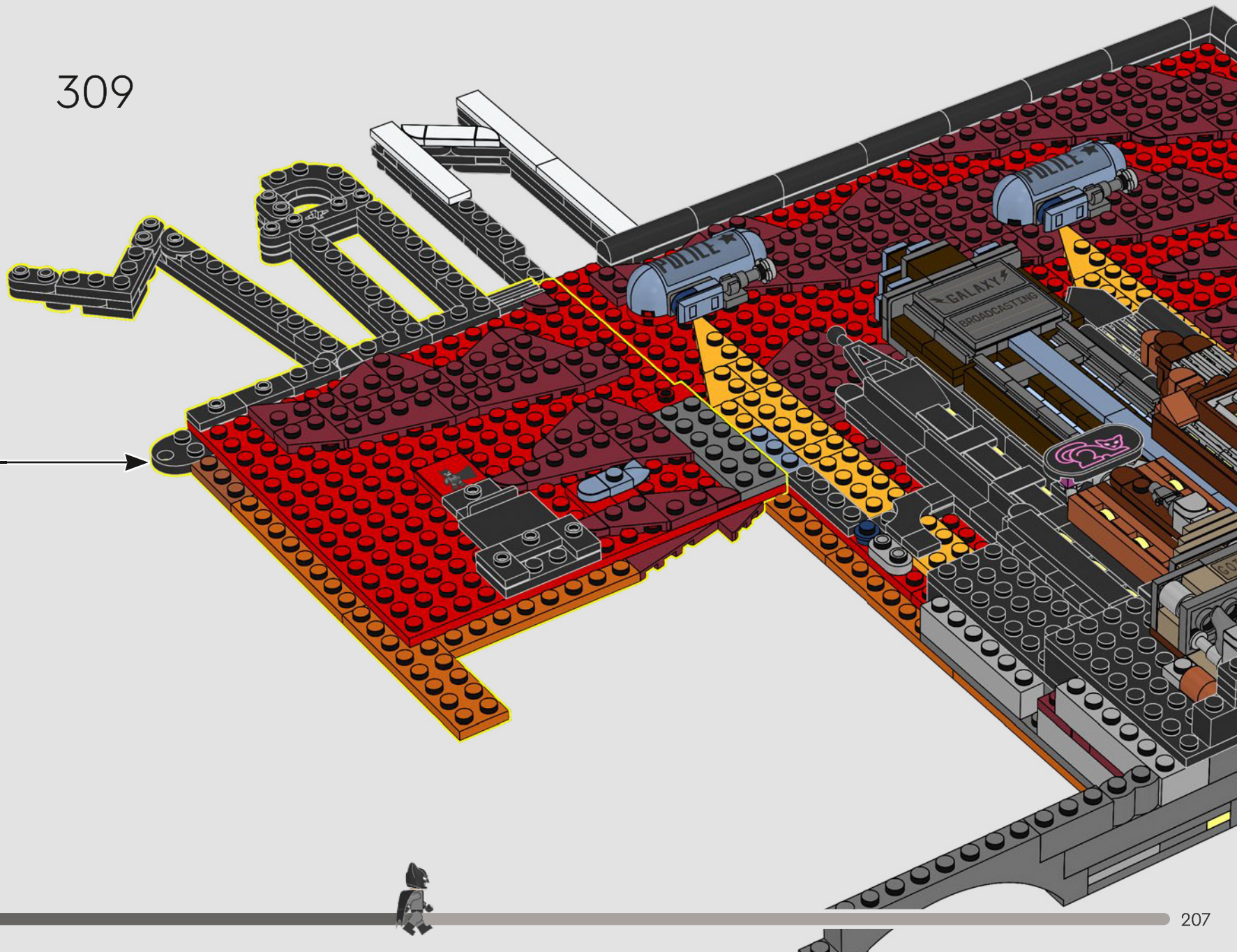



310

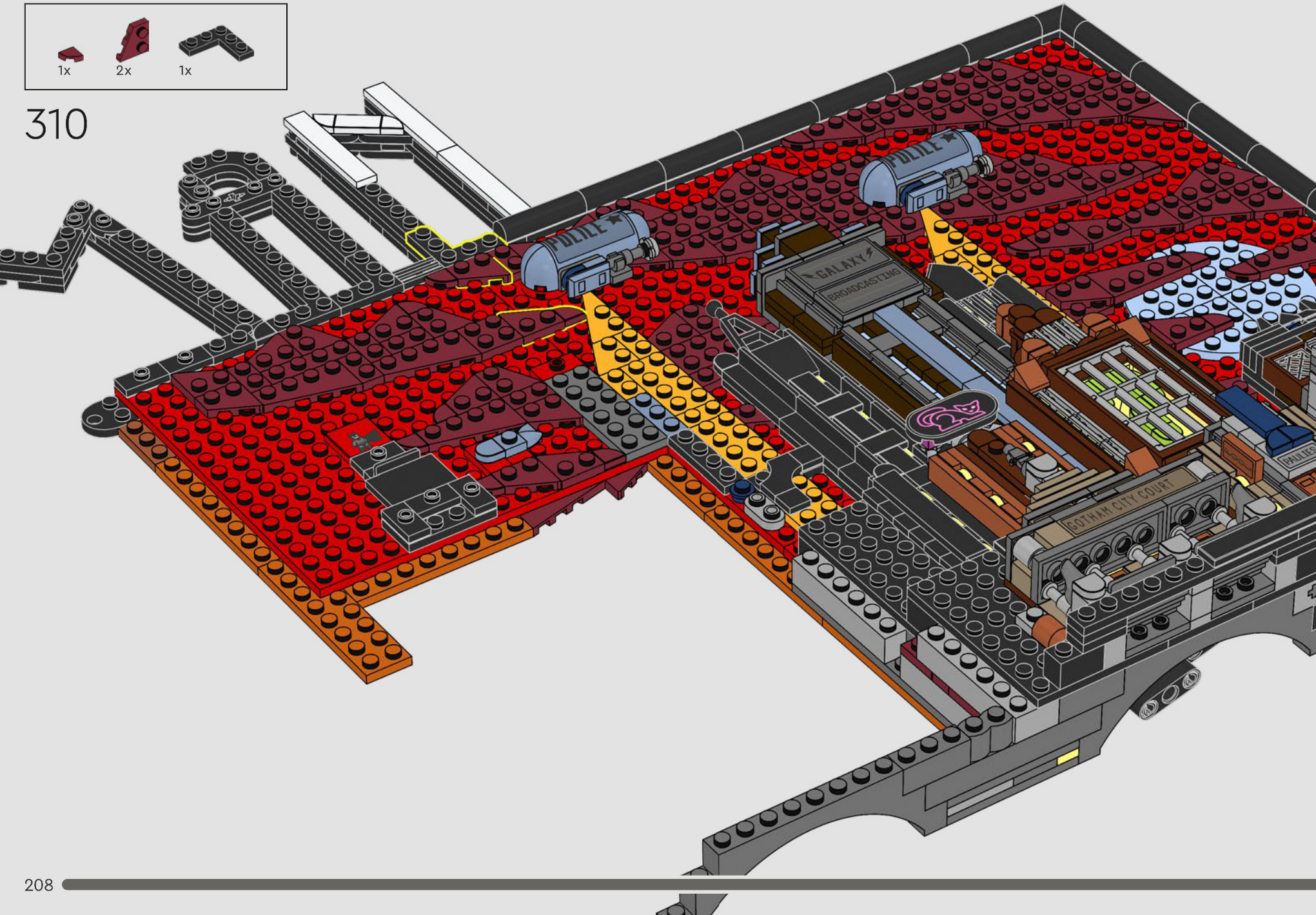

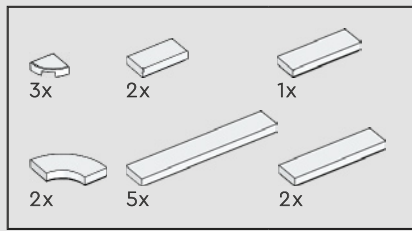

311

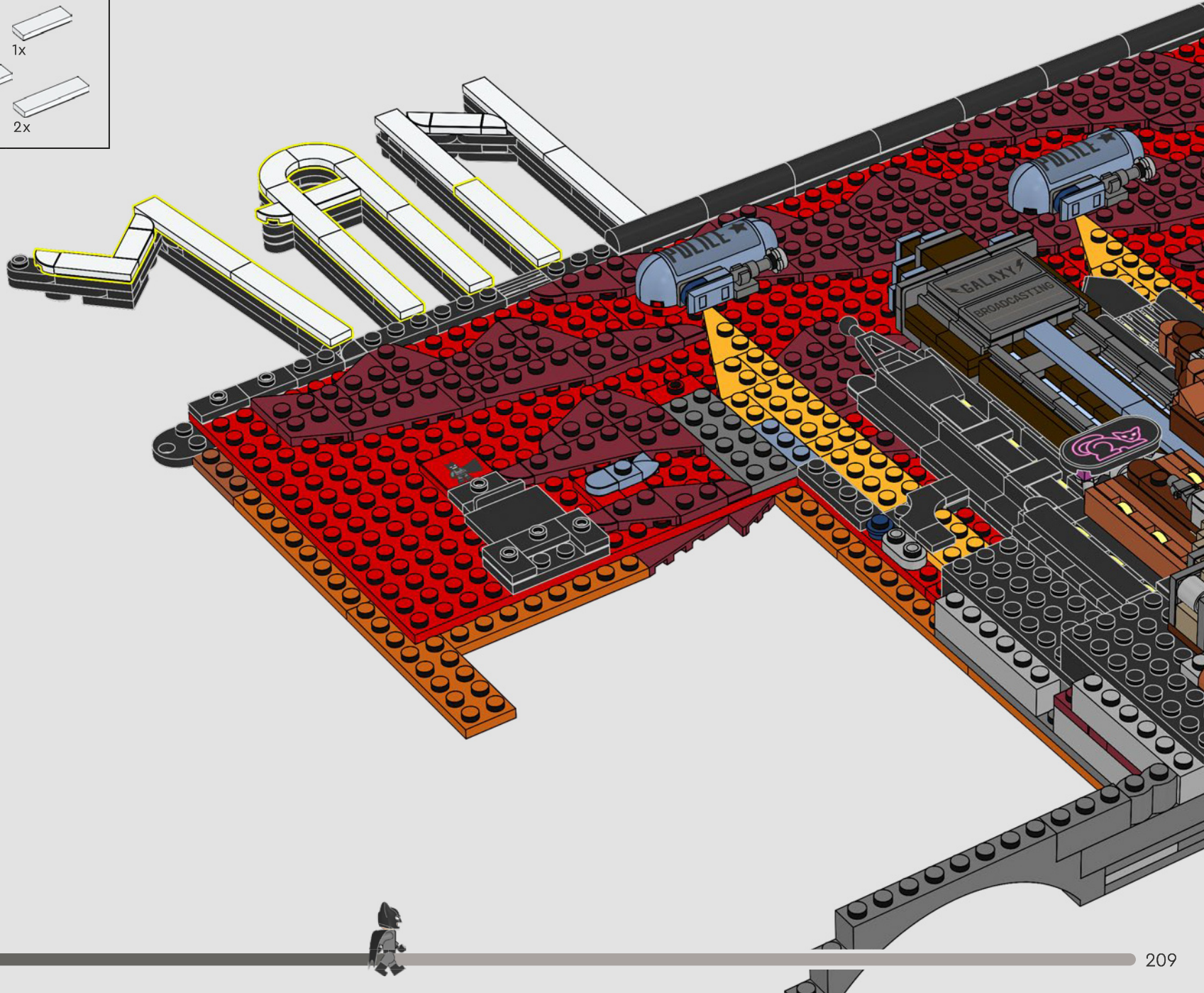

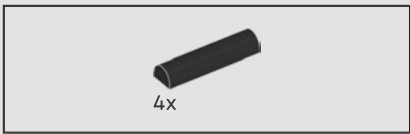

312

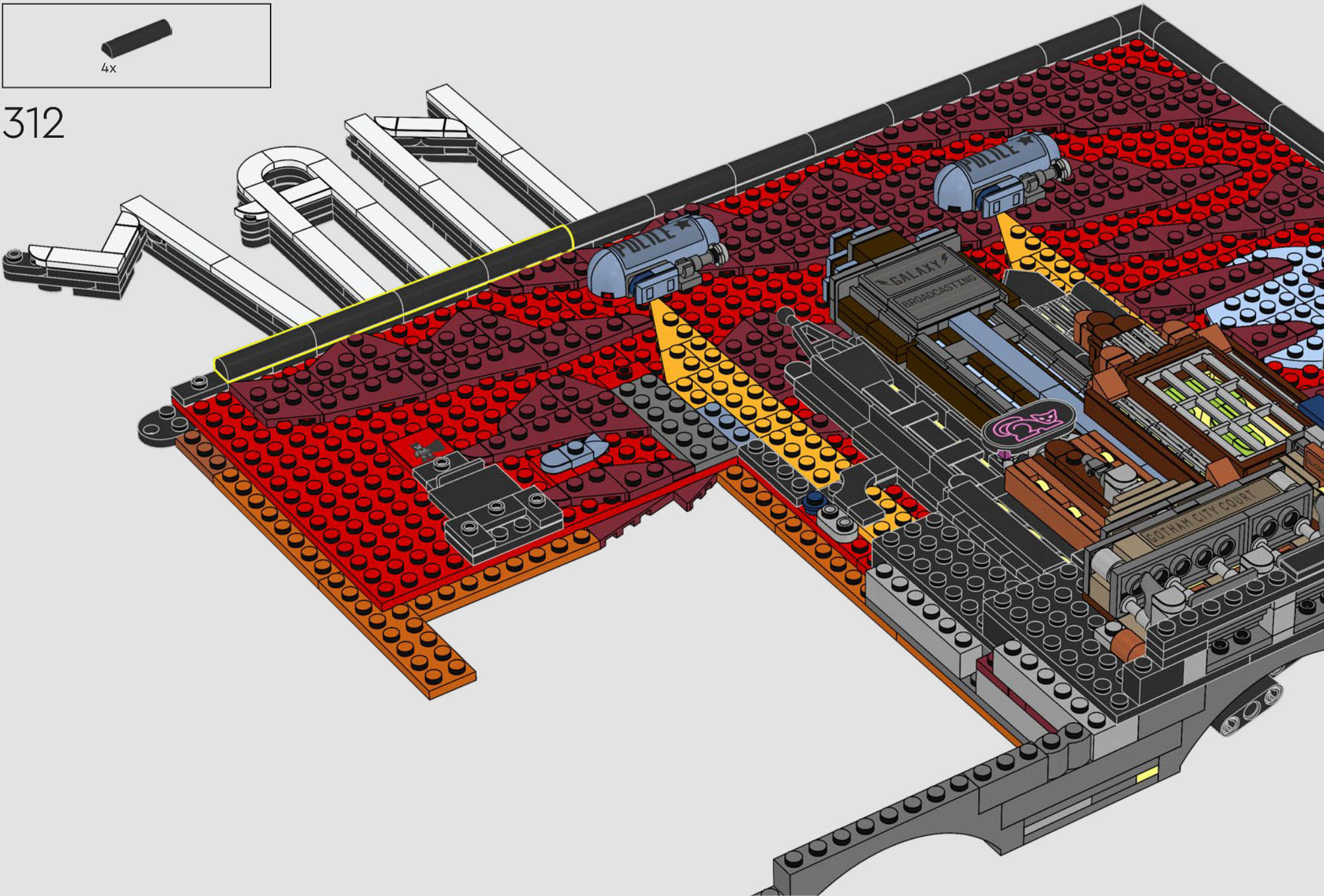

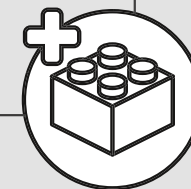
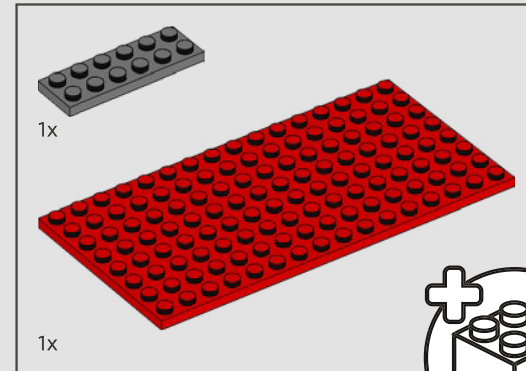
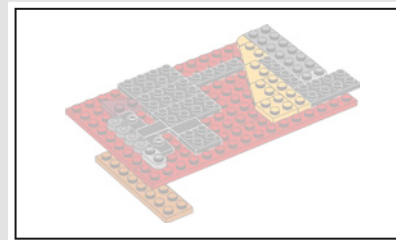
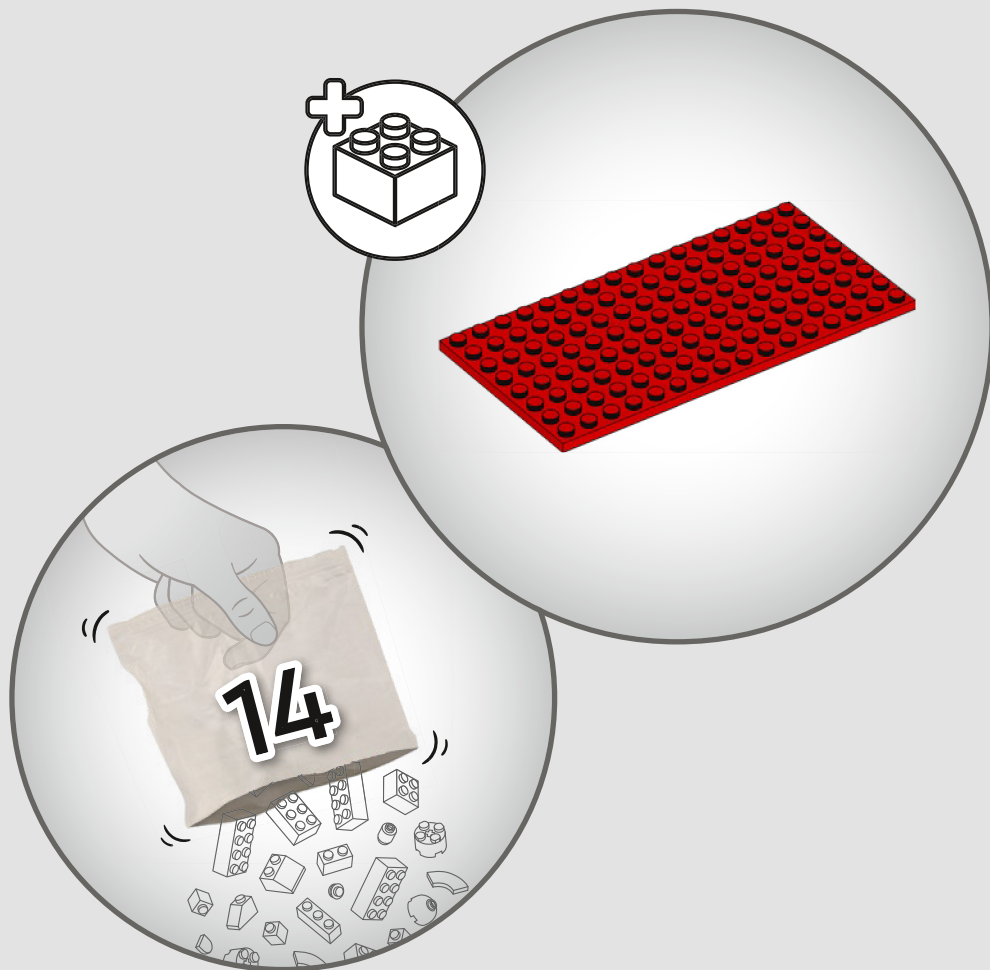

313

Episode: *Fear of Victory*
 Épisode : *Le maître de l'épouvante*
 Episodio: *Miedo a la victoria*

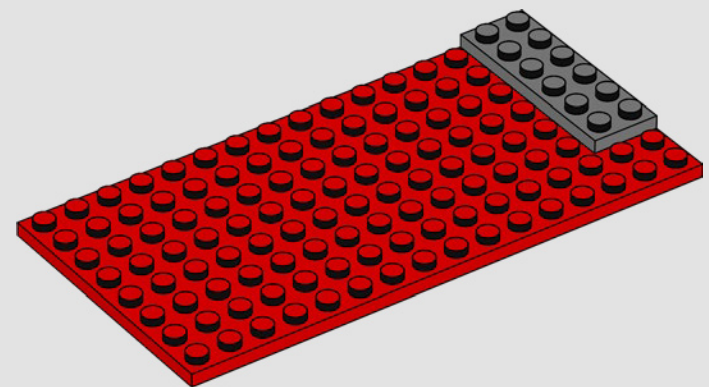

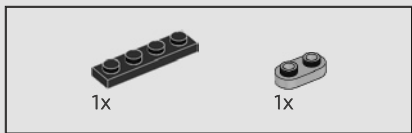

314

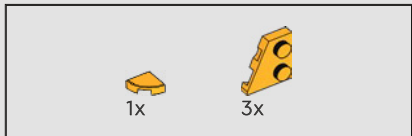
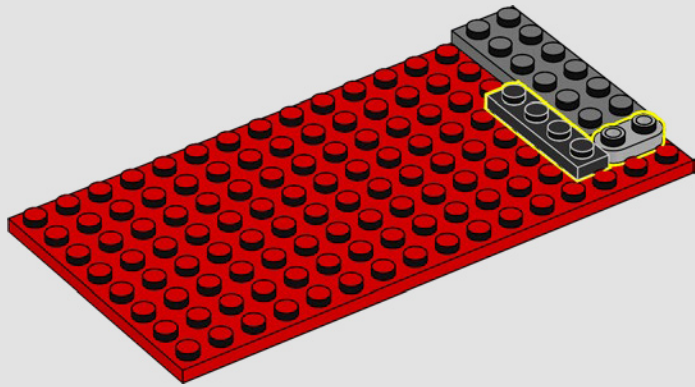

315

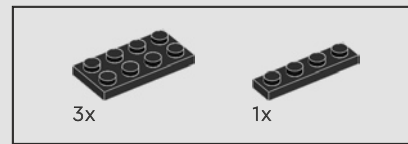
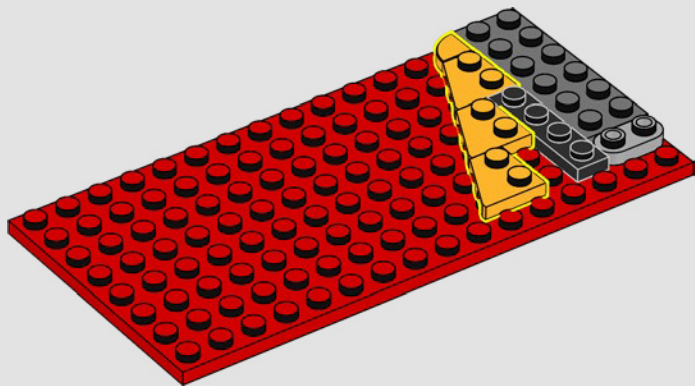

316

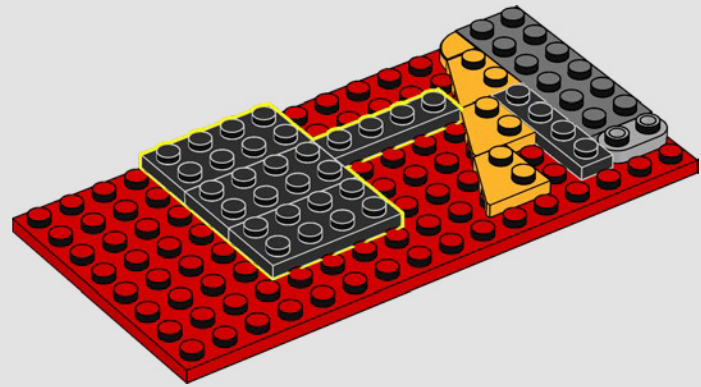

317

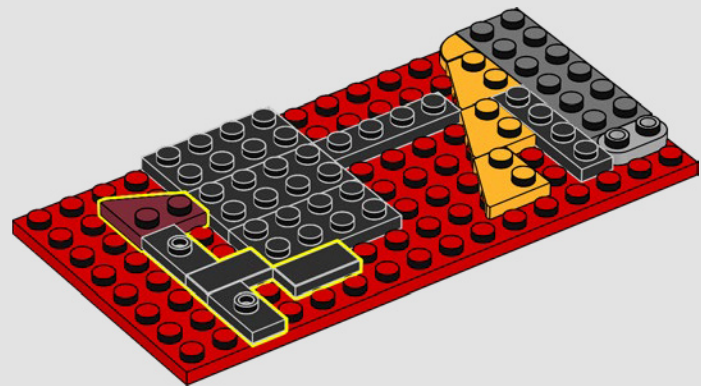

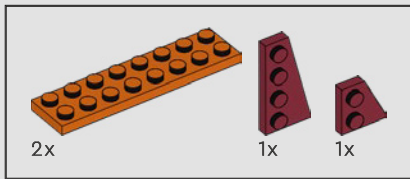

318

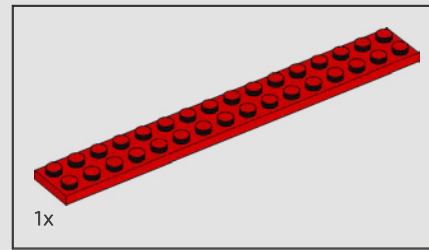
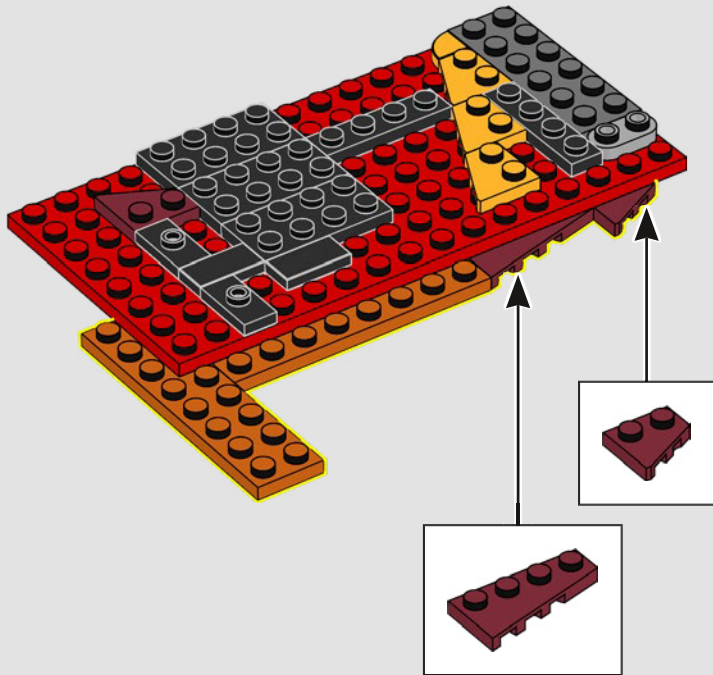

319

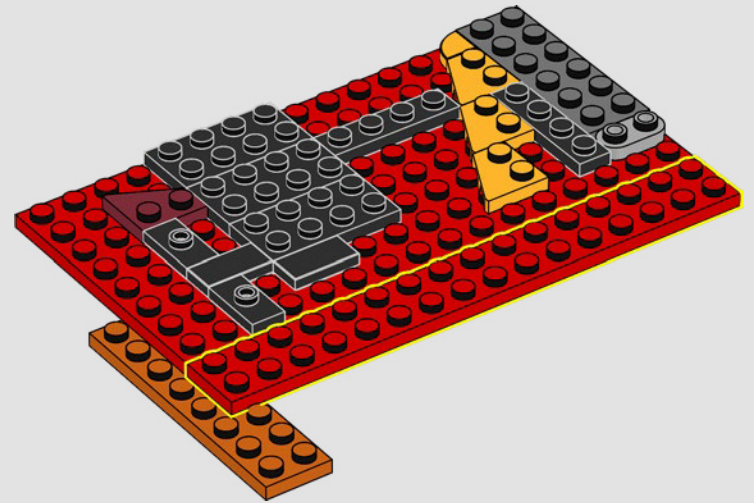

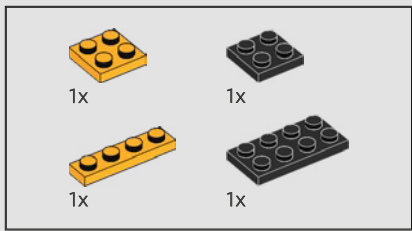

320

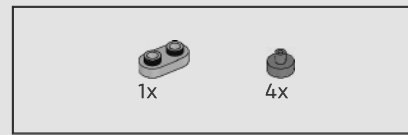
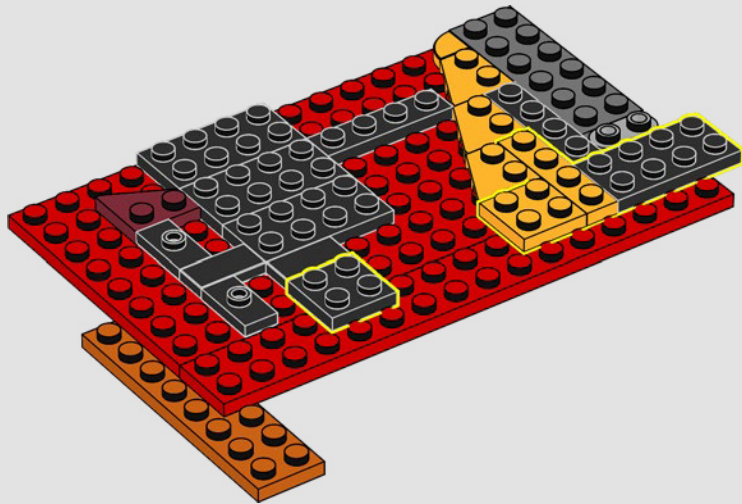

321

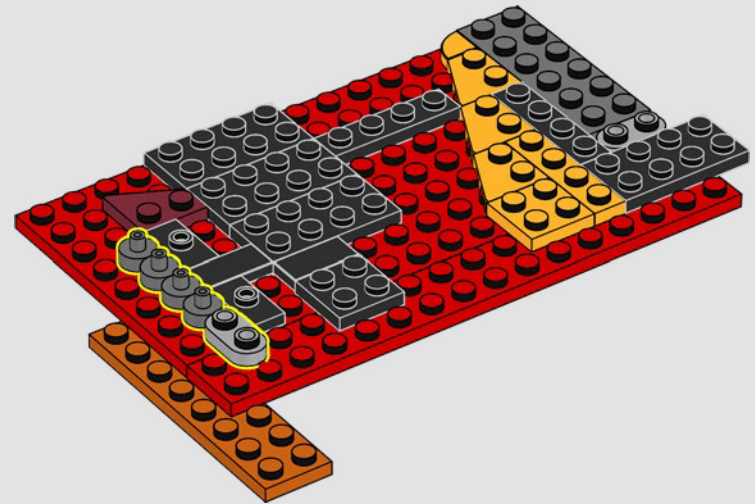



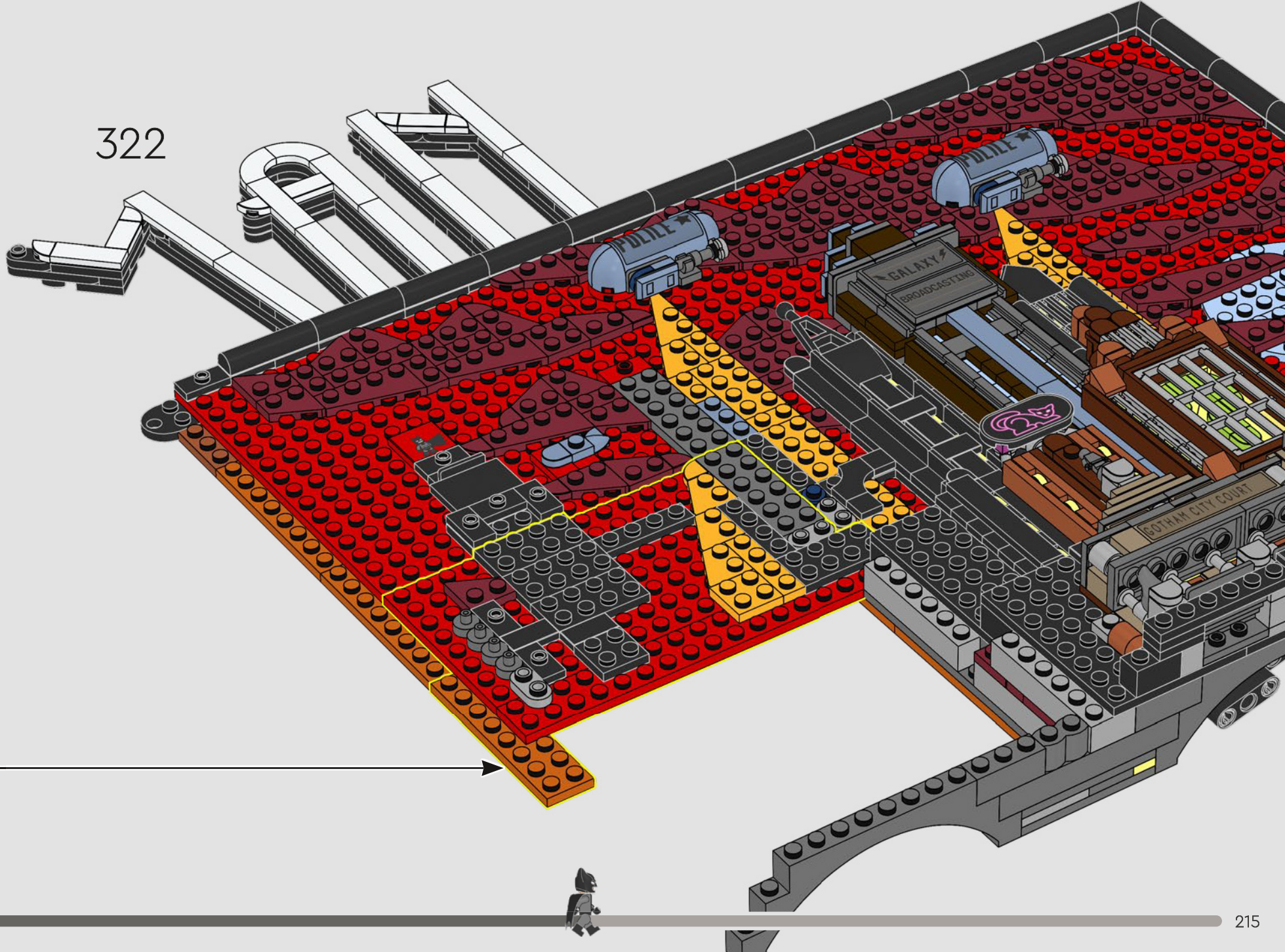

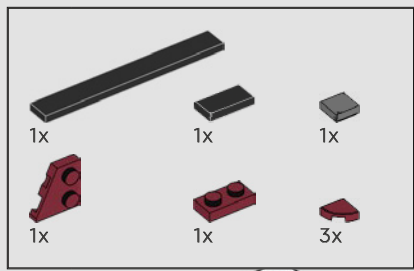
322



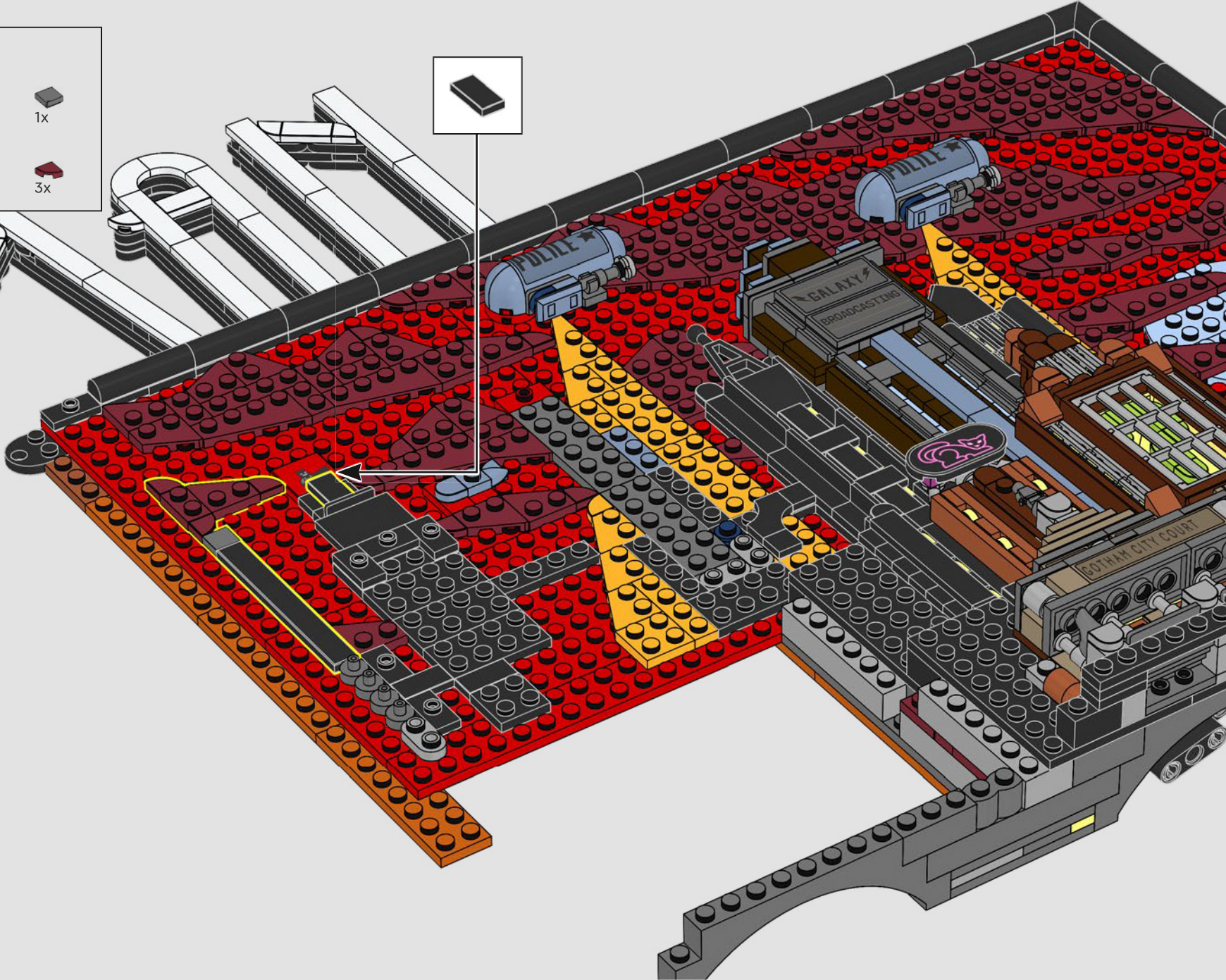

323



-  1x
-  2x
-  2x
-  1x

324

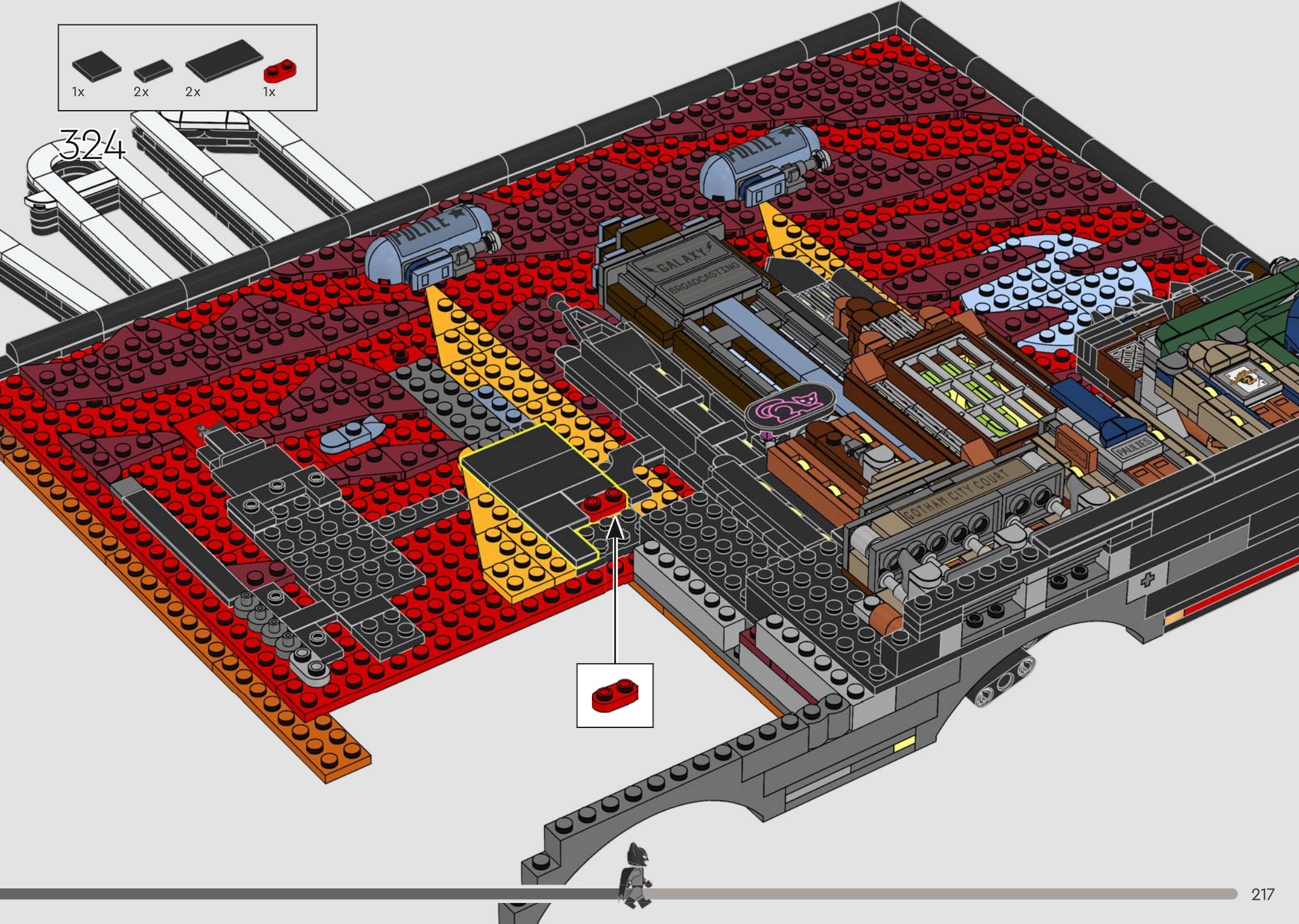



326

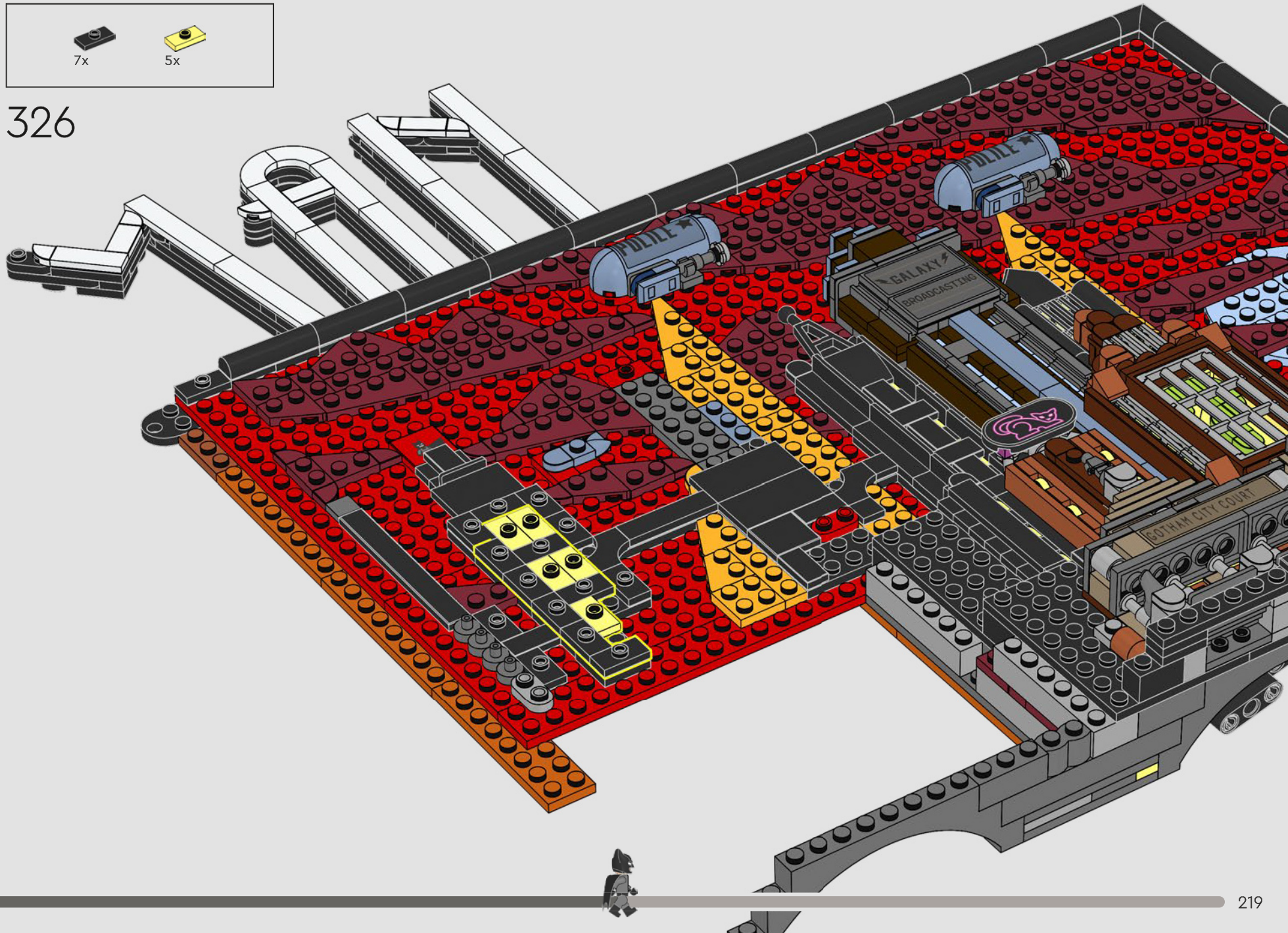

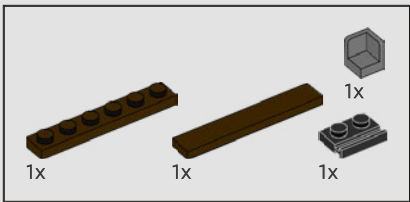

327

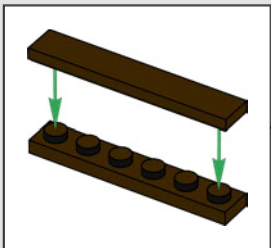
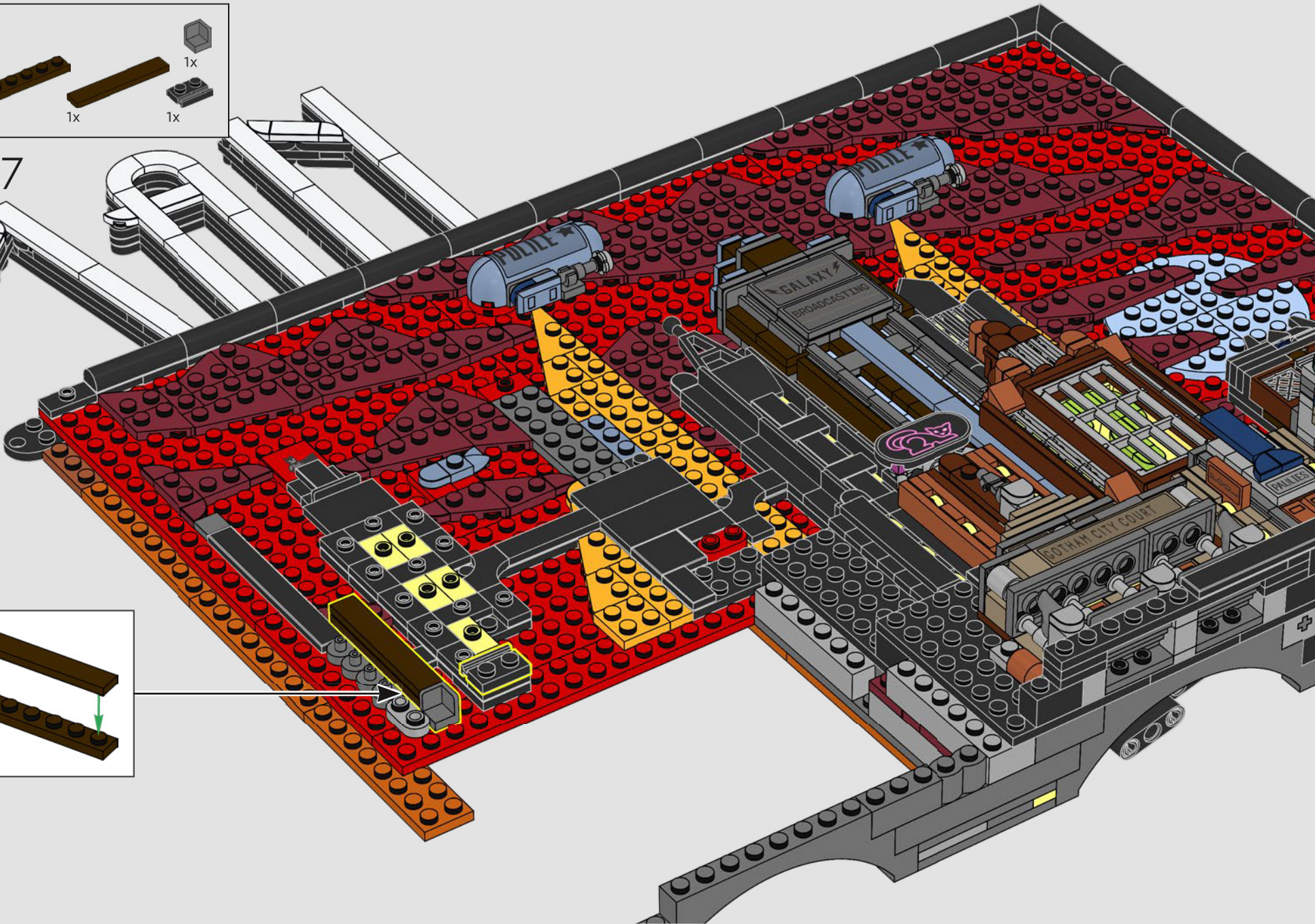

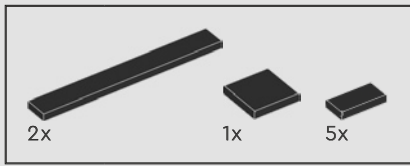

328

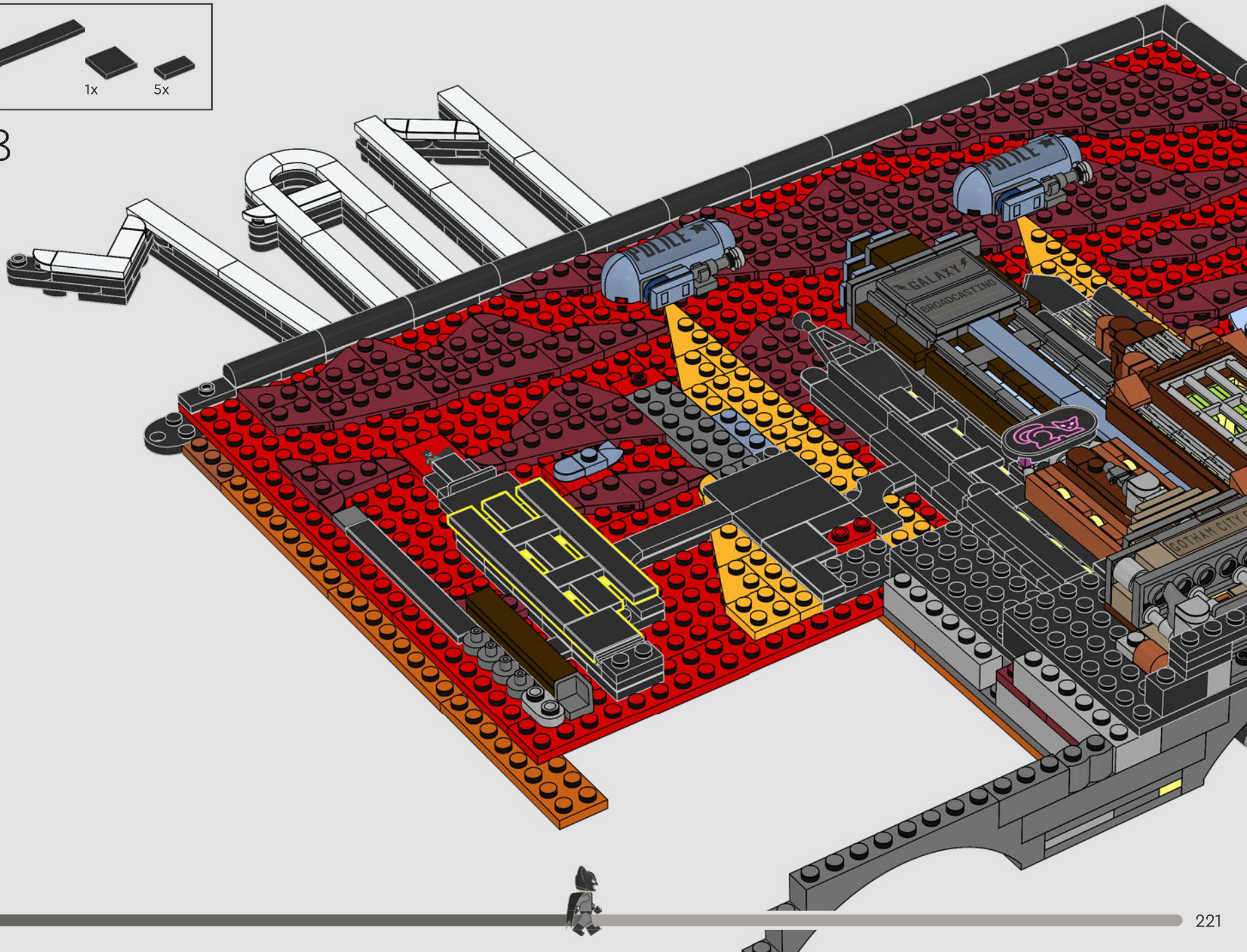

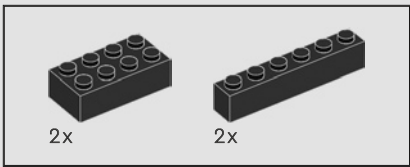

329

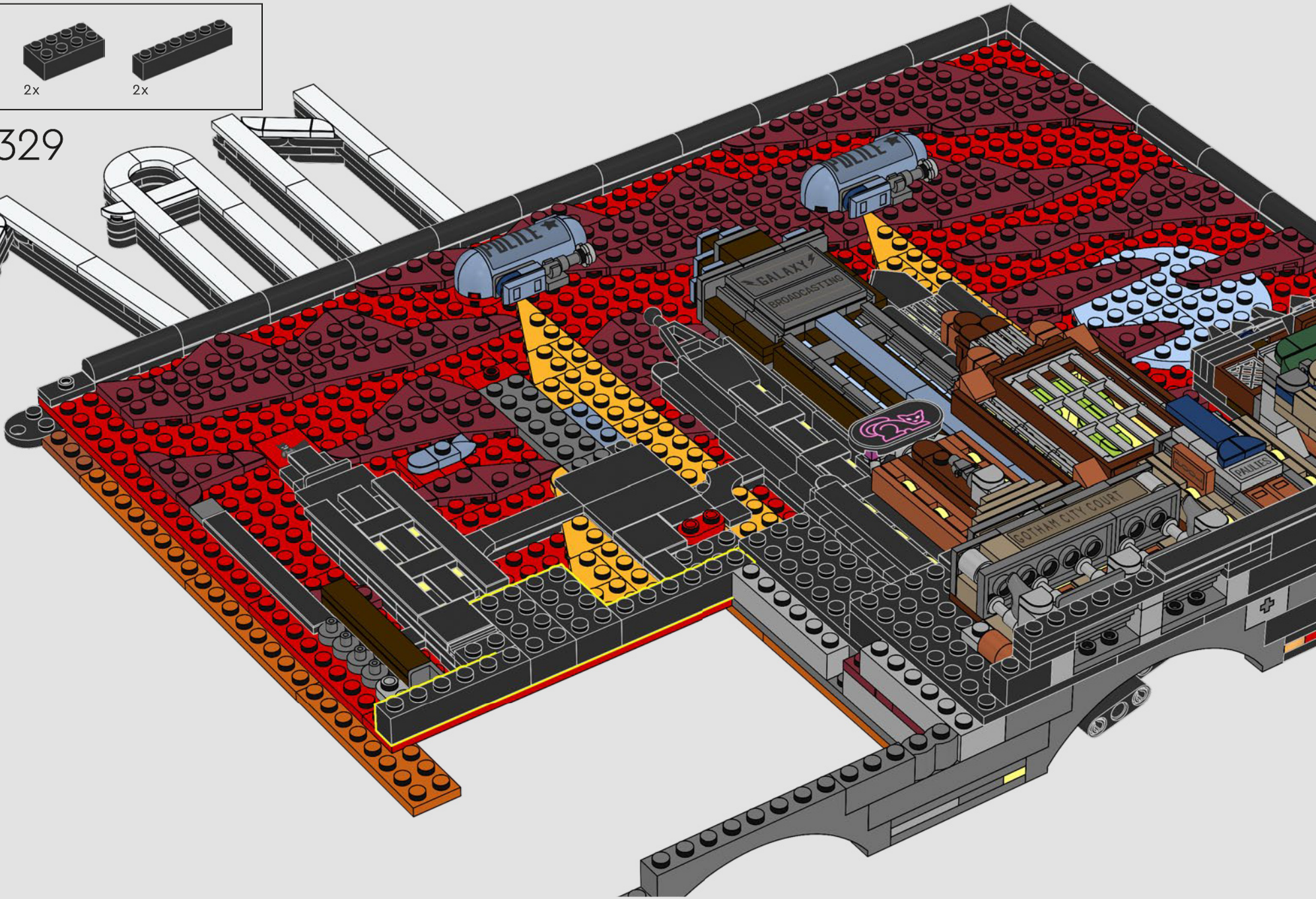

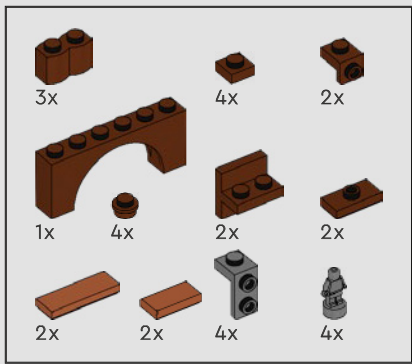

331

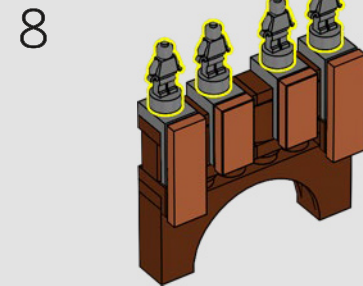
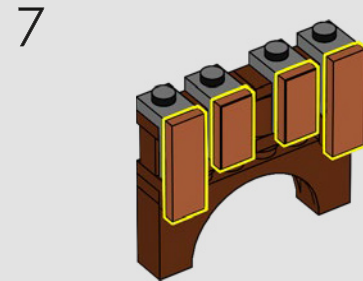
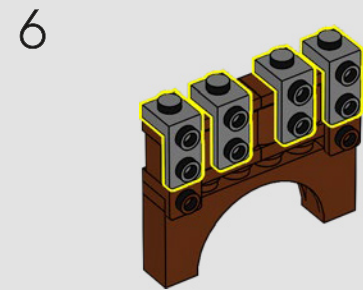
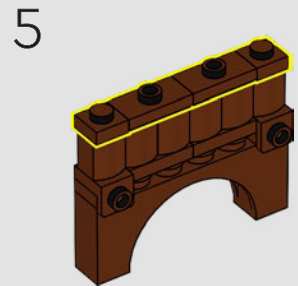
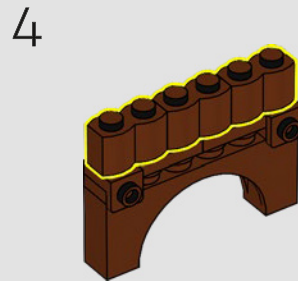
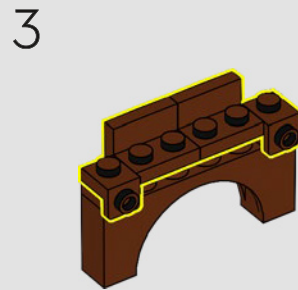
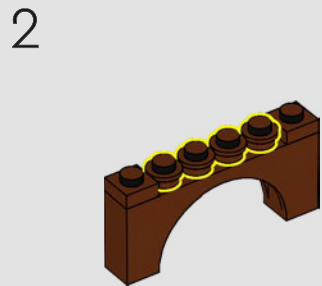
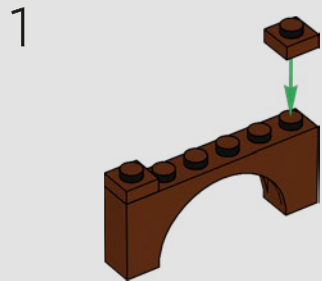

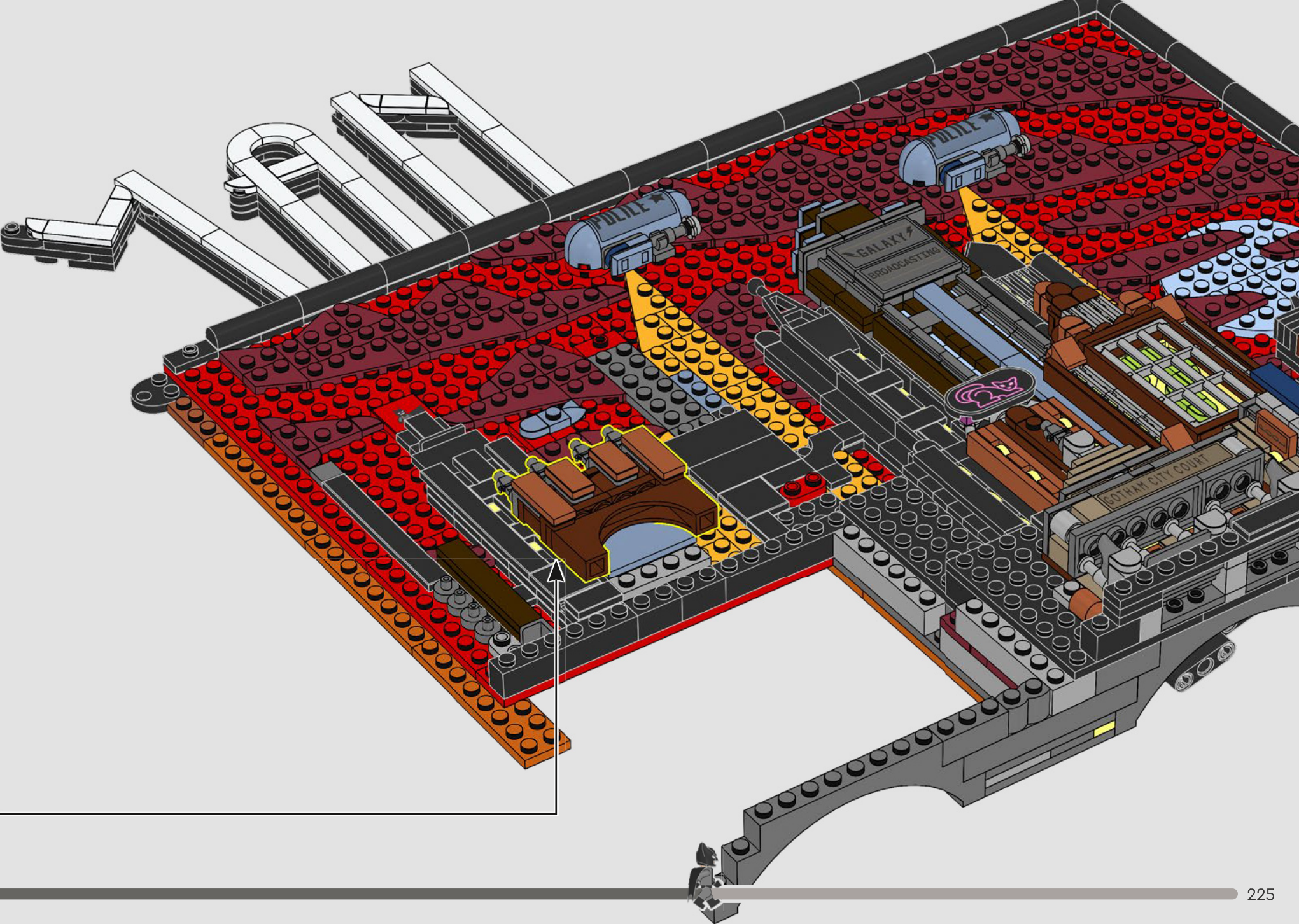

Episode: *I Am the Night*
Épisode : *Remords*
Episodio: *Yo soy la noche*



332

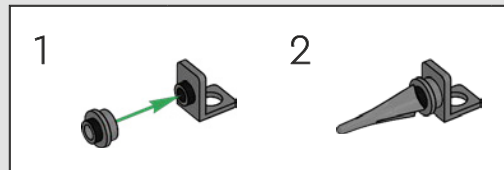

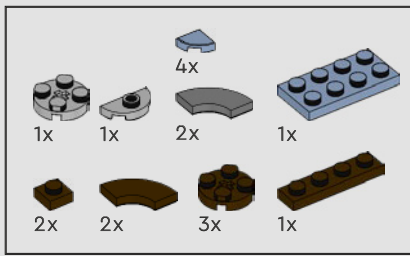

333

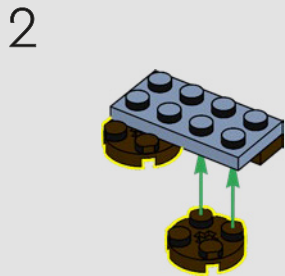
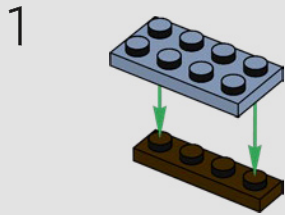

3

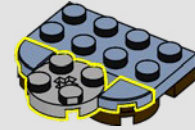

4

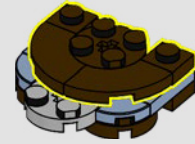

5

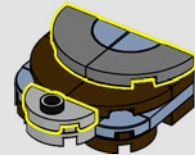

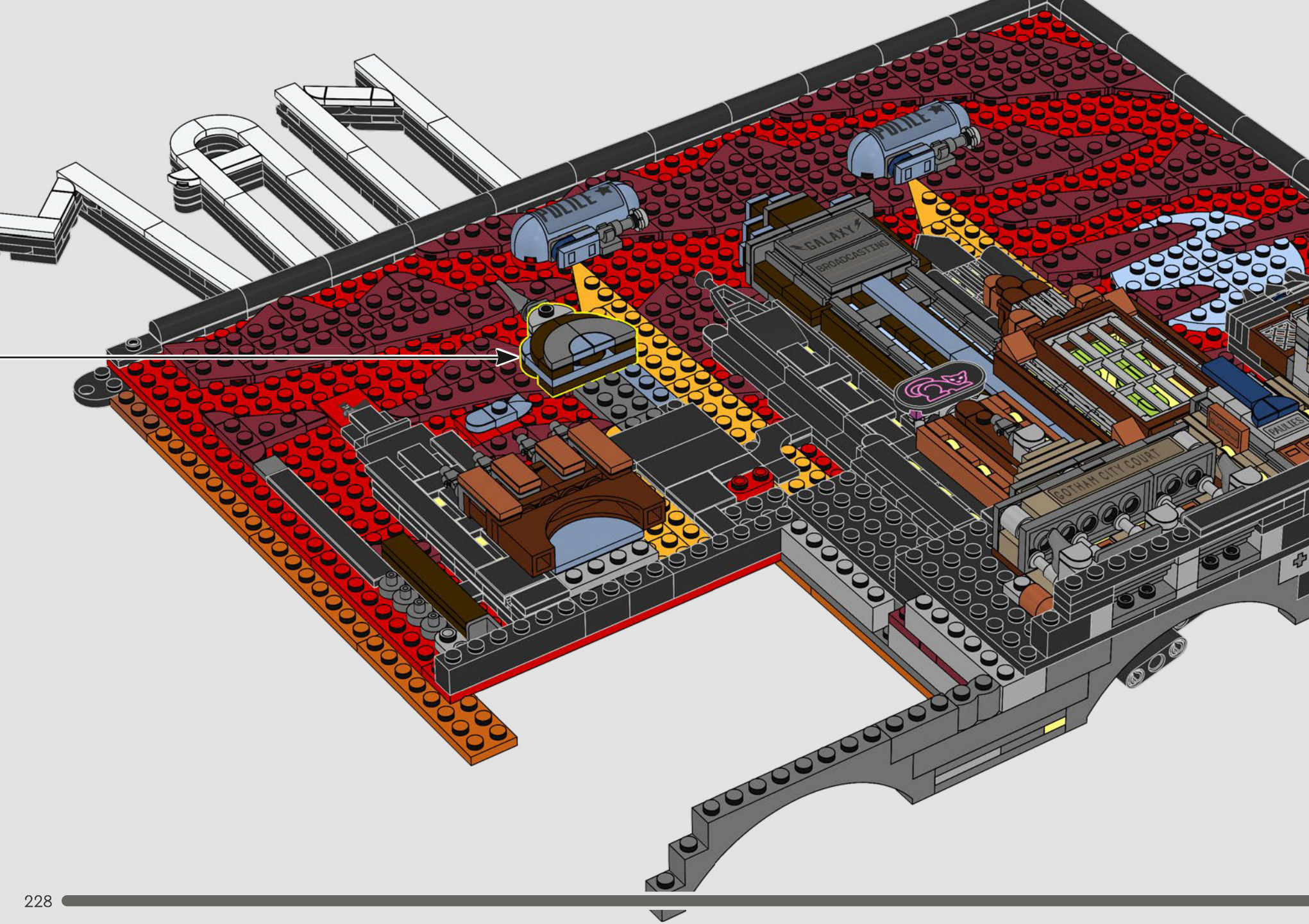

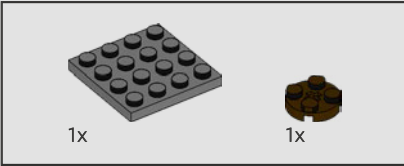
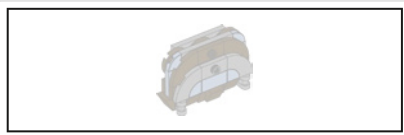

334

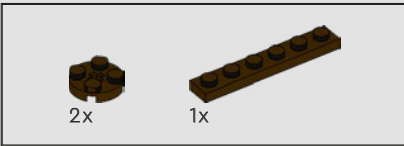
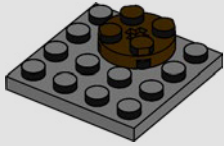

335

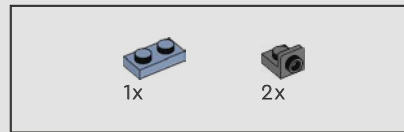
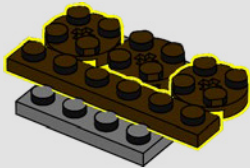

336

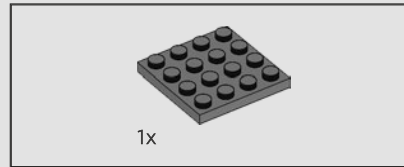
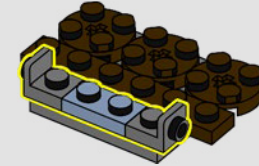

337

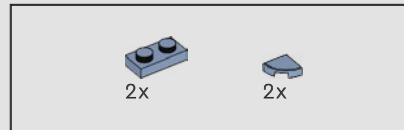
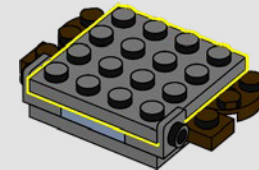

338

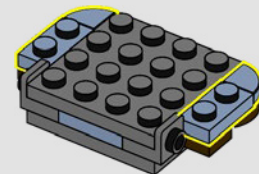

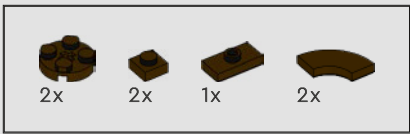

339

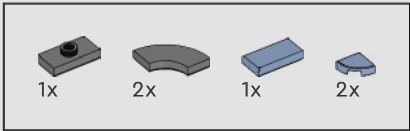
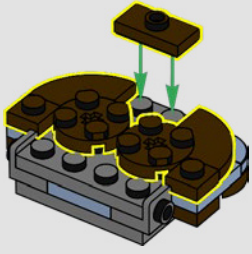

340

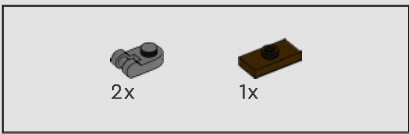
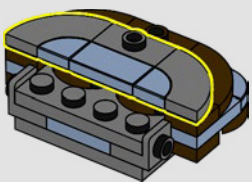

341

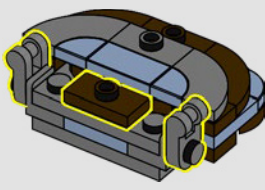



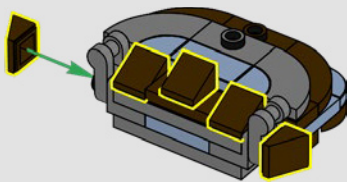

342

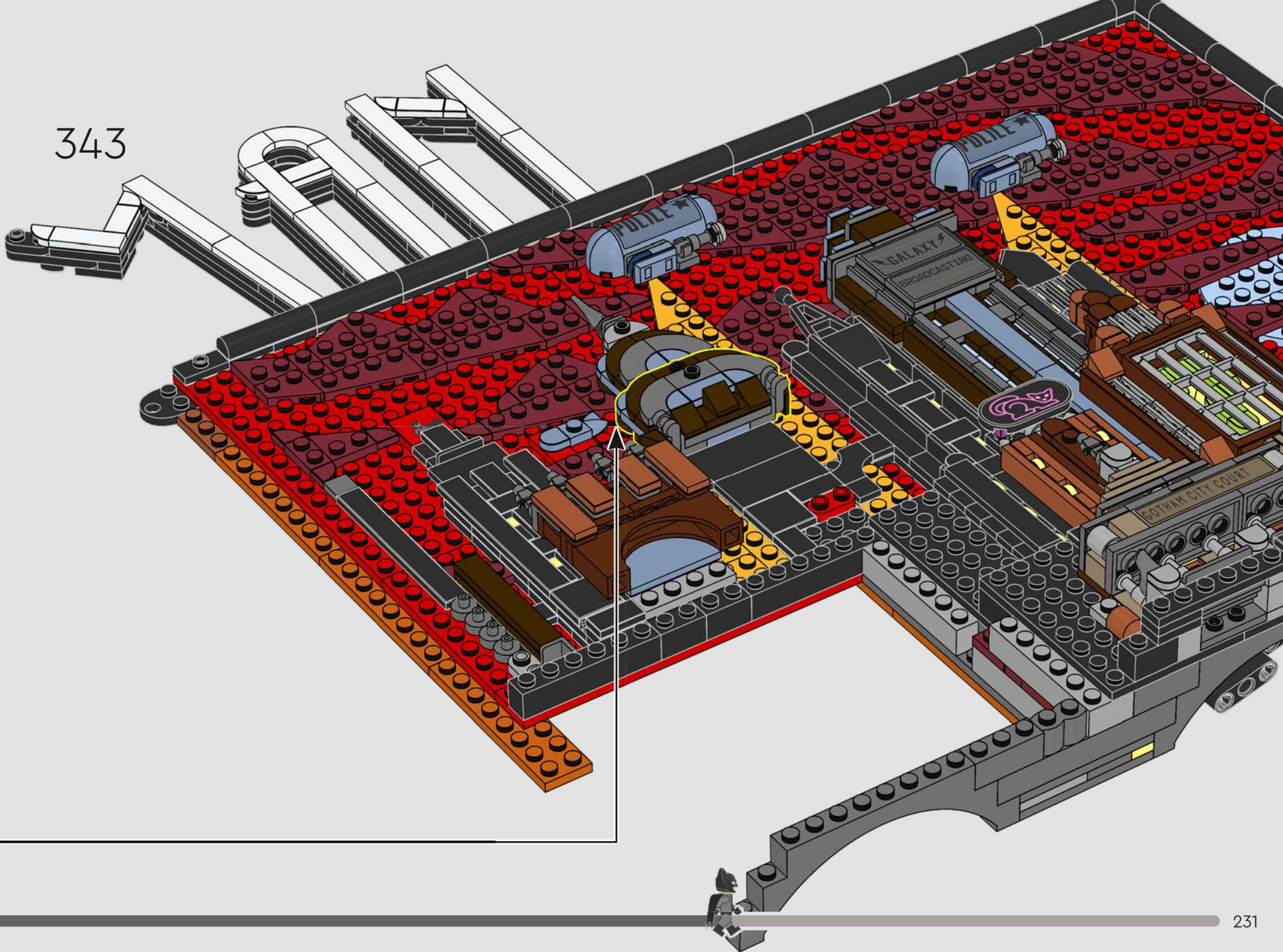

343



- 1x 
- 2x 
- 1x 
- 1x 

344

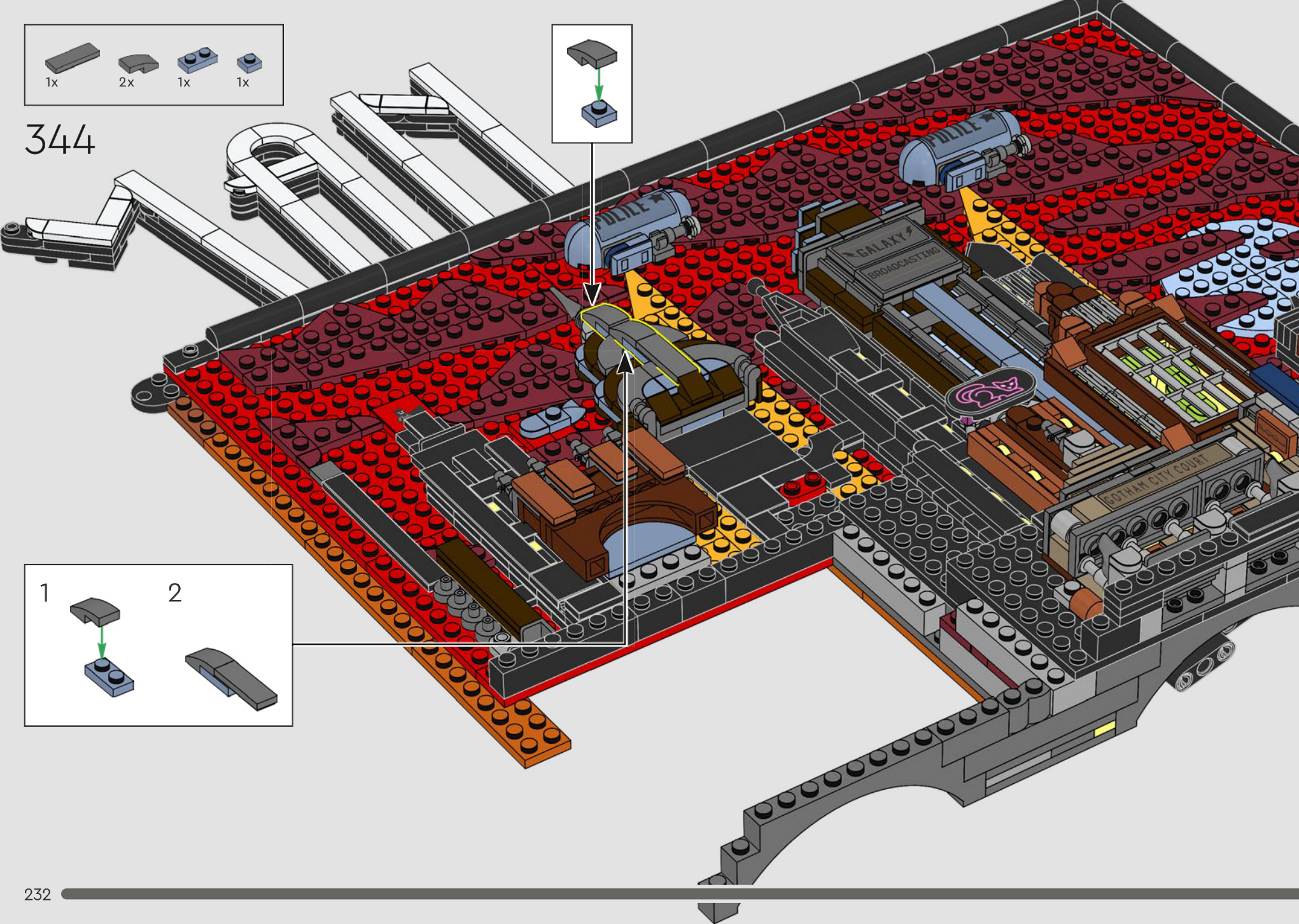
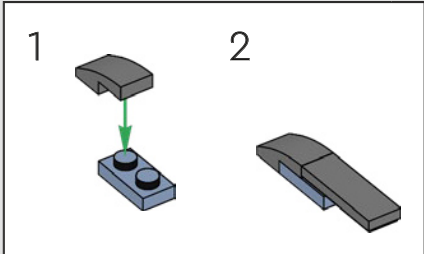
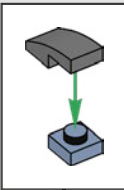



Episode: *Robin's Reckoning: Part I*
Épisode : *Robin se rebiffe*
(1^{re} partie)
Episodio: *La venganza*
de Robin: *Parte 1*

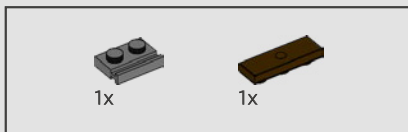
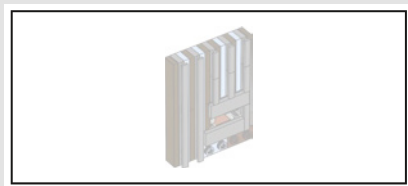

345

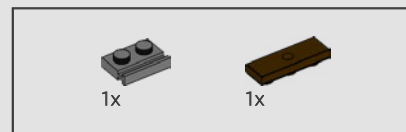
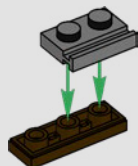

346

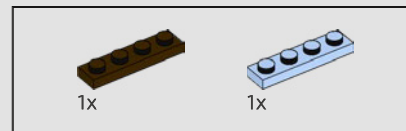
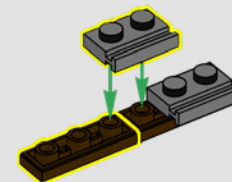

347

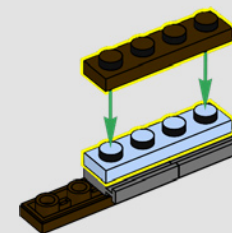

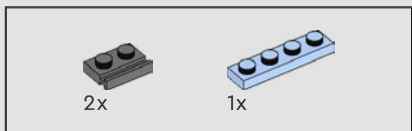

348

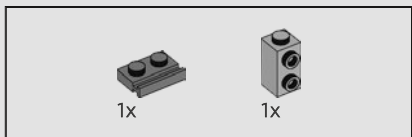
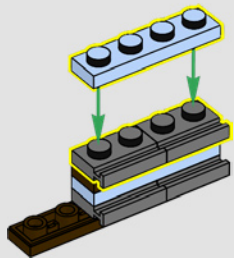

349

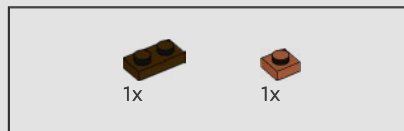
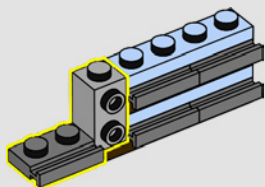

350

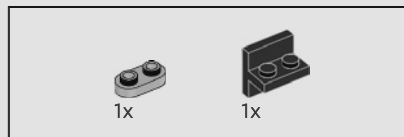
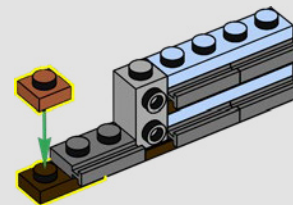

351

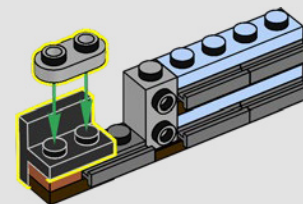

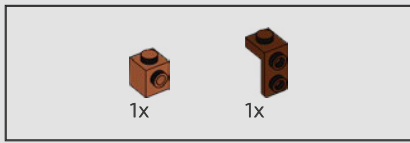

352

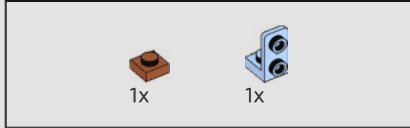
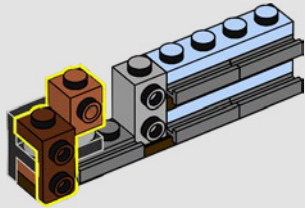

353

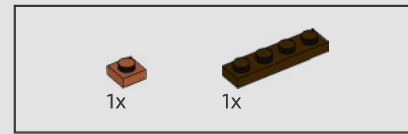
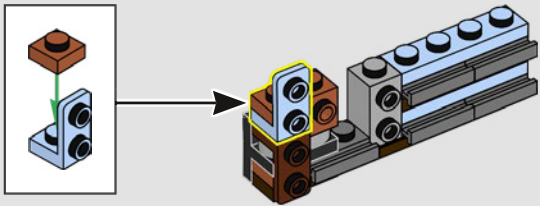

354

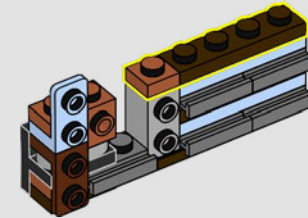

355

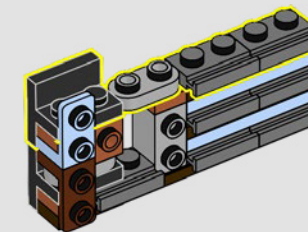



356

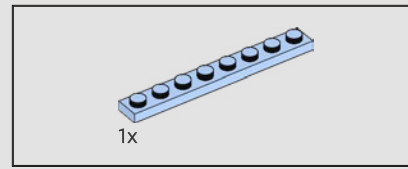
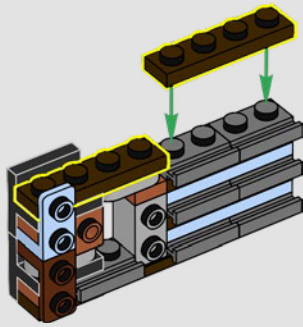

357

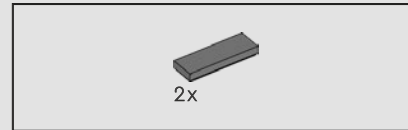
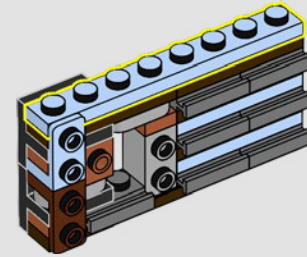

358

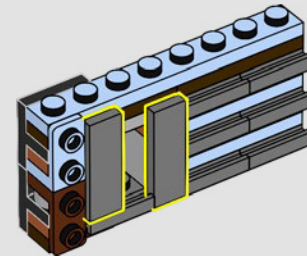

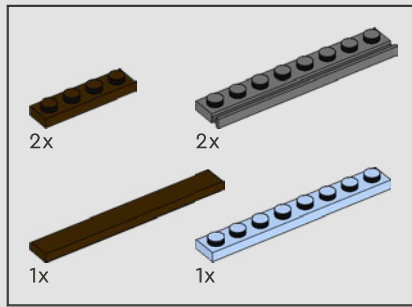

359

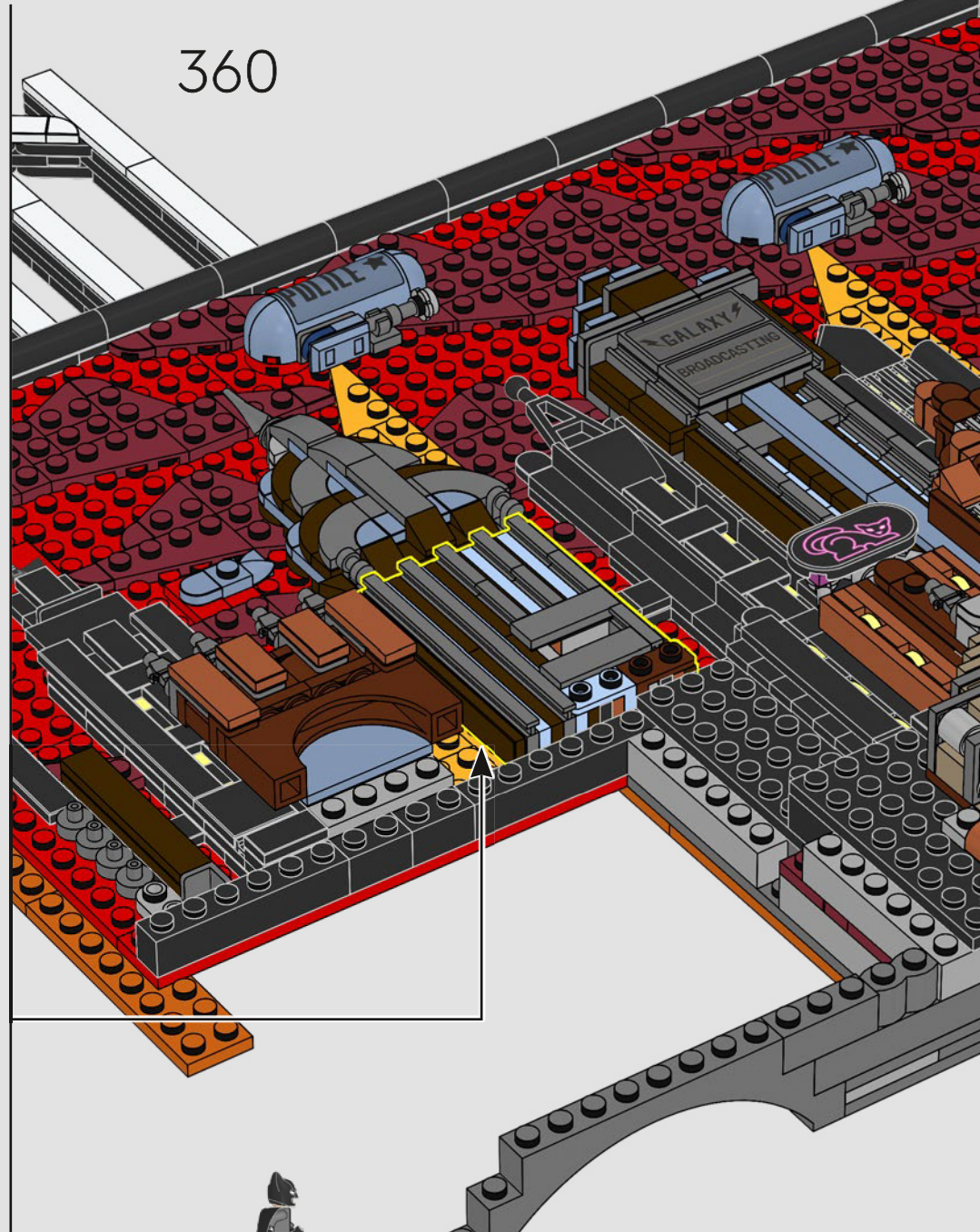
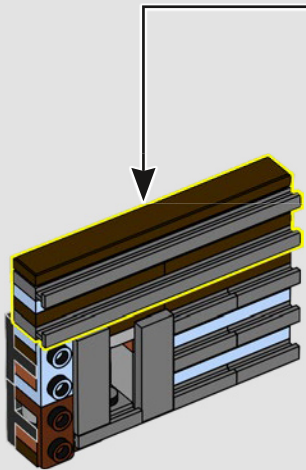
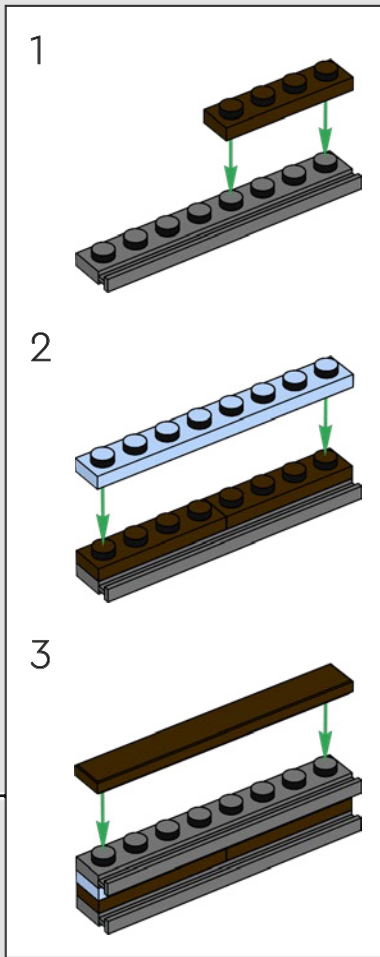

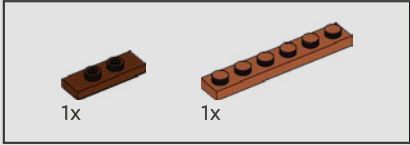

361

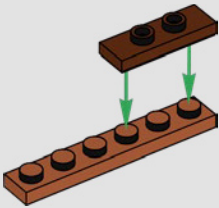

362

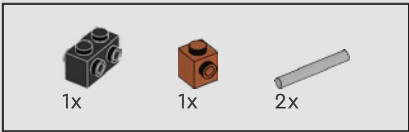
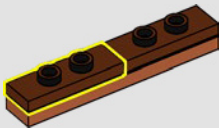

363

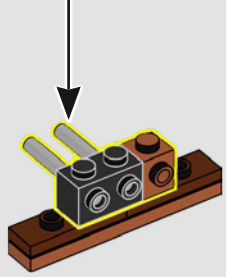
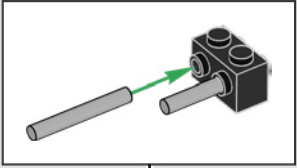

364

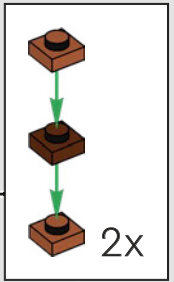
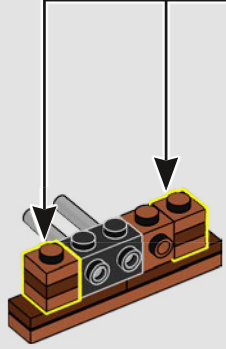

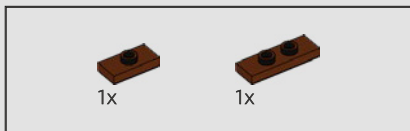

365

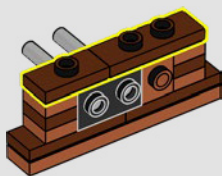

366

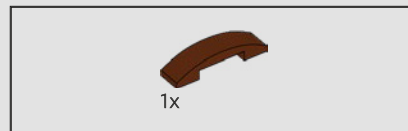
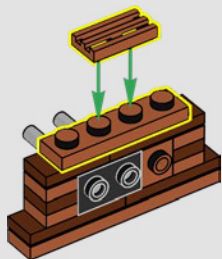

367

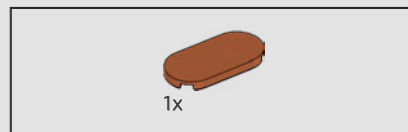
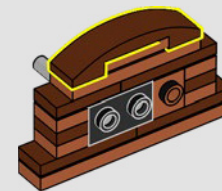

368

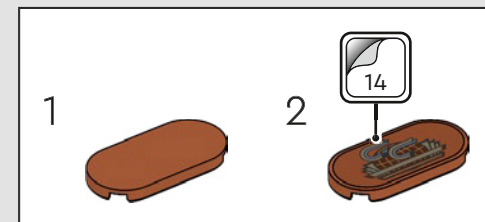

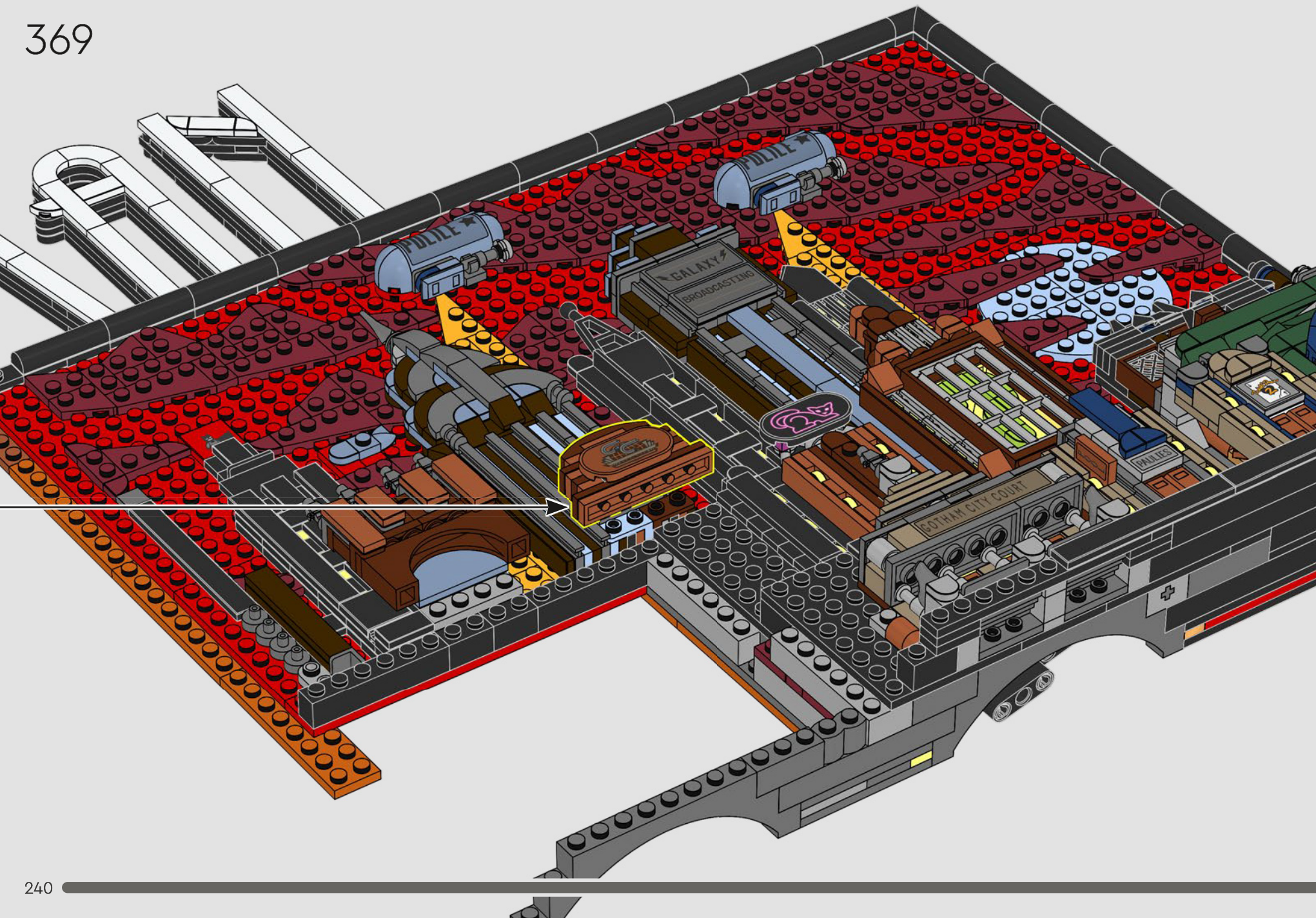

Episode: Heart of Ice
Épisode : Amour on ice
Episodio: Corazón de hielo

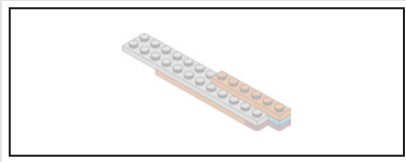

370

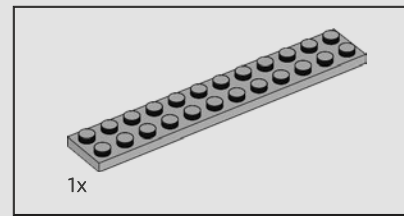
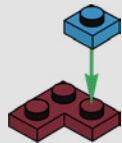

371

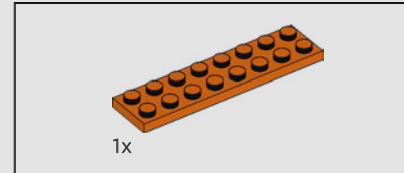
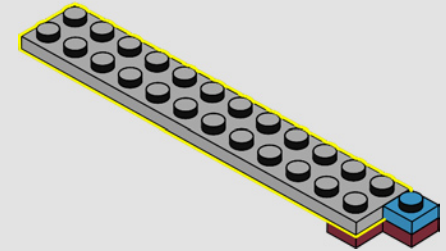

372

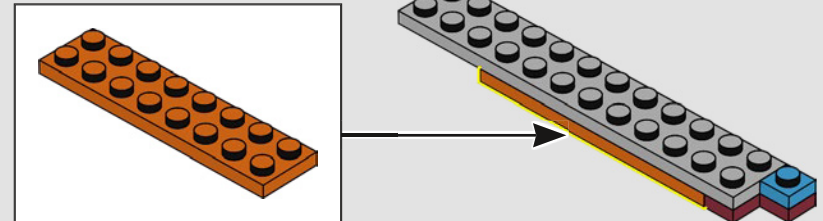

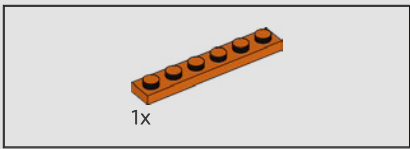

373

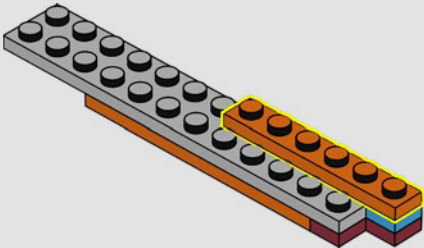

374

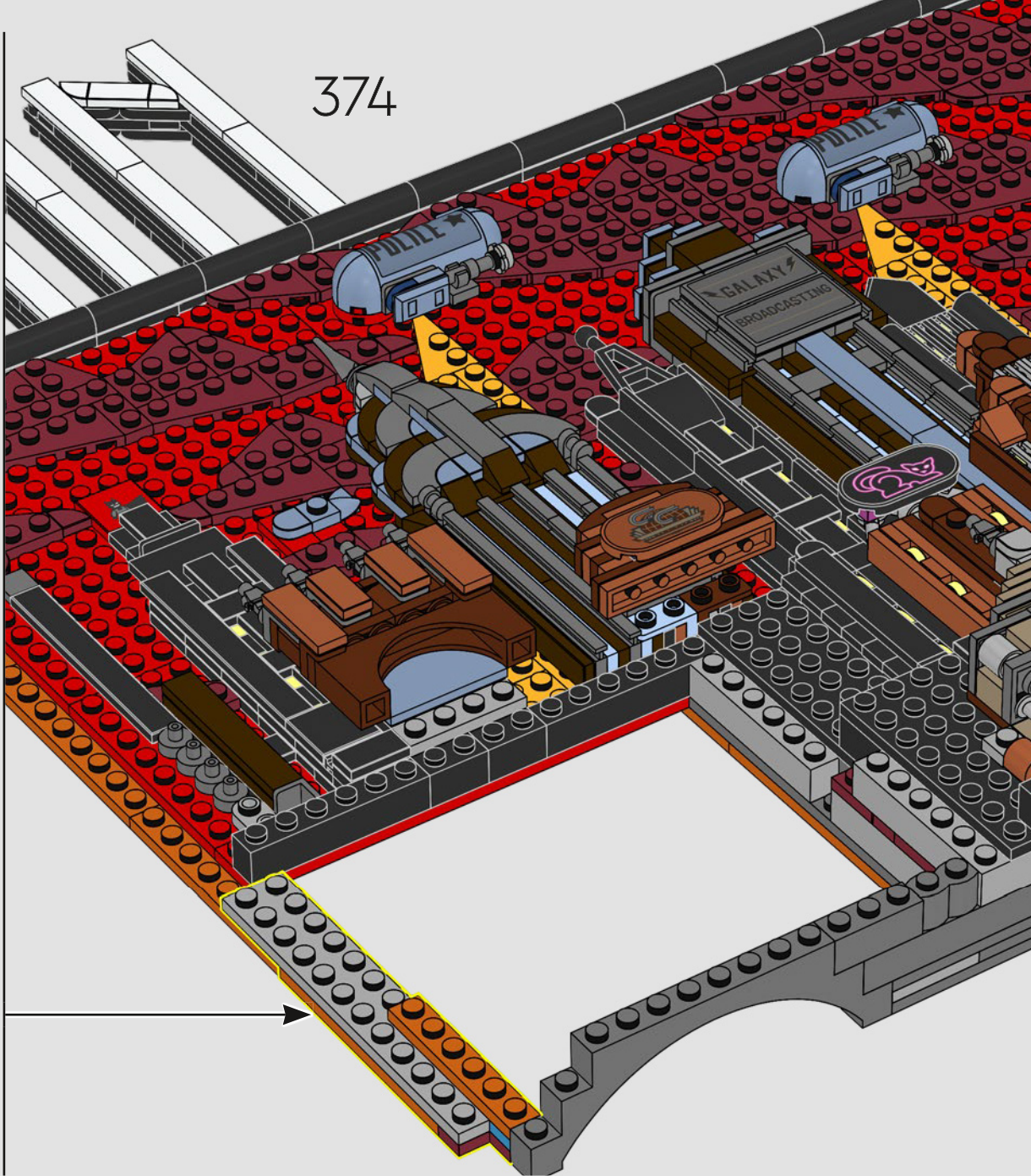

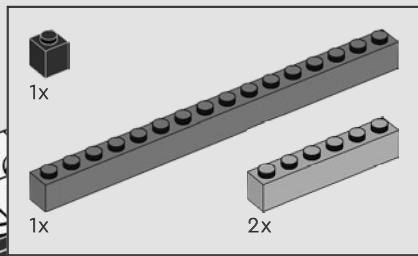

375

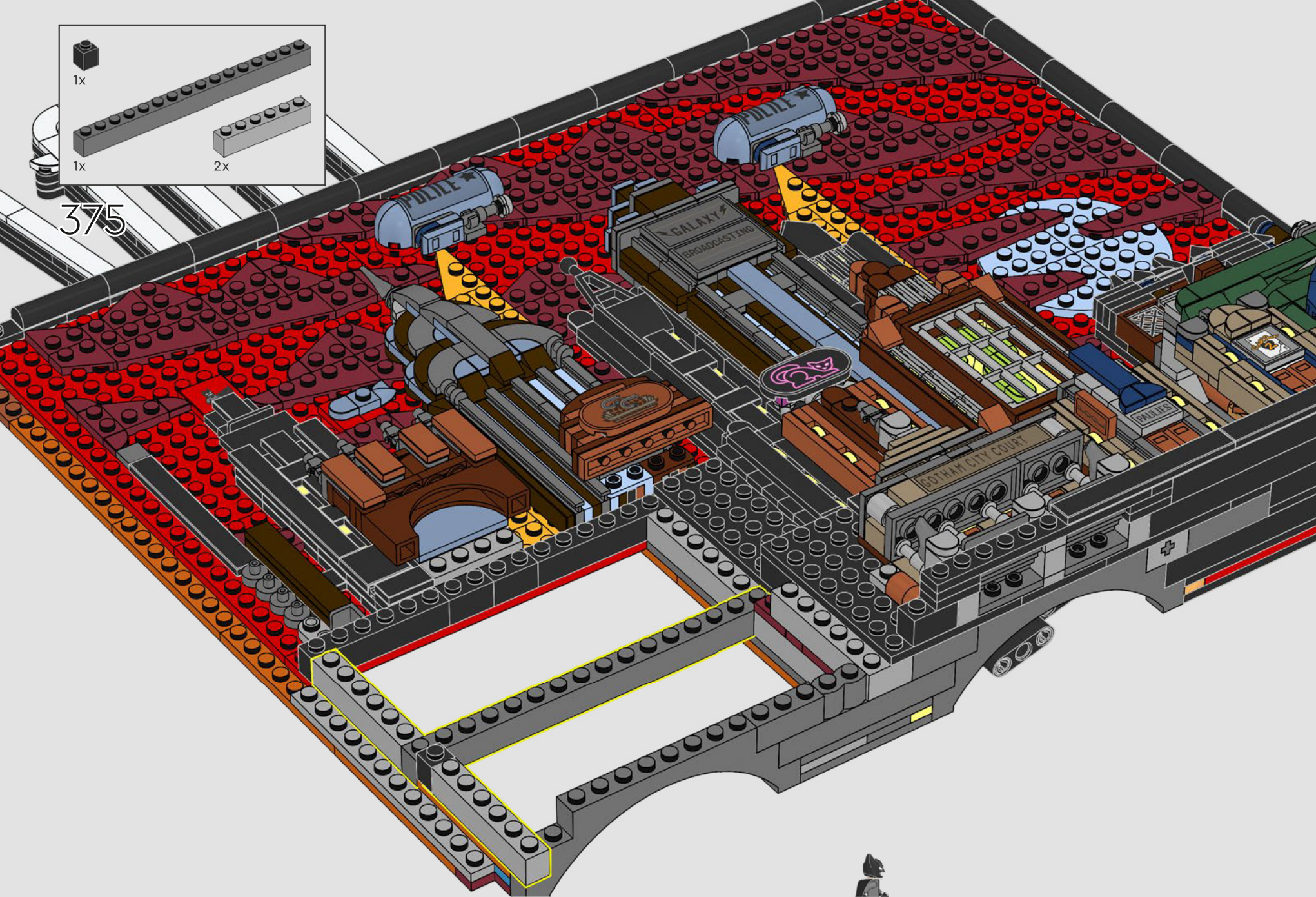

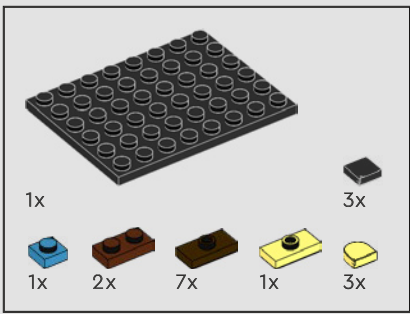

376

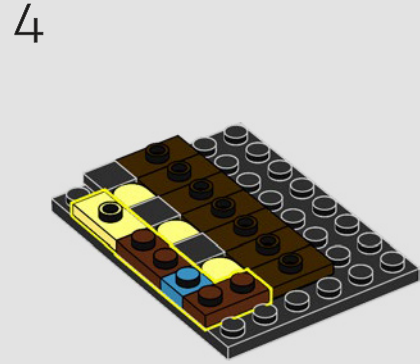
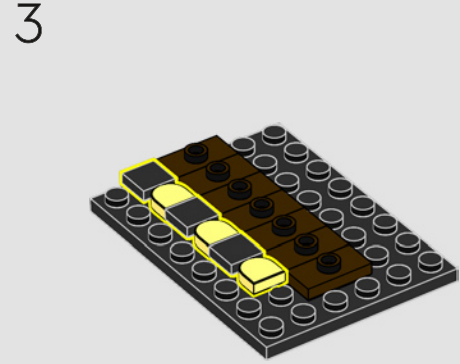
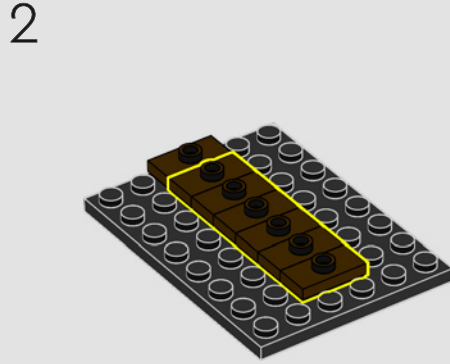
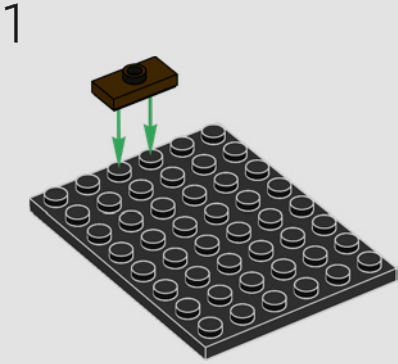

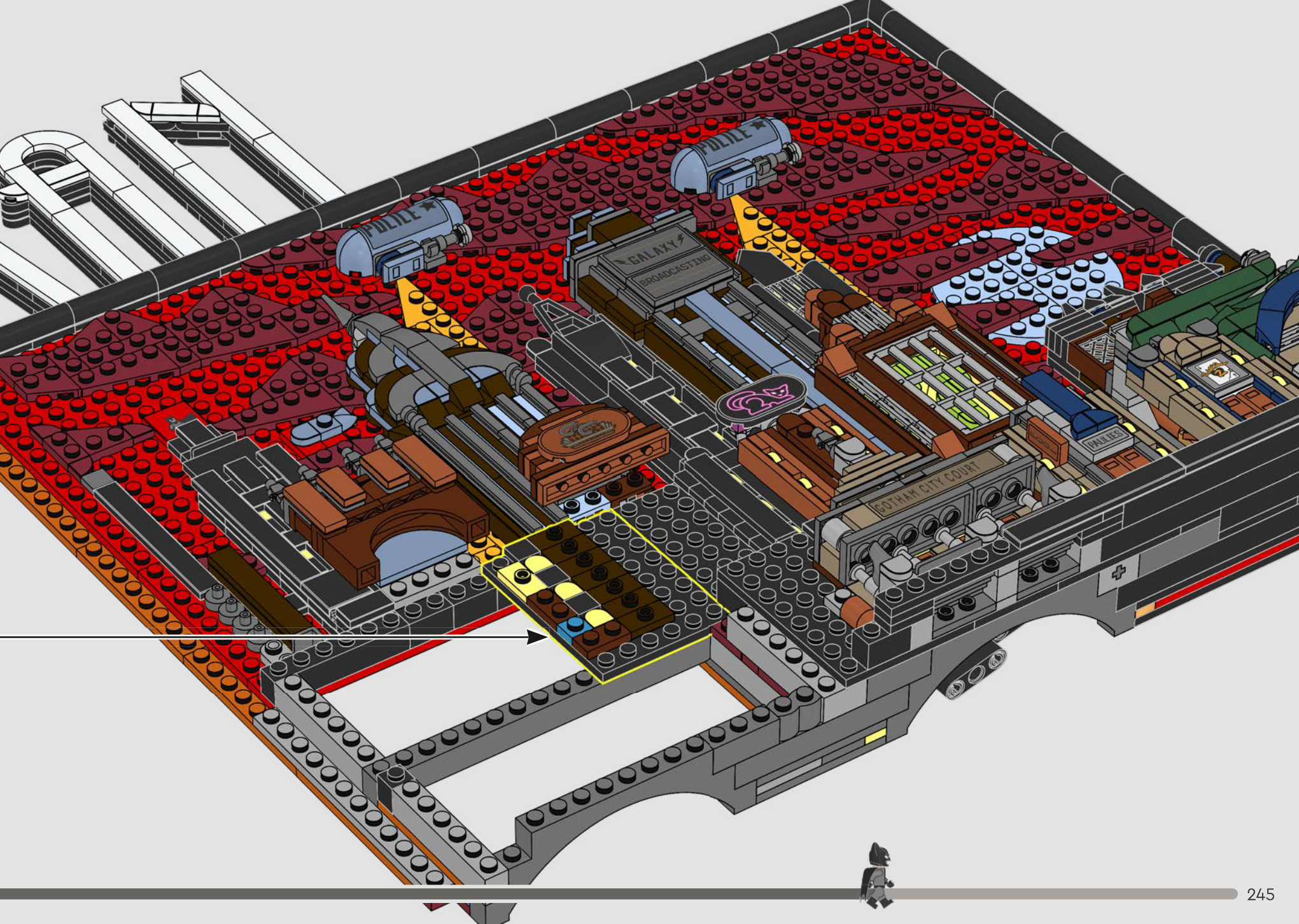

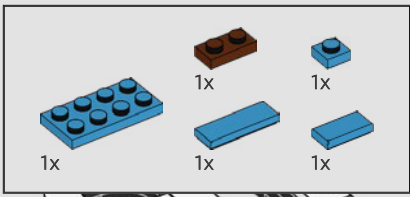

377

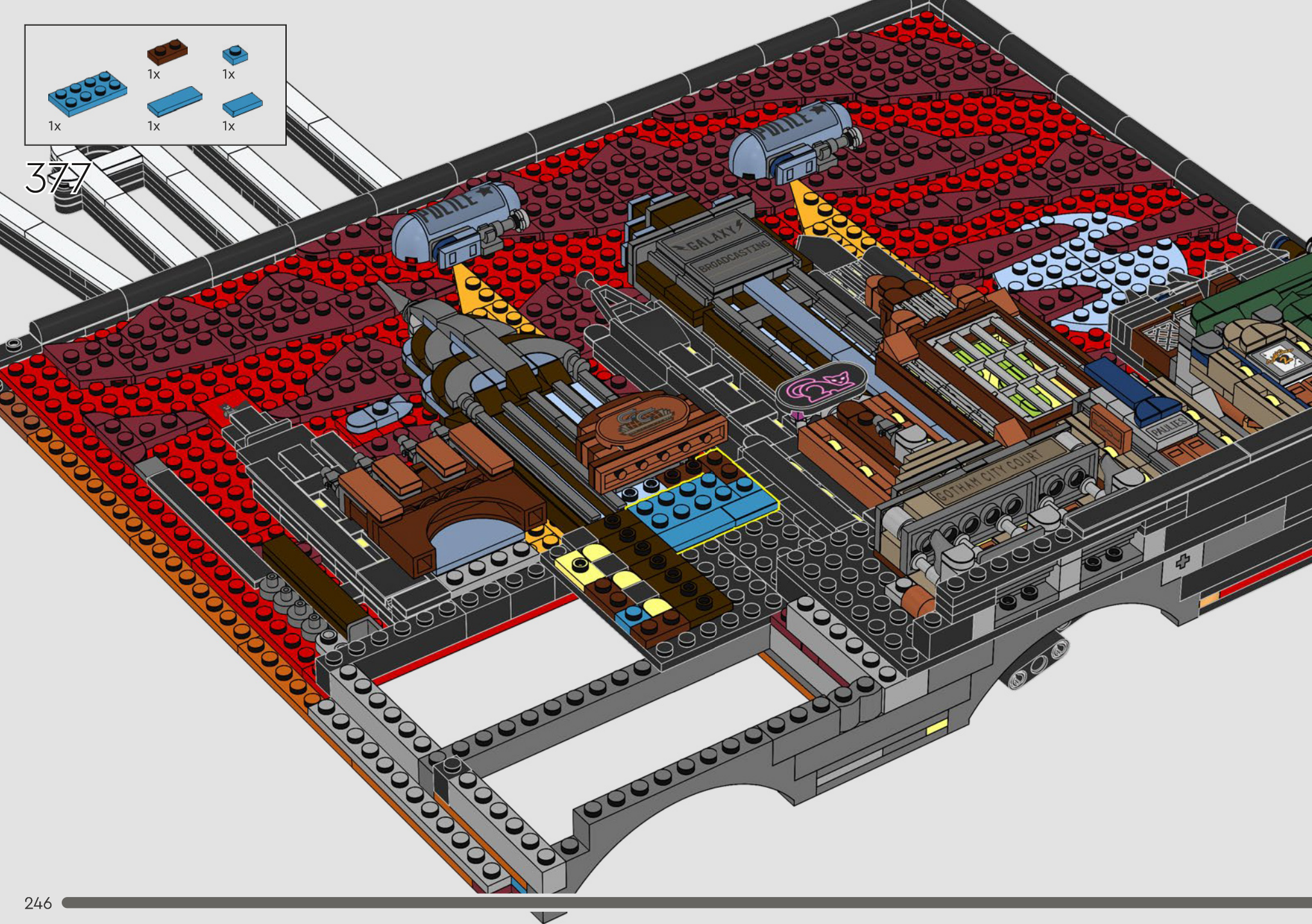

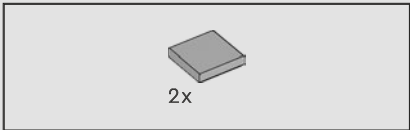

378

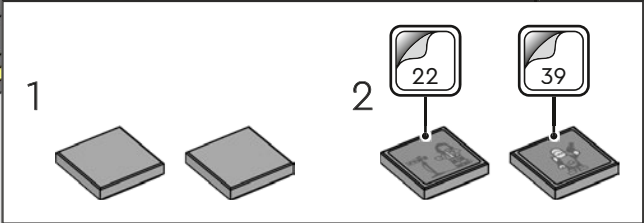
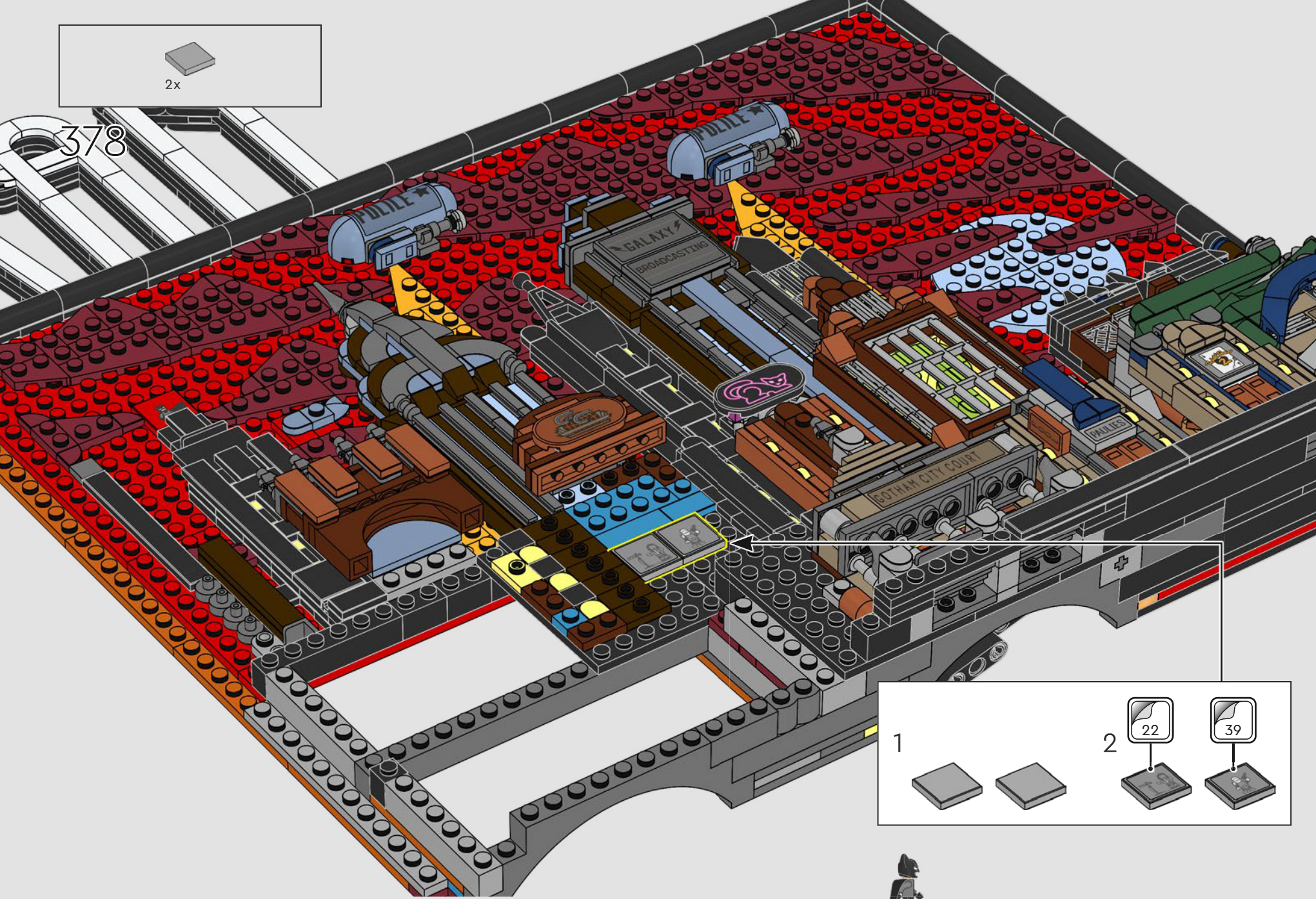

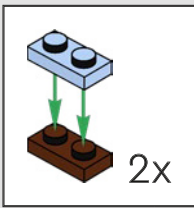

379

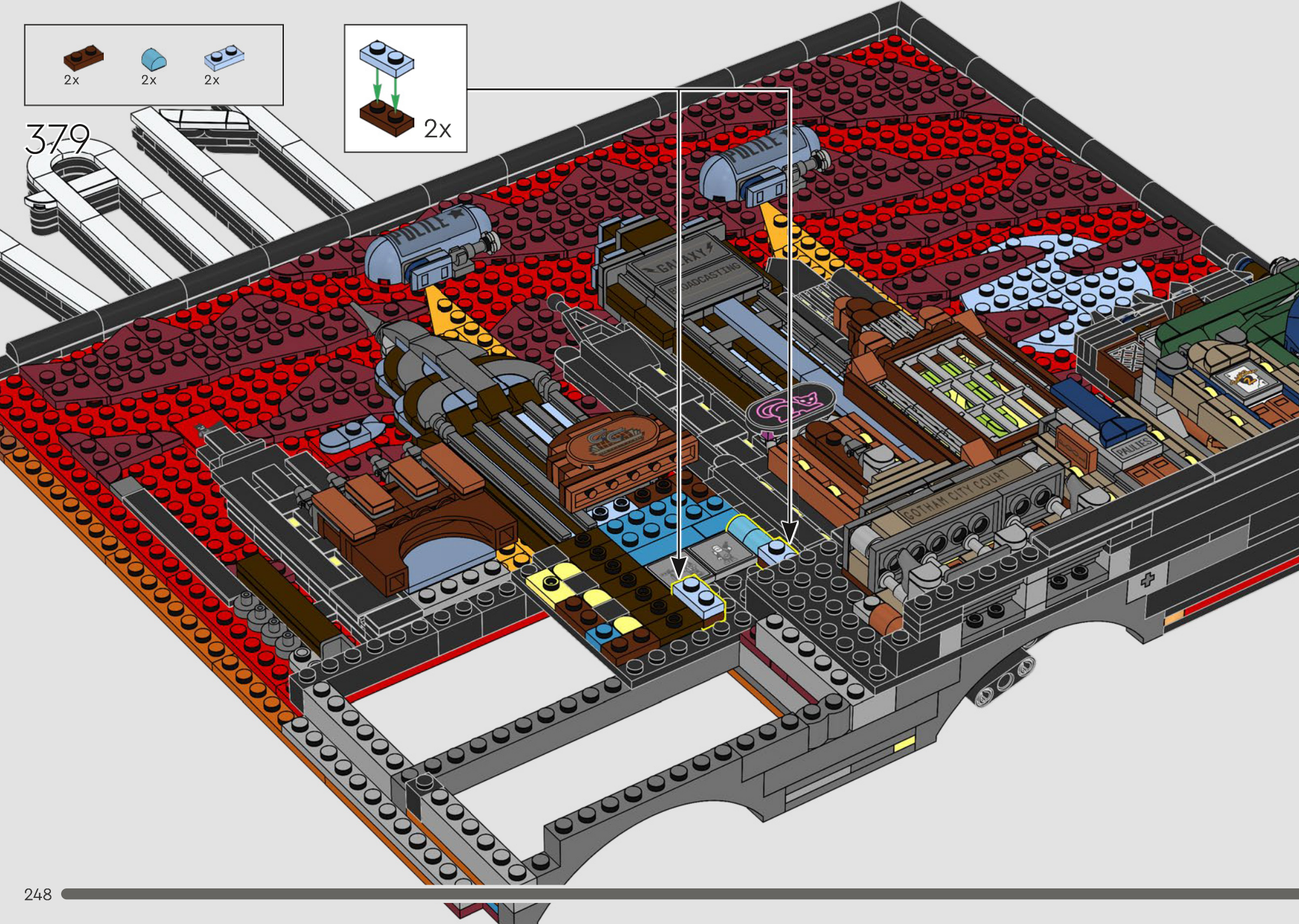

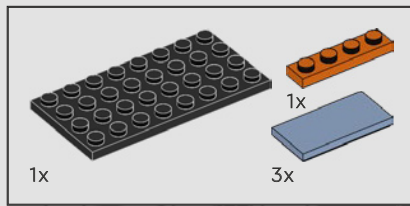

380

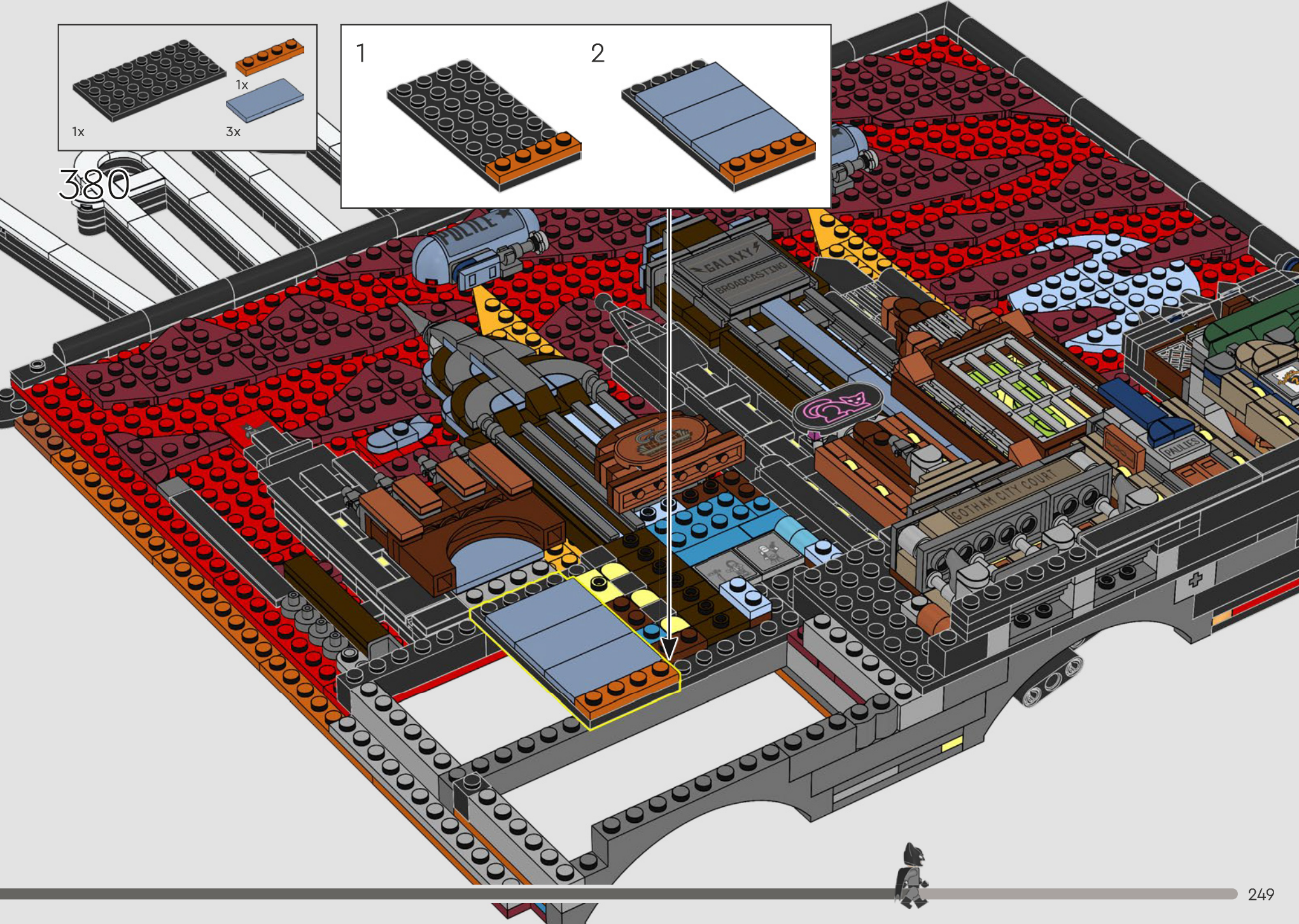
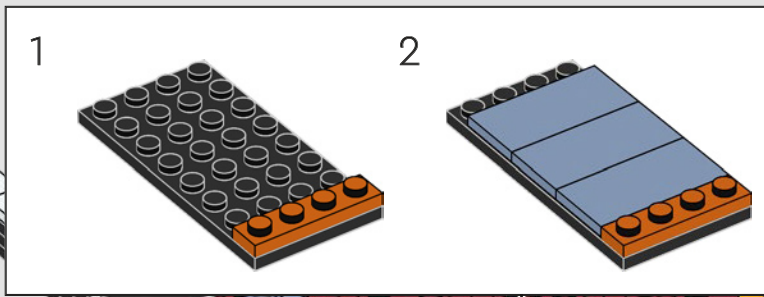

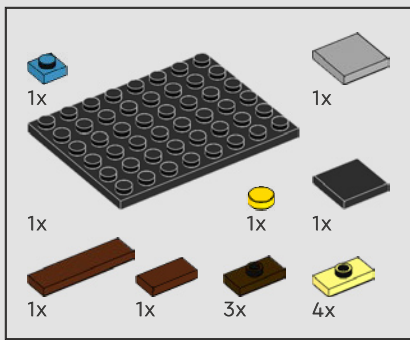

381

1

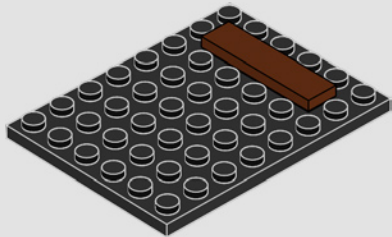

2

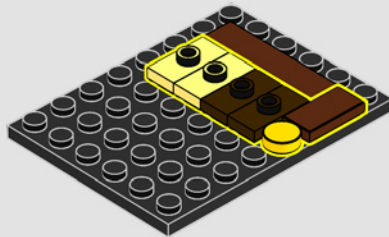

3

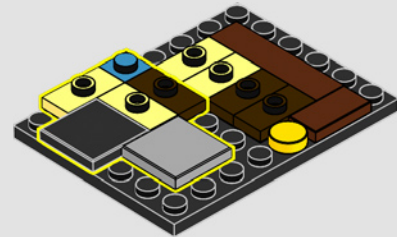

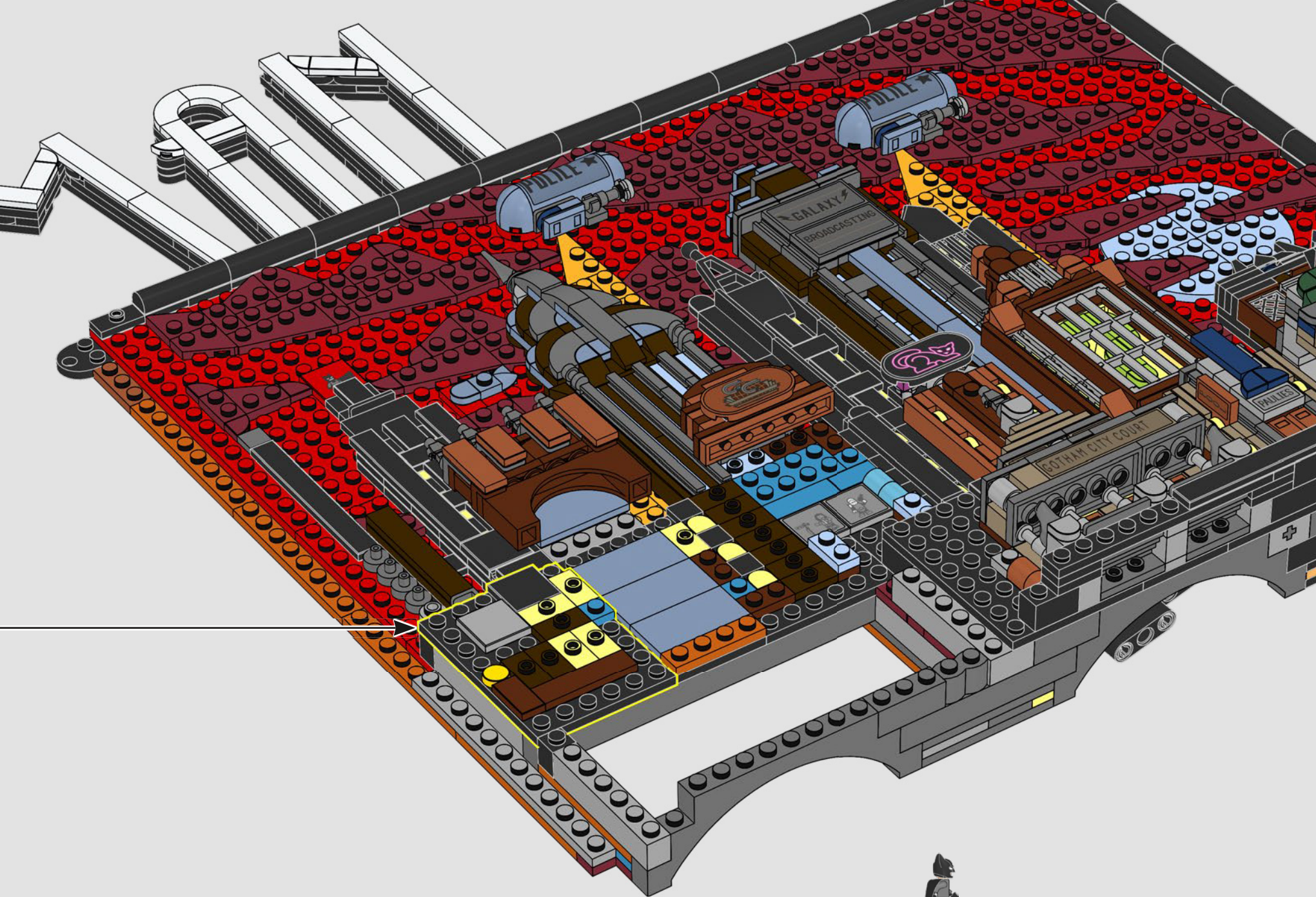

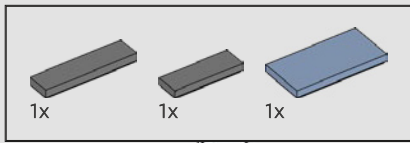

383

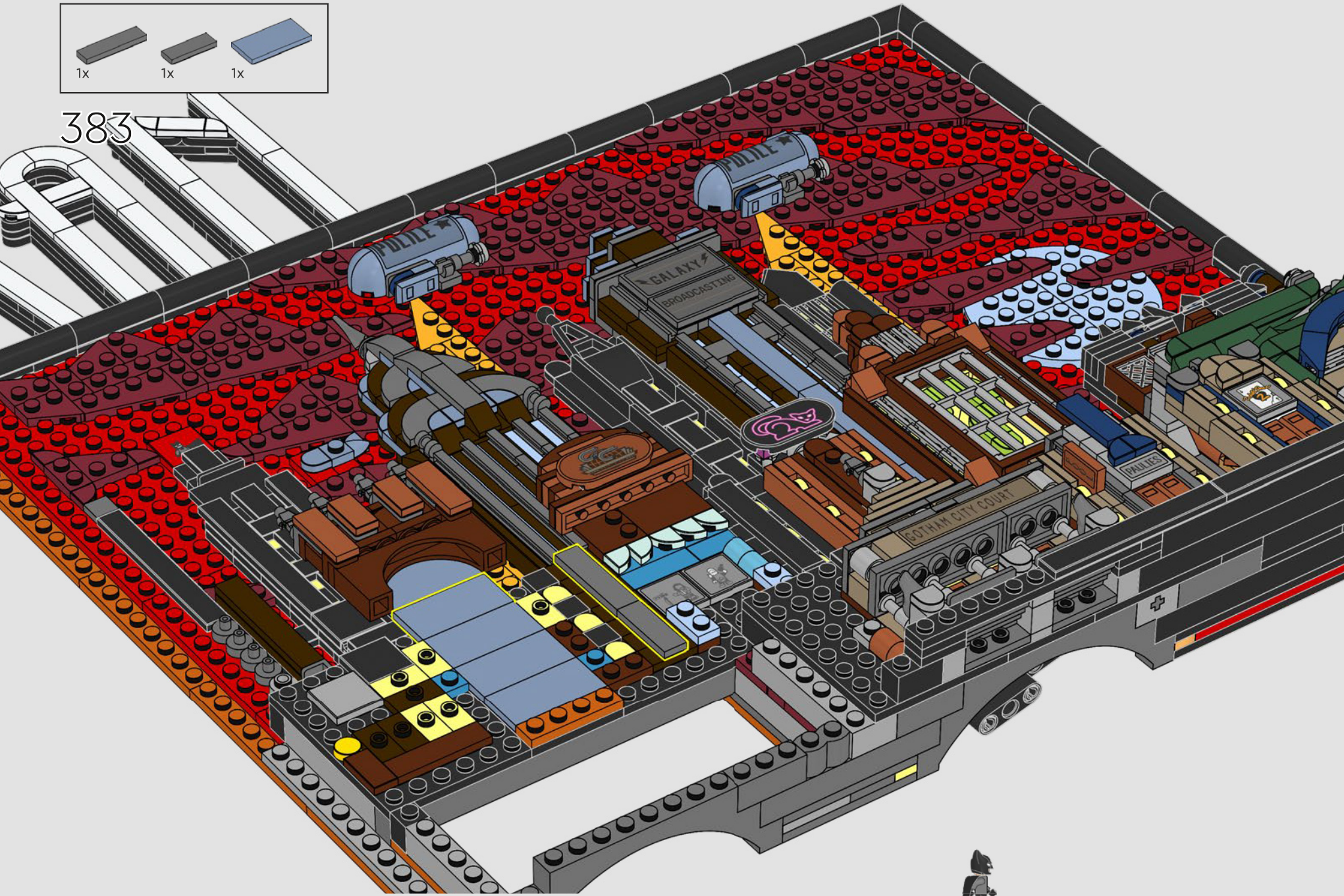

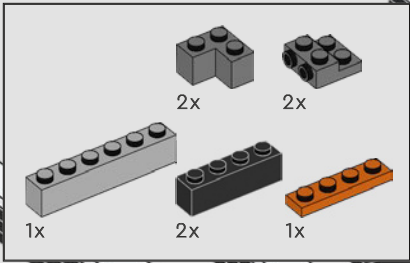

384

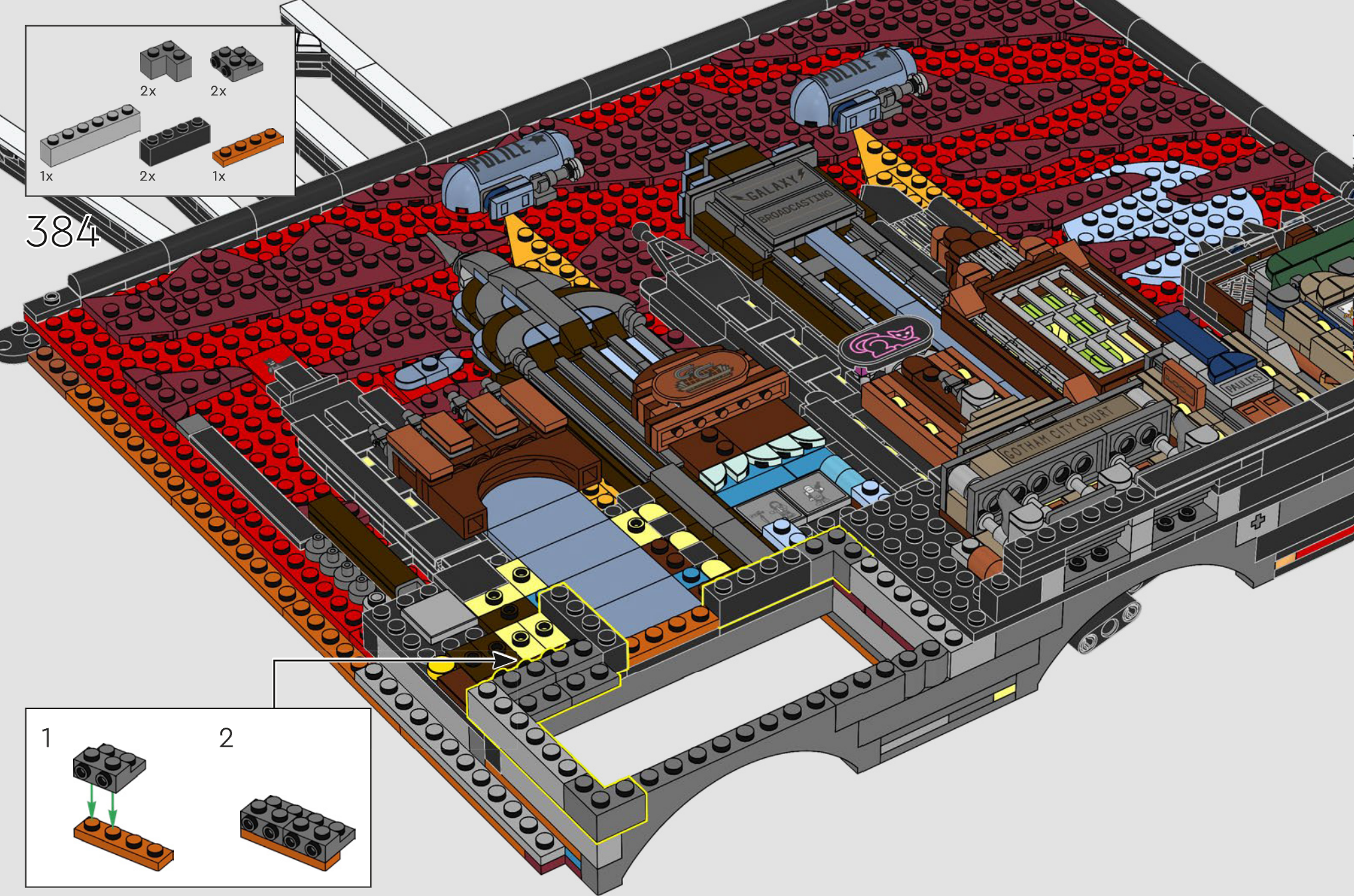
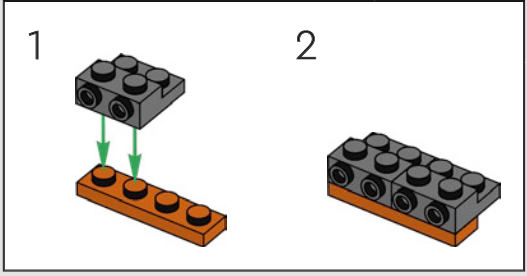

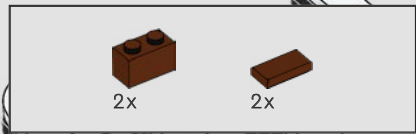

385

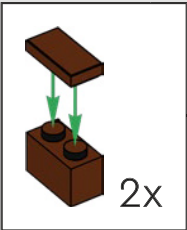
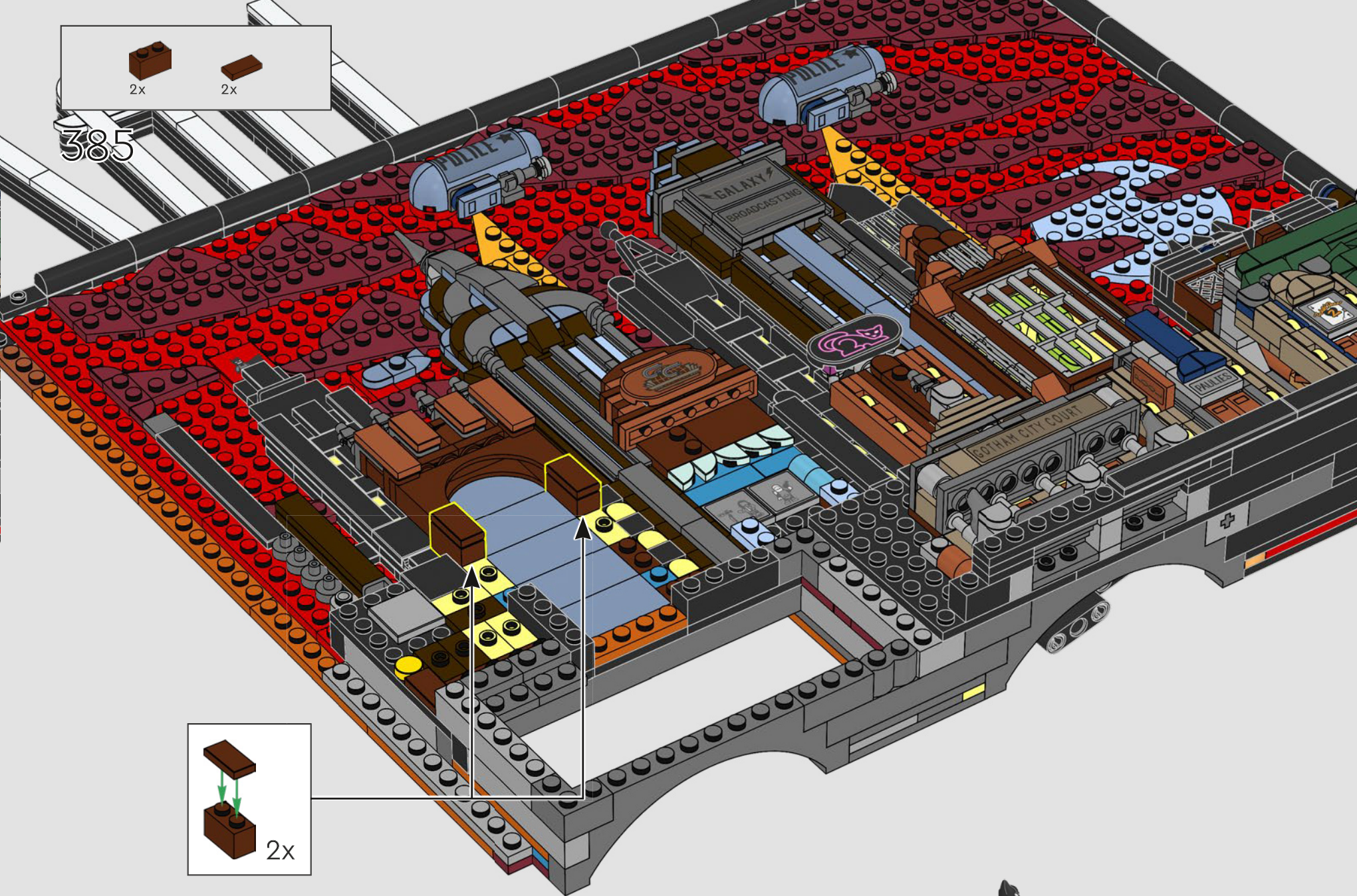

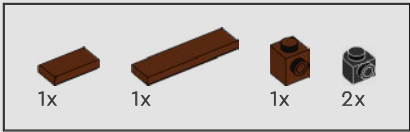

386

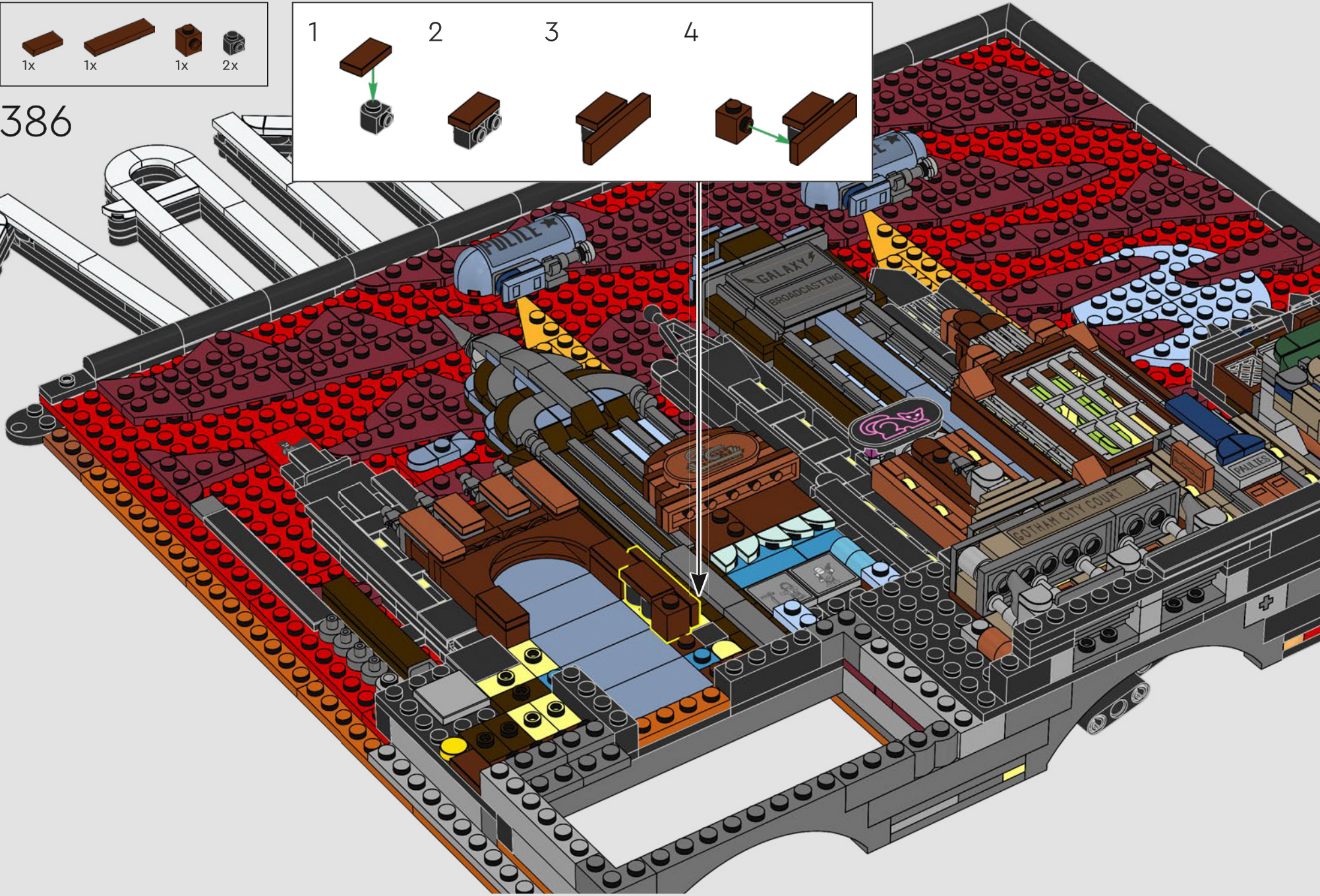
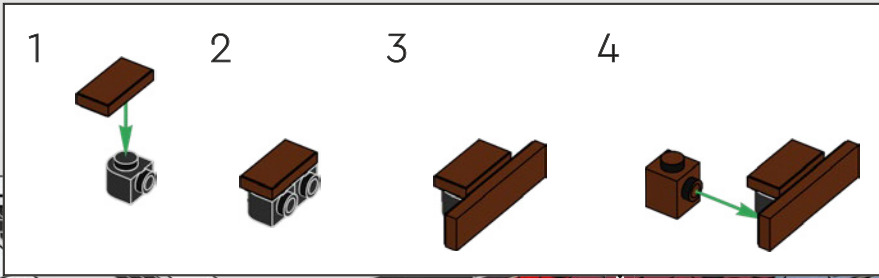

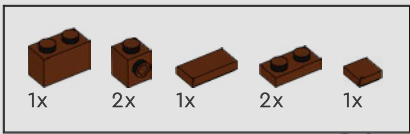

388

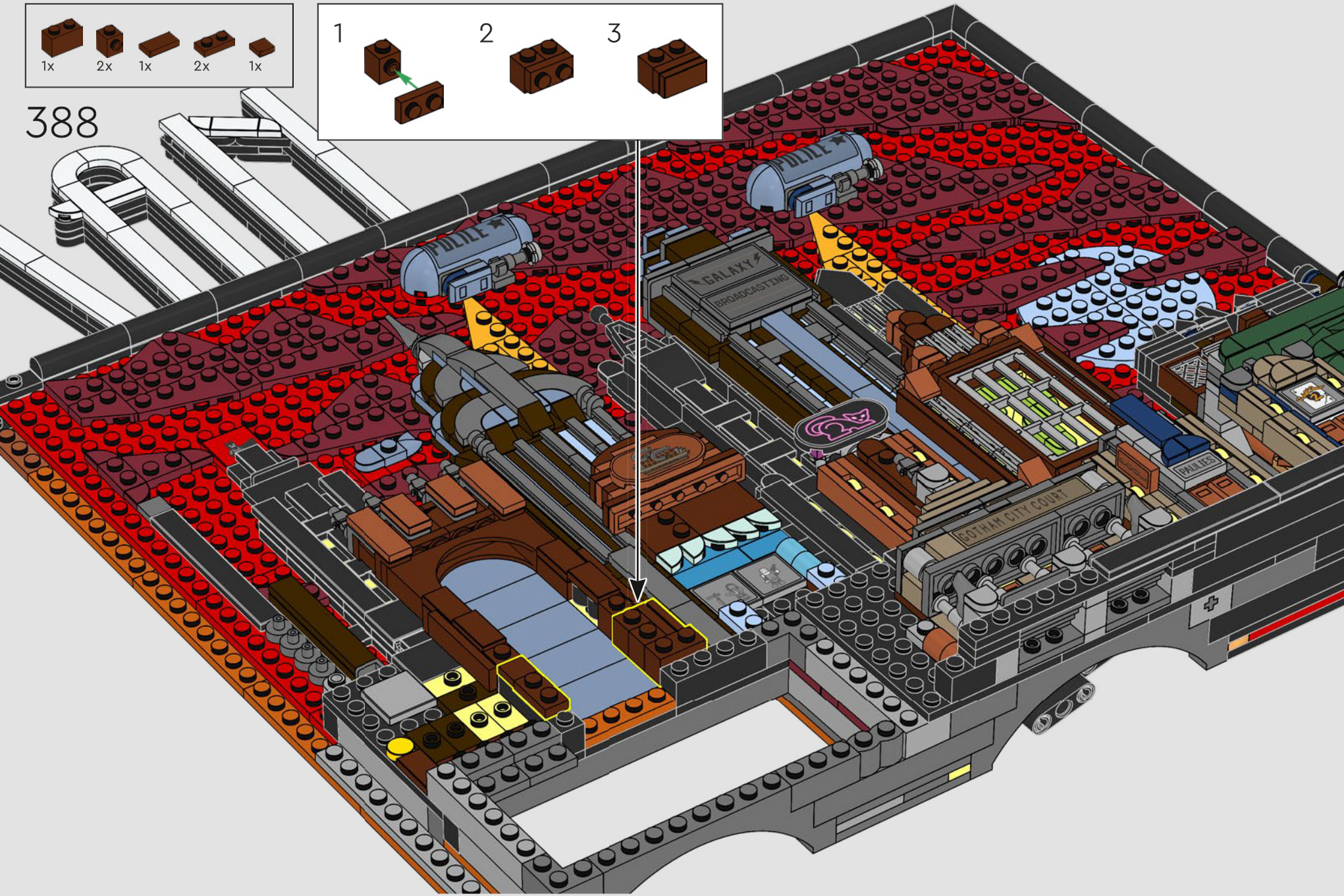
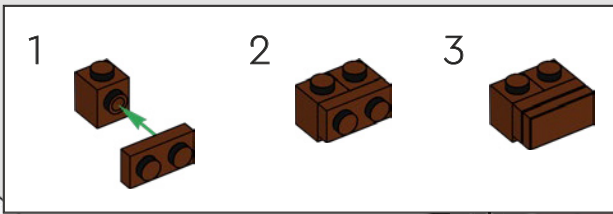

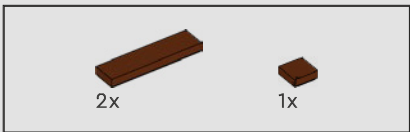

389

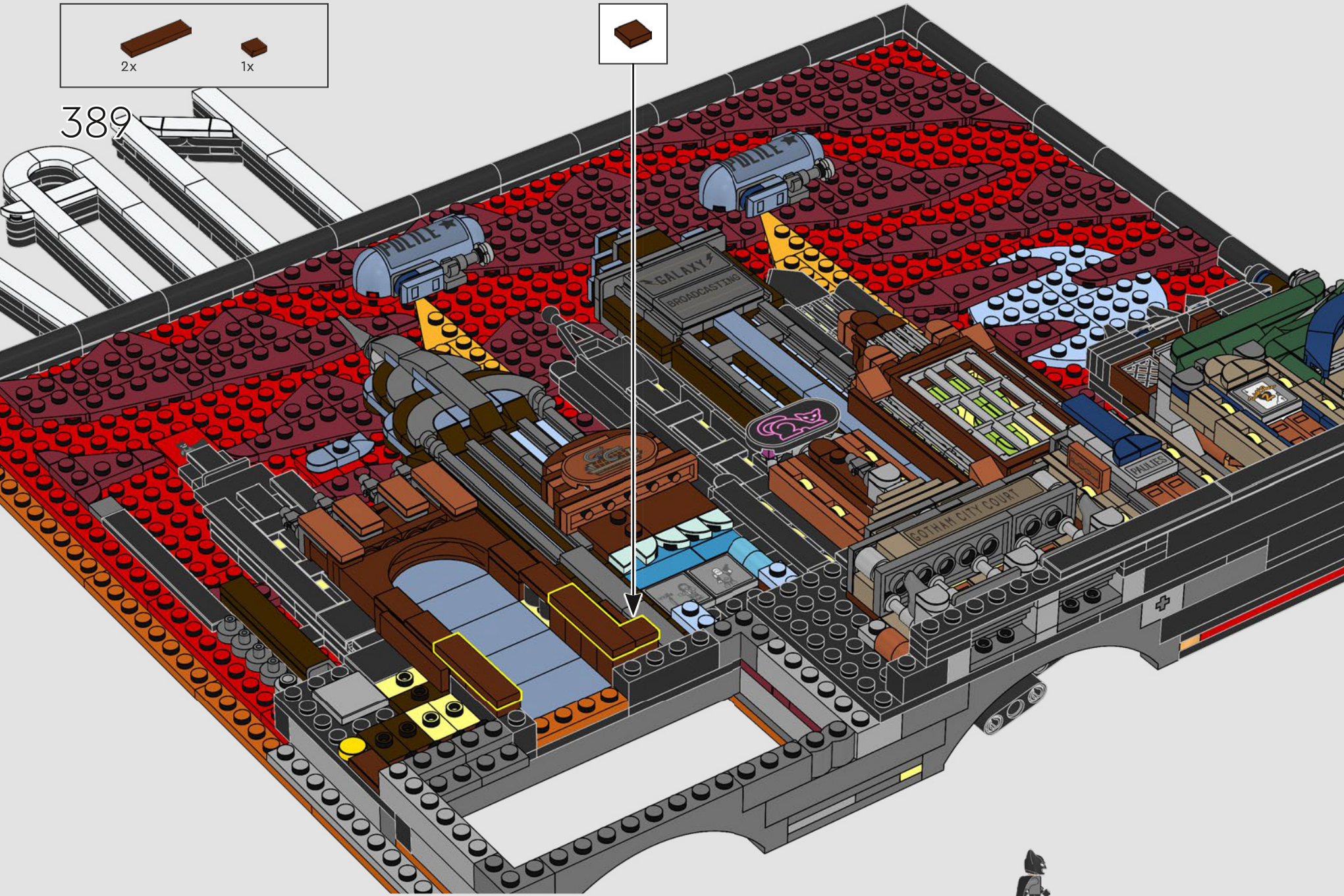

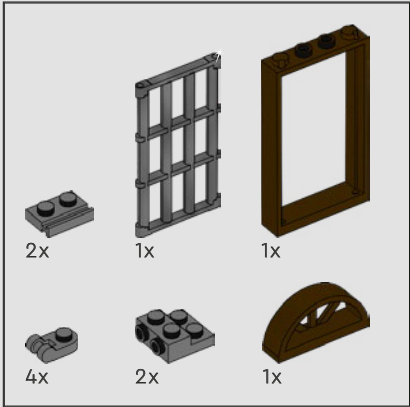
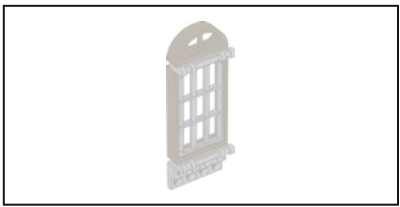

390

1

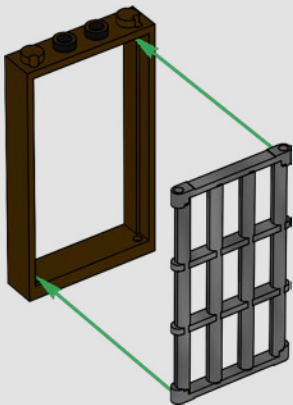

2

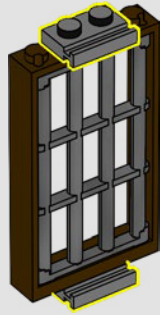

3



4

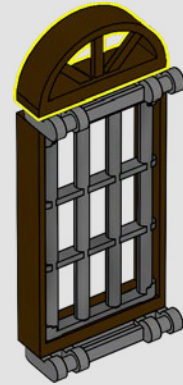

5

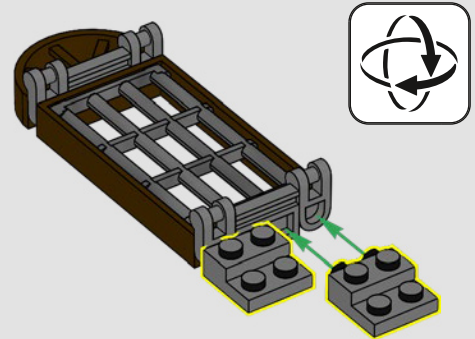

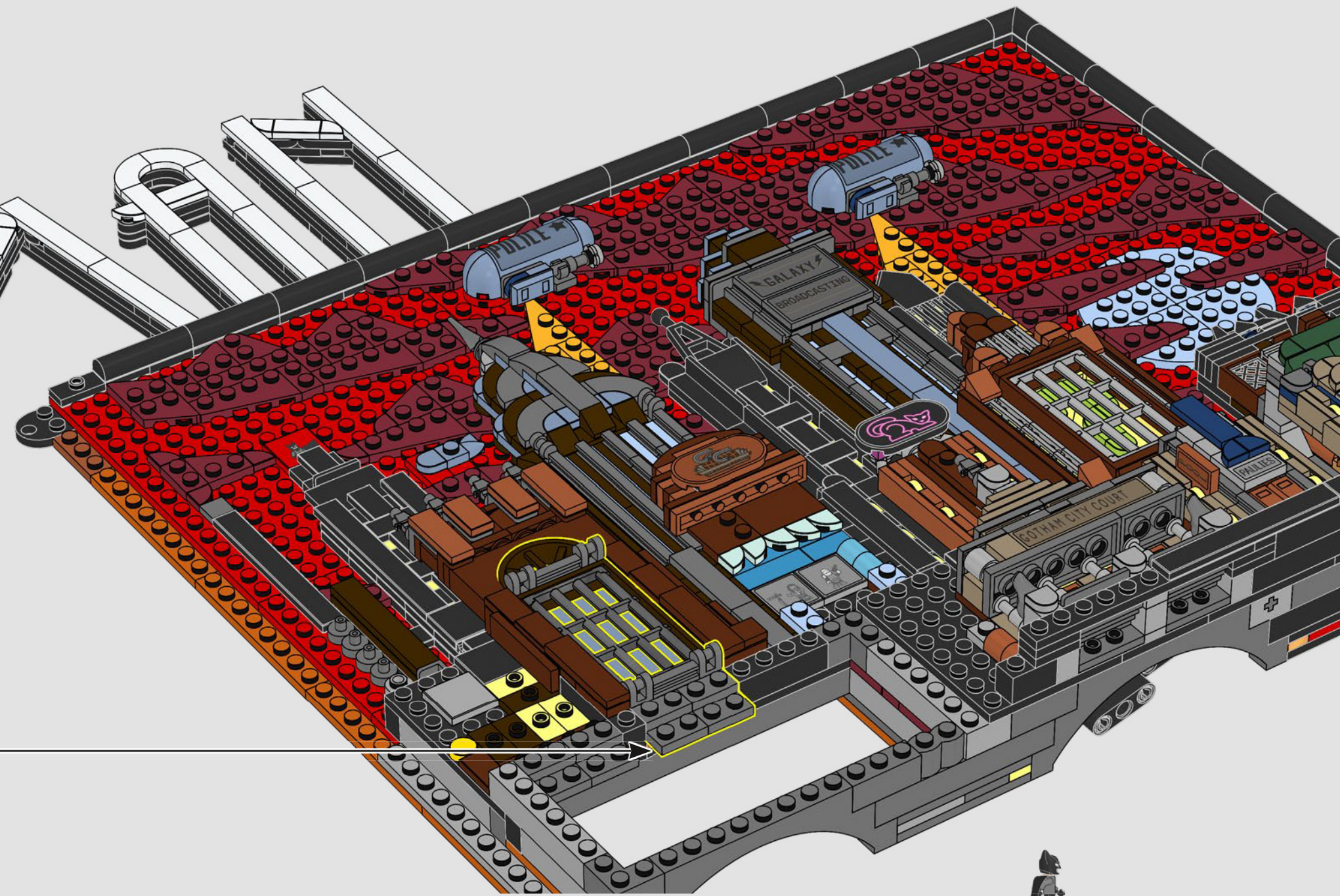

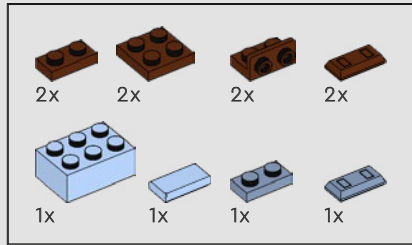

Episode: *Birds of a Feather*
Épisode : *Monsieur Pingouin*
Episodio: *Aves del mismo nido*

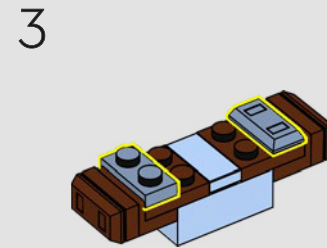
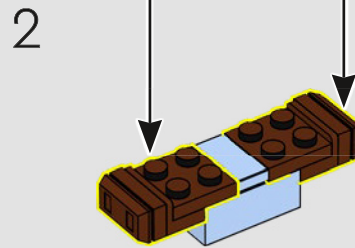
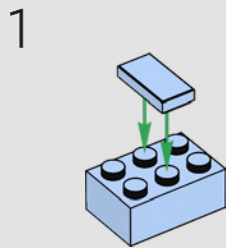
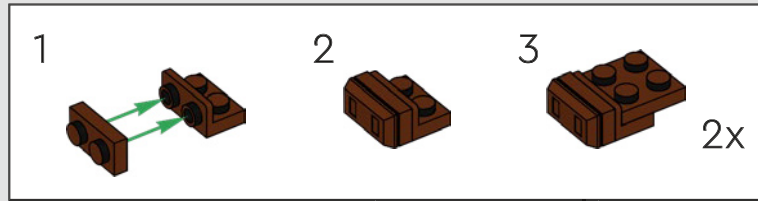

391

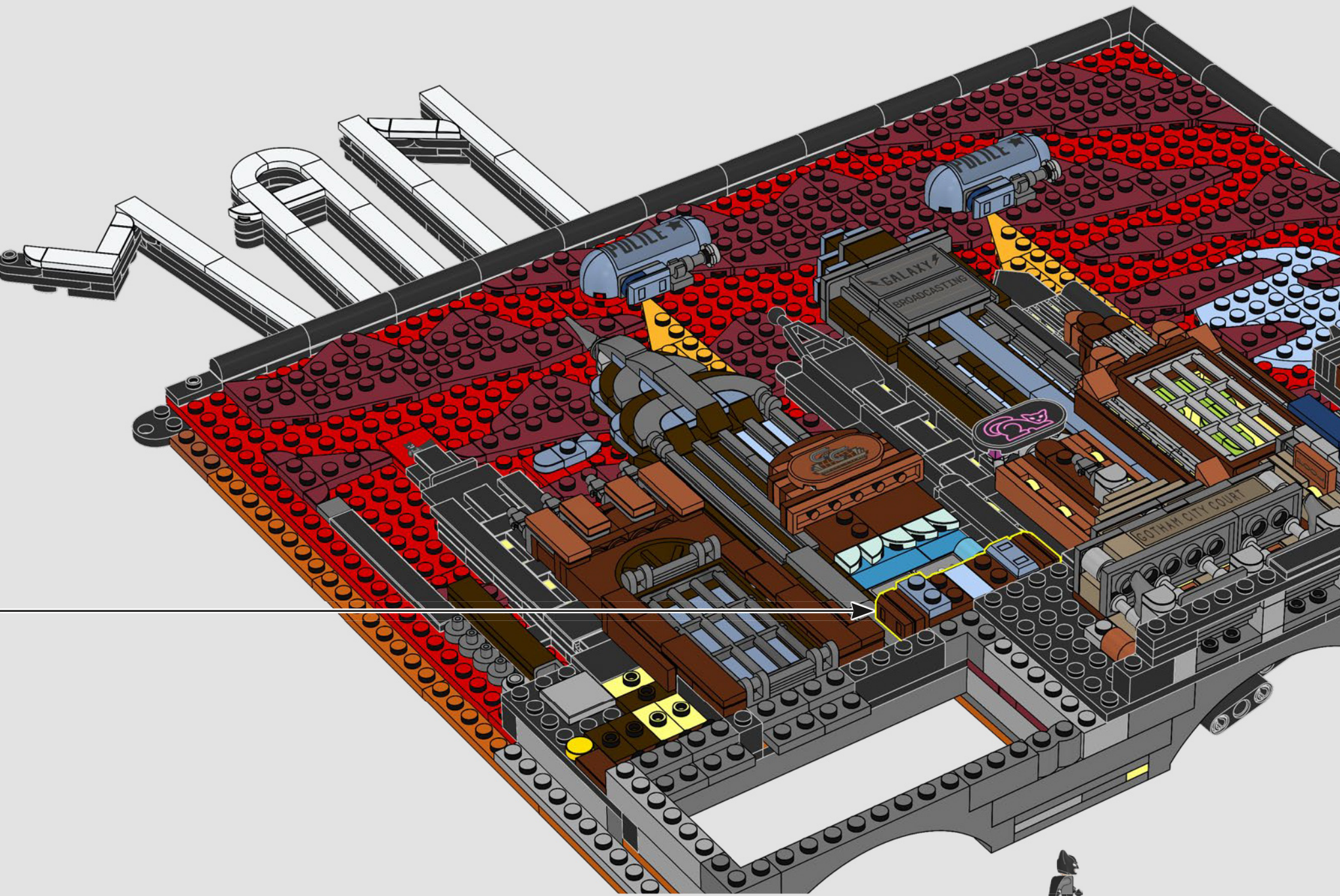



2x  1x 

392

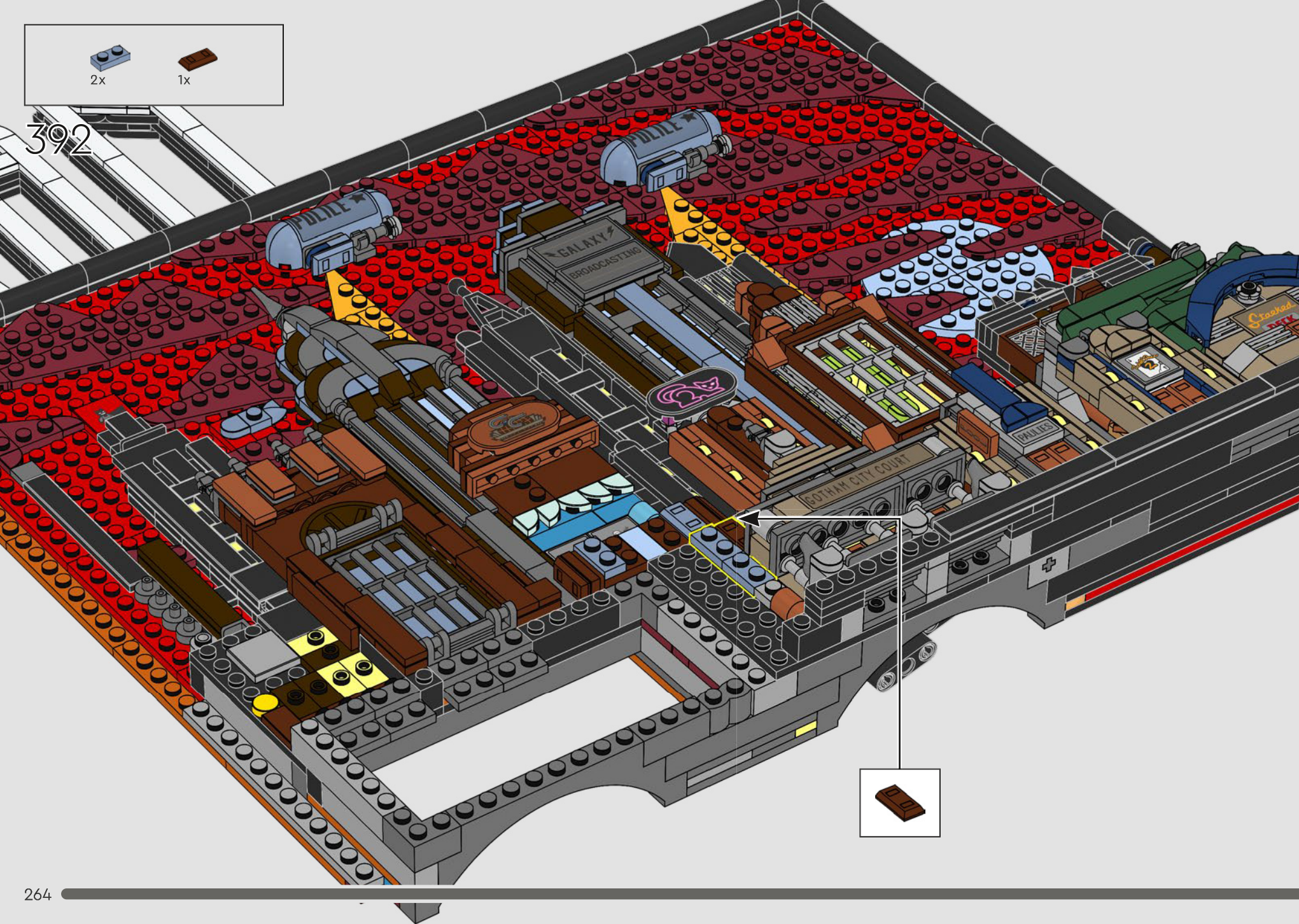

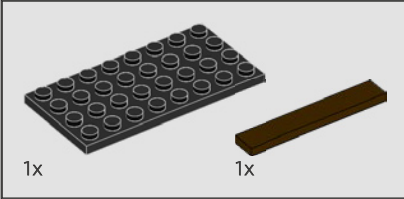
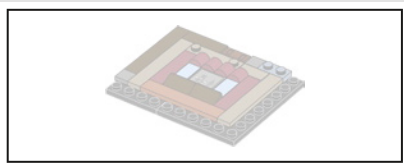

393

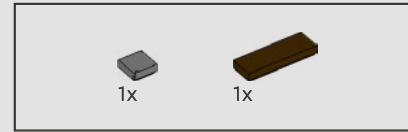
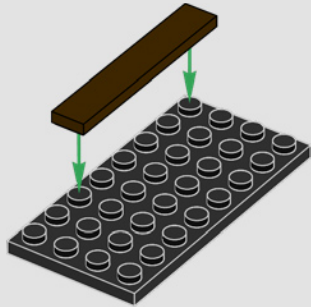

394

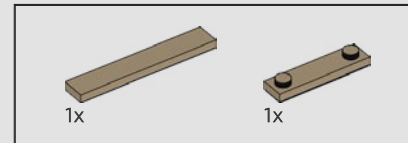
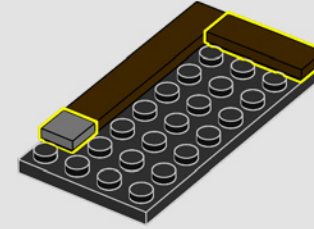

395

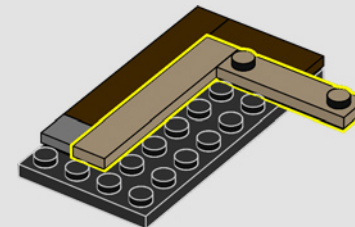

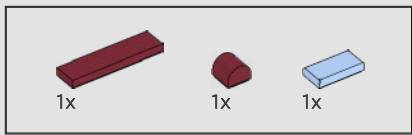

396

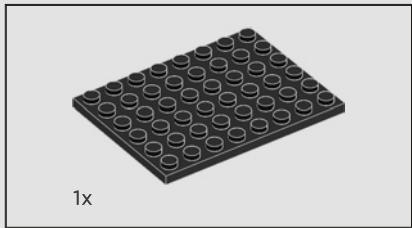
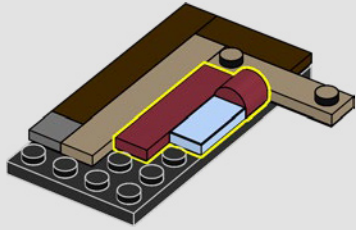

397

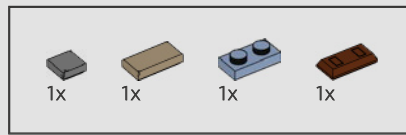
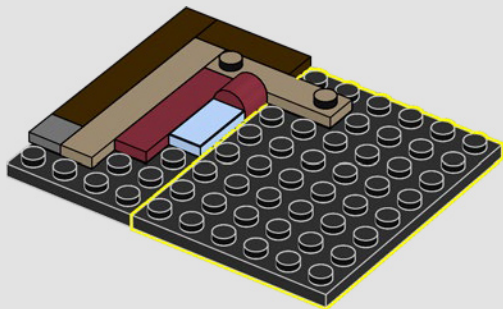

398

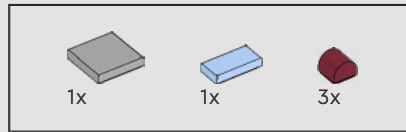
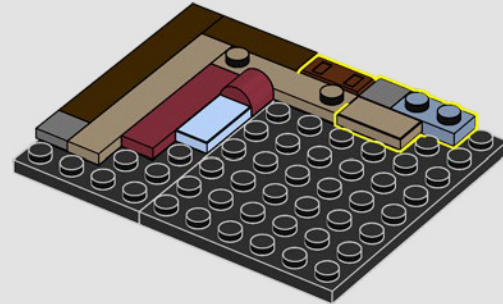

399

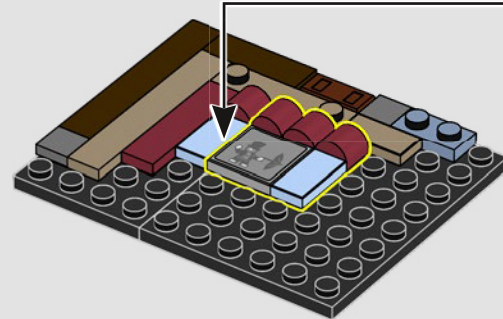
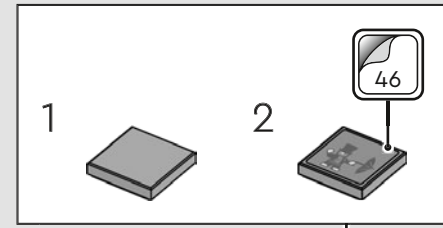

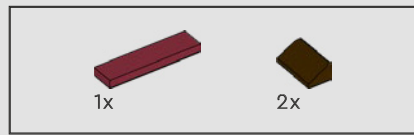

400

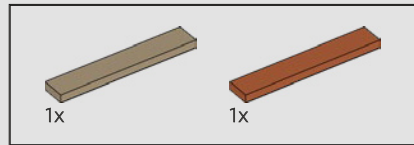
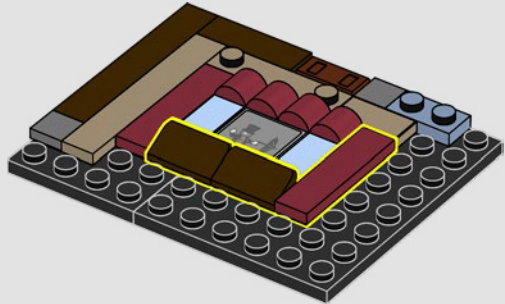

401

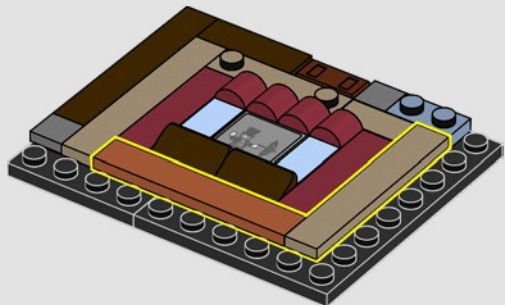

402

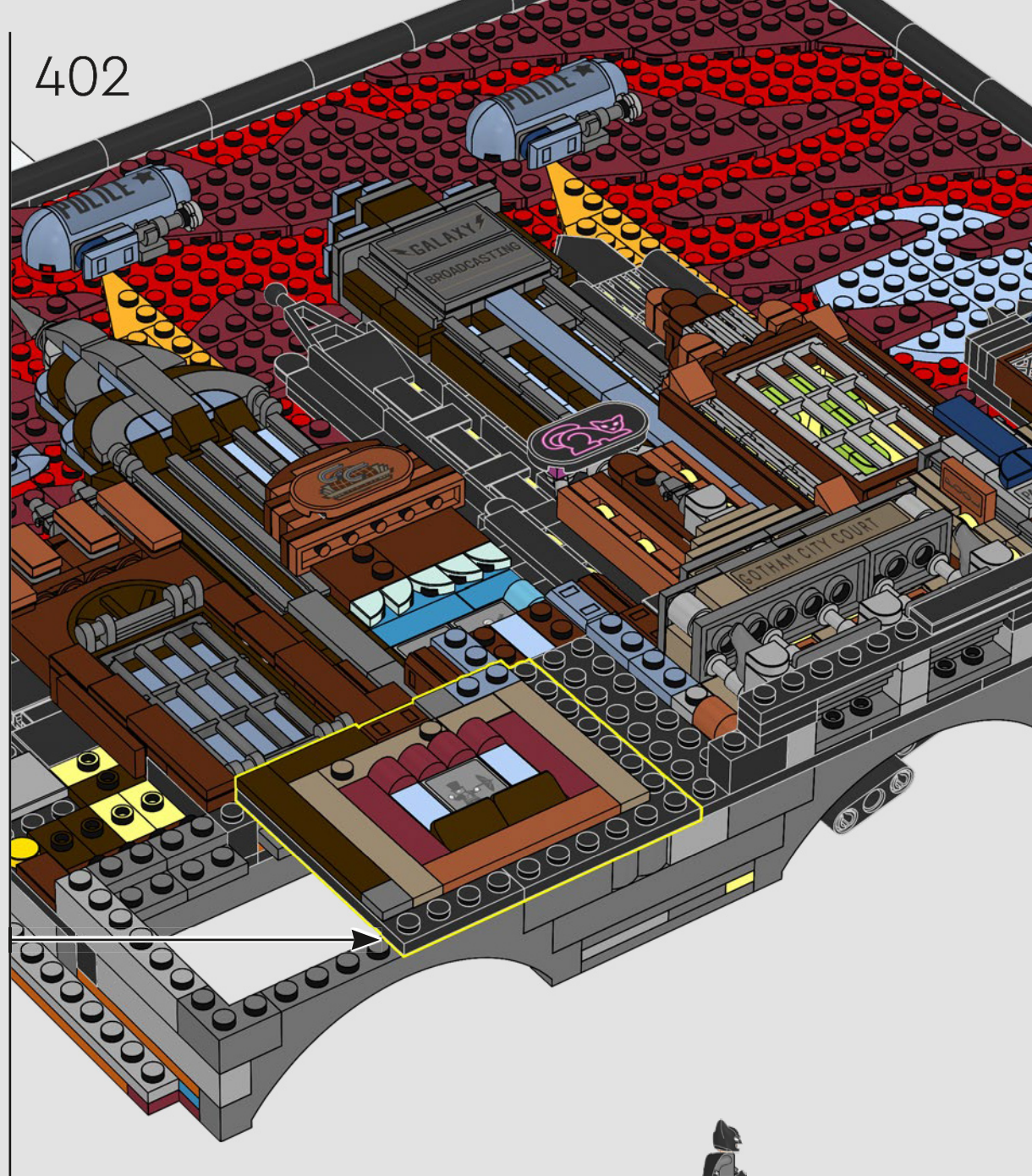

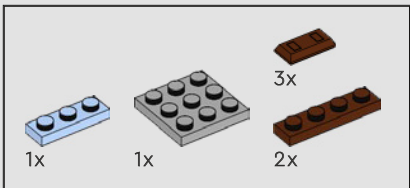

403

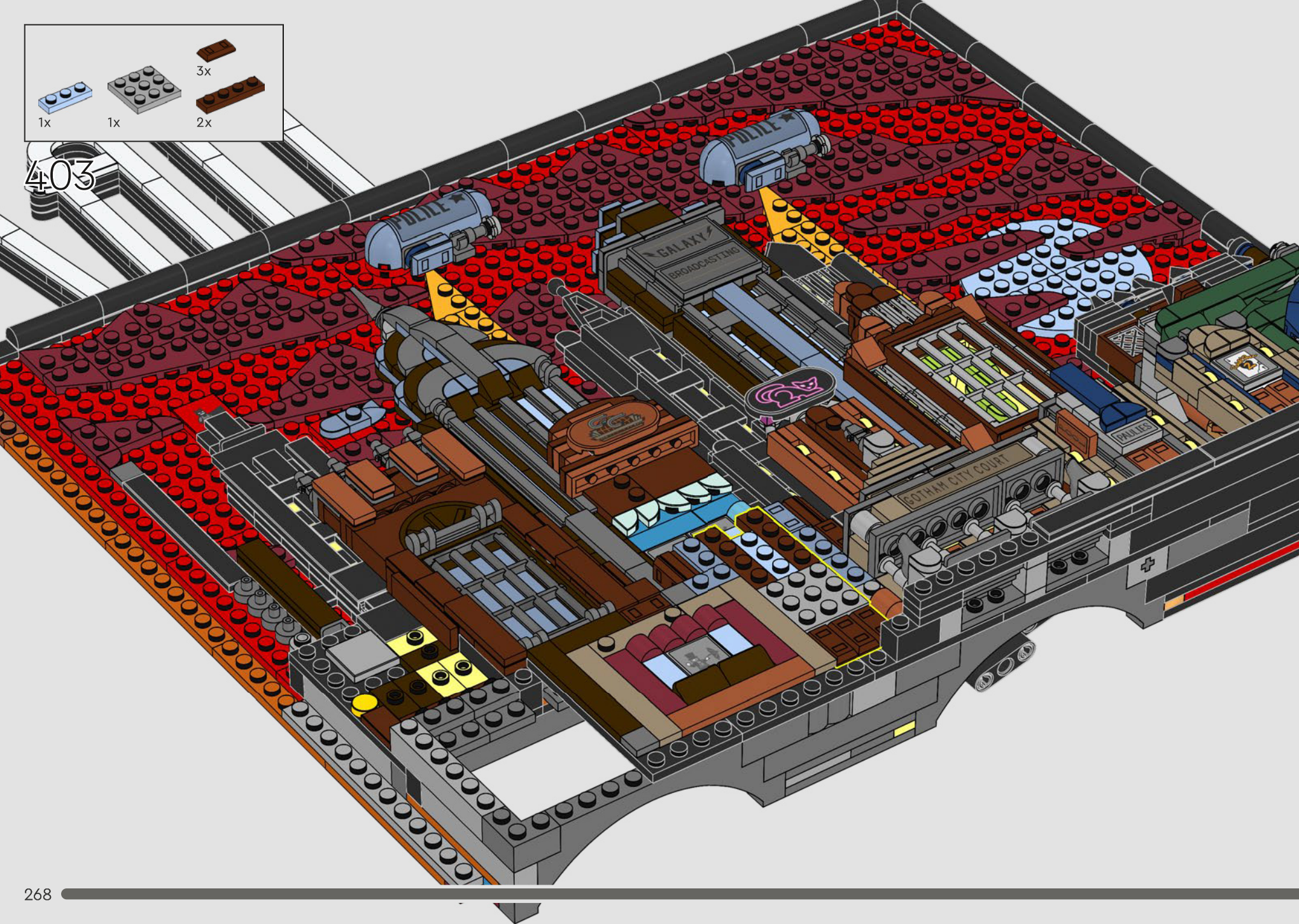

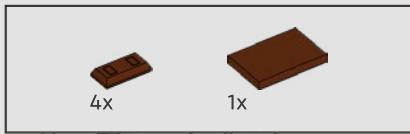

40/4

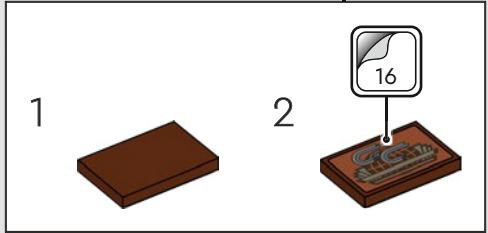
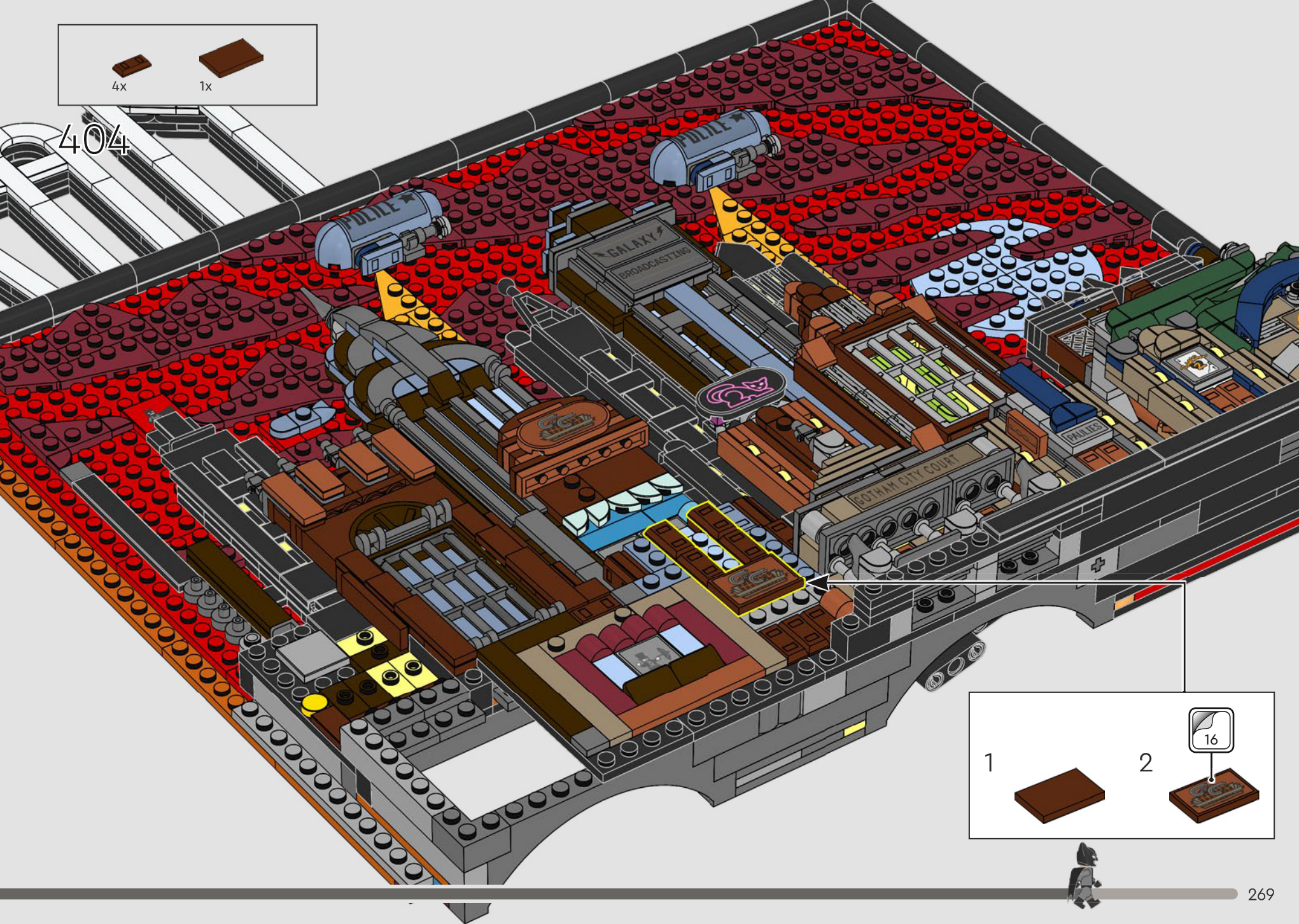

11x

405





406

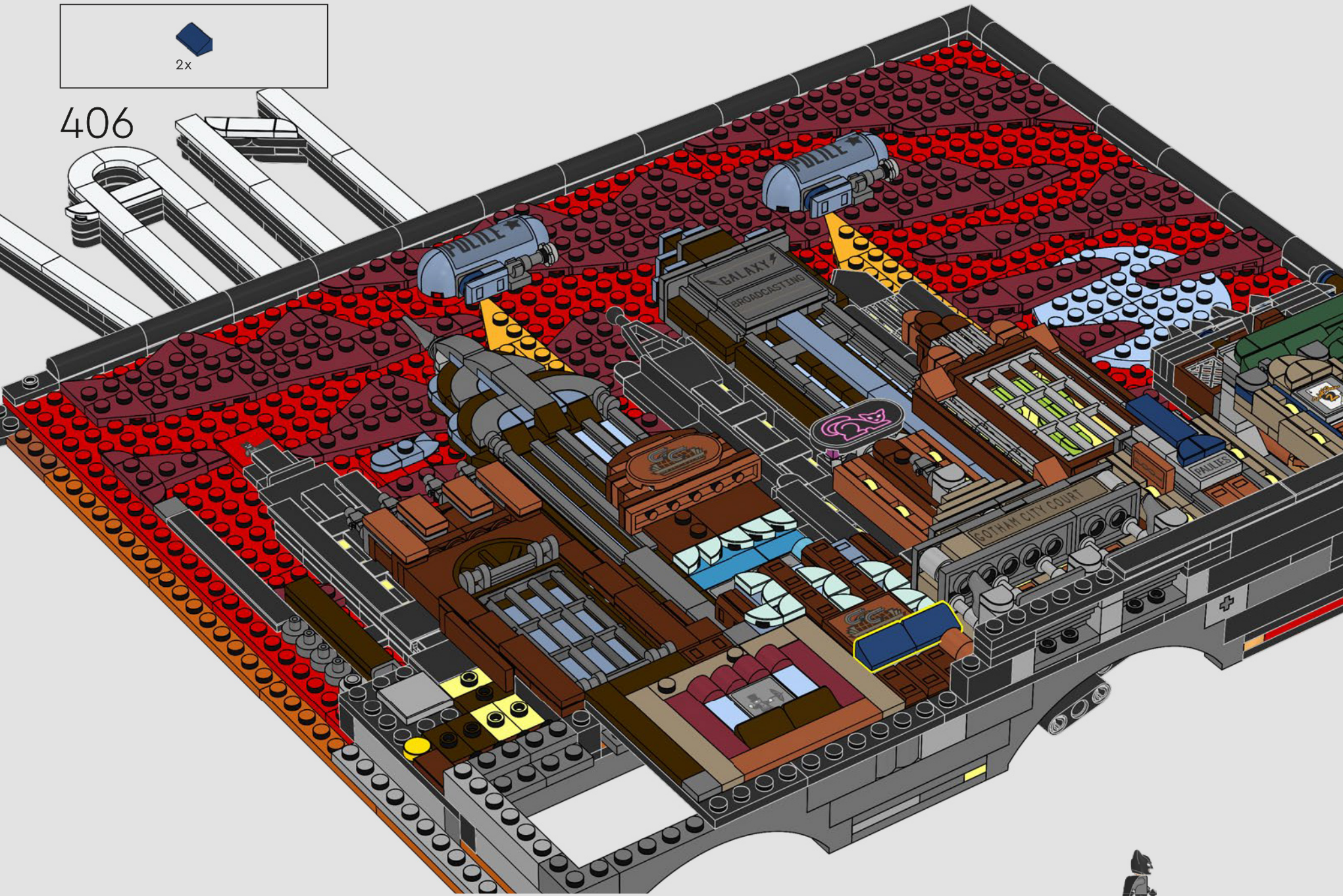

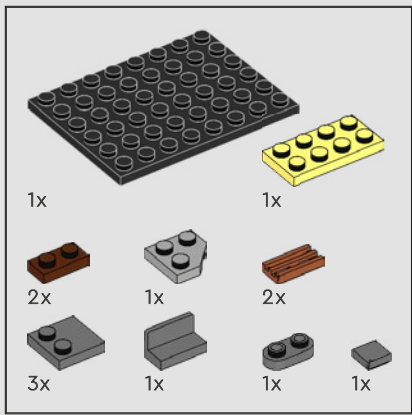

407

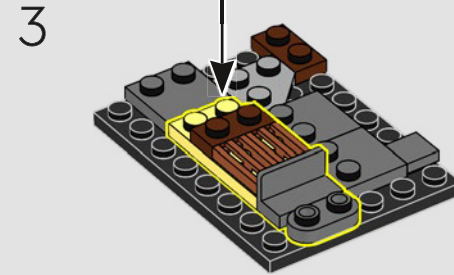
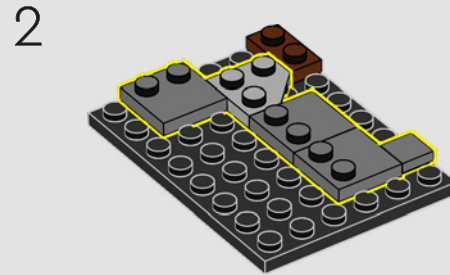
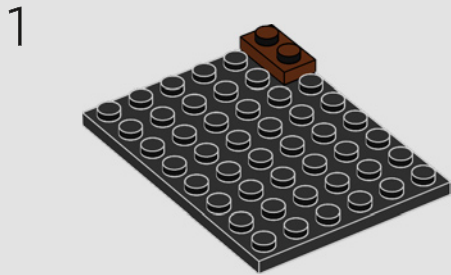
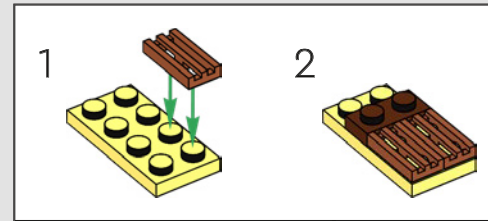

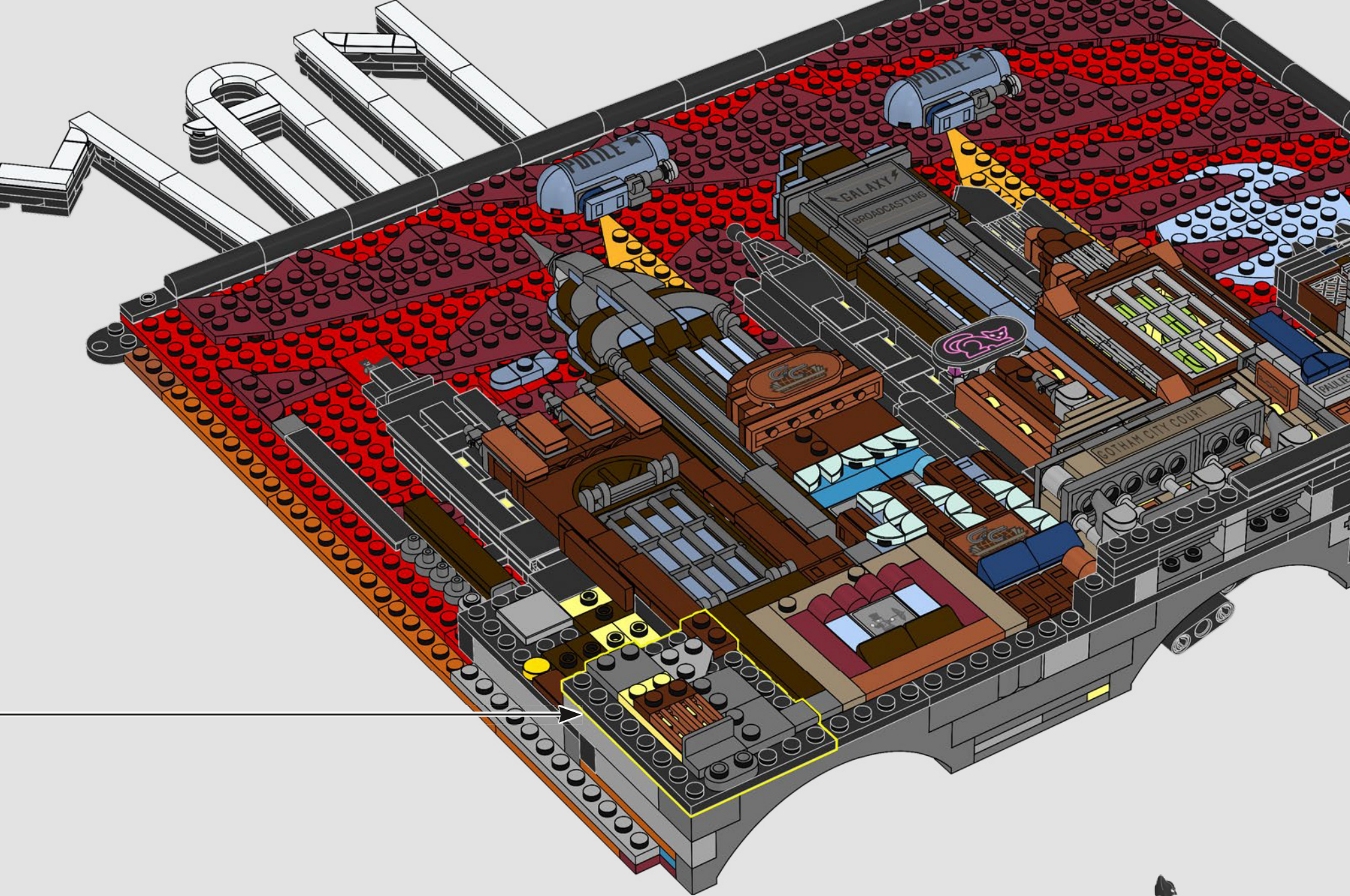

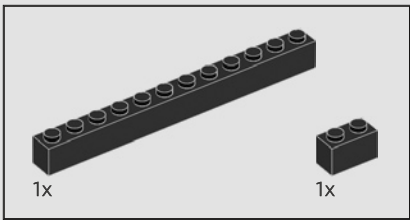

408

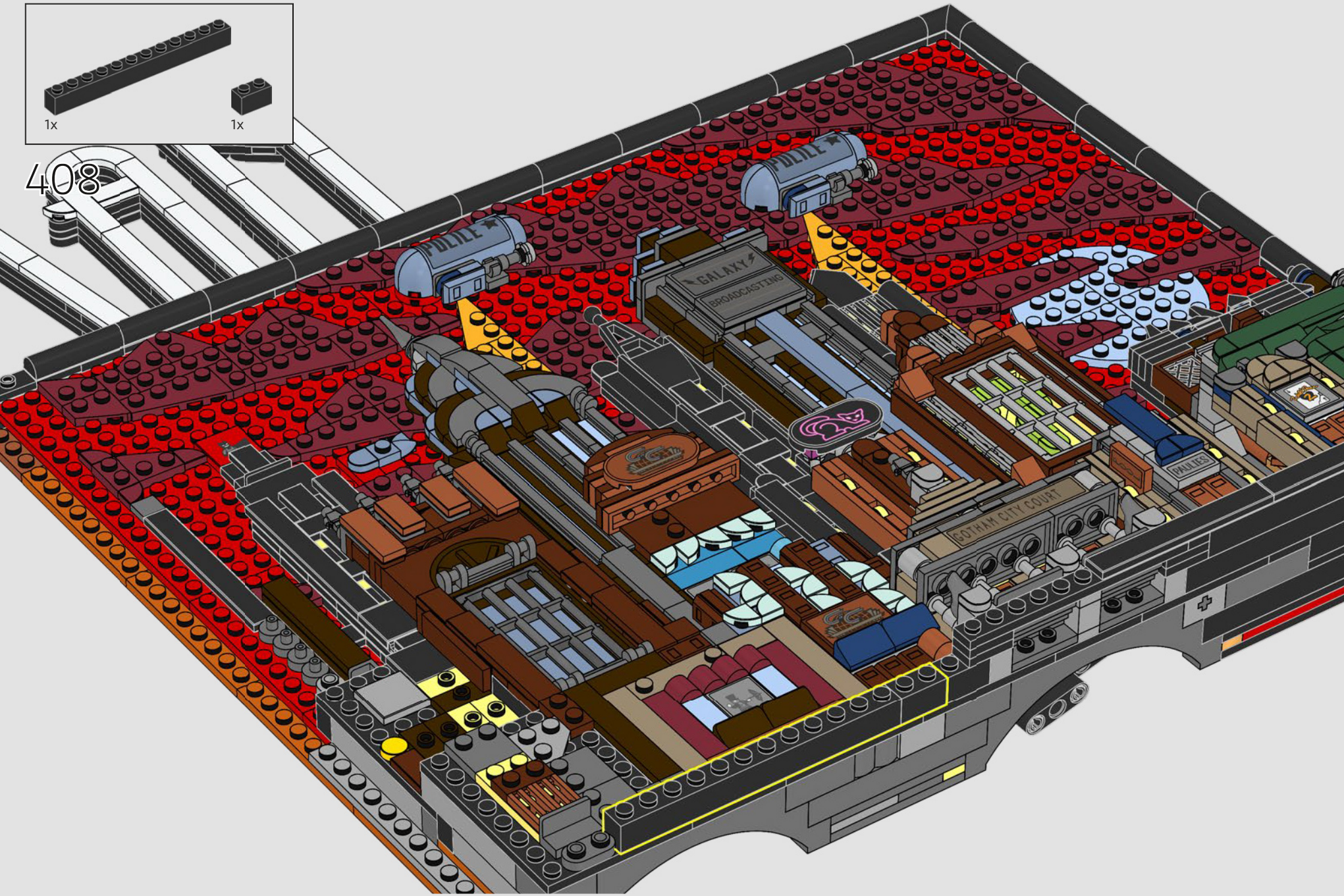

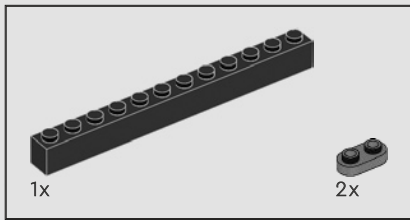

409

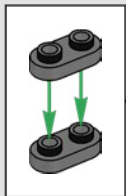
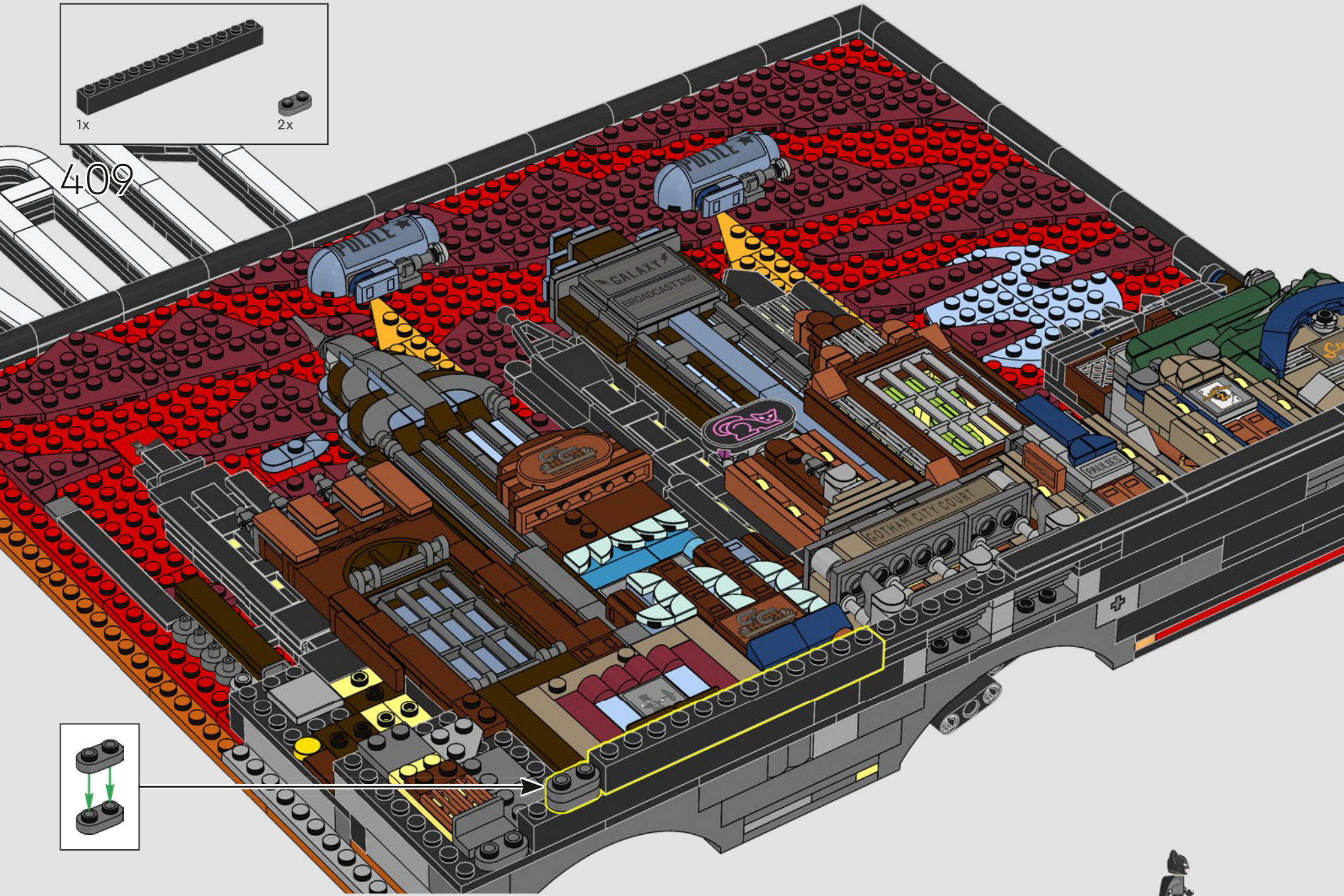

Episode: *Dreams in Darkness*
Épisode : *Sombres hallucinations*
Episodio: *Sueños en la oscuridad*

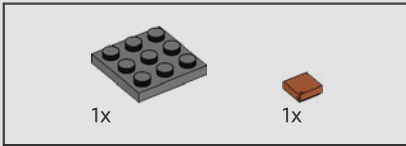
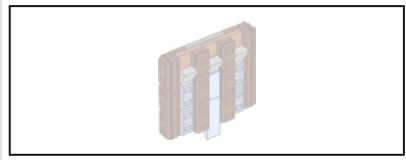

411

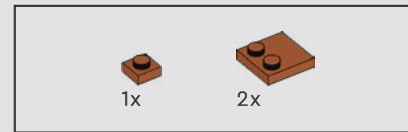
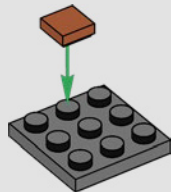

412

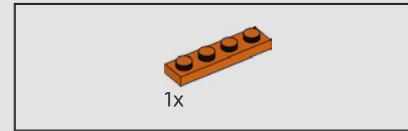
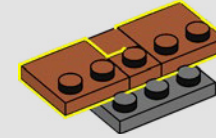

413

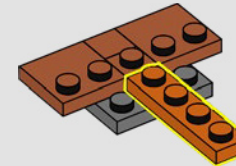

414

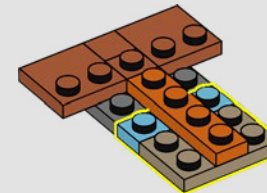

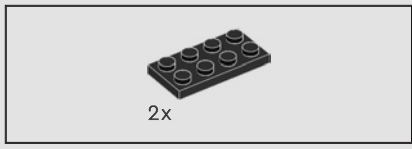

415

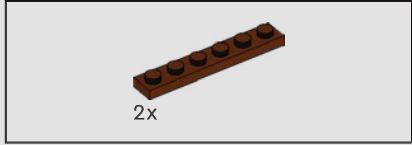
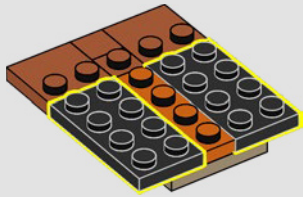

416

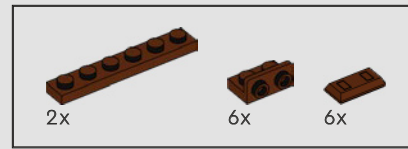
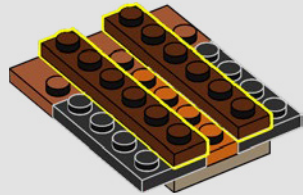

417

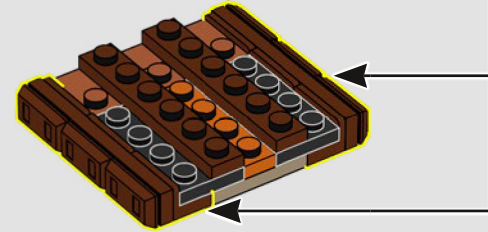
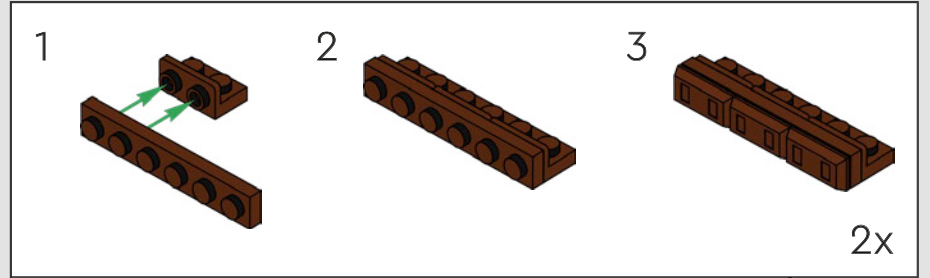

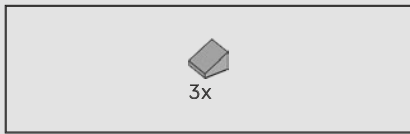

418

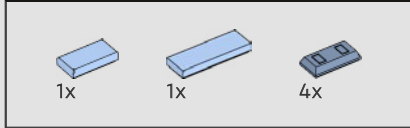
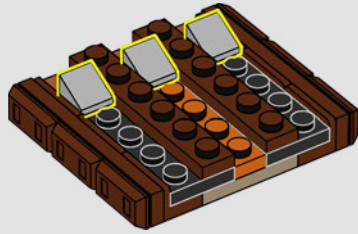

419

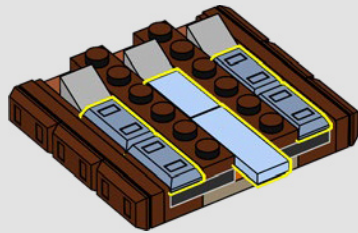

420

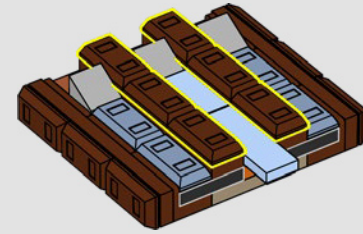

421

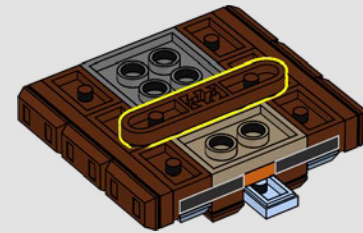

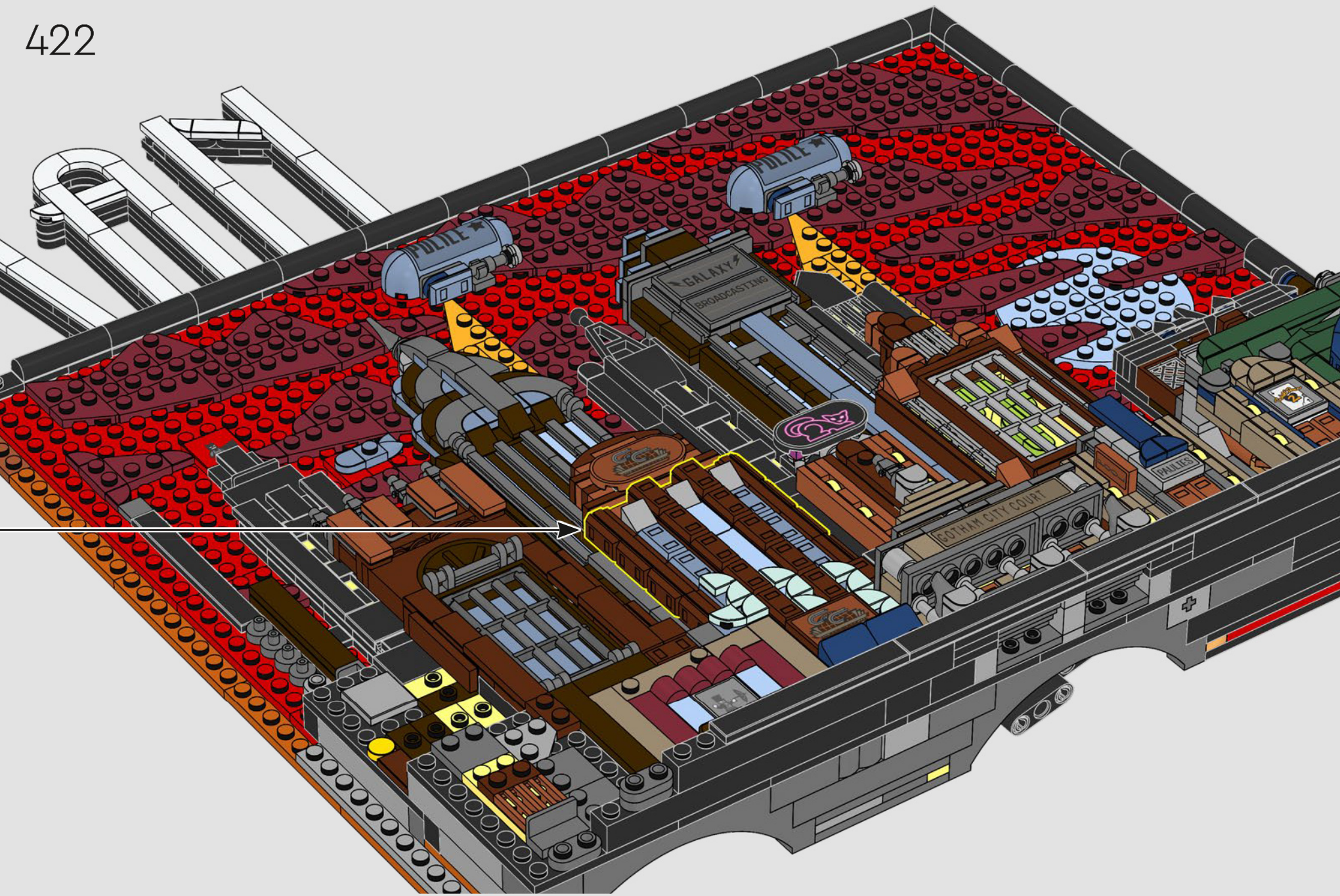

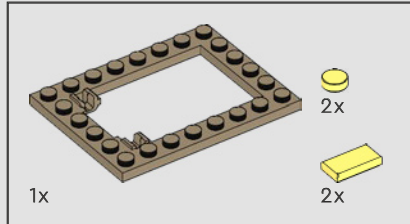
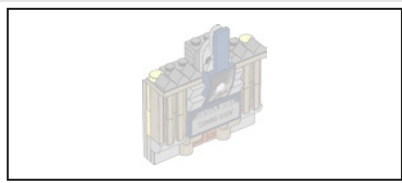

423

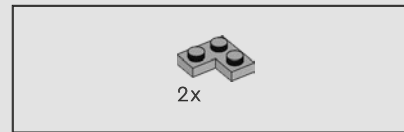
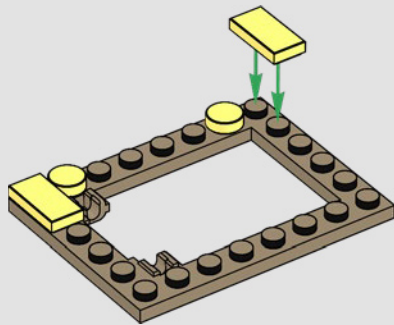

424

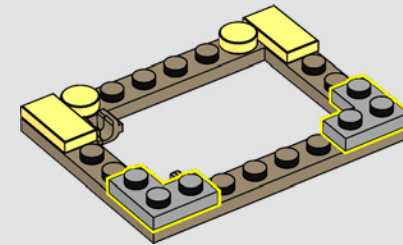

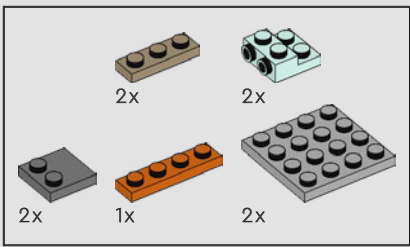

425

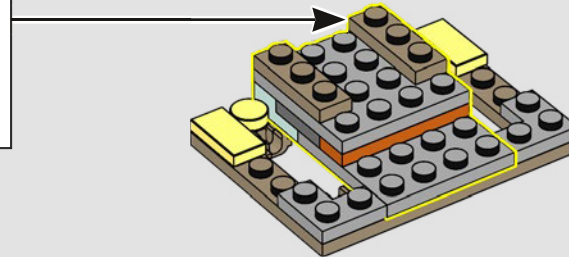
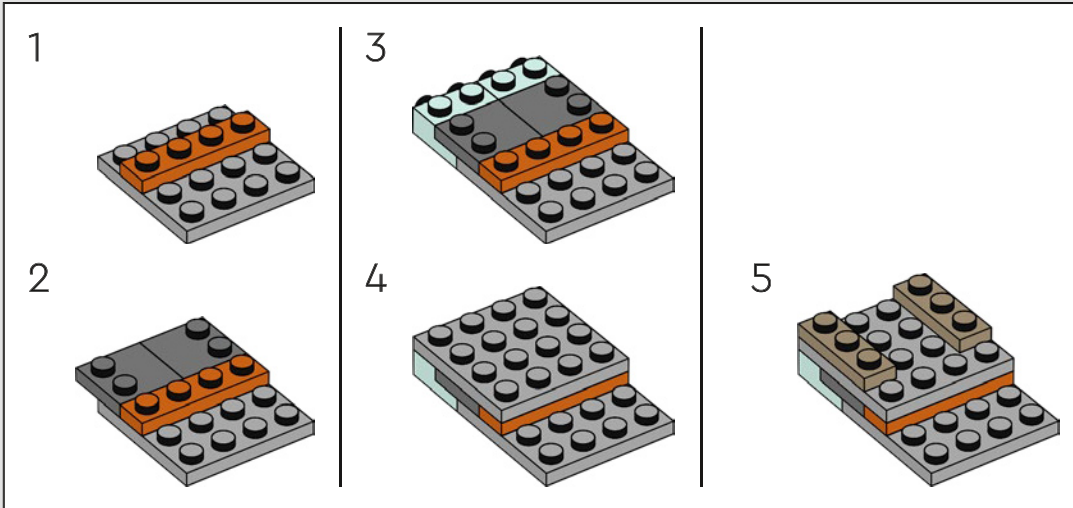

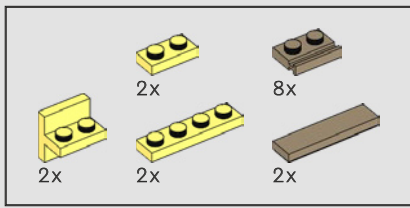

426

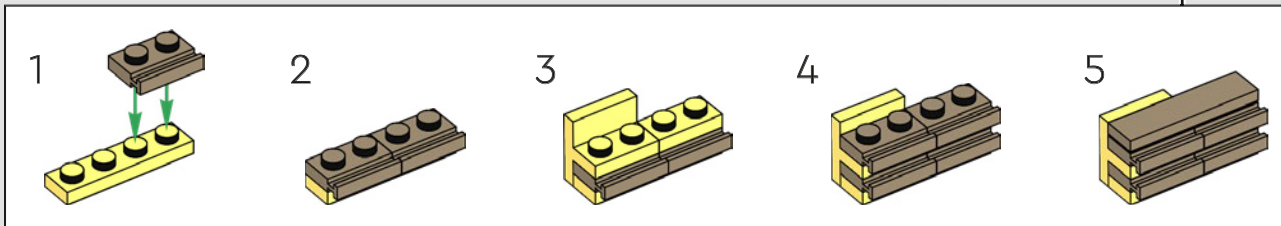
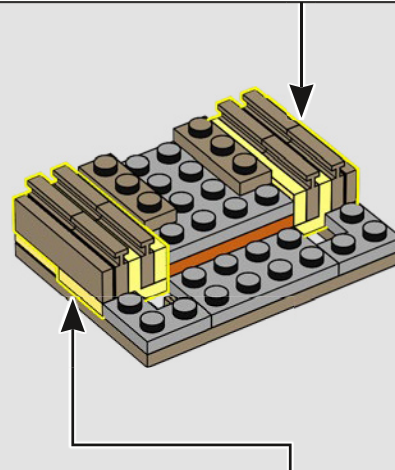
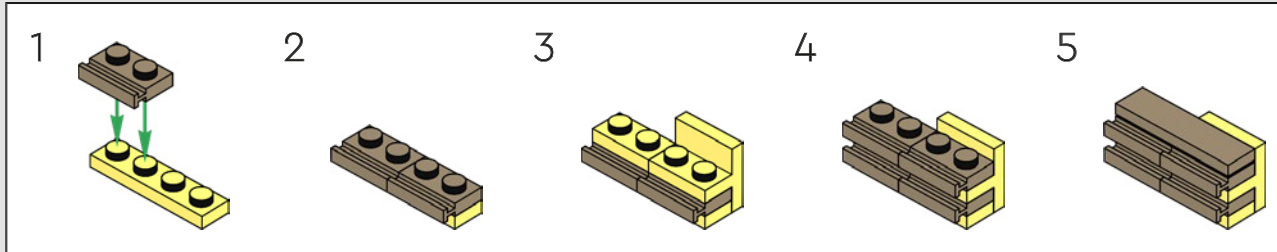

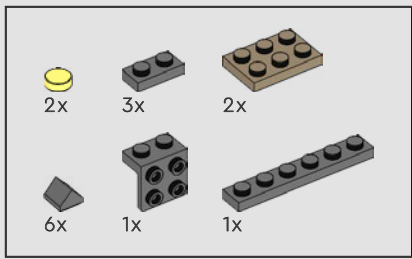

427

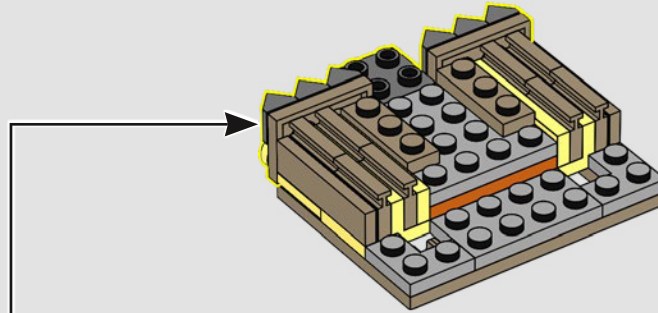
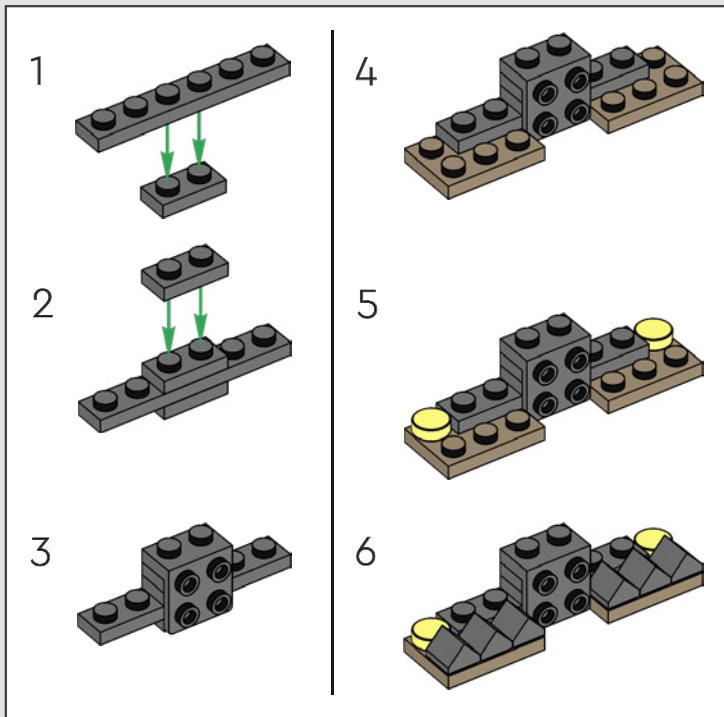

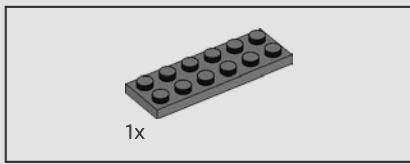

428

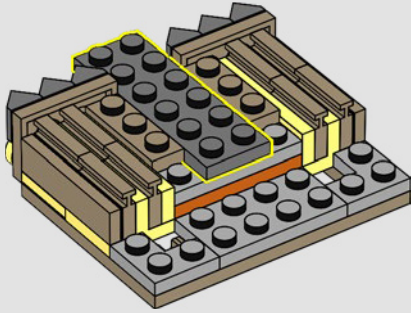

429

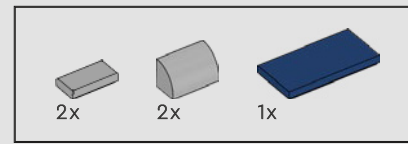
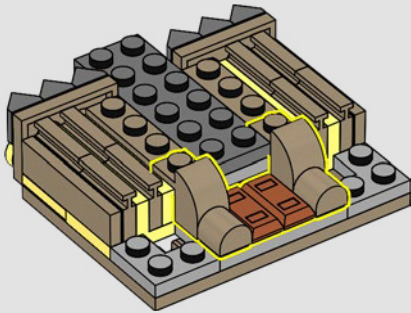

430

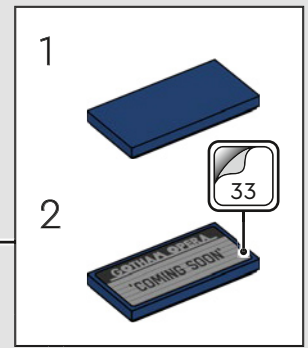
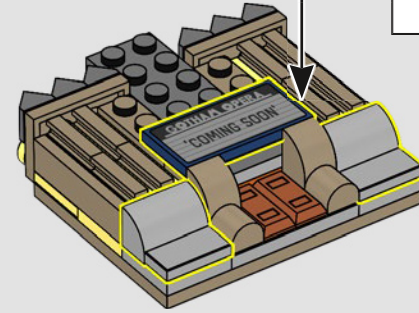

431

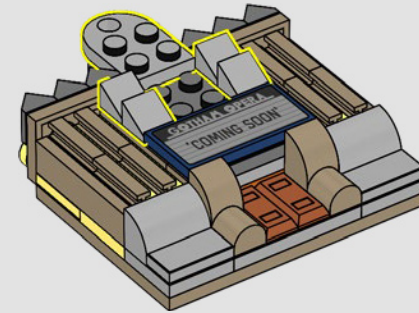

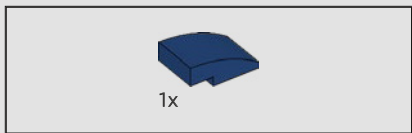

432

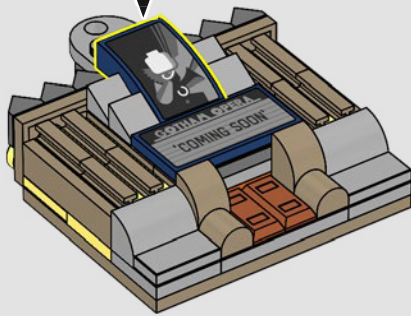
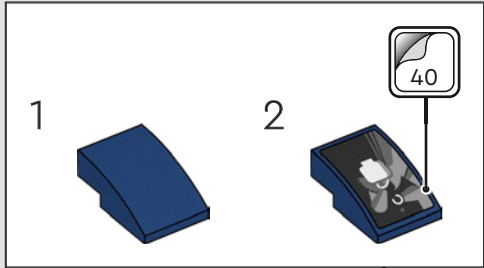

433

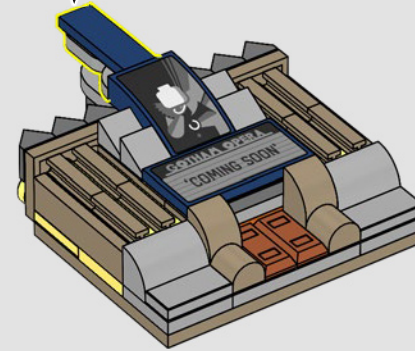
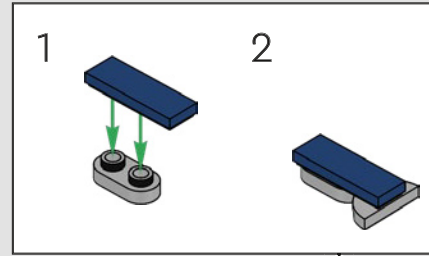

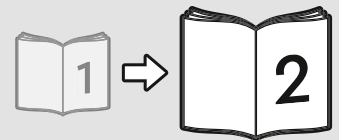
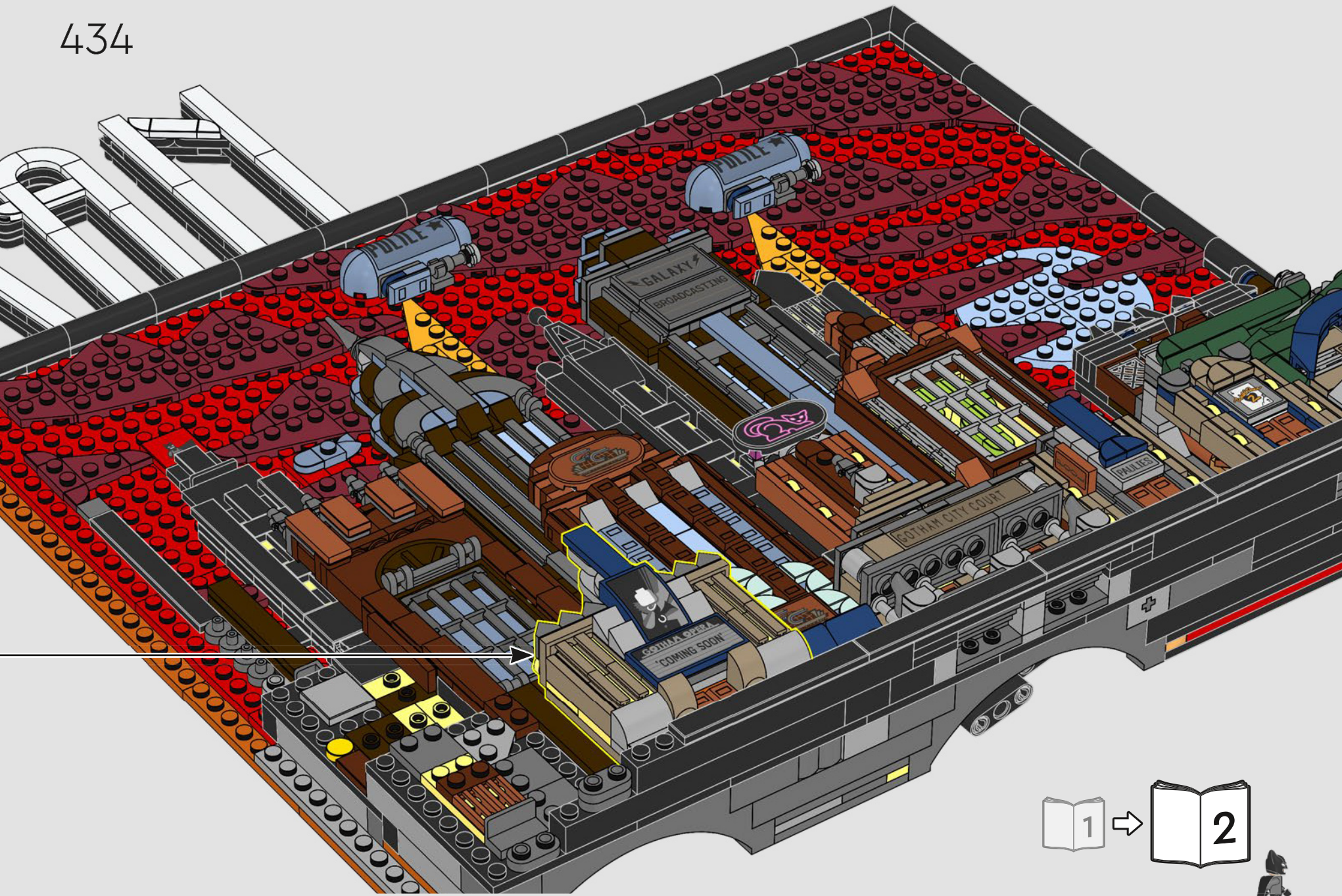

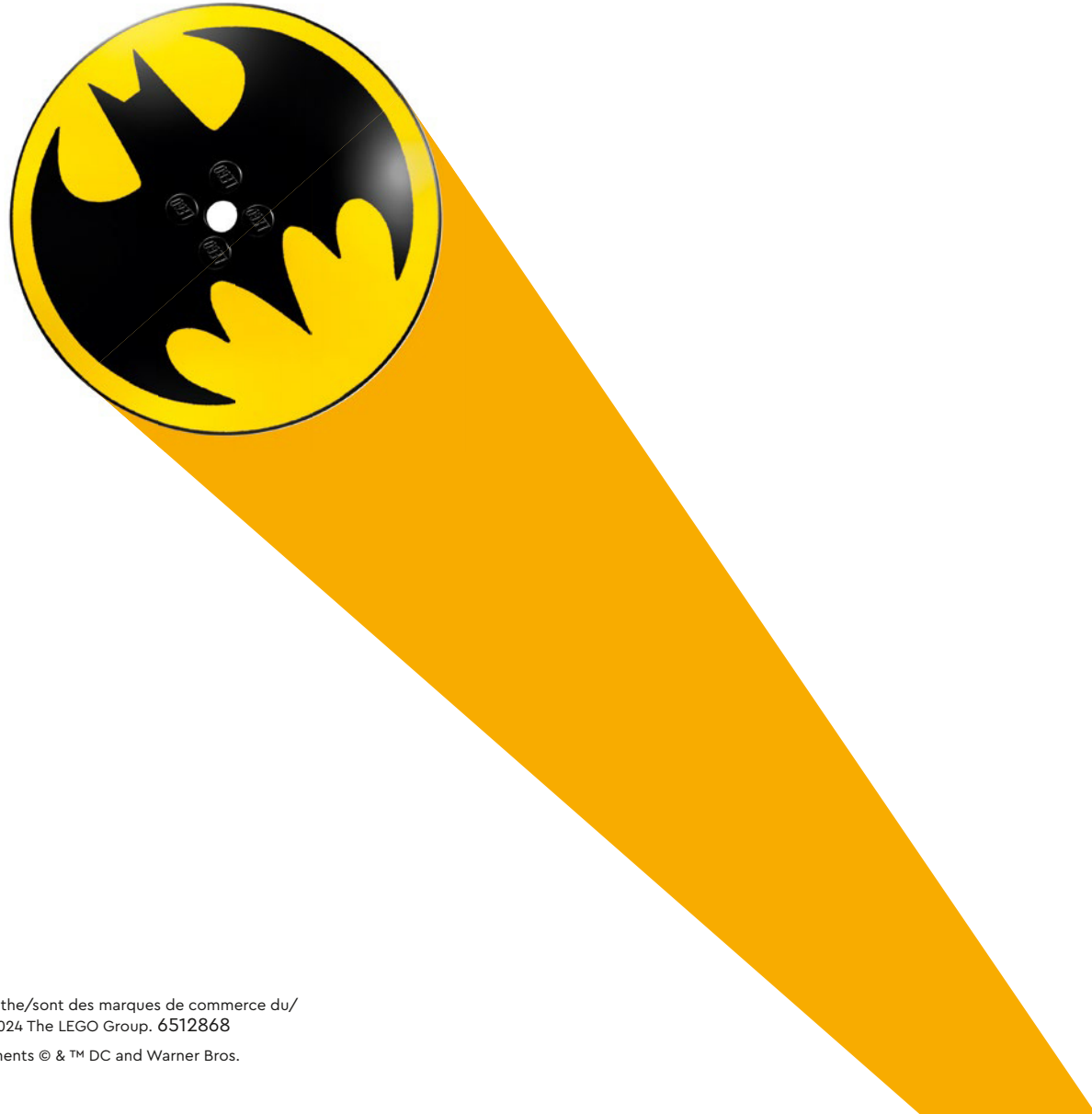

LEGO and the LEGO logo are trademarks of the/son des marques de commerce du/son marcas registradas de LEGO Group. ©2024 The LEGO Group. 6512868

BATMAN and all related characters and elements © & ™ DC and Warner Bros. and Entertainment Inc. (s24)