



76270



Q LEGO® Builder



LEGO.com/sustainable-packaging



FR
DONNEZ
OU
RECYCLEZ

 OU  OU 

ASSOCIATION MAGASIN DÉCHÈTERIE

Adresses sur quefairedemesdechets.fr



Q LEGO® Builder

BUILDER



Apple and the Apple logo are trademarks of Apple Inc., registered in the U.S. and other countries and regions. App Store is a service mark of Apple Inc. Google Play and the Google Play logo are trademarks of Google LLC. Tencent and the Tencent logo are trademarks of Tencent Inc.

Q LEGO.com/devicecheck

EN Ask parents' permission before going online | **DE** Eltern um Erlaubnis bitten, bevor du online gehst | **FR** Demande l'autorisation d'un parent avant d'aller en ligne | **IT** Chiedi il permesso ai tuoi genitori prima di andare online | **ES** Pídeles permiso a tus papás antes de conectarte a Internet | **PT** Pede autorização aos pais antes de acederes online | **ZH** 上网前应先征得父母的同意 | **PL** Poproś rodziców o zgodę, zanim wejdiesz do Internetu | **CS** Než půjdeš na internet, požádej rodiče o svolení | **SK** Skôr než pôjdeš na internet, vypýtaj si povolenie od rodičov | **HU** Kérj szülői engedélyt, mielőtt online csatlakoznál! | **RO** Cere permisiunea părinților înainte de a te conecta online | **BG** Поискайте разрешение от родител, преди да влезете онлайн | **LV** Pirms došanās tiešsaistē palūdz atļauju vecākiem | **ET** Enne Interneti kasutamist küsi vanematelt luba | **LT** Prieš prisijungdami prie interneto, atsiklauskite tėvų





1

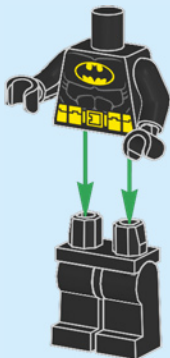

2



3

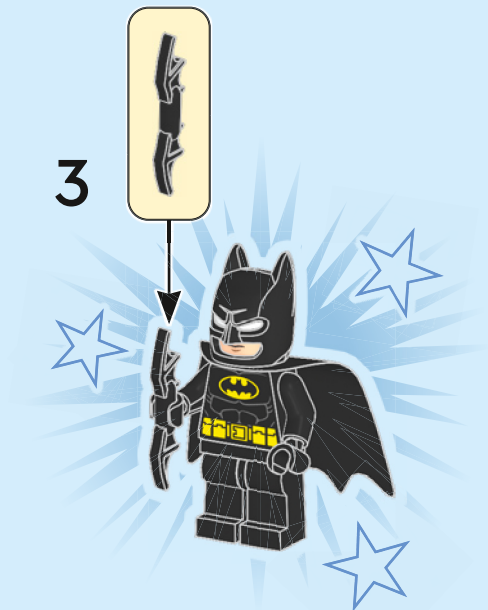

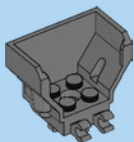

1x

1

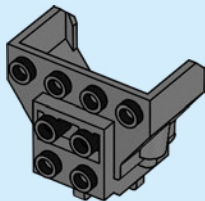

6





2x

2

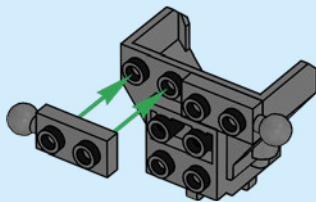

1x



1x

3

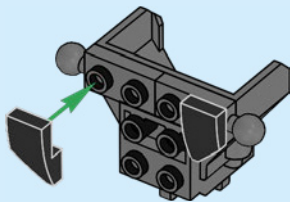

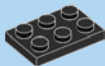

1x

4

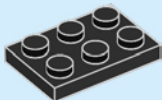

8





2x

5

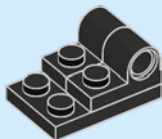

1x

6

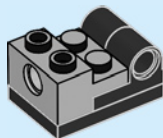



1x

7

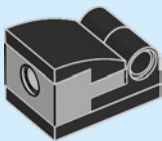

10



2x

8

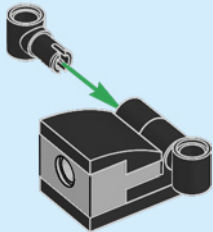

1x

9

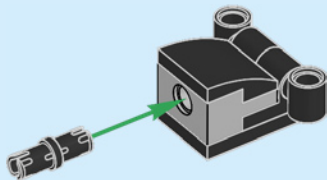

10

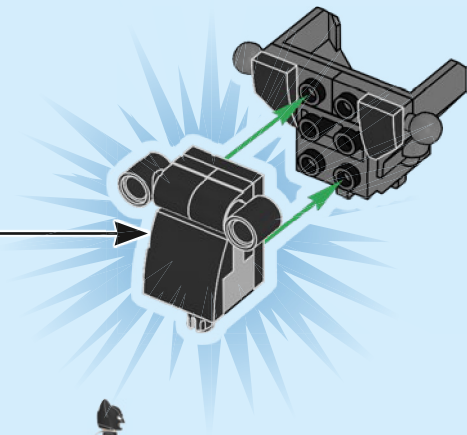

12





11

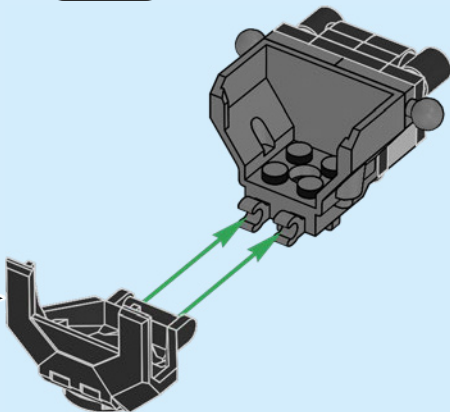
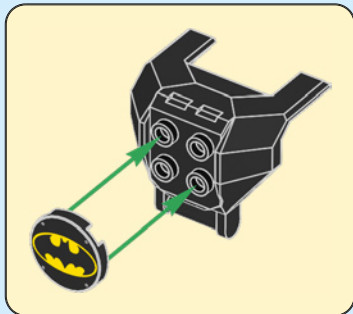



1x

12

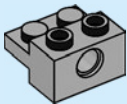

14



1x

13

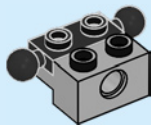



2x

14

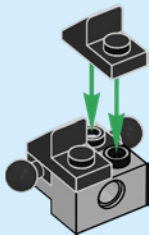

2x

15

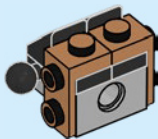



1x

16

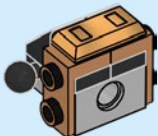



2x

17

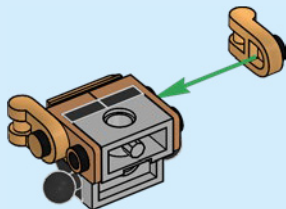

2x

18

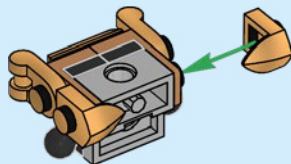



2x

19

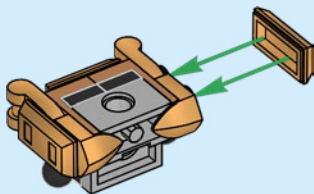

1x

20

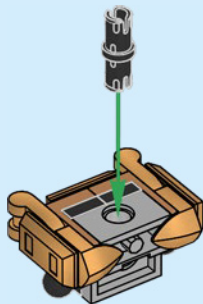

21

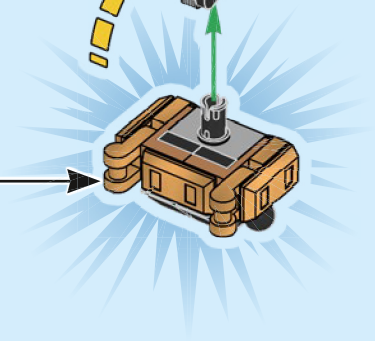
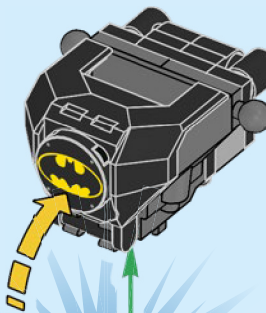

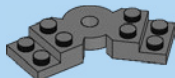

1x

22

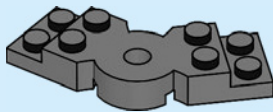



2x

23

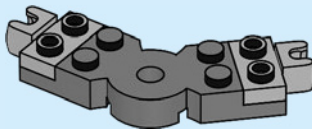

1x

24

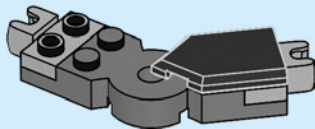



1x

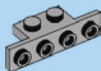

1x

25

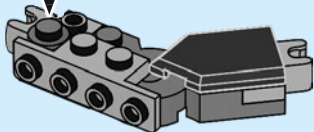



1x



1x

26

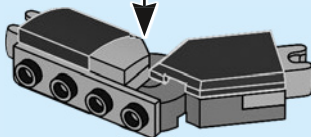

1x



1x

27

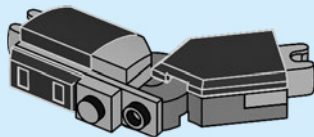



1x

28

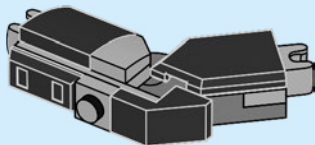

24



1x



1x

29

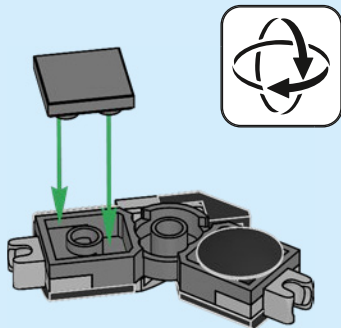

30

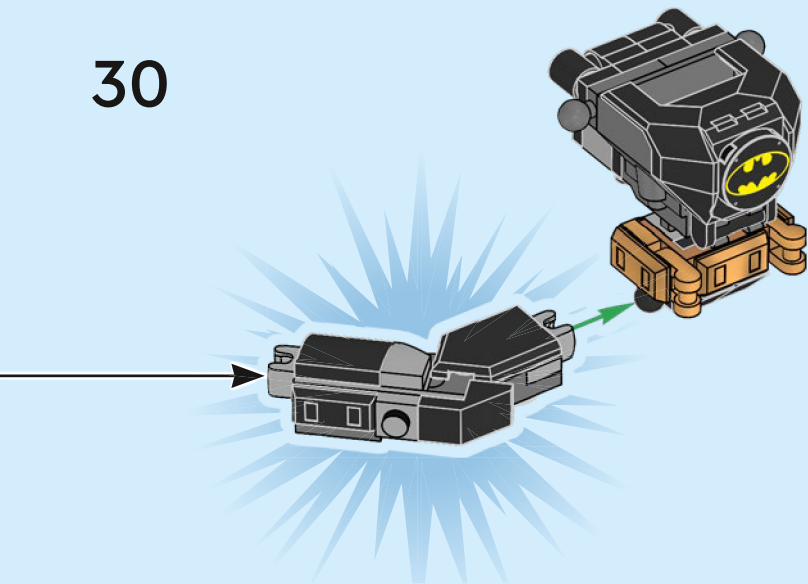

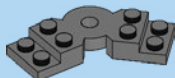

1x

31

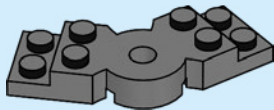



2x

32

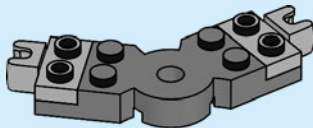

1x

33

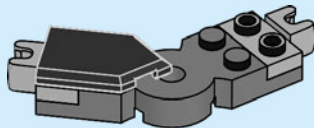



1x

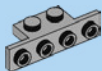

1x

34

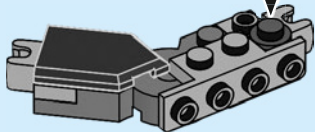



1x



1x

35

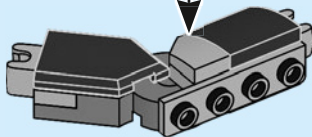

1x



1x

36

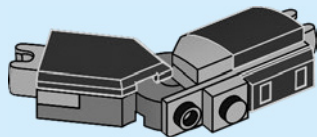



1x

37

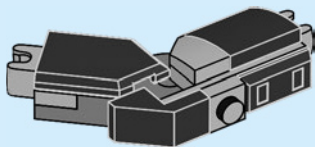

30



1x



1x

38

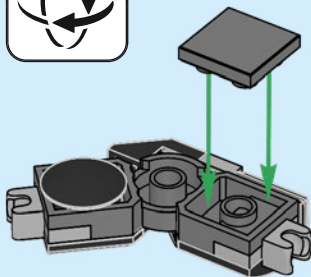

39

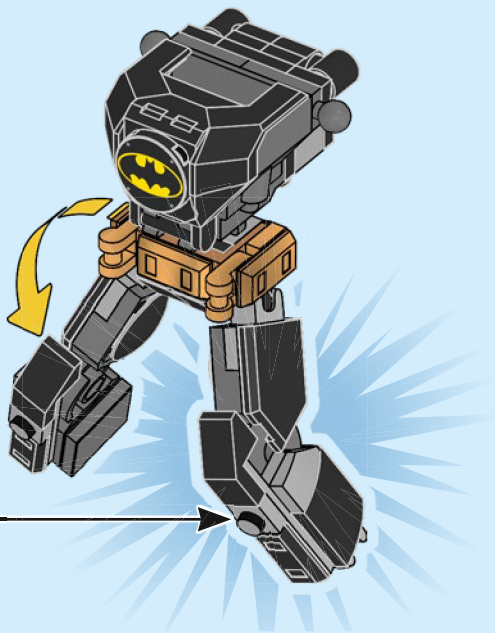

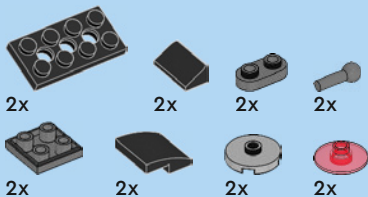

40

1

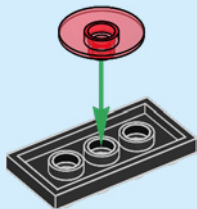

2

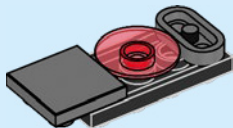

3

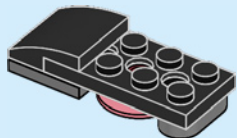

4

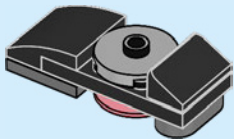

5

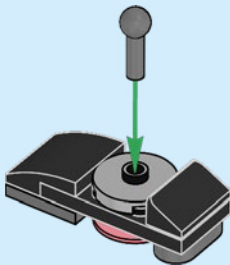

2x



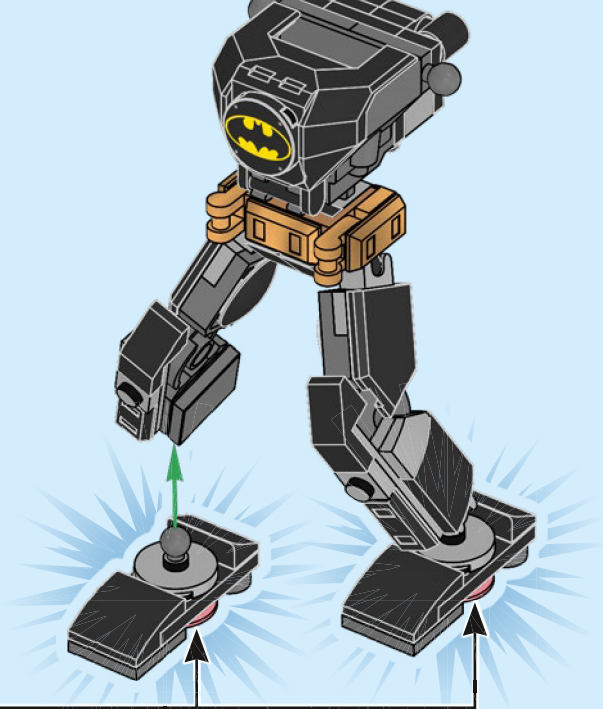

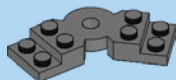

1x

41

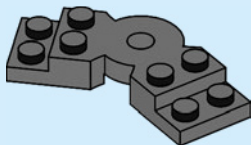



1x



1x

42

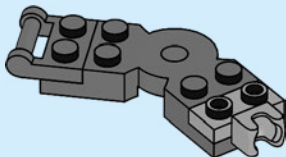



1x



1x



1x

43

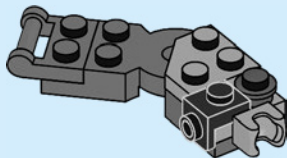



1x



1x

44

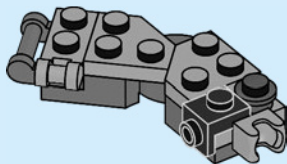



1x

45

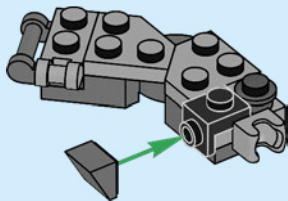



1x



1x

46

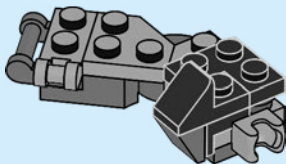



1x

47

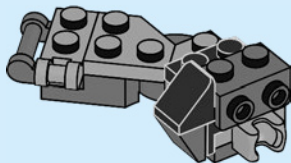



2x

48

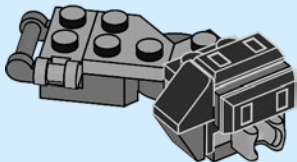

1x



1x

49

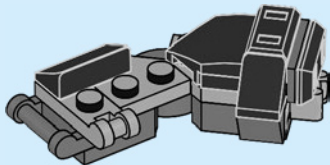

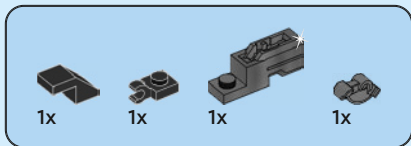

50

1

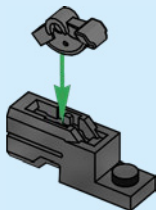

2

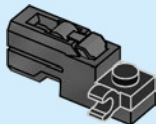

3

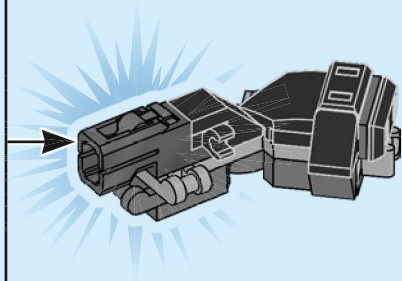
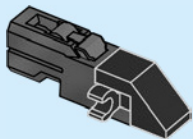



3x

51

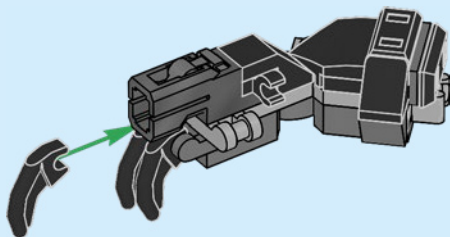



1x

52

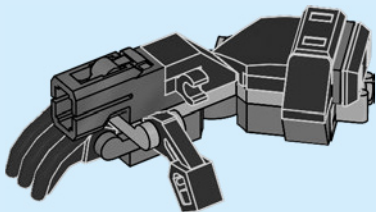



1x

53

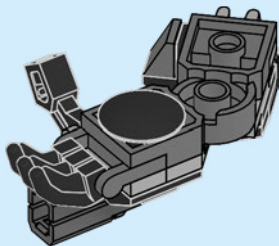

54

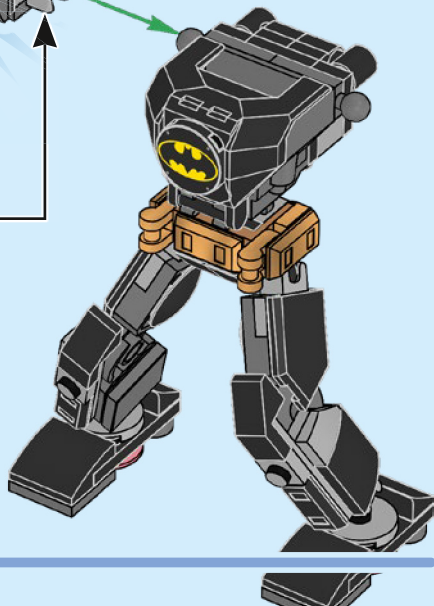
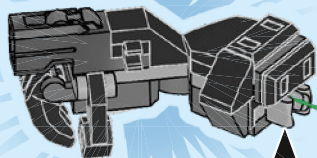

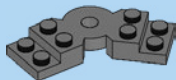

1x

55

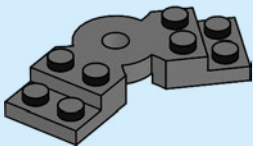



1x

56

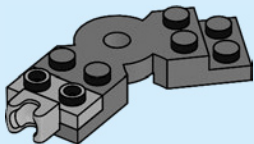

1x



1x



1x

57

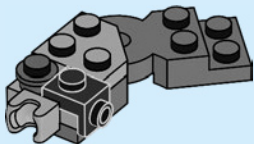



1x

58

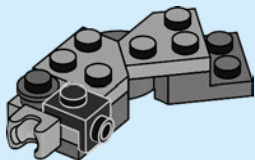



1x

59

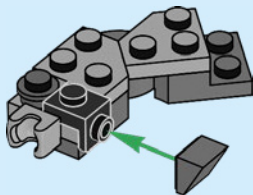



1x



1x

60

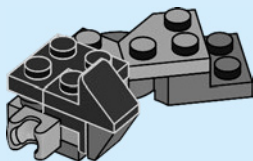



1x

61

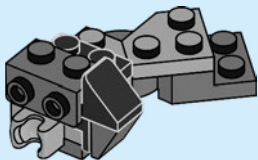

2x

62

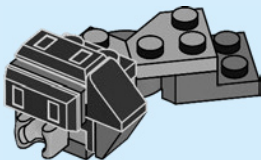



1x

63

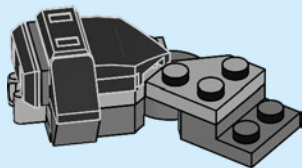



1x

64

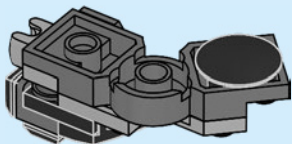

1x



1x

65

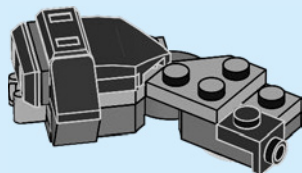



1x

66

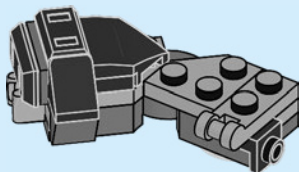



1x

67

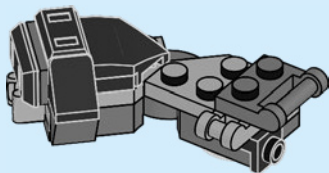

1x

68

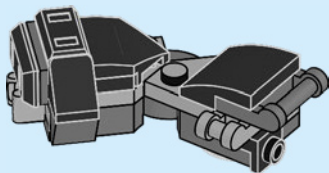



3x

69

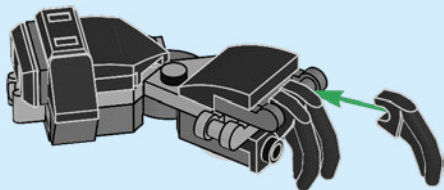

1x

70

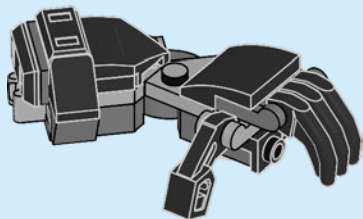

71

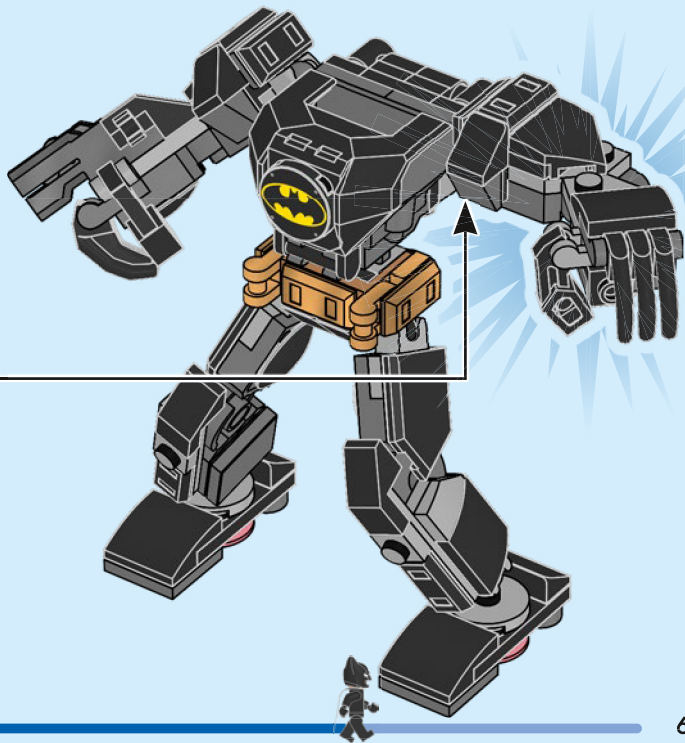

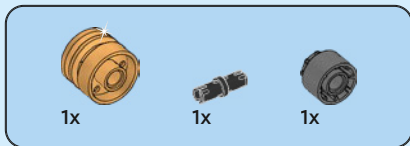

72

1



2

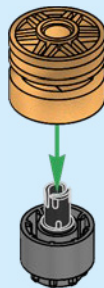

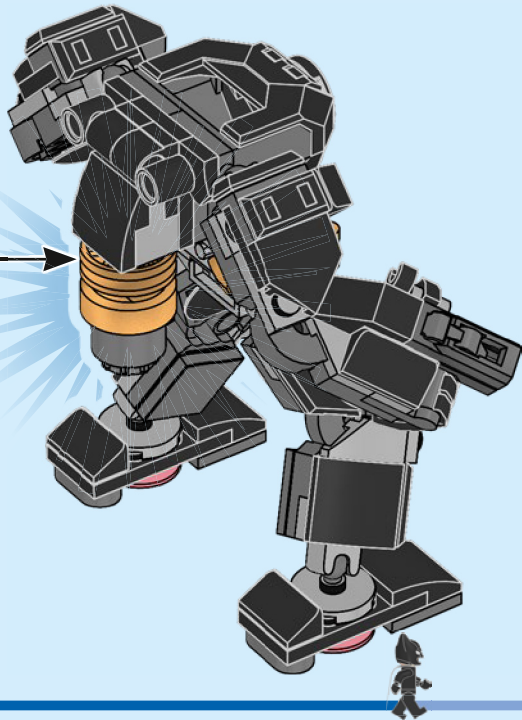

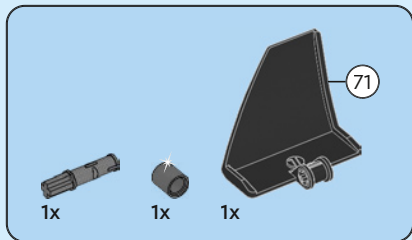

73

1

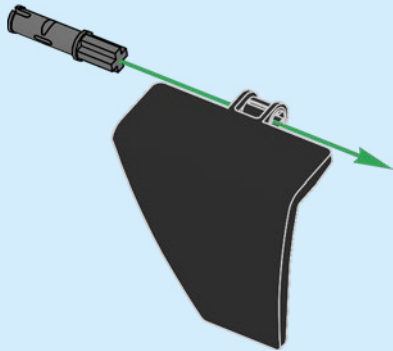

2

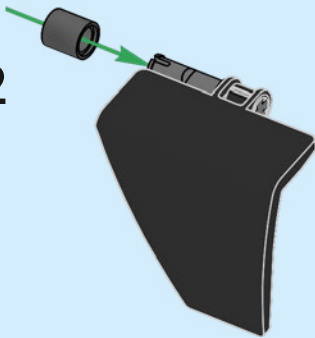

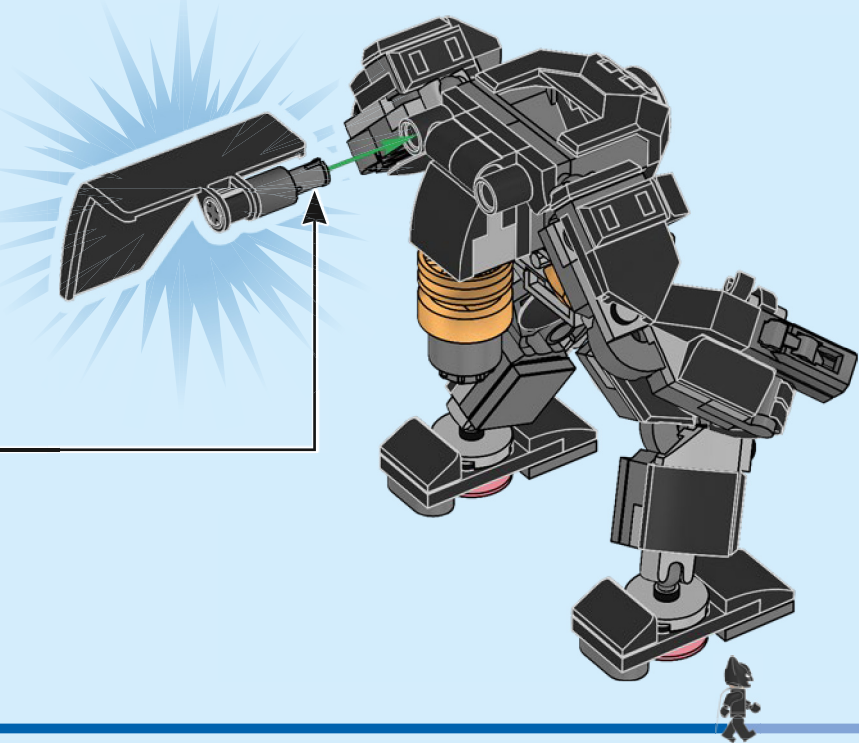

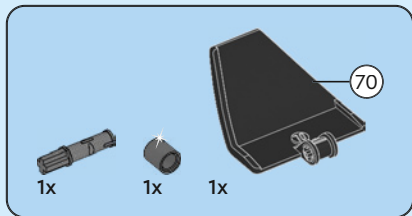

74

1

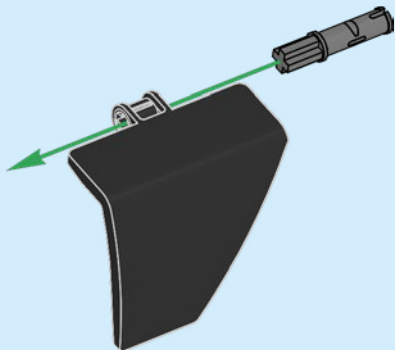

2

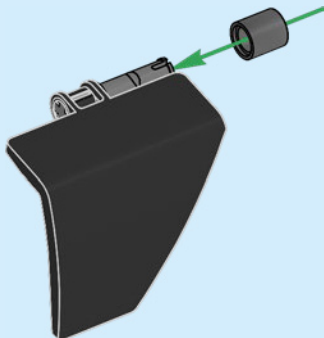

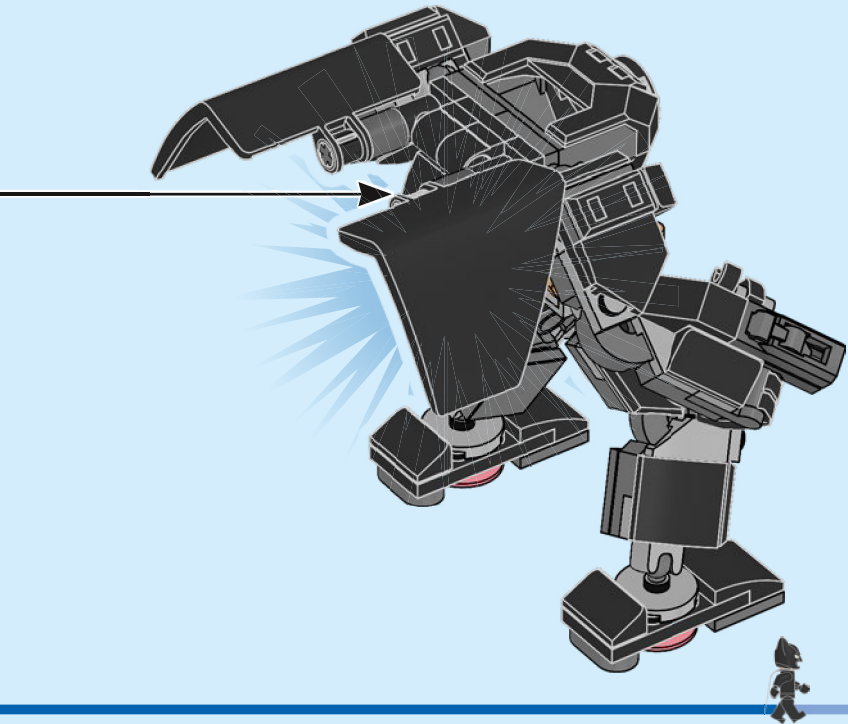



2x



1x



1x

75

1

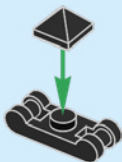

2

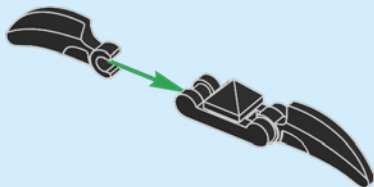

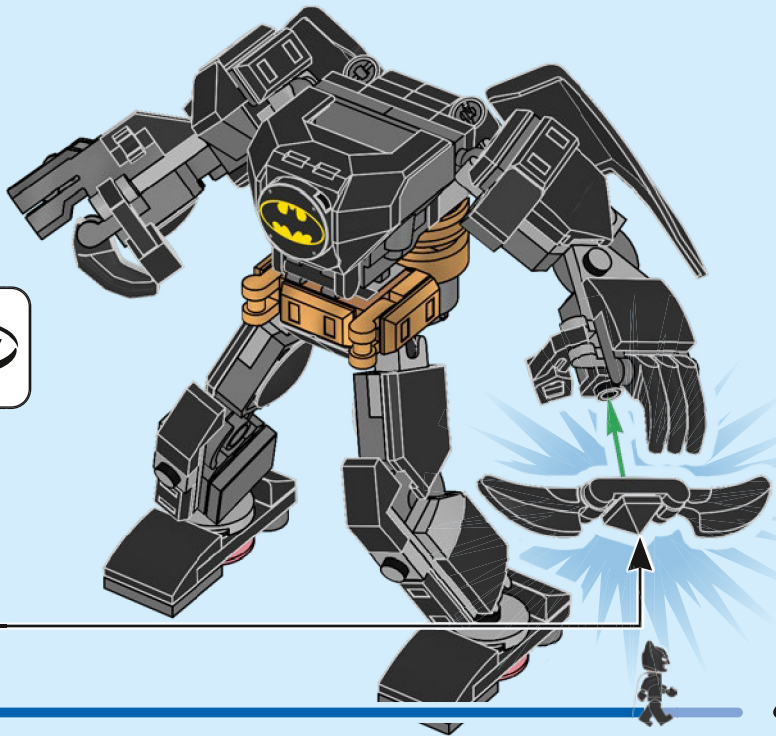

76

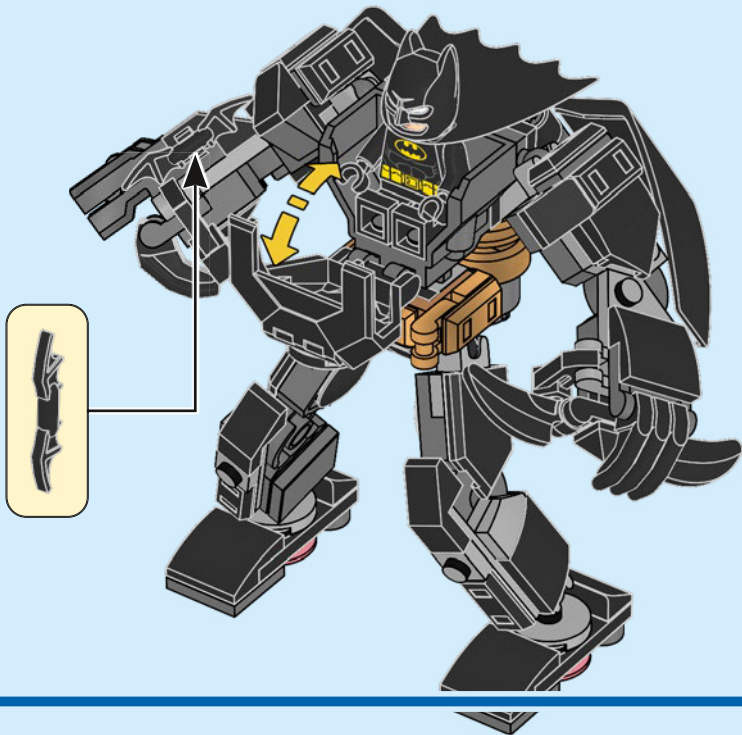



2x

77

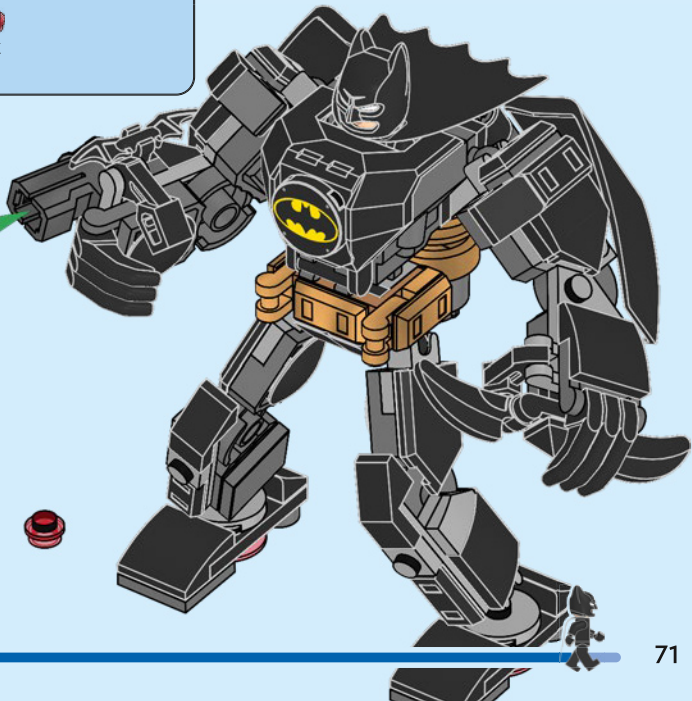

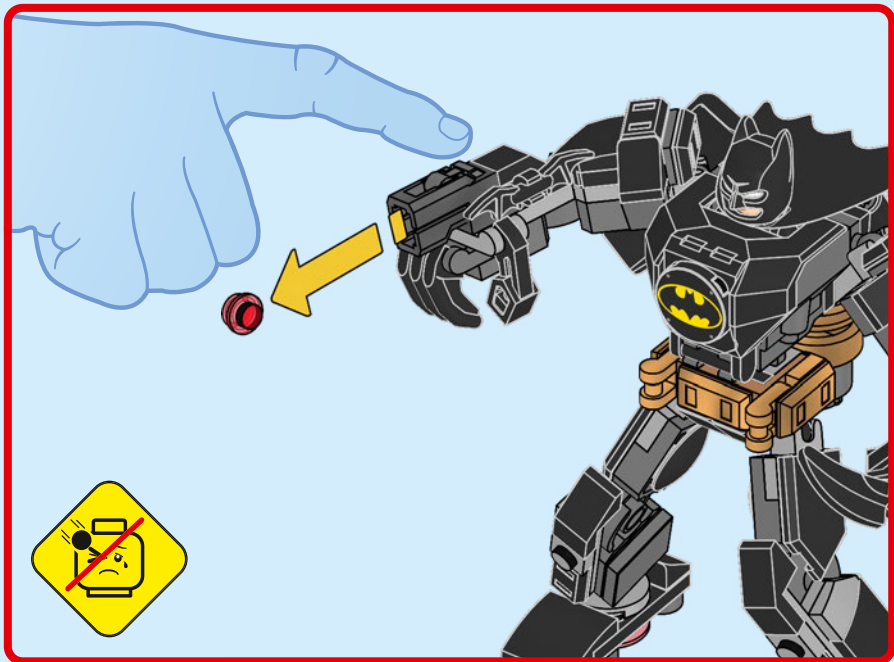

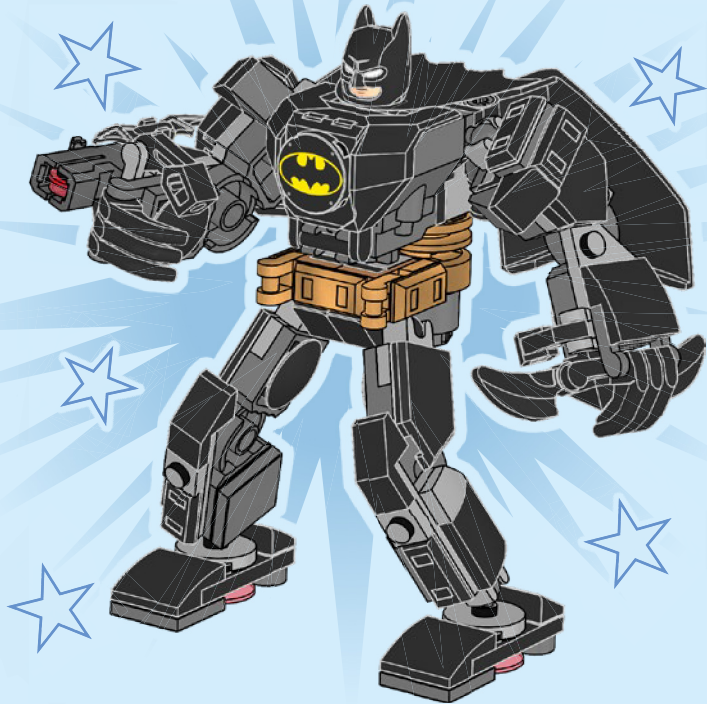



4x
6038201



1x
6225142



2x
6168615



1x
6308000



2x
6282140



6x
6156991



2x
6236395



2x
6183782



6x
6420198



1x
6181713



1x
9339



3x
6267487



1x
6345952



4x
6186657



1x
6181720



3x
4548180



2x
6276867



2x
6254273



2x
6208450



6x
6043656



1x
6312449



1x
6488960



2x
6114987



1x
6398391



2x
6245303



2x
6326478



3x
6299338



3x
6279875



2x
6308912



6x
6053077



3x
4211399



2x
4515369



1x
6421732



4x
4278359



4x
6069000



2x
242026



2x
6245251



2x
370926



2x
6083975



2x
6221607



2x
6123814



1x
6384443



1x
6174029



1x
6215542



2x
6212377



1x
6484624



4x
6013082



1x
6416838



71

1x
6362555



3x
6207933



2x
4504378



2x
6015356



4x
6395097



1x
4650620

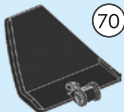

70

1x
6362554



1x
6109685



2x
6214341



2x
6146321



1x
302126



1x
6258524



2x
6474266



2x
6364352



1x
6288460



1x
6360675



 LEGO.com/service

YOU COULD
WIN



Scan this QR code or go to
LEGO.COM/PRODUCTFEEDBACK and give us
your short feedback about this LEGO® set
for a chance to win a cool LEGO prize.

Terms and Conditions apply*



EN: YOU COULD WIN. Terms and Conditions apply* **DE: Du könntest GEWINNEN.** Es gelten die Teilnahmebedingungen* **FR: Tu pourrais GAGNER.** Des conditions s'appliquent* **IT: Potresti VINCERE tu.** Termini e condizioni sono applicabili* **ES: Puedes GANAR.** Aplican términos y condiciones* **PT: Poderá GANHAR.** Aplicam-se termos e condições* **ZH: 轻松获奖.** 条款和条件适用* **PL: Szansa na WYGRANĄ.** Obowiązują warunki korzystania* **CS: Máte šanci VYHRÁT.** Platí všeobecné smluvní podmínky* **SK: Máte šancu VYHRÁT.** Platia všeobecné zmluvné podmienky* **HU: TE IS NYERHETSZ.** Felhasználási feltételek érvényesek* **RO: Ai putea CÂȘTIGA.** Se aplică termenii și condiții* **BG: Можете да СПЕЧЕЛИТЕ.** Има определени правила и условия* **LV: Tu vari LAIMĒT.** Ir spēkā noteikumi un nosacījumi.* **ET: Sul on võimalus VÕITA.** Kehtivad tingimused* **LT: Jūs galite LAIMĖTI.** Taikomos sąlygos*

*[LEGO.com/productfeedback-terms](https://www.lego.com/productfeedback-terms)

LEGO and the LEGO logo are trademarks of the LEGO Group. ©2024 The LEGO Group.
BATMAN and all related characters and elements © & TM DC (s24)

6522943