



MARVEL

76241





Get excited about our new packaging!

We're switching from plastic to paper-based packaging. That's why you might find a mix of paper and plastic in our boxes!

Nos nouveaux emballages vous emballeront !

Nous passons des emballages en plastique aux emballages à base de papier. C'est pourquoi vous pourriez trouver un mélange de papier et de plastique dans nos boîtes !

¡Te presentamos nuestros nuevos empaques!

Estamos sustituyendo las bolsas de plástico por bolsas con base de papel. ¡Por eso, puedes encontrar una mezcla de papel y de plástico en nuestras cajas!

[LEGO.com/sustainable-packaging](https://www.lego.com/sustainable-packaging)



BUILDER



Apple and the Apple logo are trademarks of Apple Inc., registered in the U.S. and other countries and regions. App Store is a service mark of Apple Inc. Google Play and the Google Play logo are trademarks of Google LLC. Tencent and the Tencent logo are trademarks of Tencent Inc.

 LEGO.com/devicecheck

EN Ask parents' permission before going online | **DE** Eltern um Erlaubnis bitten, bevor du online gehst | **FR** Demande l'autorisation d'un parent avant d'aller en ligne | **IT** Chiedi il permesso ai tuoi genitori prima di andare online | **ES** Pídeles permiso a tus papás antes de conectarte a Internet | **PT** Pede autorização aos pais antes de acederes online | **JA** オンラインになる前に ほご者の方のきよかをもらおう | **ZH** 上网前应先征得父母的同意 | **KO** 온라인 접속 전에 보호자 동의가 필요합니다 | **RU** Спроси разрешения у родителей, прежде чем заходить в интернет | **PL** Poproś rodziców o zgodę, zanim wejdiesz do Internetu | **CS** Než půjdeš na internet, požádej rodiče o svolení | **SK** Skôr než pôjdeš na internet, vypýtaj si povolenie od rodičov | **HU** Kérj szülői engedélyt, mielőtt online csatlakoznál! | **RO** Cere permisiunea părinților înainte de a te conecta online | **BG** Поискайте разрешение от родители, преди да влезете онлайн | **LV** Pirms došanās tiešsaistē palūdz atļauju vecākiem | **ET** Enne Interneti kasutamist küsi vanematelt luba | **LT** Prieš prisijungdami prie interneto, atsiklauskite tėvų



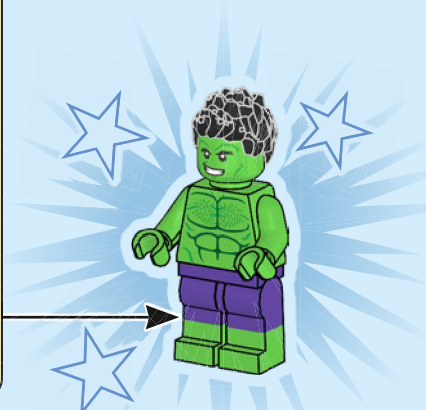
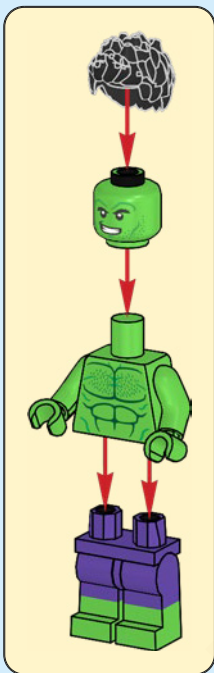

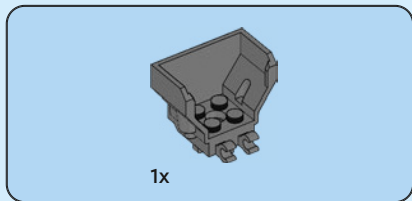

1

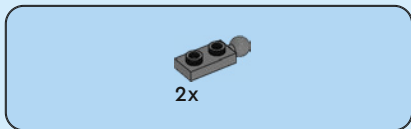
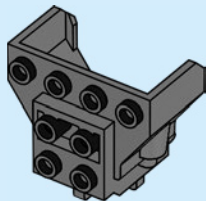

2

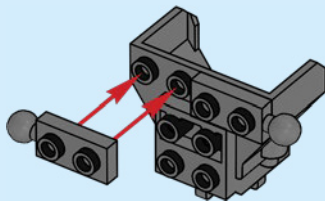

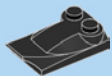

1x

3

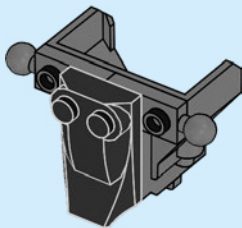

6





1x



2x

4

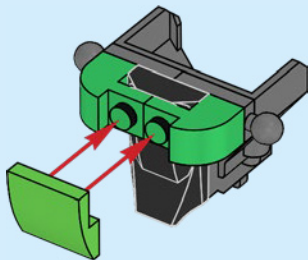

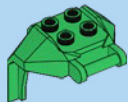

1x



1x

5

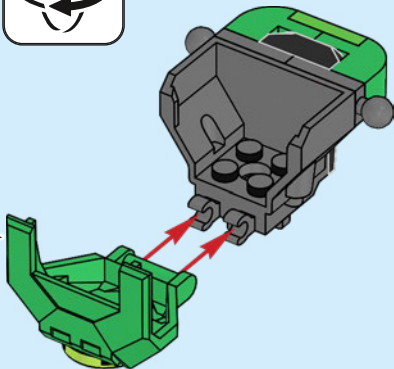
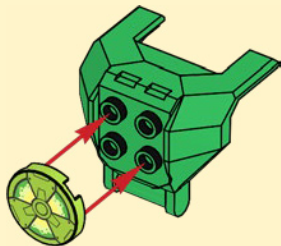

6





1x

7

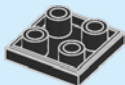

10





1x

8

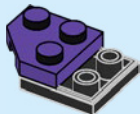

1x

9

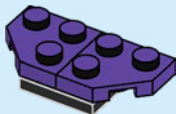



1x

10

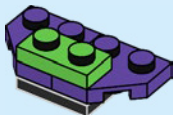

12





1x

11

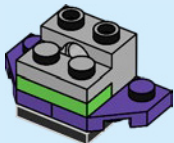

2x

12

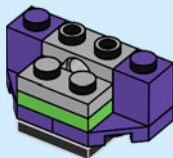



1x

13

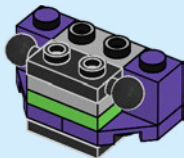

14





1x

14



2x

15

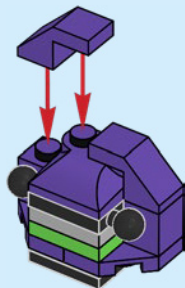



1x

16

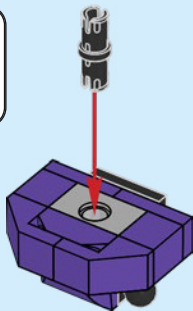

16



17

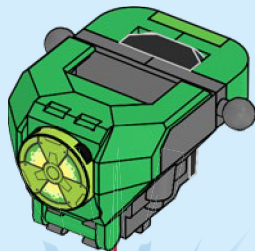



1x

18





2x

19

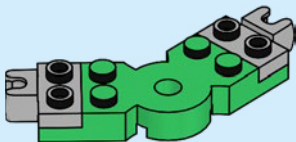

1x



1x

20

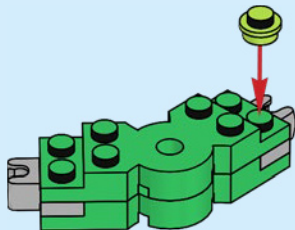



1x



1x

21

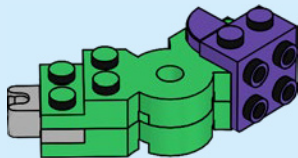

20





1x



1x

22

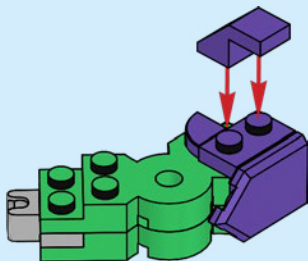

1x

23

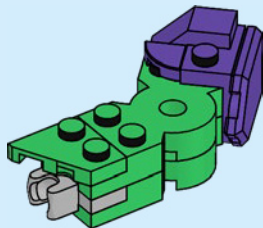



1x

24

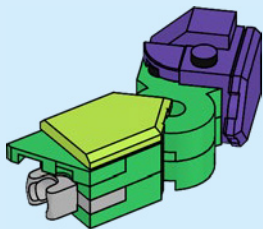

25

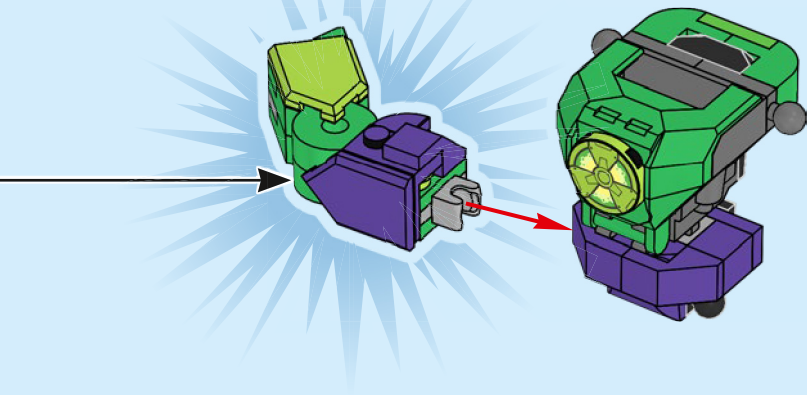



1x

26

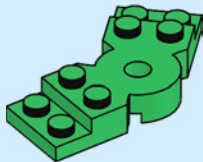



2x

27

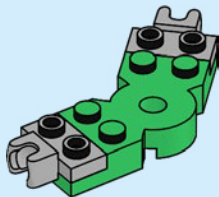

1x



1x

28

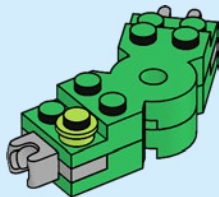



1x



1x

29

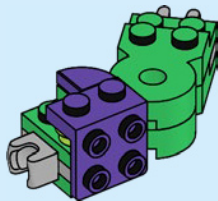



1x



1x

30

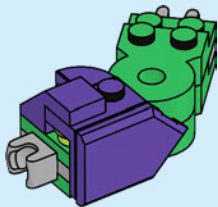

1x

31

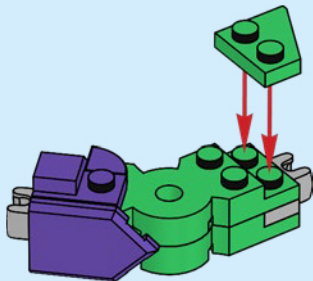



1x

32

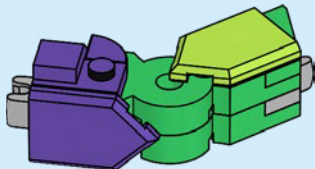

33

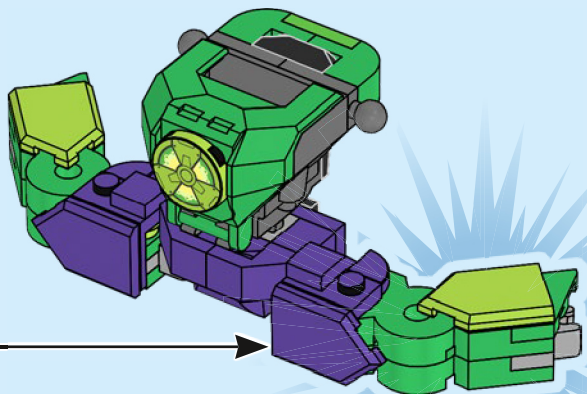

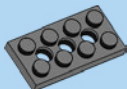

1x

34

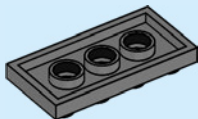



1x



1x

35

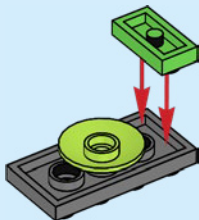

1x

36

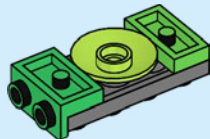



2x



1x

37

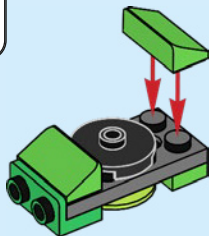



2x

38

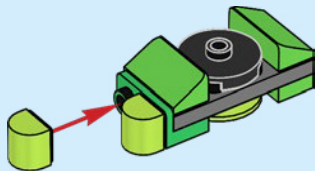

1x

39

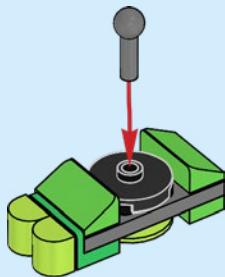

2x

40

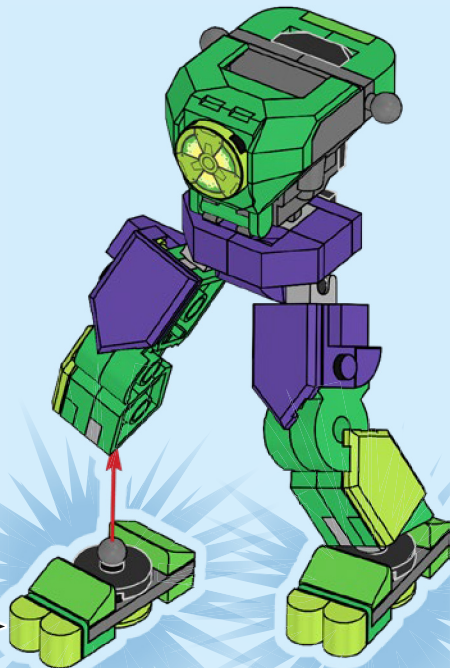



1x

41

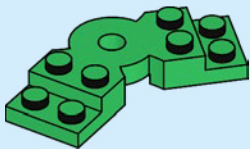

1x



1x

42

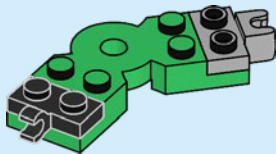



1x



1x

43

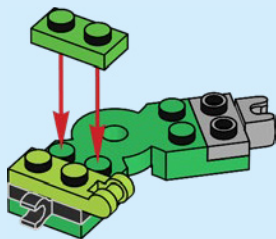



1x



1x

44

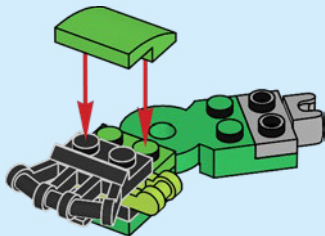

1x

45

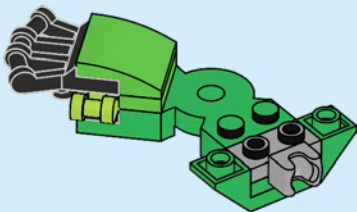



2x

46

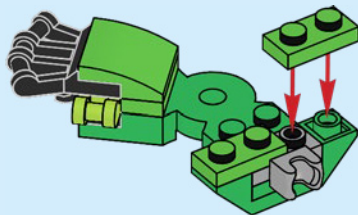



1x

47

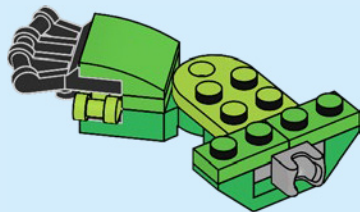

1x

48

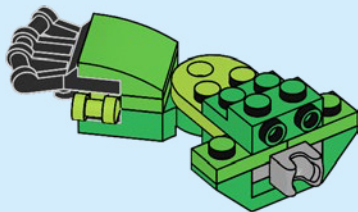



1x

49

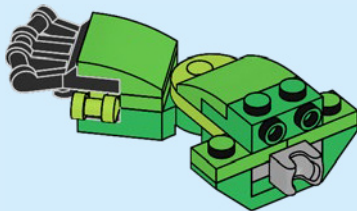



2x

50

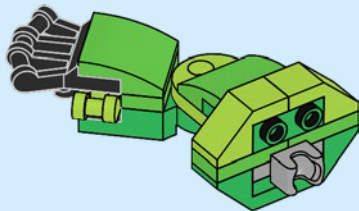



2x

51

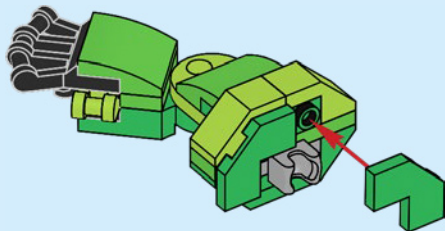



8x



4x



4x

52

1

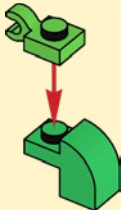

2

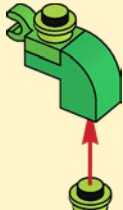

4x

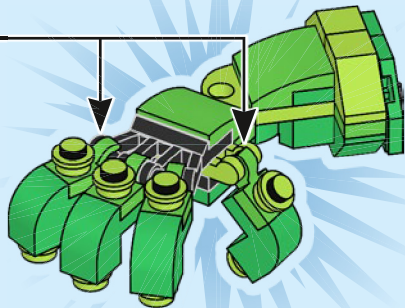

53

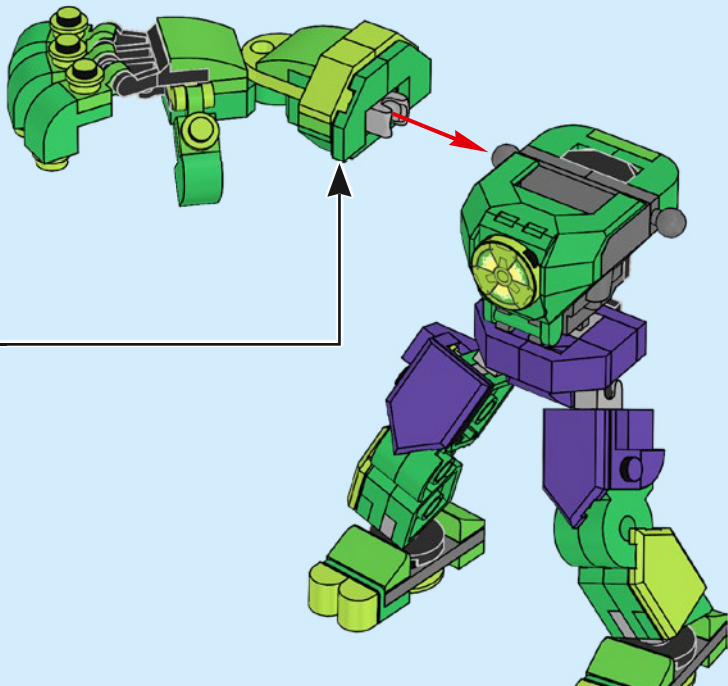



1x

54

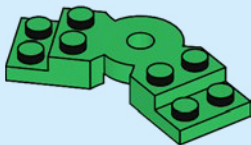



1x



1x

55

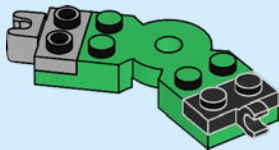



1x



1x

56

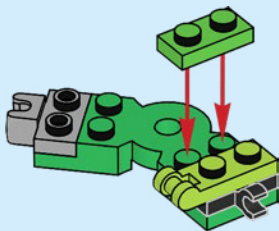



1x



1x

57

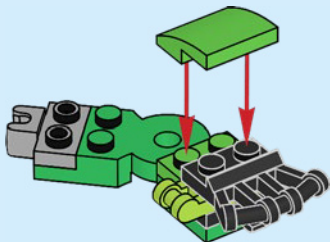



1x

58

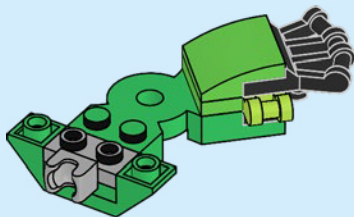



2x

59

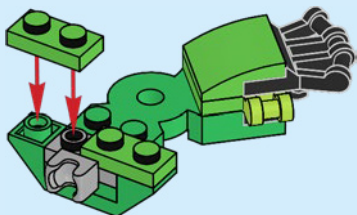



1x

60

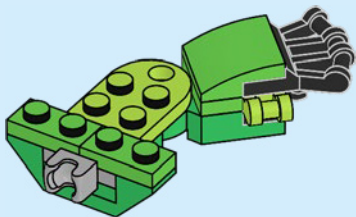



1x

61

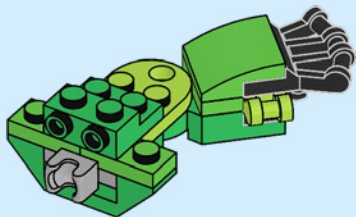



1x

62

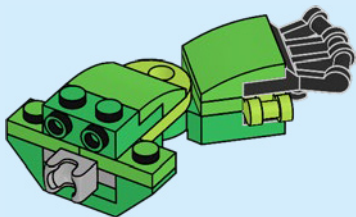



2x

63

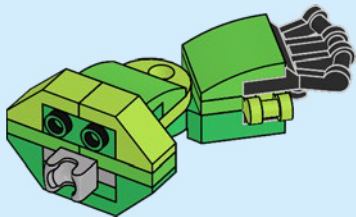



2x

64

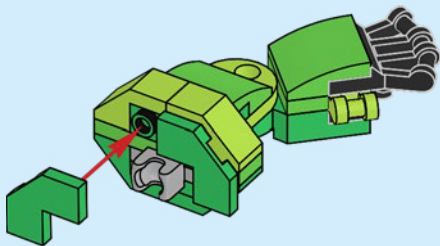



8x



4x



4x

65

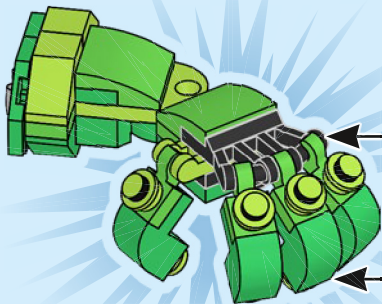

1



2



4x

66

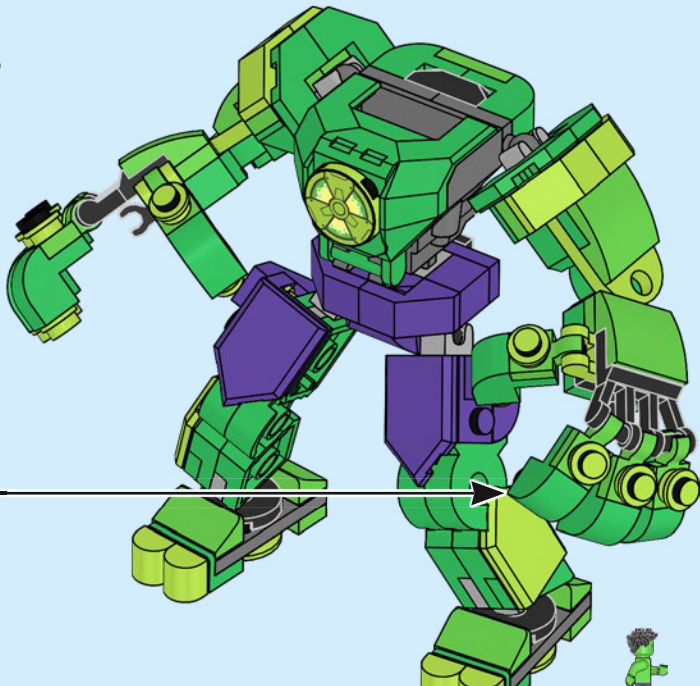

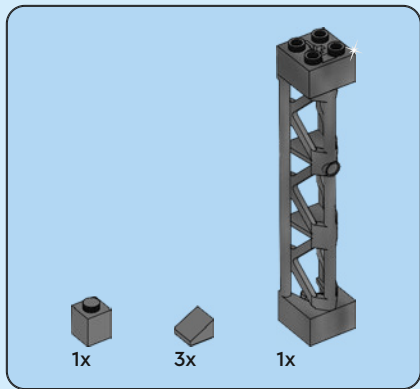

67

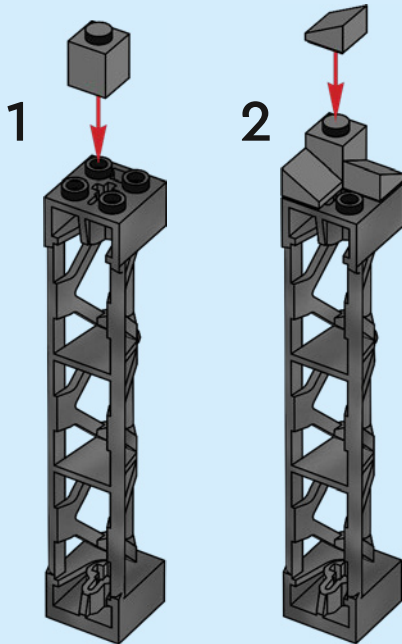

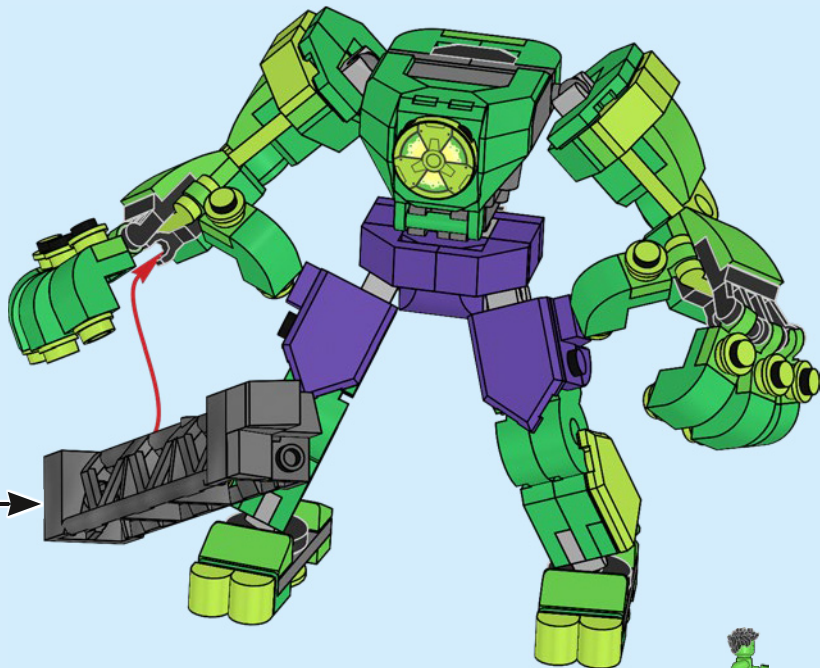

68

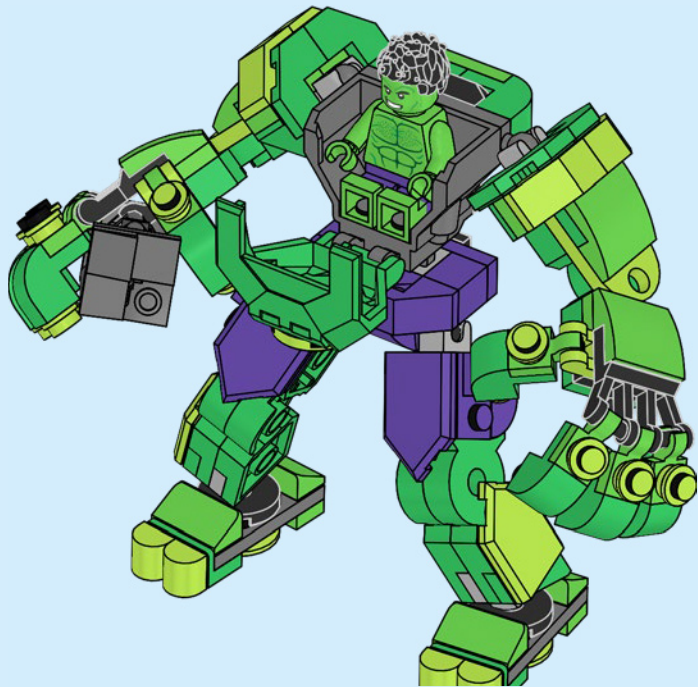





1x
6079896



1x
6279875



2x
6195325



2x
6313116



1x
6013867



1x
6416838



1x
4285883



2x
4604304

62



1x
6385276



1x
6385279



10x
6374489



2x
6099243



4x
6385275



2x
6388820



2x
6399782



1x
6346745



6x
6372712



1x
6421685



8x
6347296



4x
6138510



9x
6343326



5x
6138513



1x
6432311



18x
4183133



4x
6312452



1x
6421694



2x
6121816



4x
6258413



2x
6133859



2x
6253457



2x
6256868



6x
6043656



1x
6326478



3x
4504378



1x
4211098



2x
6364352



2x
6123814



2x
4227398

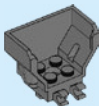

1x
6384443



2x
6199891



2x
6084028



1x
6382662



4x
6166863



2x
6382583



1x
6109766



2x
6245266



2x
6334093



1x
6263553



[LEGO.com/service](https://www.LEGO.com/service)

YOU COULD

WIN



Scan this QR code or go to
LEGO.COM/PRODUCTFEEDBACK and give us
your short feedback about this LEGO® set
for a chance to win a cool LEGO prize.

Terms and Conditions apply*

DE: Du könntest GEWINNEN. Es gelten die Teilnahmebedingungen* **FR: Tu pourrais GAGNER.** Des conditions s'appliquent* **IT: Potresti VINCERE tu.** Termini e condizioni sono applicabili* **ES: Puedes GANAR.** Aplican términos y condiciones* **PT: Poderá GANHAR.** Aplicam-se termos e condições* **JA: プレゼント付き! 利用規約が適用されます*** **ZH: 轻松获奖. 条款和条件适用*** **KO: 상품의 주인이 되어보세요. 소정의 약관이 적용됩니다*** **RU: Вы можете ВЫИГРАТЬ.** Действуют положения и условия* **PL: Szansa na WYGRANĄ.** Obowiązują warunki korzystania* **CS: Máte šanci VYHRÁT.** Platí všeobecné smluvní podmínky* **SK: Máte šancu VYHRATĚ.** Platia všeobecné zmluvné podmienky* **HU: TE IS NYERHETSZ.** Felhasználási feltételek érvényesek* **RO: Ai putea CÂȘTIGA.** Se aplică termenii și condiții* **BG: Можете да СПЕЧЕЛИТЕ.** Има определени правила и условия* **LV: Tu vari LAIMĒT.** Ir spēkā noteikumi un nosacījumi.* **ET: Sul on võimalus VÕITA.** Kehtivad tingimused* **LT: Jūs galite LAIMĖTI.** Taikomos sąlygos*

*[LEGO.com/productfeedback-terms](https://www.lego.com/productfeedback-terms)

LEGO and the LEGO logo are trademarks of the/son des marques de commerce du/son marcas registradas de LEGO Group. ©2023 The LEGO Group.

© 2023 MARVEL

6451737