



DC COMICS
**SUPER
HEROES**

76070



6187718

1

1



2

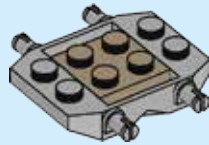

3

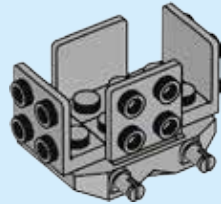

4

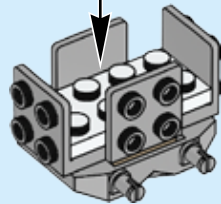

5

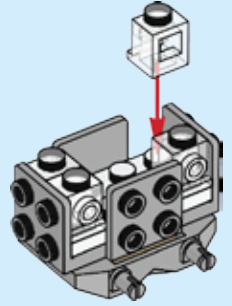

6

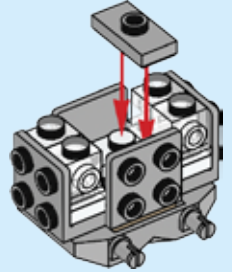

7

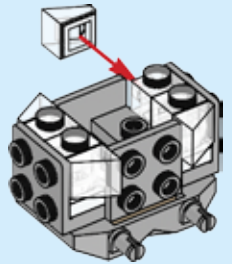

8

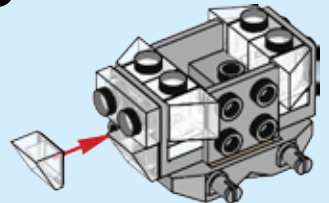

9

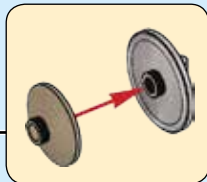
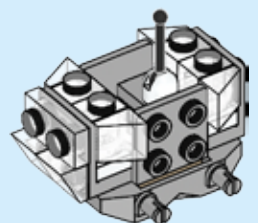

10

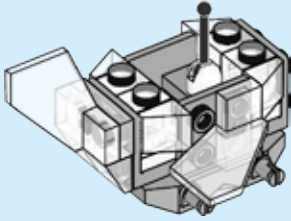

11

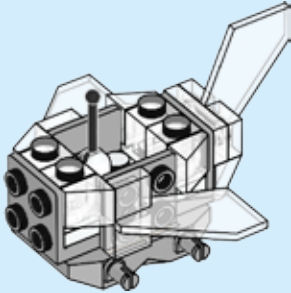
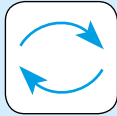

12

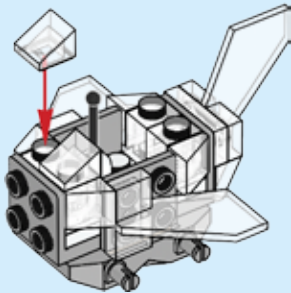

13

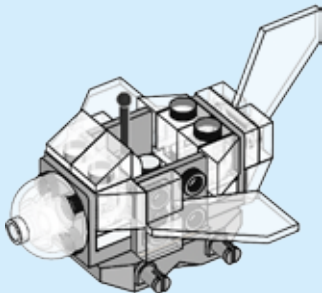

14

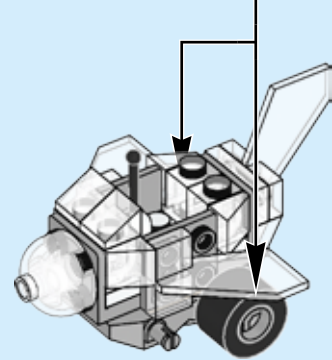
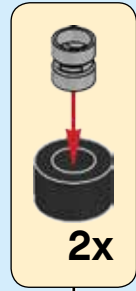

15

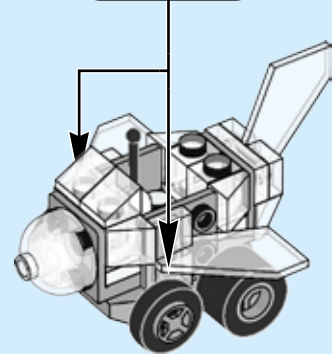
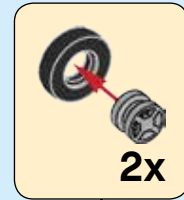

LEGO.com/service

LEGO and the LEGO logo are trademarks of the LEGO Group. ©2017 The LEGO Group. 6187718

DC All DC characters and elements © & TM DC Comics.

WB SHIELD: TM & © WBEI. (s17)