



Disney · PIXAR  
**Toy**  
STORY



7593



1

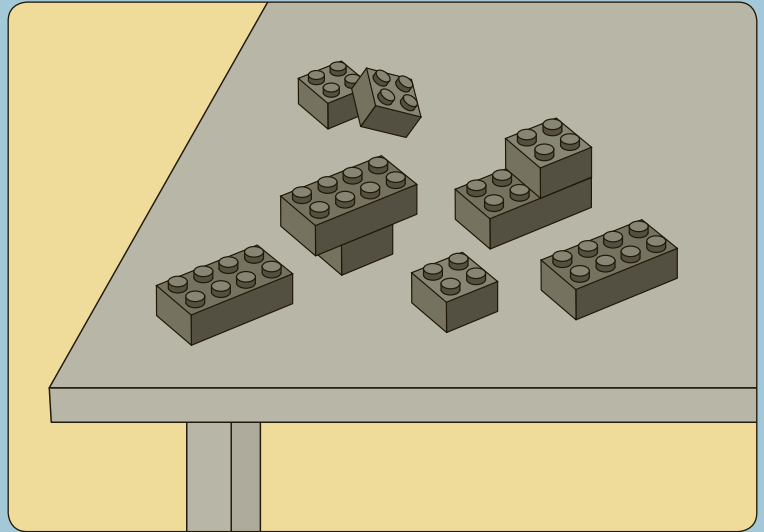
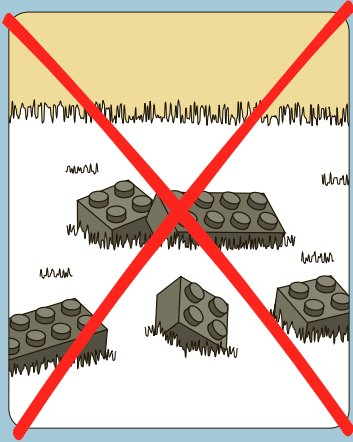

2





1

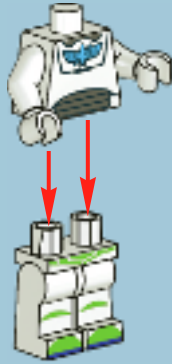

2

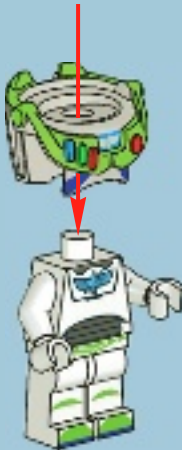

3

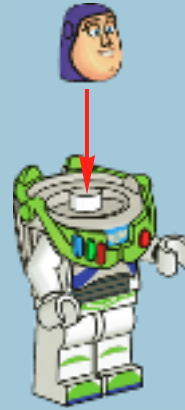

4

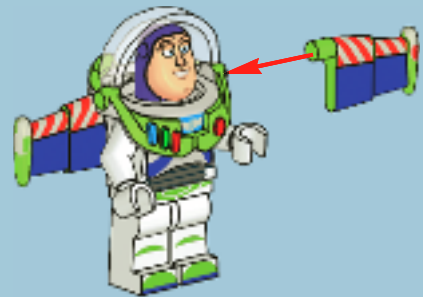

1

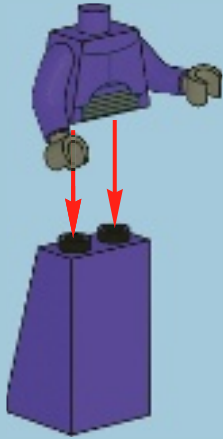

2



3

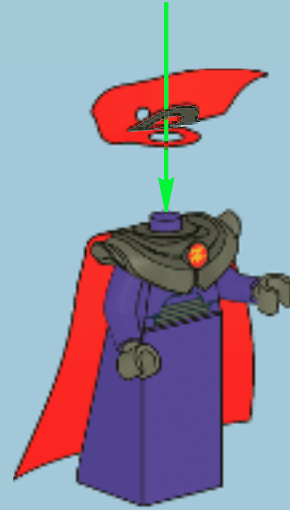

4



5

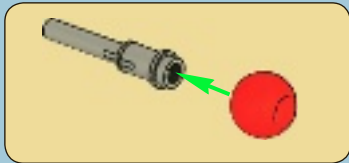

6

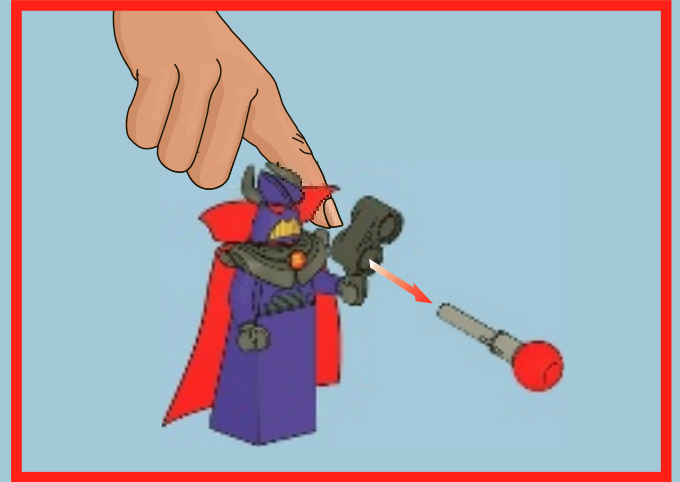

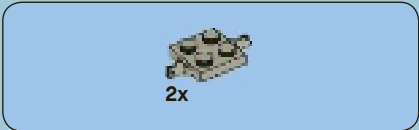

1

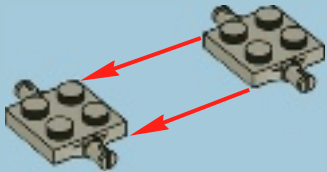

2

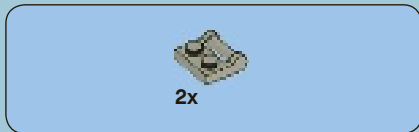

3



4

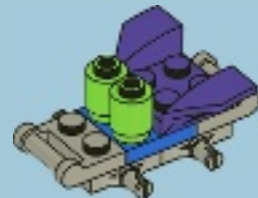



2x

5

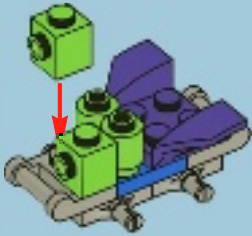

1x

6

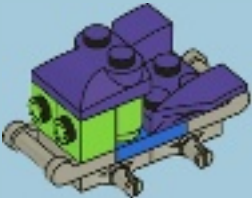

2x

7

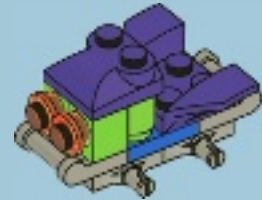

4x



4x

8







9





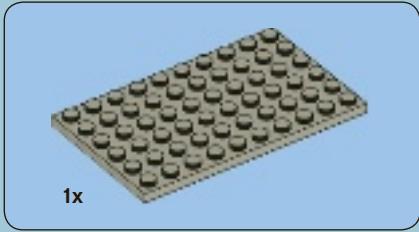
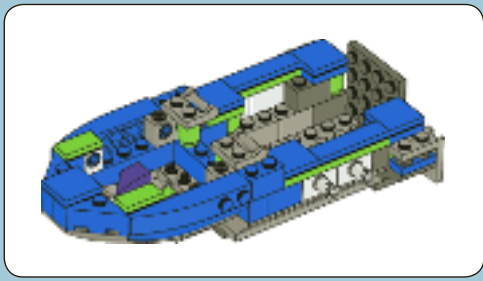

**1**

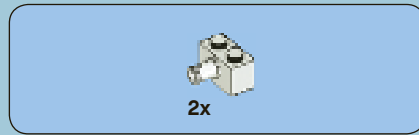
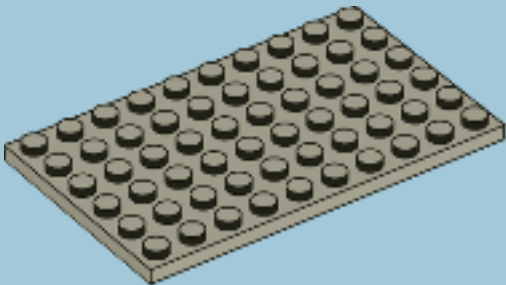

**2**

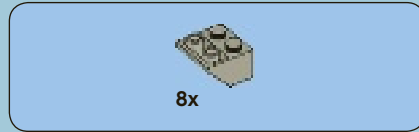
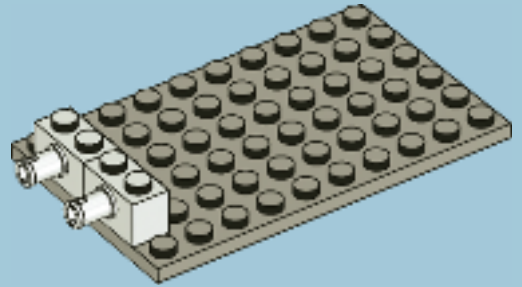

**3**

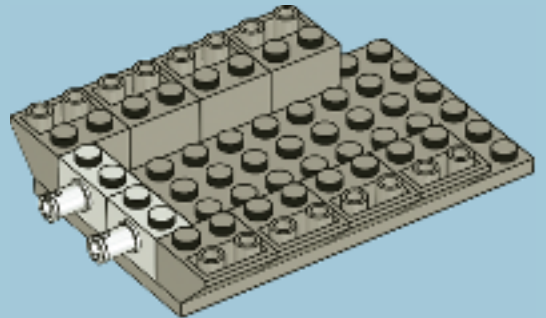



4

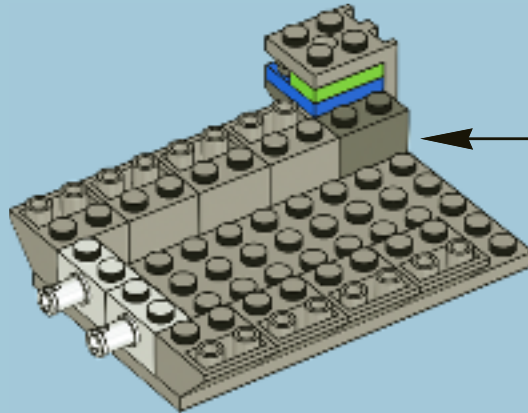
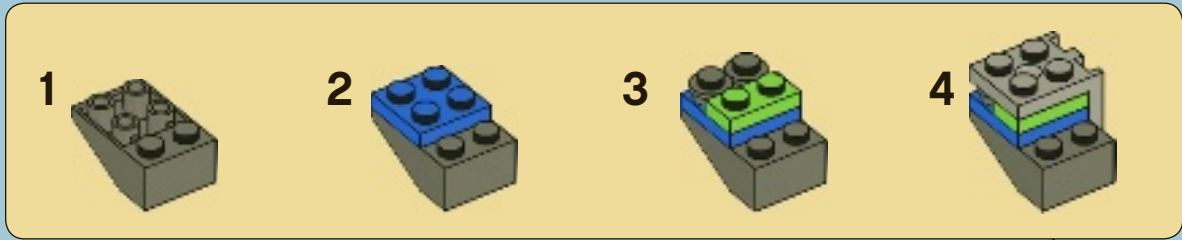



# 5

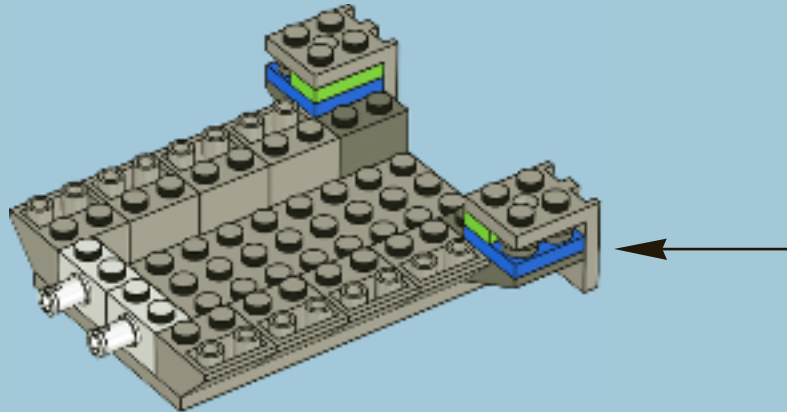



2x



2x

# 6

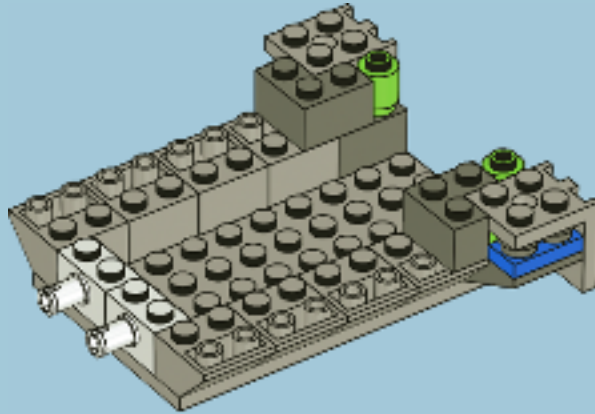

4x



2x

# 7

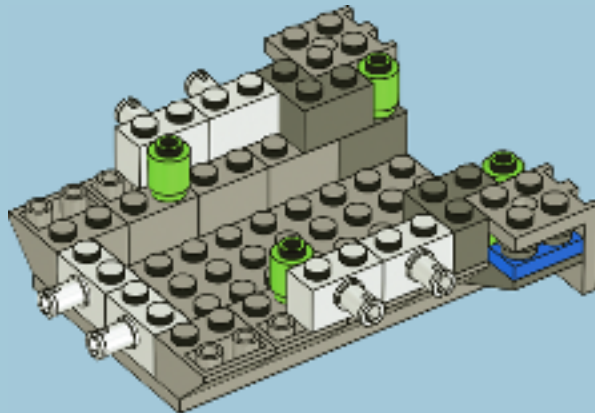

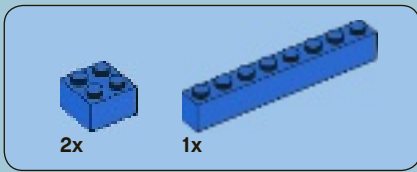

8

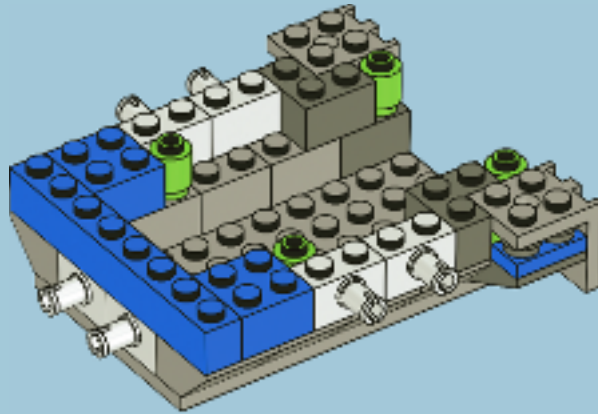

9

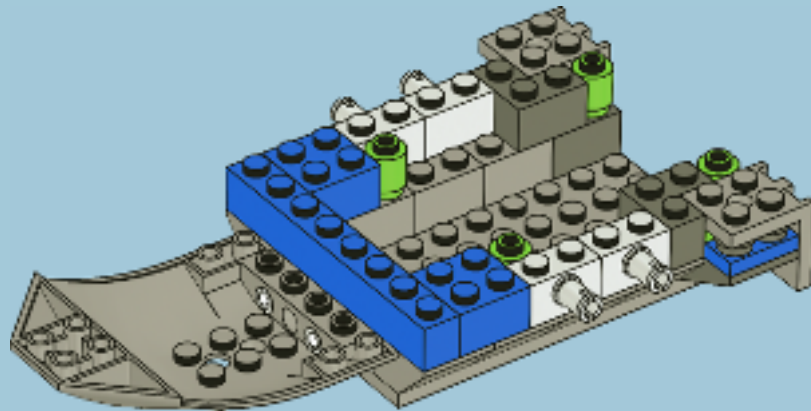



1x

# 10

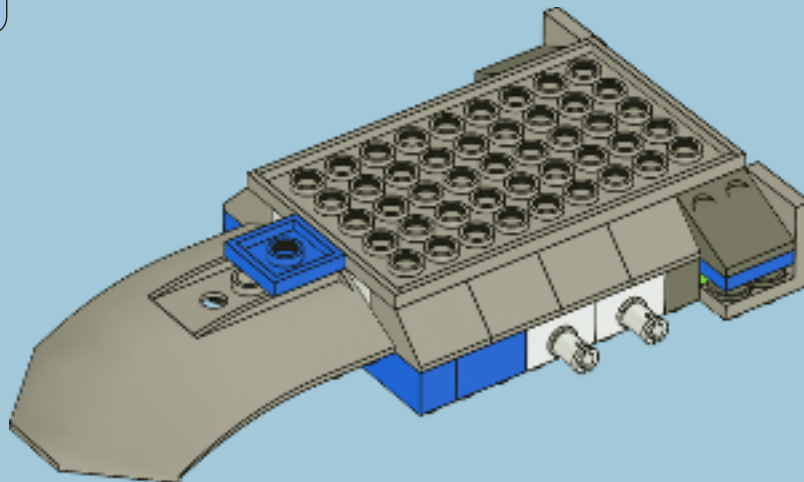
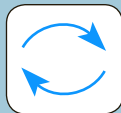

2x



1x

# 11

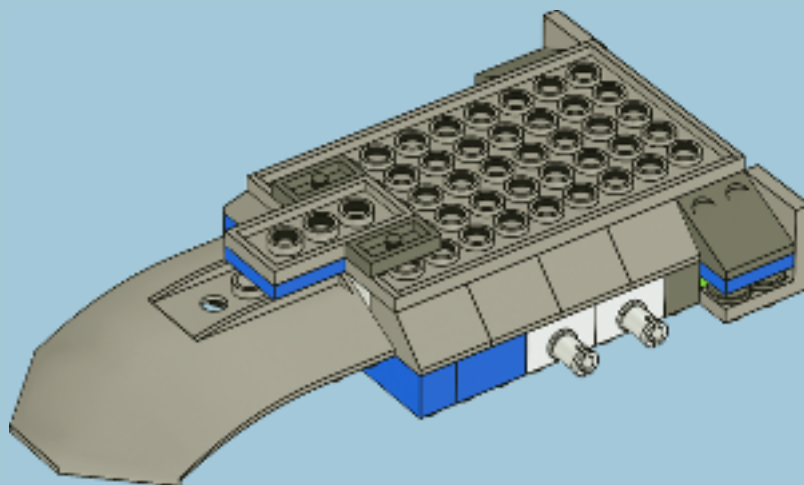

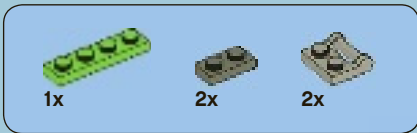

# 12

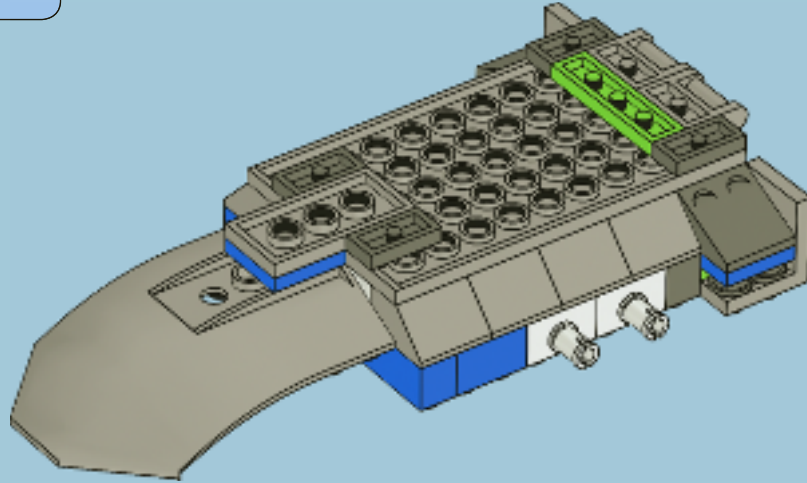

# 13

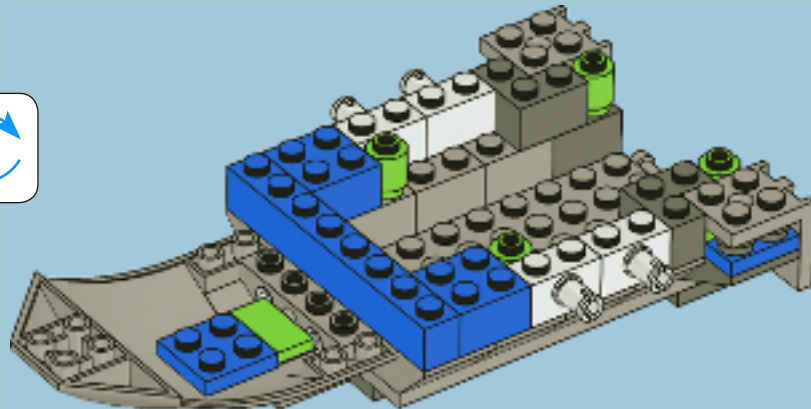
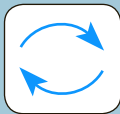





1x

# 14

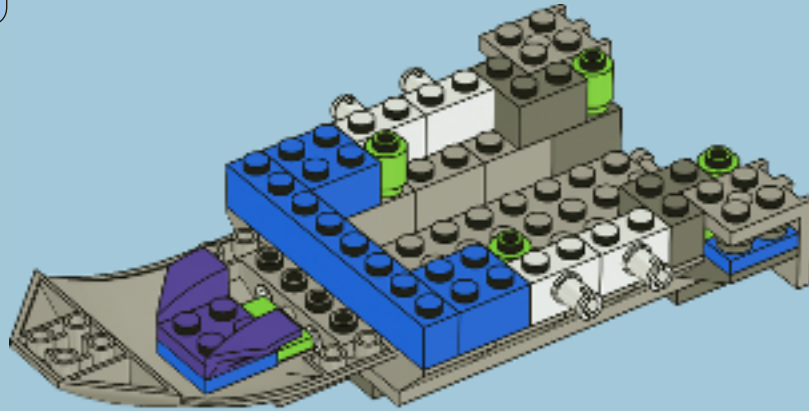

1x



1x

# 15

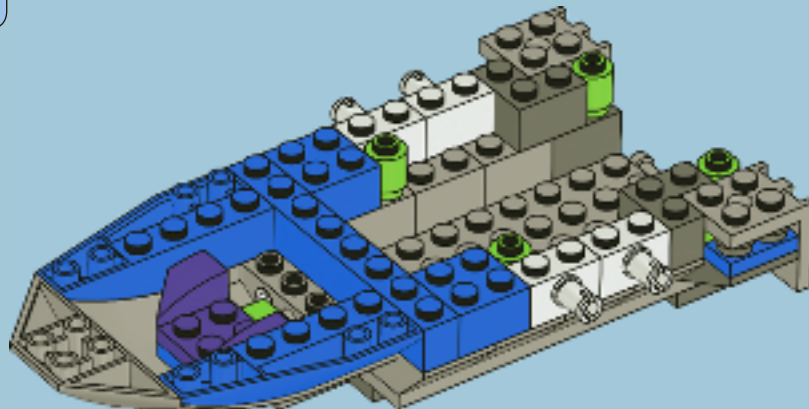

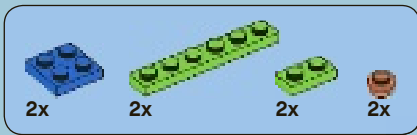

# 16

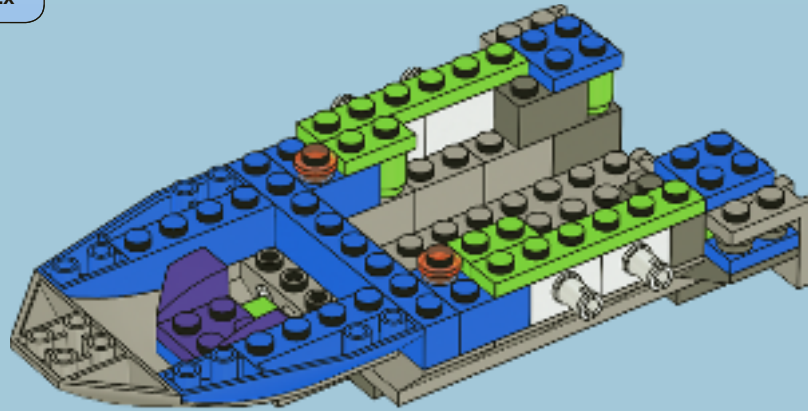

# 17

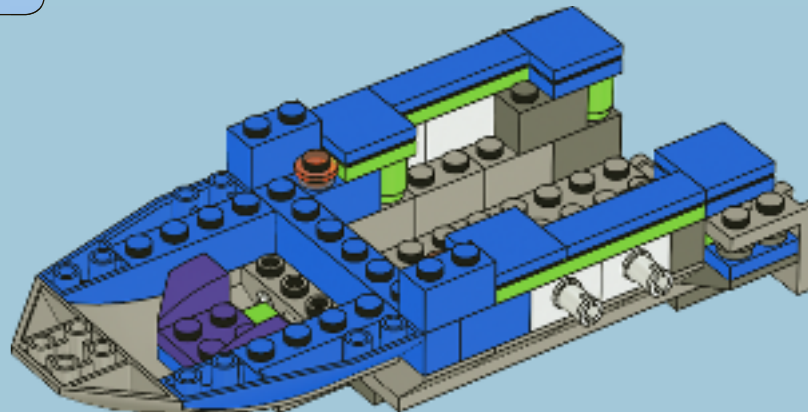



2x



2x

# 18

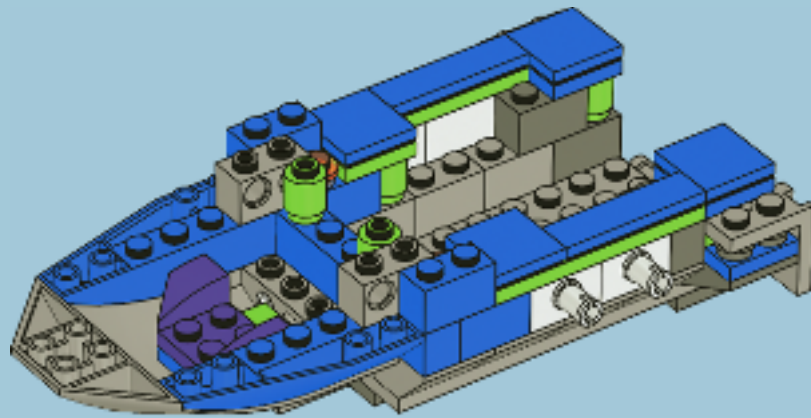



2x



2x

# 19

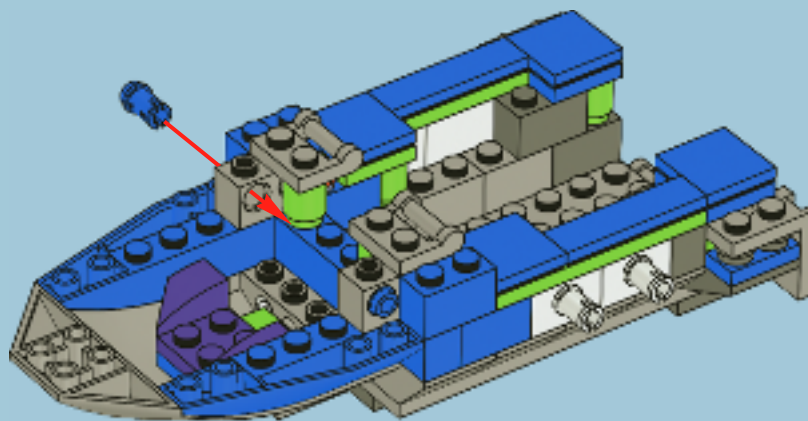



1x



2x

# 20

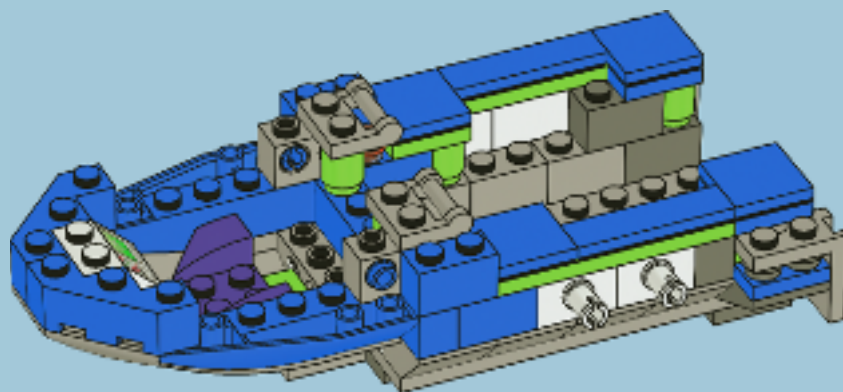



# 21

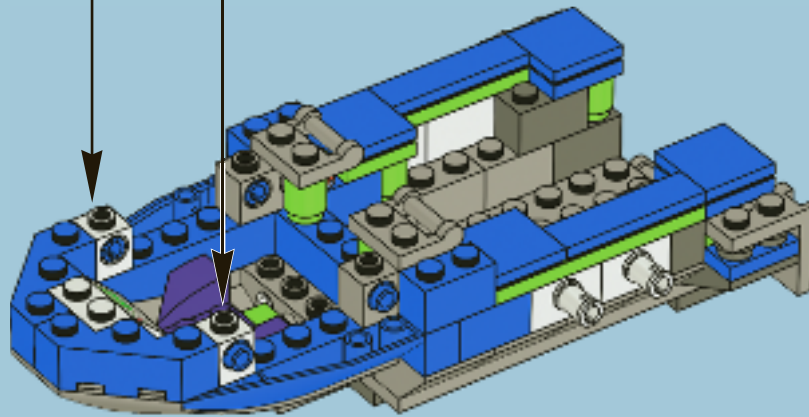
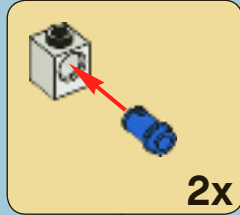



1x



2x

# 22

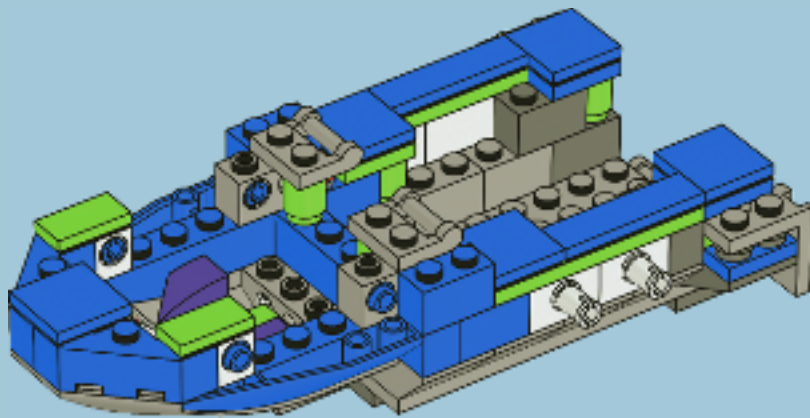



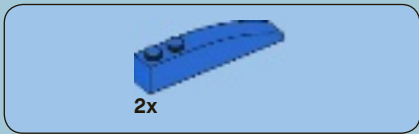

# 23

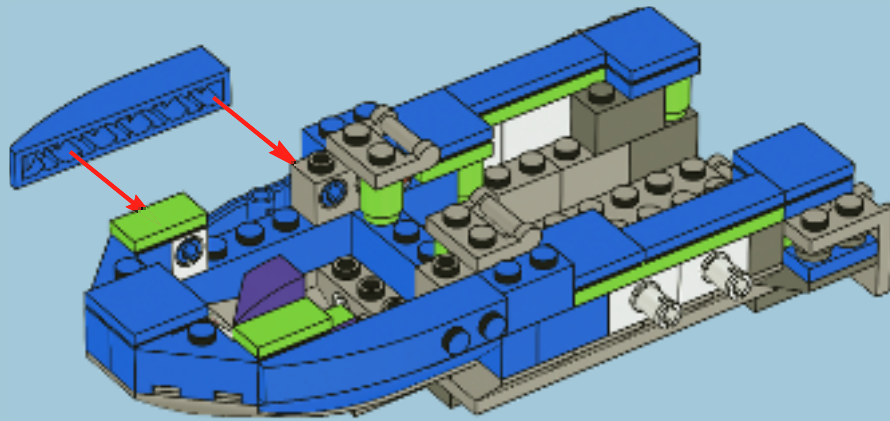



# 24

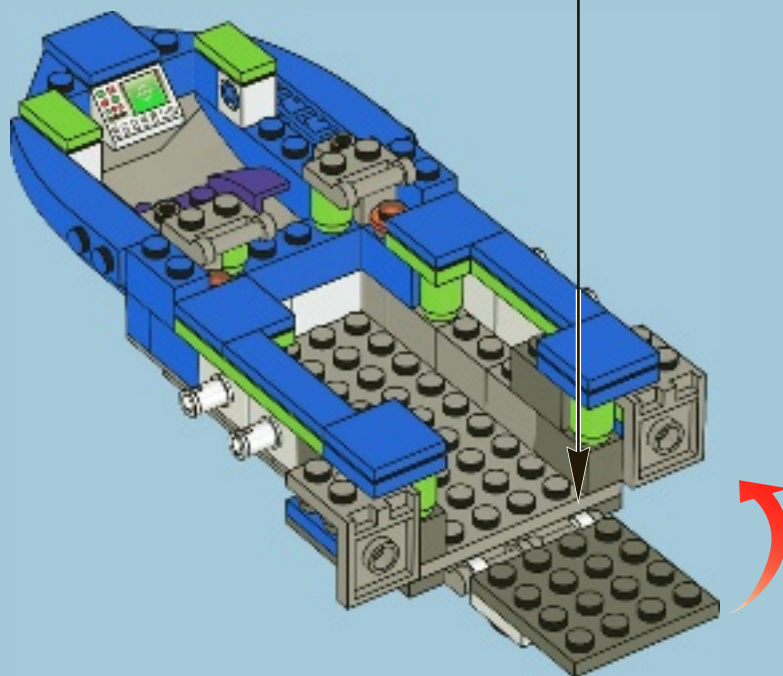
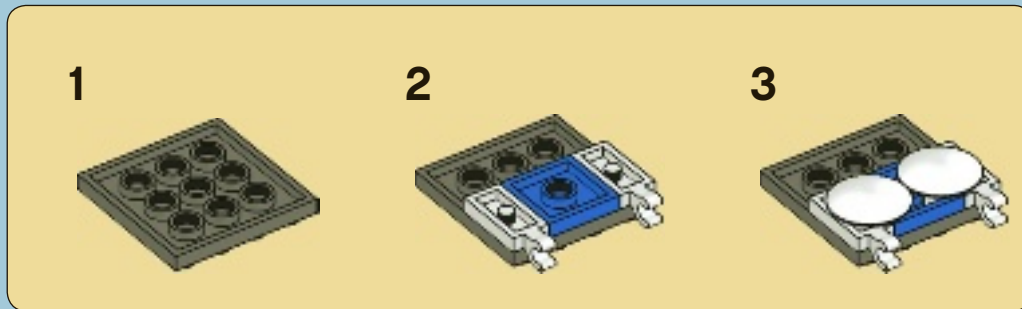

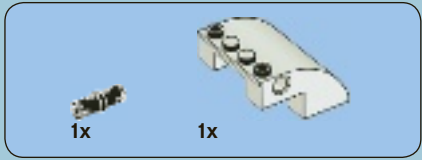
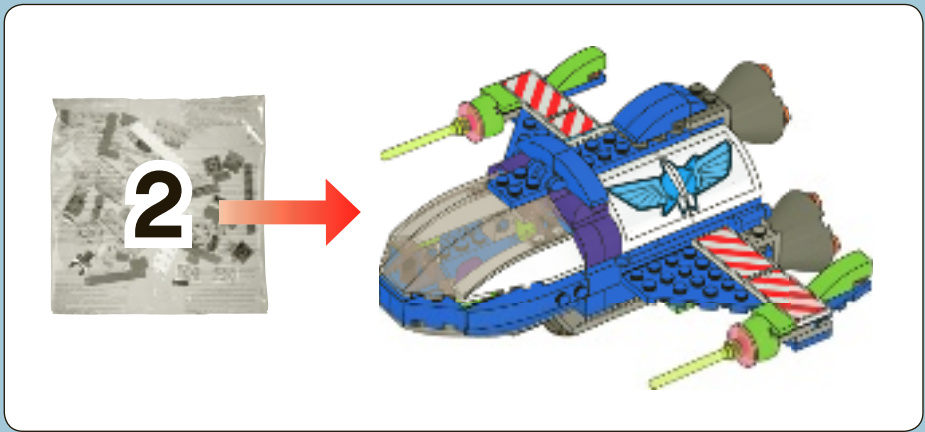

1

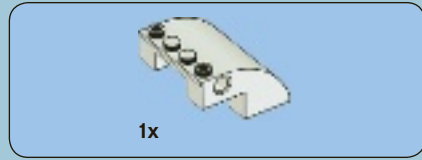
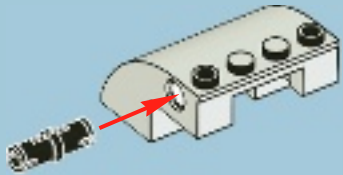

2

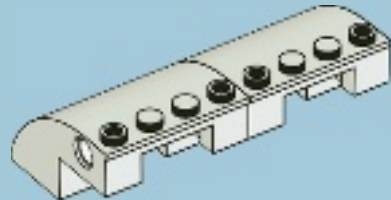



2x

3

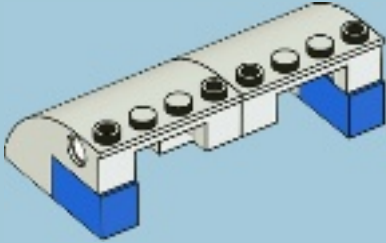

1x



1x

4

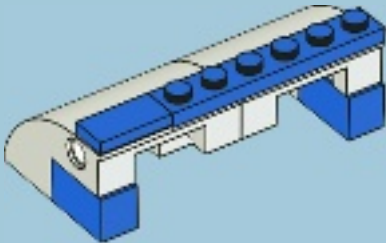

4x

5

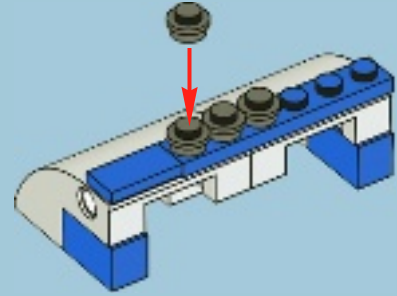

1x

6

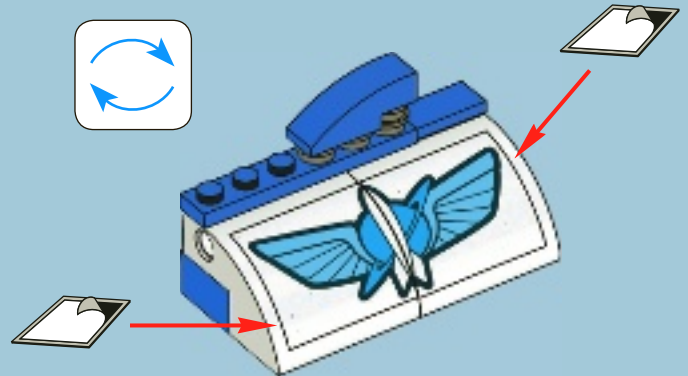
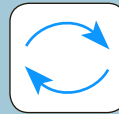



# 7

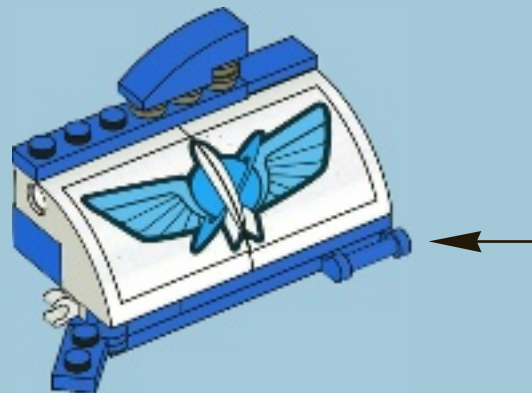
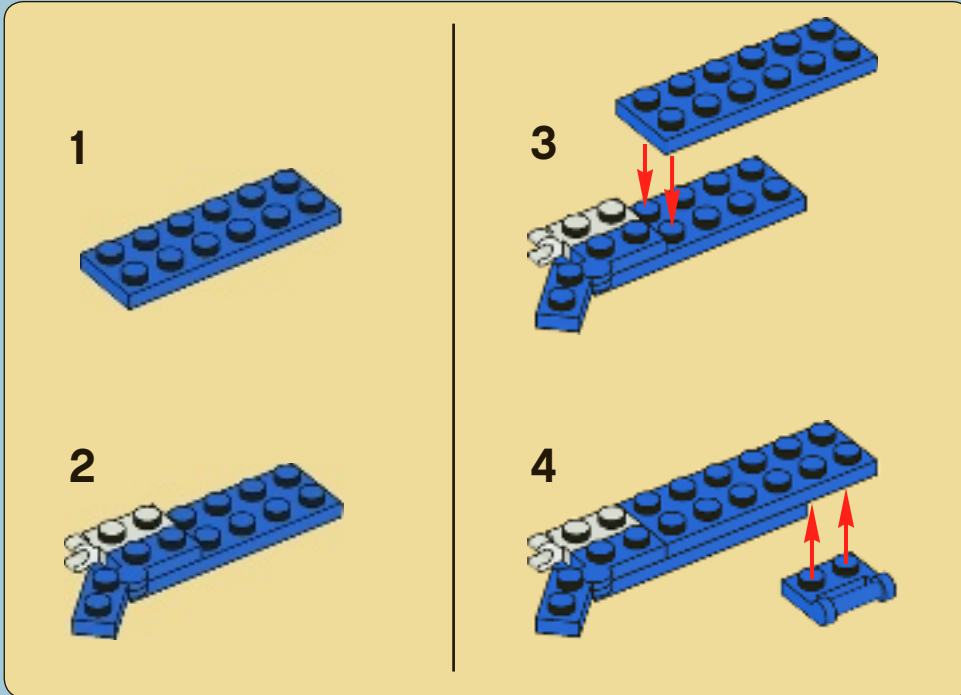

25

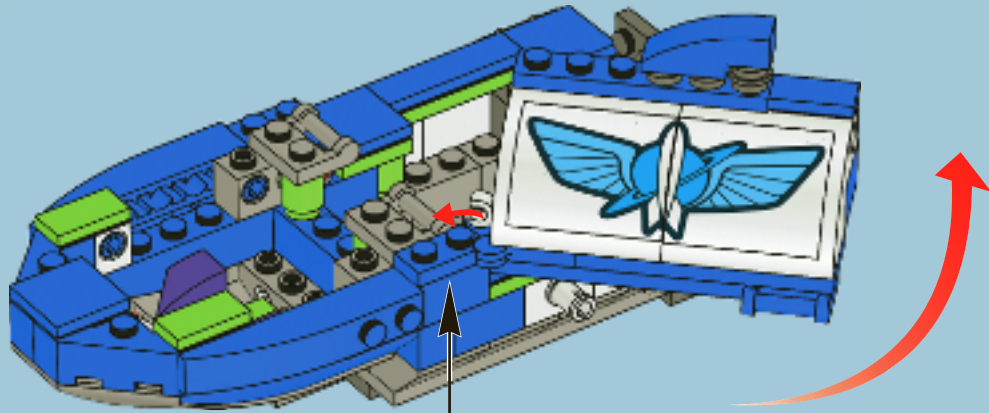

CLICK!

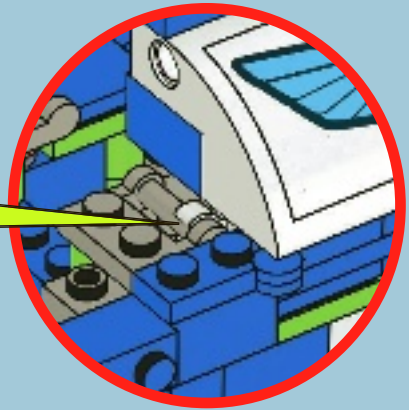

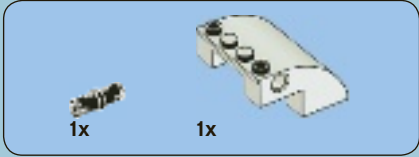
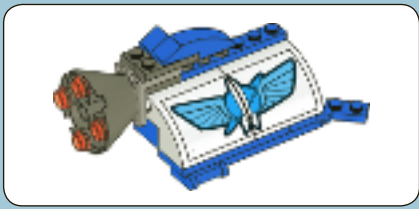

1

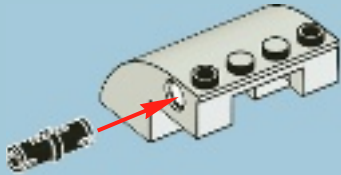

2

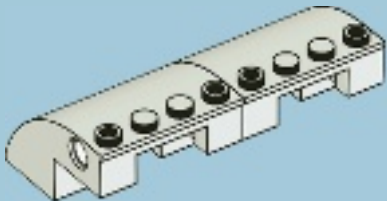

3

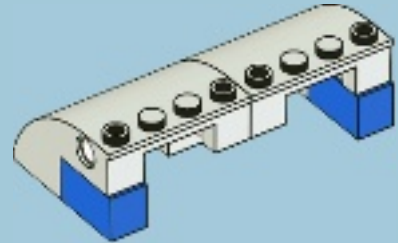

4

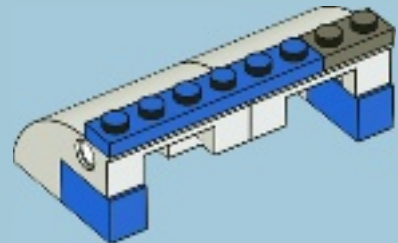



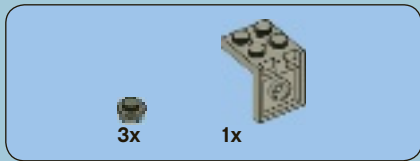

5

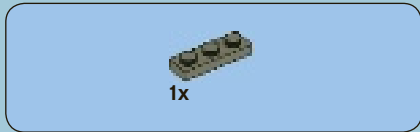
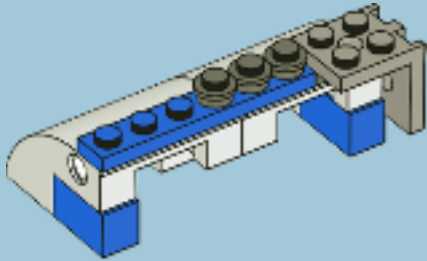

6

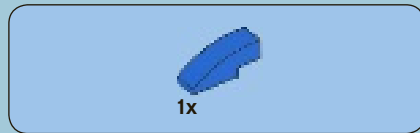
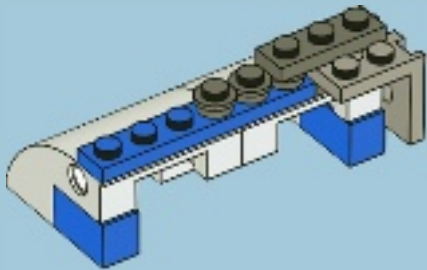

7

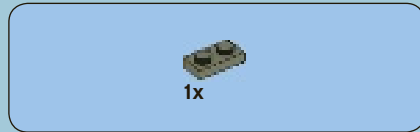
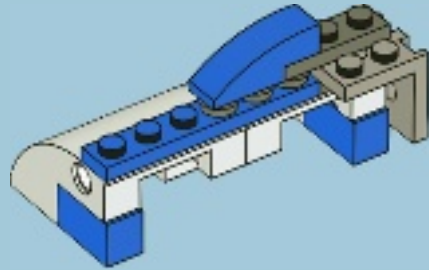

8

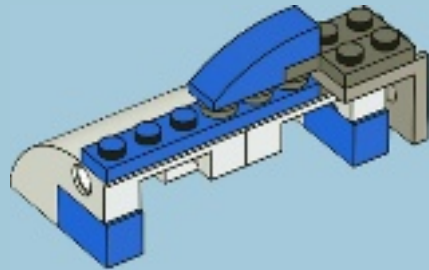

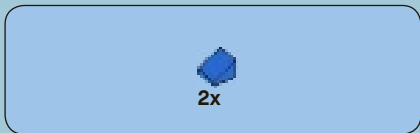

9

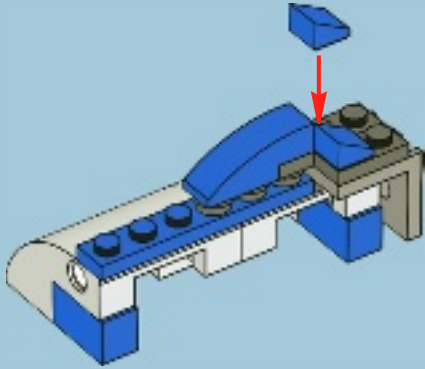

10

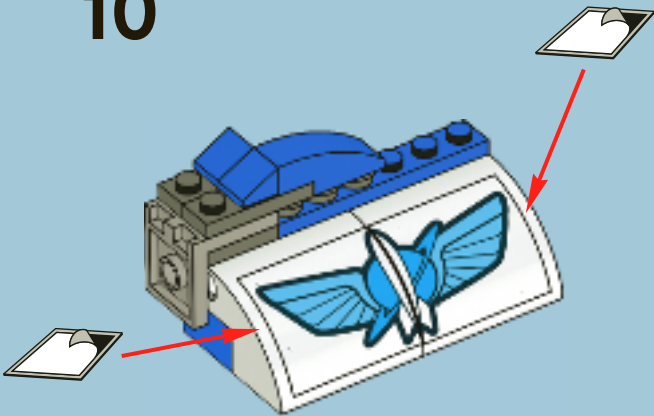

11

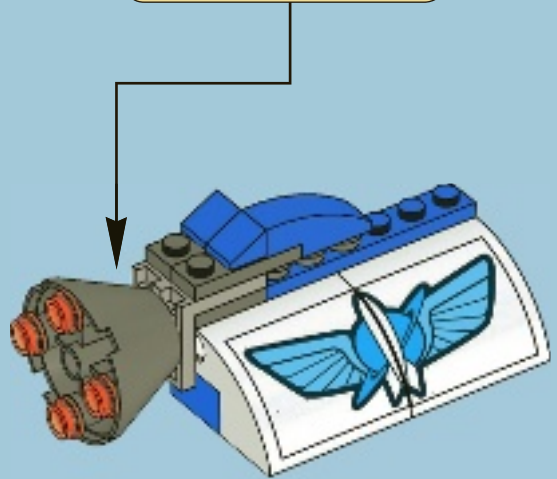
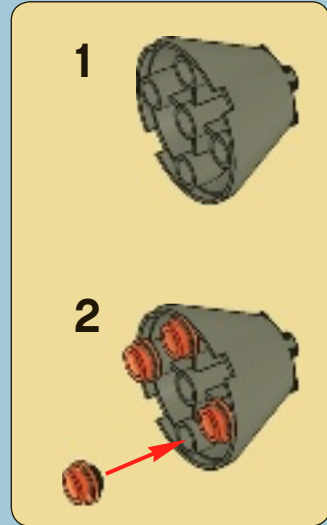



# 12

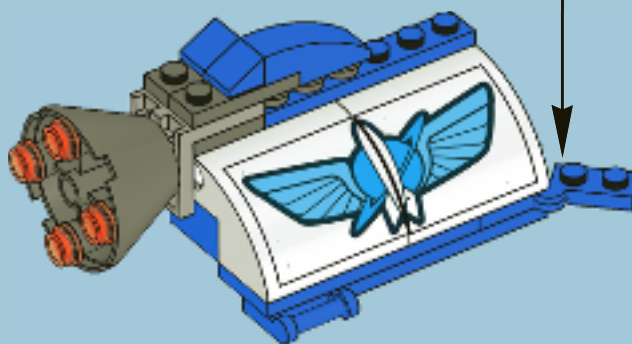
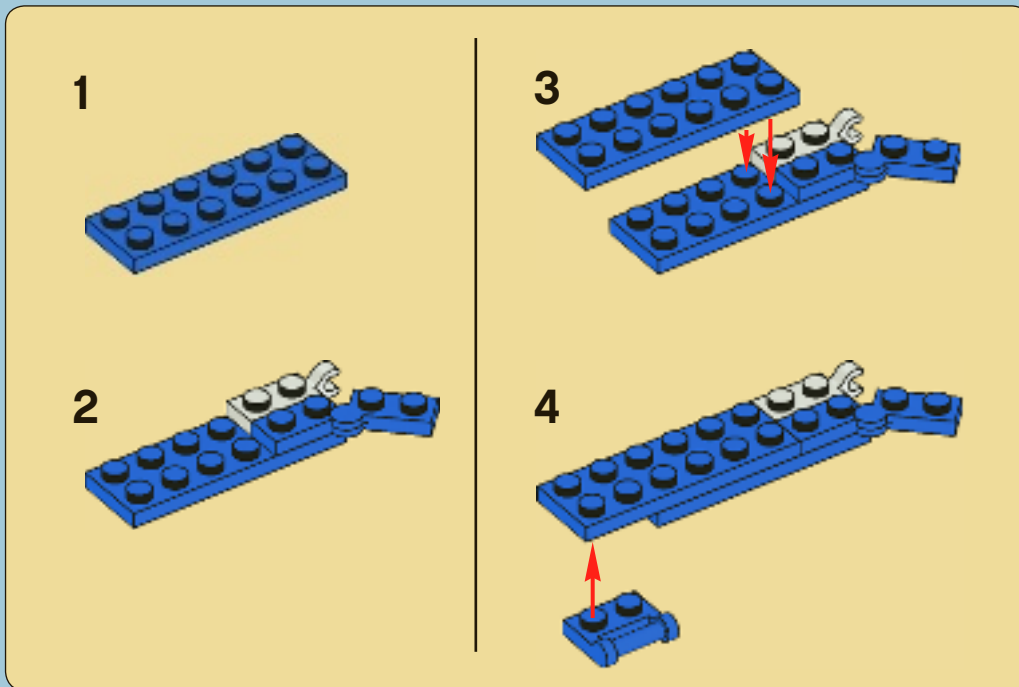

26

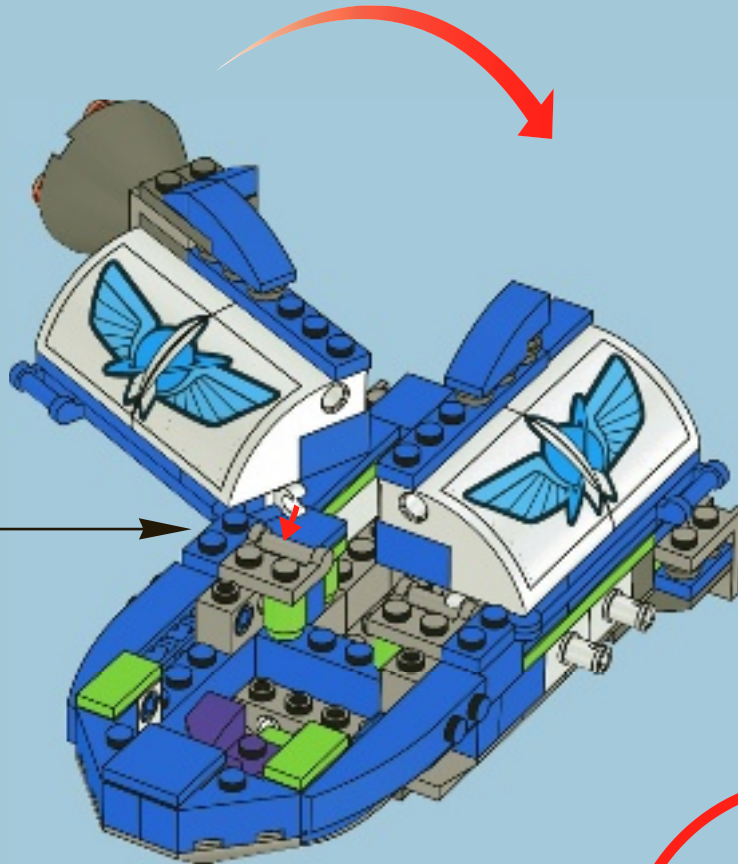

CLICK!

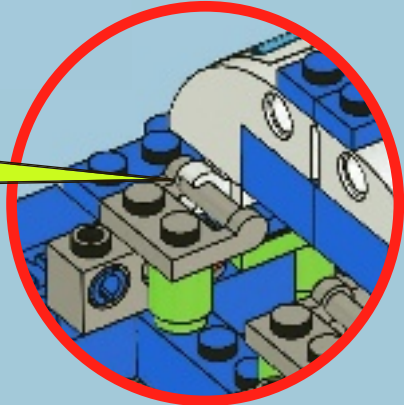



2x



2x

# 27

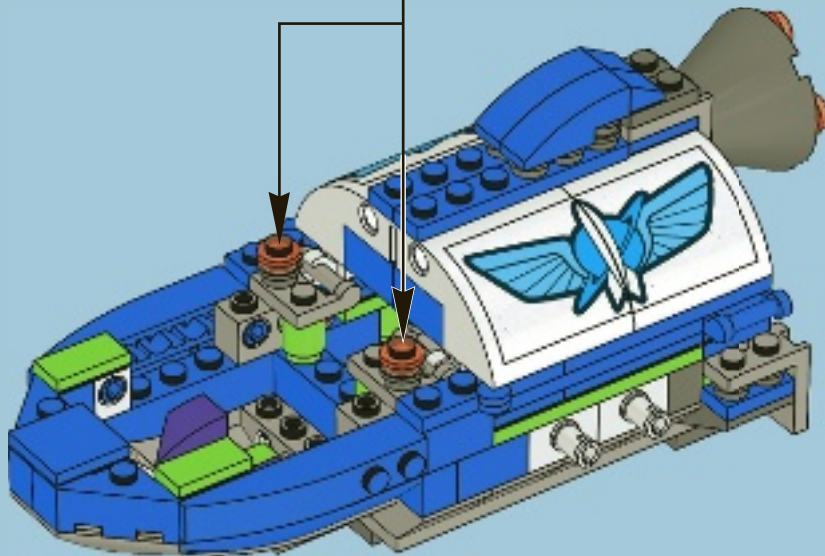



4x

# 28

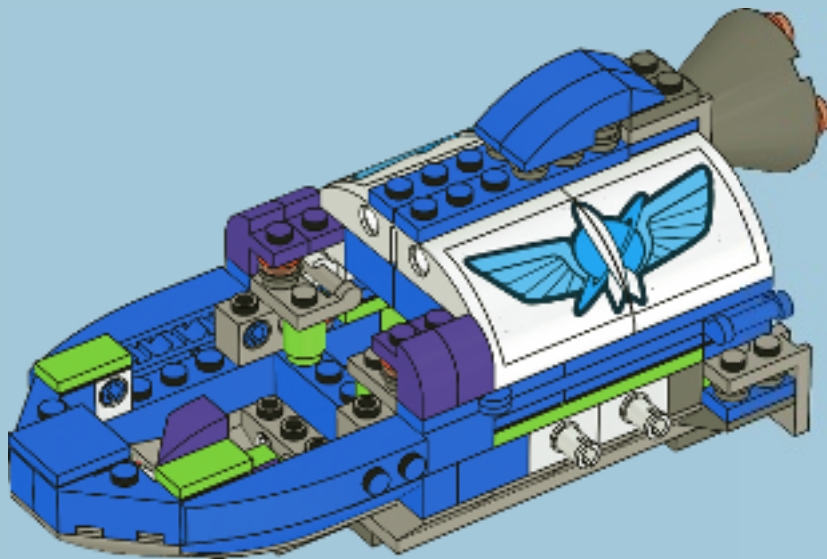



1x

# 29

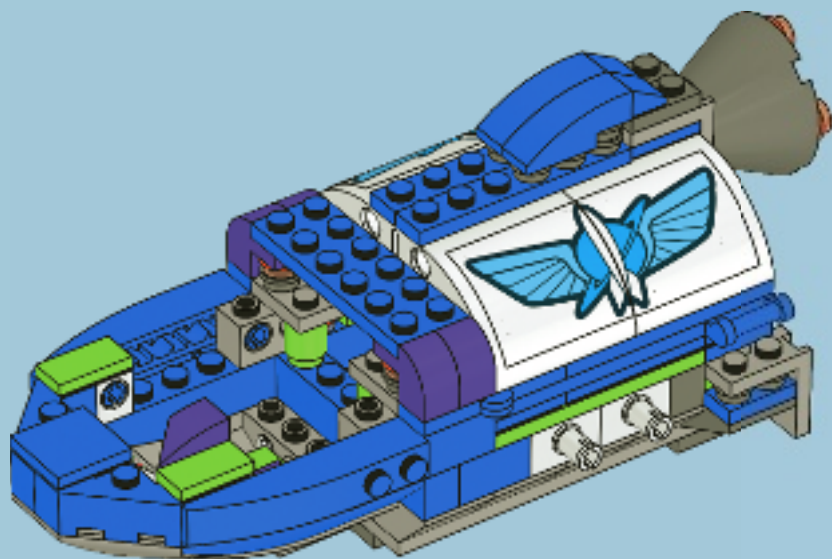



3x

# 30

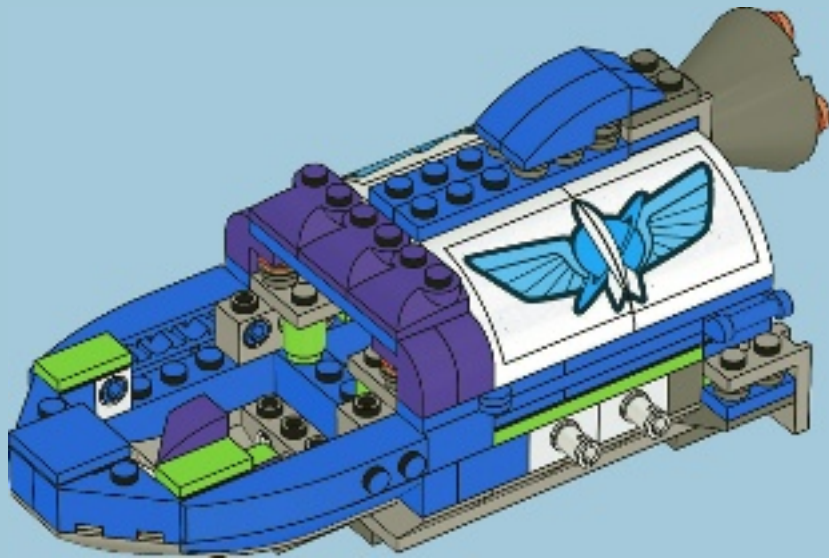





1x

# 31

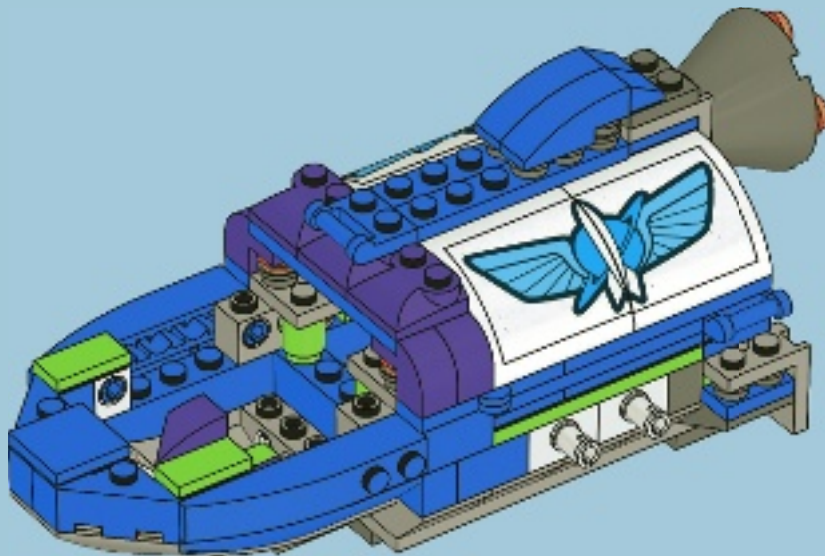



2x

# 32

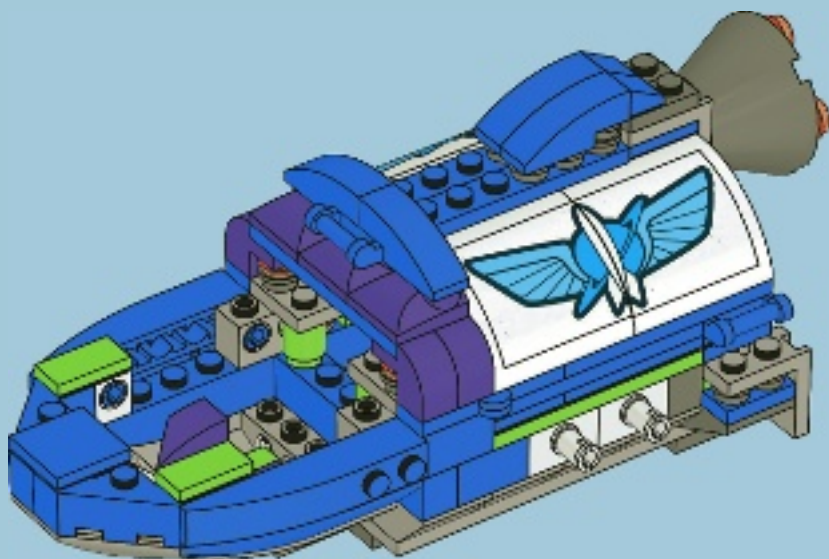

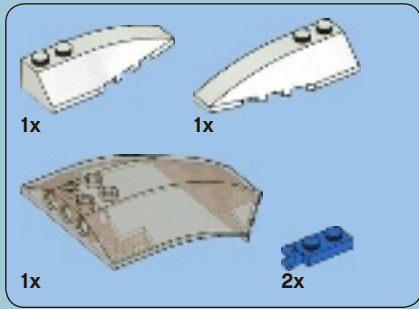

33

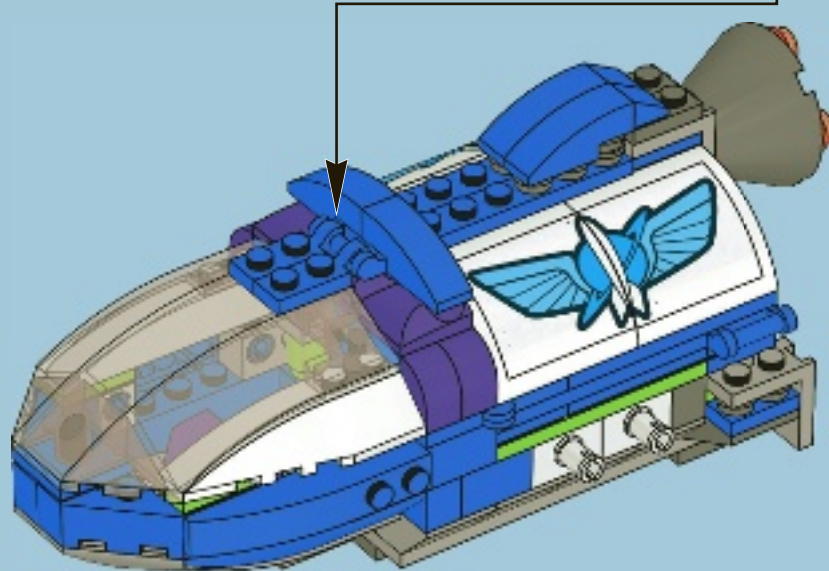
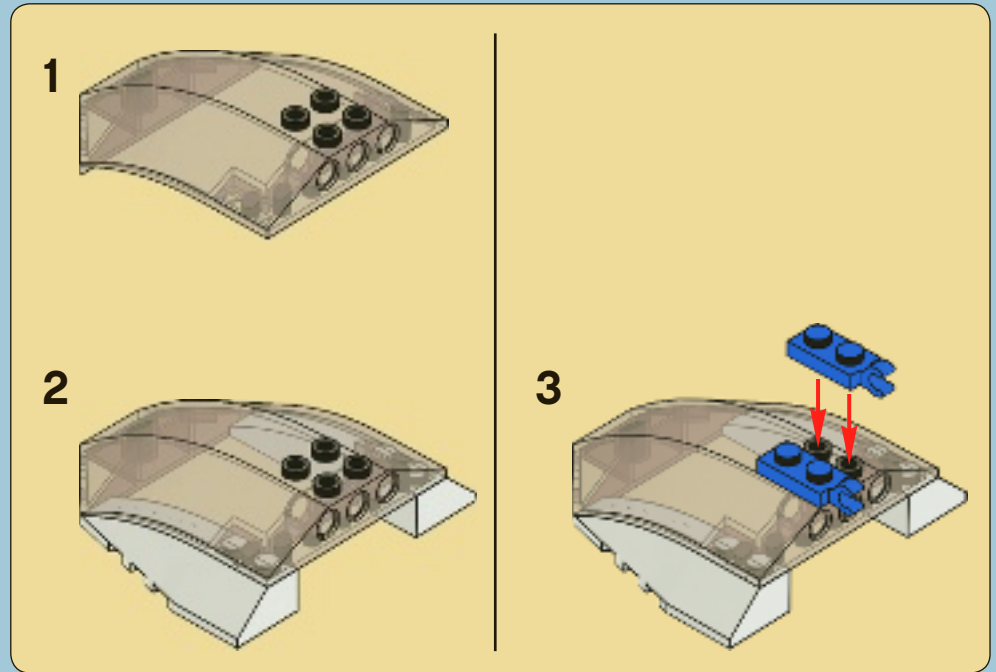



1

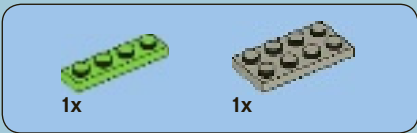
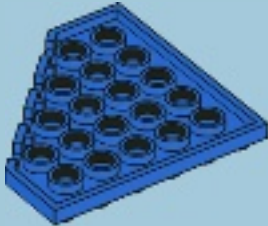

2

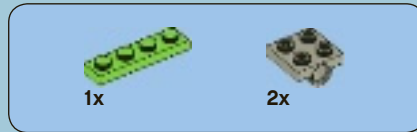
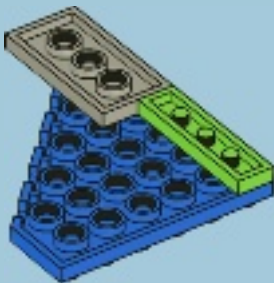

3

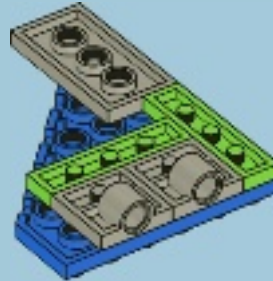

4

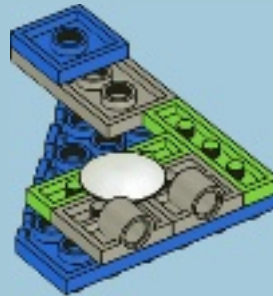



1x

5



1x



1x



1x

6

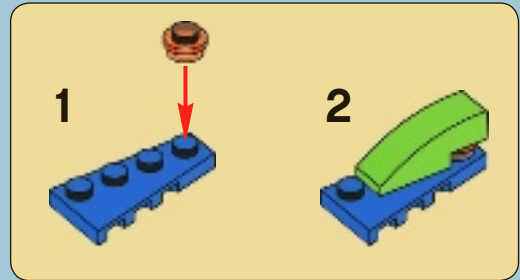



7

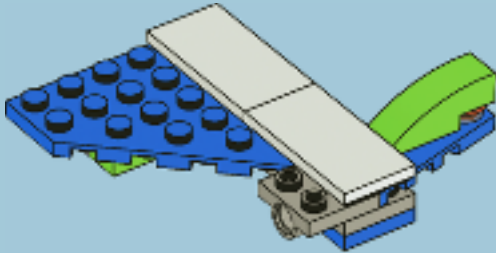

8

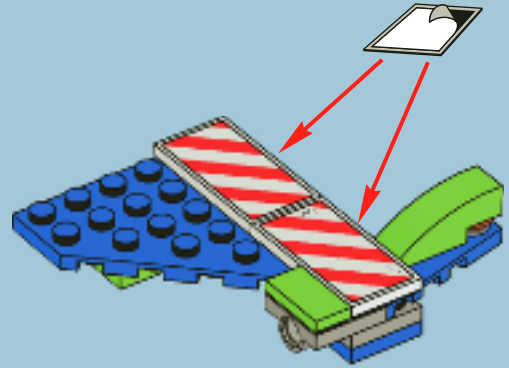

34

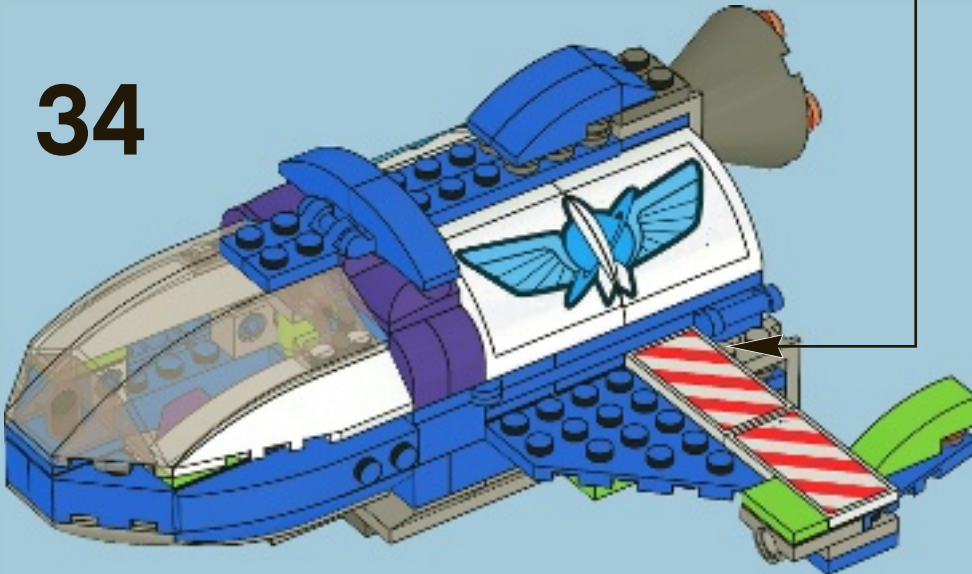



1



2

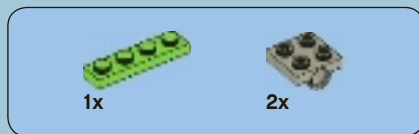
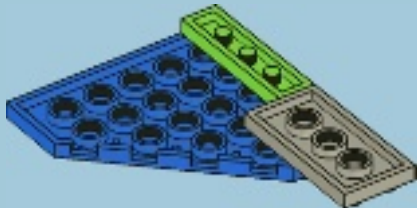

3

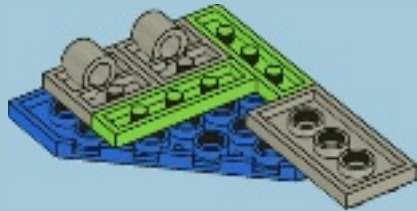

4

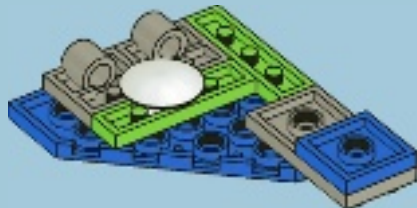





5

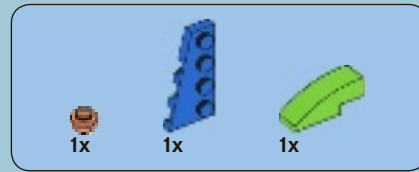
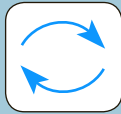

6

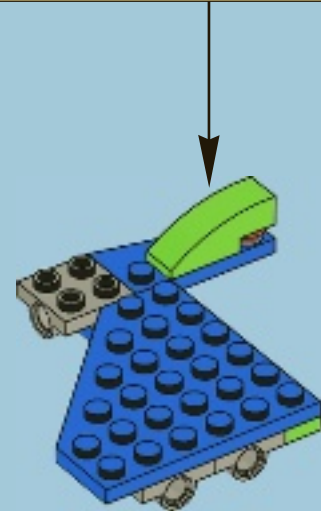
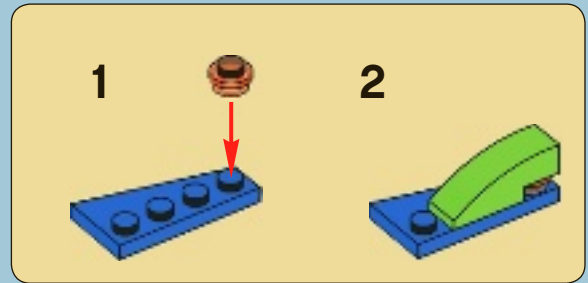





7

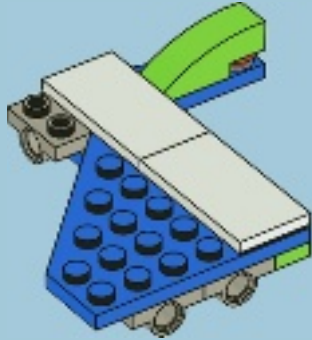

8

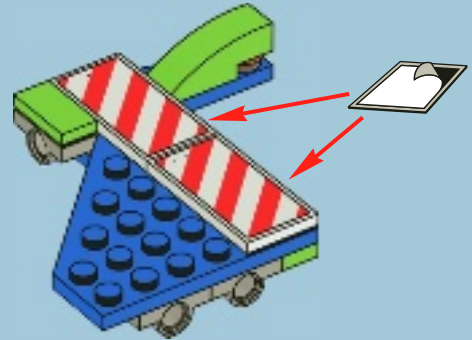

35

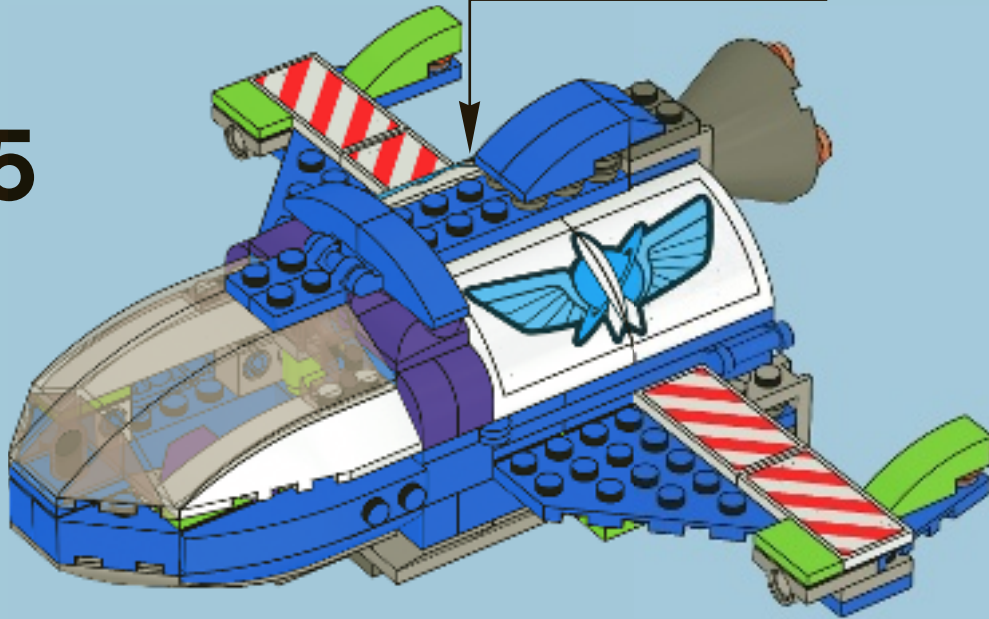



36

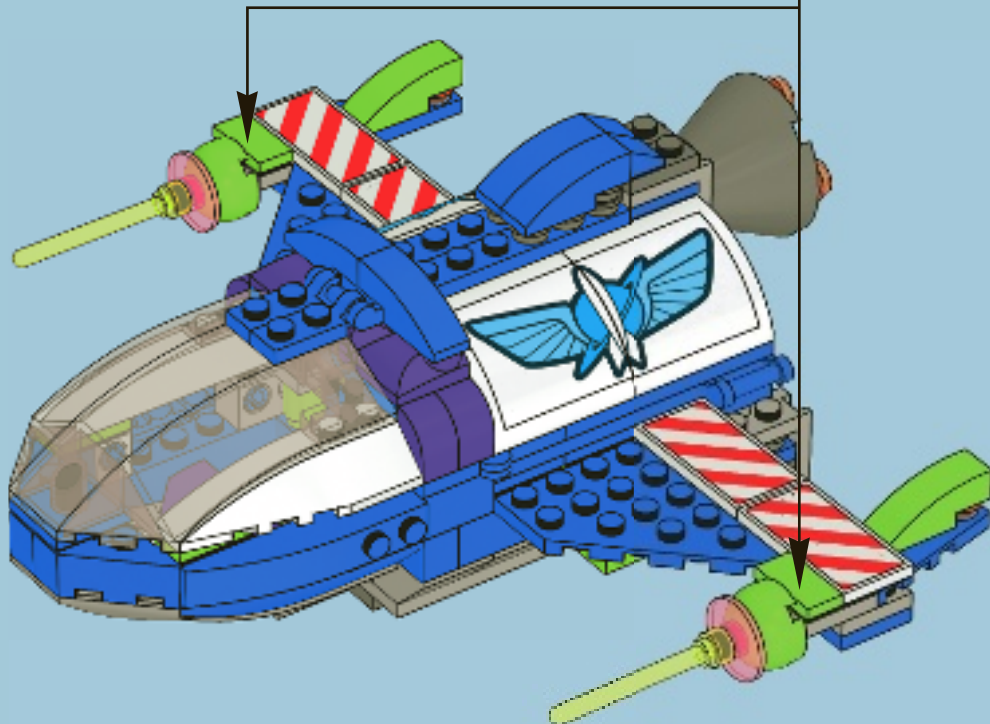
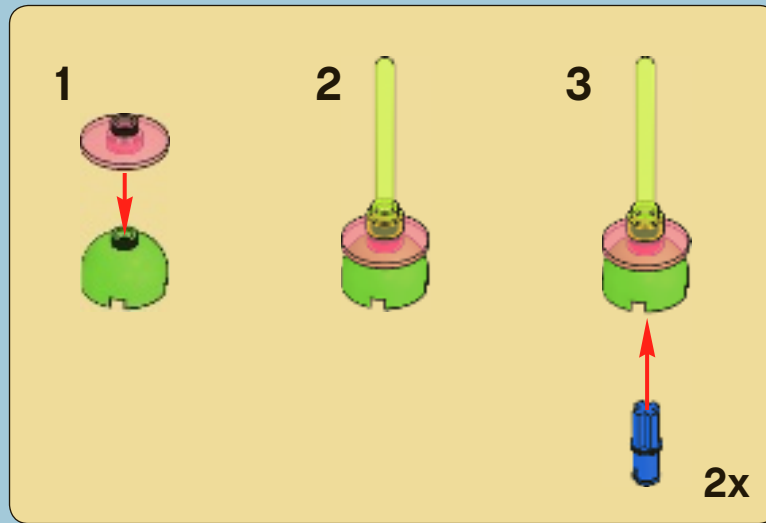



4x



4x

# 37

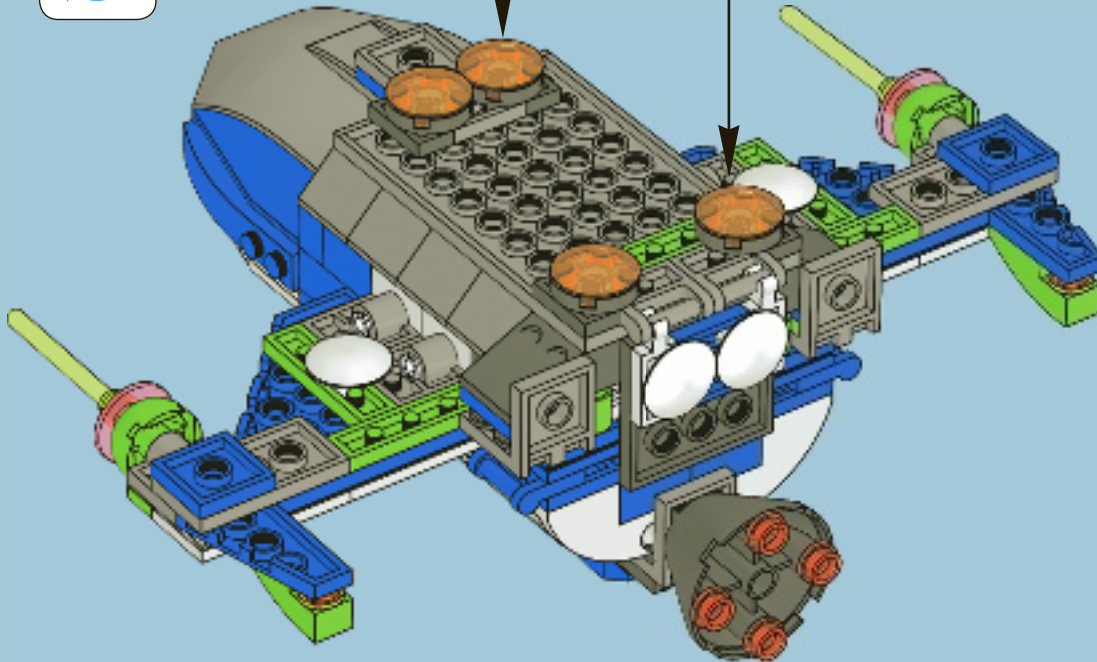

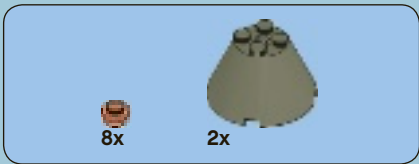

38

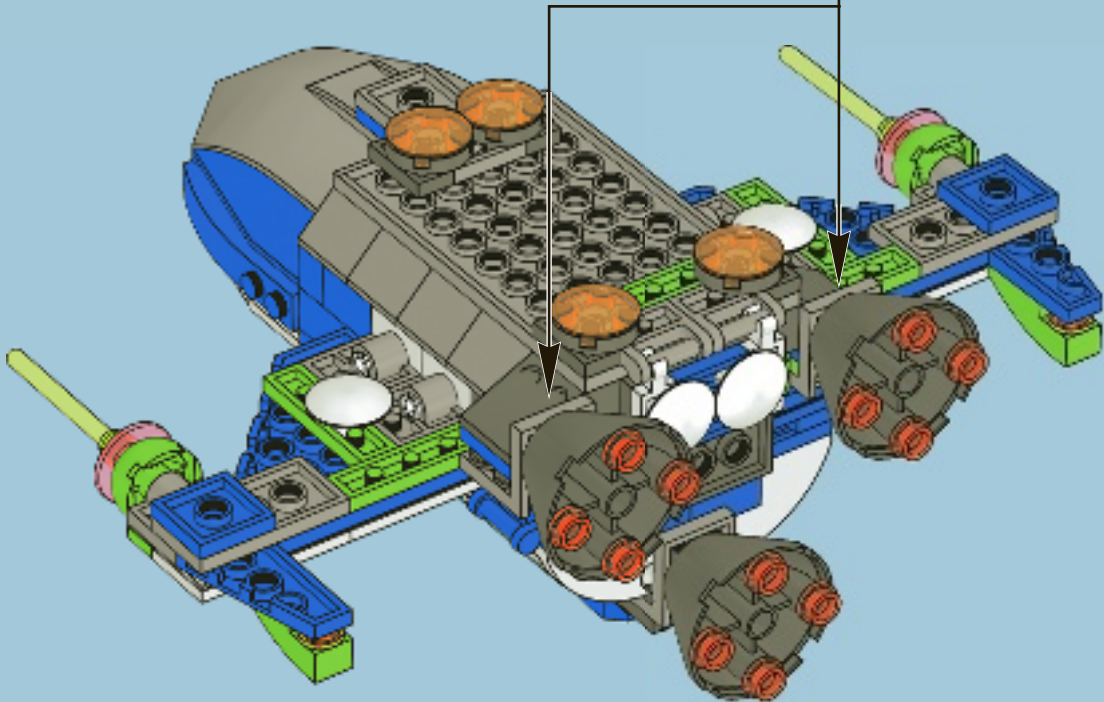
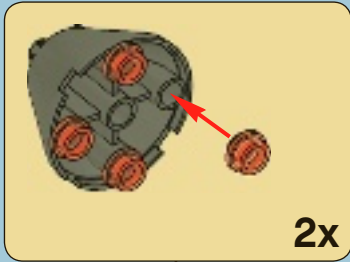

39

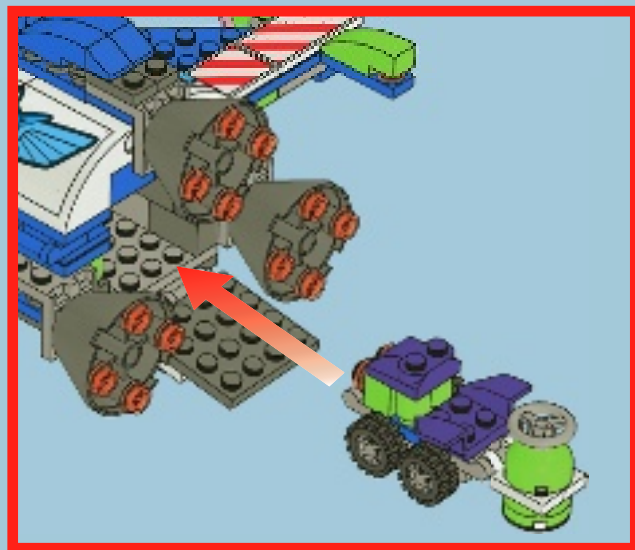
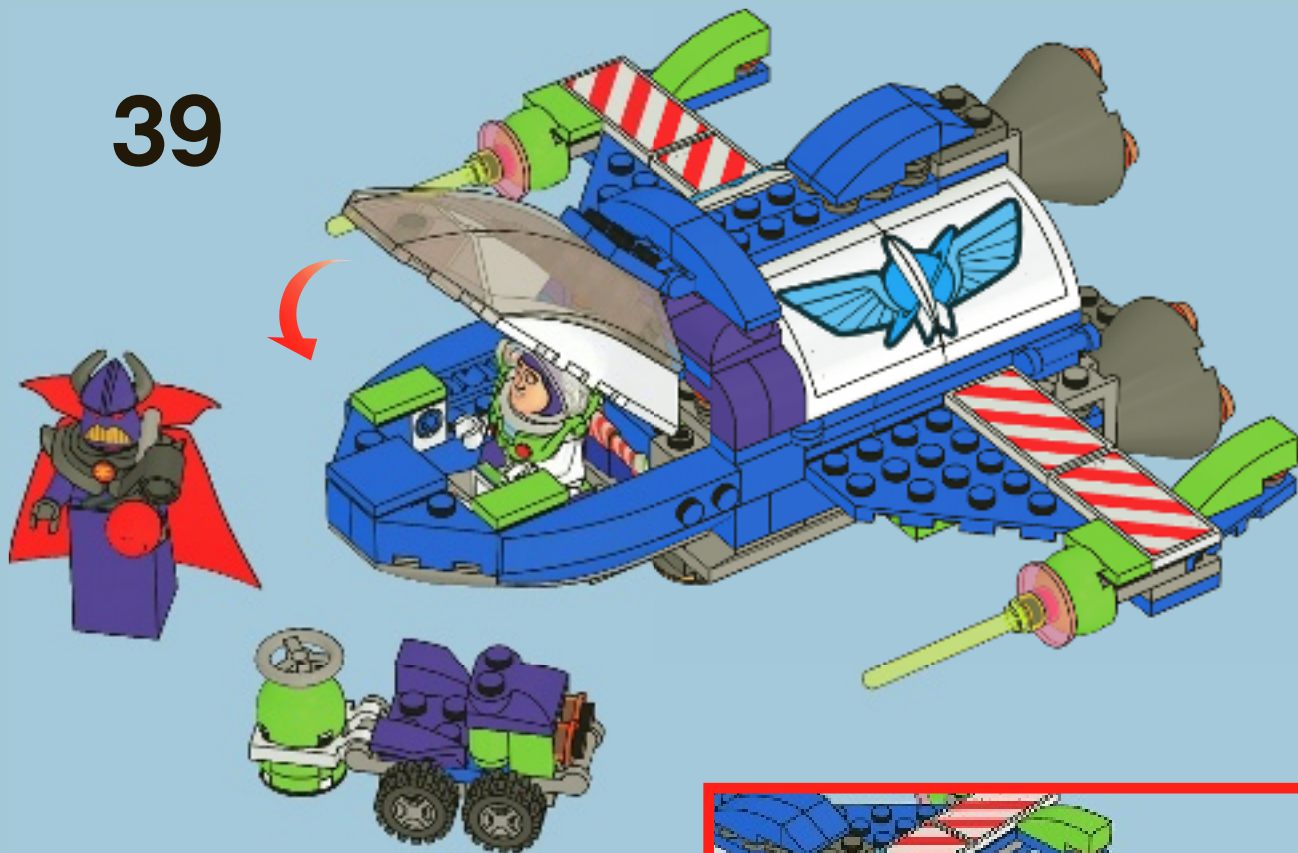





Disney · PIXAR  
**Toy  
STORY**

LEGO and the LEGO logo are trademarks of the LEGO group.  
©2010 The LEGO group.  
© Disney/Pixar.





Disney · PIXAR  
**Toy  
STORY**



**7590**



**7595**



**7594**





Disney · PIXAR  
**Toy  
STORY**

LEGO and the LEGO logo are trademarks of the LEGO group.  
©2010 The LEGO group.  
© Disney/Pixar.

**7591**



**7592**







Customer Service

Kundenservice

Service Consommateurs

Servicio Al Consumidor

[www.lego.com/service](http://www.lego.com/service) or dial



00800 5346 5555 :



1-800-422-5346 :



FREE! GRATIS! GRATUIT!



club  
MAGAZINE™

www.LEGOclub.com



00800 5346 5555\*

1-866-534-6258 • 1-877-518-5346

US & Canada only

Canada seule ment



VISIT THE WORLD'S  
BIGGEST LEGO® SHOP!

www.LEGOshop.com

\* Freephone. Mobile charges may apply. \* Numéro sans Frais. Des Frais peuvent s'appliquer avec les téléphones cellulaires. \* Gebührenfrei, Kosten für Anrufe aus Mobilfunknetzen können abweichen.  
\* Gratis telefonnummer vanaf vaste lijn. \* Det er ett gratis nummer, när du ringer från FastTeleFon. \* Det är gratis, när du ringer från en Fast TeleFon.





# WIN!

Go to [www.nielsen.com/LEGO](http://www.nielsen.com/LEGO) to fill out a survey for a chance to win a cool LEGO® Product. No purchase necessary. Open to all residents where not prohibited.

 [www.LEGO.com](http://www.LEGO.com)



## [www.nielsen.com/LEGO](http://www.nielsen.com/LEGO)

### GEWINNE! WIN!

Nimm an der Umfrage auf [www.nielsen.com/LEGO](http://www.nielsen.com/LEGO) teil und hab die Chance ein cooles LEGO® Produkt zu gewinnen!

Die Teilnahme am Gewinnspiel führt zu keinerlei Kaufverpflichtungen. Teilnahme in allen nicht ausgeschlossenen Ländern möglich.

Ga naar [www.nielsen.com/LEGO](http://www.nielsen.com/LEGO), vul een enquêteformulier in en maak kans op een cool LEGO® product.

Geen aankoopverplichting. Iedereen mag deelnemen, uitgezonderd ingezetenden van landen waar een enquêteverbod geldt.

### GAGNE! 当てよう!

Visite [www.nielsen.com/LEGO](http://www.nielsen.com/LEGO) pour répondre à un questionnaire et avoir une chance de gagner un produit LEGO® très cool!

Aucune obligation d'achat. Ouvert à tous les résidents des pays autorisés.

[www.nielsen.com/LEGO](http://www.nielsen.com/LEGO)にアクセスして、アンケートにご記入ください。当選者にはレゴ®製品を差し上げます。

お買い上げの必要はありません。

禁止されていない限り、すべての皆様にご利用いただけます。