



AVATAR™

75576





Get excited about our new packaging!

We're switching from plastic to paper-based packaging. That's why you might find a mix of paper and plastic in our boxes!

Nos nouveaux emballages vous emballeront !

Nous passons des emballages en plastique aux emballages à base de papier. C'est pourquoi vous pourriez trouver un mélange de papier et de plastique dans nos boîtes !

¡Te presentamos nuestros nuevos empaques!

Estamos sustituyendo las bolsas de plástico por bolsas con base de papel. ¡Por eso, puedes encontrar una mezcla de papel y de plástico en nuestras cajas!

[LEGO.com/sustainable-packaging](https://www.lego.com/sustainable-packaging)



BUILDER



Apple and the Apple logo are trademarks of Apple Inc., registered in the U.S. and other countries and regions. App Store is a service mark of Apple Inc. Google Play and the Google Play logo are trademarks of Google LLC. Tencent and the Tencent logo are trademarks of Tencent Inc.

LEGO.com/devicecheck

EN Ask parents' permission before going online | DE Eltern um Erlaubnis bitten, bevor du online gehst | FR Demande l'autorisation d'un parent avant d'aller en ligne | IT Chiedi il permesso ai tuoi genitori prima di andare online | ES Pídeles permiso a tus papás antes de conectarte a Internet | PT pede autorização aos pais antes de acederes online | JA オンラインになる前に ほかの方のきよかもをもらおう | ZH 上网前应先征得父母的同意 | KO 온라인 접속 전에 보호자 동의가 필요합니다 | RU Спроси разрешения у родителей, прежде чем заходить в интернет | PL Poproś rodziców o zgodę, zanim wejdiesz do Internetu | CS Než půjdeš na internet, požádej rodiče o svolení | SK Skôr než pôjdeš na internet, vypýtaj si povolenie od rodičov | HU Kérj szülői engedélyt, mielőtt online csatlakoznál! | RO Cere permisiunea părinților înainte de a te conecta online | BG Поискайте разрешение от родител, преди да влезете онлайн | LV Pirms došanās tiešsaistē palūdz atļauju vecākiem | ET Enne Interneti kasutamist küsi vanematelt luba | LT Prieš prisijungdami prie interneto, atsilkauskite tėvų

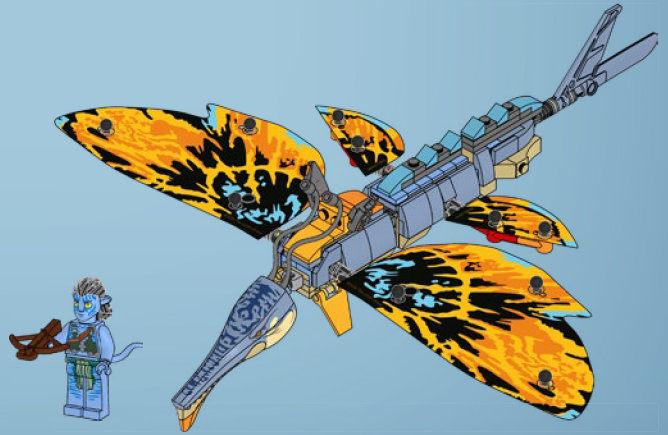
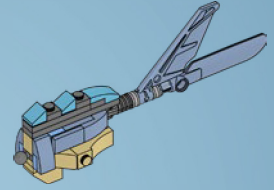

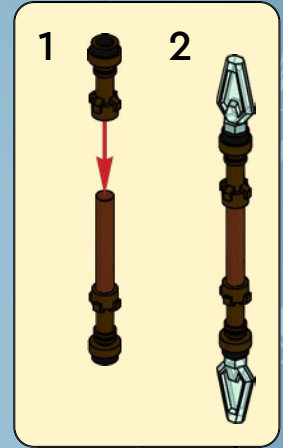
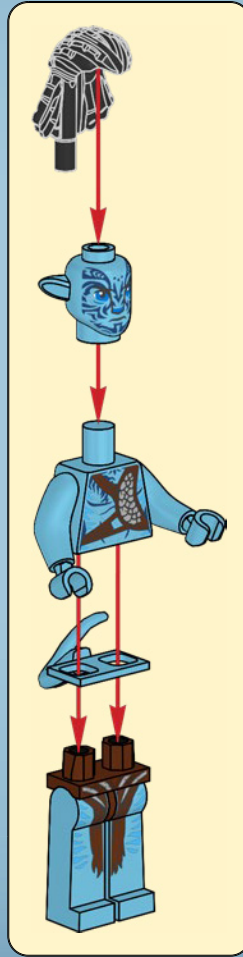



1x

1

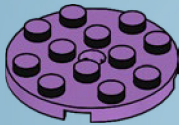

1x

2

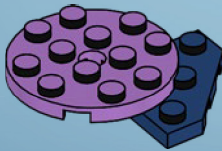

2x

3



1x



1x

4

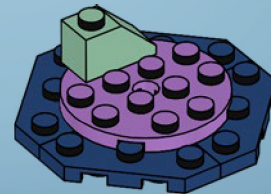



2x

5

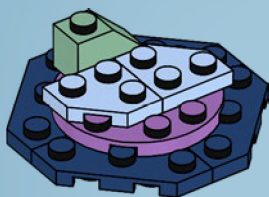

1x



1x

6

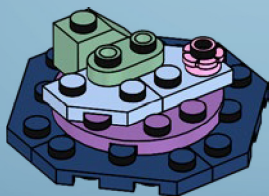

1x

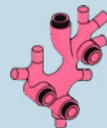

1x

7

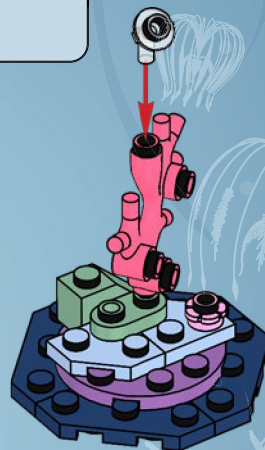

1x



1x

8









1x

1x

1

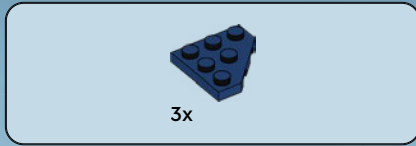
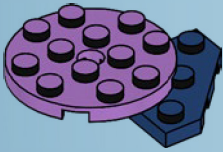

3x

2

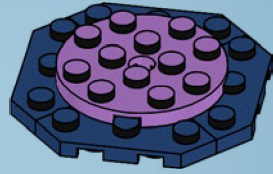

2x

1x

3

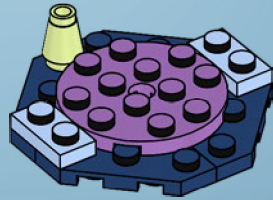

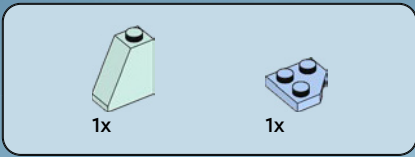

4

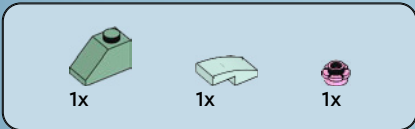
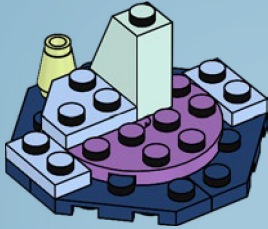

5

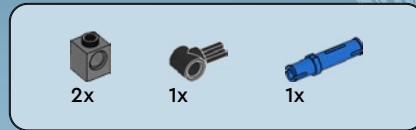
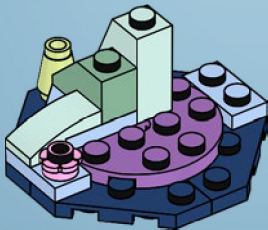

6

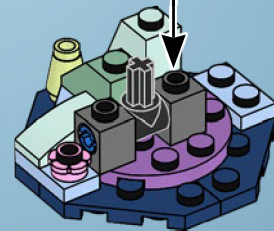
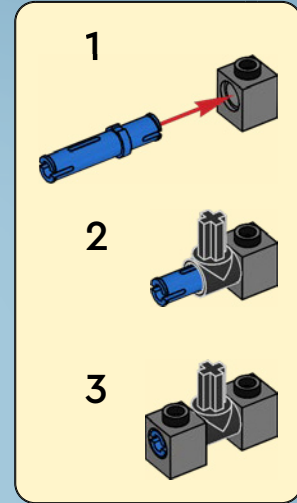



2x

7

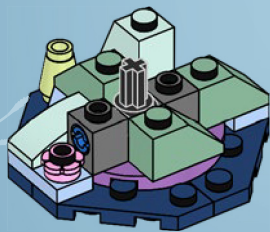

1x



1x



1x

8

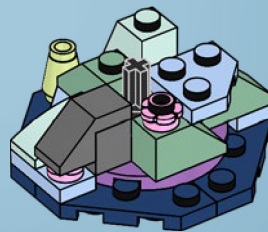

1x



1x



1x

9

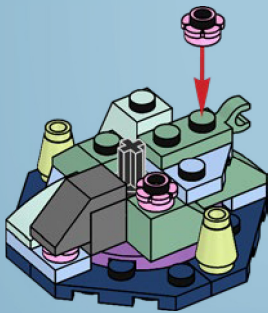

1x



1x



1x

10

1



2

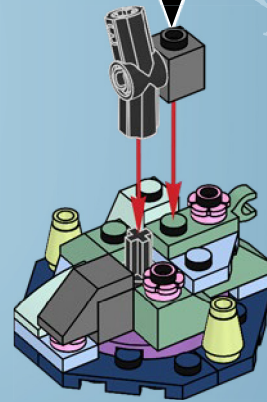
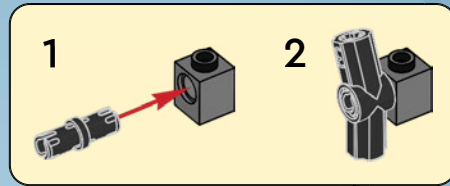



1x



1x



2x

11

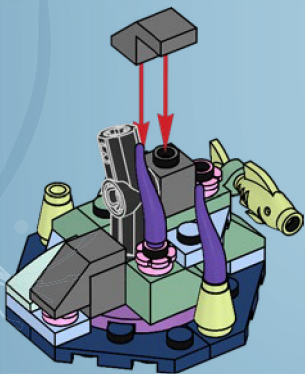

2x



1x

12

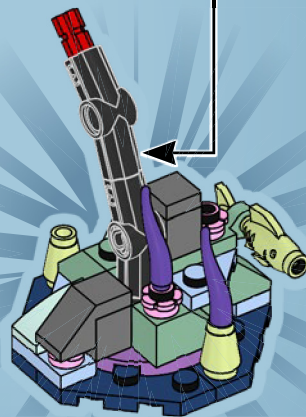
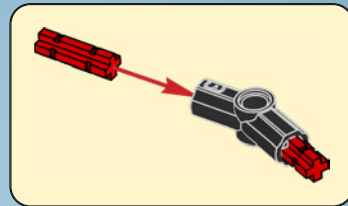

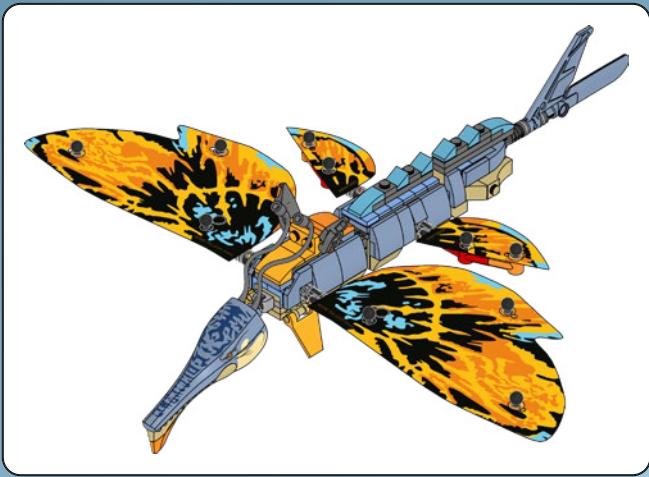

1x



1x

1

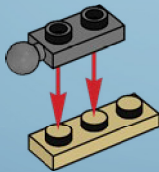

1x

2

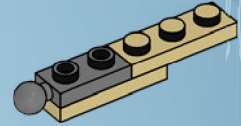

1x



1x

3

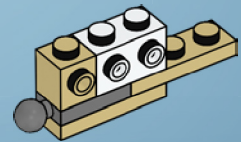

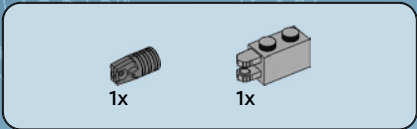

4

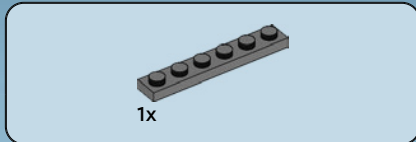
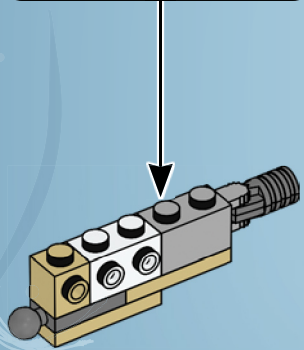
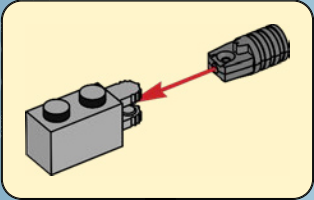

5

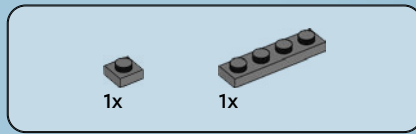
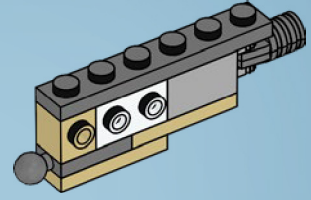

6

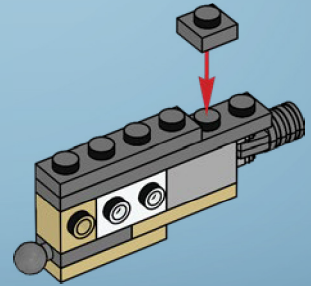



2x



2x



1x

7

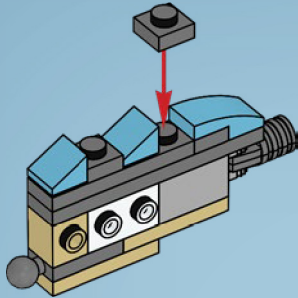

1x



1x

8

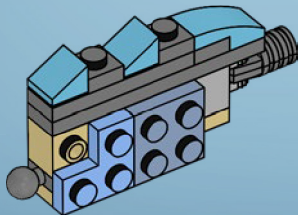

1x



1x

9

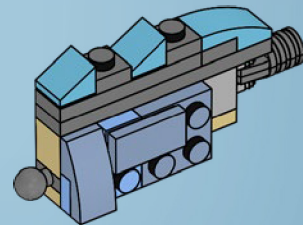



1x



1x

10

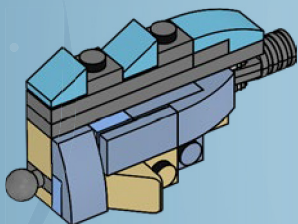

1x



1x

11

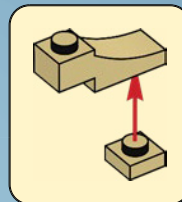
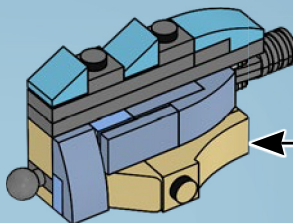

1x



1x

12

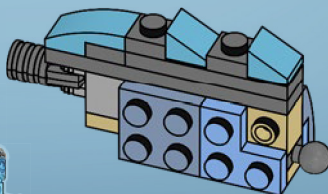



1x



1x

13

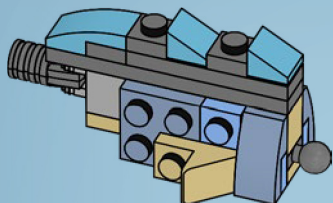

1x



1x

14

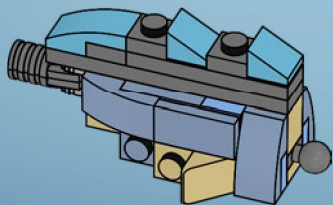

1x



1x

15

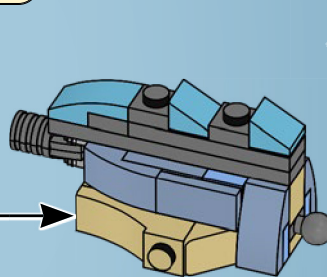
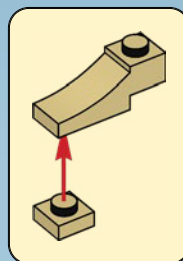

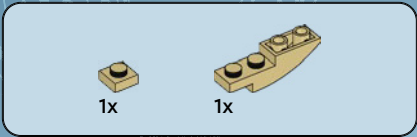

16

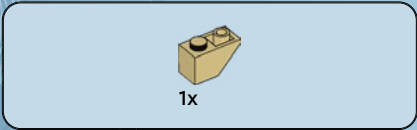
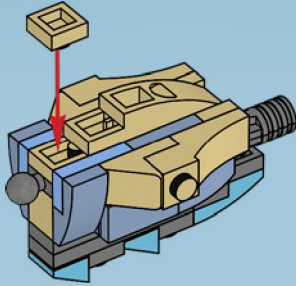

17

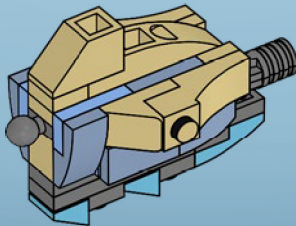

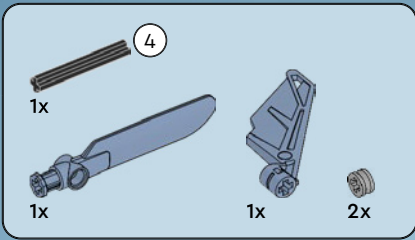

18

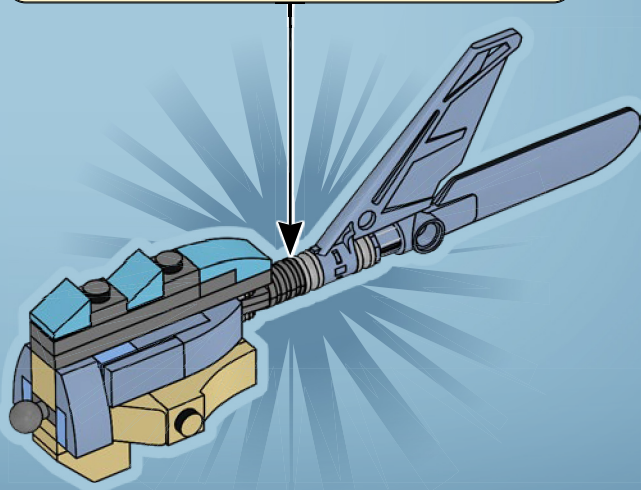
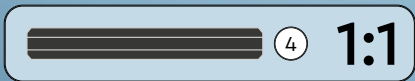
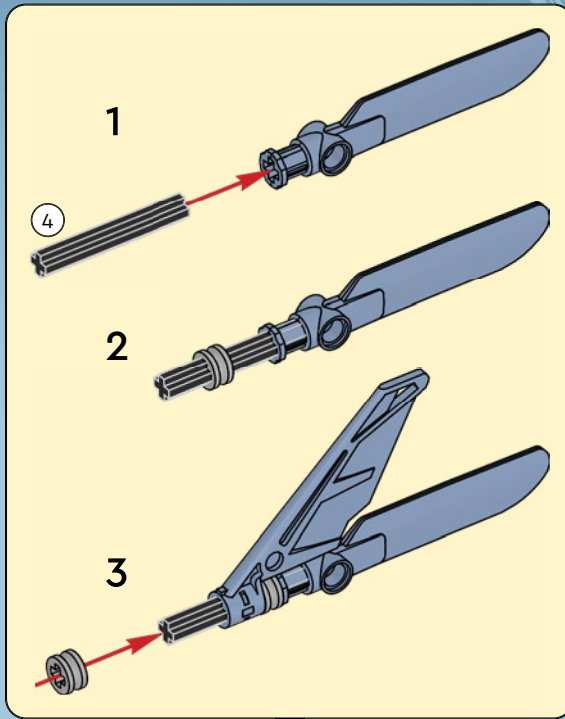





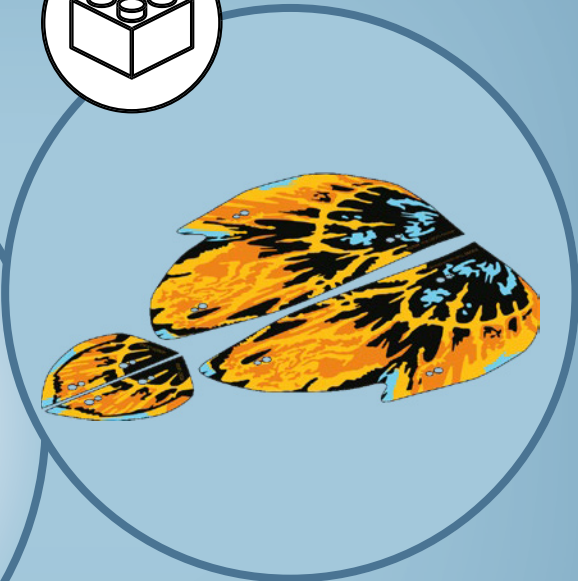
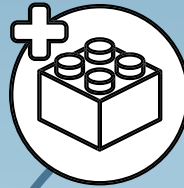

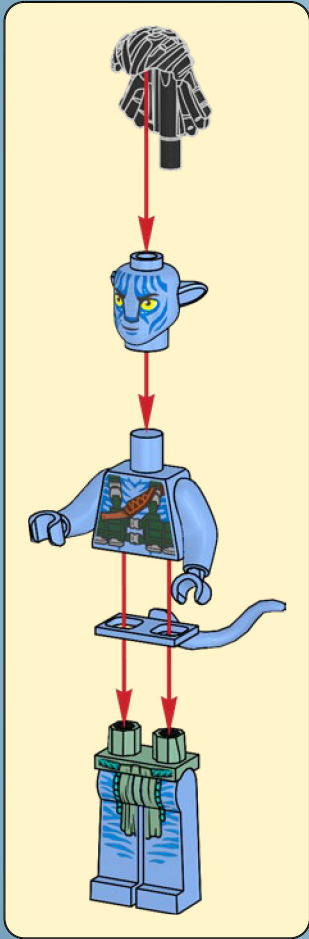

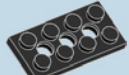
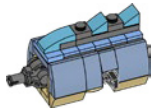

1x



1x

19

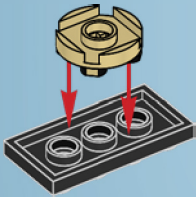

2x

20

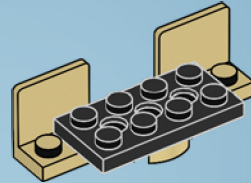

1x

21

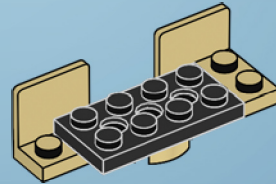



1x



1x



1x

22

1

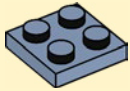

2

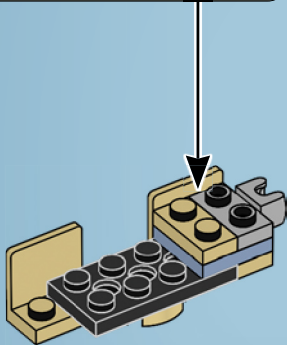
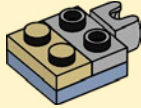

2x



2x

23

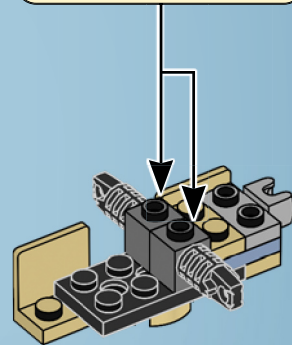
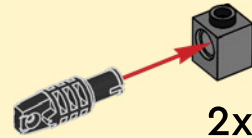



1x

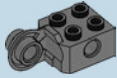

1x

24

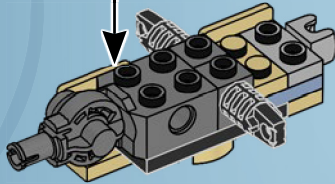
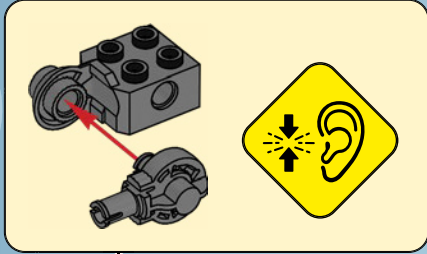

2x

25

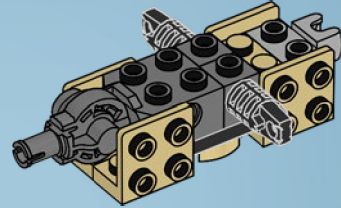

1x

26

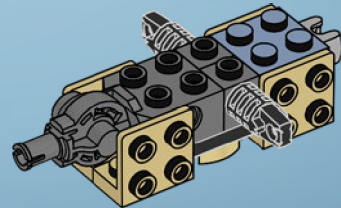



4x



2x

27

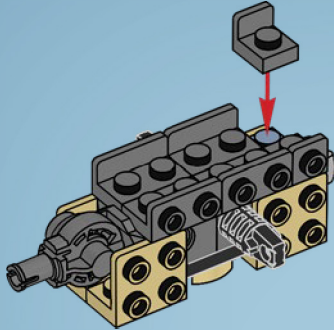

1x

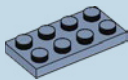

1x

28

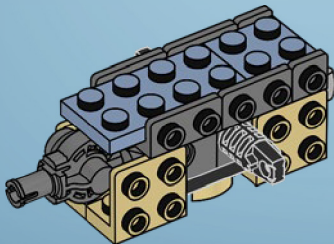

6x

29

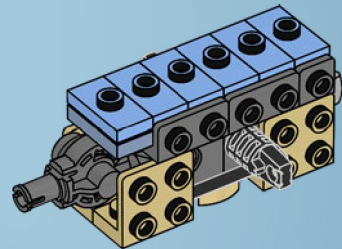

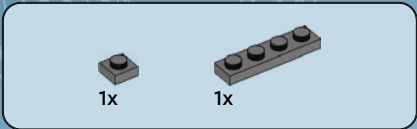

30

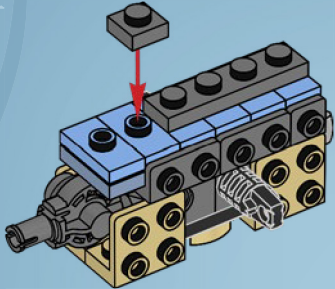

31

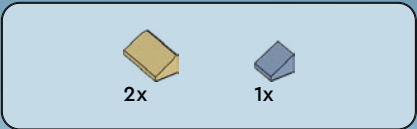
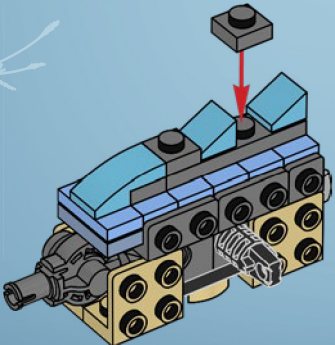

32

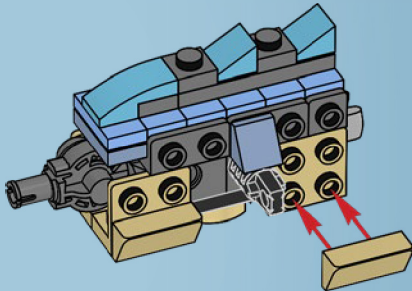

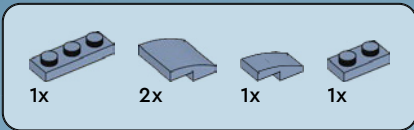

33

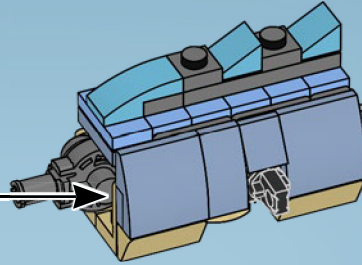
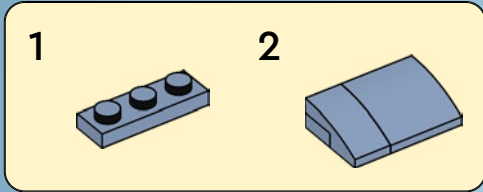
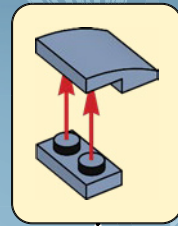

34

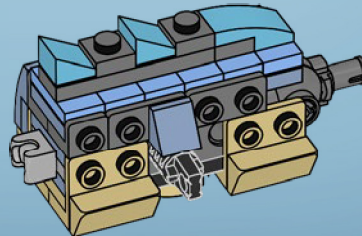

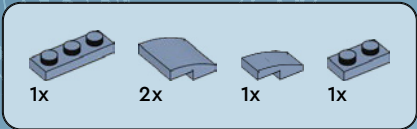

35

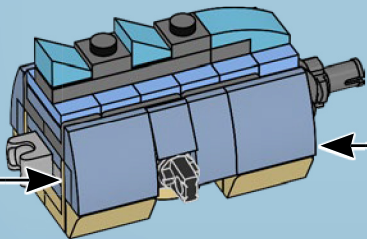
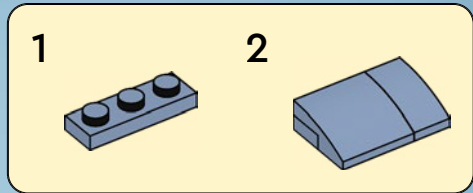
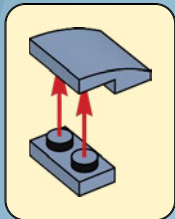

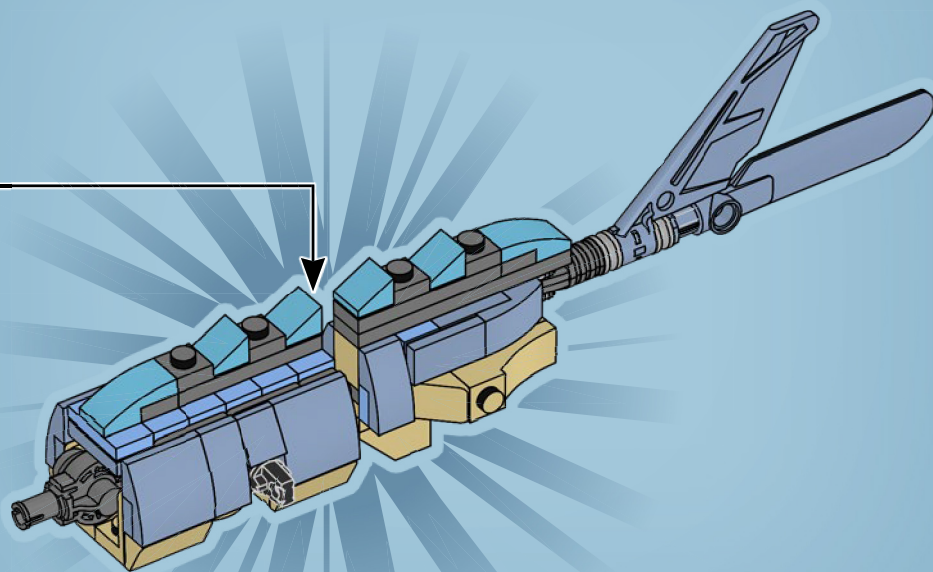

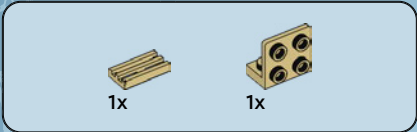
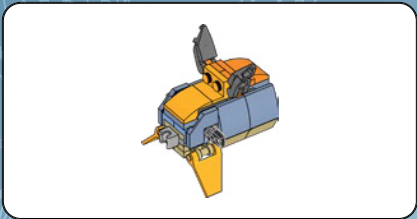

37



38

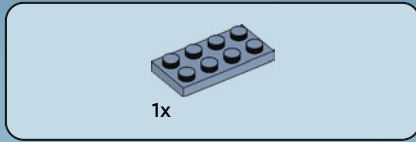
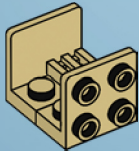

39

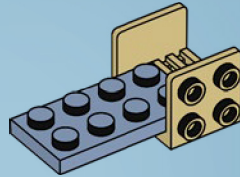

40

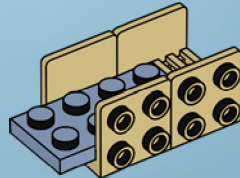



41

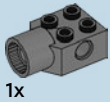
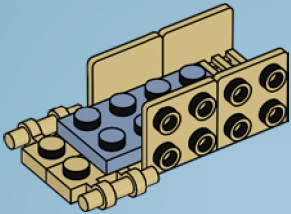

42

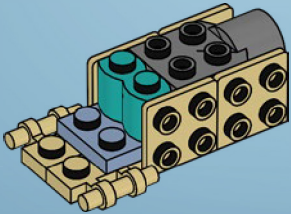

43

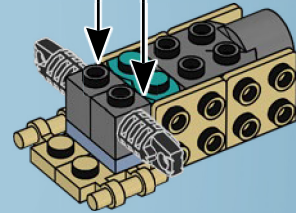
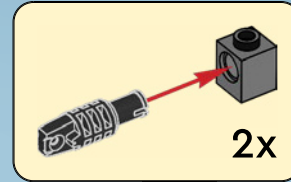



4x

44

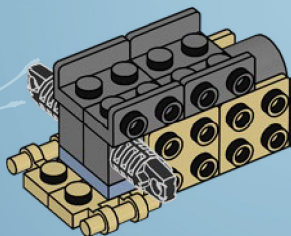

1x



1x

45

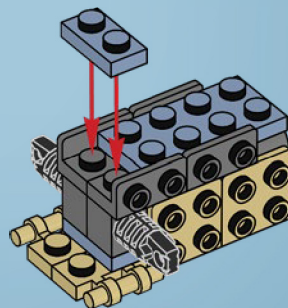



2x



1x



1x



2x

46

1

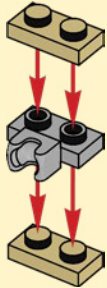

2

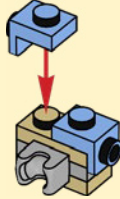

3

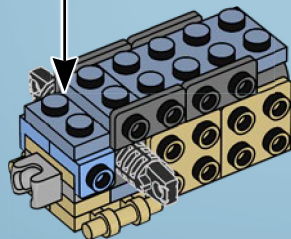
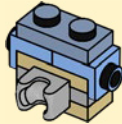

1x

47

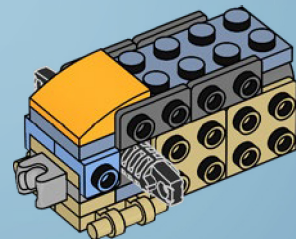



48

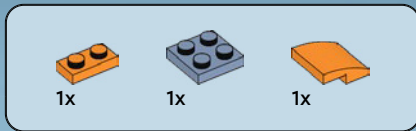
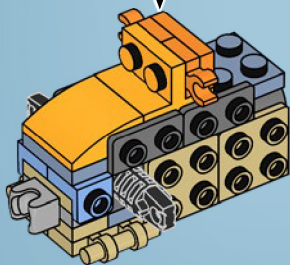
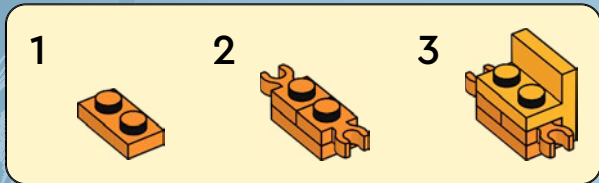

49

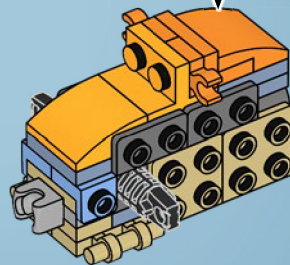
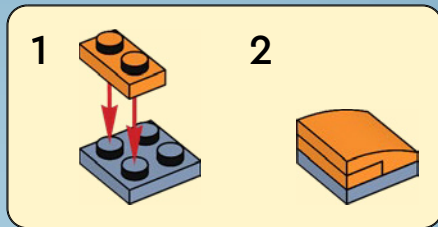



1x

50

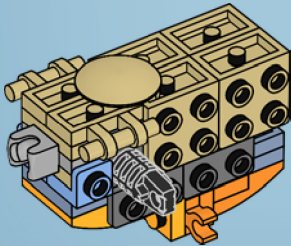

2x



1x

51

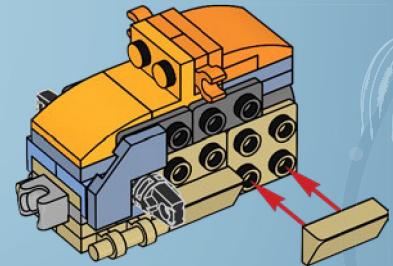

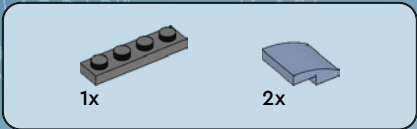

52

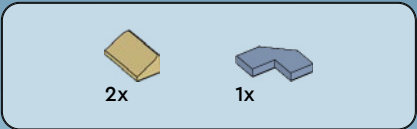
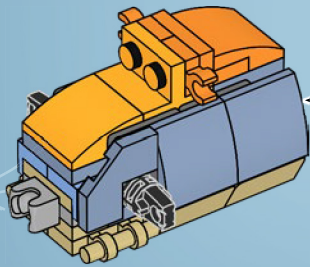
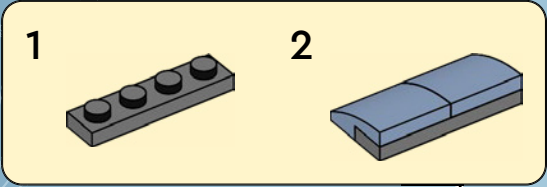

53

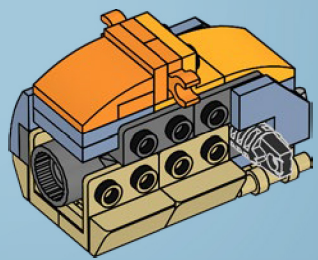



1x



2x

54

1

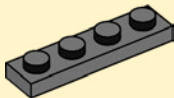

2

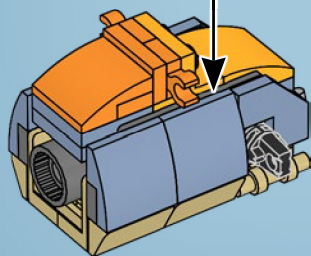
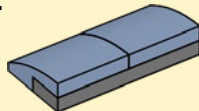

1x



1x



2x



2x

55

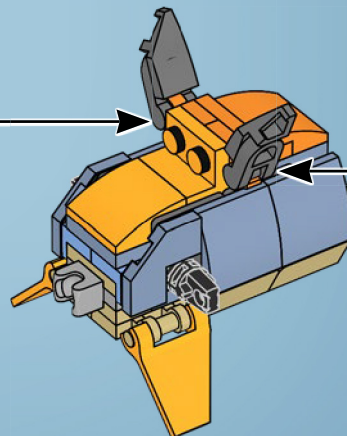
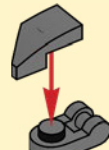

56

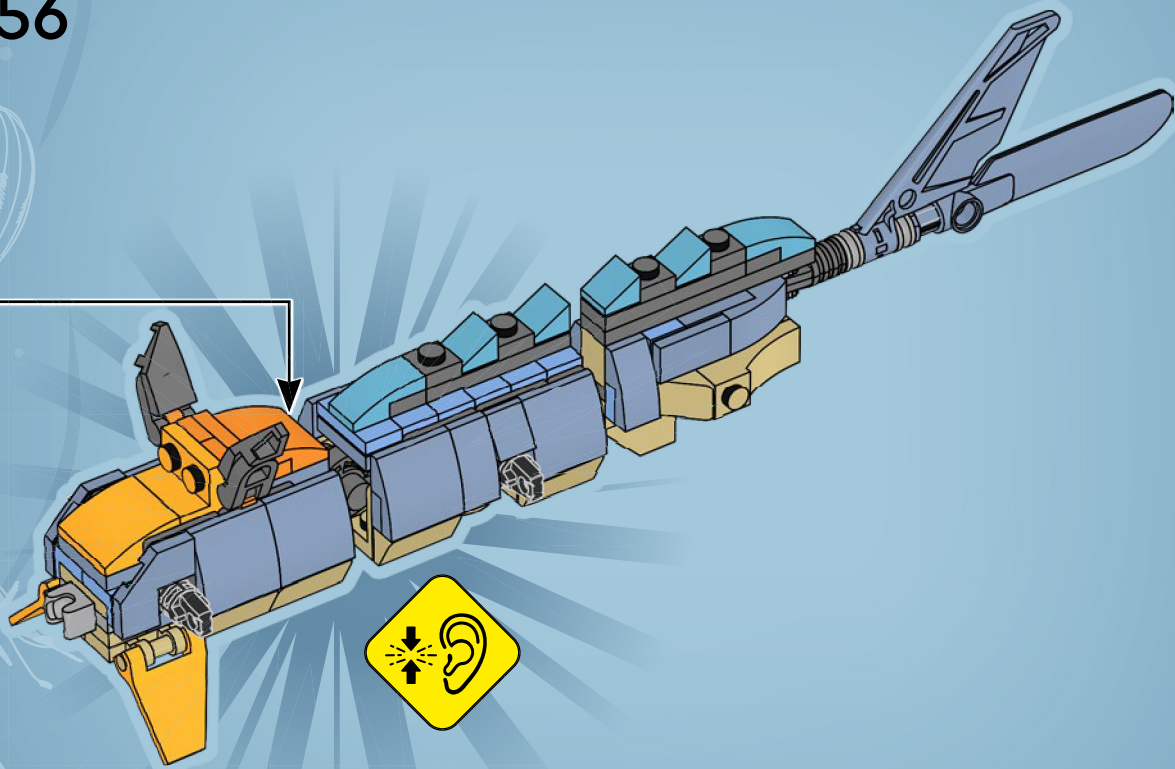

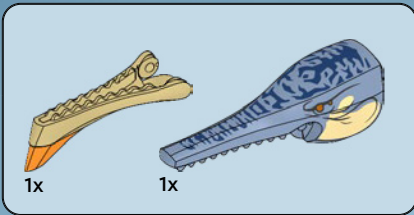

57

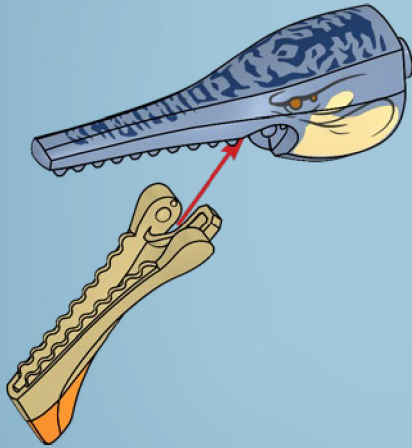

58

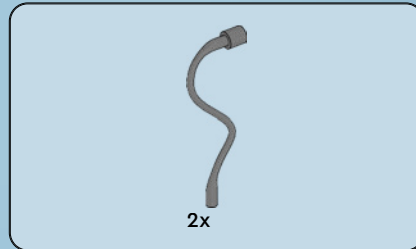
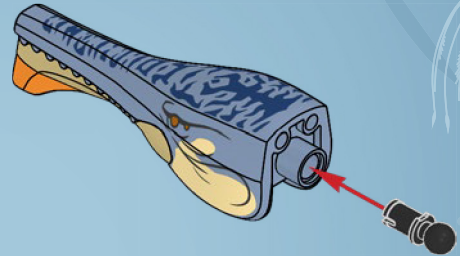

59

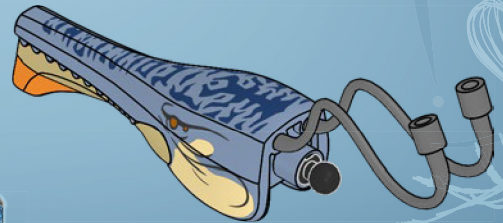

60

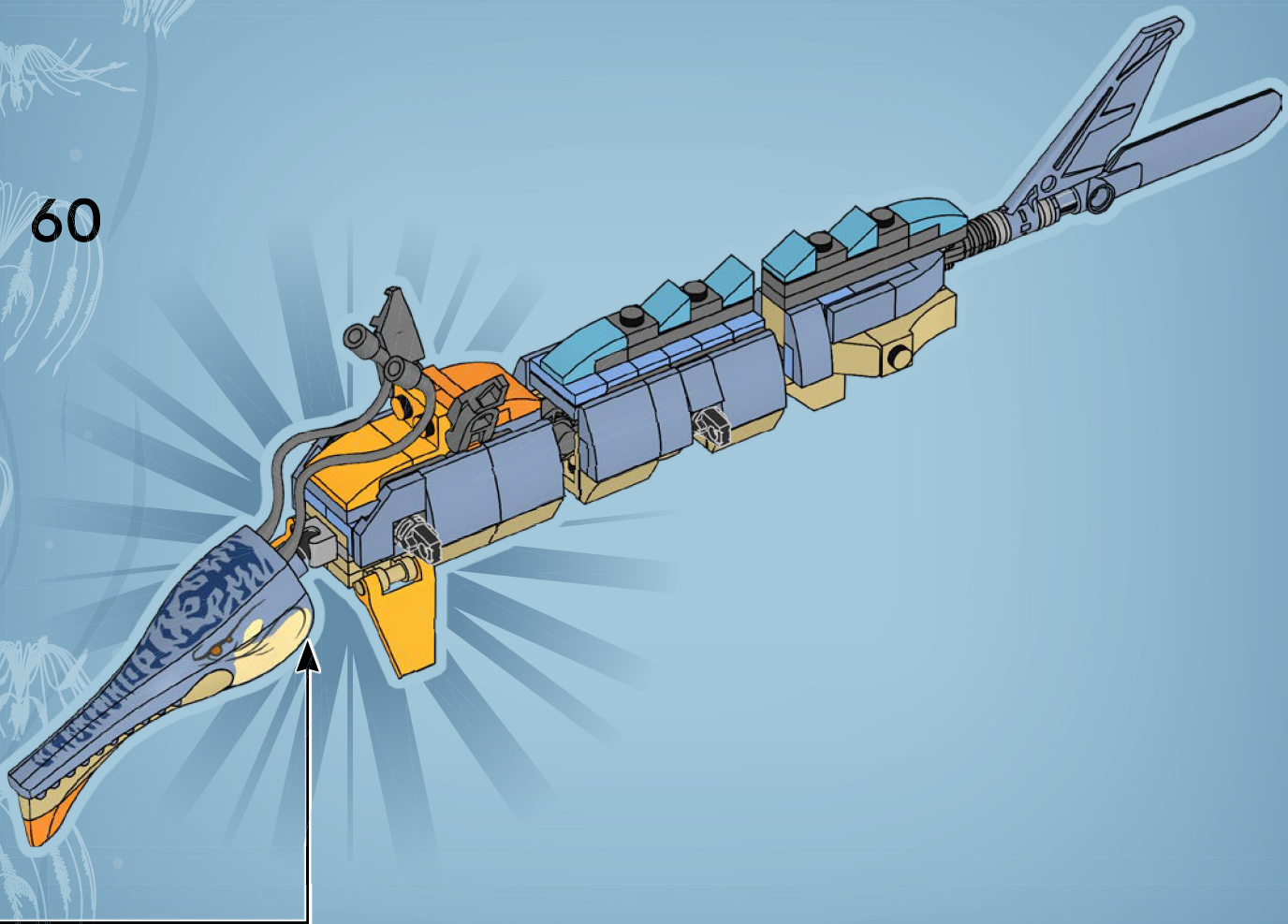

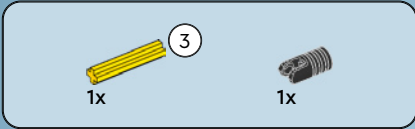
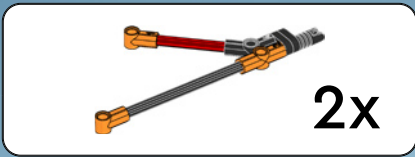

61

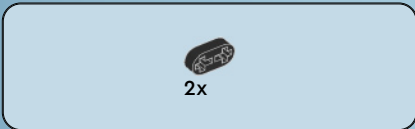
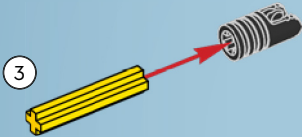

62

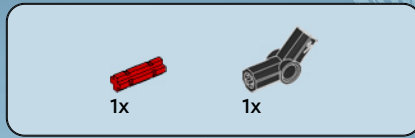
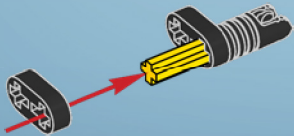

63

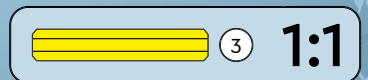
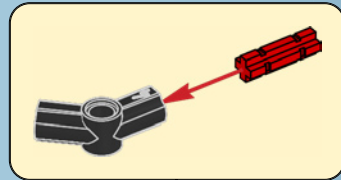



1x



6



10

1:1

64

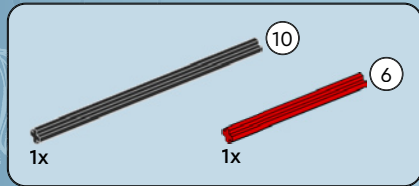

1x

1x

65

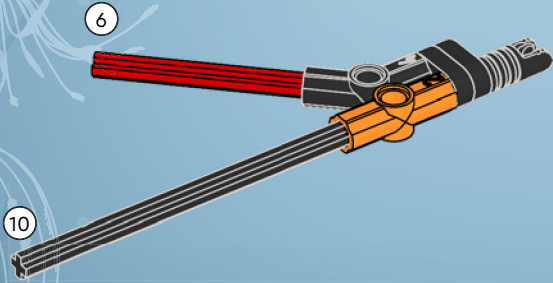

6

10



2x

66

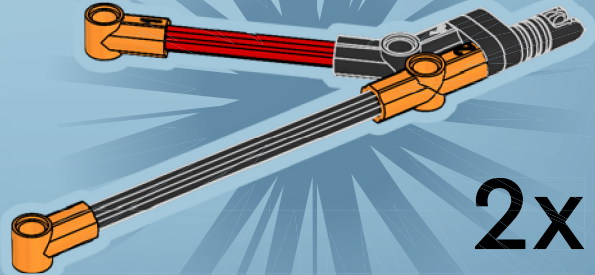

2x

67

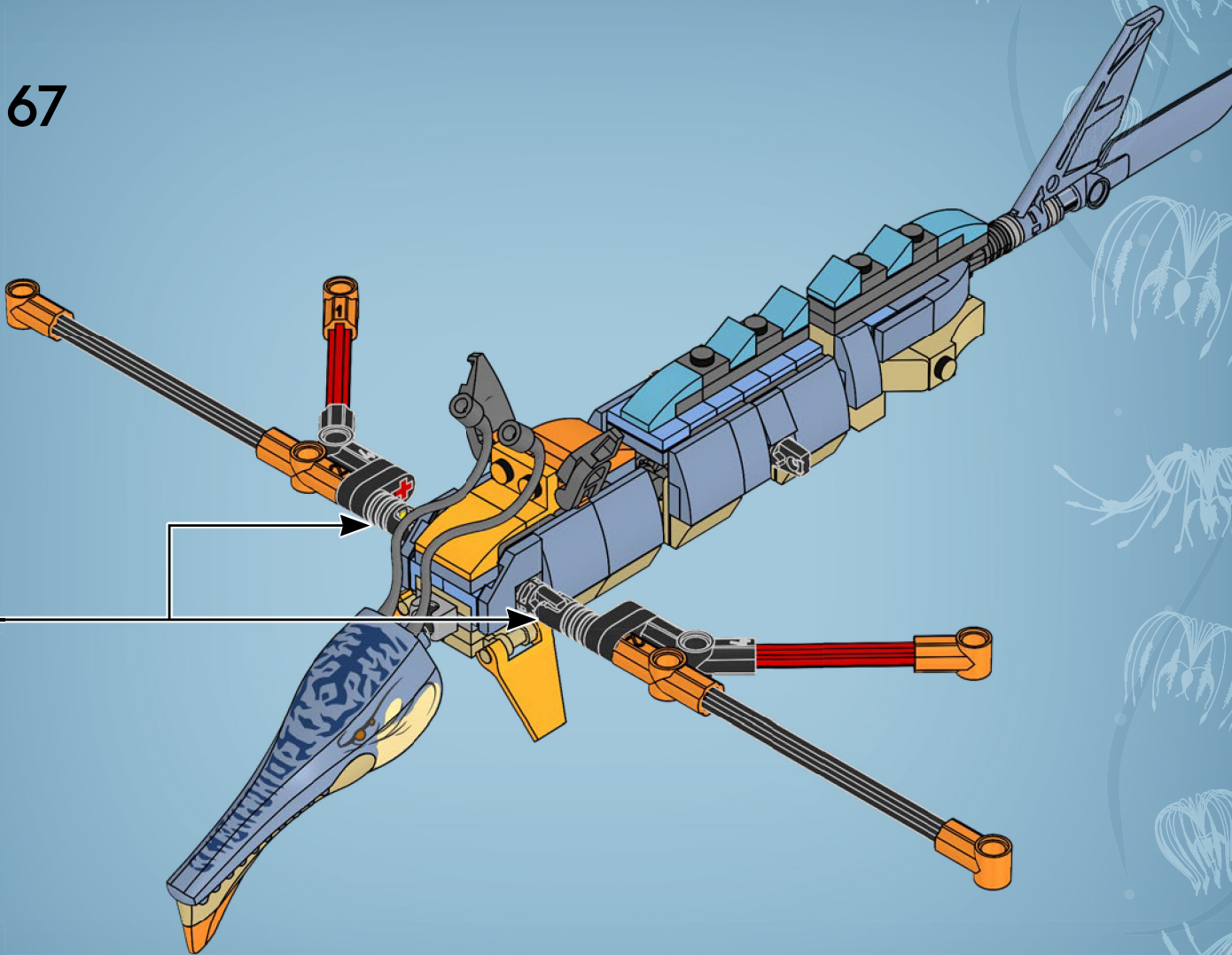



68

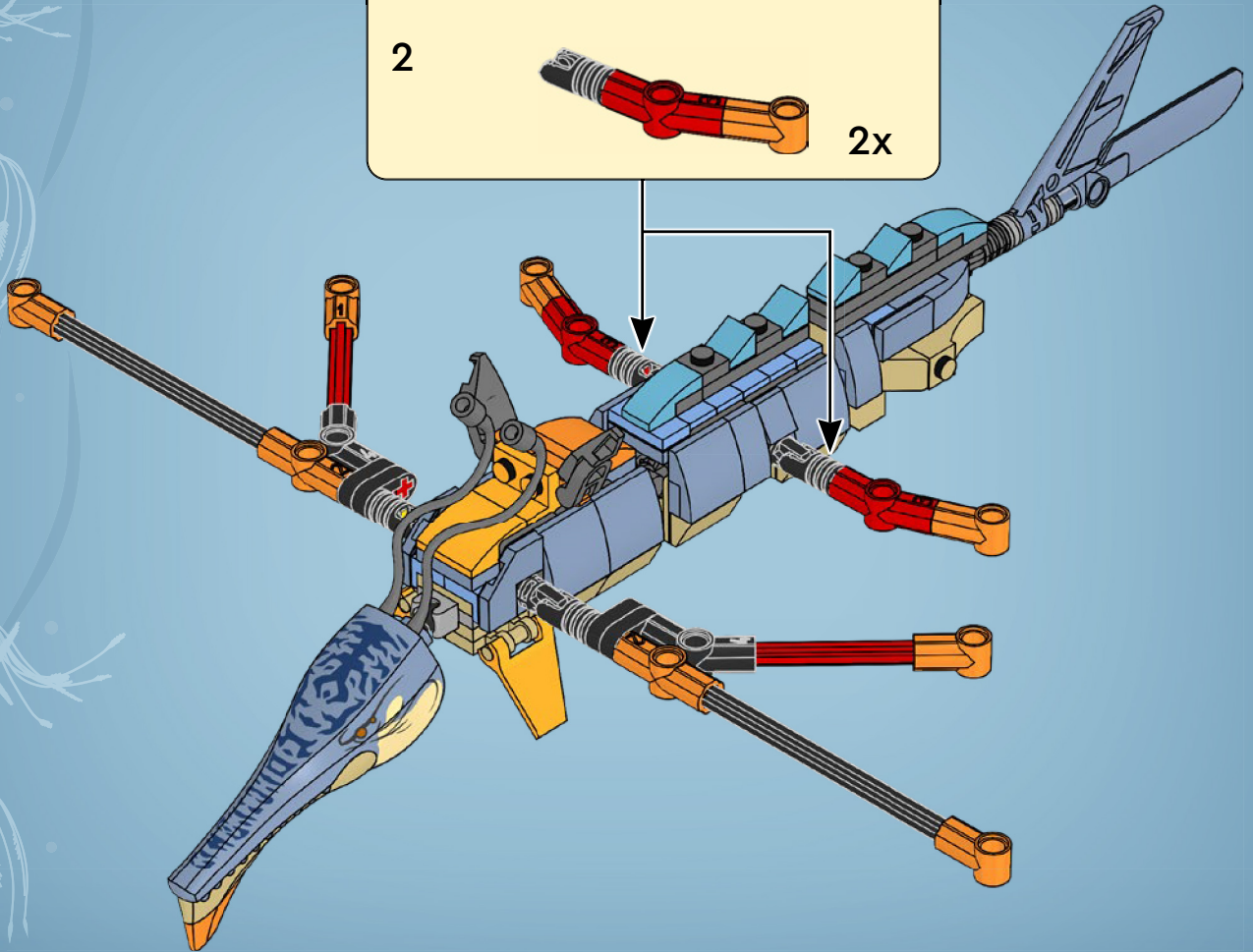
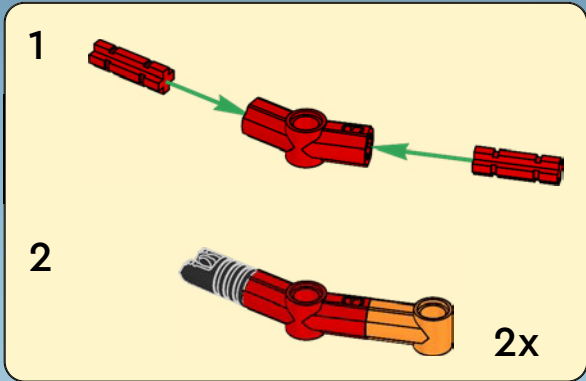



10x

69

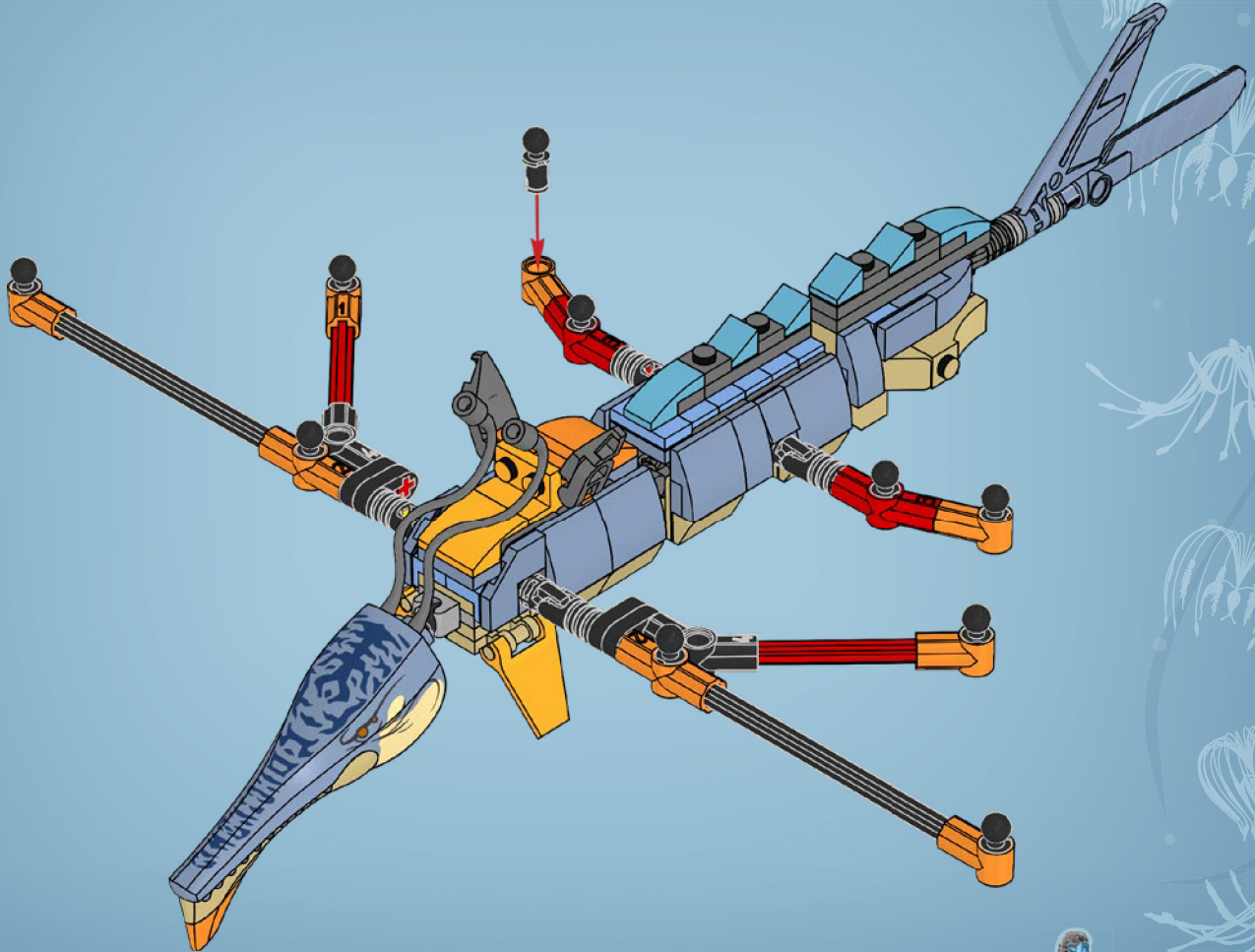

70

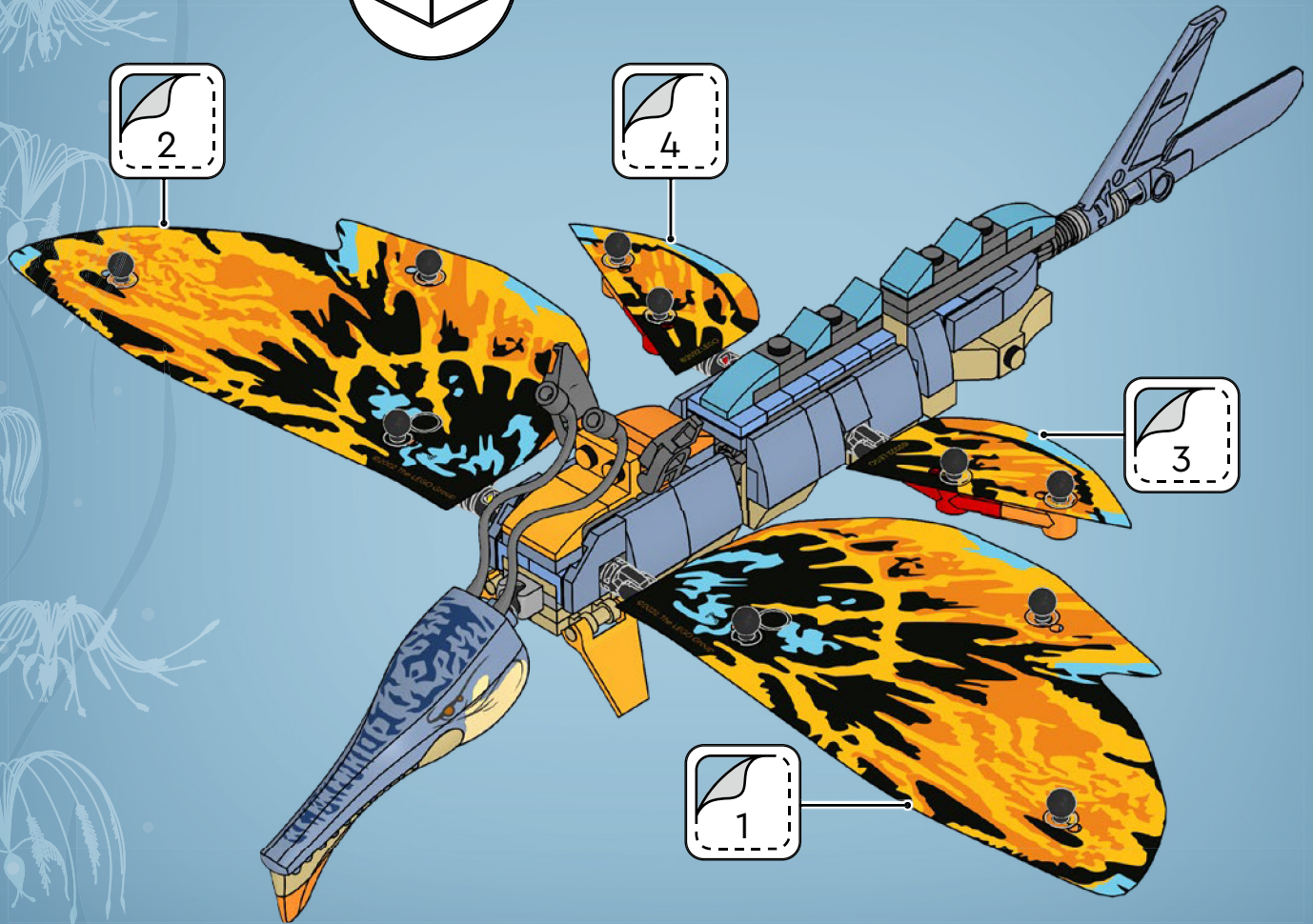
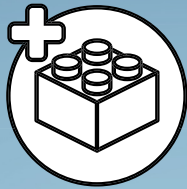



LEGO

AVATAR



75571



75572



75573



75574





75575



75576



75577



75578



75579





1x
4667575



3x
4159553



1x
4213568



8x
4624086



1x
4278422



1x
4140562



1x
4124456



4x
4113917



1x
4159196



2x
6069165



8x
6174925



2x
4140593



2x
4121921



2x
6328182



1x
6273851



1x
6421788



8x
4142865



2x
6261396



2x
6130002



1x
6299413



2x
6130007



11x
6344752



4x
6338428



2x
6412279



1x
6279875



4x
6271535



1x
6253260



4x
6271542



2x
6262897



2x
6261386



1x
370526



1x
370926

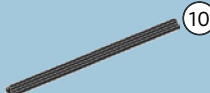

2x
373726



1x
6285587



1x
6385602



6x
6092601



2x
6332365



1x
6432225



1x
6325980



2x
6062686



2x
6434368



2x
6248079



1x
6430099



1x
6303004



1x
6409160



4x
6083976



1x
6354613



1x
6163294



2x
6141593



4x
6198156



6x
6179812



2x
6142505



1x
6424466



8x
6166865



6x
6062089



2x
6398674



2x
6142245



3x
6248957



1x
6411195



1x
6421787



8x
6110050



1x
6392165



2x
6365499



1x
6099730



1x
6451069



1x
6428805



1x
6434369



2x
6271165



2x
6043656



1x
6267136



7x
4210639



1x
6204668



6x
4210719



2x
6225494



1x
6265702



2x
6388119



1x
6204667



2x
6425976



2x
6168776



8x
6000606



1x
4522784



1x
6123814



1x
6278974



4x
4211001



1x
6343337



1x
4211056



4x
6421616



2x
6362254



4x
6212501



2x
6430673



2x
6133832



4x
4619520



1x
6421767



1x
6420861



2x
6071246



1x
6430050



6x
6332584



2x
6352223



2x
4177932



1x
6067913



2x
6271874



2x
6134717



3x
6420918



1x
6291414



1x
6292823



1x
6424660



[LEGO.com/service](https://www.lego.com/service)

YOU COULD

WIN



Scan this QR code or go to
LEGO.COM/PRODUCTFEEDBACK and give us
your short feedback about this LEGO® set for a
chance to win a cool LEGO prize.

Terms and Conditions apply*

DE: Du könntest GEWINNEN. Es gelten die Teilnahmebedingungen* **FR: Tu pourrais GAGNER.** Des conditions s'appliquent* **IT: Potresti VINCERE tu.** Termini e condizioni sono applicabili* **ES: Puedes GANAR.** Aplican términos y condiciones* **PT: Poderá GANHAR.** Aplicam-se termos e condições* **JA: プレゼント付き! 利用規約が適用されます*** **ZH: 轻松获奖. 条款和条件适用*** **KO: 상품의 주인이 되어보세요. 소정의 약관이 적용됩니다*** **RU: Вы можете ВЫИГРАТЬ.** Действуют положения и условия* **PL: Szansa na WYGRANĄ.** Obowiązują warunki korzystania* **CS: Máte šanci VYHRÁT.** Platí všeobecné smluvní podmínky* **SK: Máte šancu VYHRAŤ.** Platia všeobecné zmluvné podmienky* **HU: TE IS NYERHETSZ.** Felhasználási feltételek érvényesek* **RO: Ai putea CÂȘTIGA.** Se aplică termeni și condiții* **BG: Можете да СПЕЧЕЛИТЕ.** Има определени правила и условия* **LV: Tu vari LAIMĒT.** Ir spēkā noteikumi un nosacījumi.* **ET: Sul on võimalus VÕITA.** Kehtivad tingimused* **LT: Jūs galite LAIMĖTI.** Taikomos sąlygos*

*[LEGO.com/productfeedback-terms](https://www.lego.com/productfeedback-terms)

LEGO and the LEGO logo are trademarks of the/son des marques de commerce du/son marcas registradas de LEGO Group. ©2023 The LEGO Group.

TM & © 20th Century Studios

6449477