

LEGO

STAR
WARS

7259

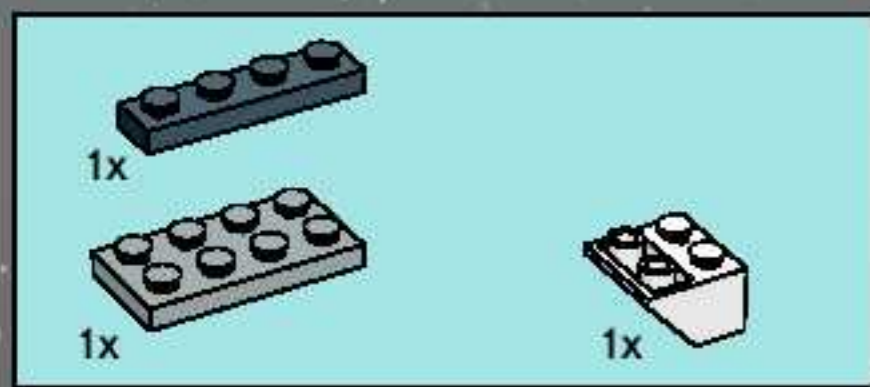

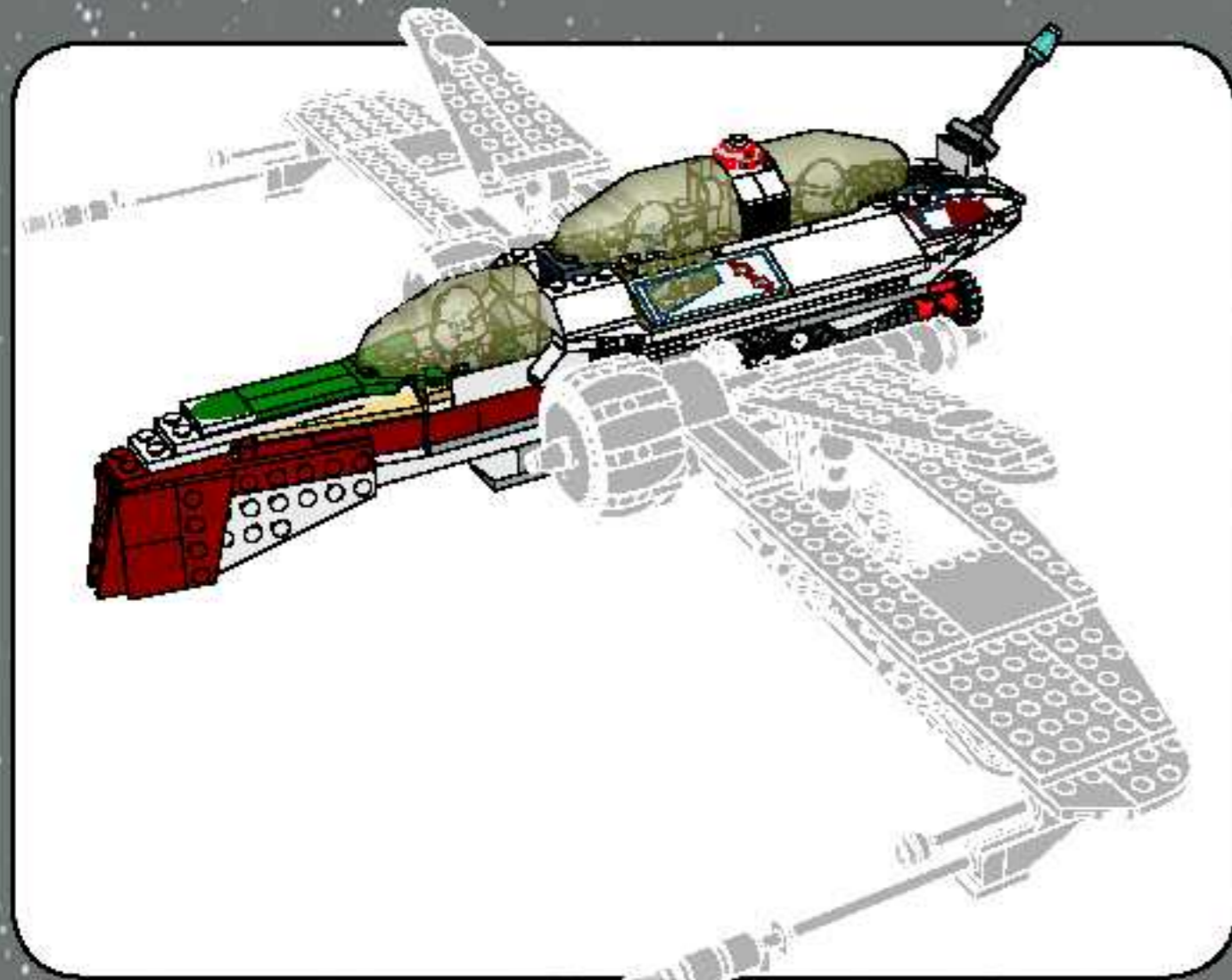
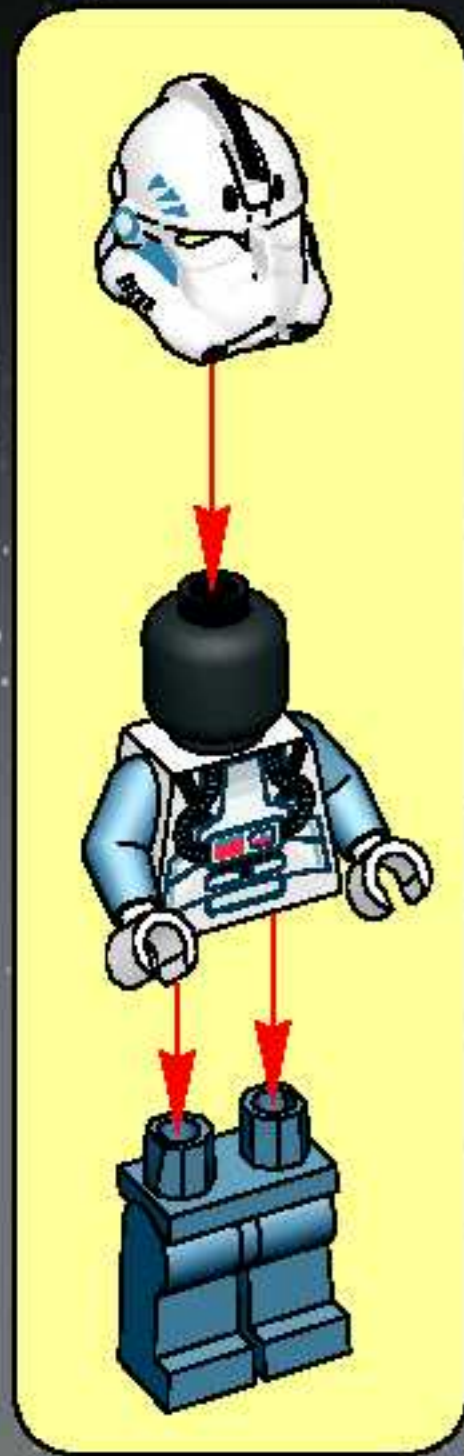

1

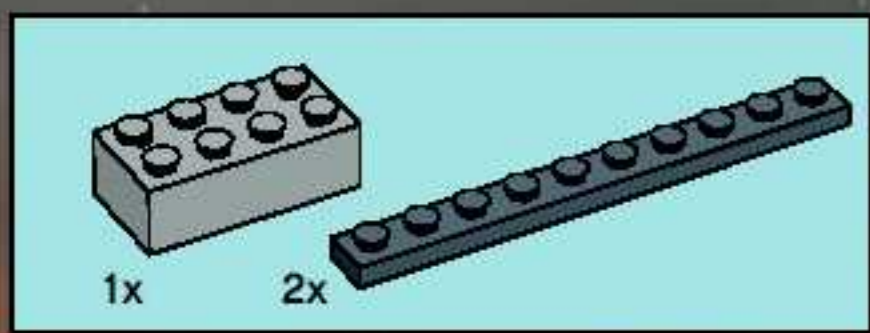
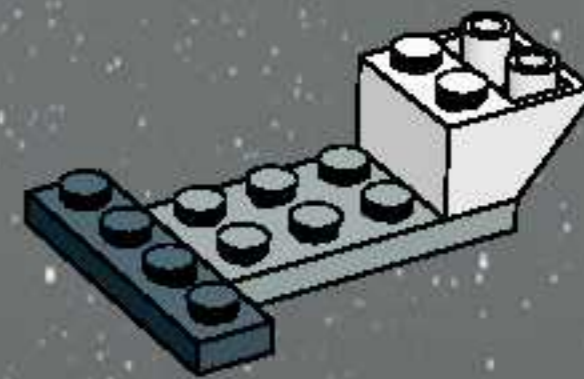

2

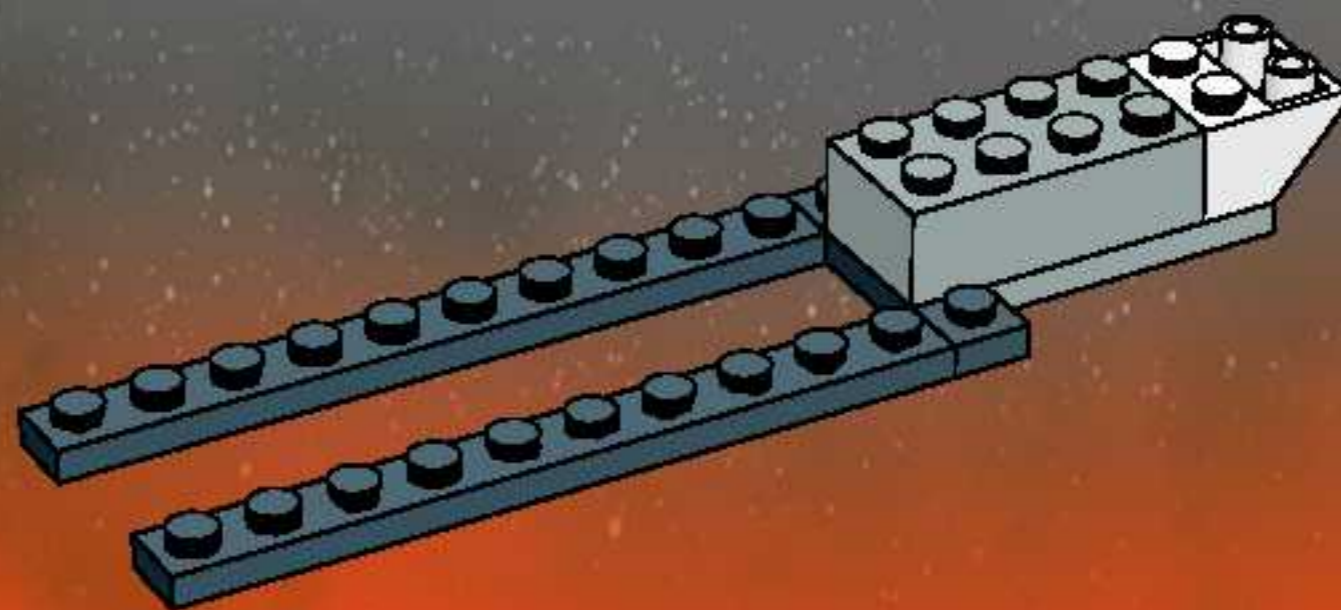

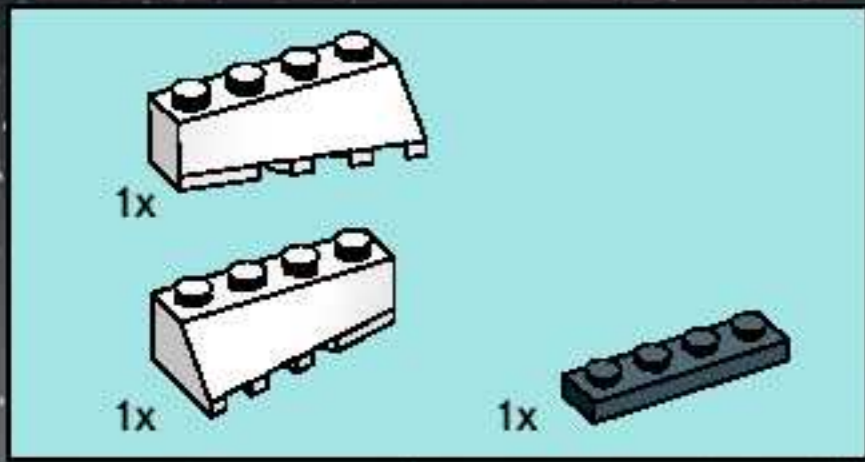

3

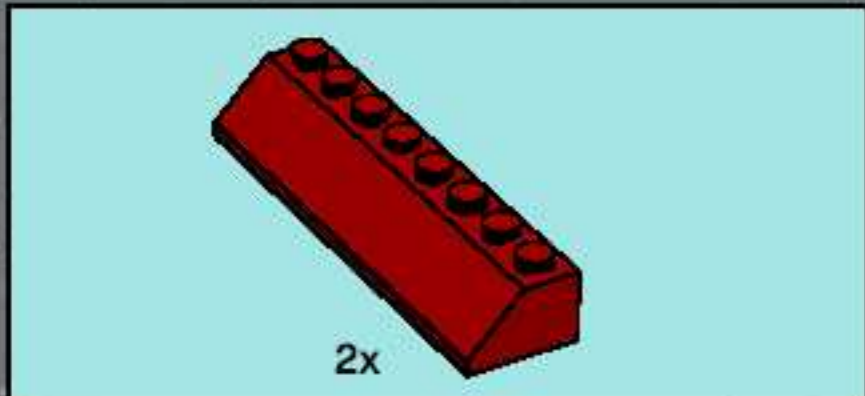
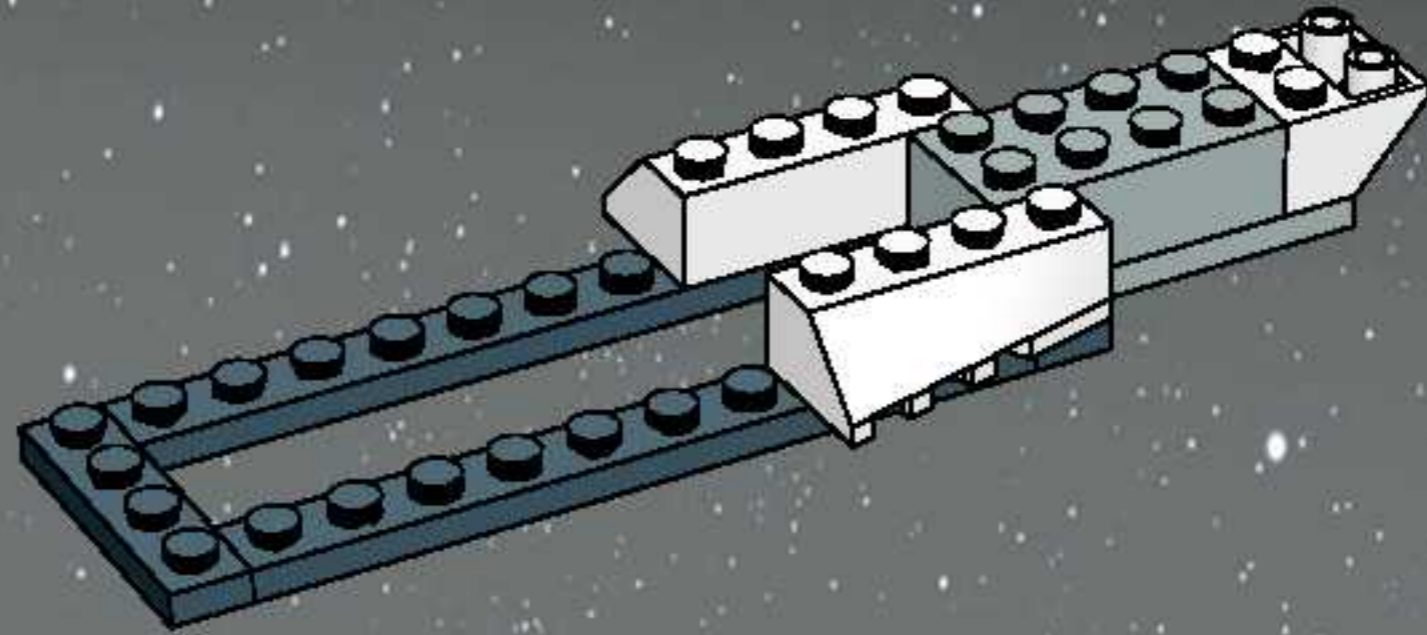

4

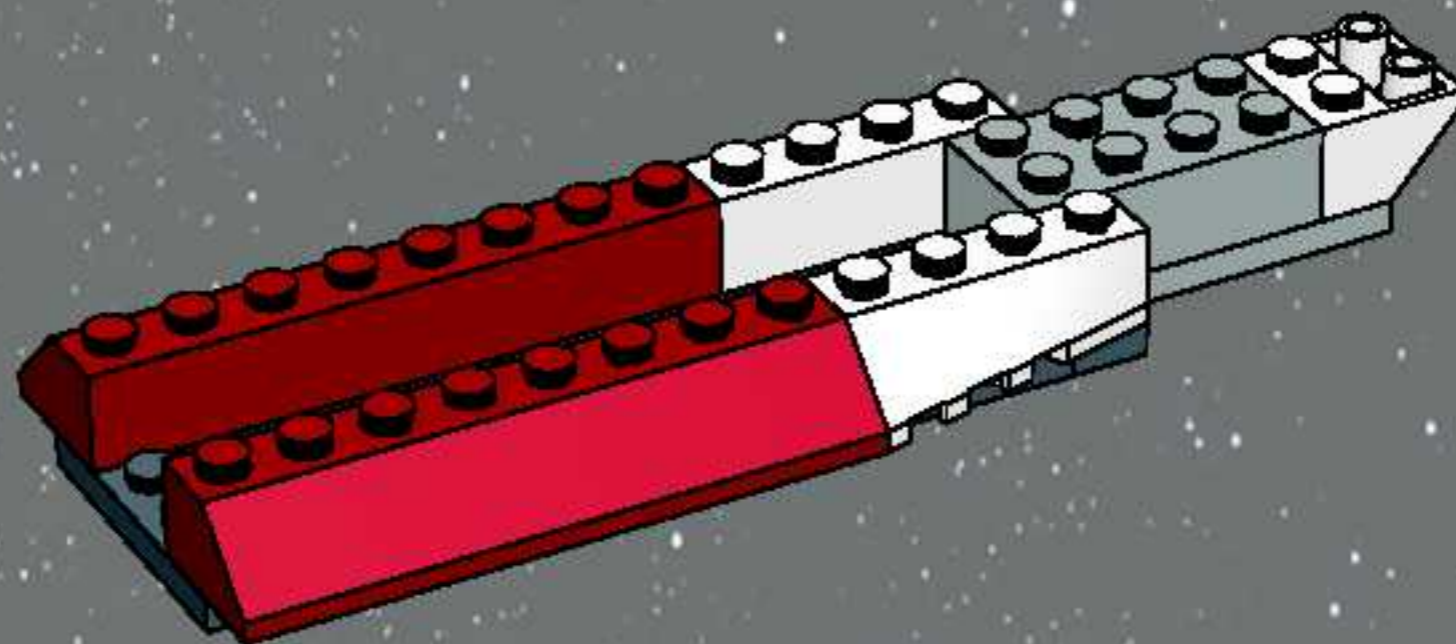

5

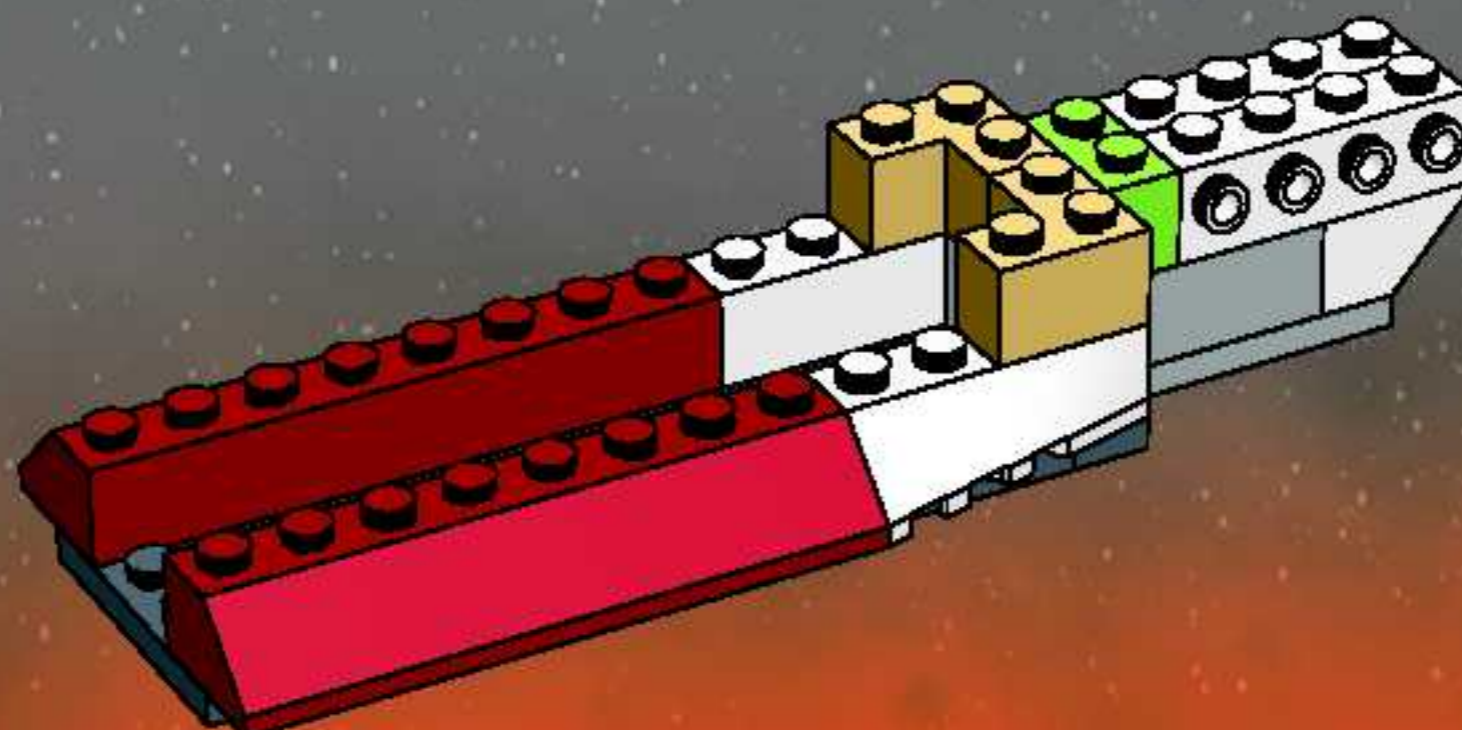

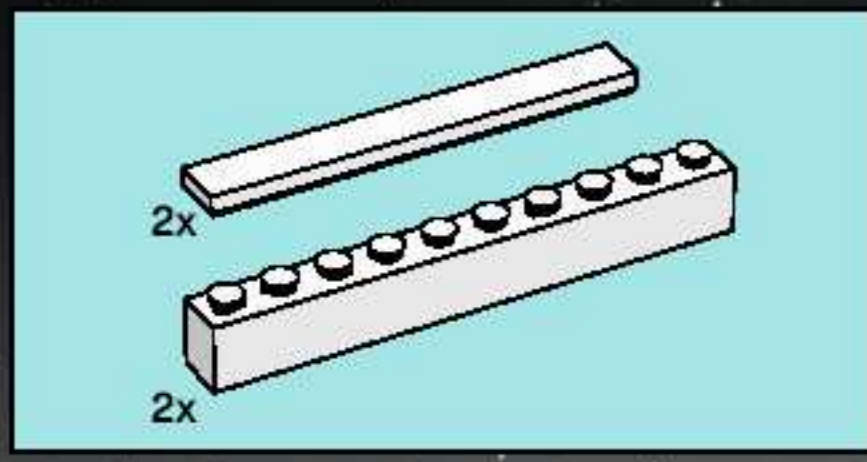

6

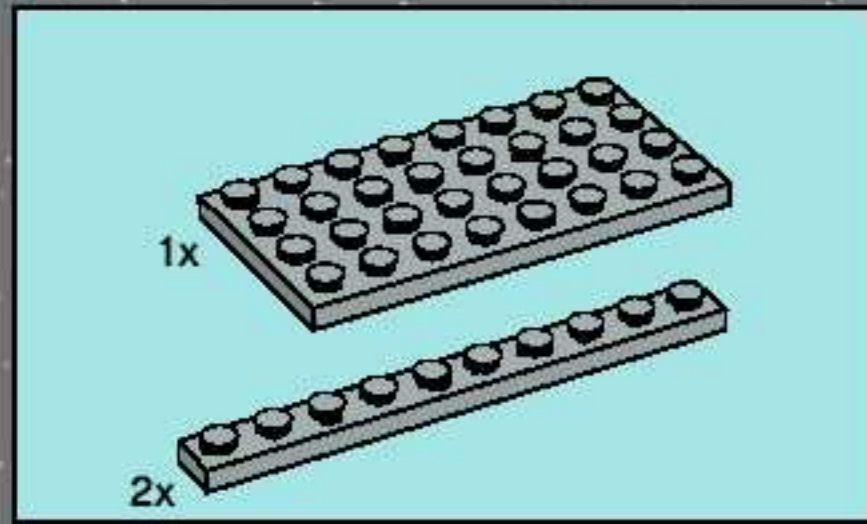
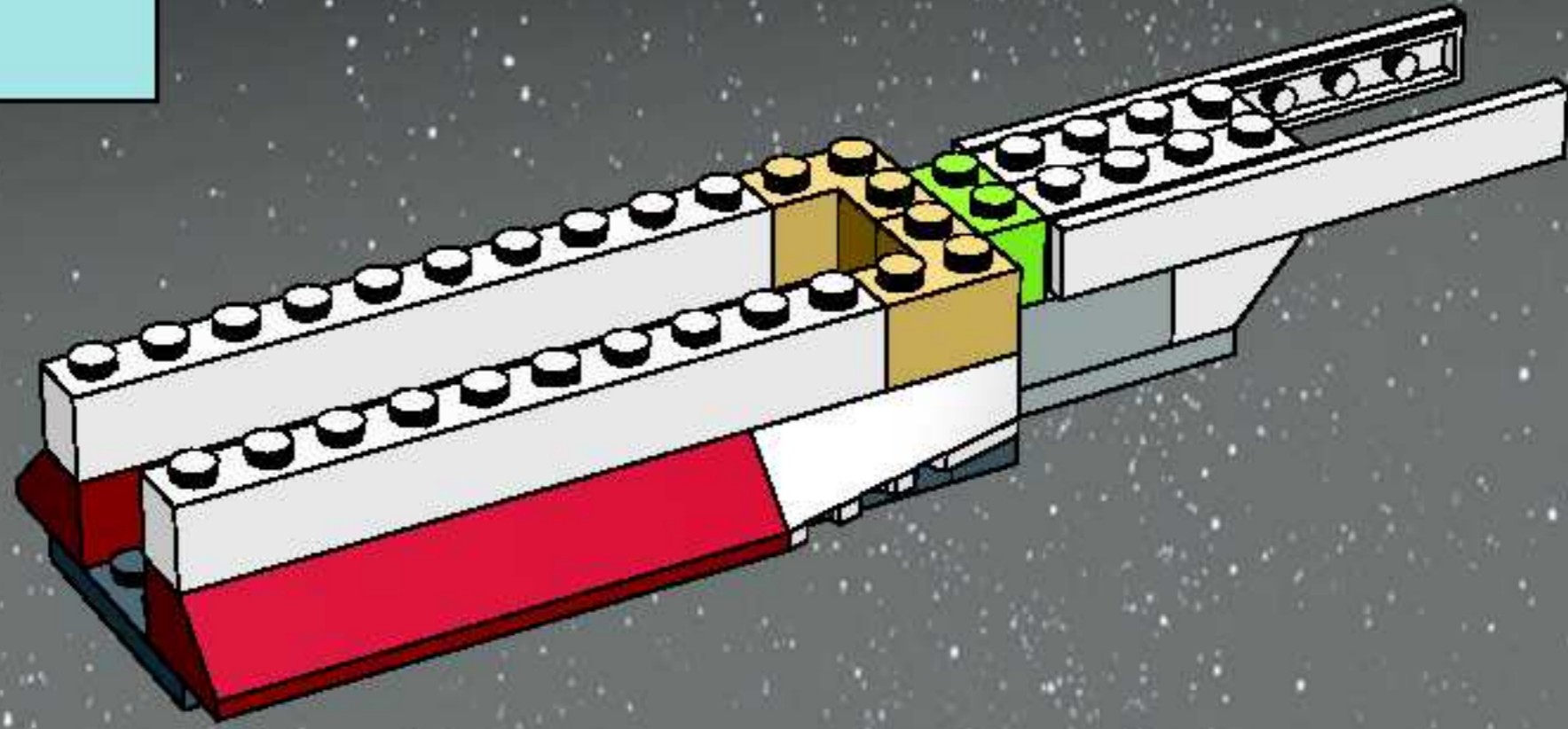

7

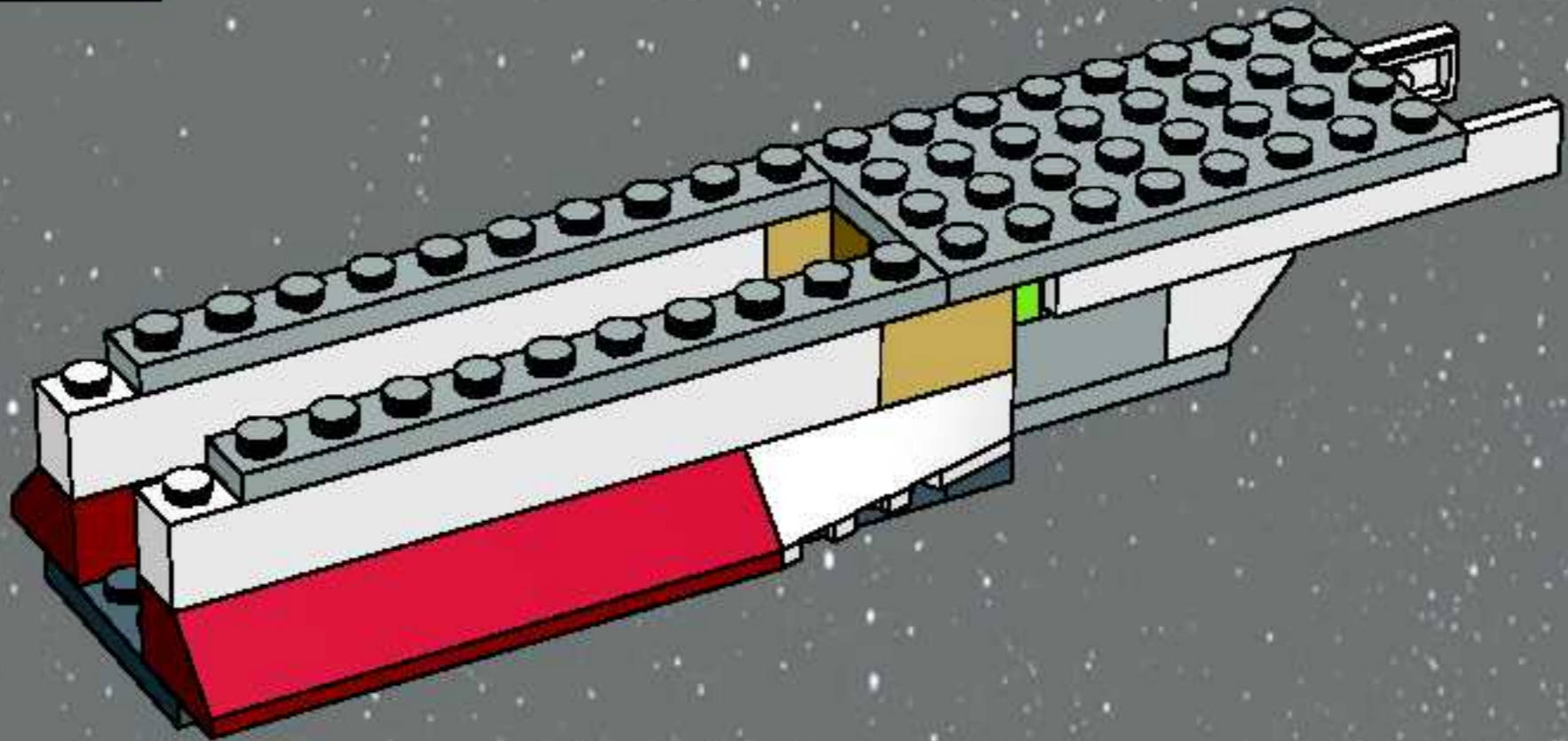

8

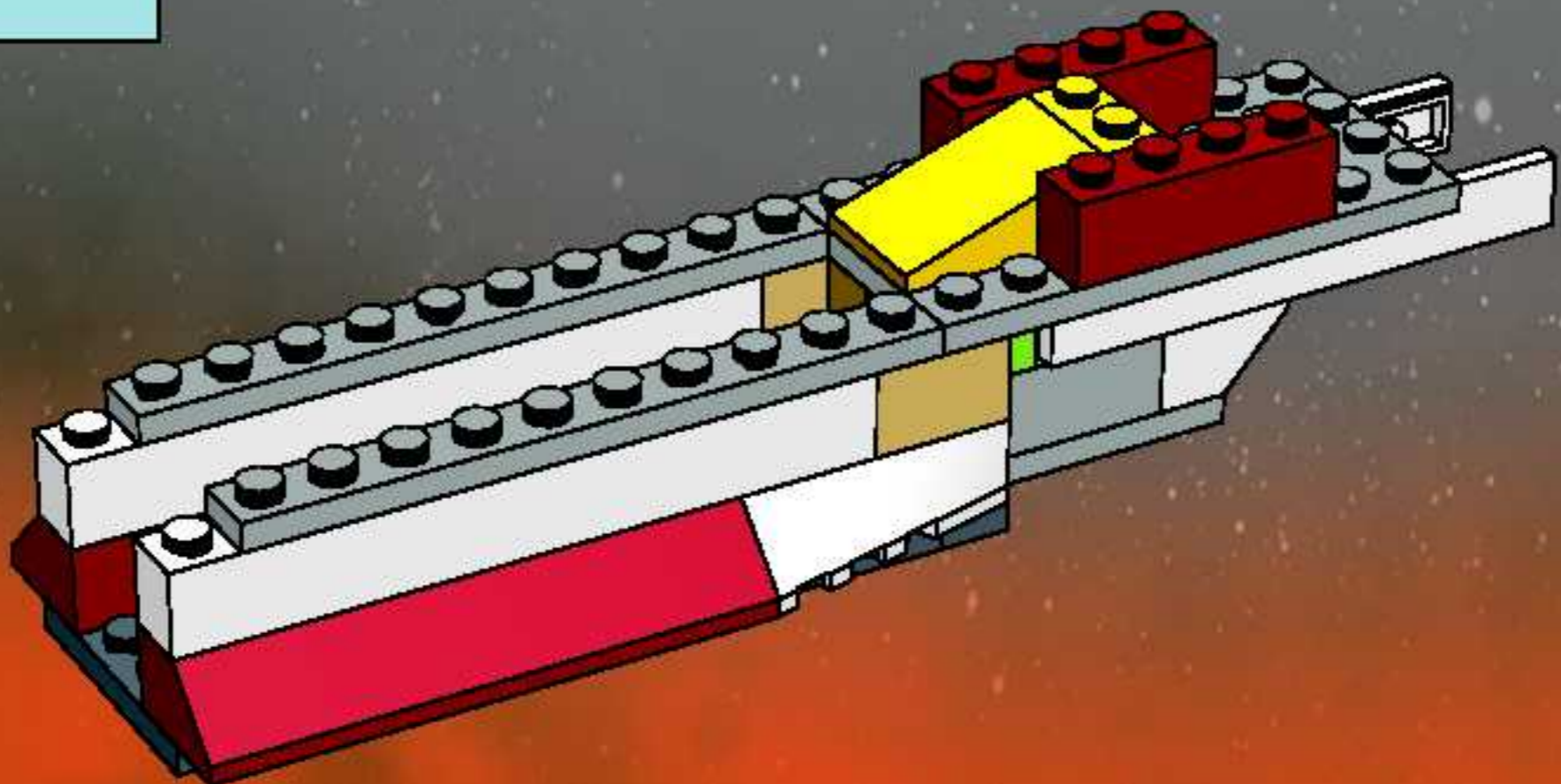



10

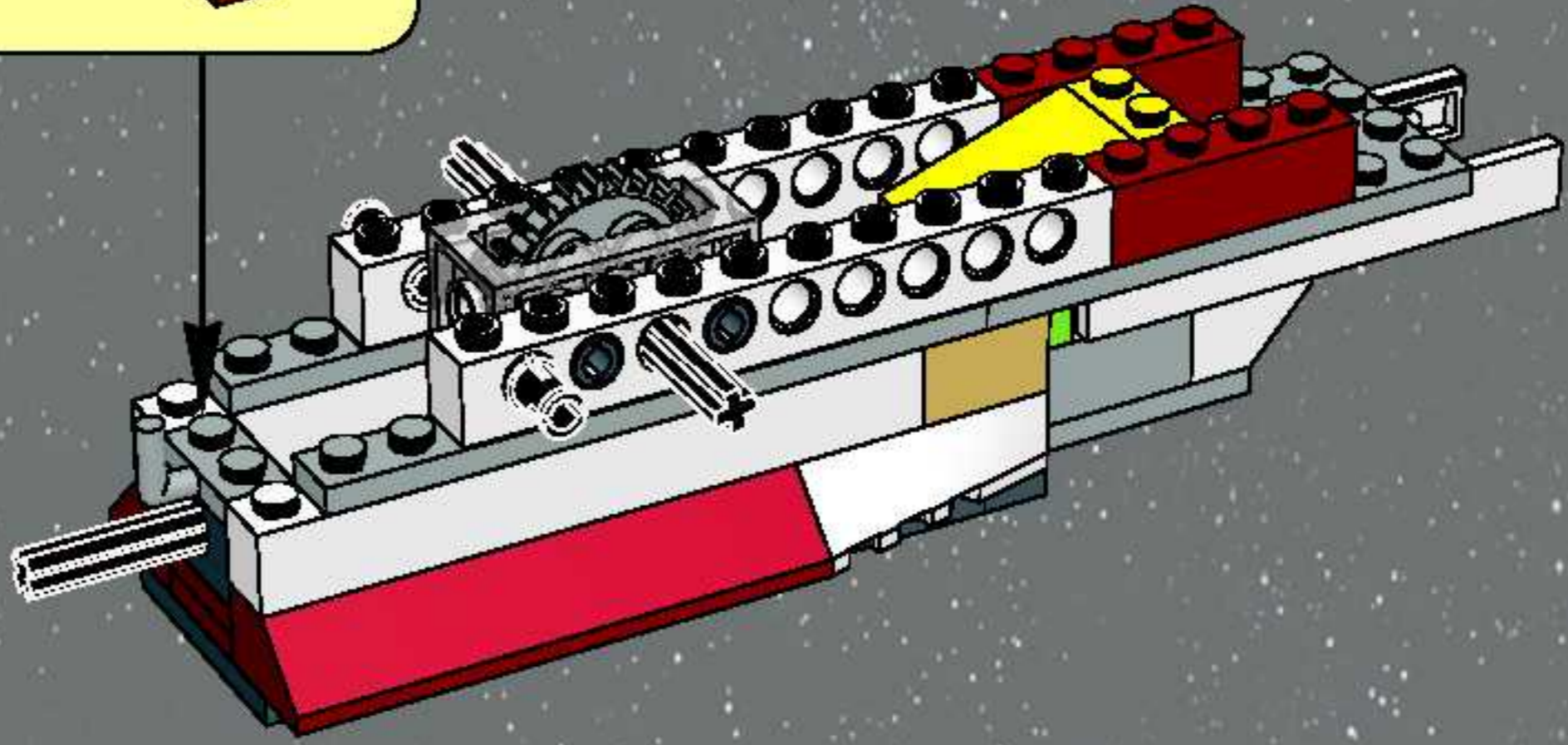
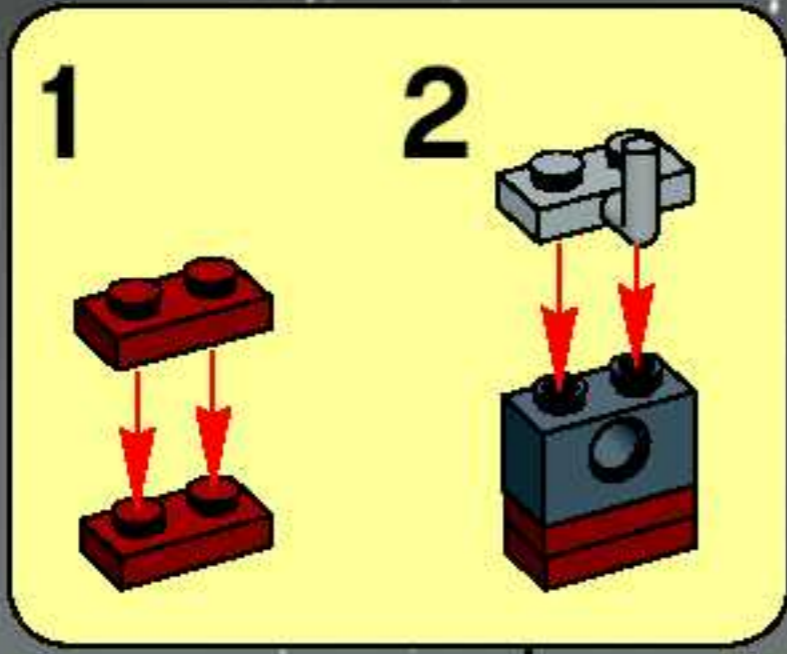

11

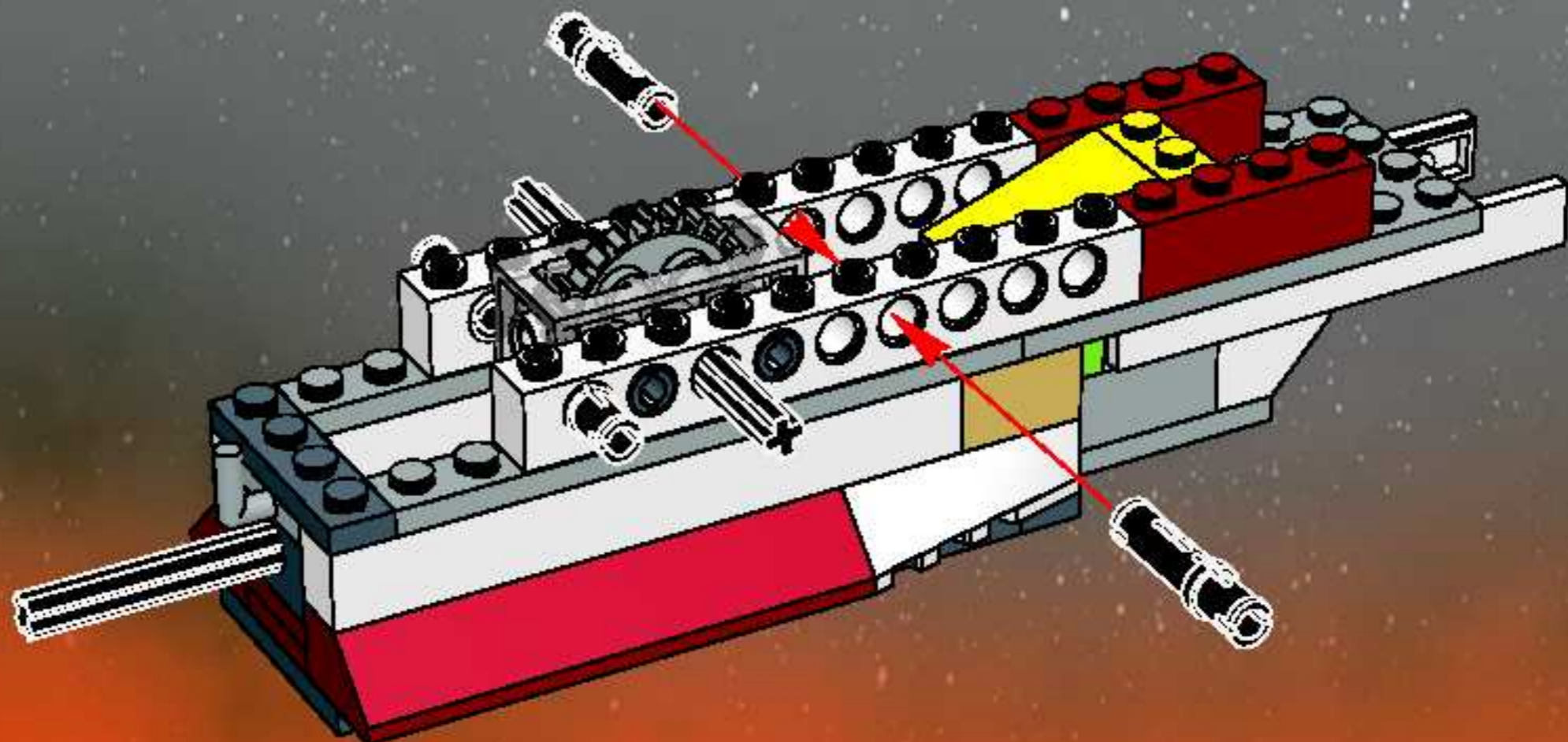

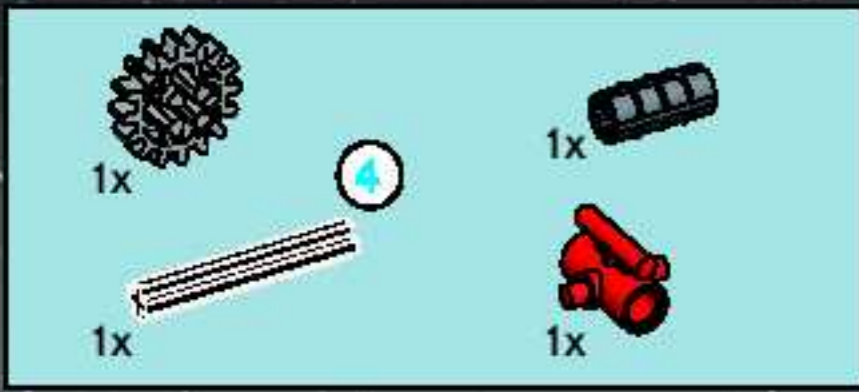

12

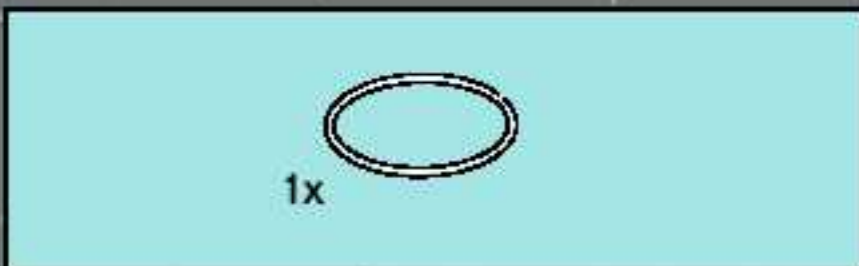
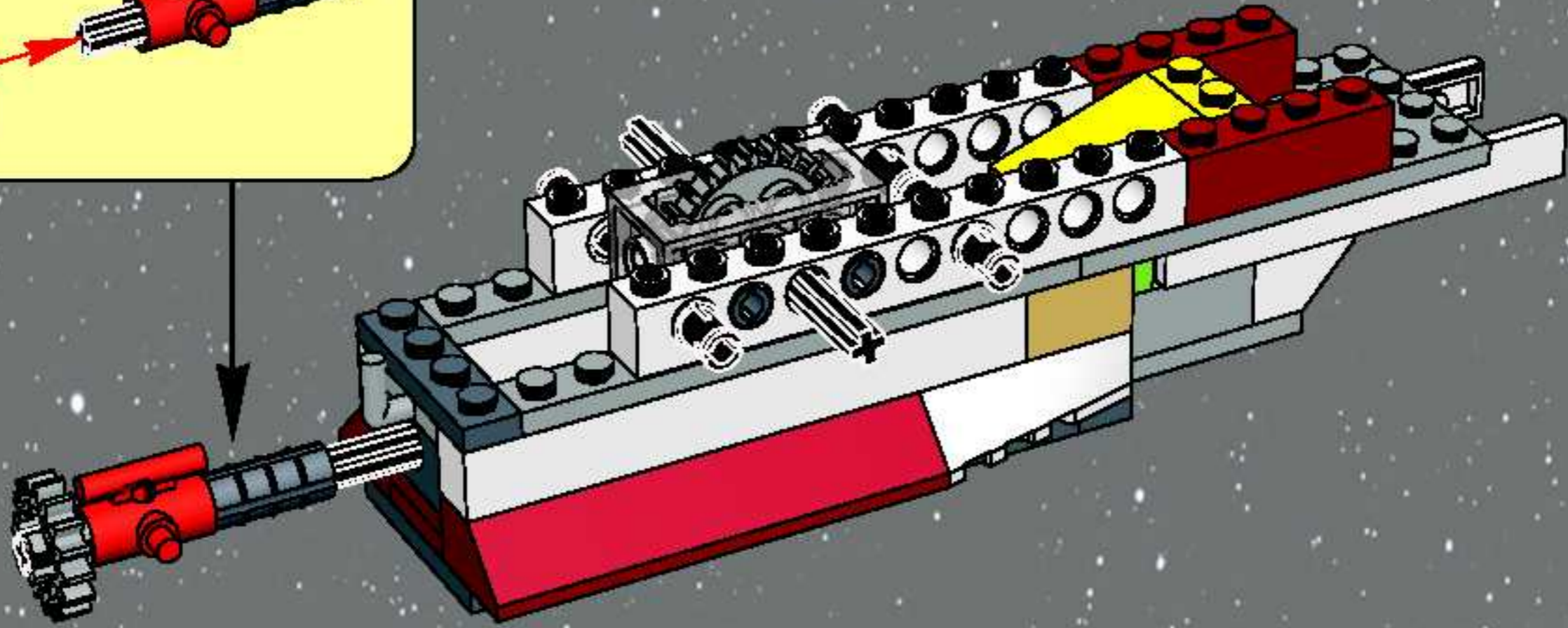
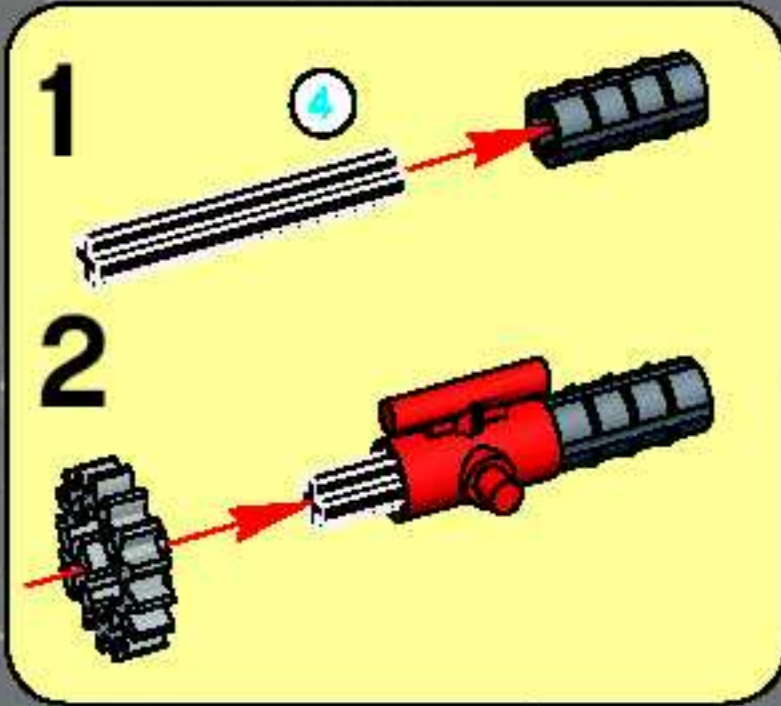

13

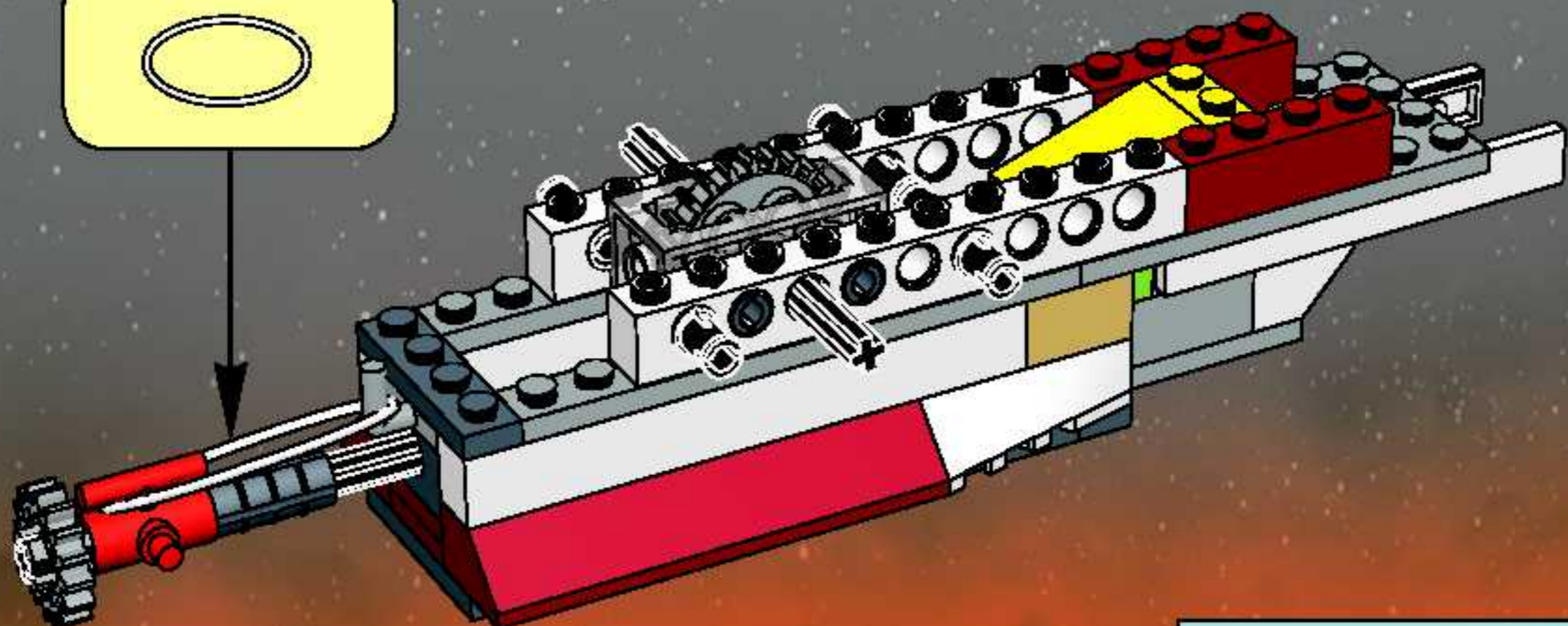
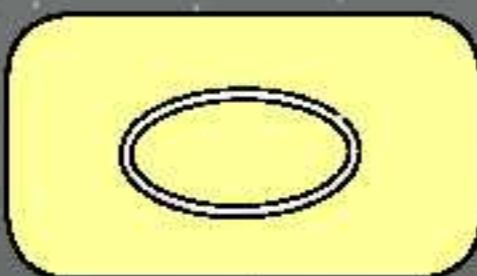

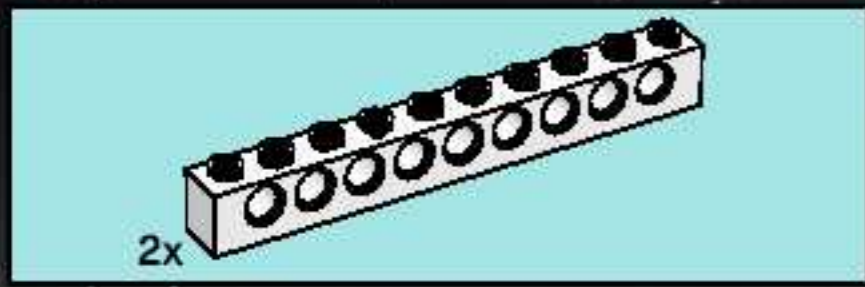

14

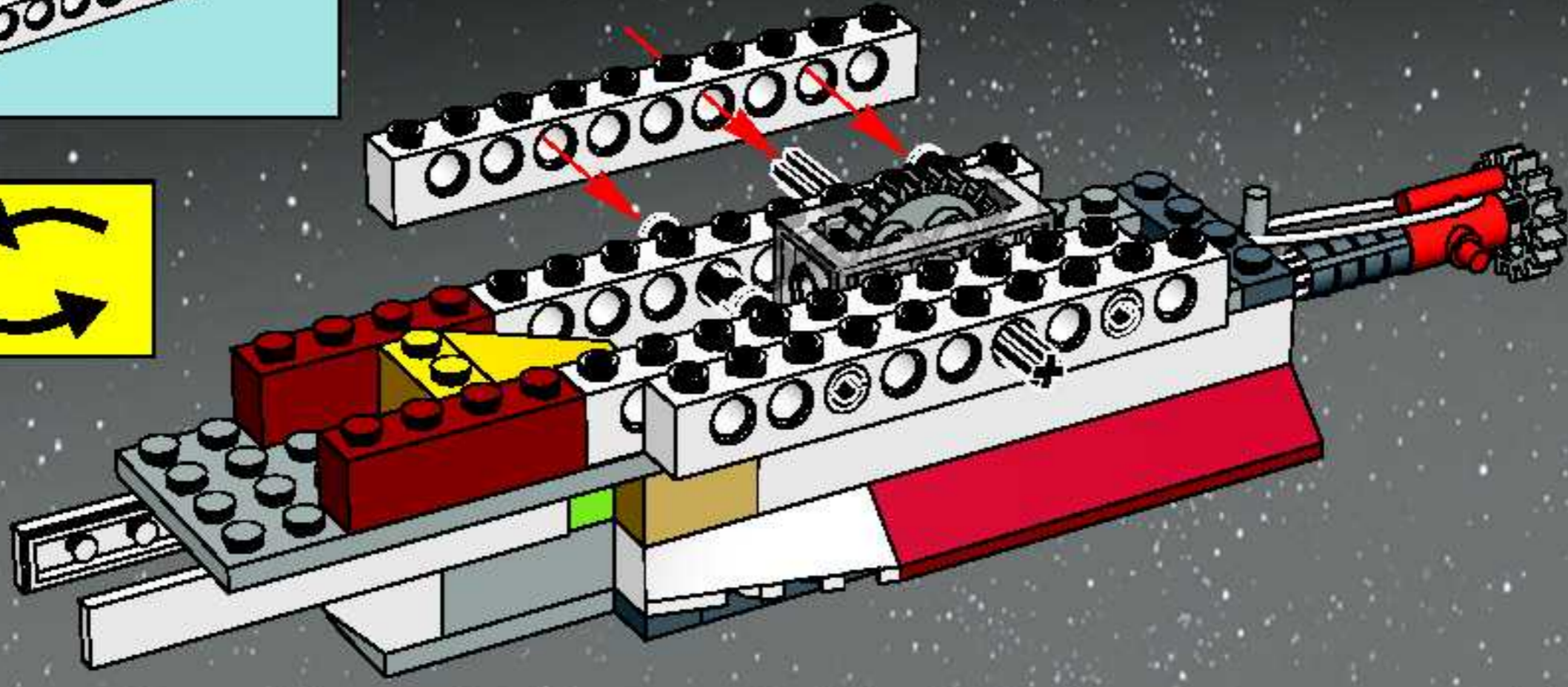

15

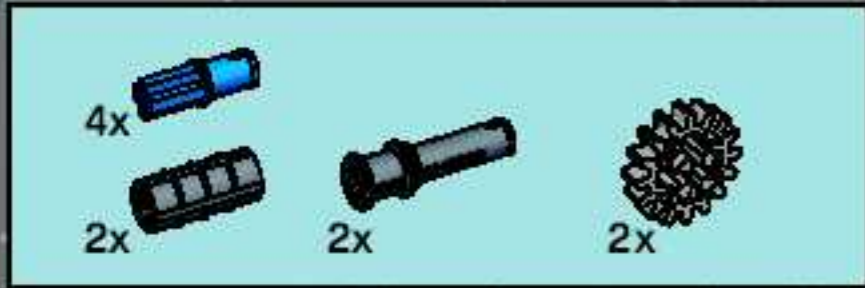
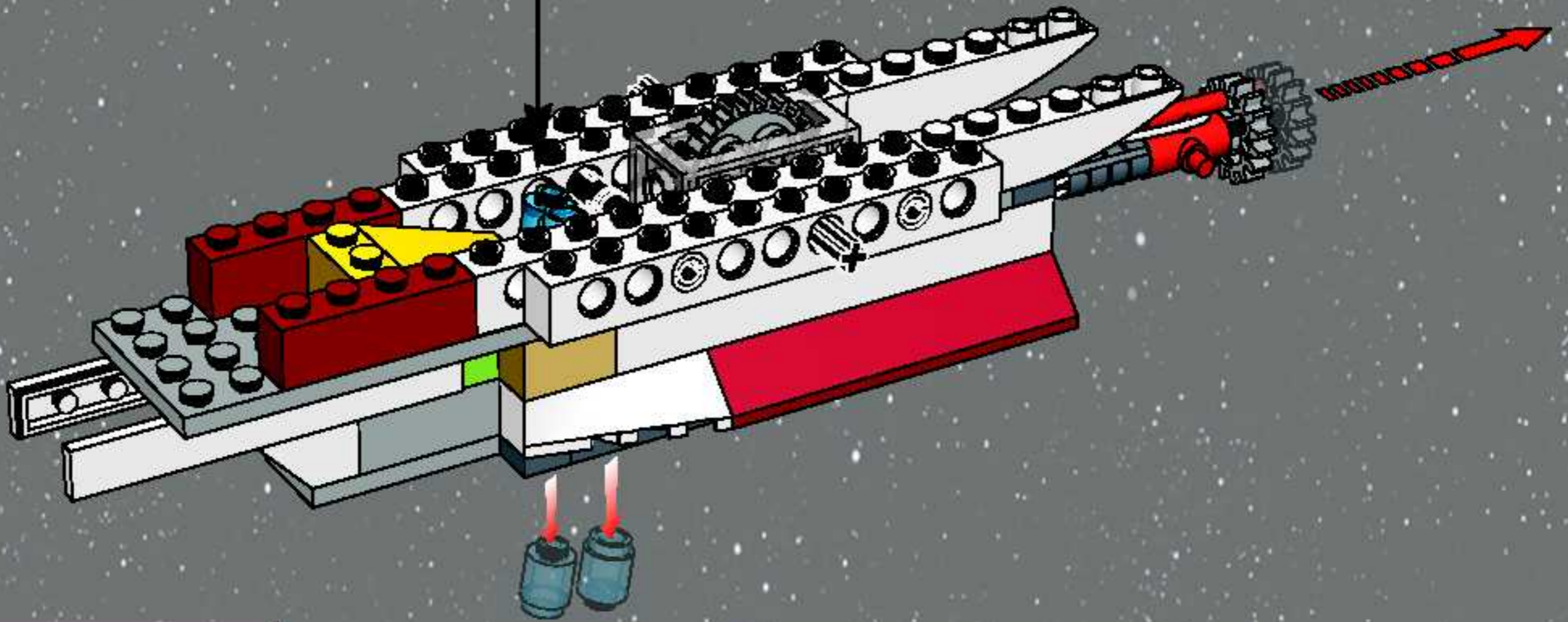

16

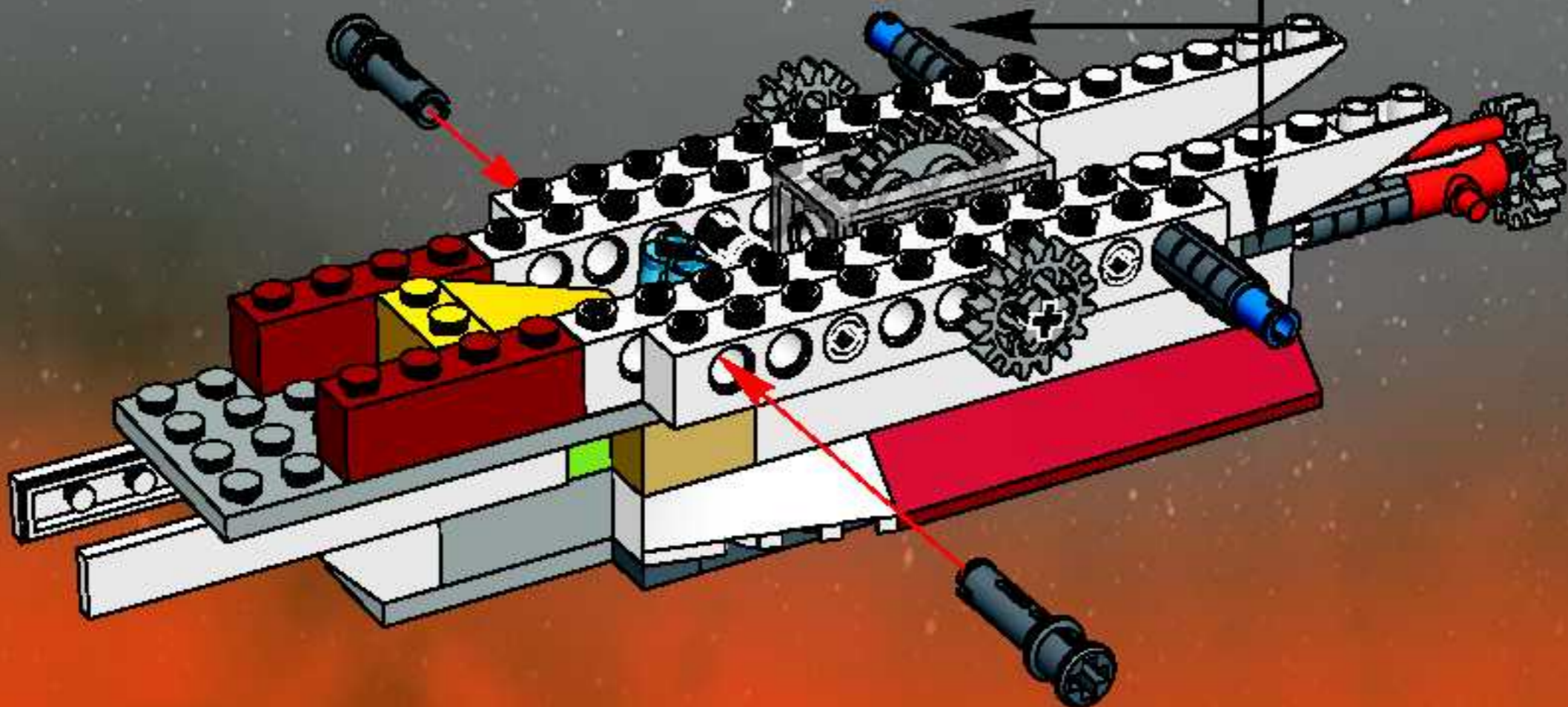
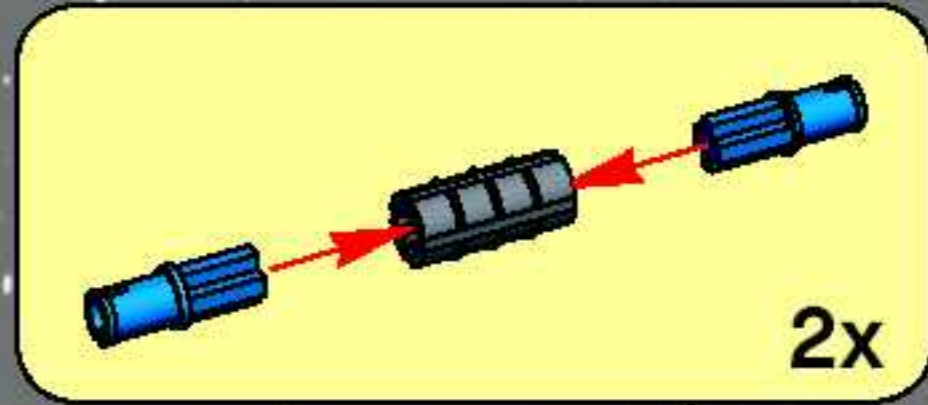

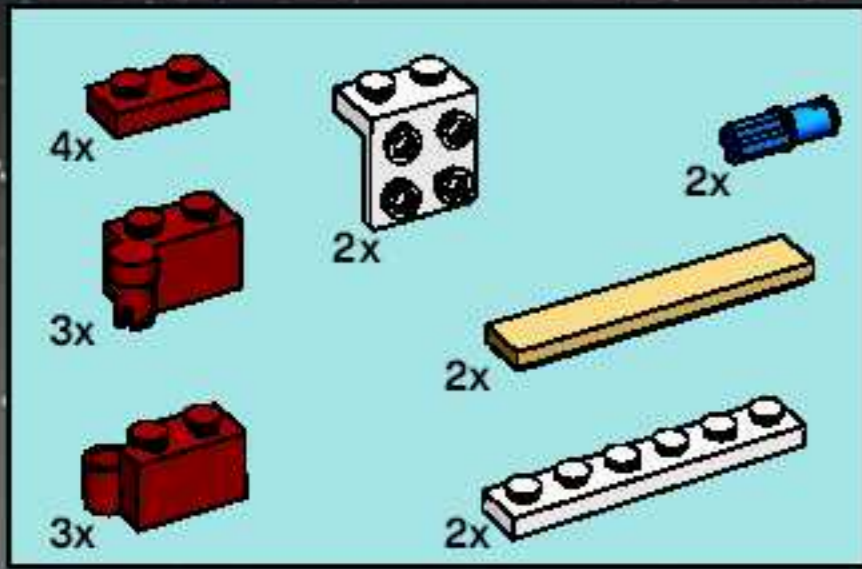

17

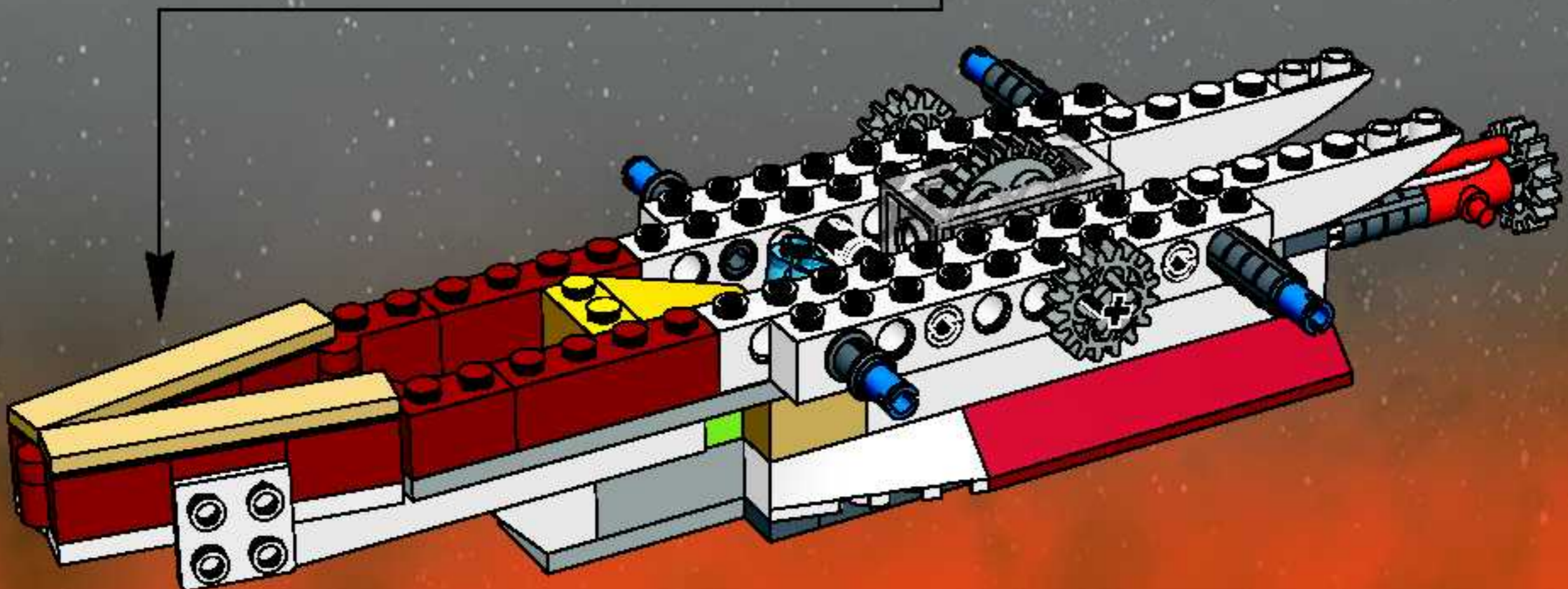
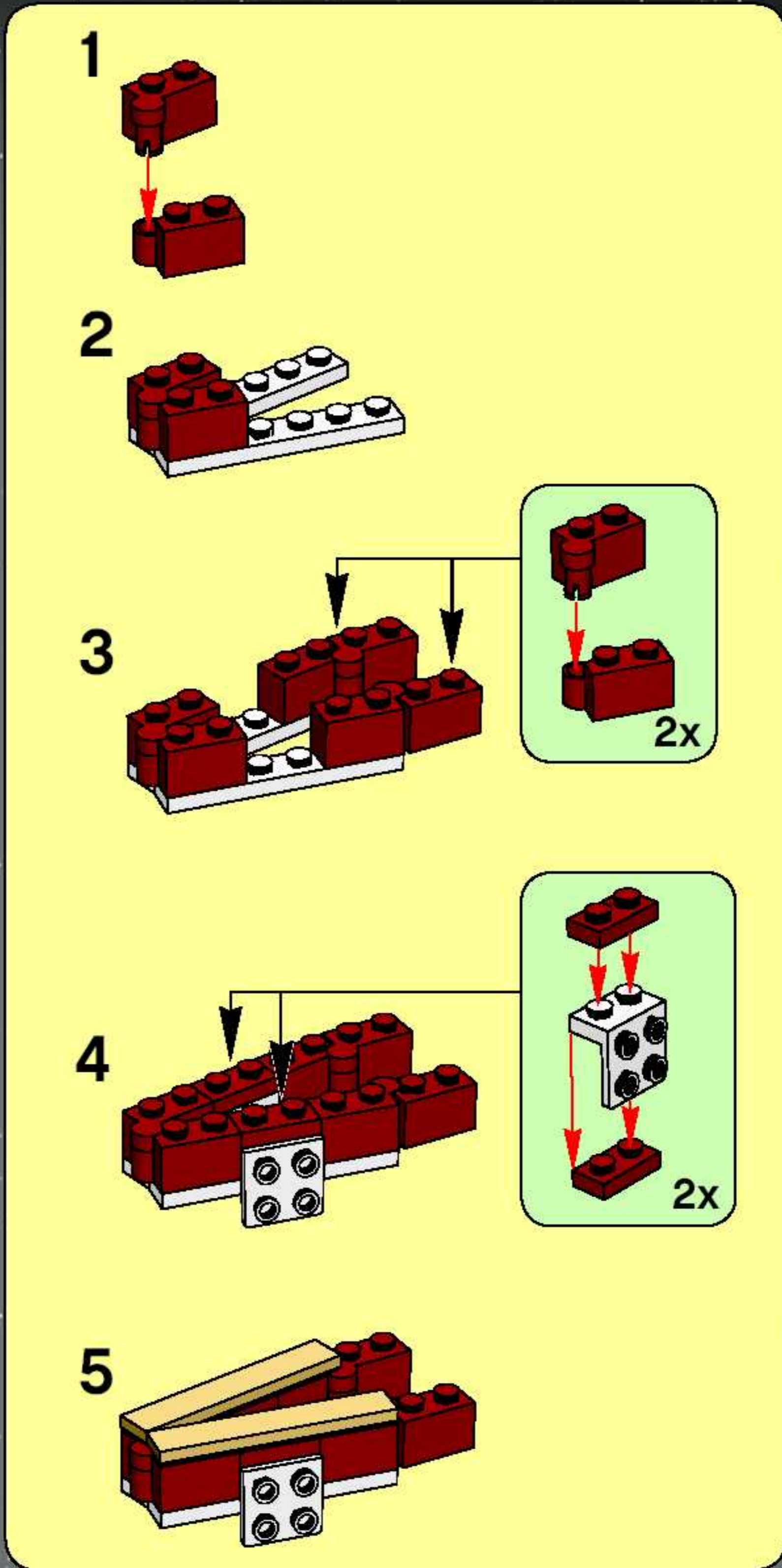

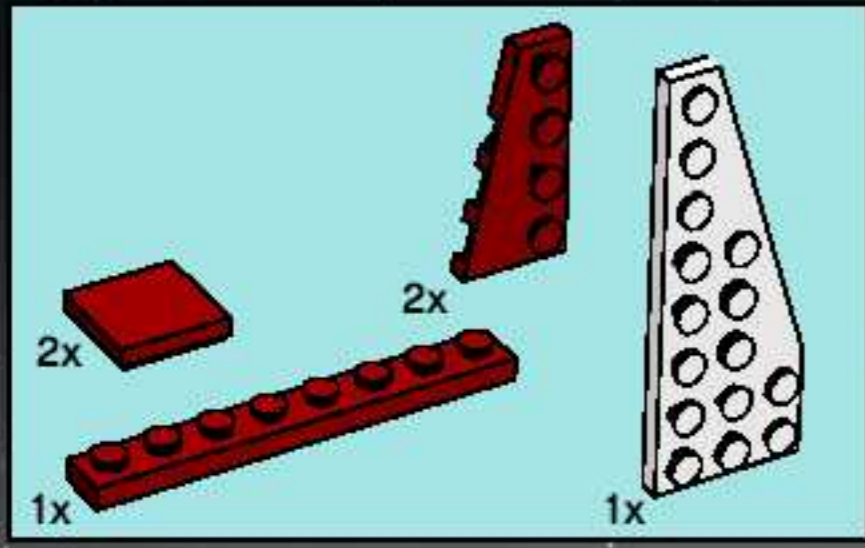

18

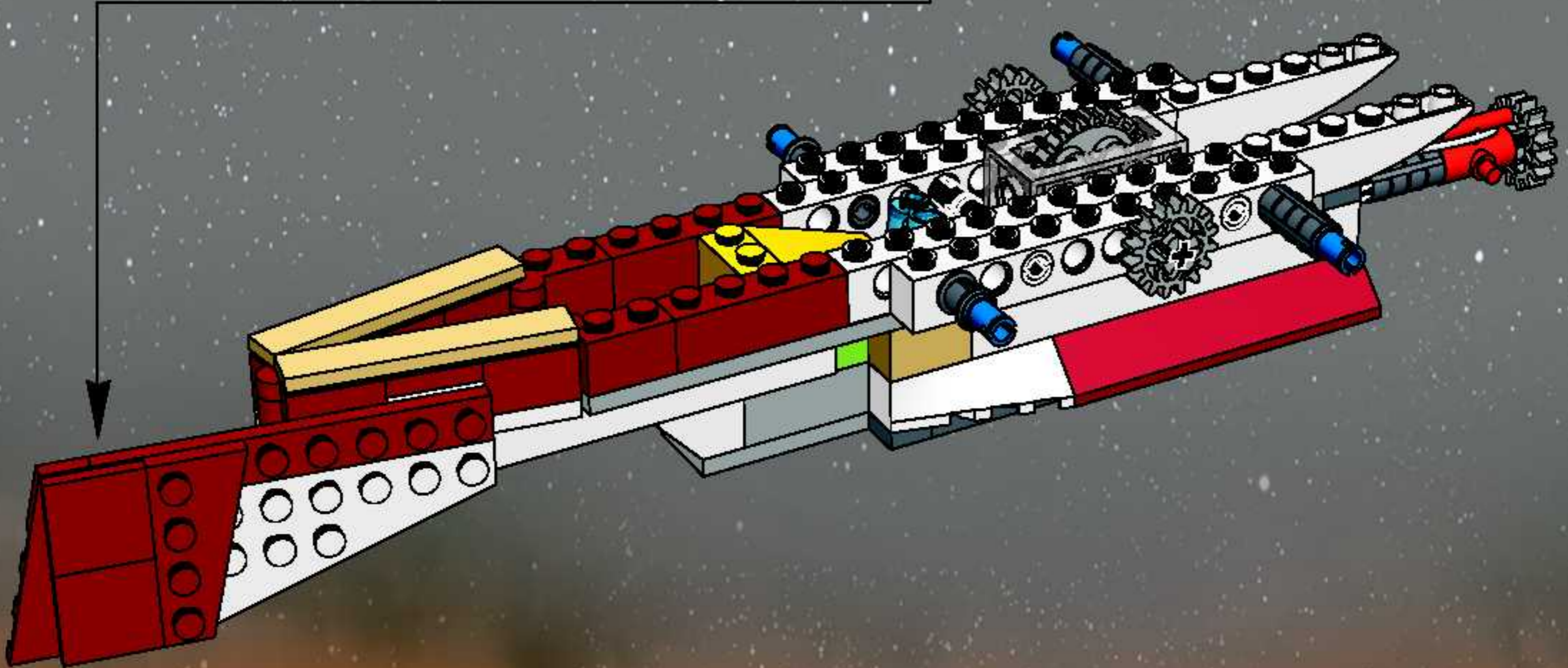
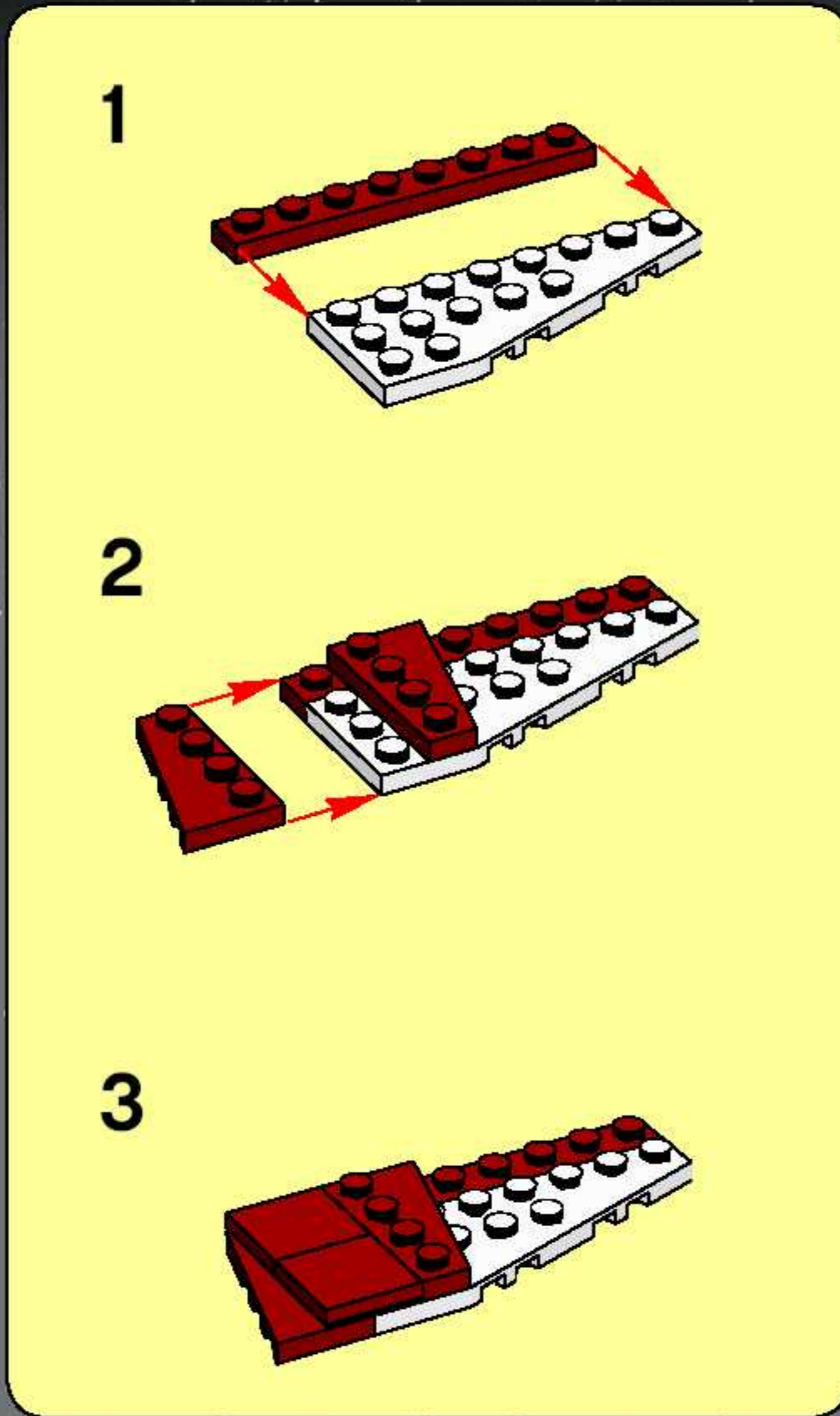

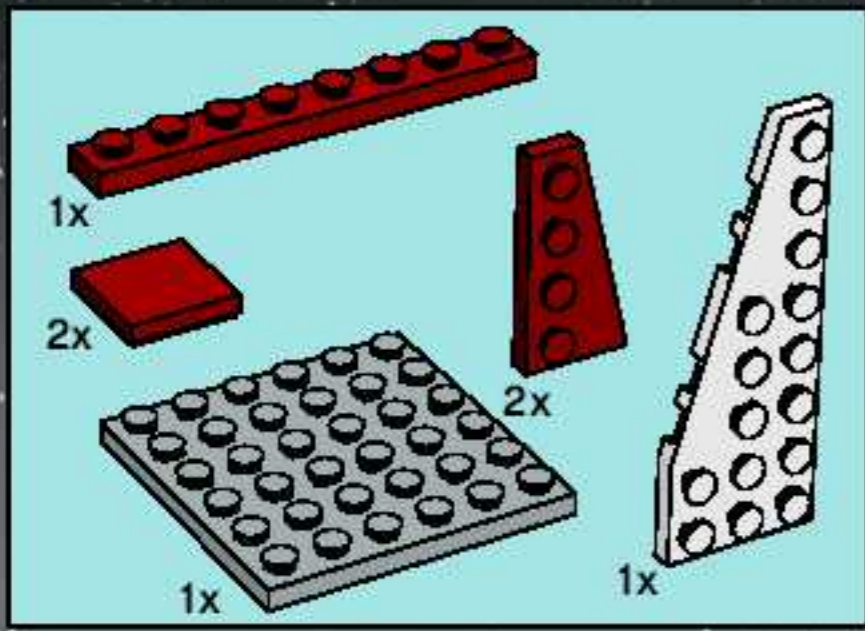

19

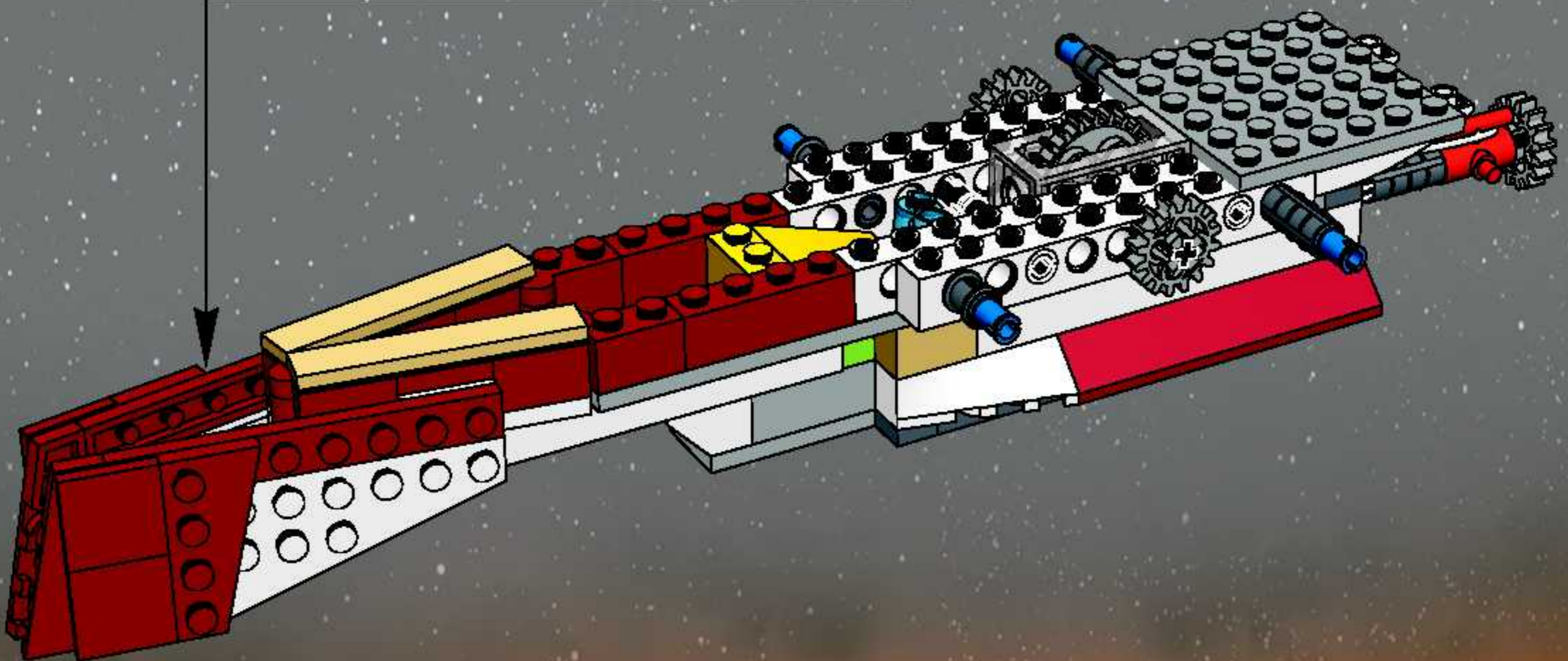
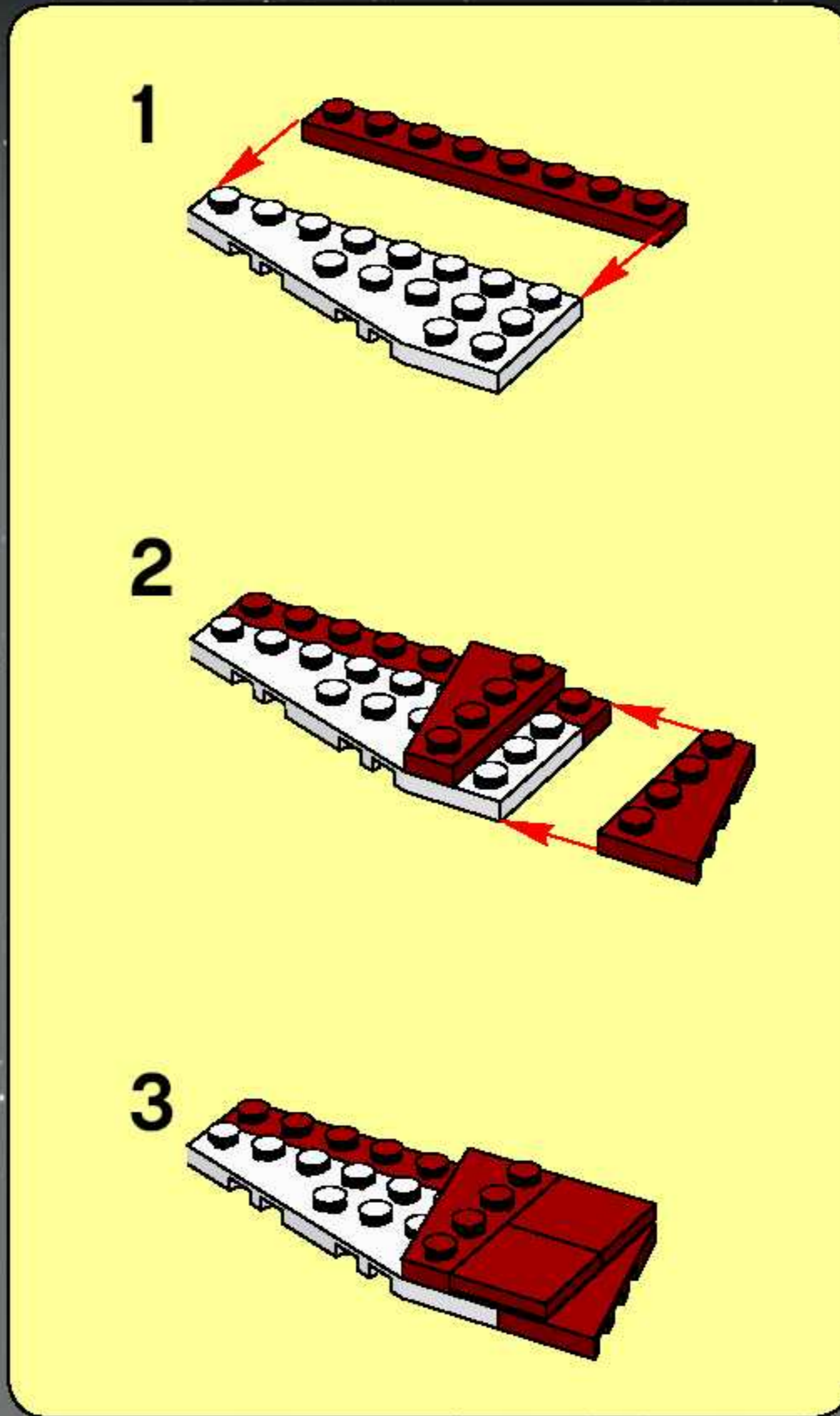

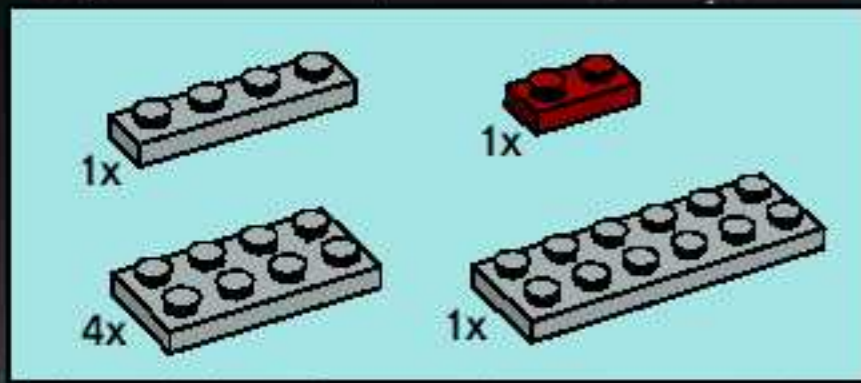

20

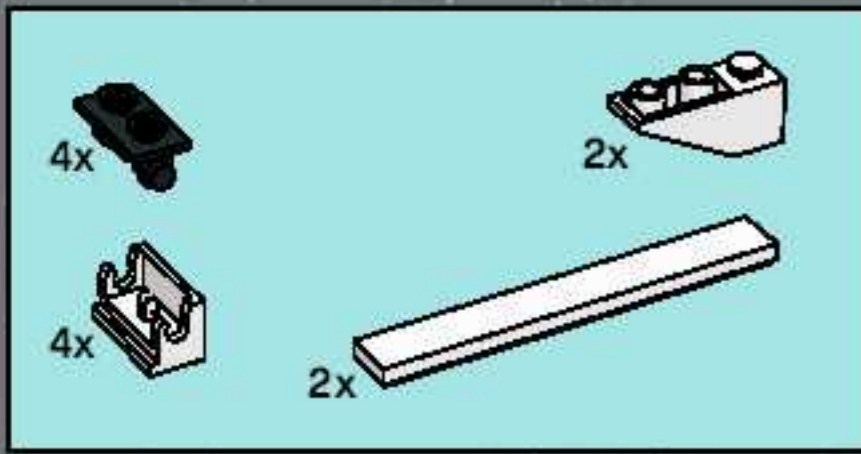
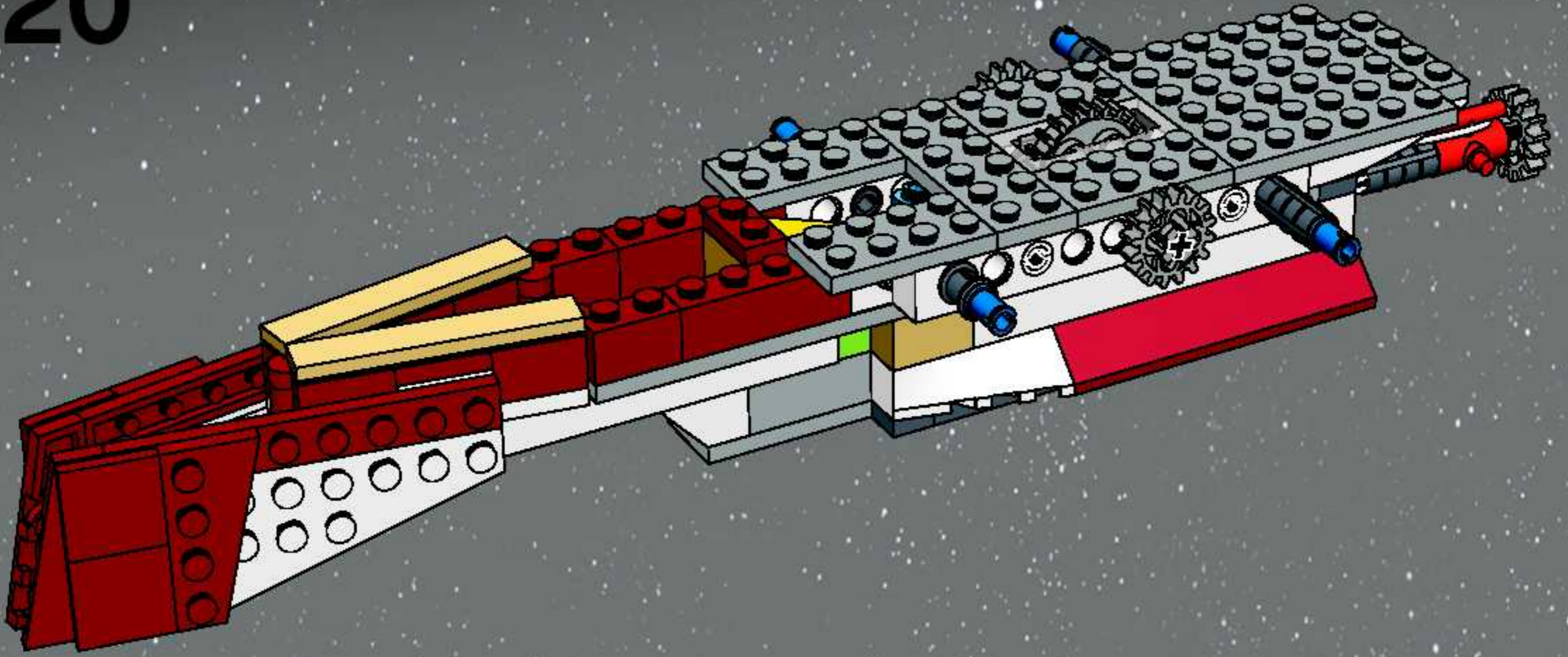

21

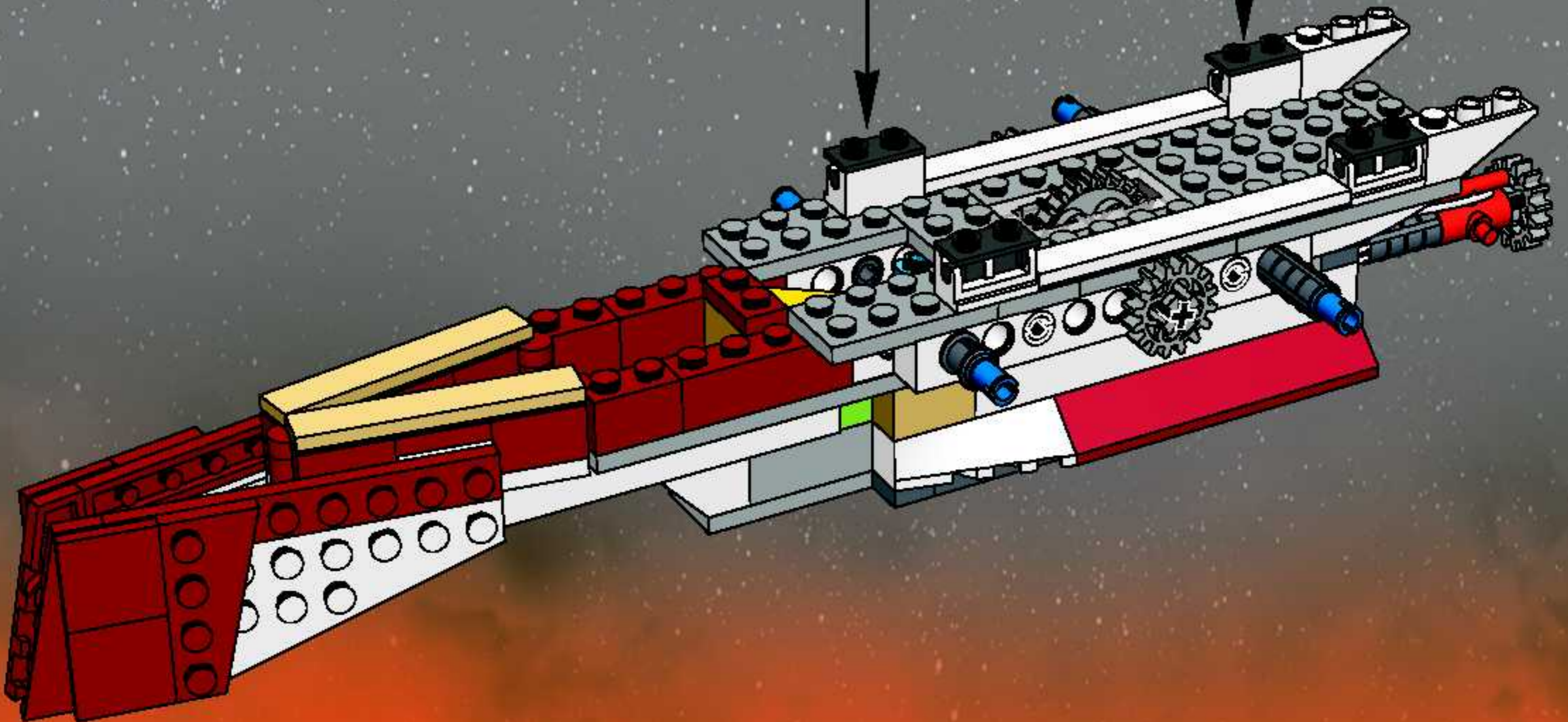
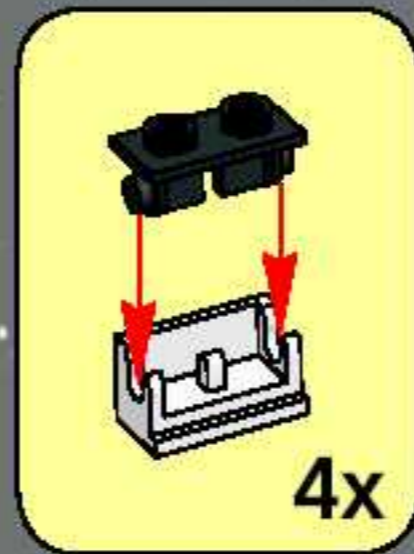

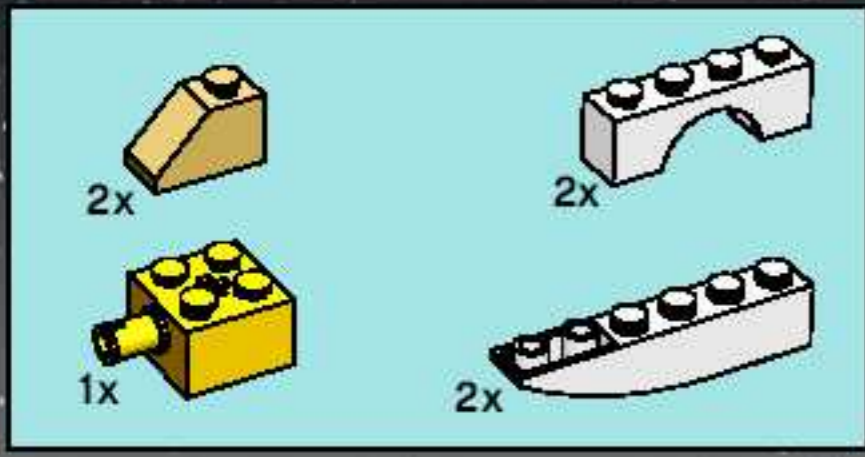

22

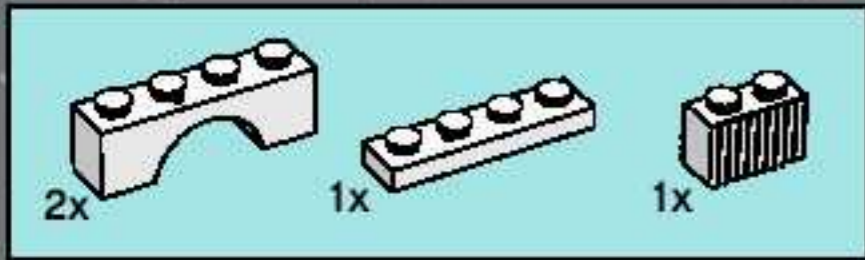
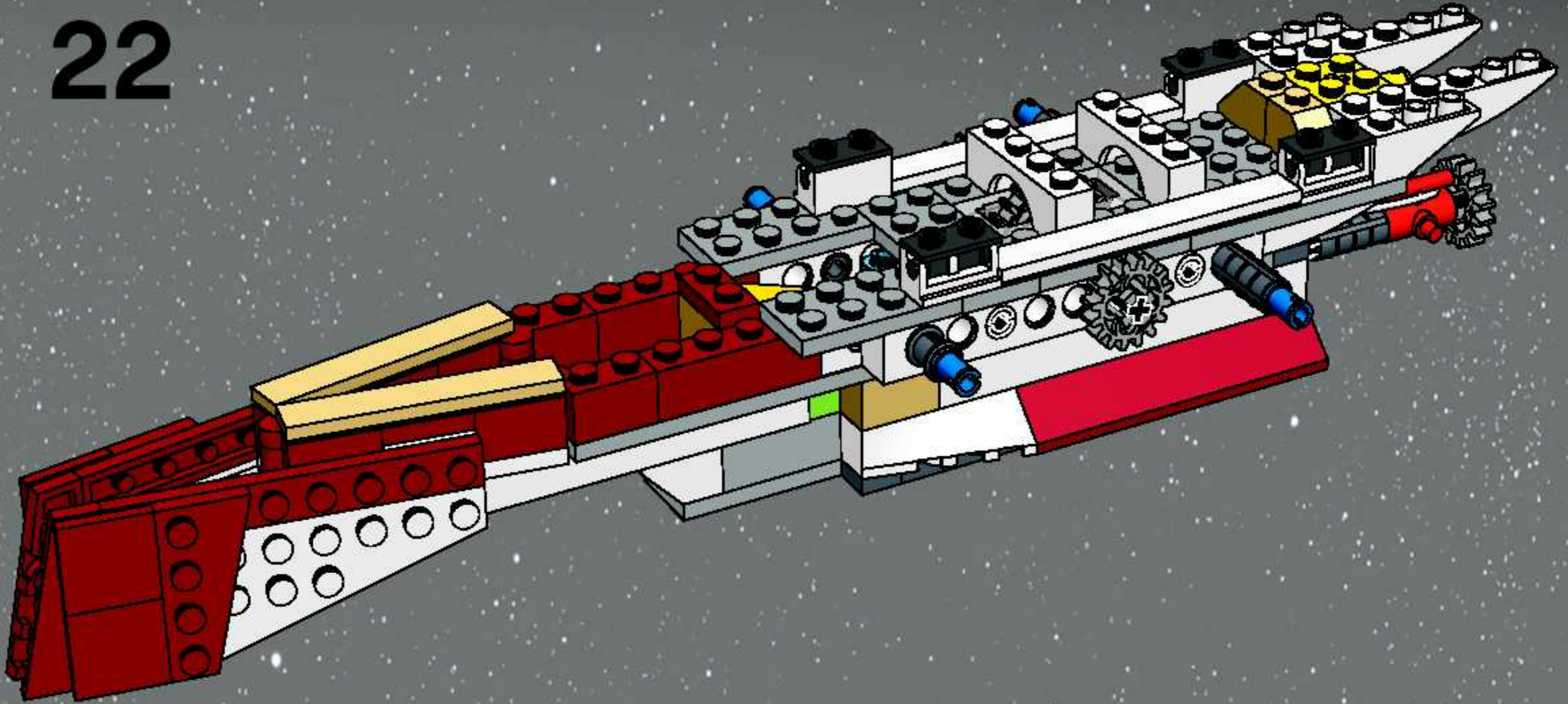

23

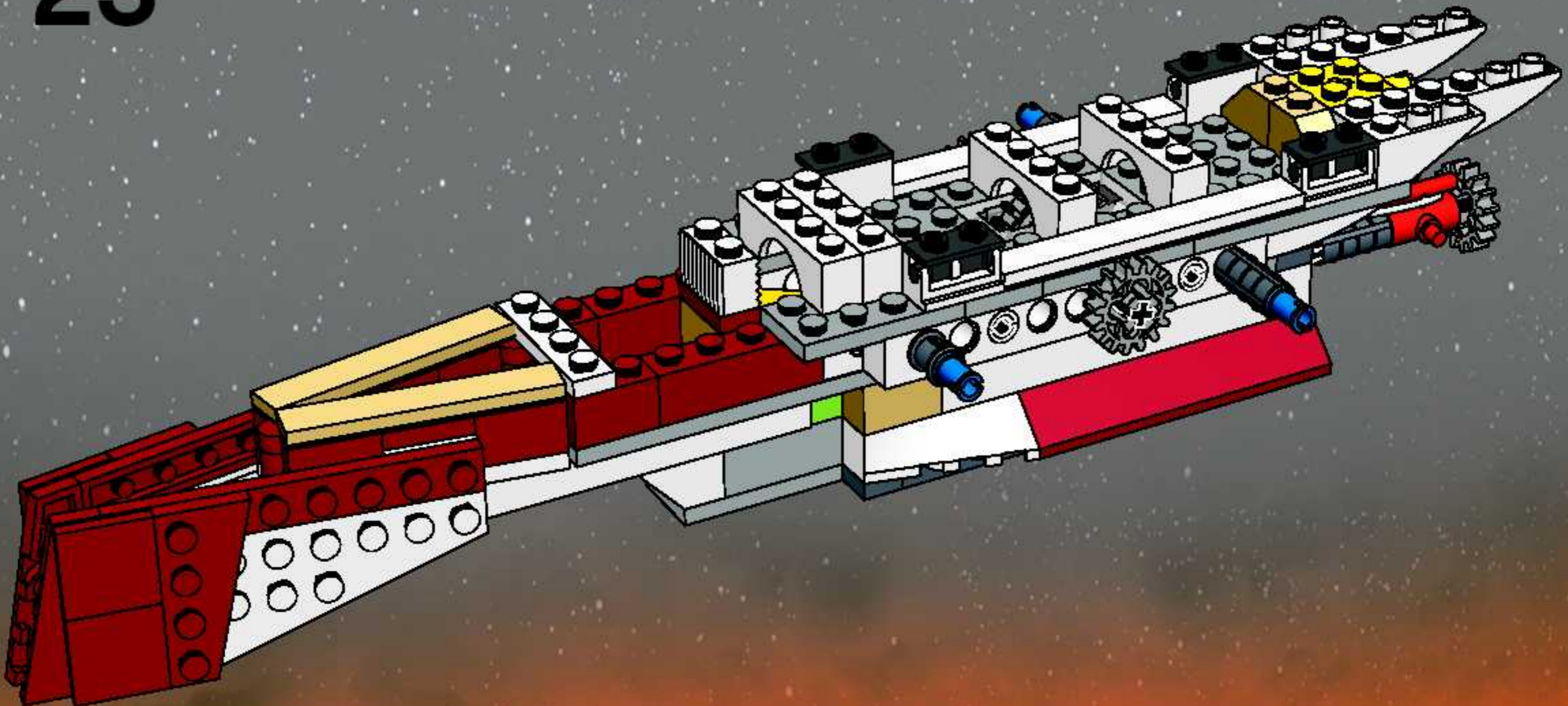



24

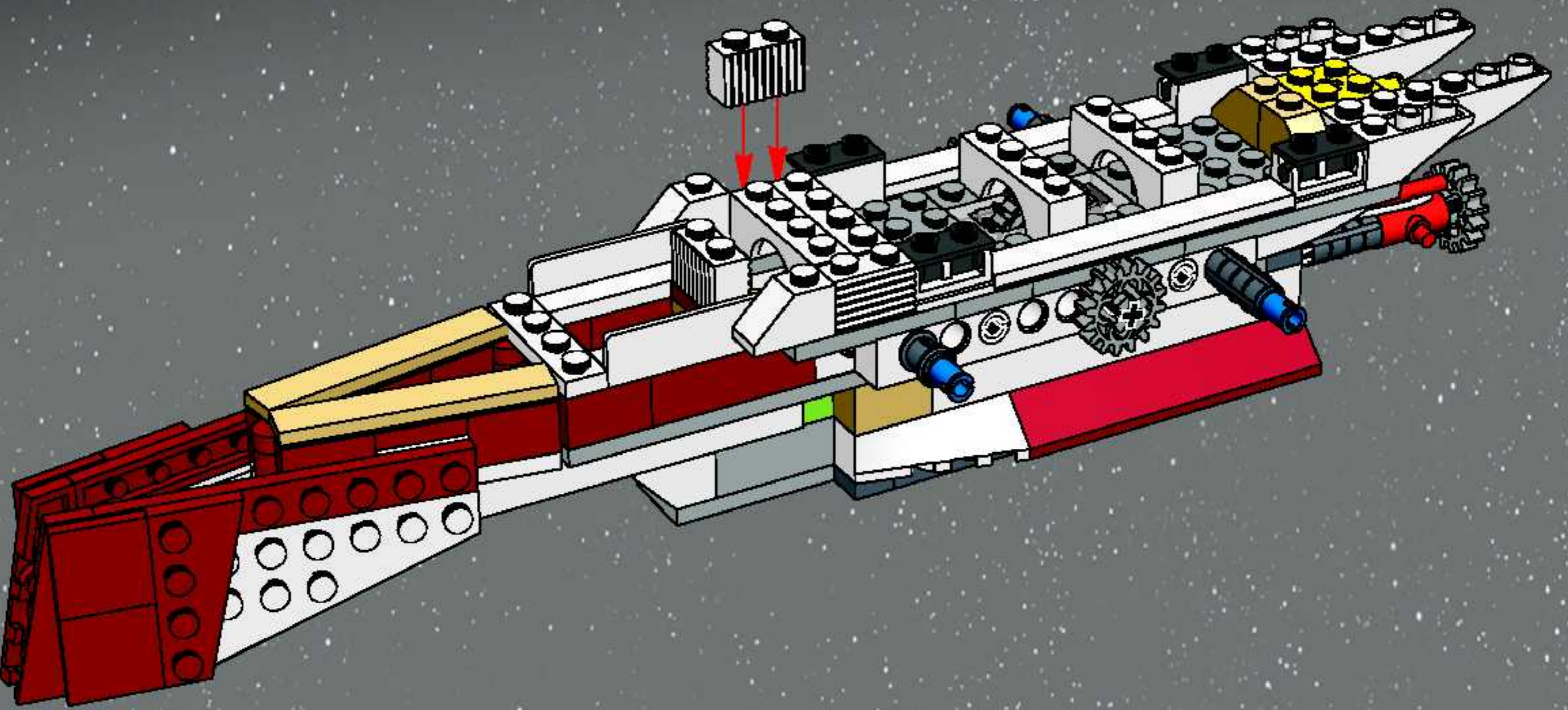

25

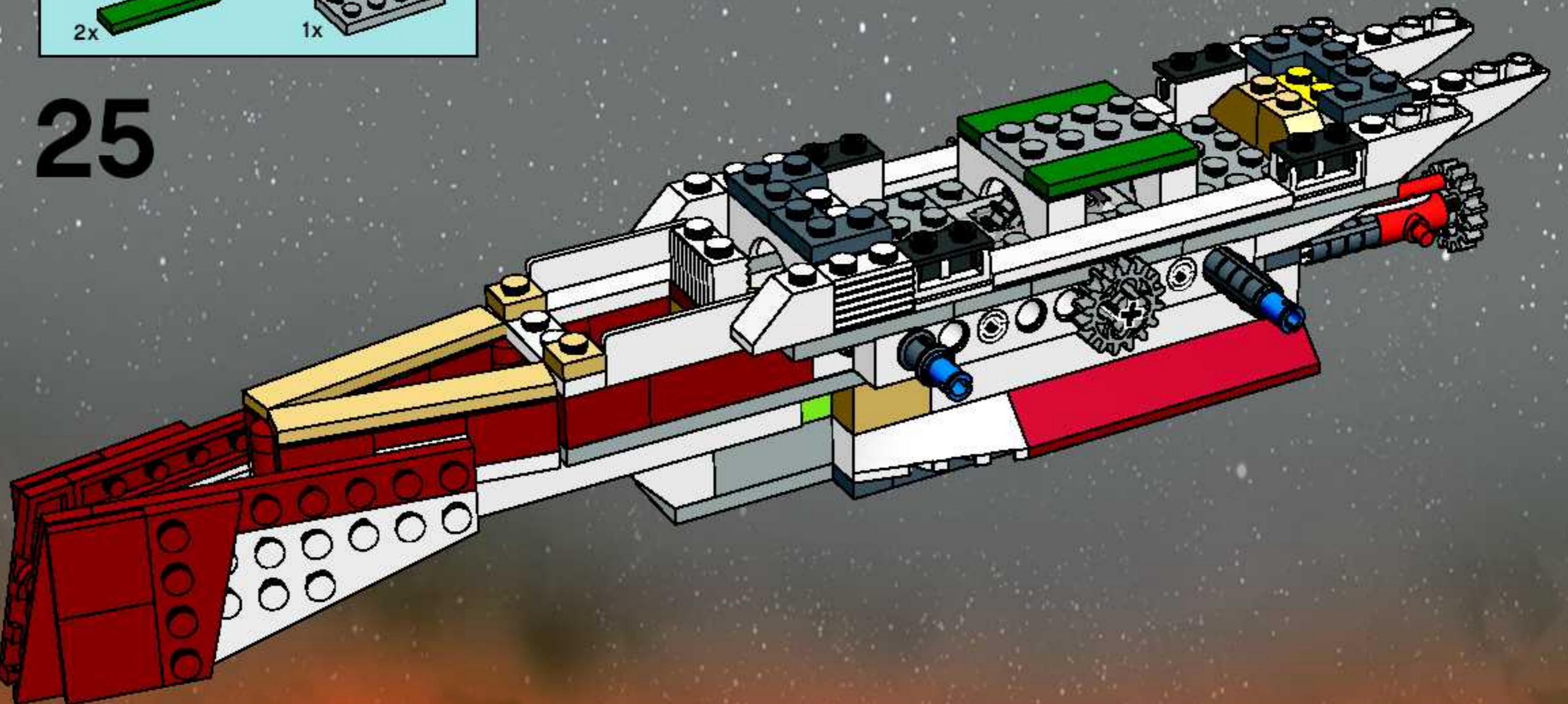

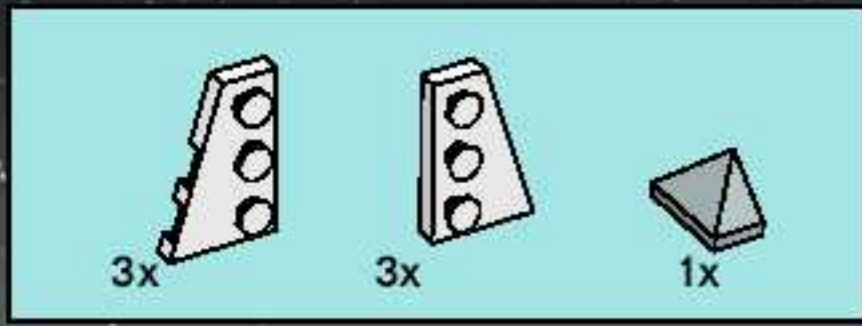

26

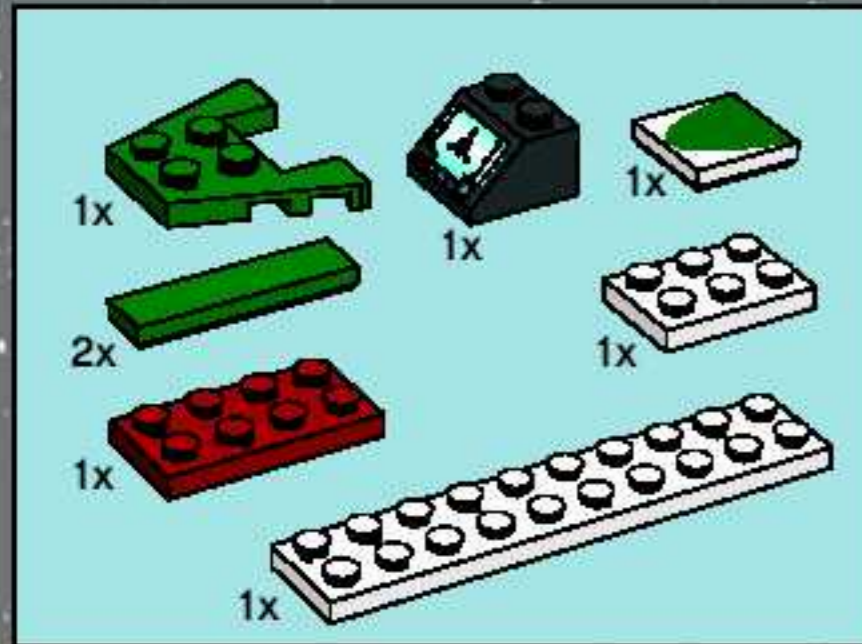
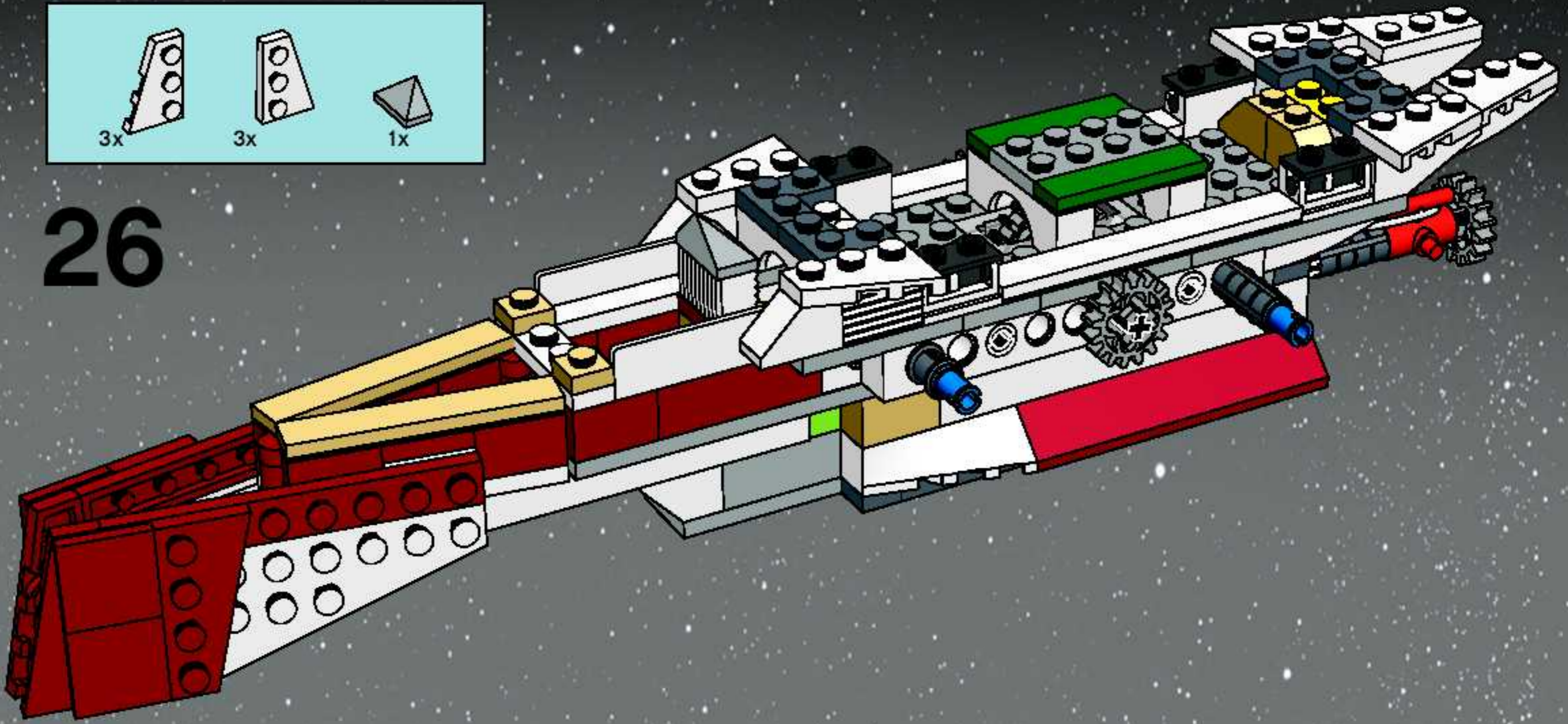

27

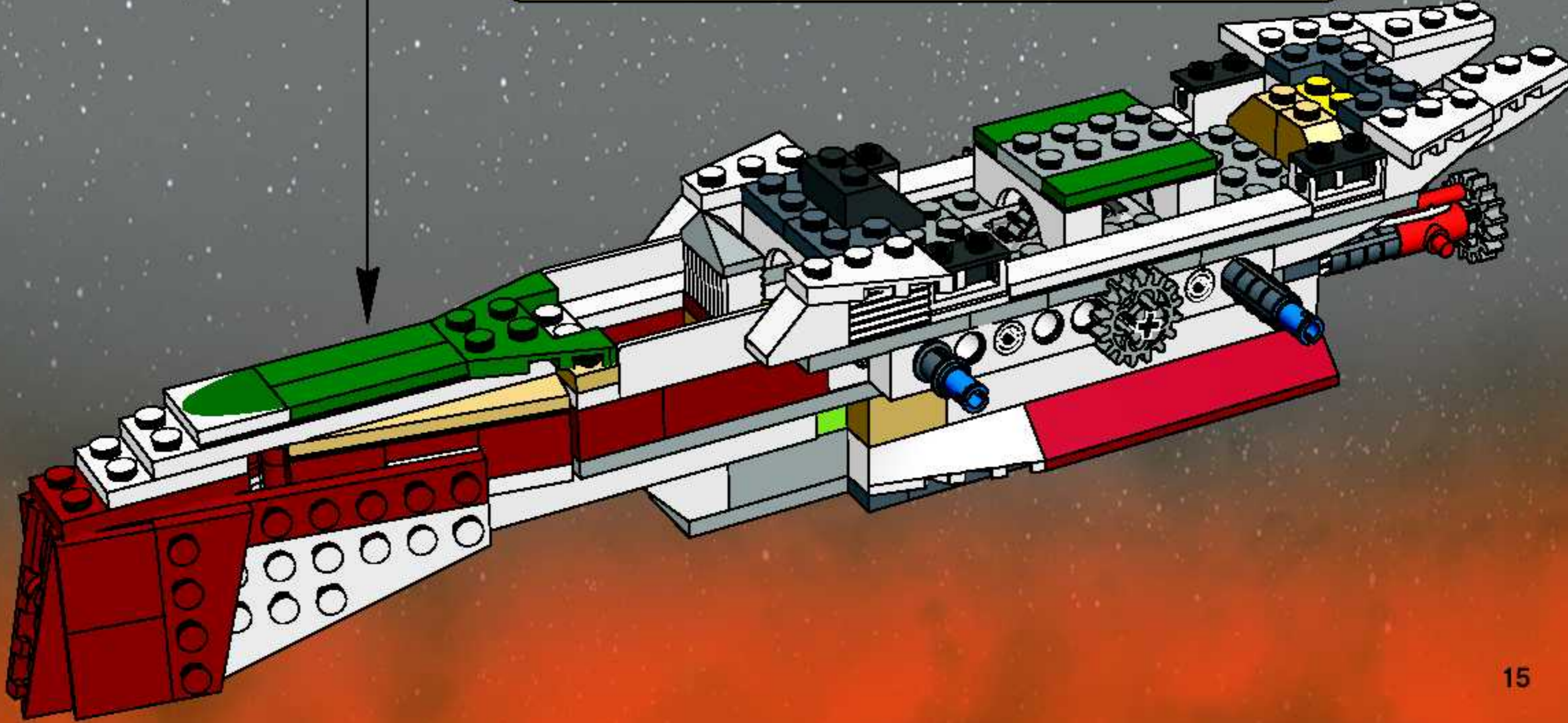
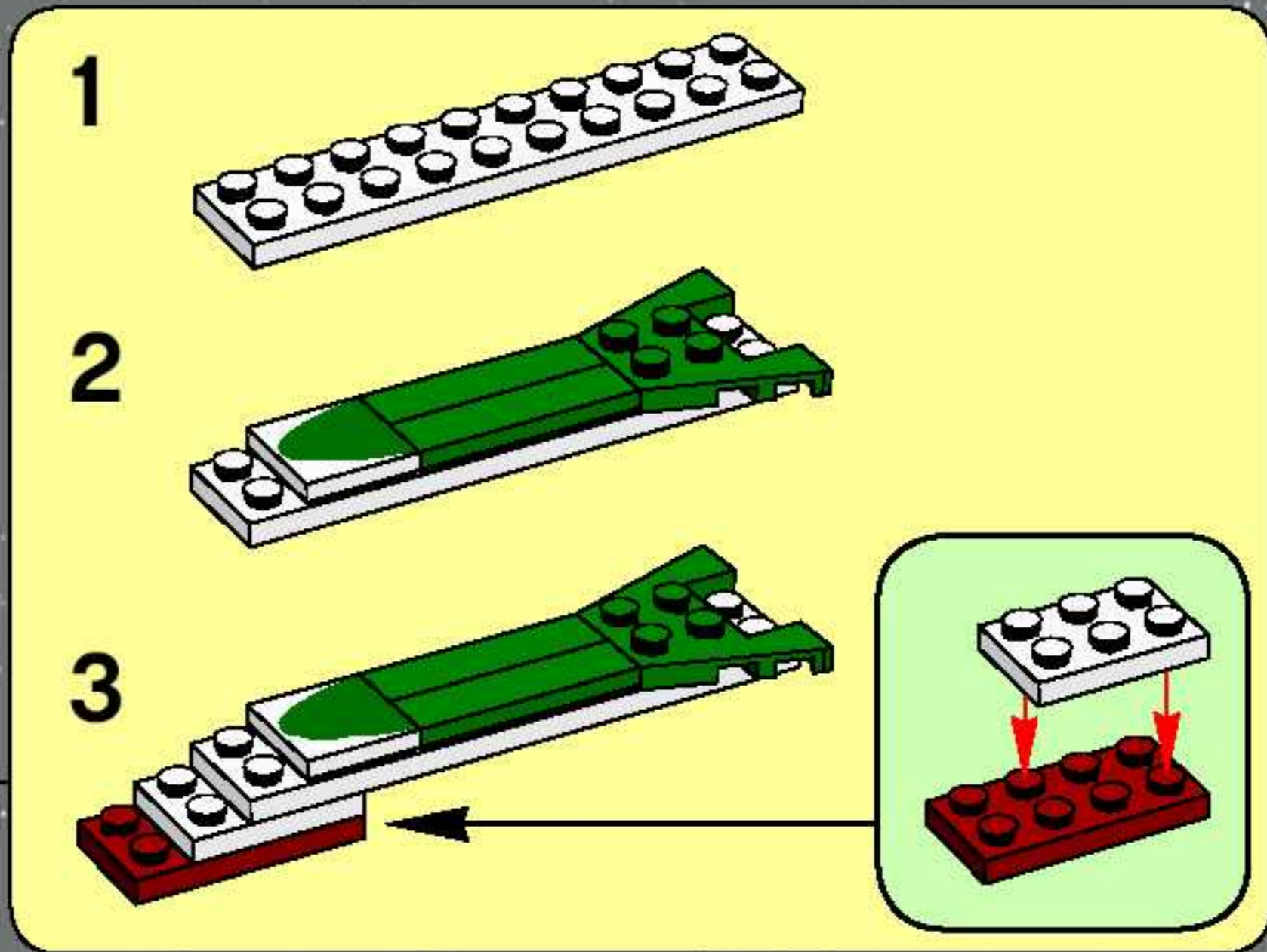

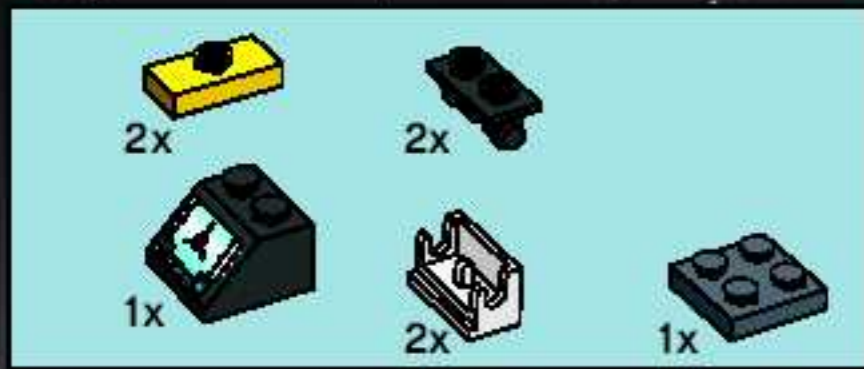

28

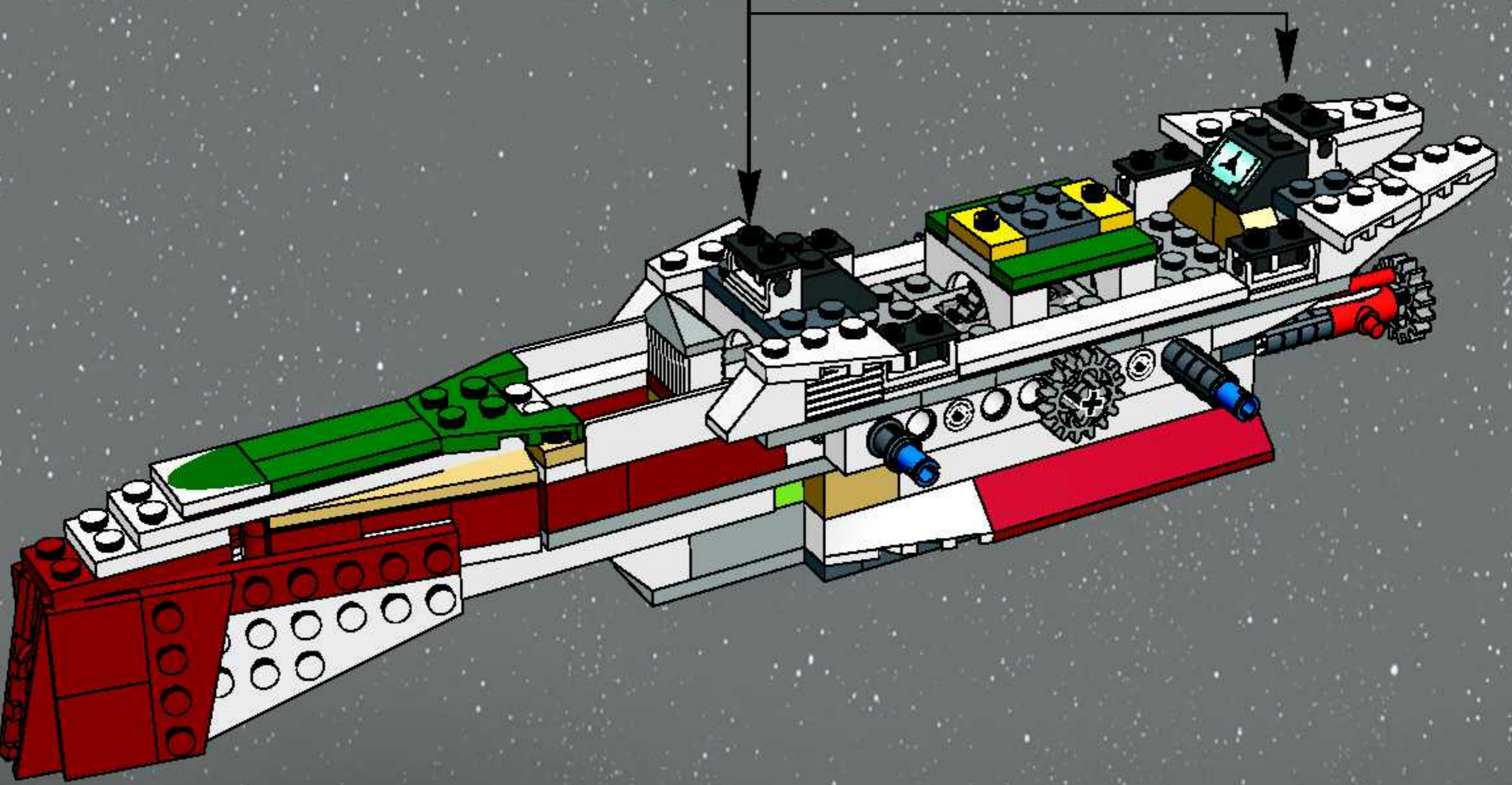
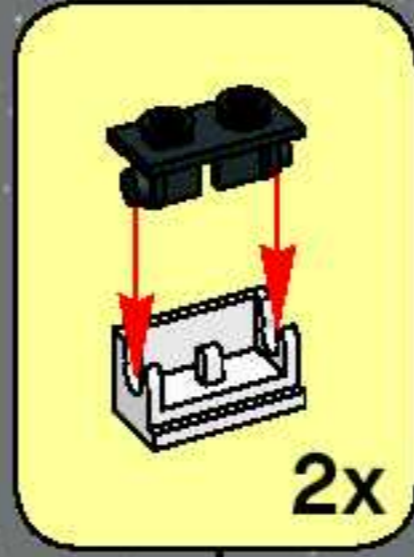

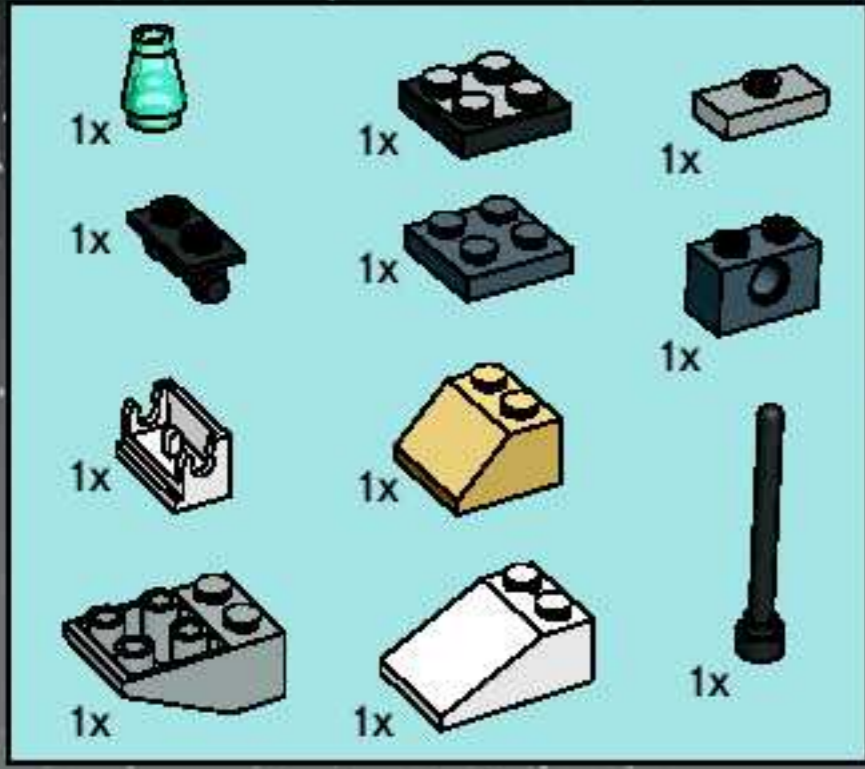

29

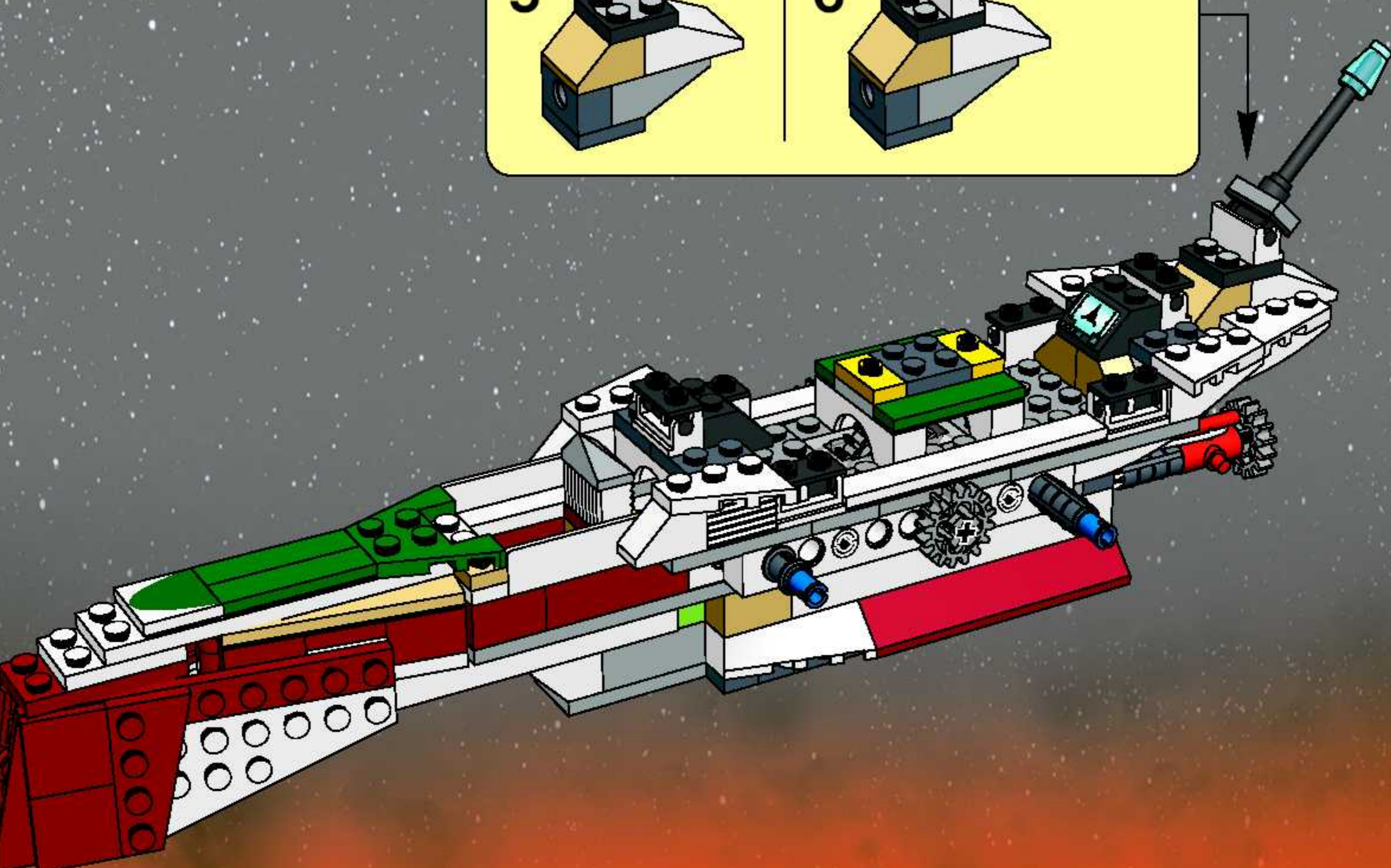
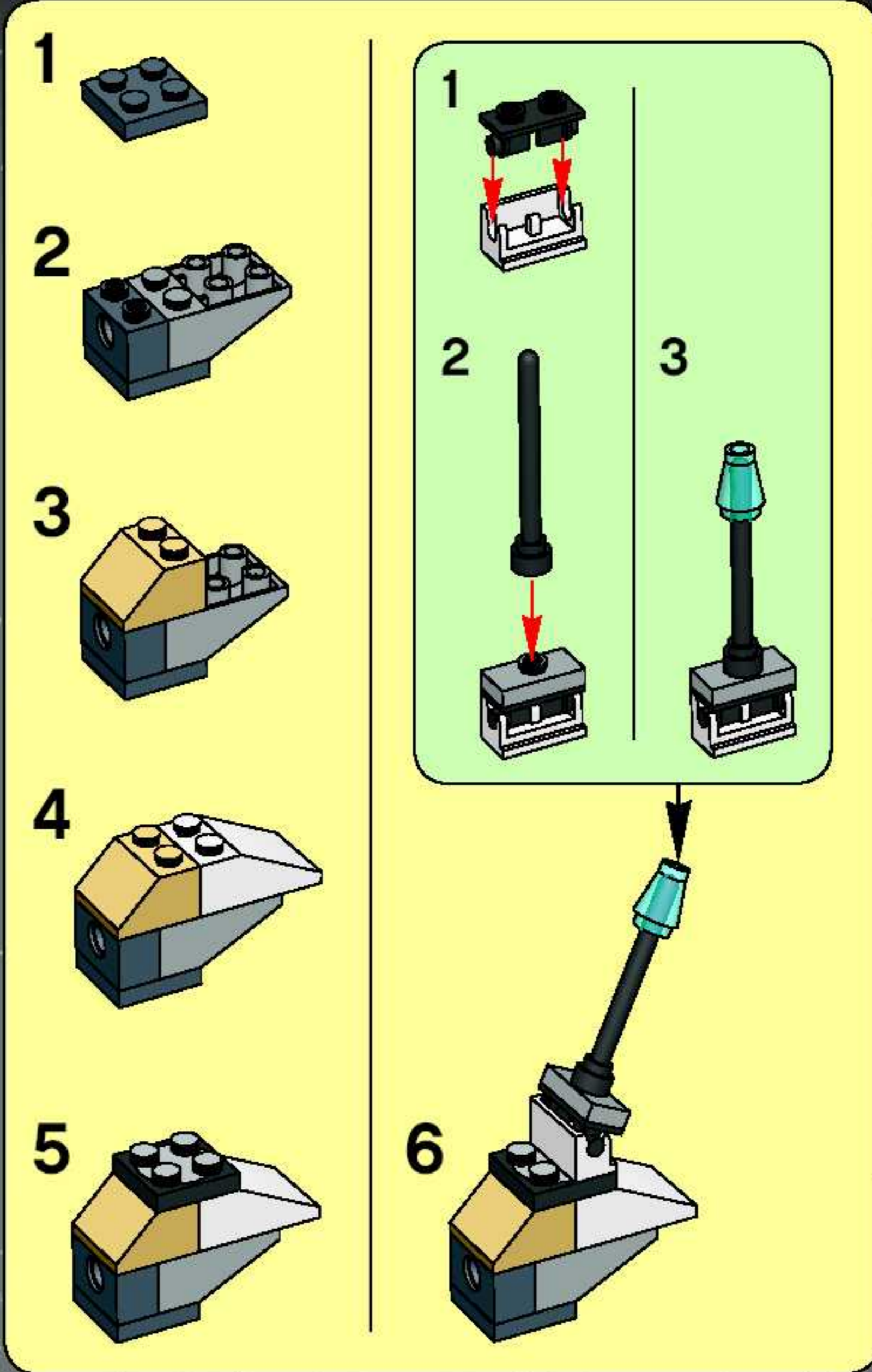

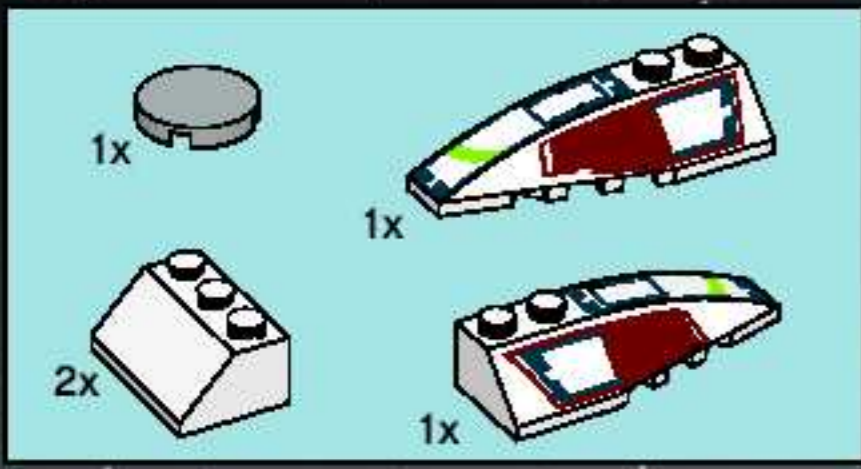

30

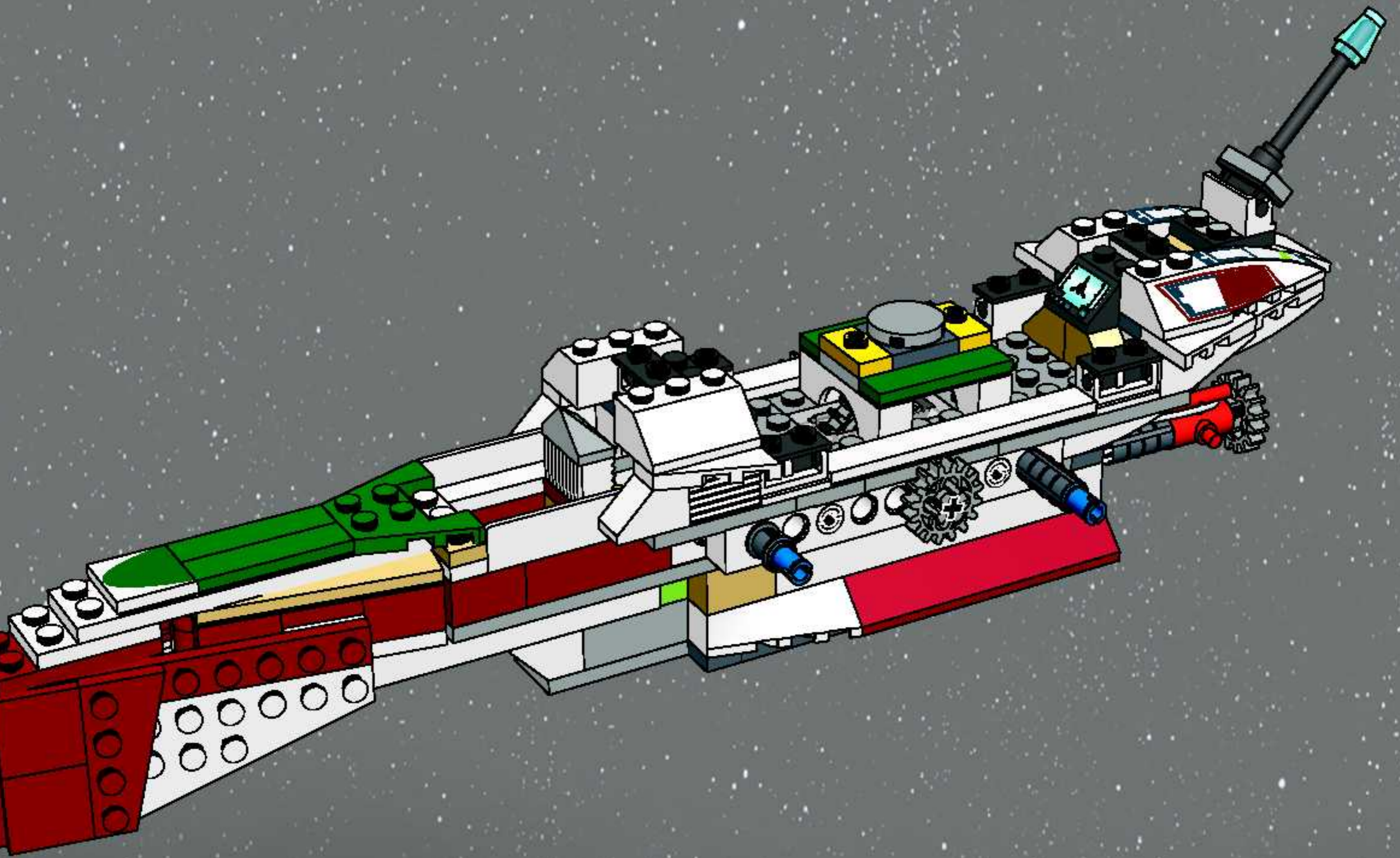

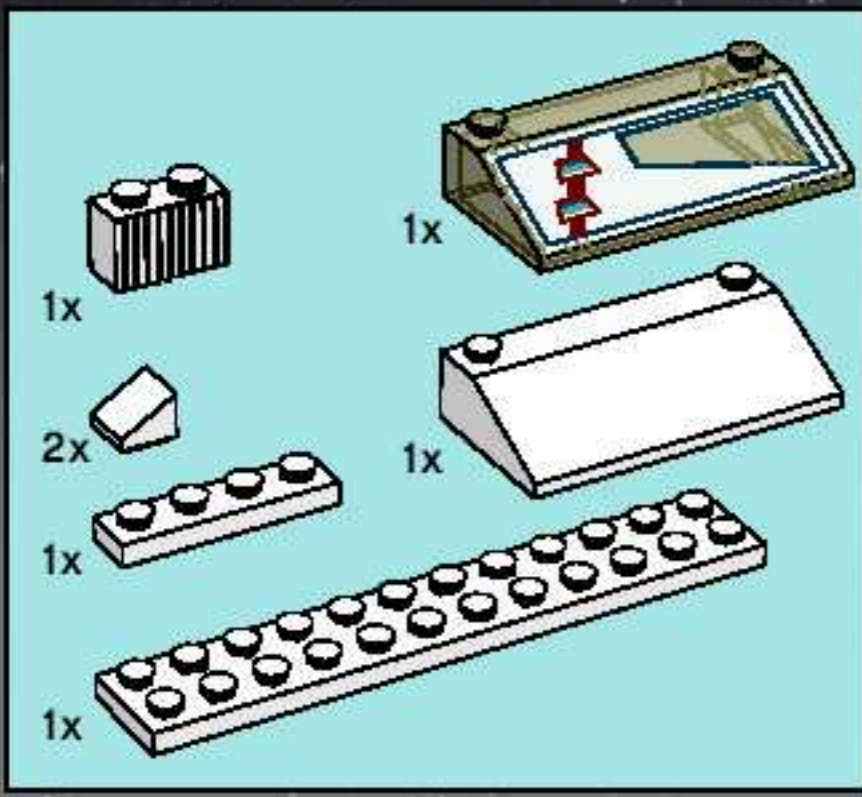

31

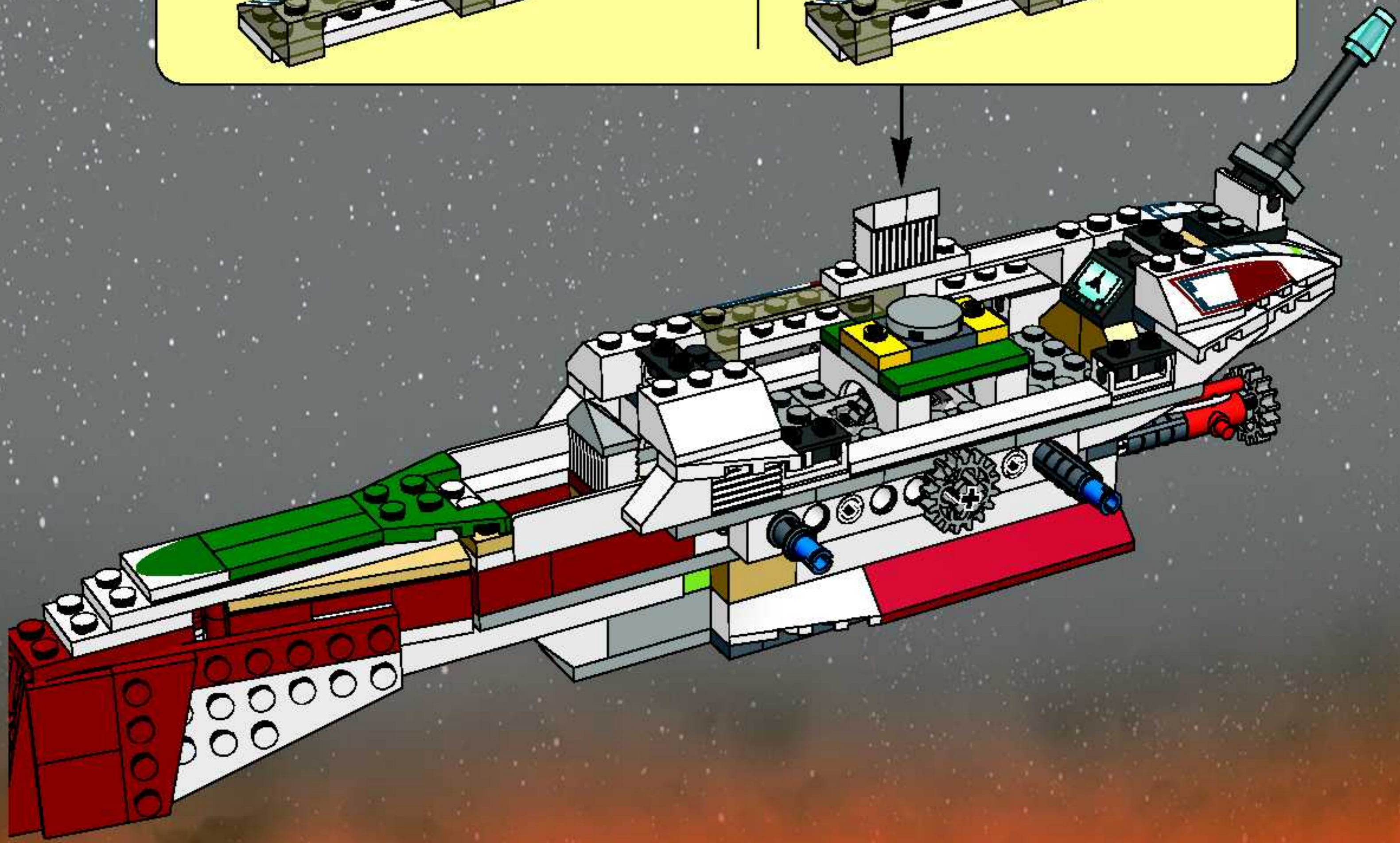
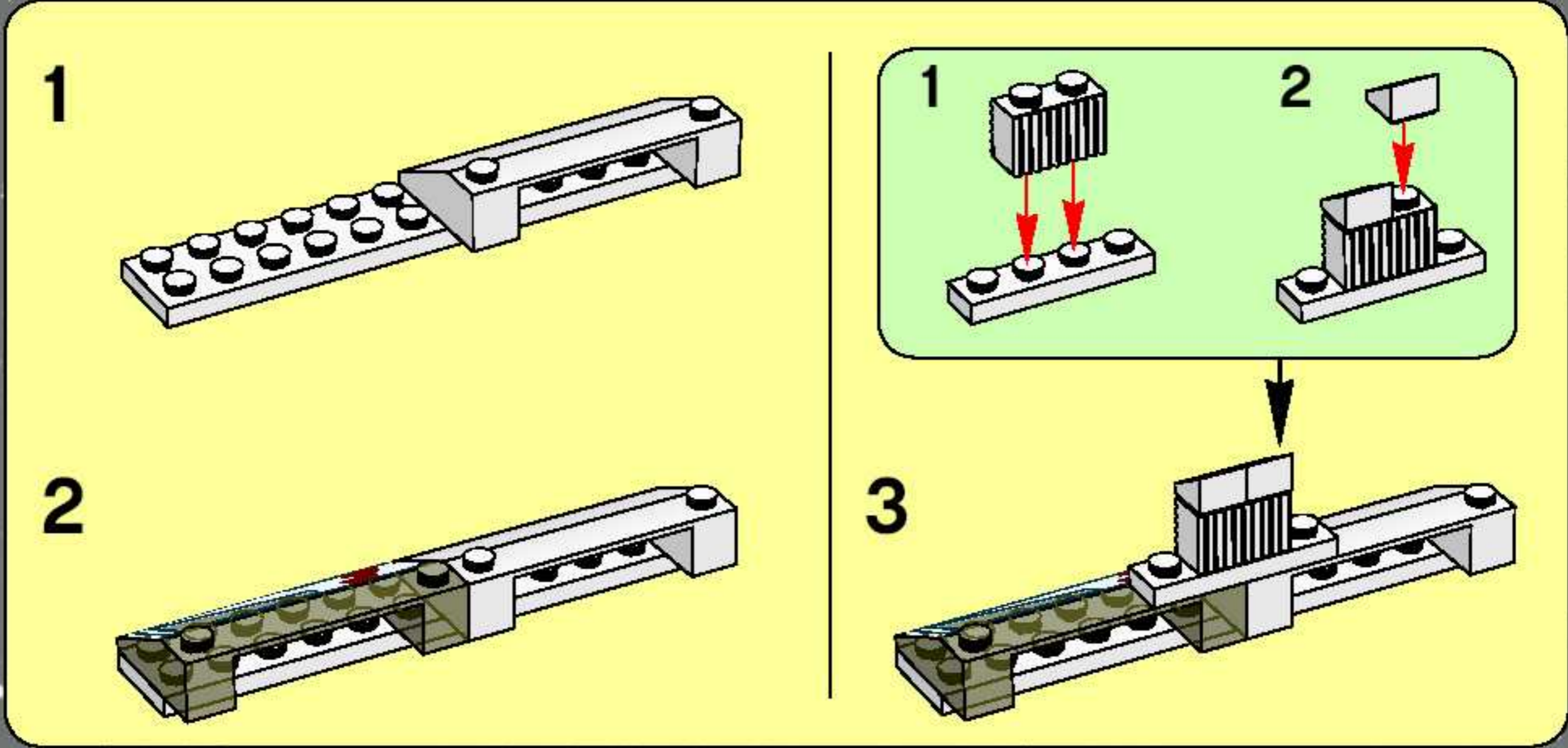

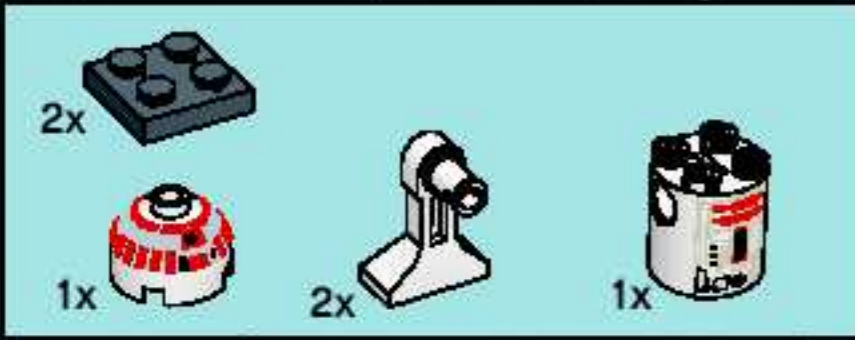

32

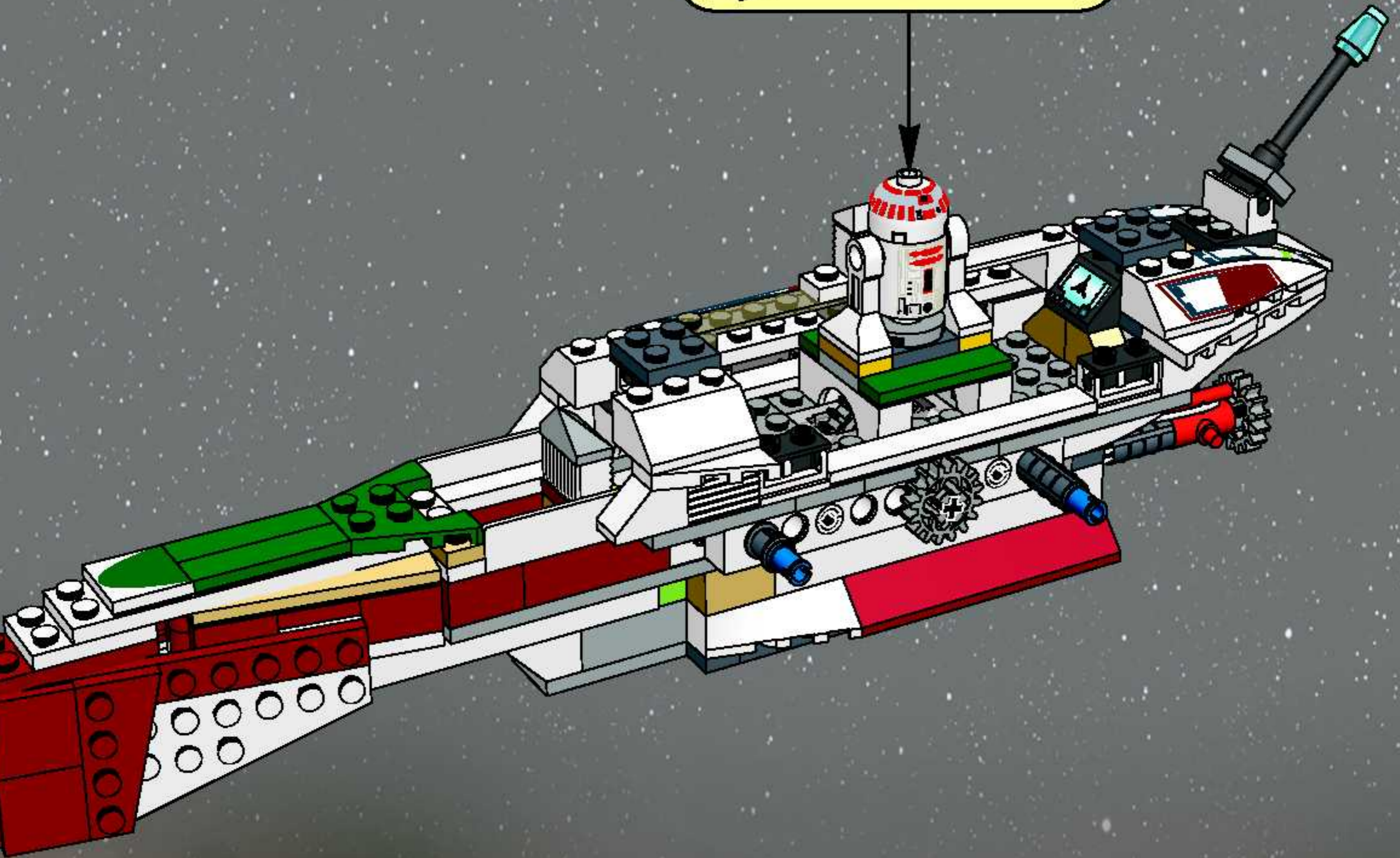
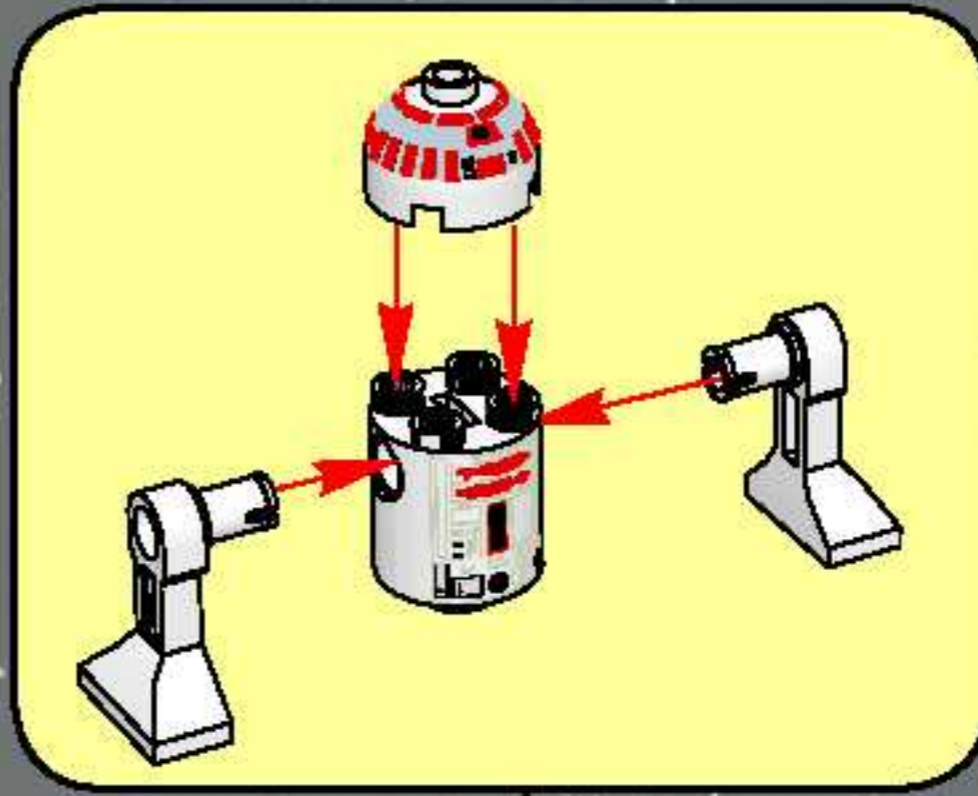

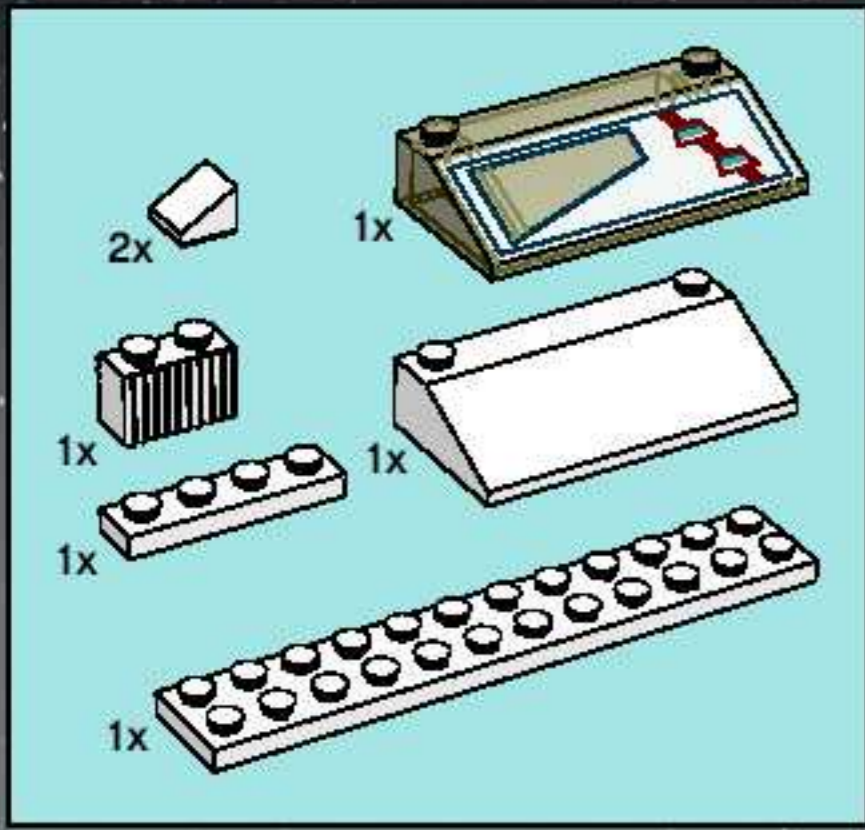

33

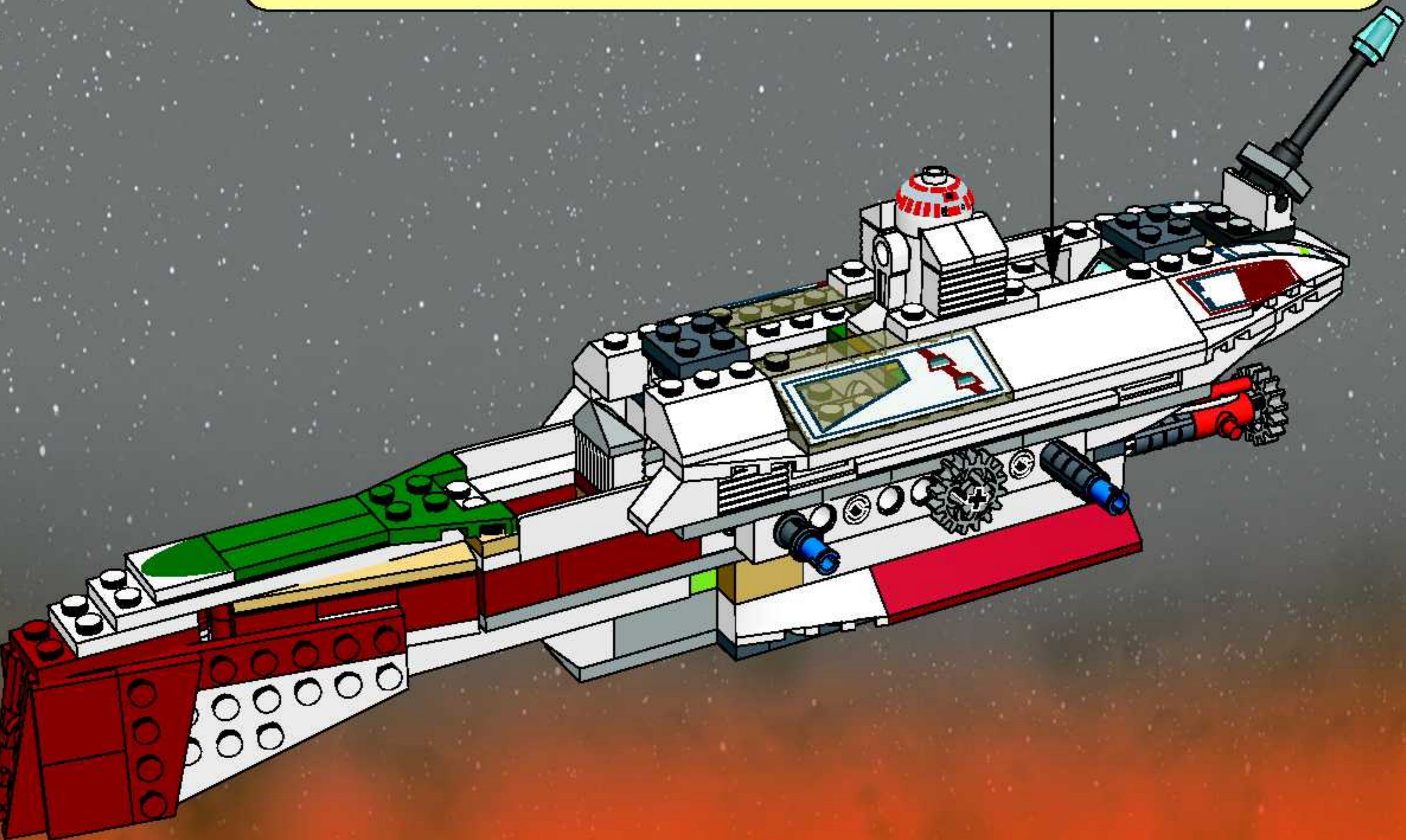
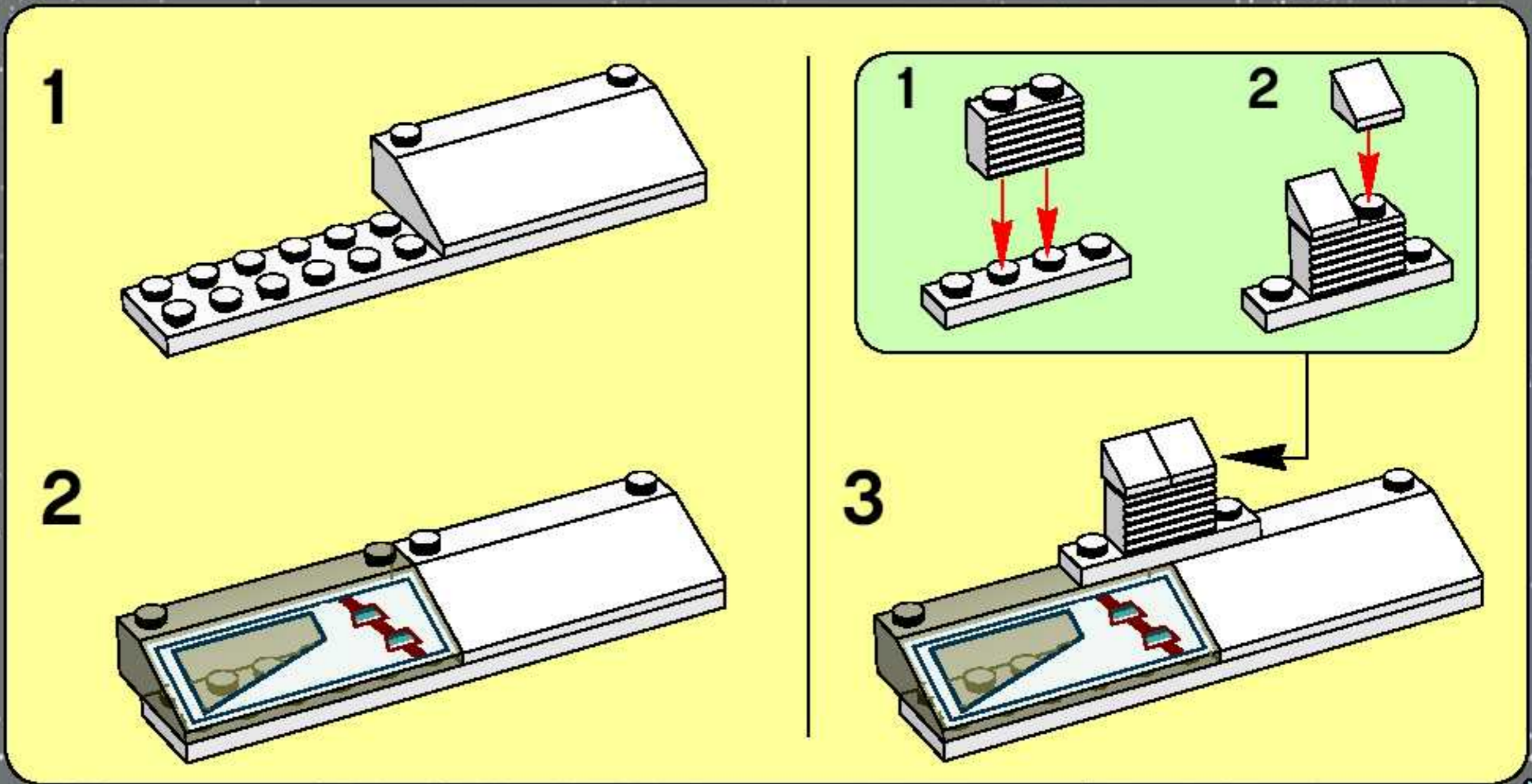

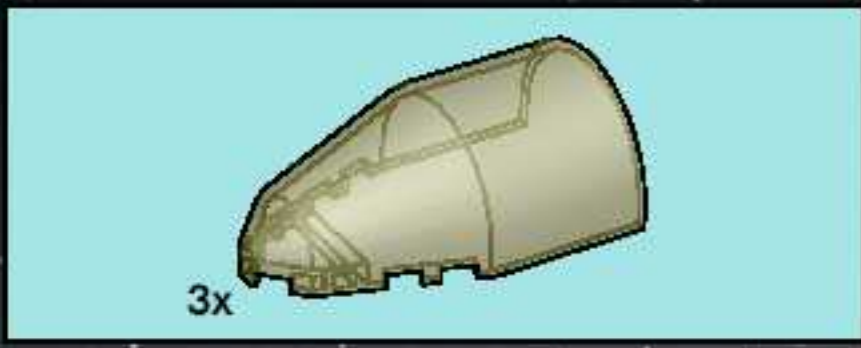

34

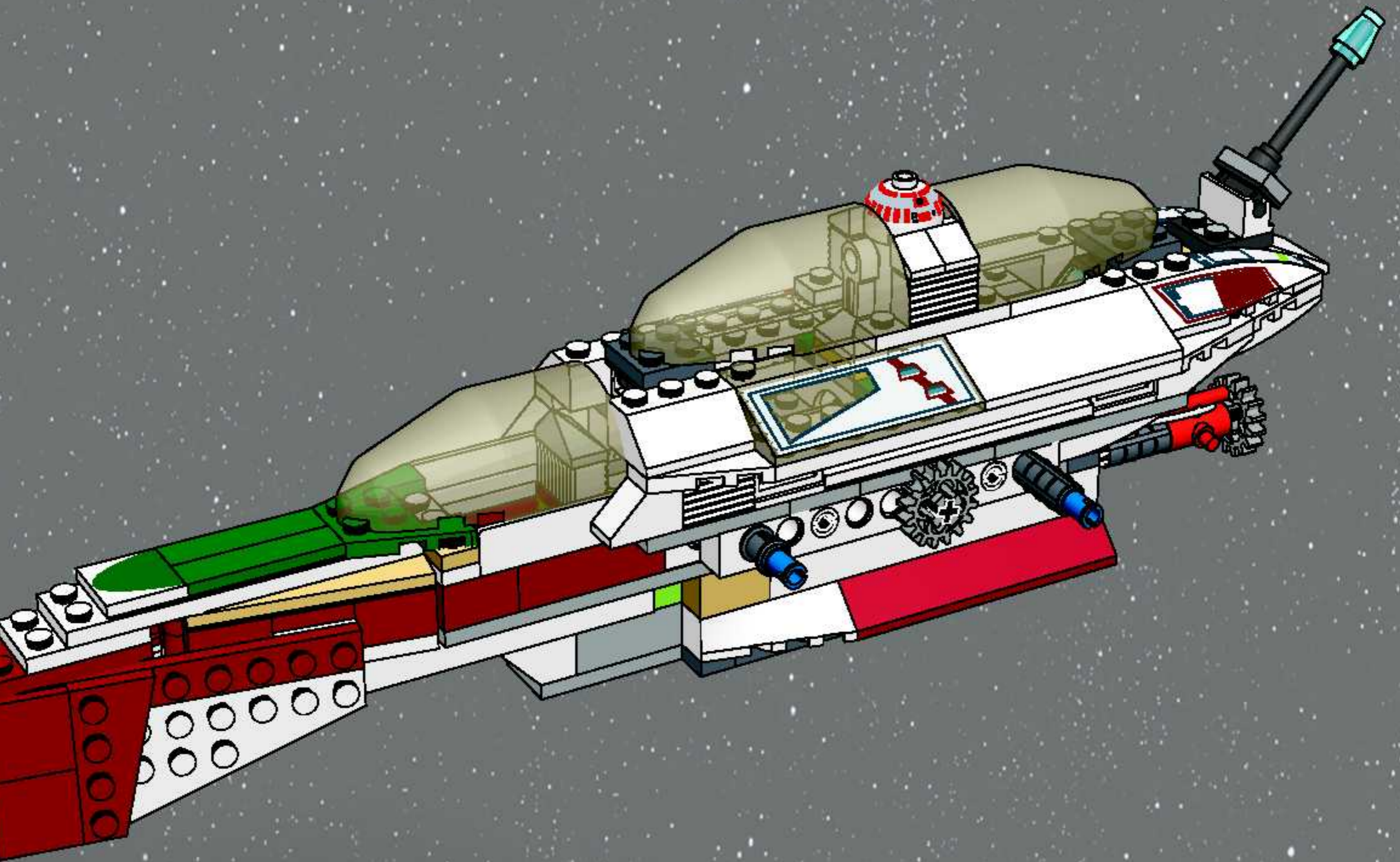

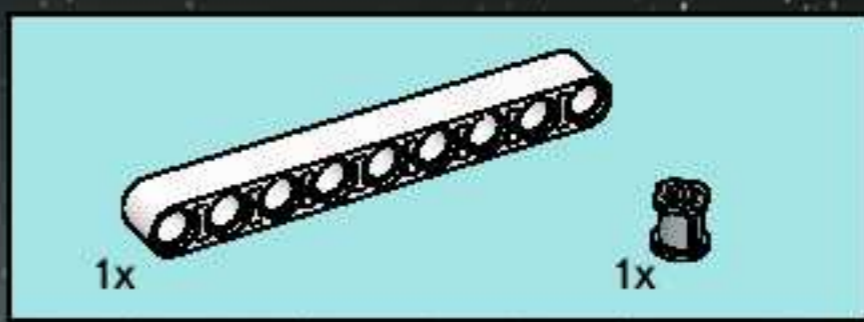
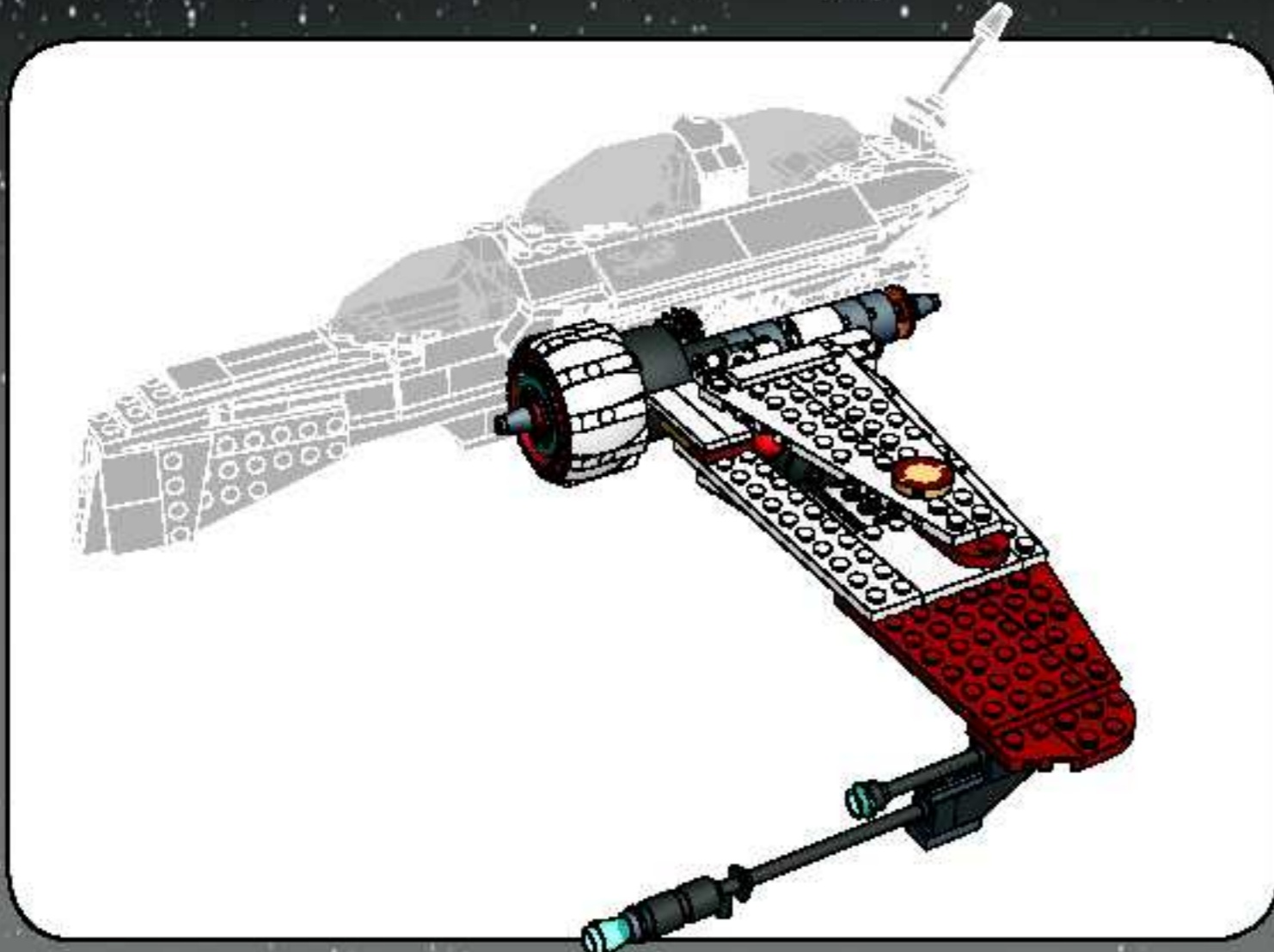

4

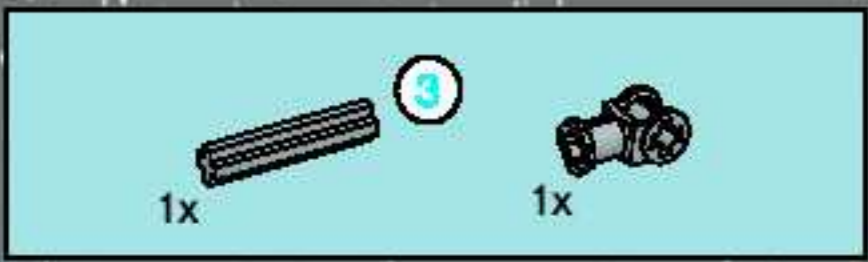
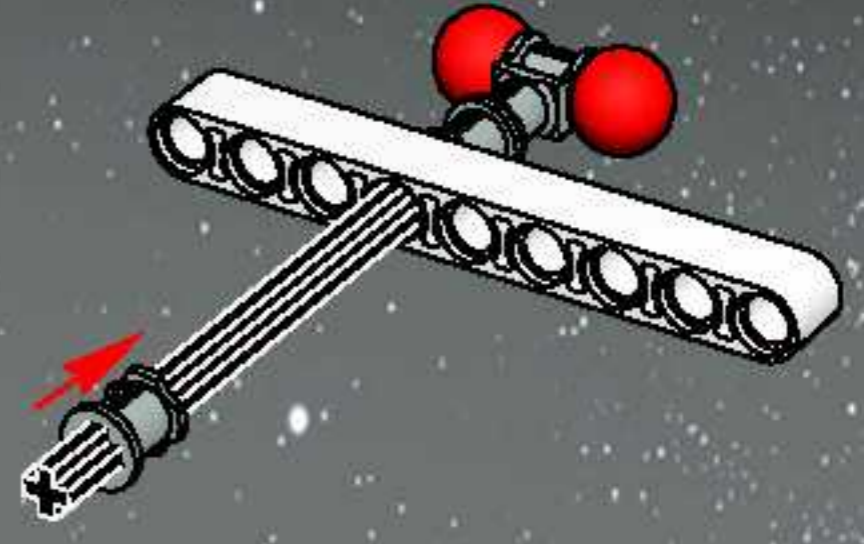

1

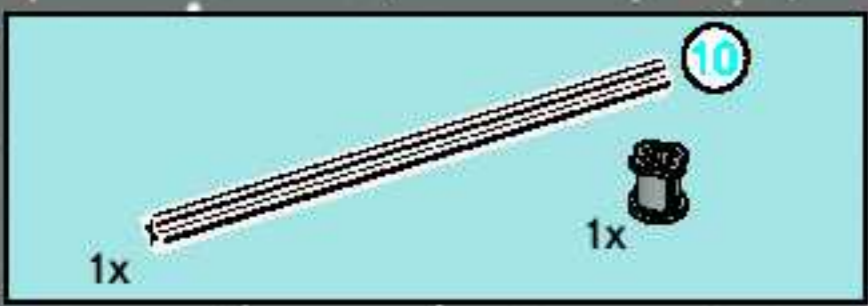
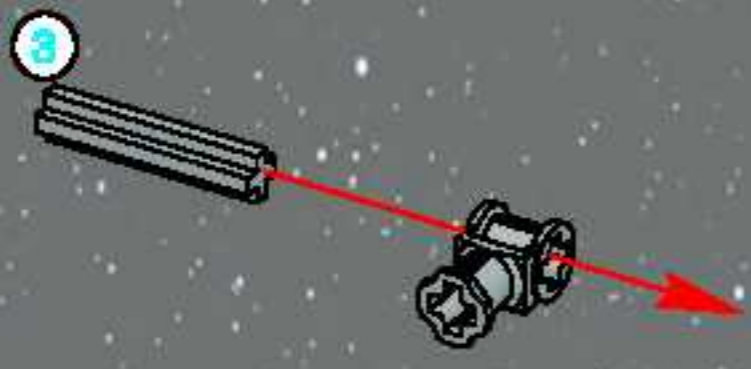

2

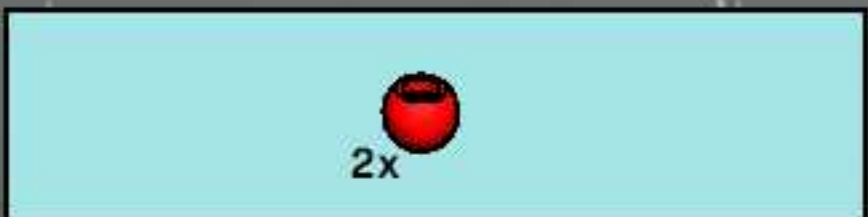
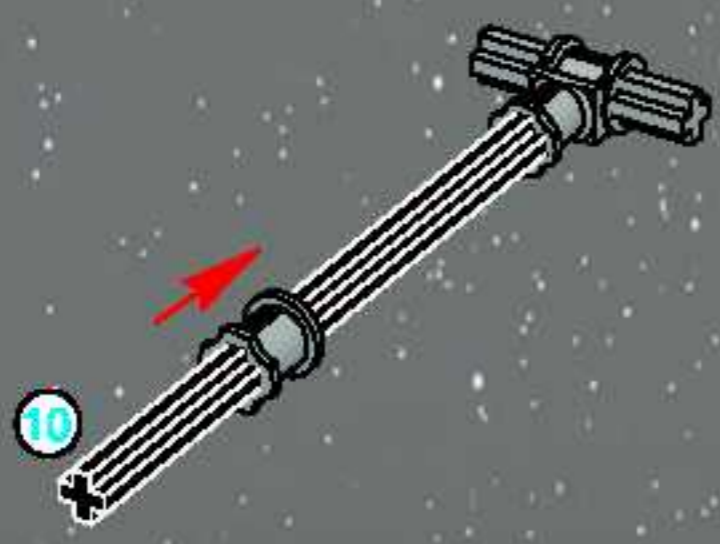

3



5

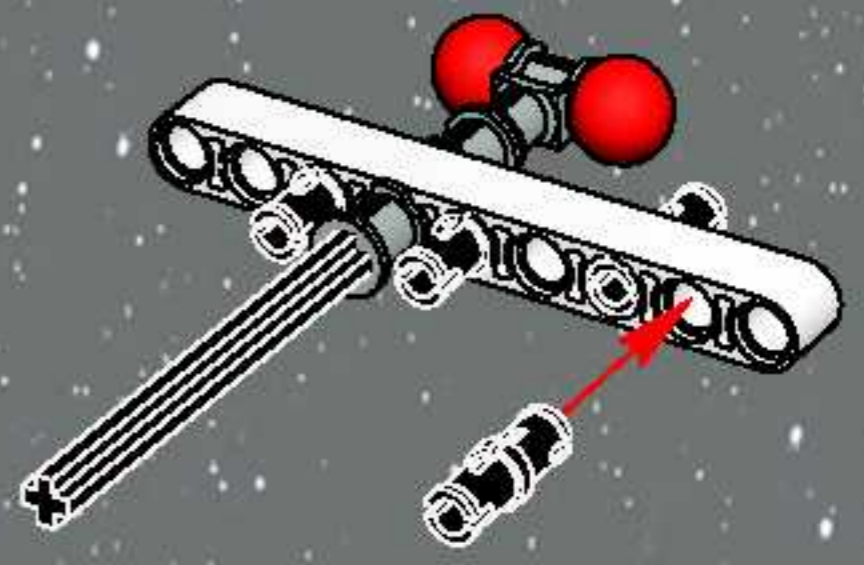

6

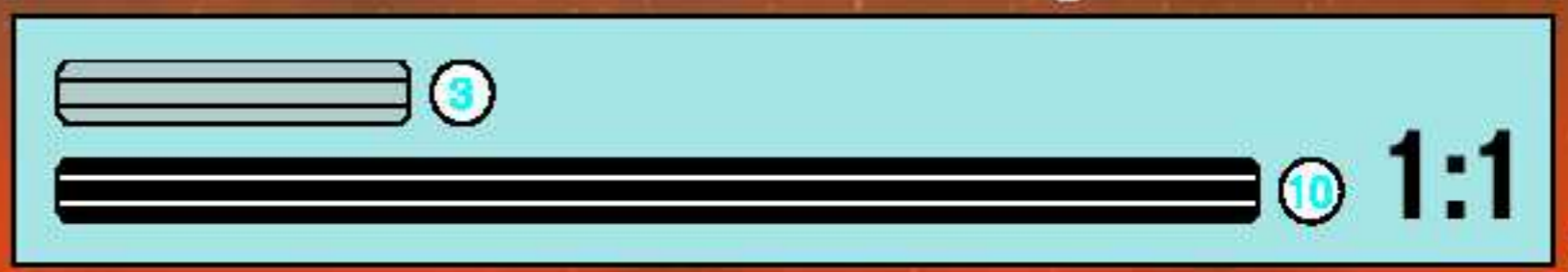
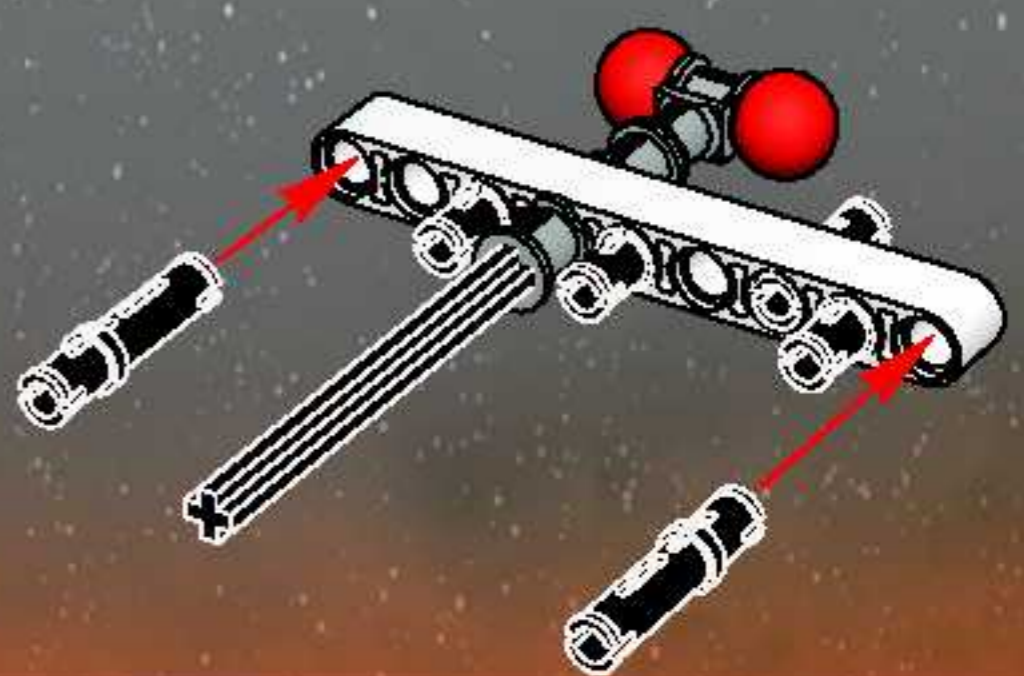

1:1

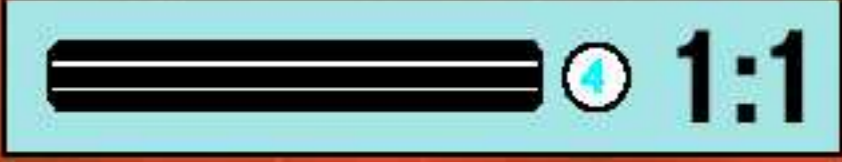
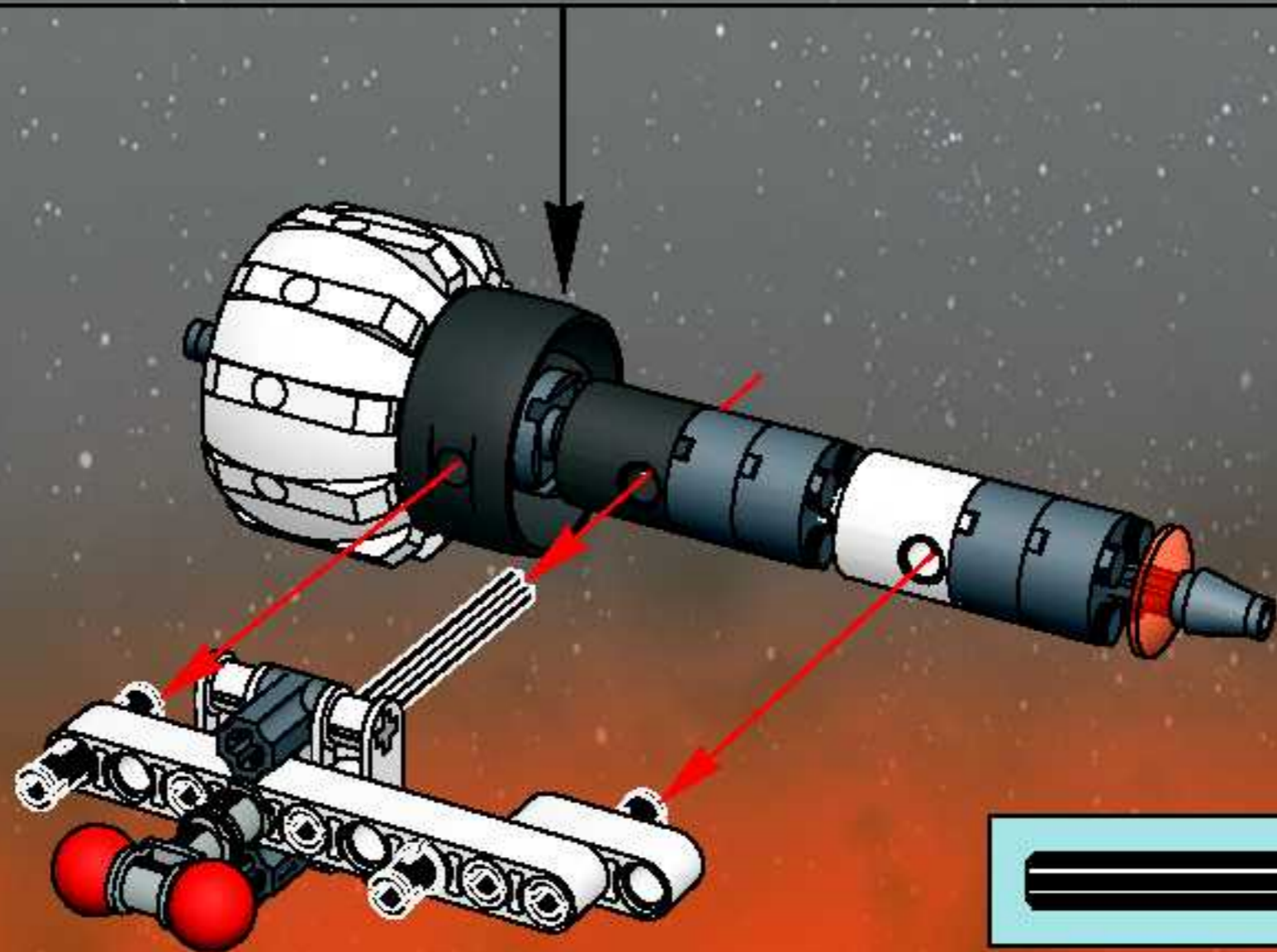
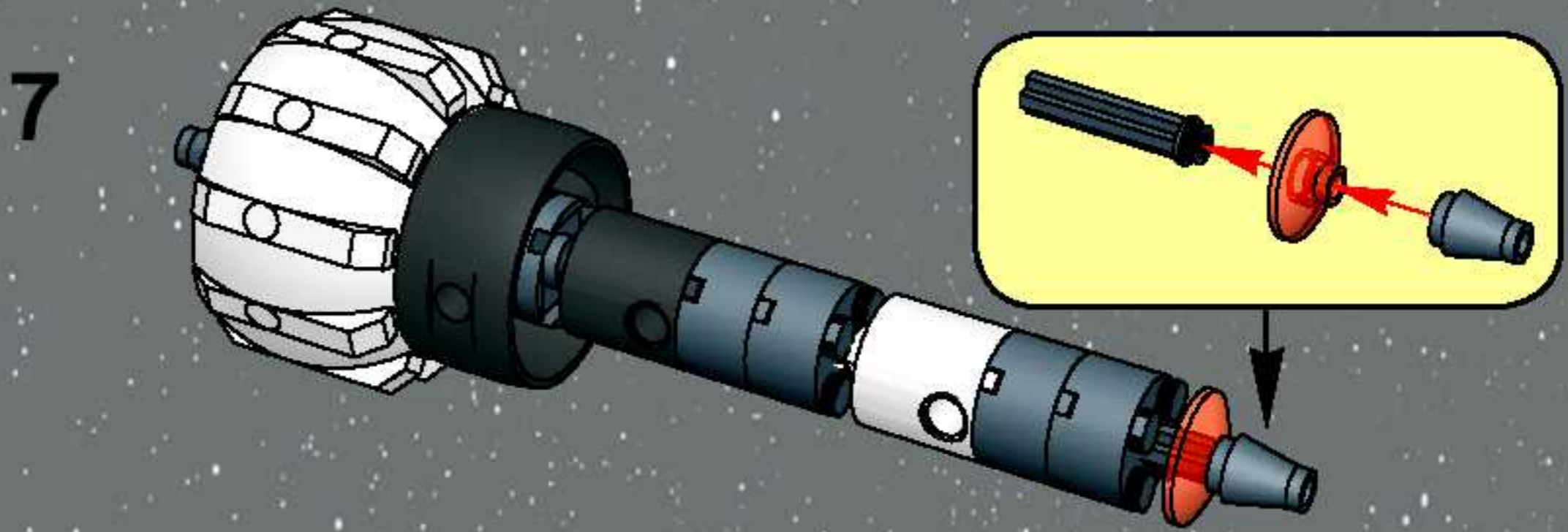
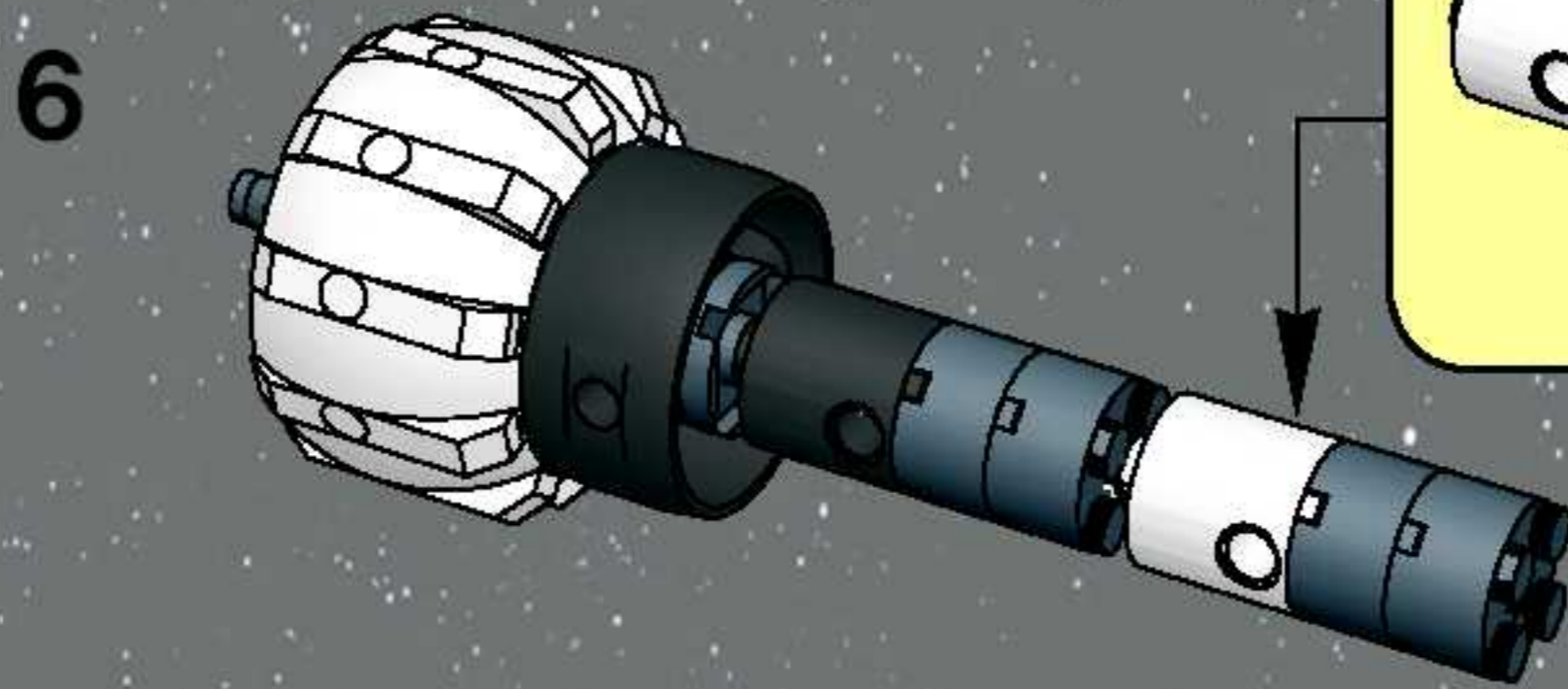
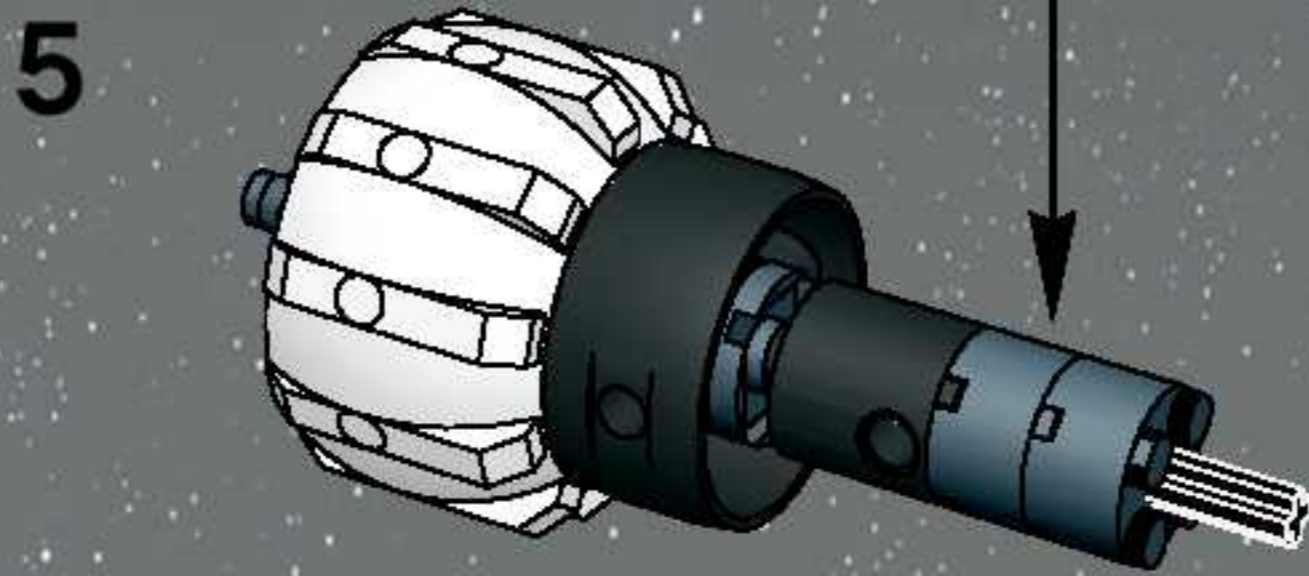
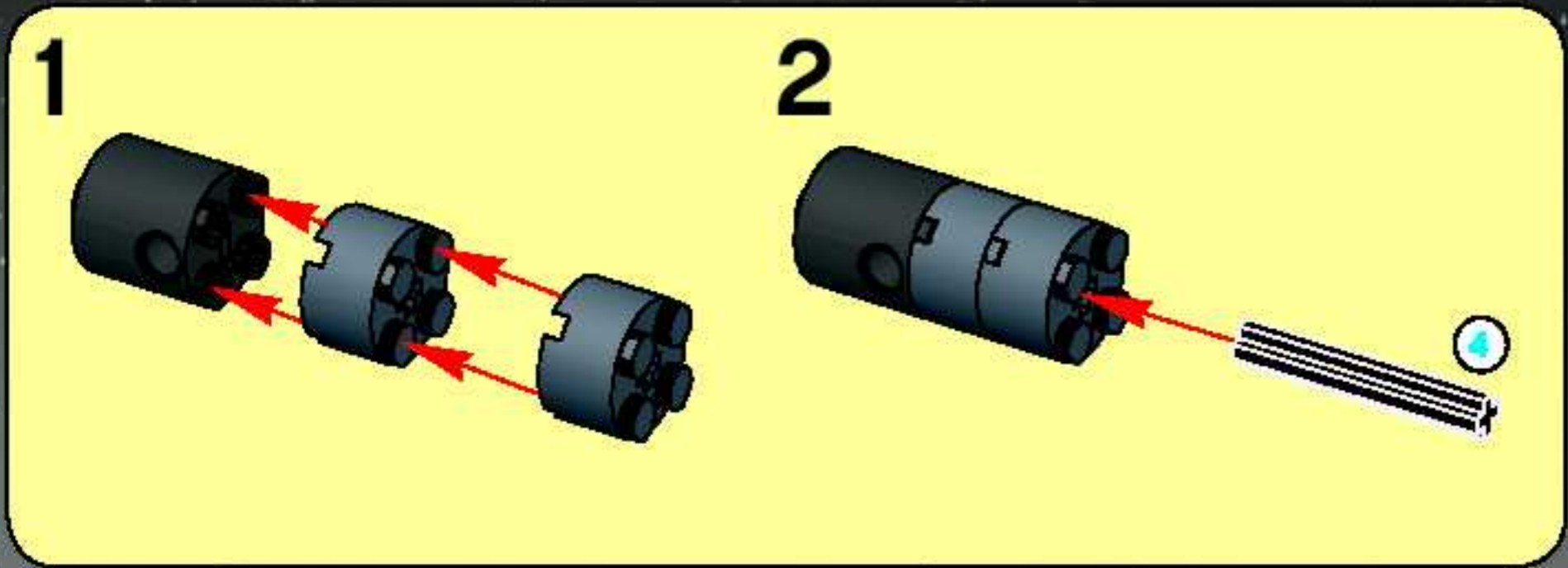



10

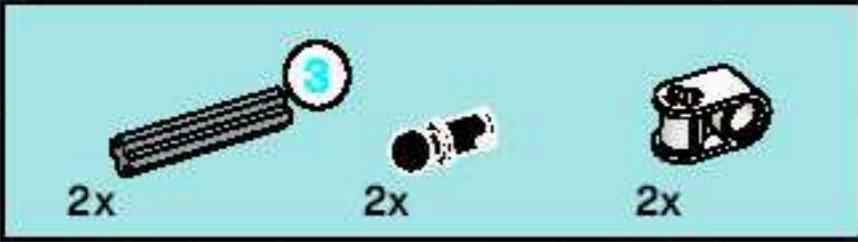
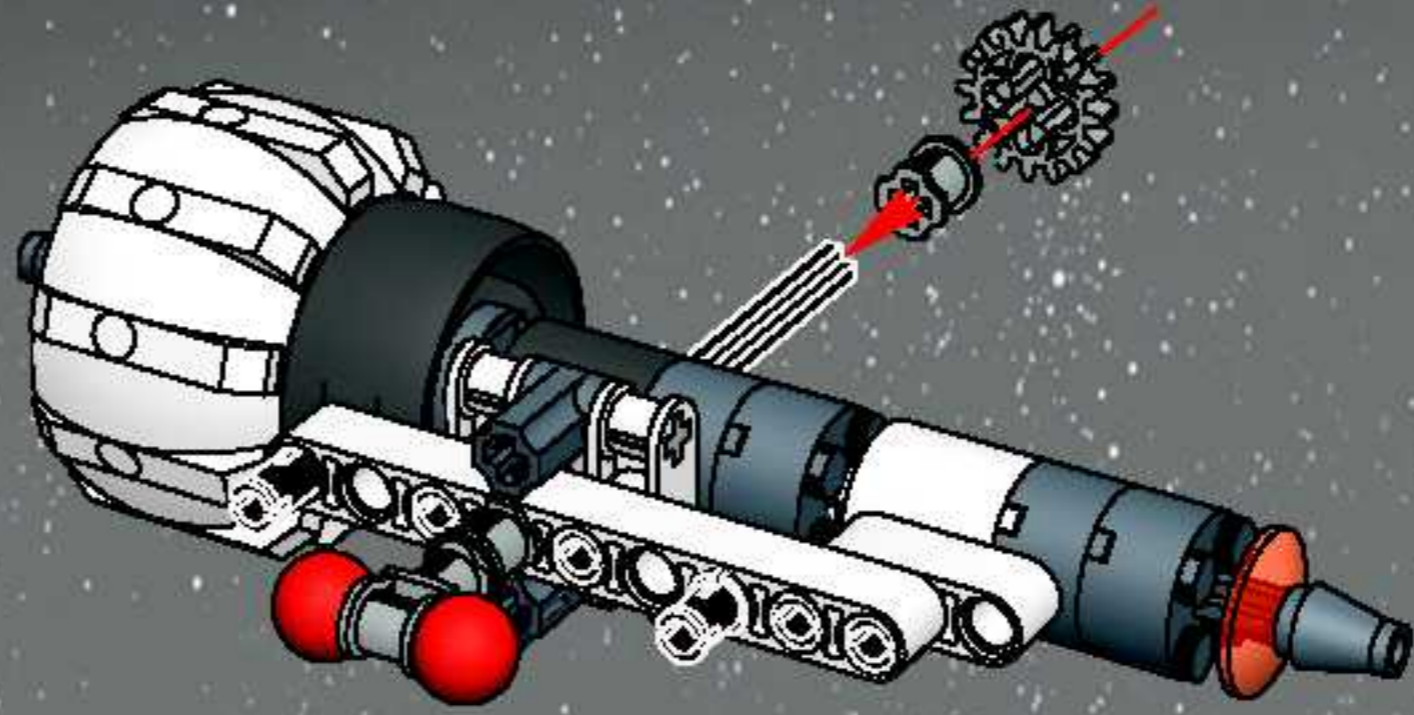

11

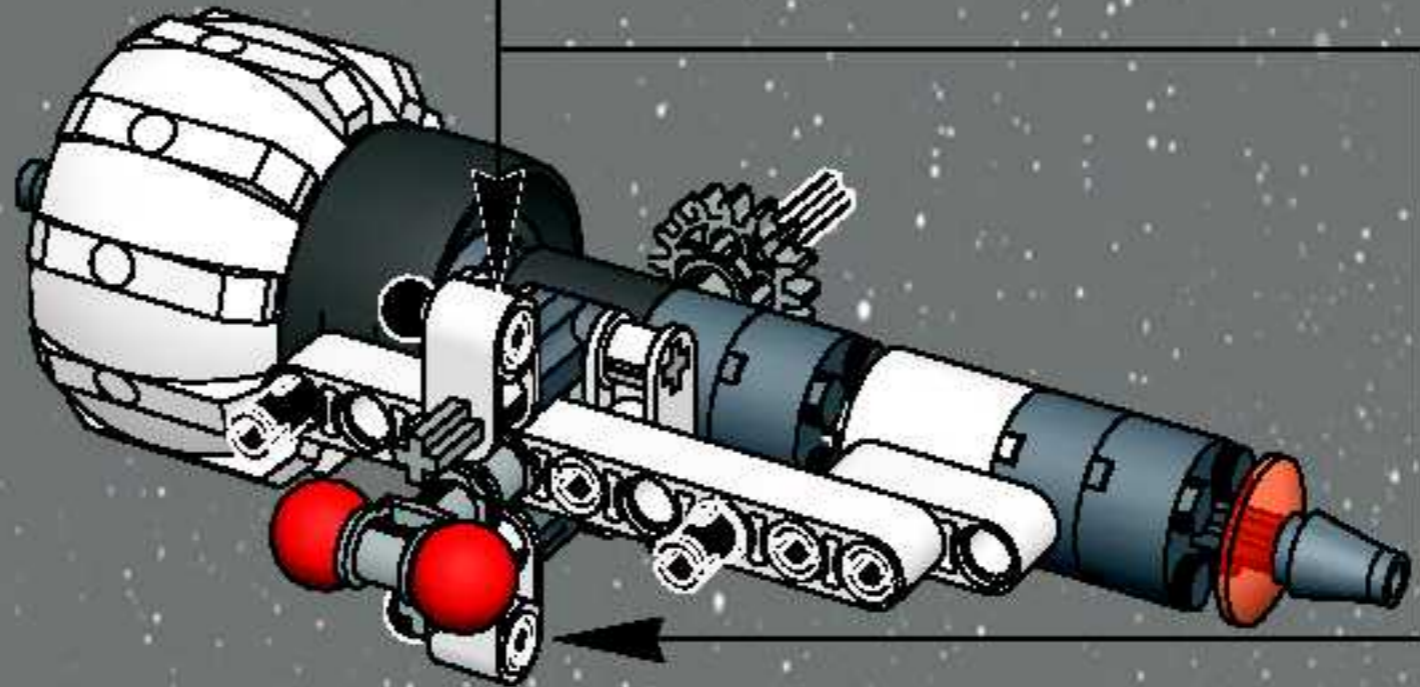
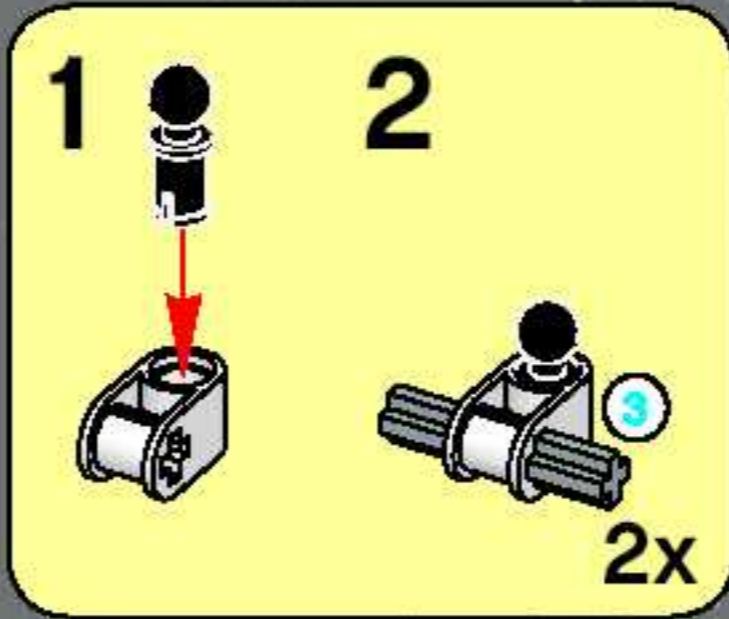

12

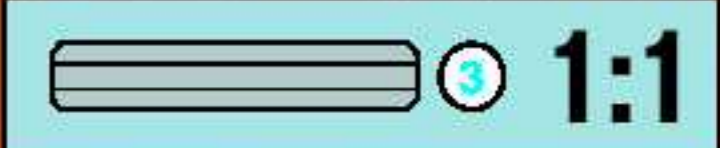
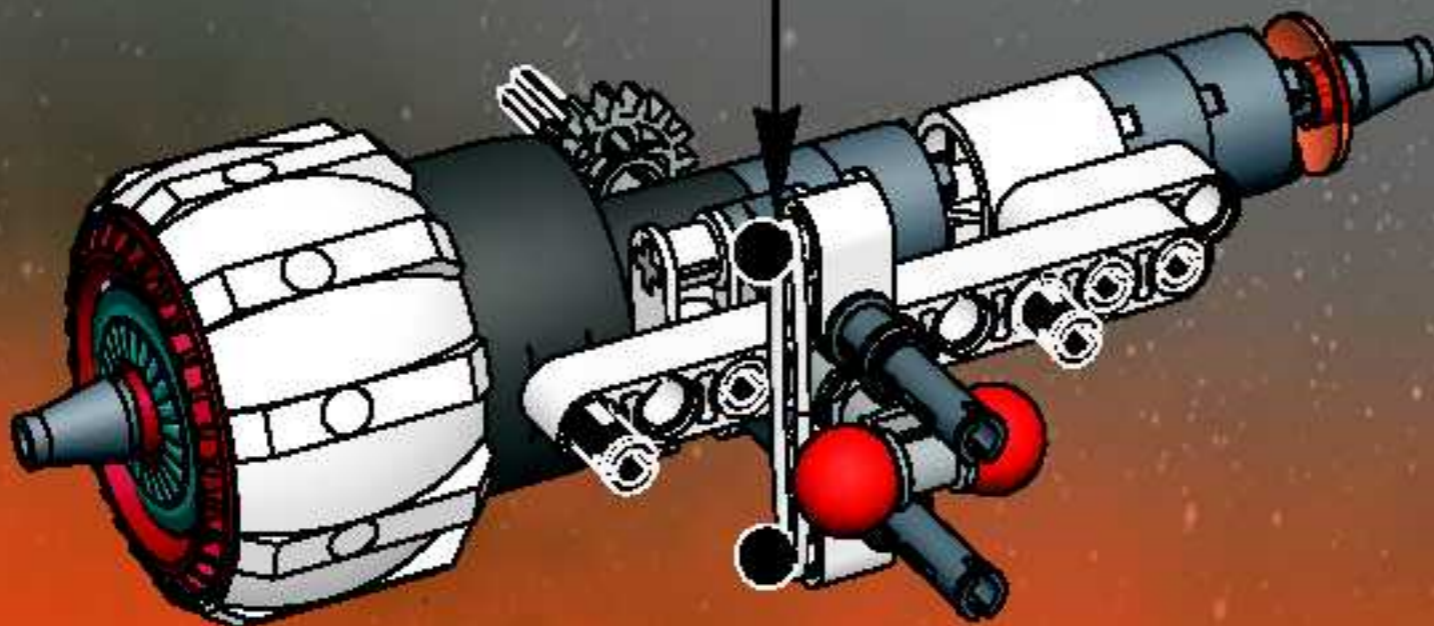
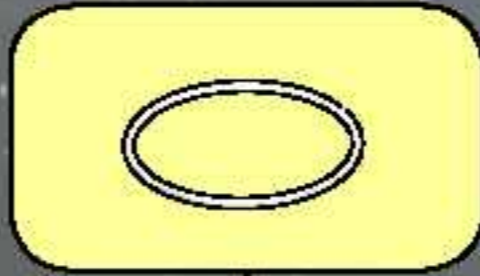

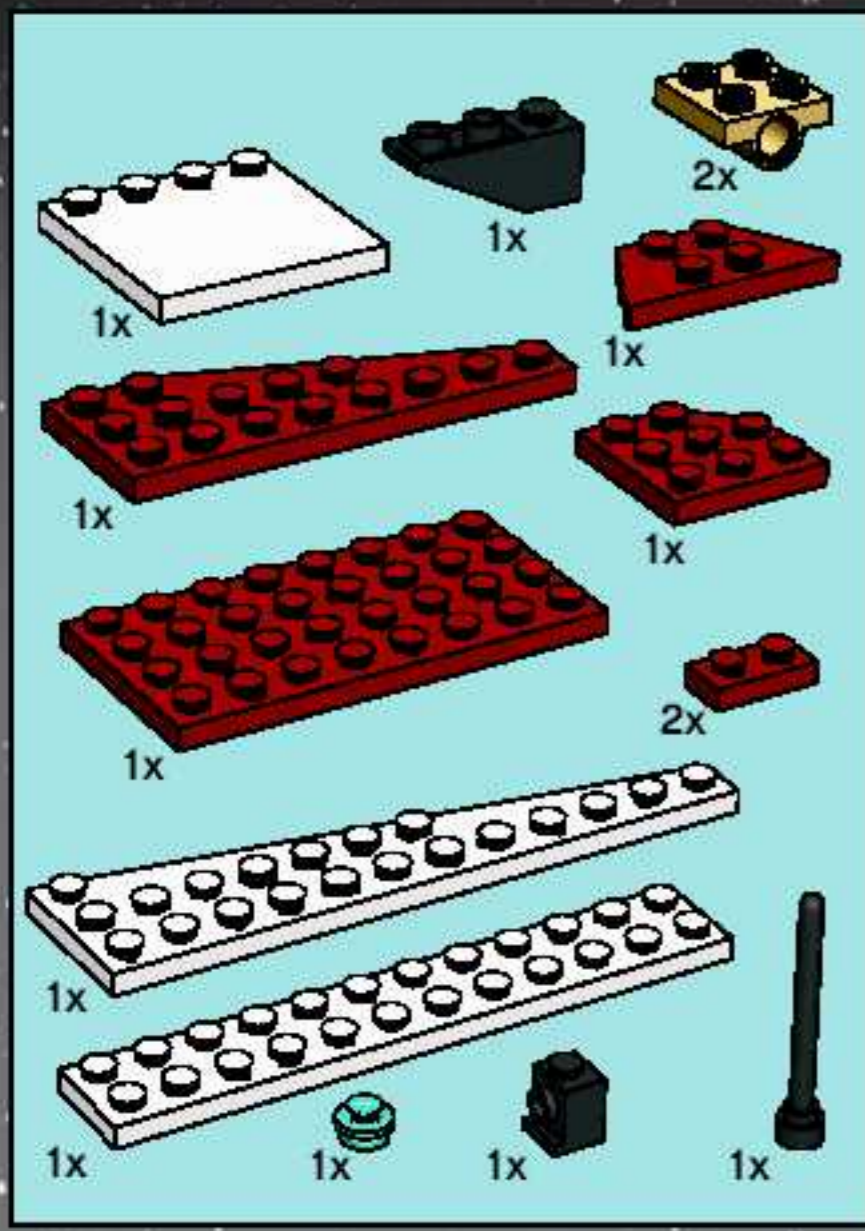

13

1

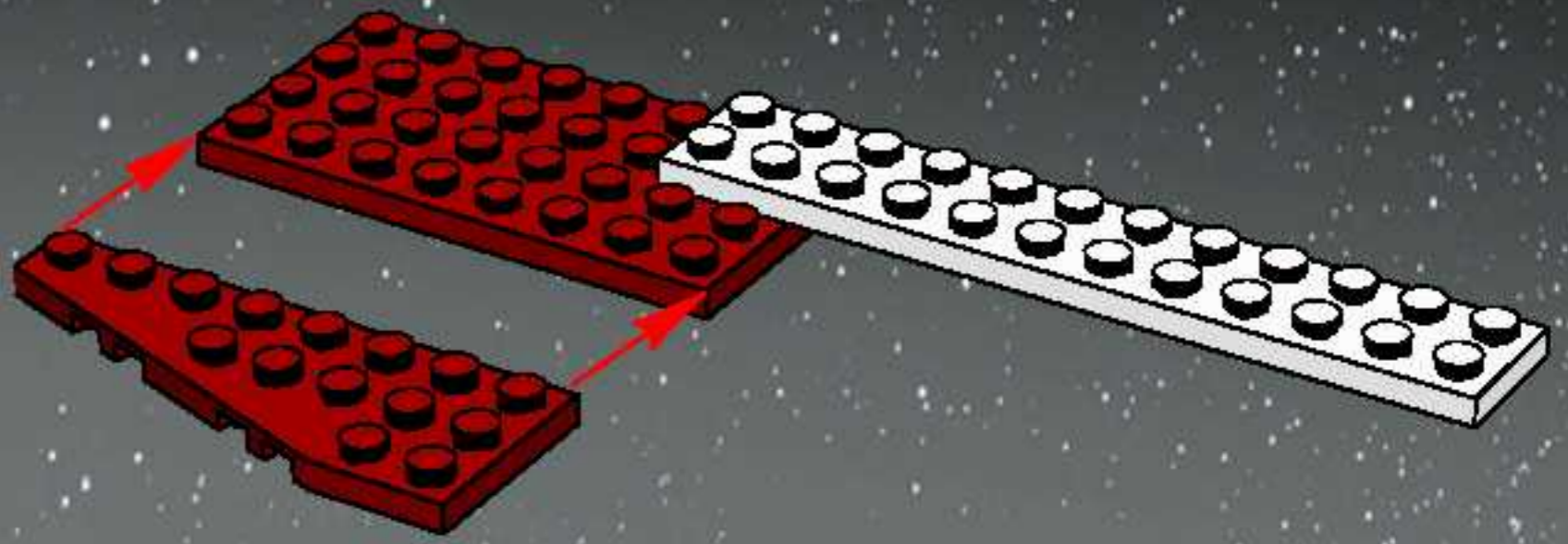

2

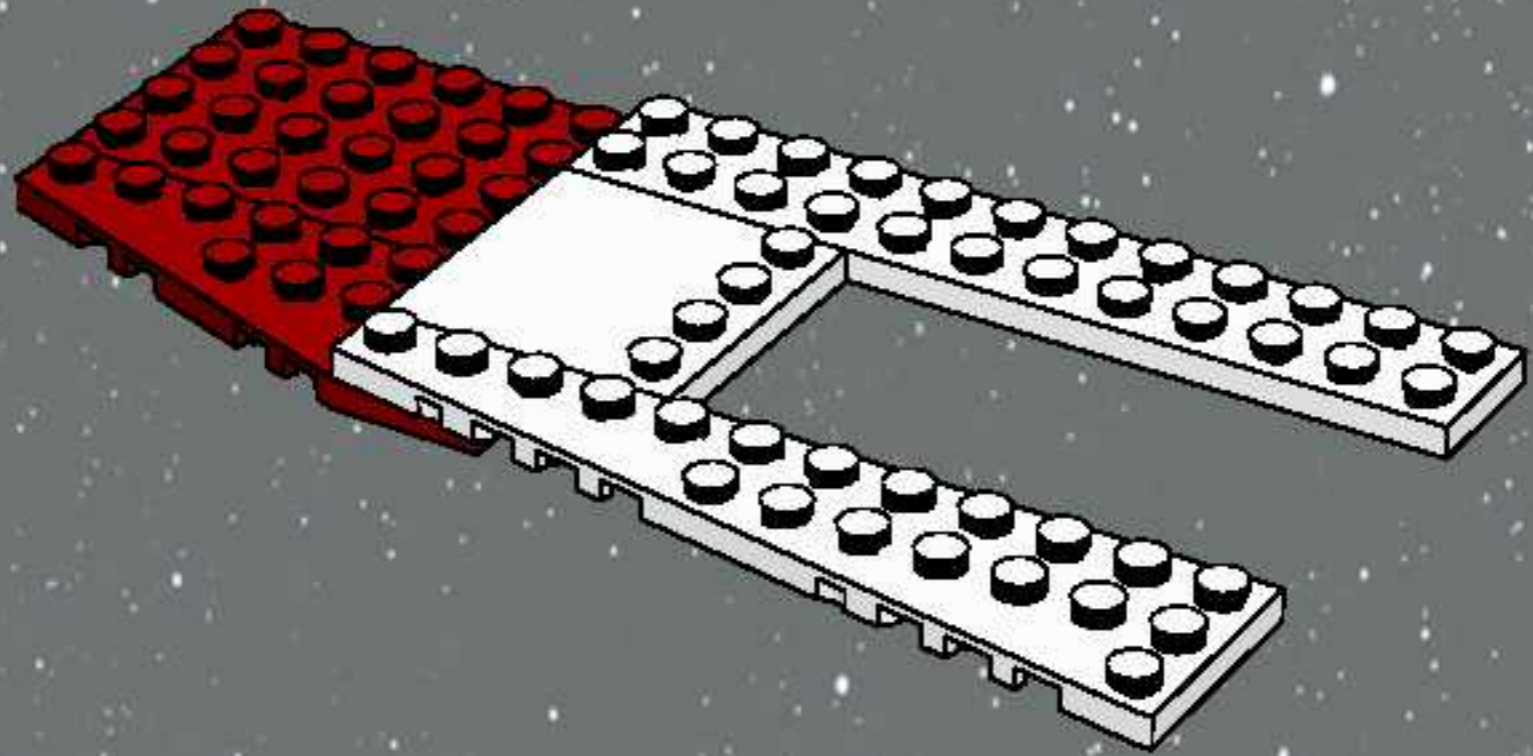

3

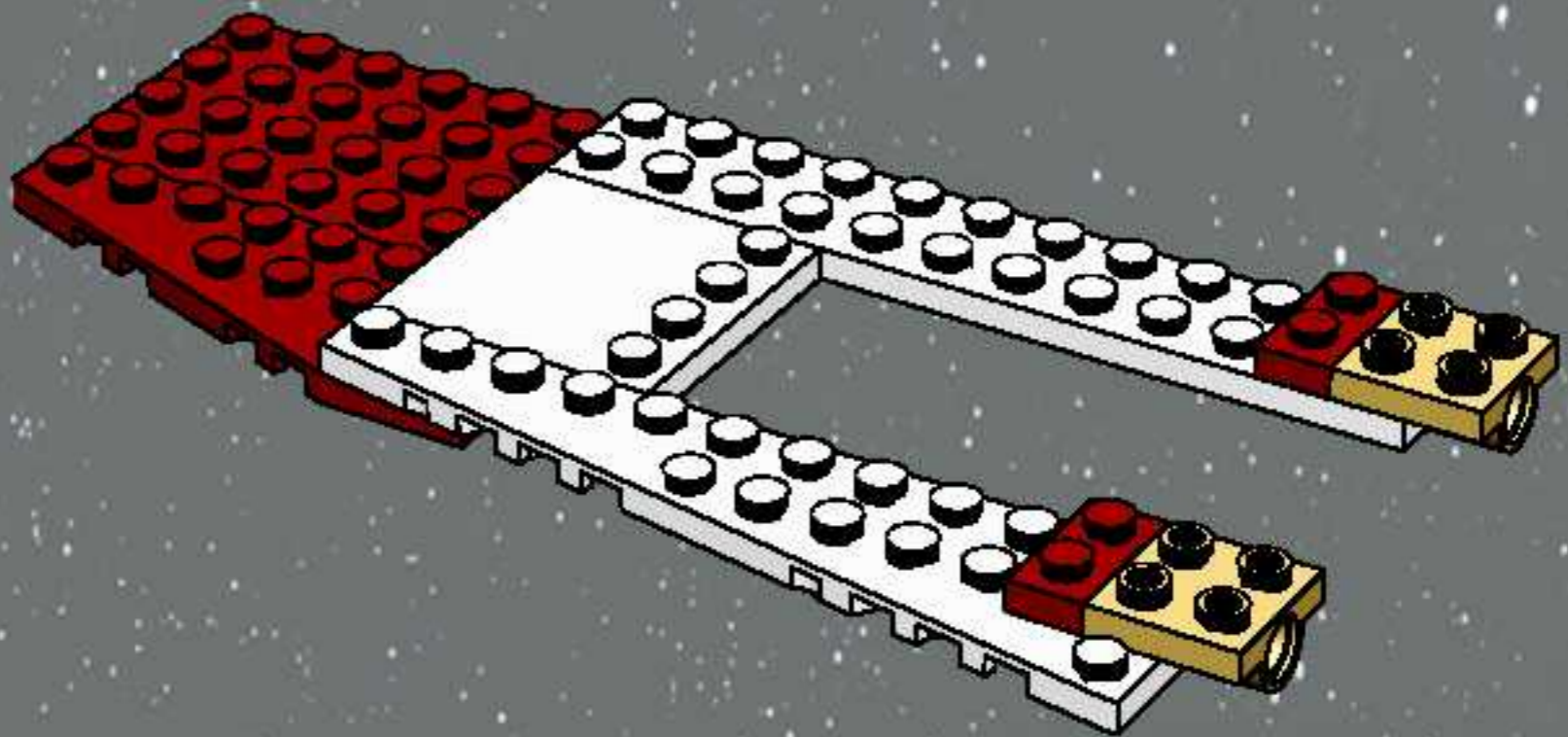

4

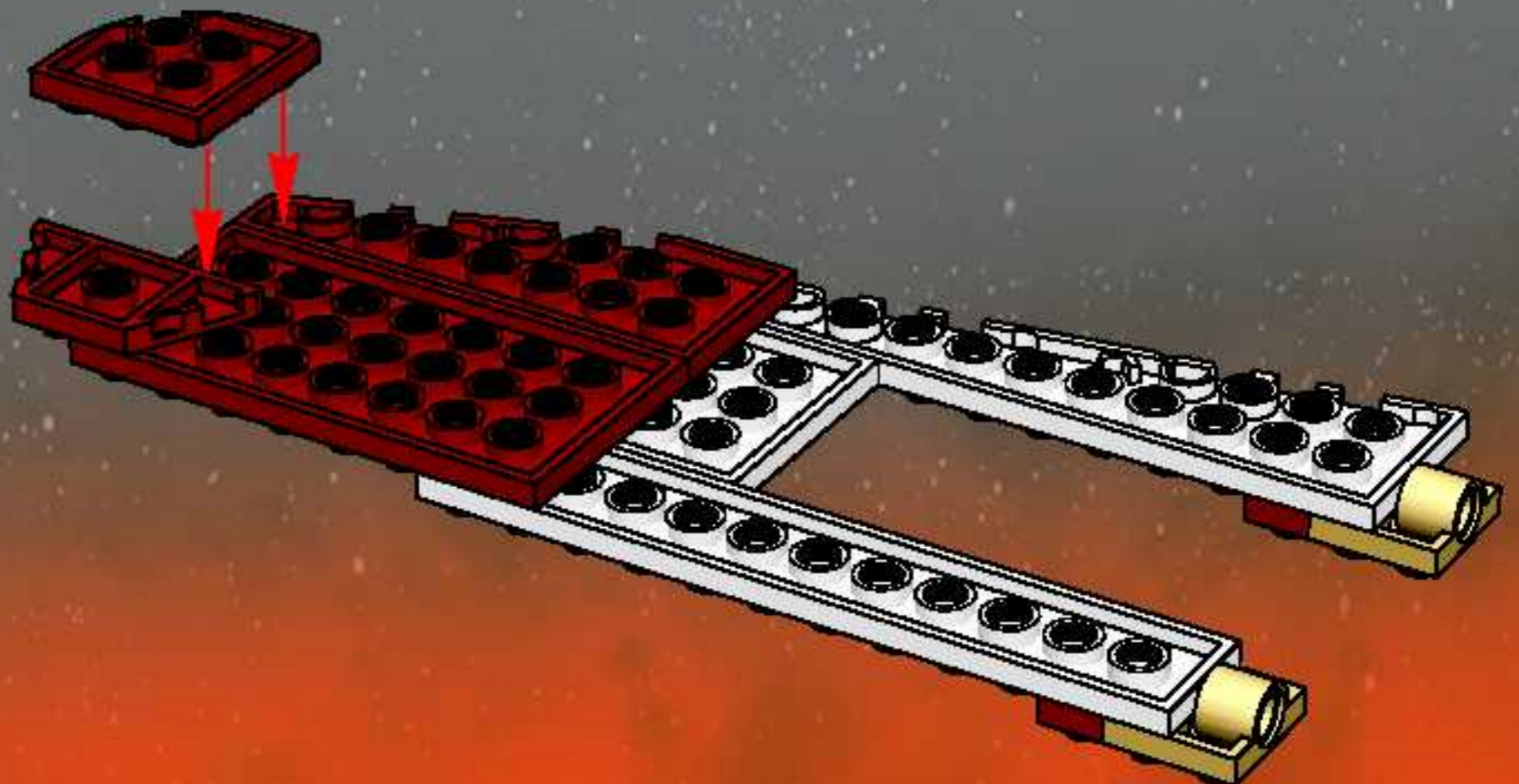

5

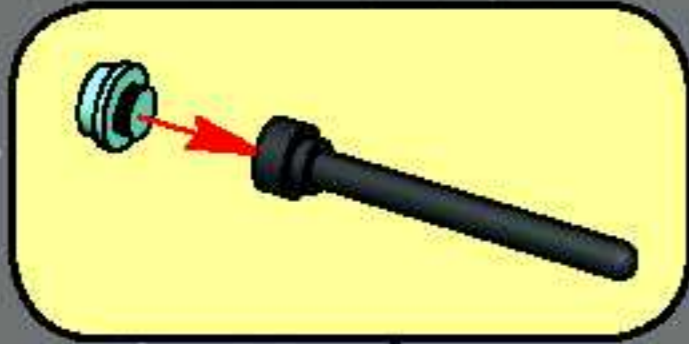
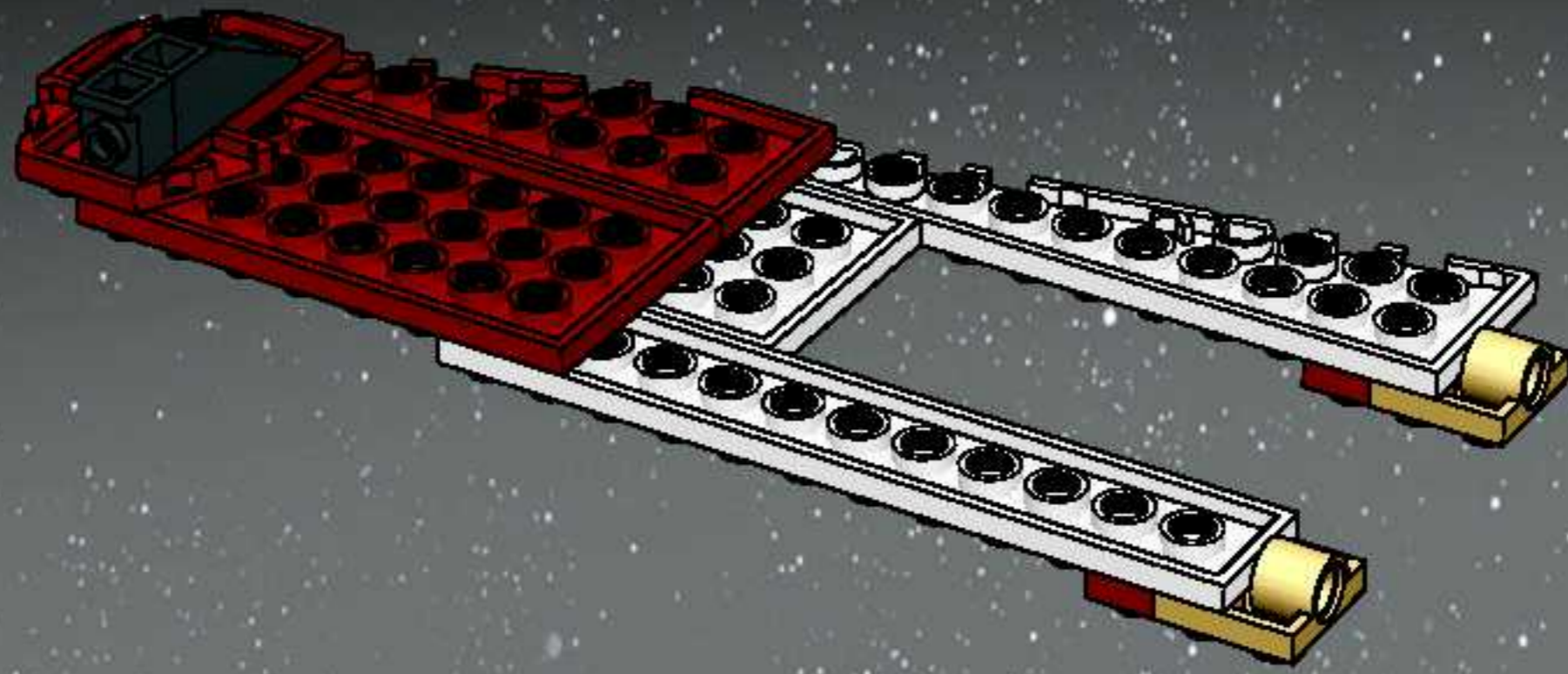

6

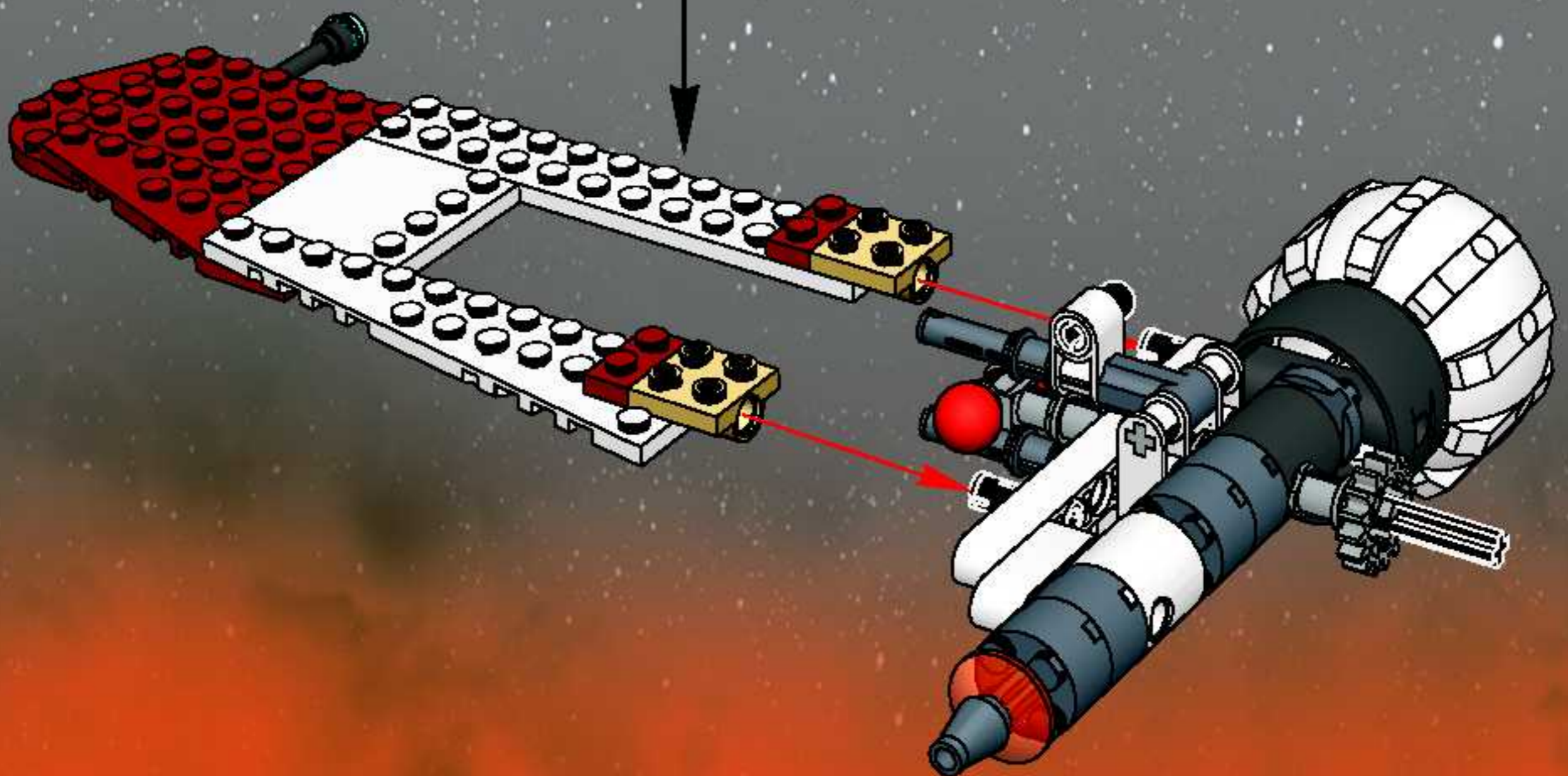
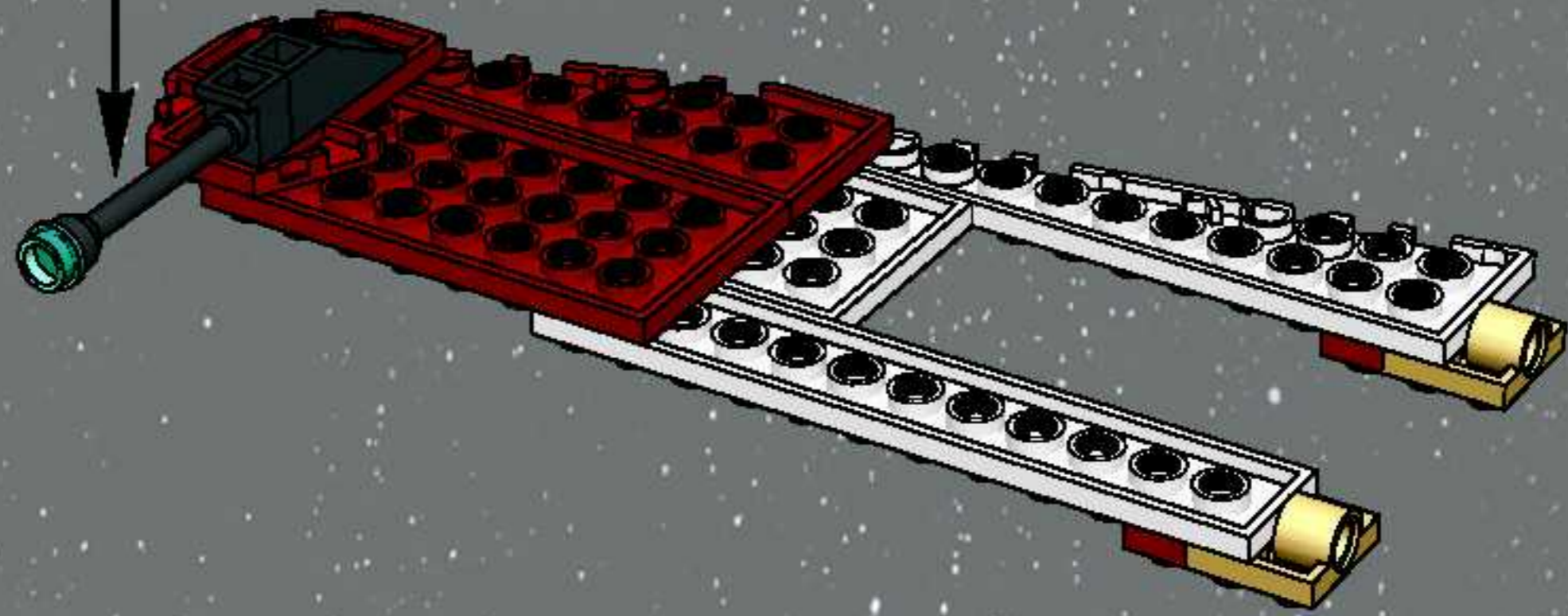

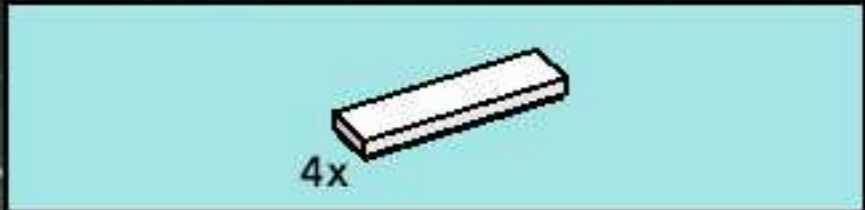

14

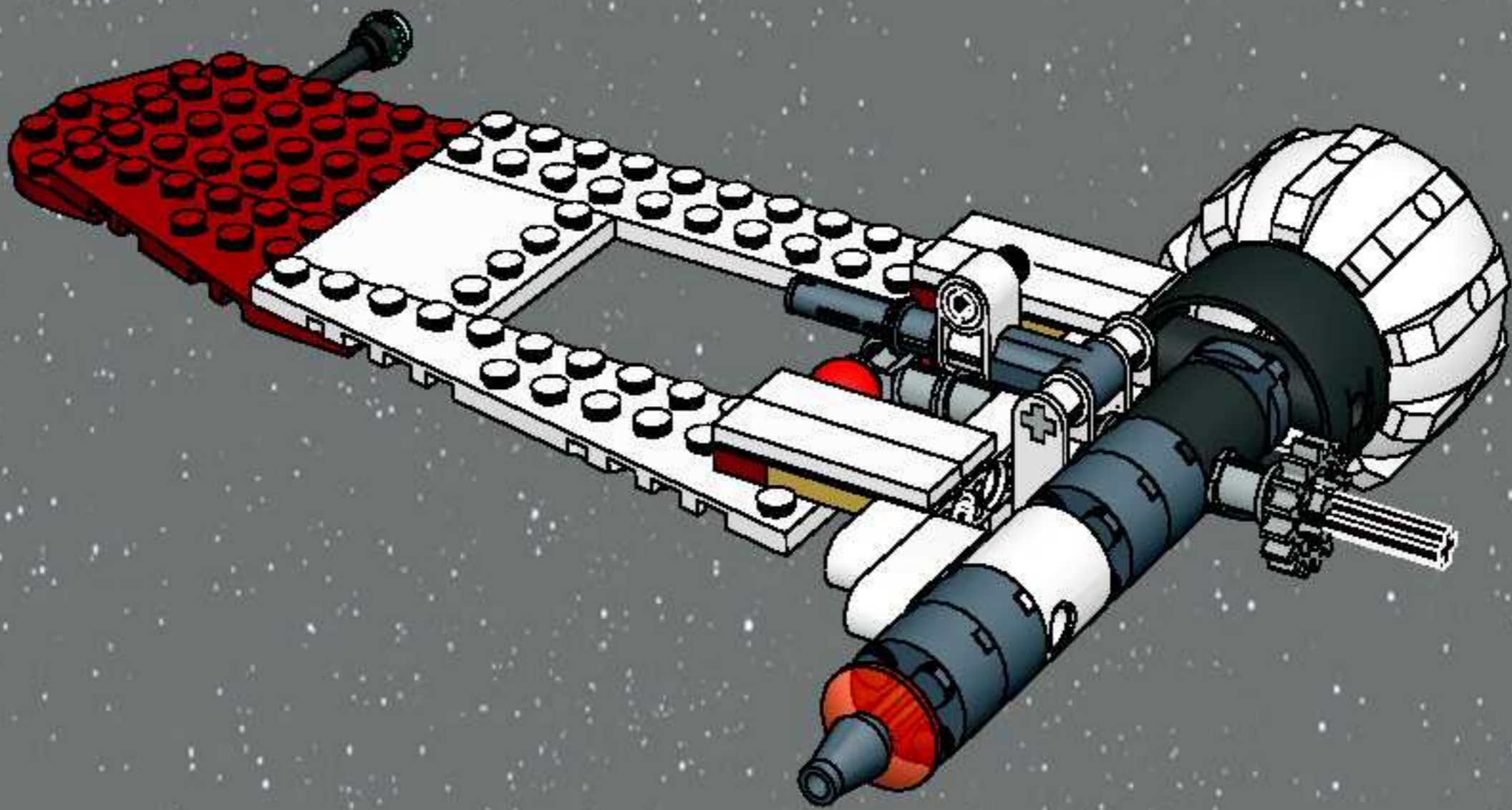

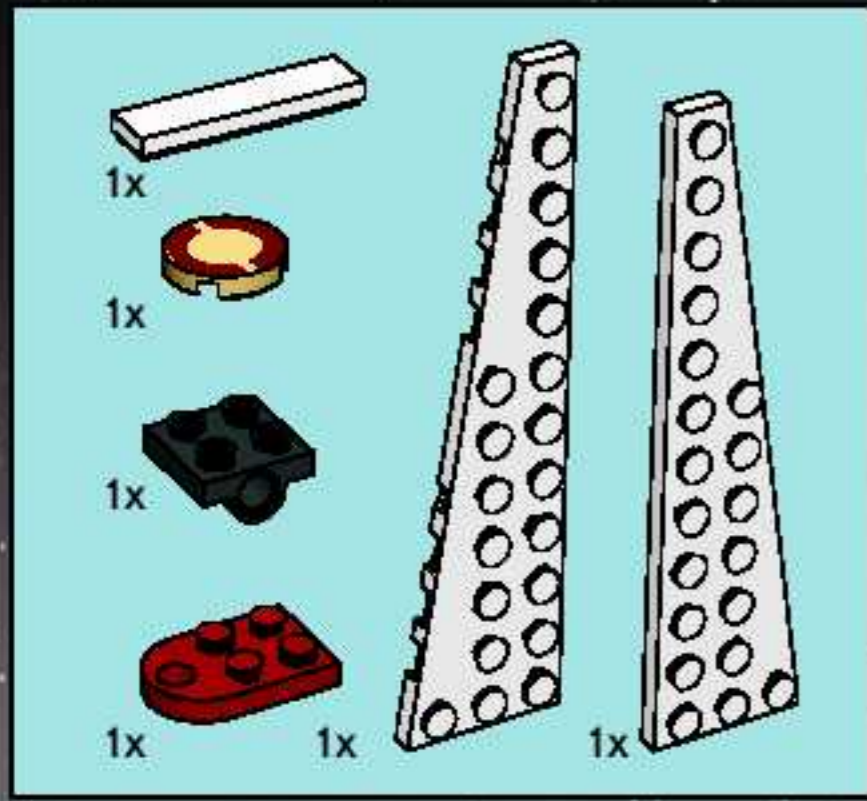

15

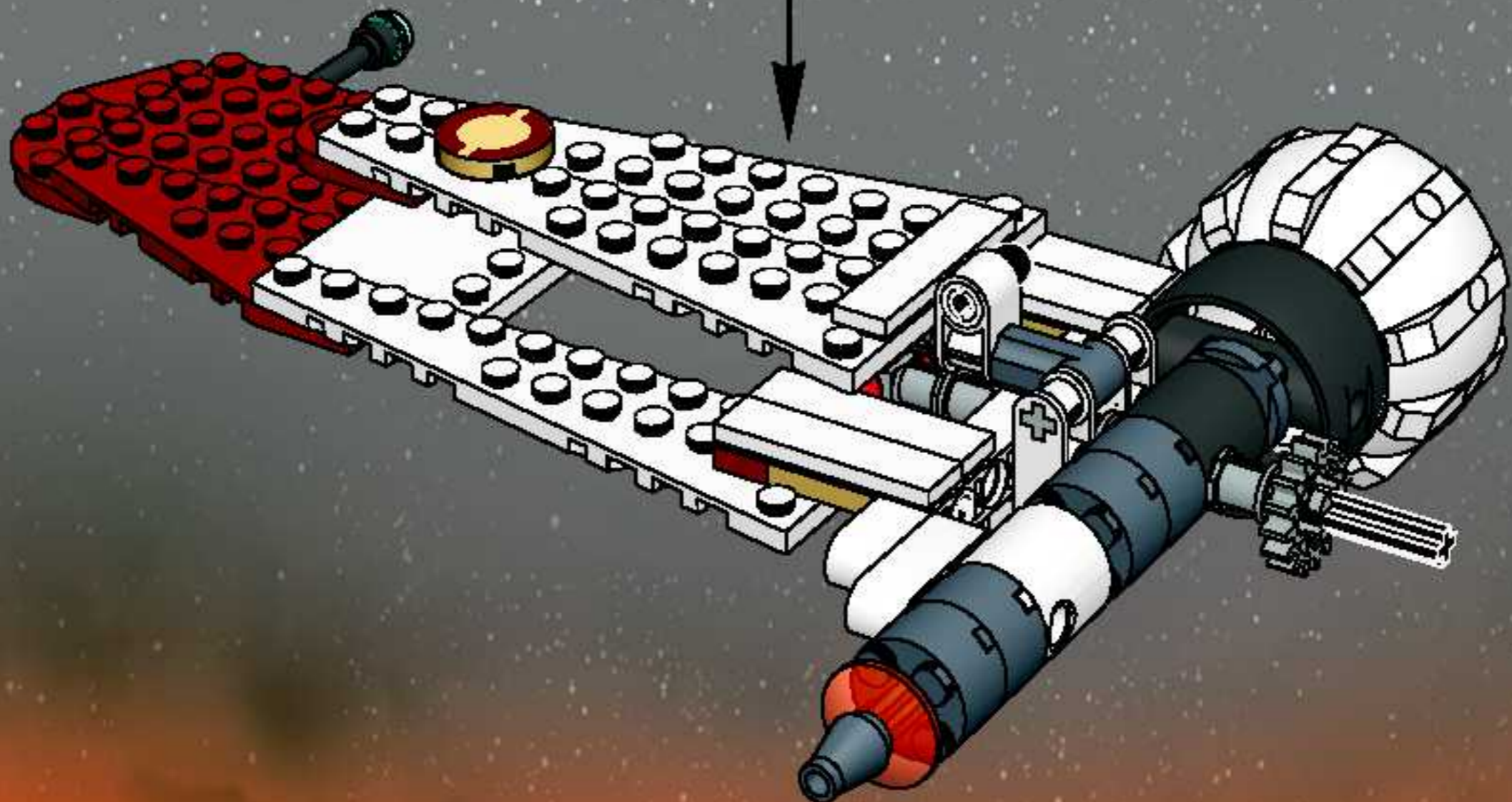
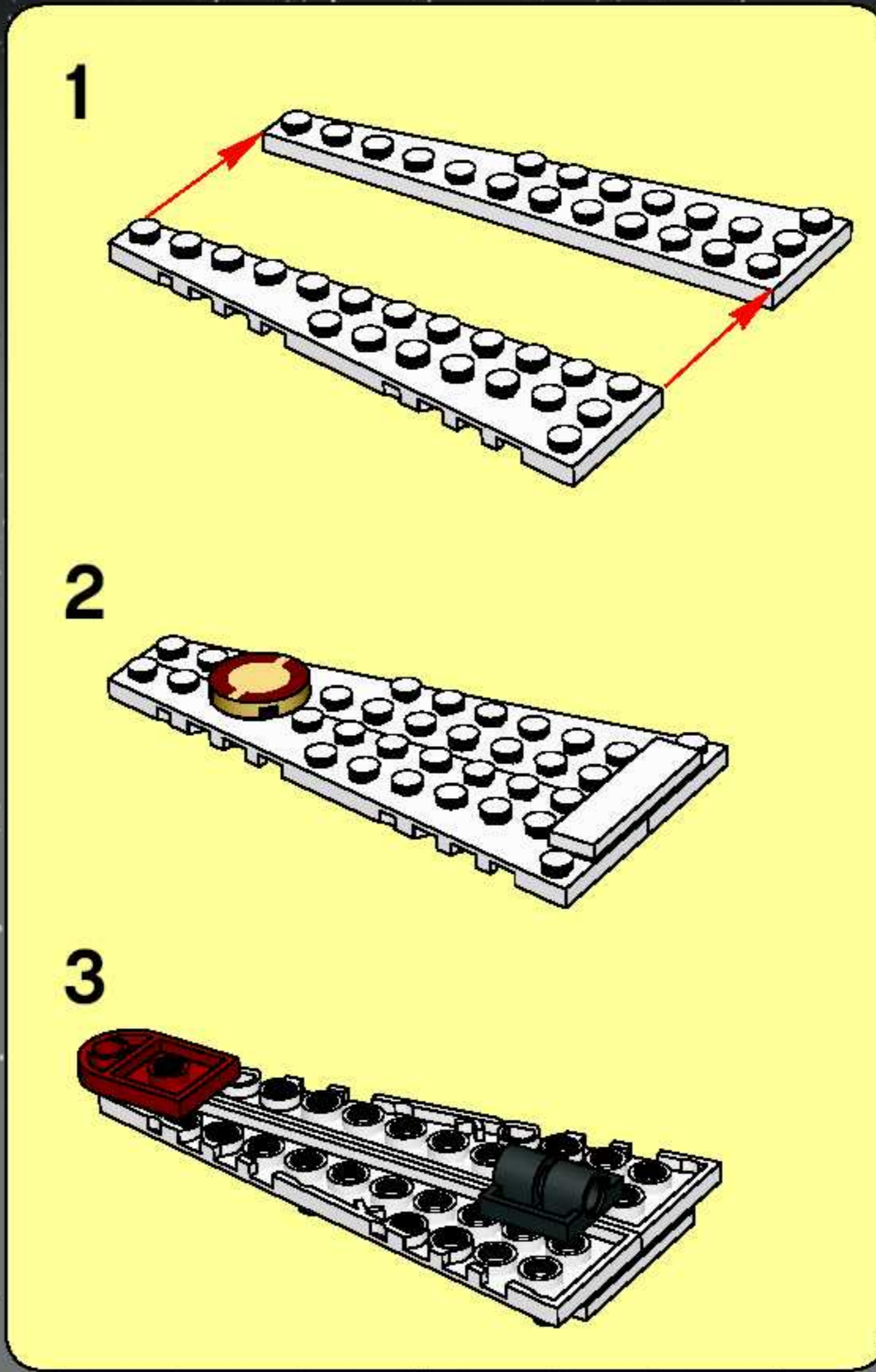

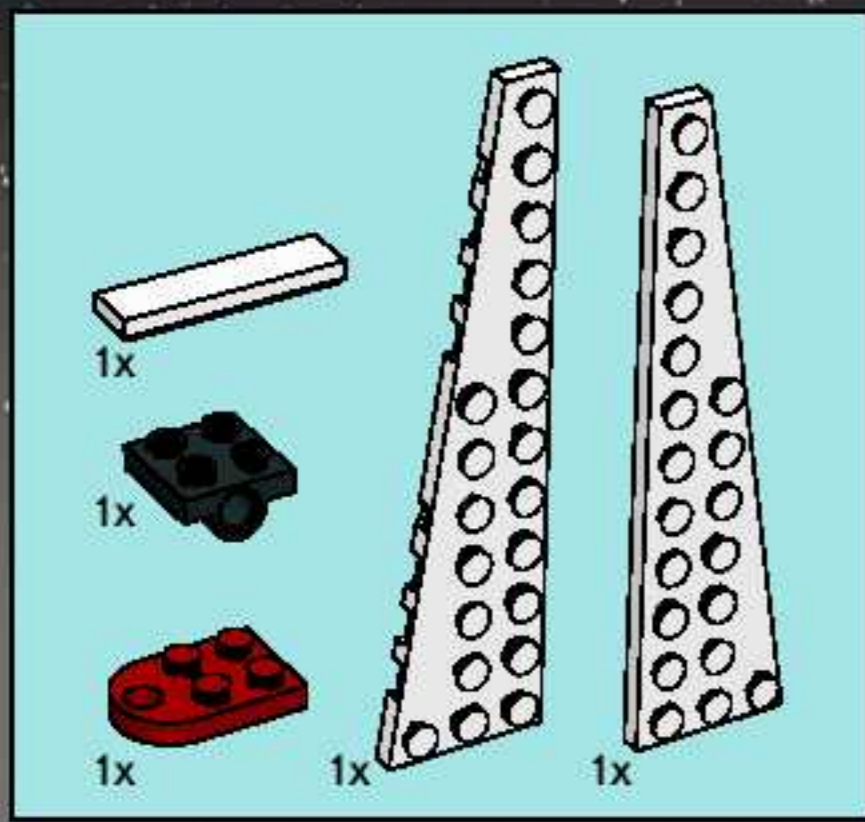

16

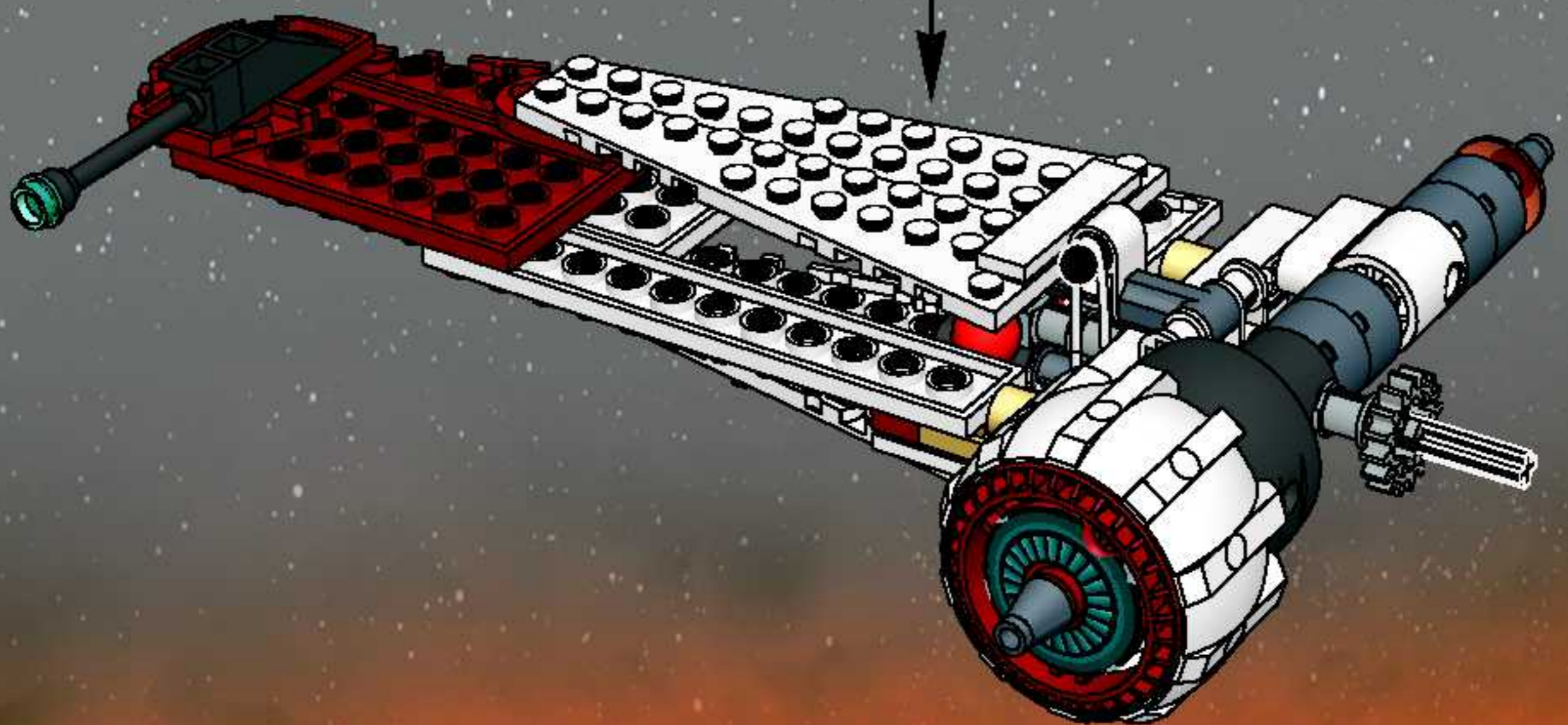
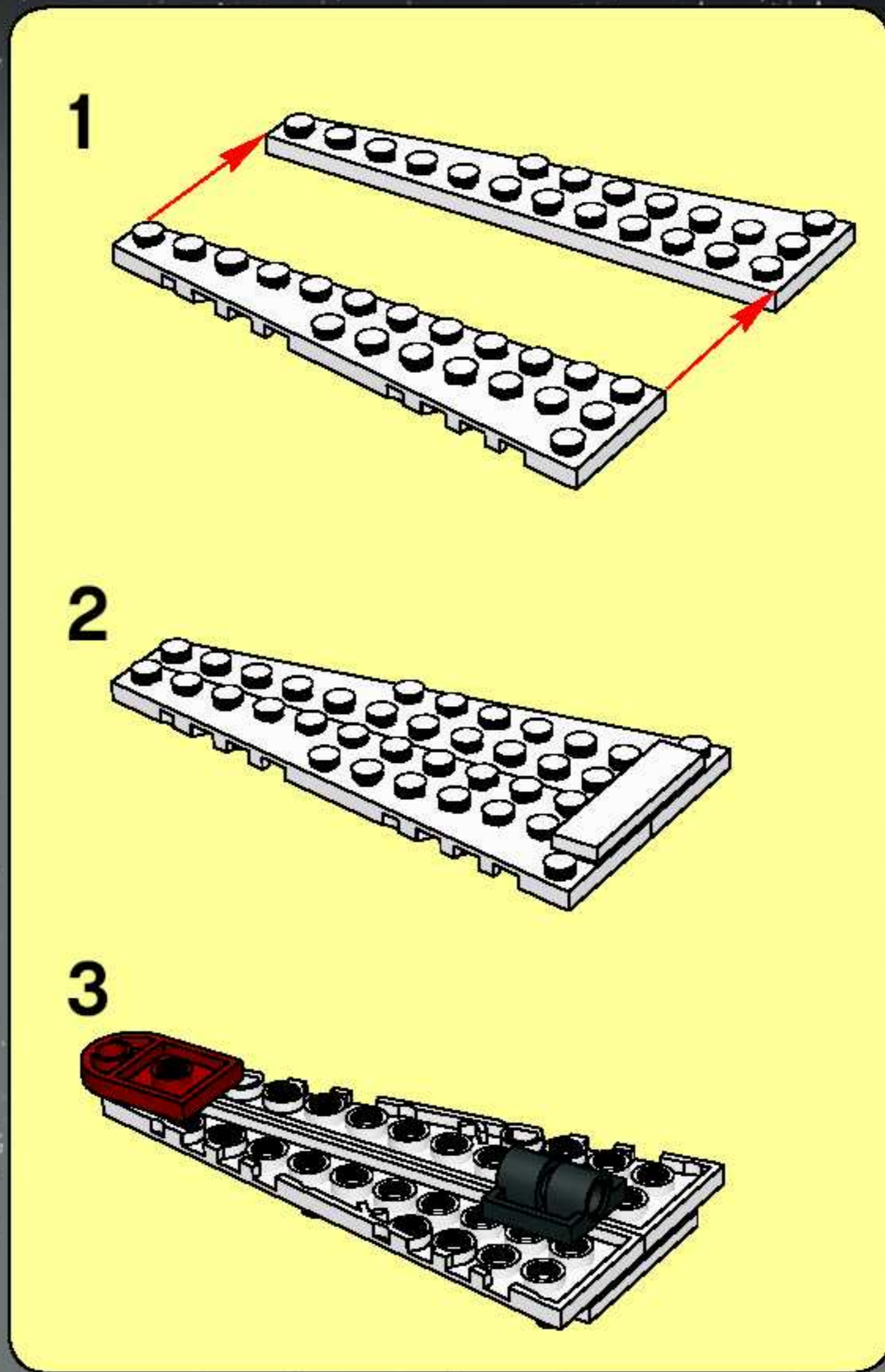

35

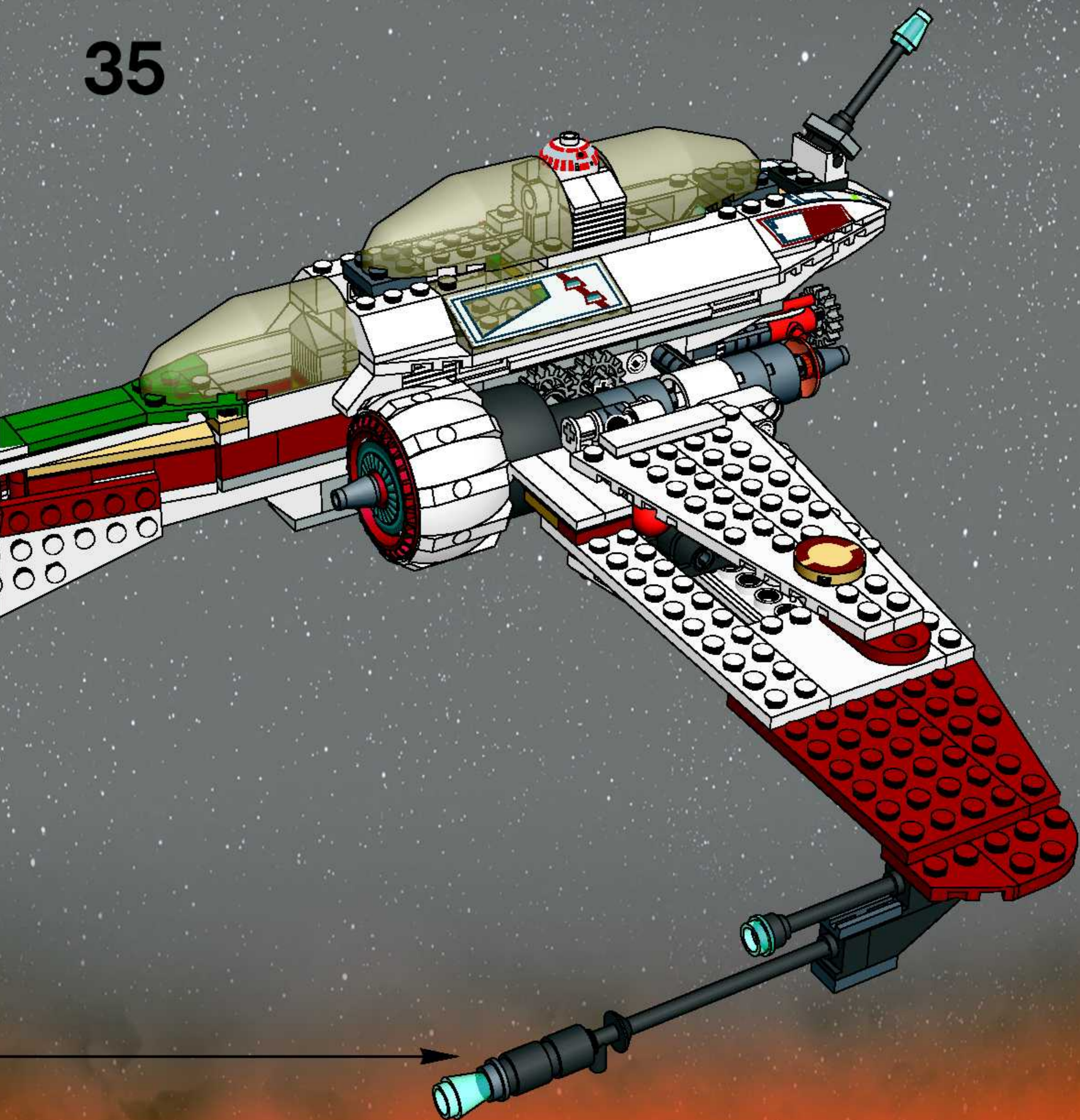

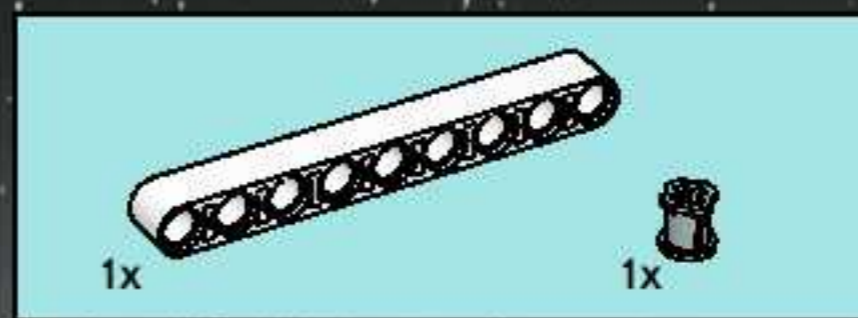
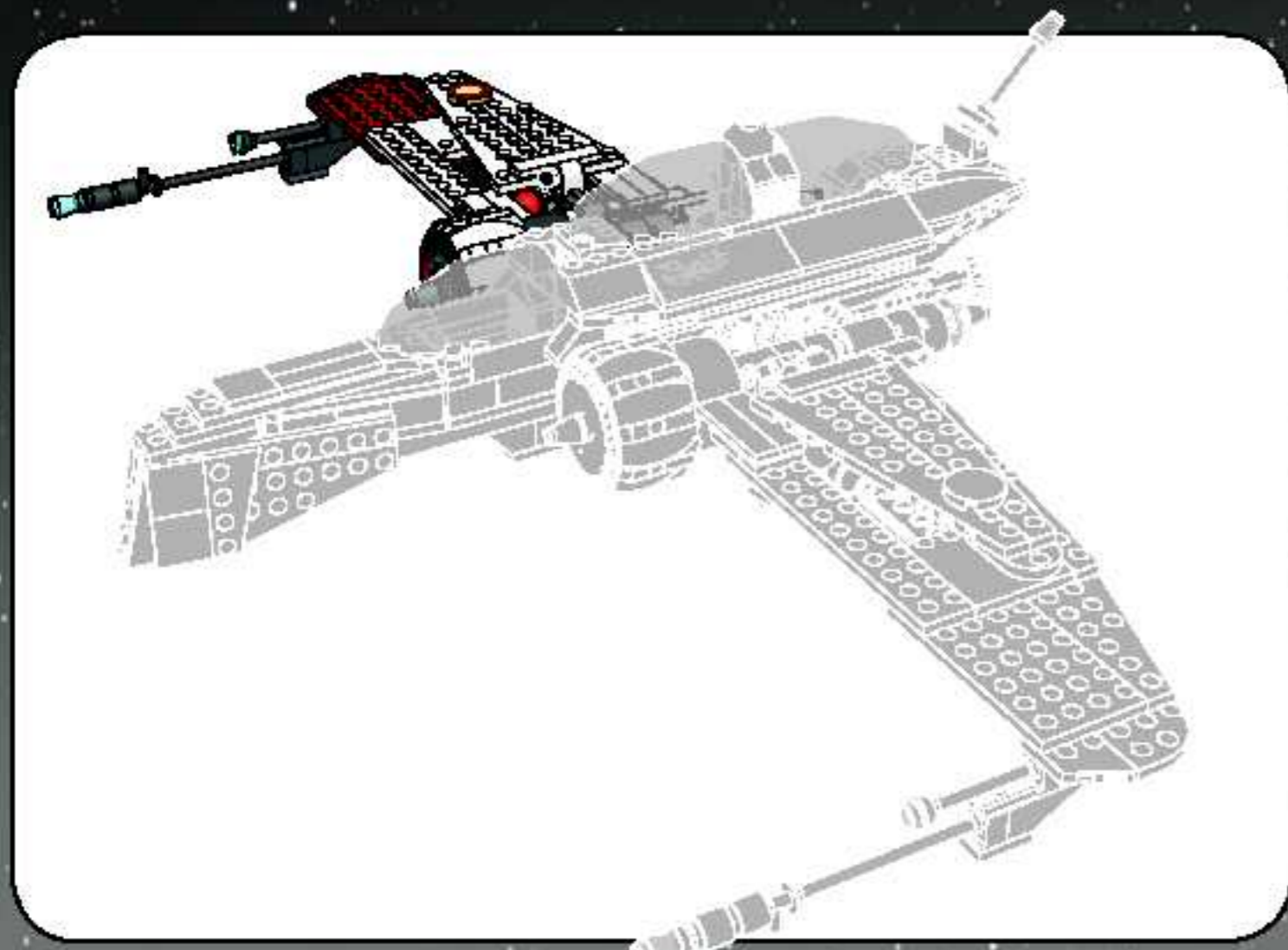

4

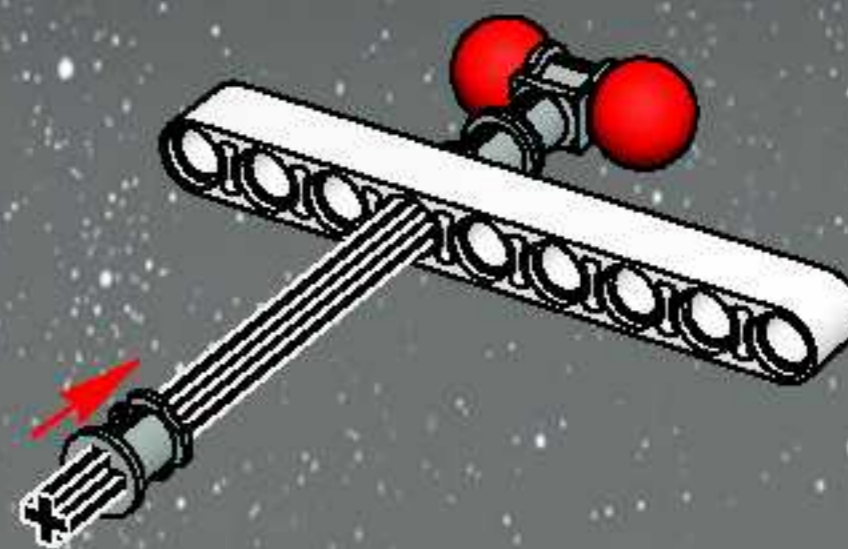

1

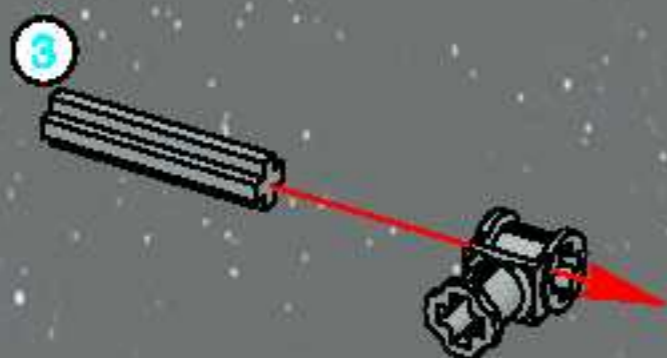

5

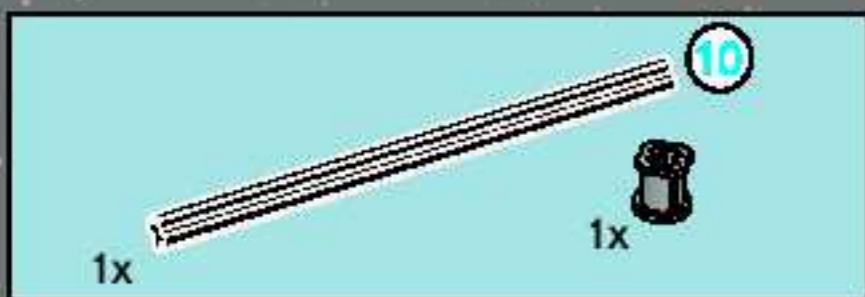
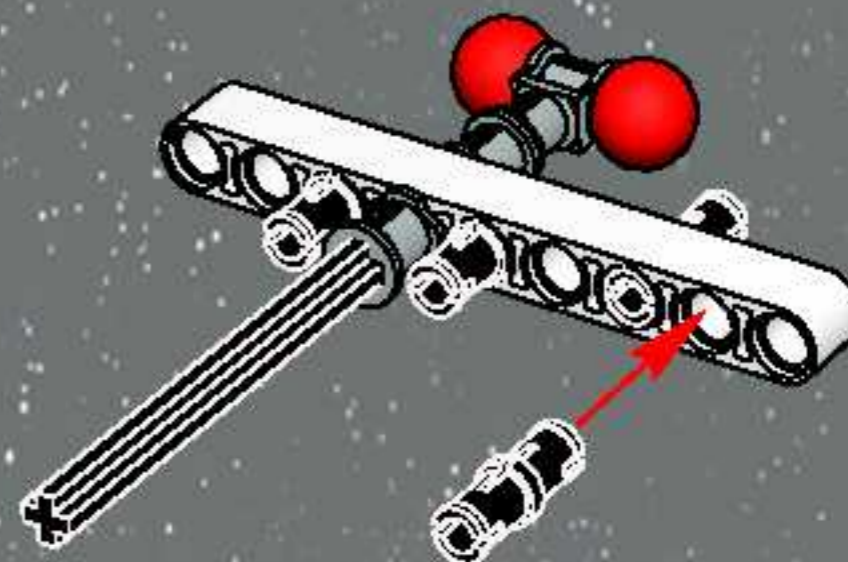

2

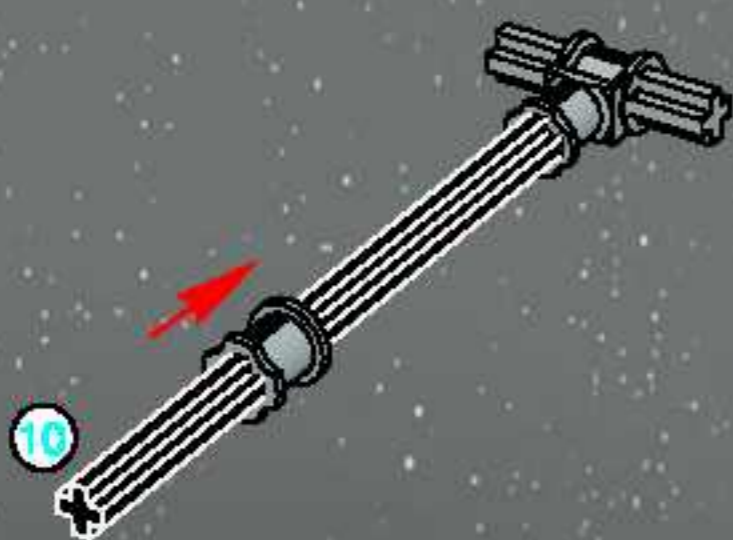

6

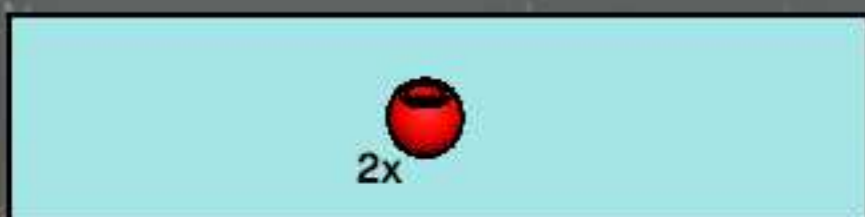
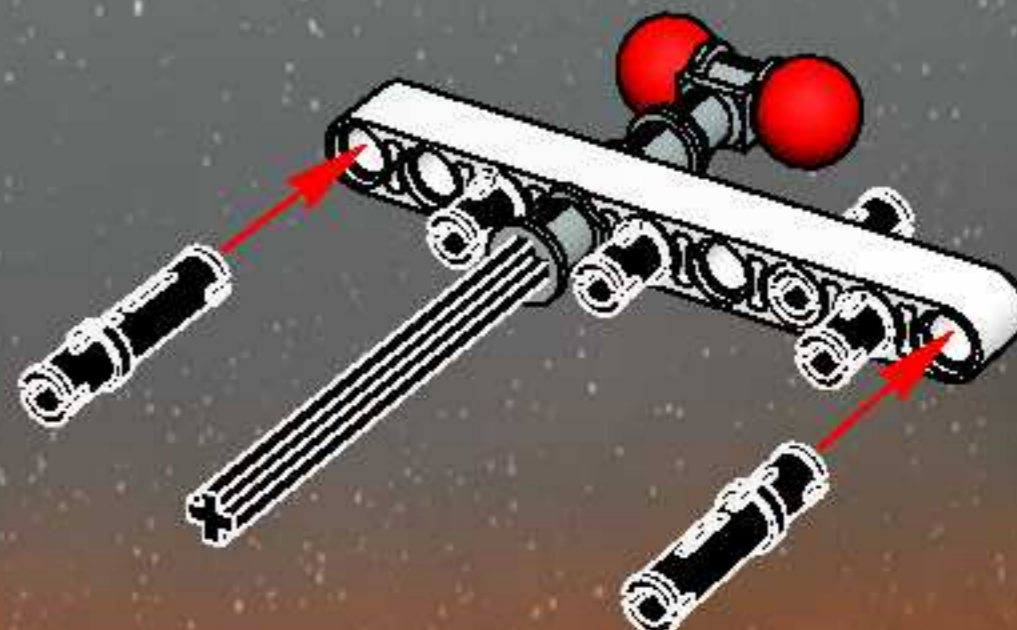

3

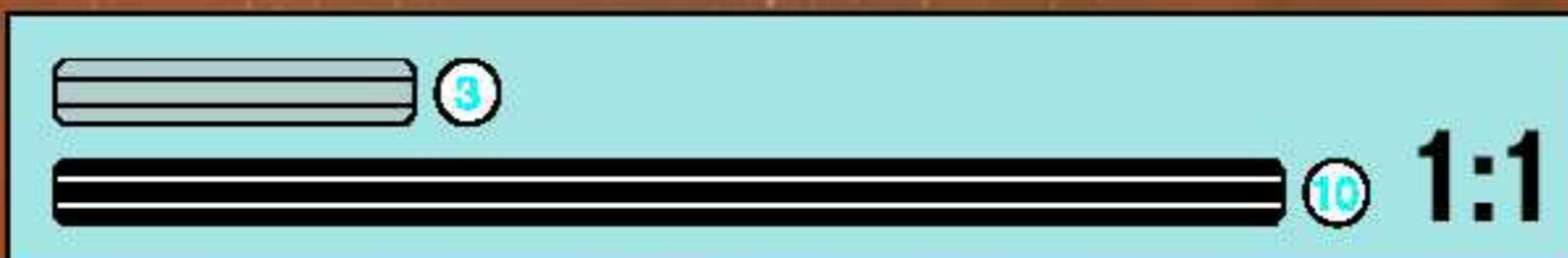
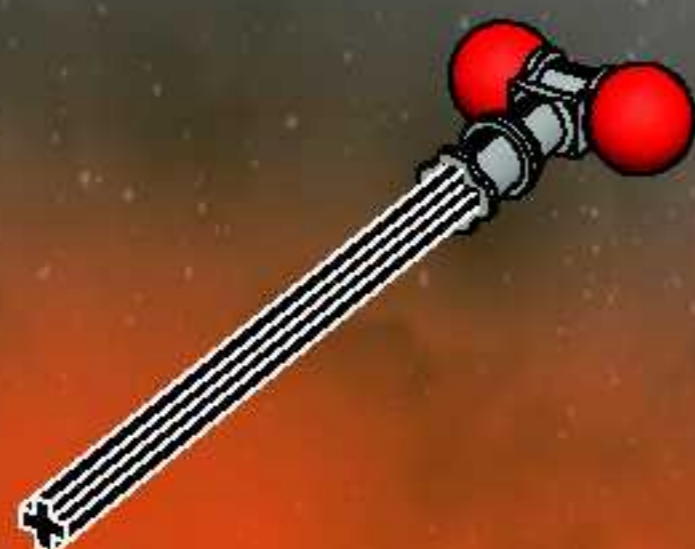

1:1

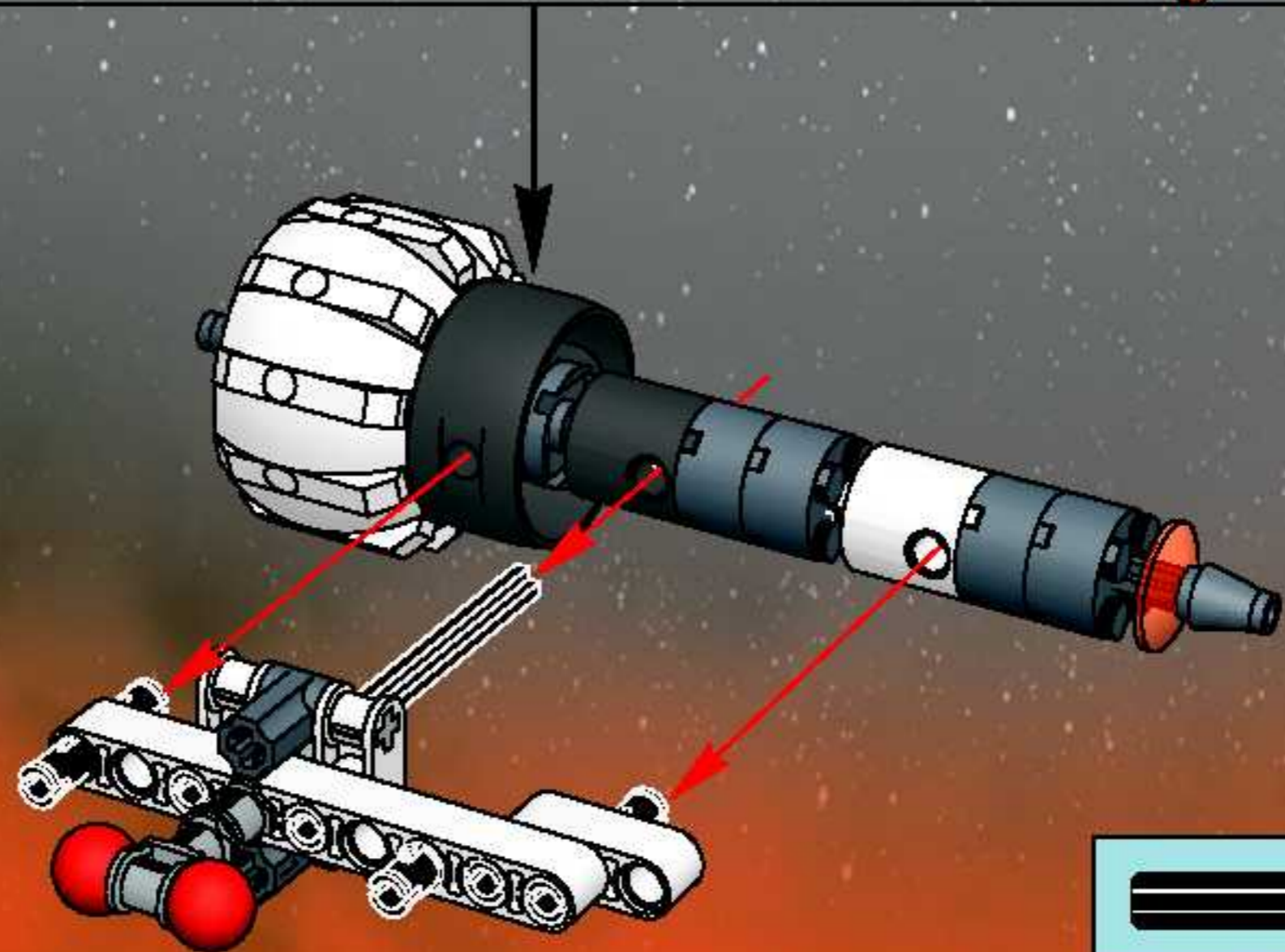
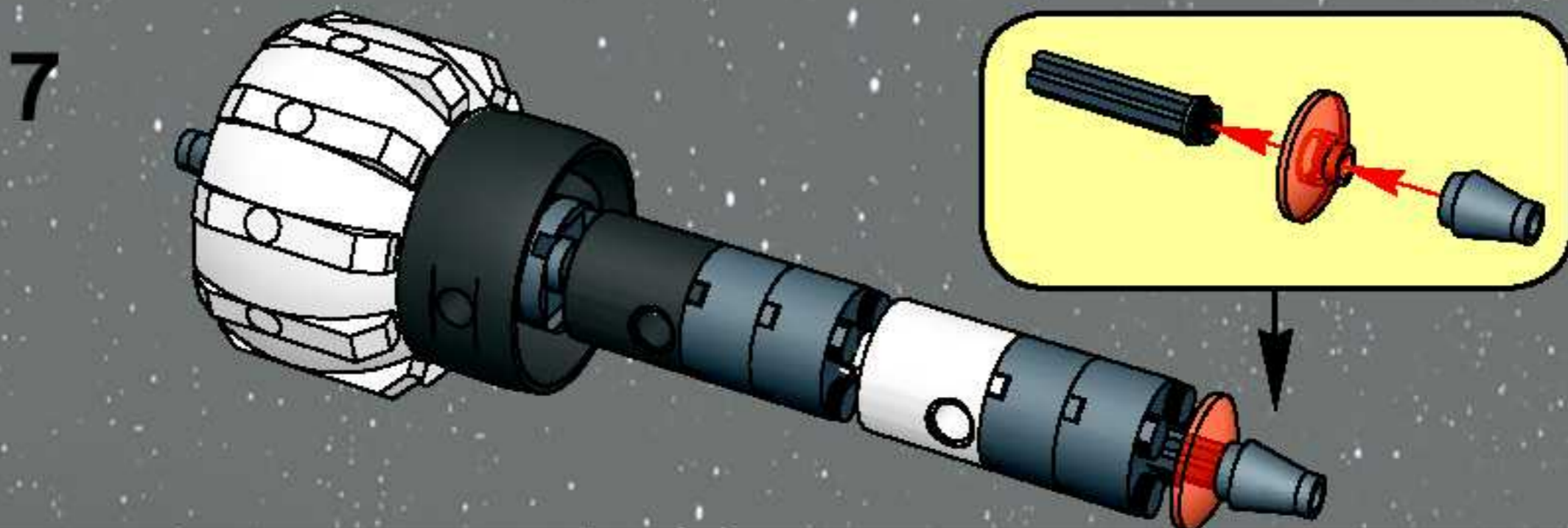
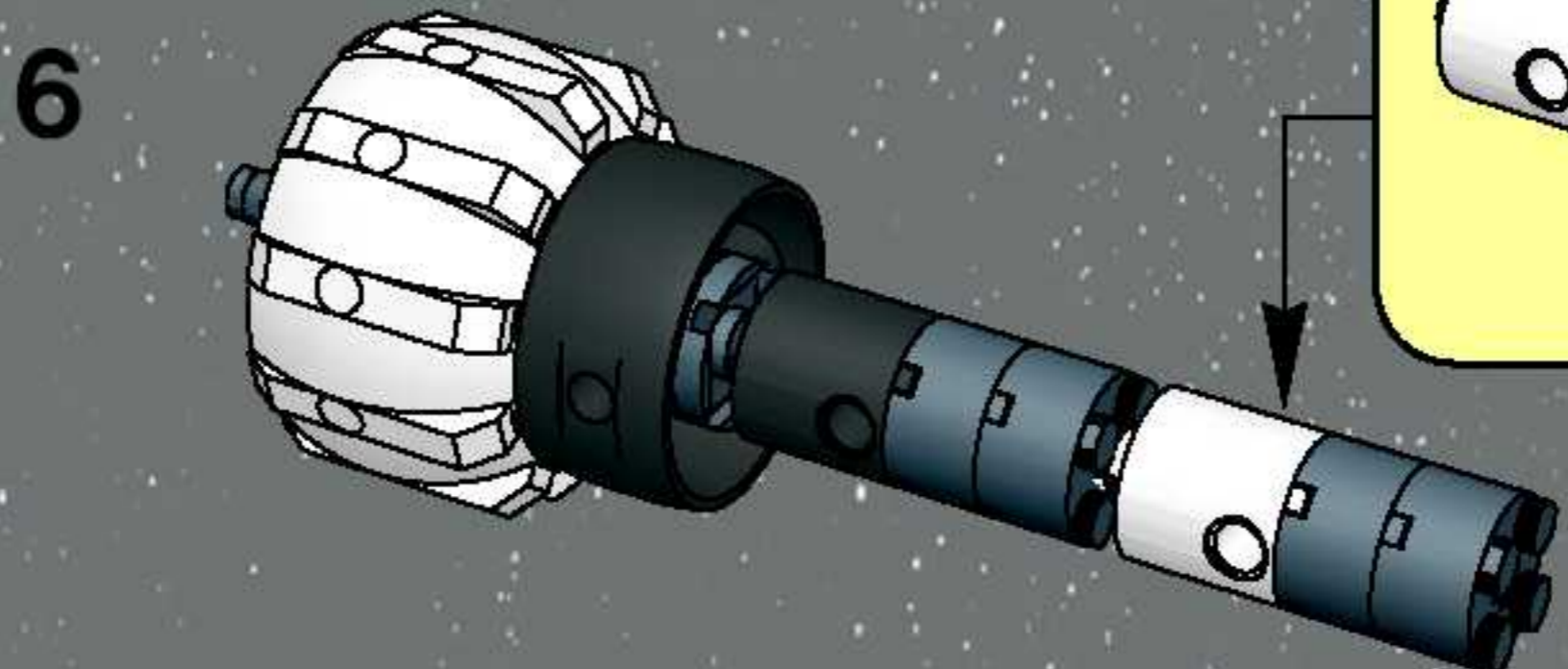
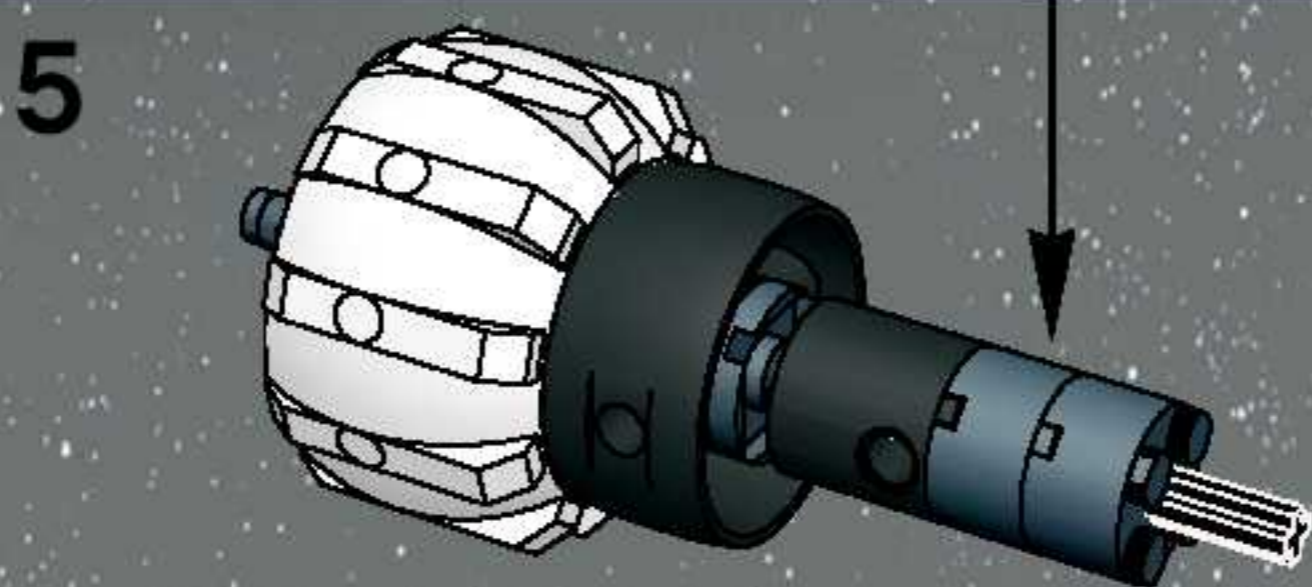
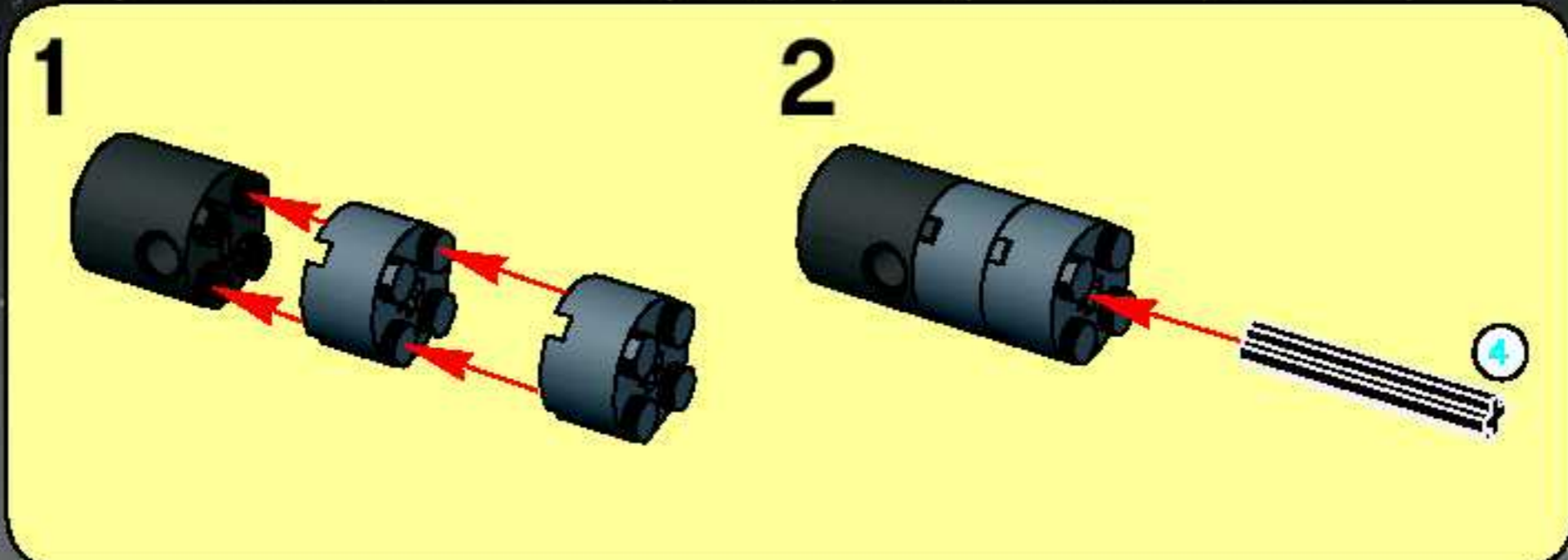



1x



1x

10

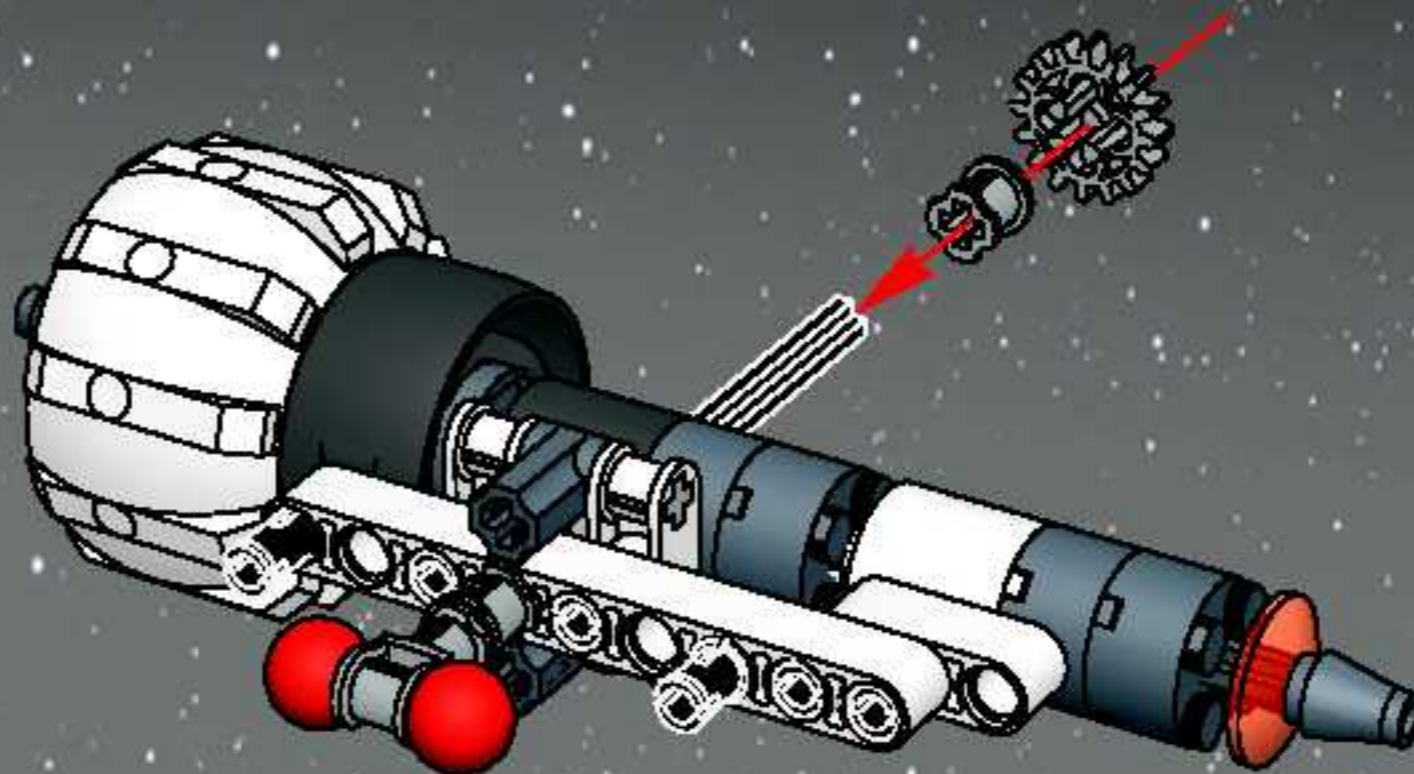

2x

2x

2x

11

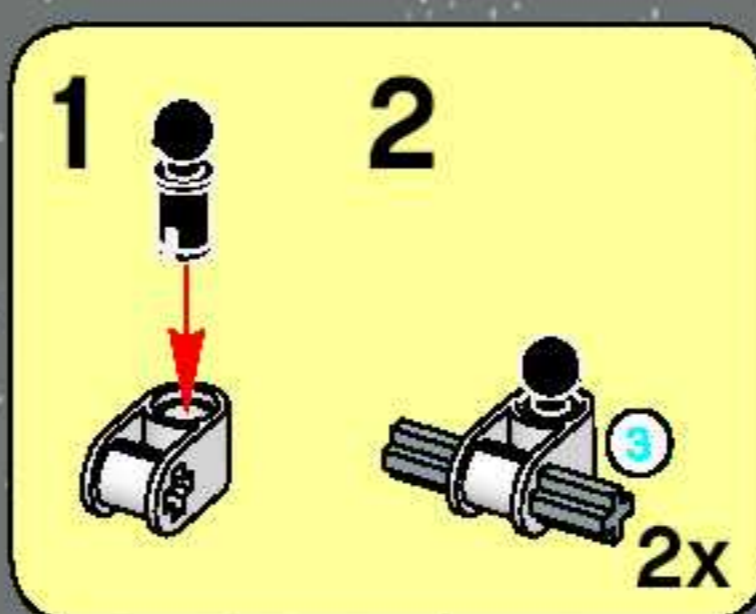

1

2

2x

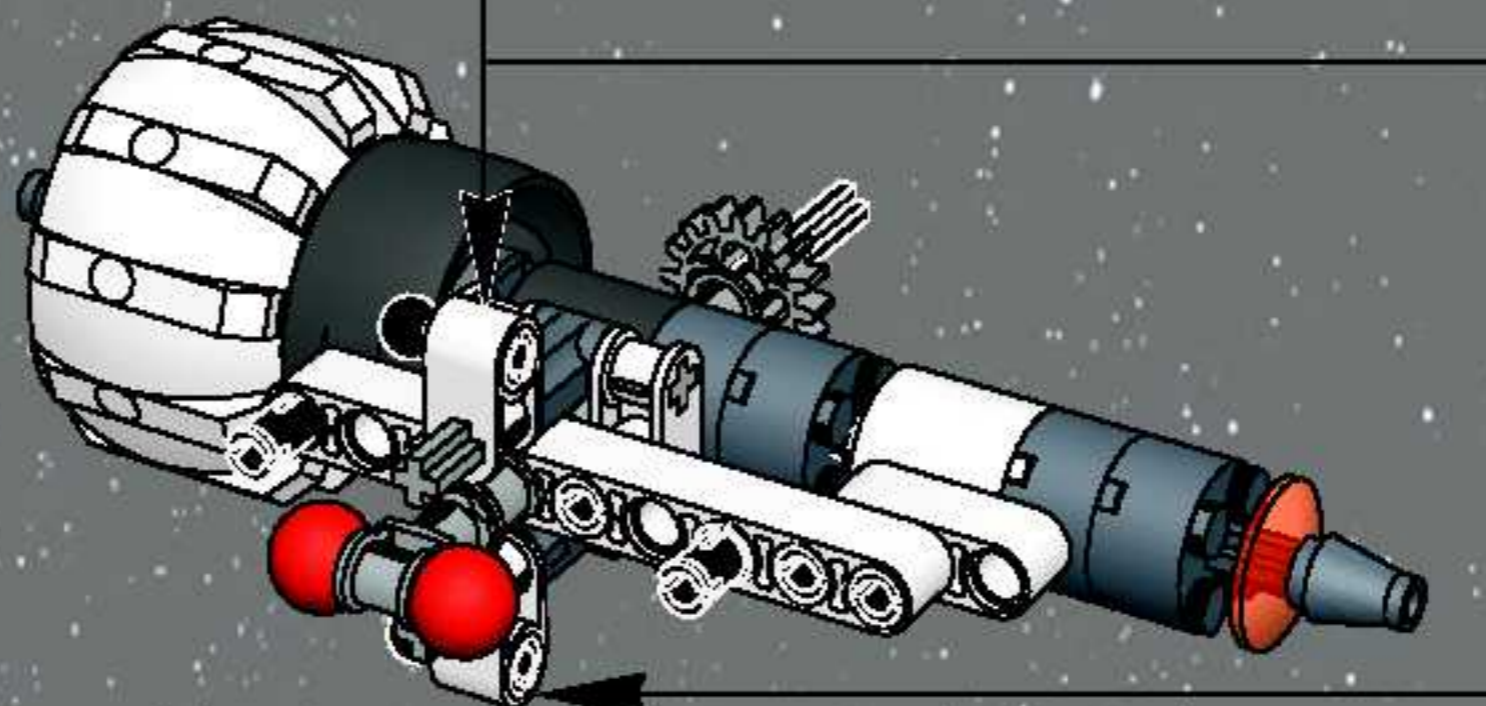

2x

1x

12

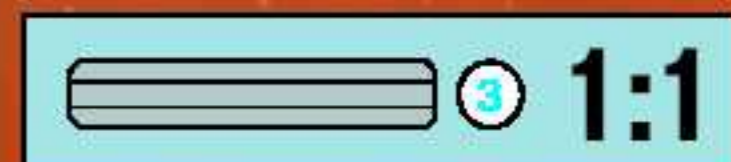
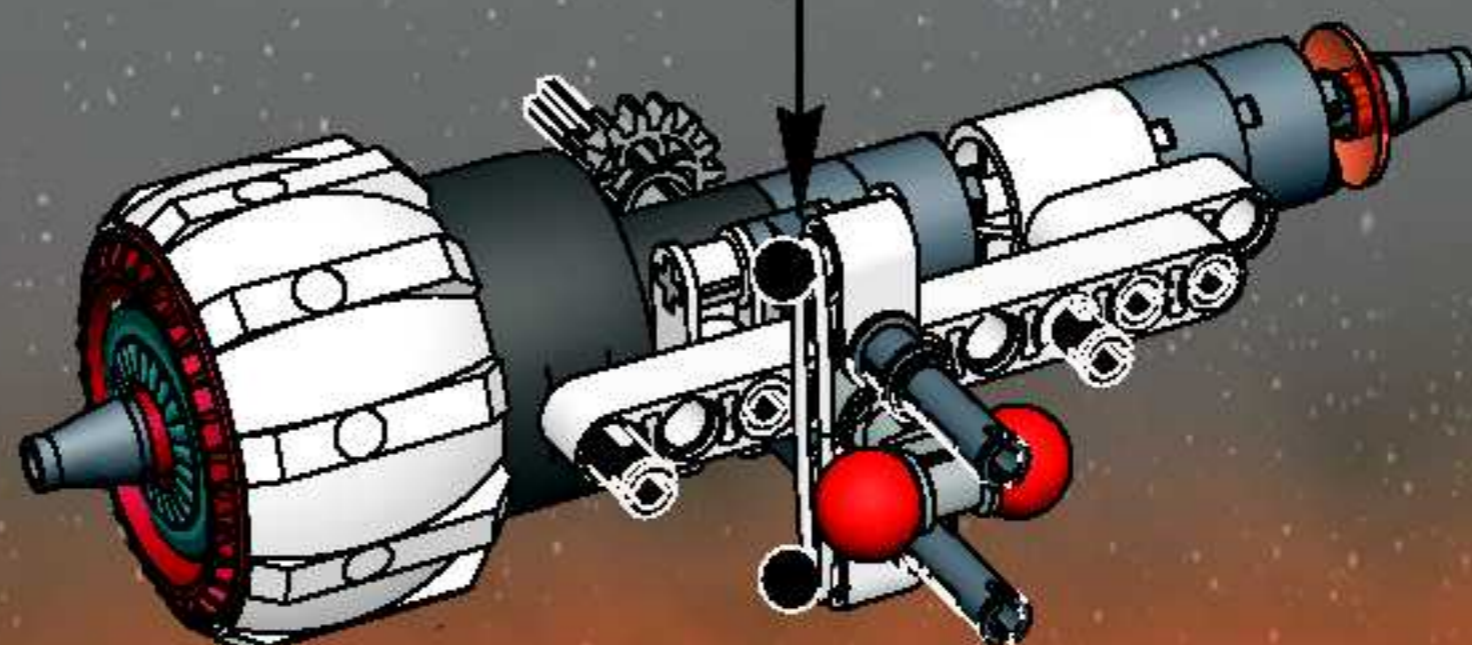
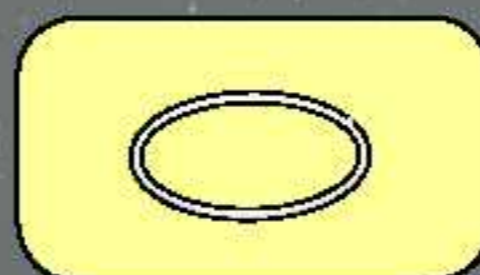

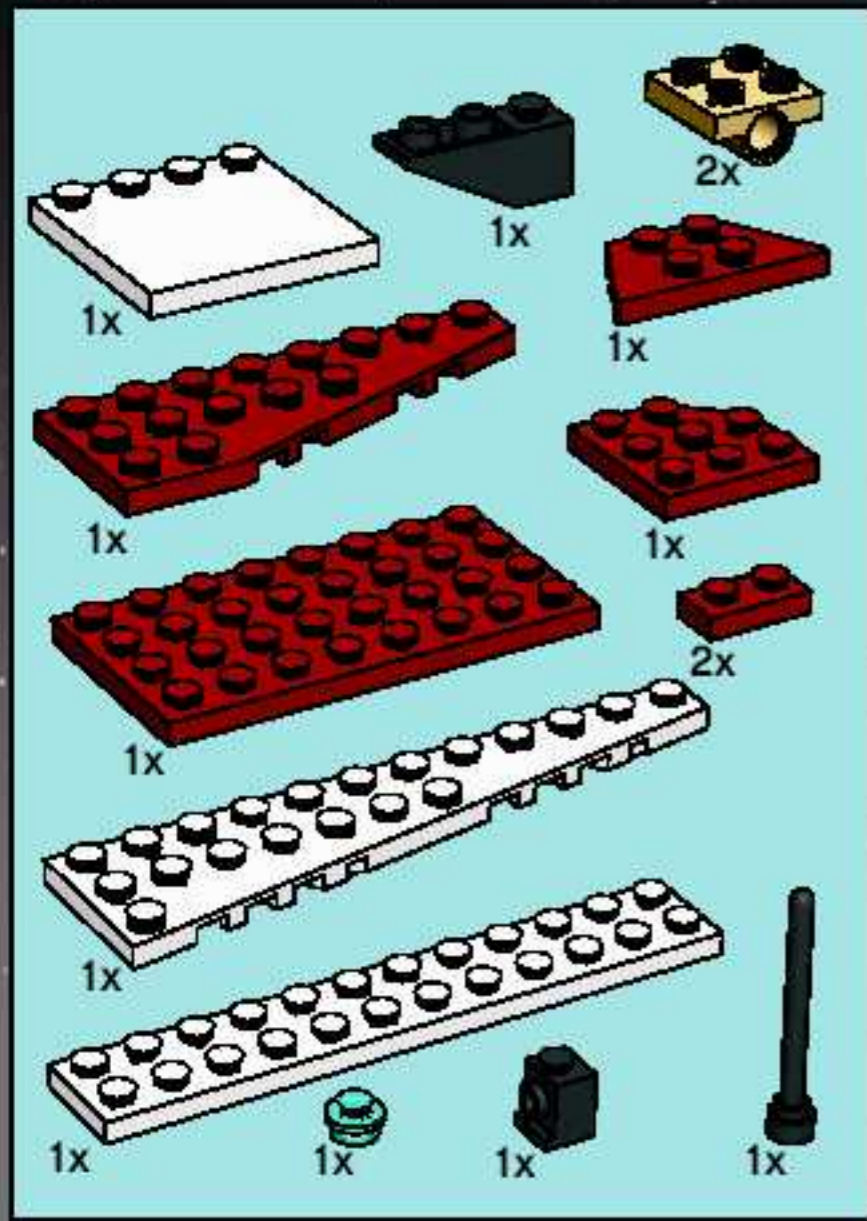

13

1

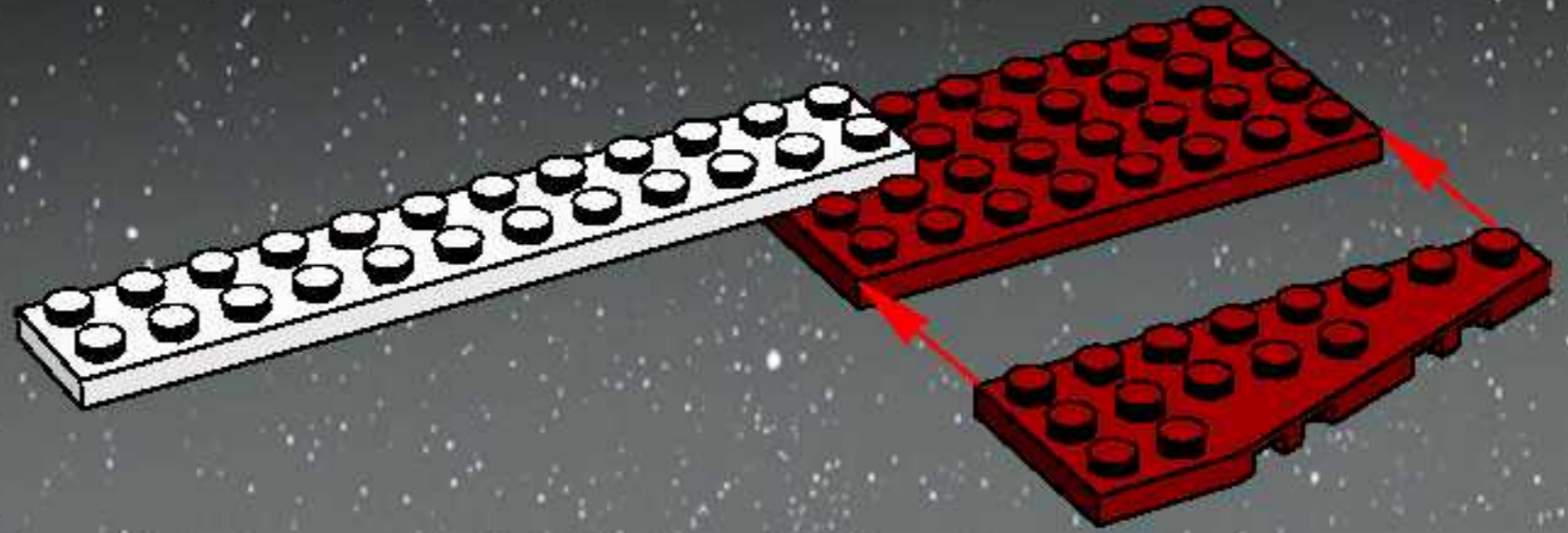

2

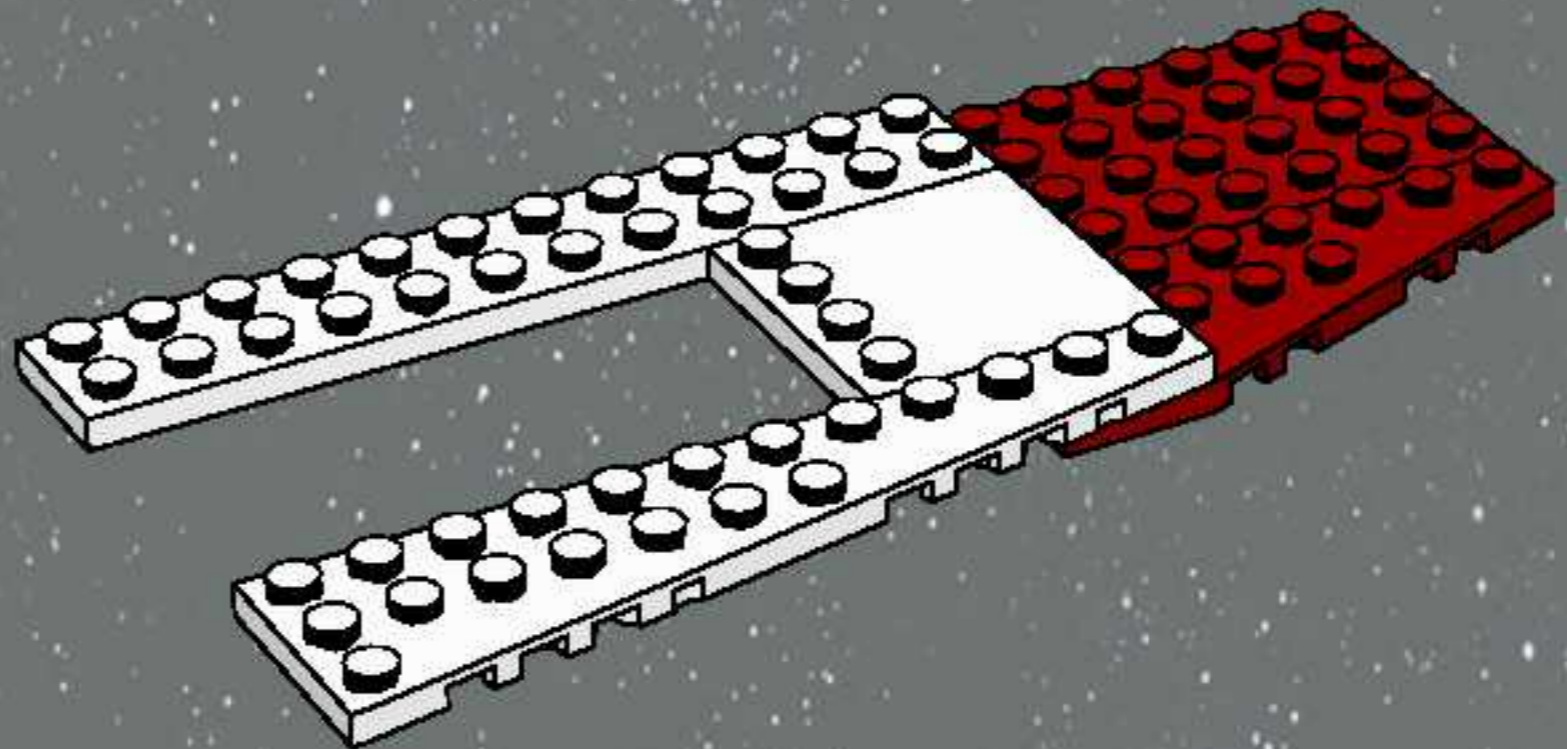

3

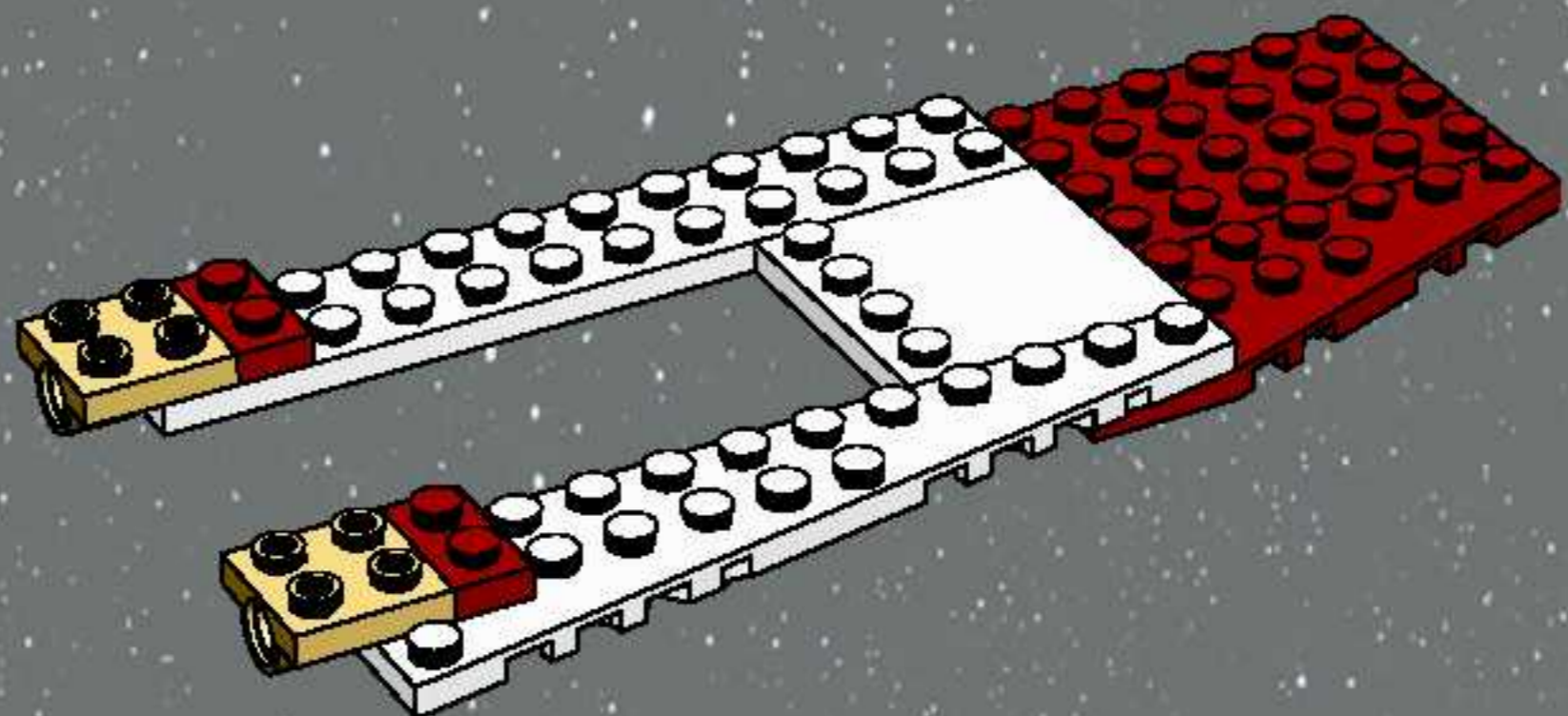

4

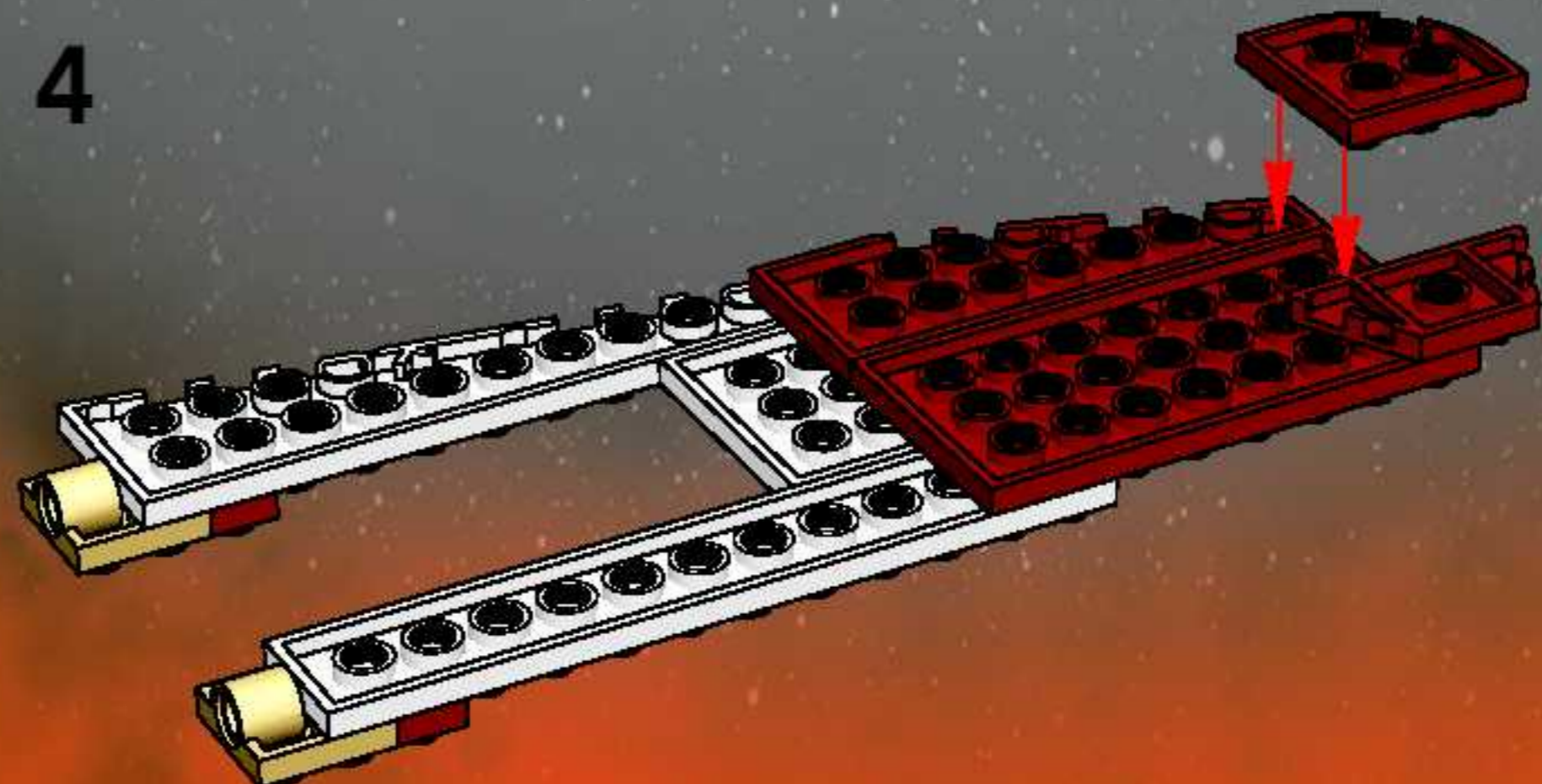

5

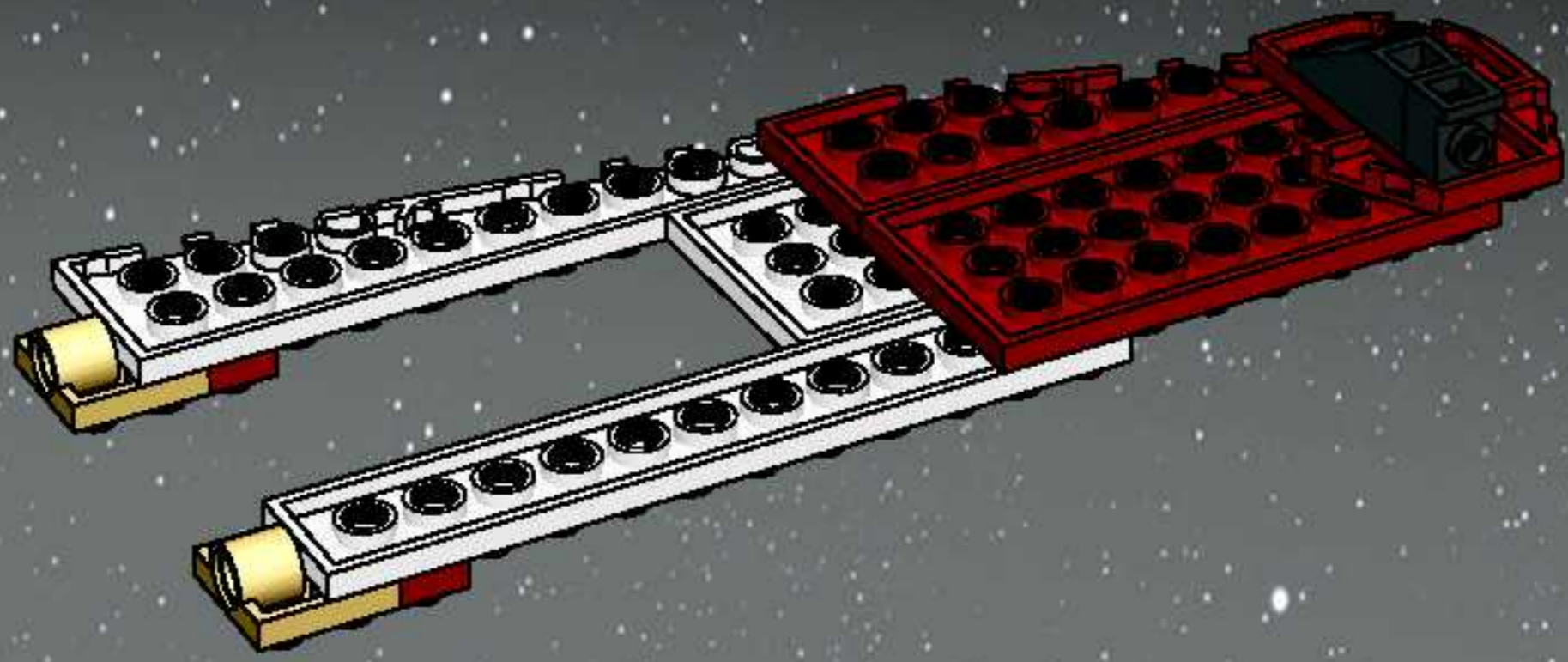

6

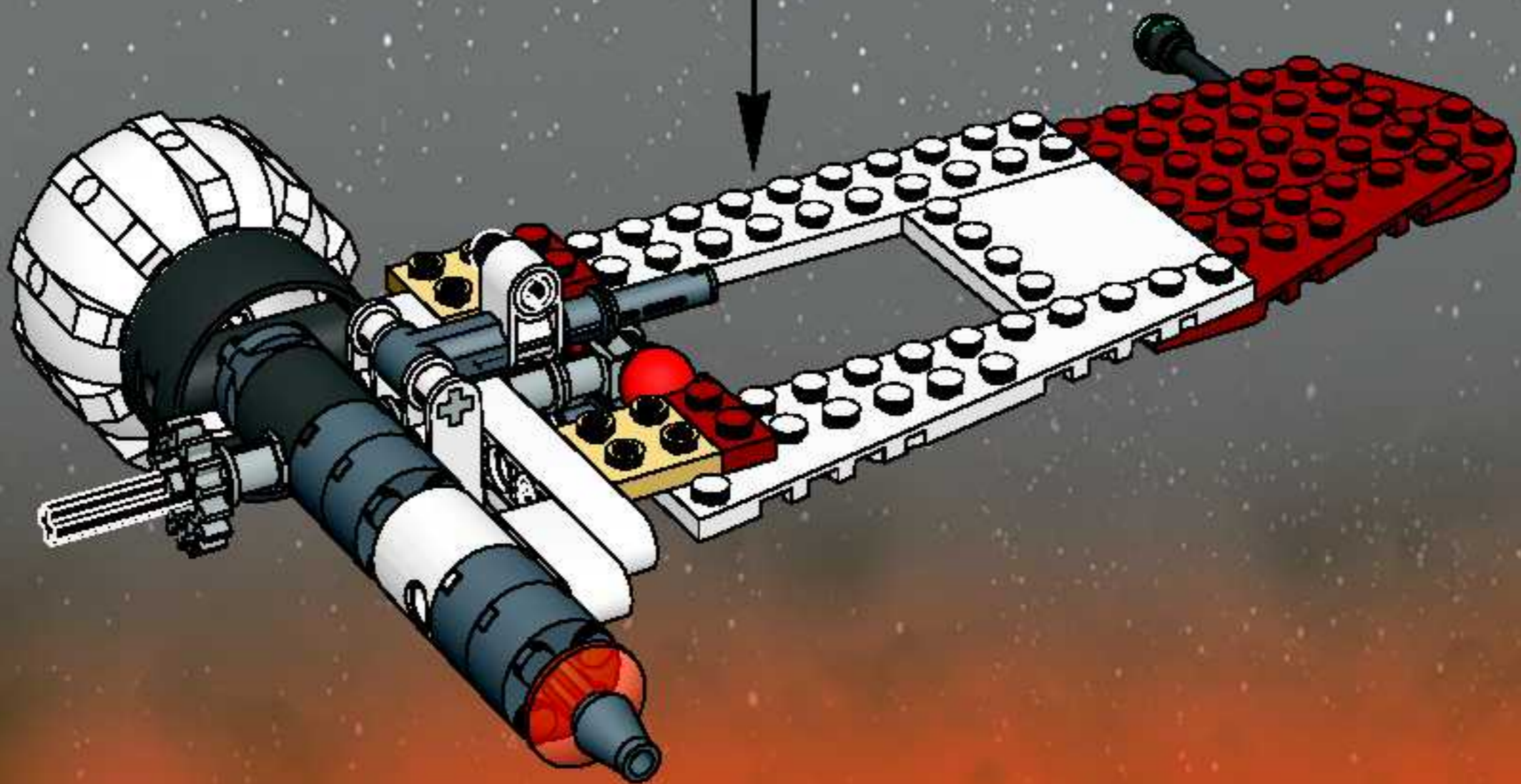
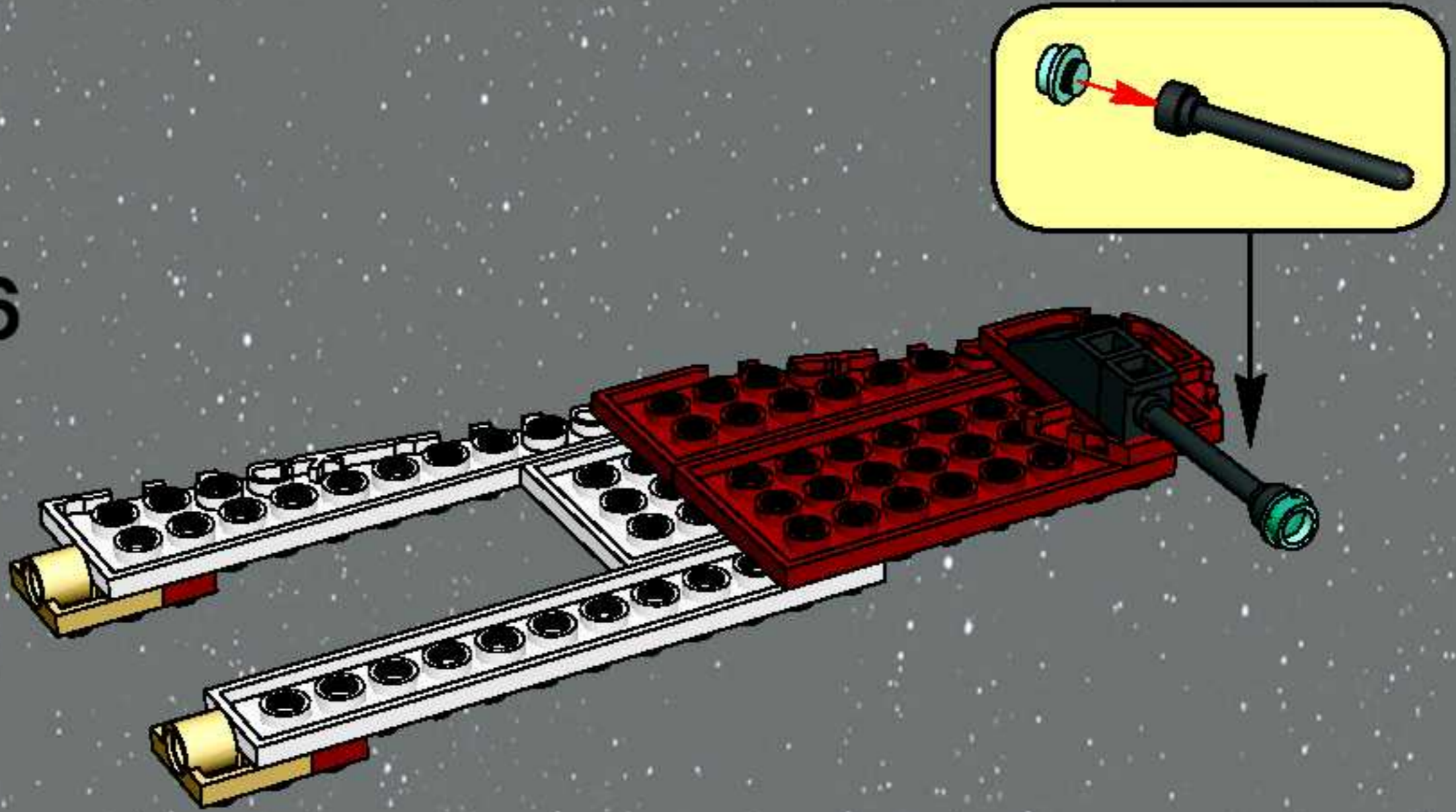

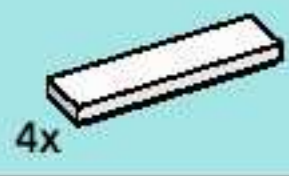

4x

14

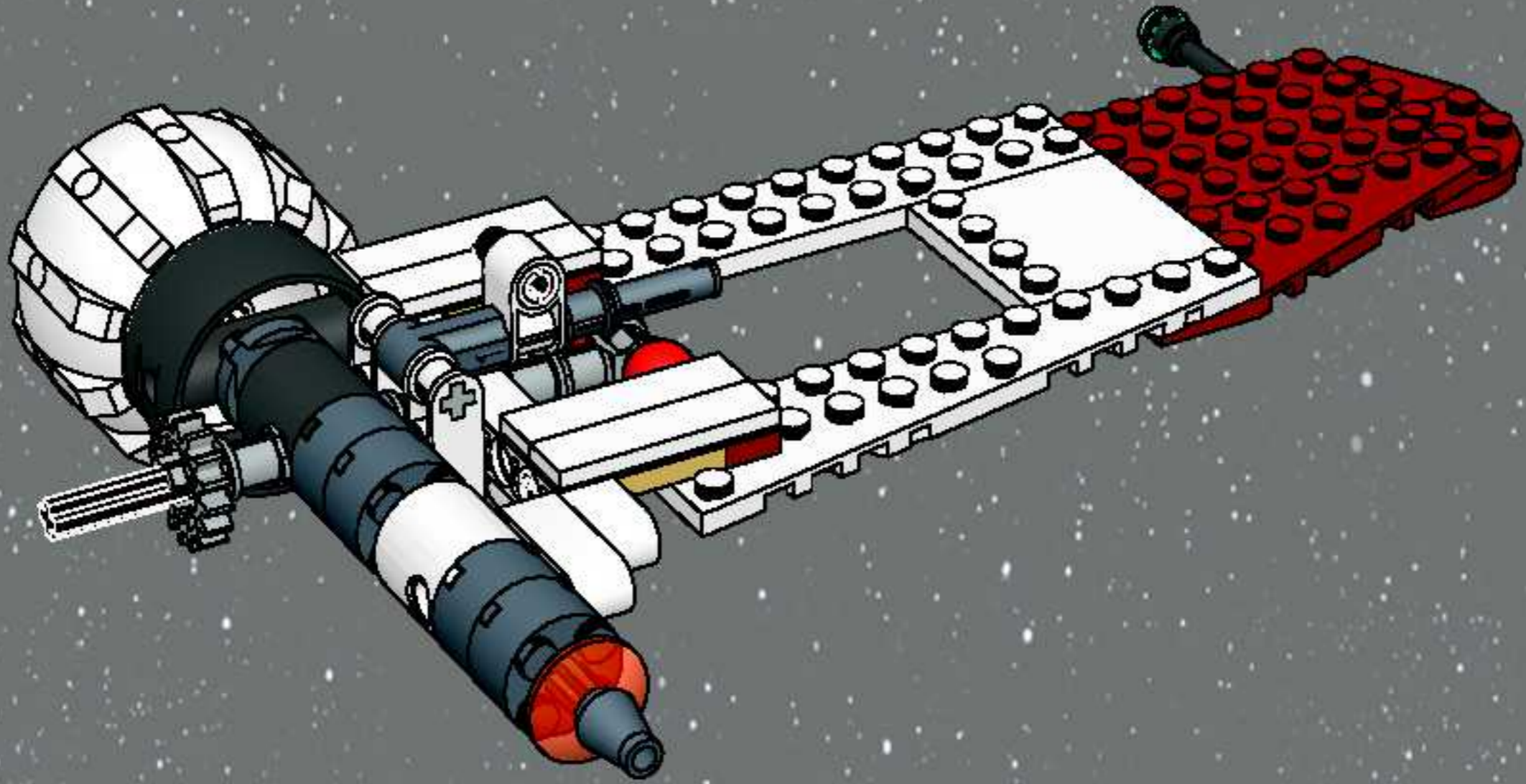

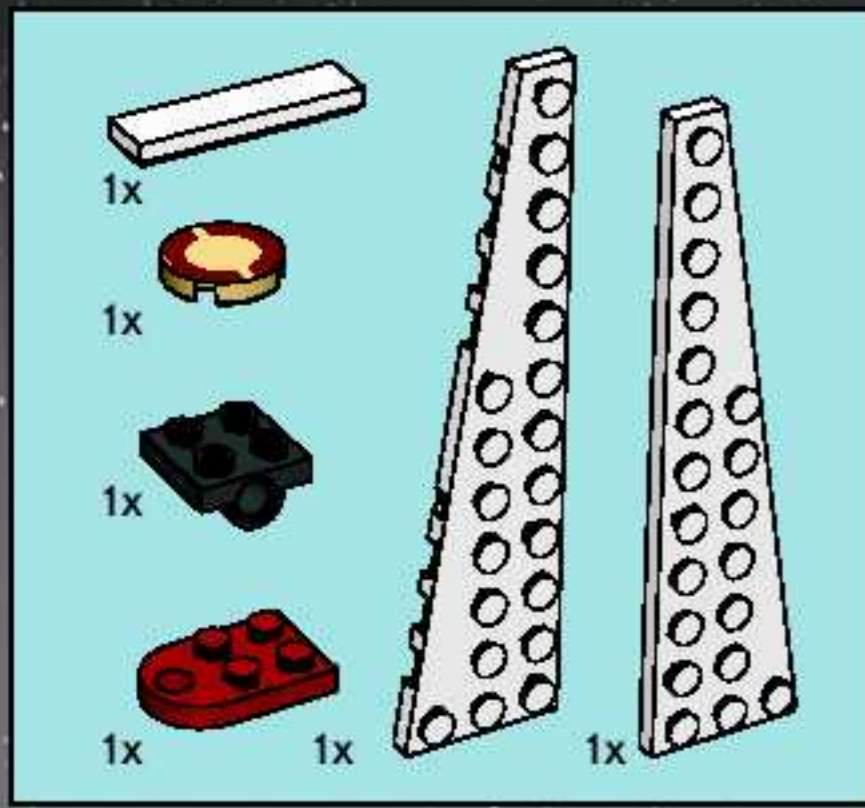

15

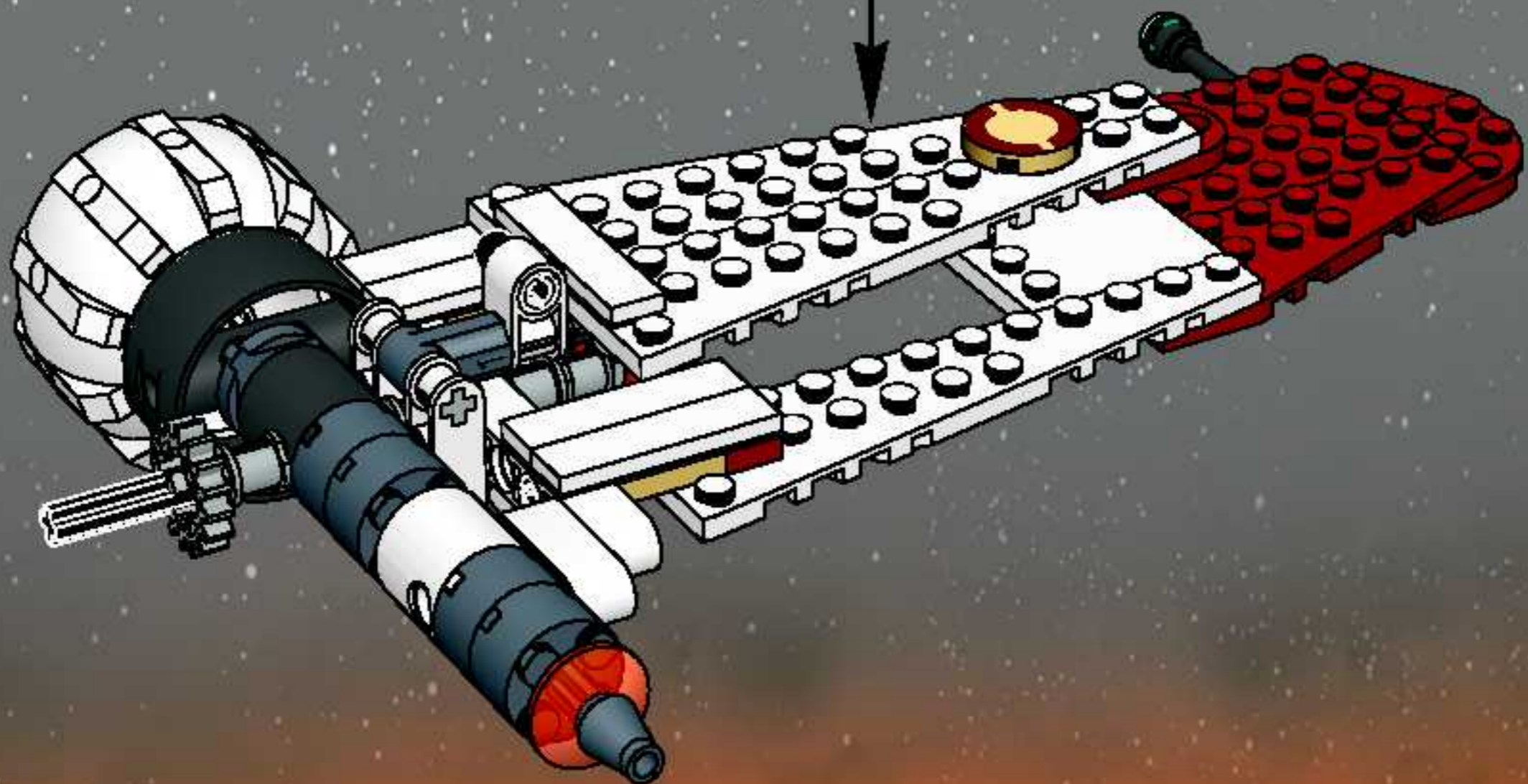
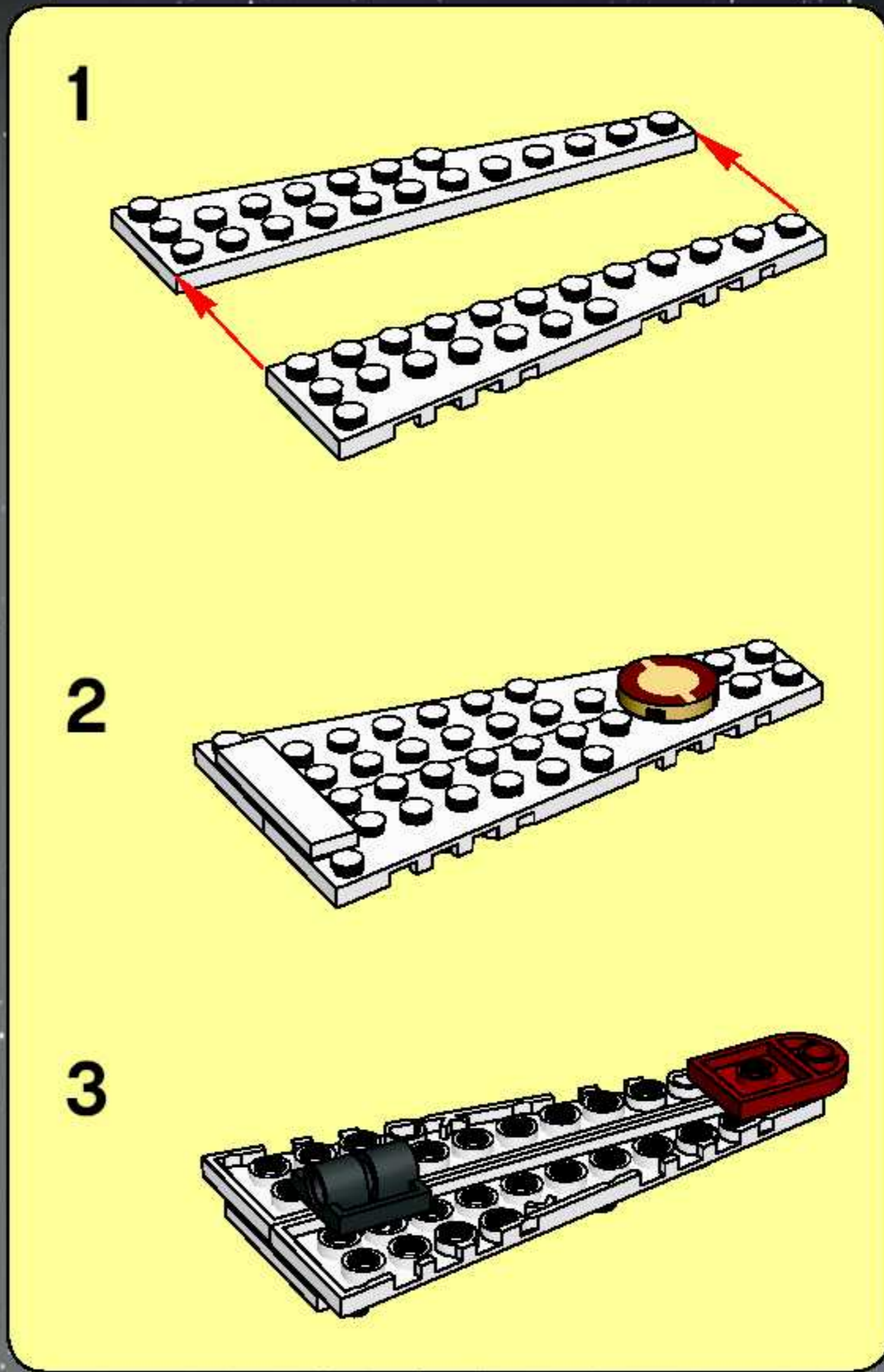

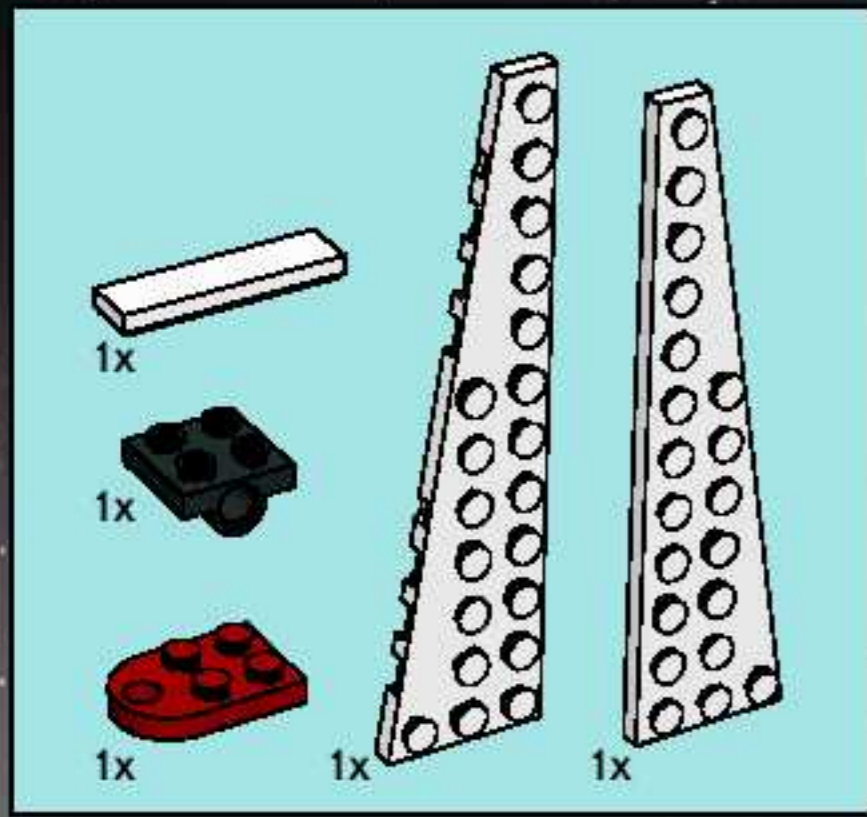

16

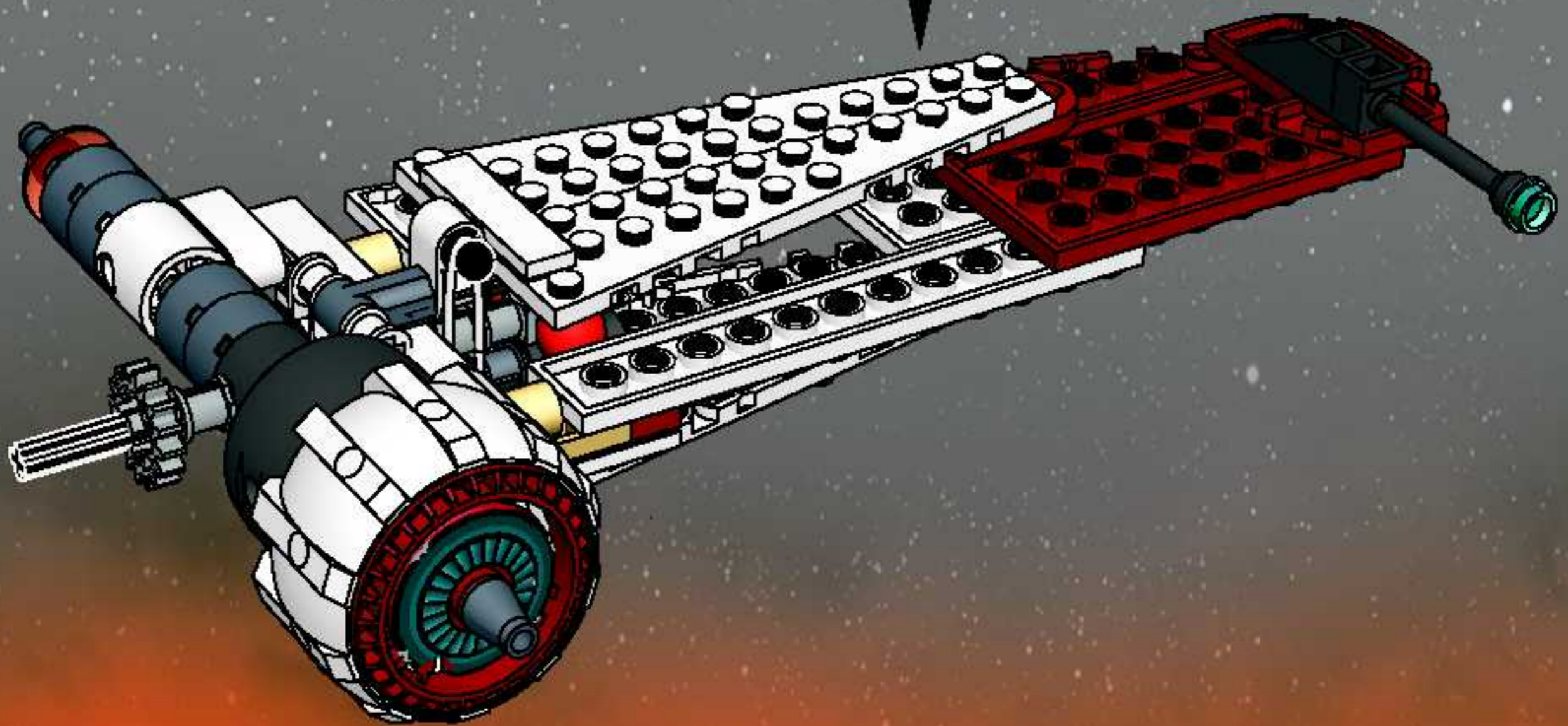
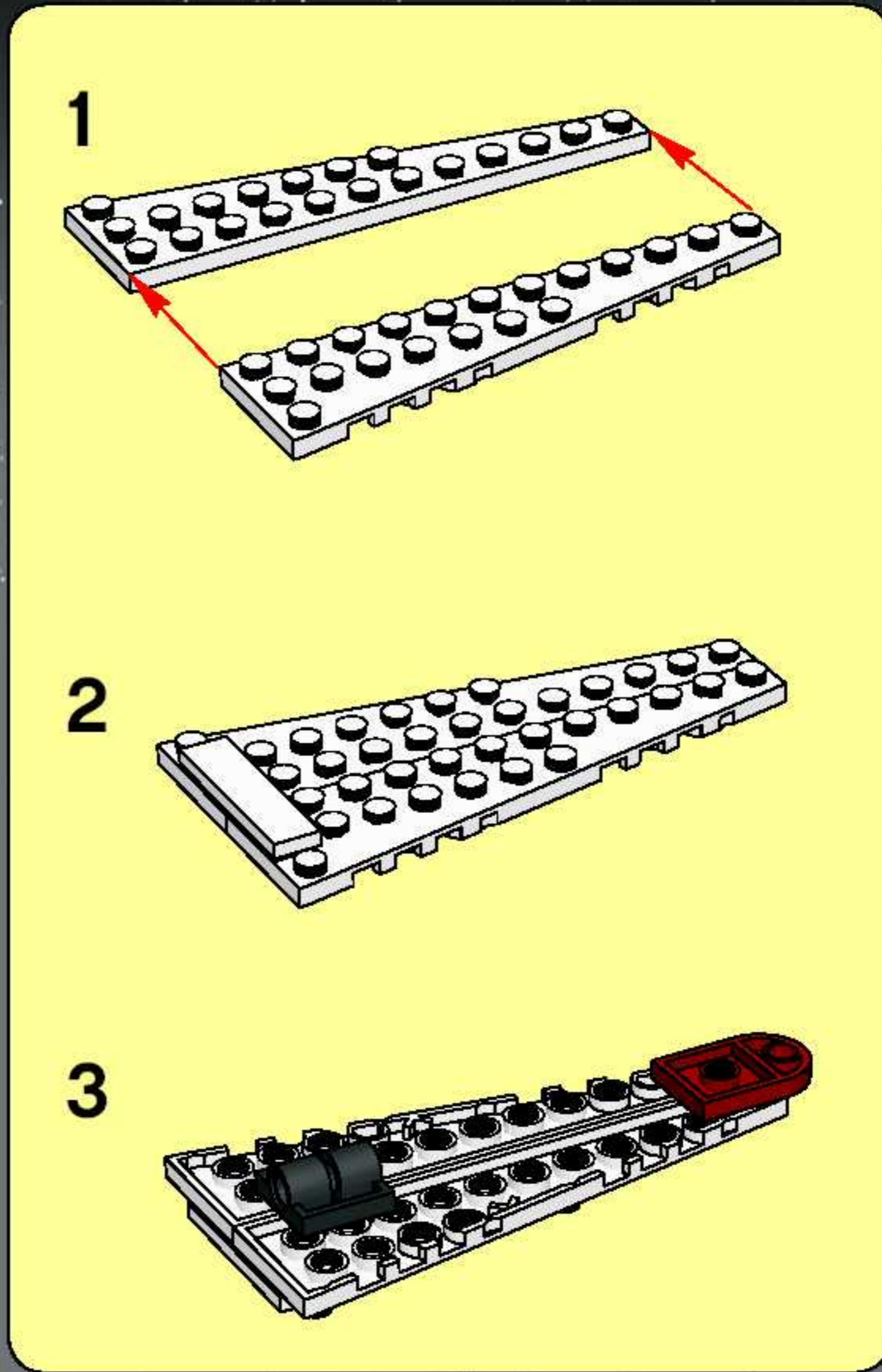

36

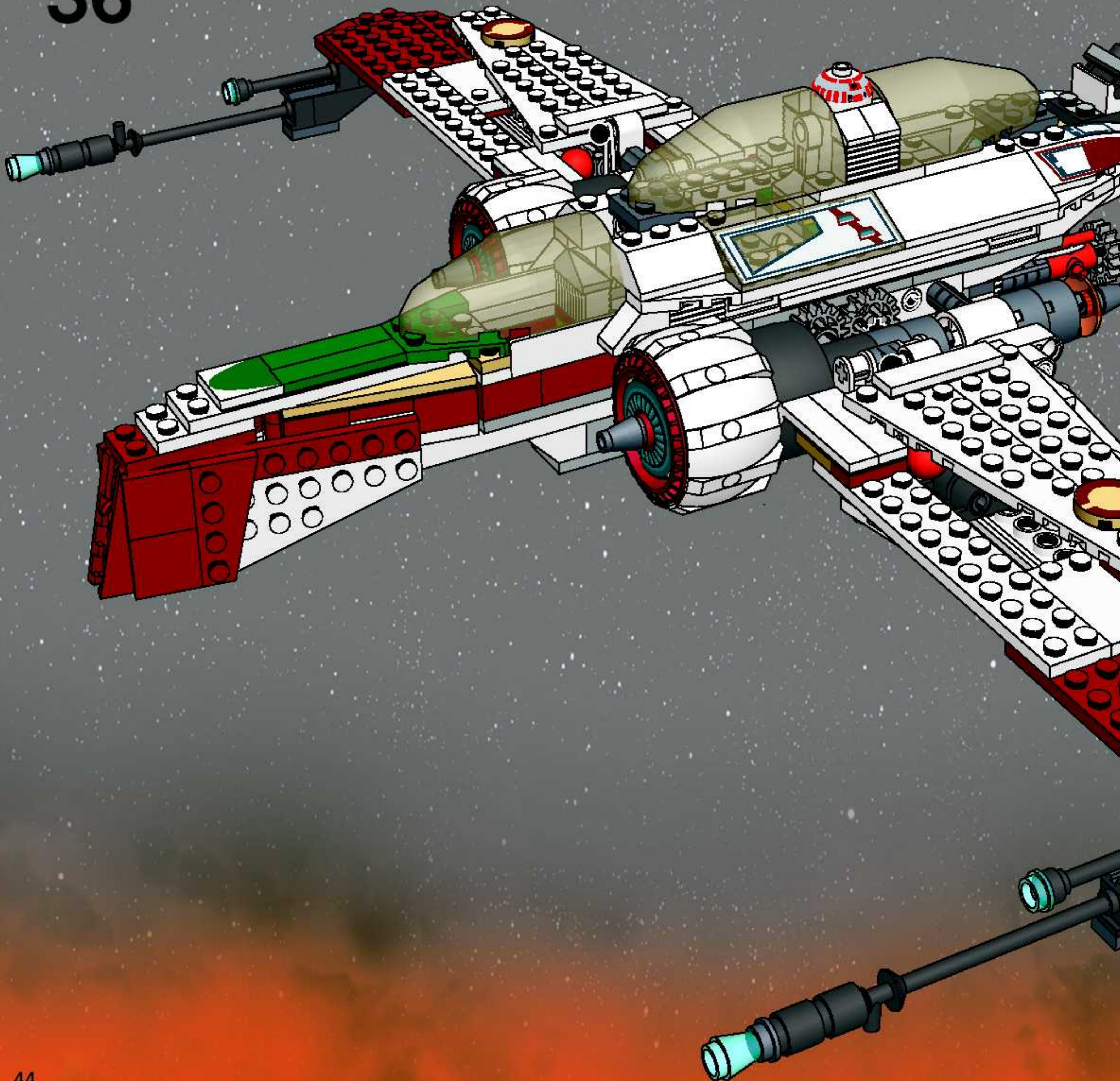

37

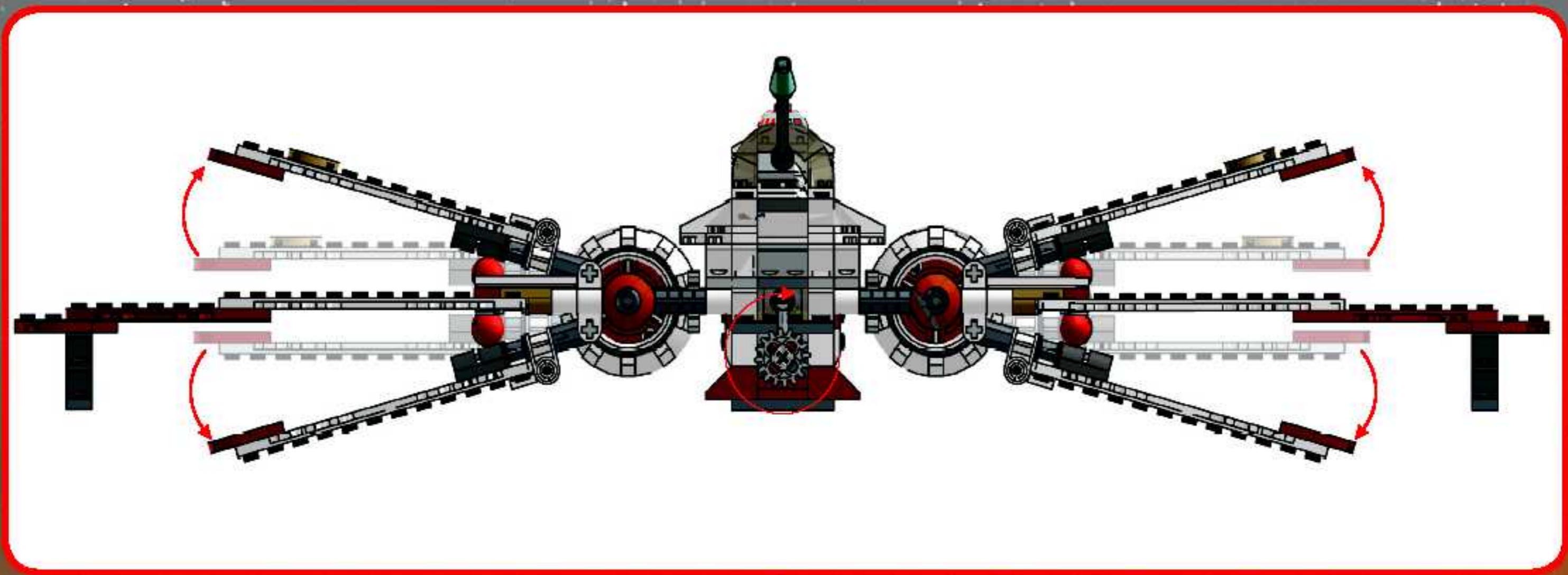
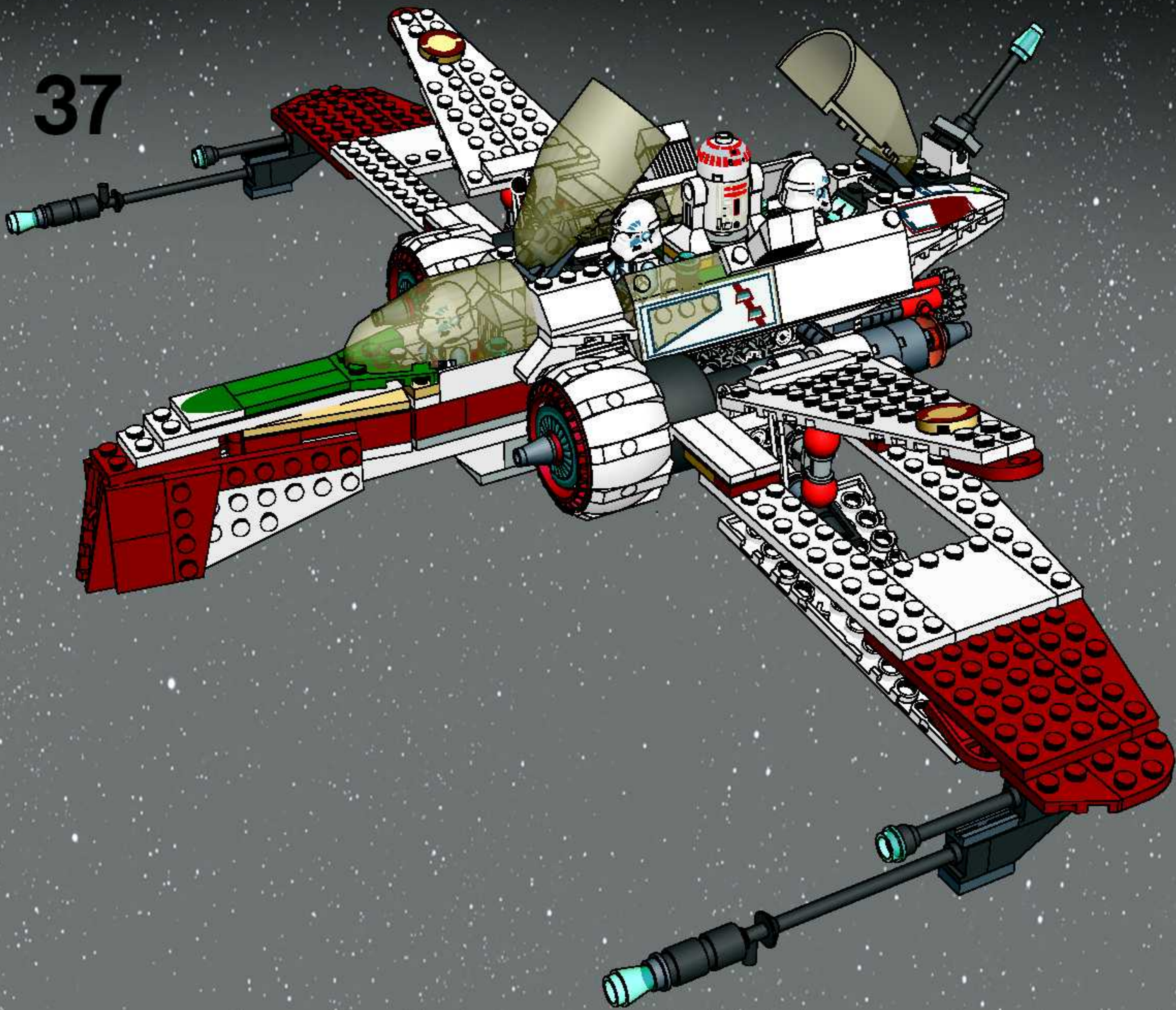

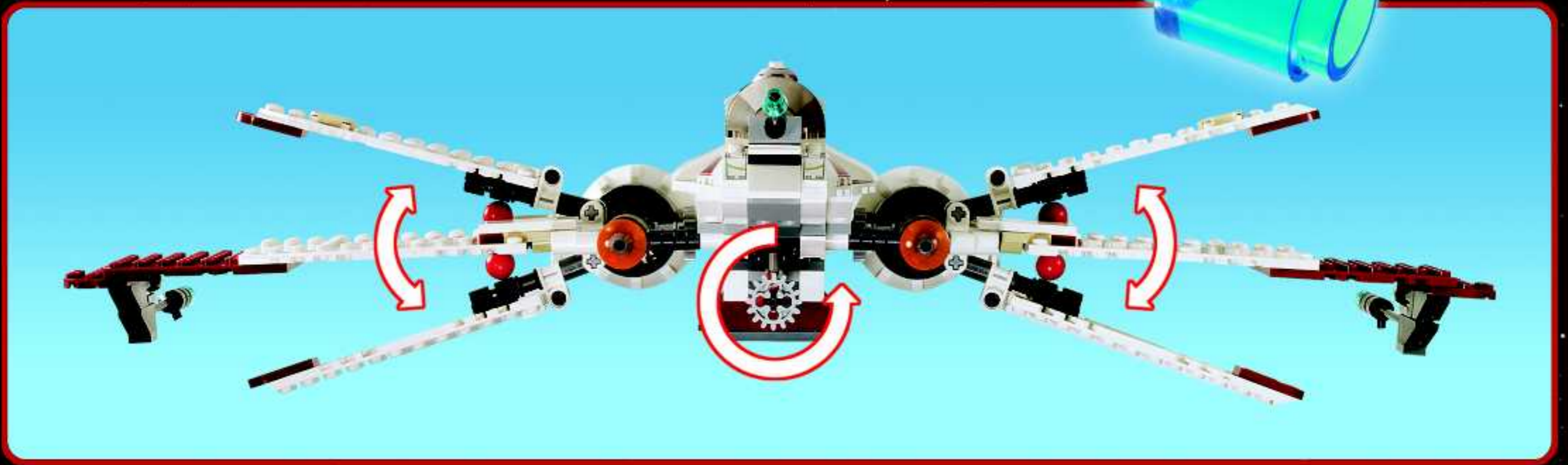





7256
Jedi Starfighter™
and Vulture Droid™



7259
Arc-170 Starfighter™



7251
Darth Vader™
Transformation



7261 Clone Turbo Tank™

7250 Clone
Scout Walker™



7252 Droid Tri-fighter™



7257 Ultimate Lightsaber™ Duel



7255 General Grievous™ Chase



7260 Wookiee Catamaran™



7258 Wookiee™ Attack



Discover the LEGO® UNIVERSE!



www.lego.com/starwars



SHOP at HOME

The World's Biggest
LEGO Shop!



The screenshot shows the LEGO SHOP at HOME website. At the top, there's a navigation bar with 'SHOP at HOME' and 'Visit the Halloween Shop!'. Below that, a welcome message reads 'Welcome to The World's Biggest LEGO® Shop!'. A prominent offer features a yellow LEGO truck with the text 'FREE LEGO Truck! A \$1499 Value!'. To the right, there are promotional banners for 'Visit our Halloween Shop!' and 'Shop Our NEW Fall Catalog Online!'. At the bottom, there are three icons for 'LEGO Auctions on eBay!', 'Catalog Quick Order', and 'Sales & Deals'.

The background shows four children smiling and playing with LEGO bricks. In the foreground, there are two screenshots of the LEGO club website. The left screenshot shows the 'club' homepage with a grid of featured content including 'LEGO magazine', 'LEGO club page', and 'LEGO club news'. The right screenshot shows a detailed article page from the LEGO magazine section, featuring a large image of a LEGO Technic model and text about a 'LEGO club' event.

Win! Gagne! Gewinne! 当たります



WIN LEGO® PRODUCTS

We would like to know what you think about our new LEGO® product. If you could help us by answering a few questions you are in with a chance of winning an exciting LEGO prize. It will only take you about 3 minutes! Log on to the web address below for further instructions.

We would really like to hear what you think about your new LEGO product. If you'd like to help us, go to the web address below for further instructions.



GAGNE DES PRODUITS LEGO®

Nous aimerions savoir ce que tu penses de ton nouveau produit LEGO®. Si tu veux bien nous aider en répondant à quelques questions, tu recevras peut-être bientôt un fantastique prix LEGO. Et cela ne te prendra que 3 minutes environ ! Tu obtiendras davantage d'informations en visitant le site Internet indiqué ci-dessous.

Nous aimerions savoir ce que tu penses de ton nouveau produit LEGO. Si tu souhaites nous aider, rends-toi à l'adresse Internet ci-dessous où tu trouveras des Instructions supplémentaires.



Kedves Ifjú LEGO® Vásárló

Ha ellátogatsz a www.acnielsen.aim.dk/lego honlapra és ott angol, francia, német vagy japán nyelven megválaszolsz néhány kérdést, akkor részt veszel egy versenyben, amelyben értékes LEGO® díjakat nyerhetsz.



GEWINNE LEGO® PRODUKTE

Wir sind sehr an deiner Meinung über dein neues LEGO® Produkt interessiert. Wenn du uns den Gefallen tust und ein paar Fragen beantwortest, kannst du einen tollen LEGO Preis gewinnen. Das Ganze dauert nur etwa 3 Minuten! Gehe einfach zu der unten angegebenen Webadresse - dort findest du weitere Informationen.

Wir möchten gerne wissen, was Sie von Ihrem neuen LEGO Produkt halten. Wenn Sie uns helfen möchten, besuchen Sie bitte die u.a. Website, auf der Sie alles Weitere erfahren.



Estimado usuario LEGO®

Al contestar algunas preguntas en inglés, francés, alemán o japonés, en el sitio www.acnielsen.aim.dk/lego, podrás participar en el sorteo de algunos valiosos premios LEGO®.



Caro Consumidor da LEGO®

Ao responder a algumas perguntas em Inglês, Francês, Alemão ou Japonês no endereço www.acnielsen.aim.dk/lego irá participar num concurso para ganhar valiosos prémios da LEGO®.



抽選でレゴ®製品が当たります

私たちは、皆さんがお買い求めのレゴ®製品についてどんな感想をお持ちか、知りたいと思っています。質問に答えて、楽しいレゴ®製品の抽選に応募しませんか。アンケートの回答には、ほんの3分ほどしかかかりません！詳しくは、以下のウェブアドレスまでアクセスしてください。



www.acnielsen.aim.dk/LEGO





STAR WARS

THE VIDEO GAME

4291633
©2005 The LEGO Group.



LEGO, the LEGO logo and the Minifigure are trademarks of The LEGO Group. © 2004 The LEGO Group. © 2004 Lucasfilm Entertainment Company Ltd. or Lucasfilm Ltd. & © or TM as indicated. All rights reserved. Microsoft, Xbox and the Xbox logos are either registered trademarks or trademarks of Microsoft Corporation in the U.S. and/or in other countries and are used under license from Microsoft. All rights reserved. "PS2" and "PlayStation" are registered trademarks of Sony Computer Entertainment Inc. All rights reserved. GAME BOY ADVANCE IS A TRADEMARK OF NINTENDO. The NVIDIA logo and "The way it's meant to be played" logo are registered trademarks or trademarks of NVIDIA Corporation.