

BIONICLE®



TOA
IRINI
SPECIAL EDITION

8762





1

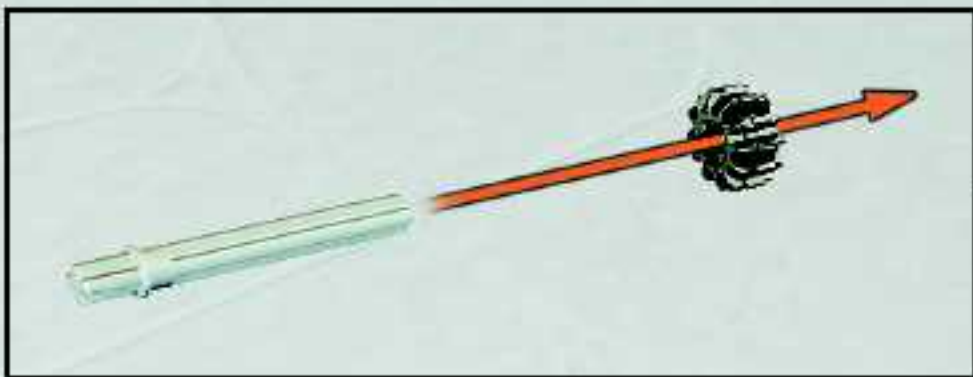
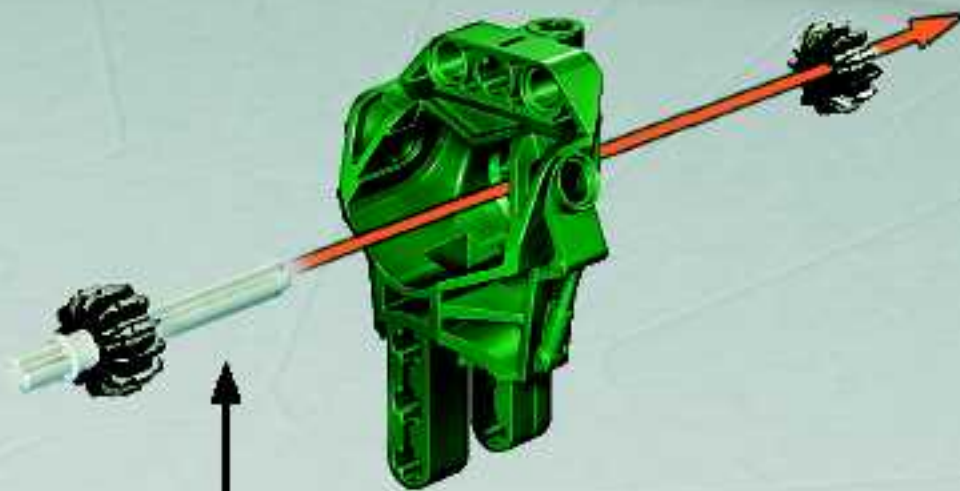

2



3

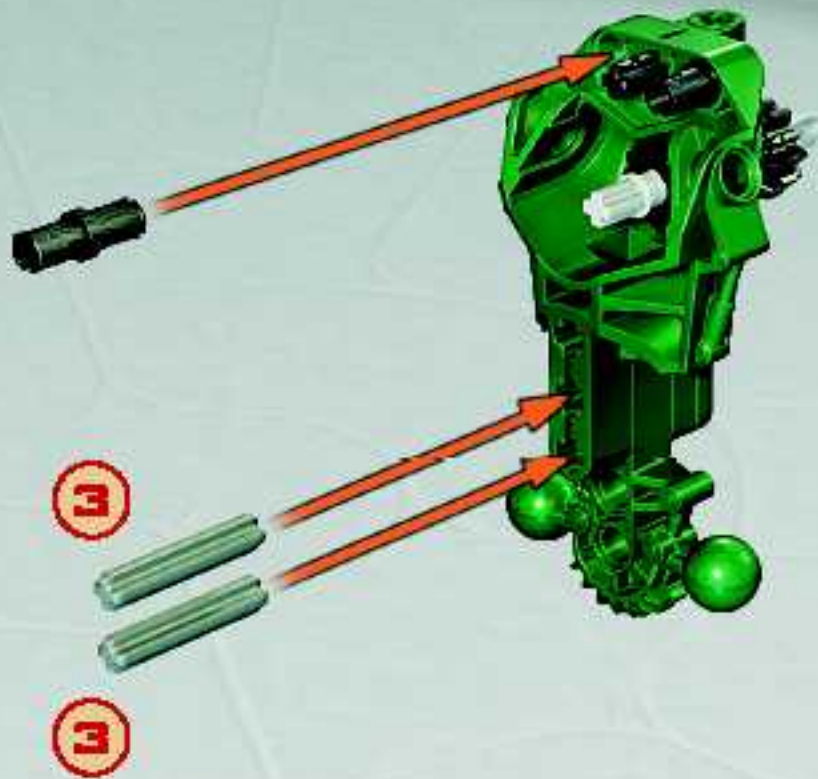

4

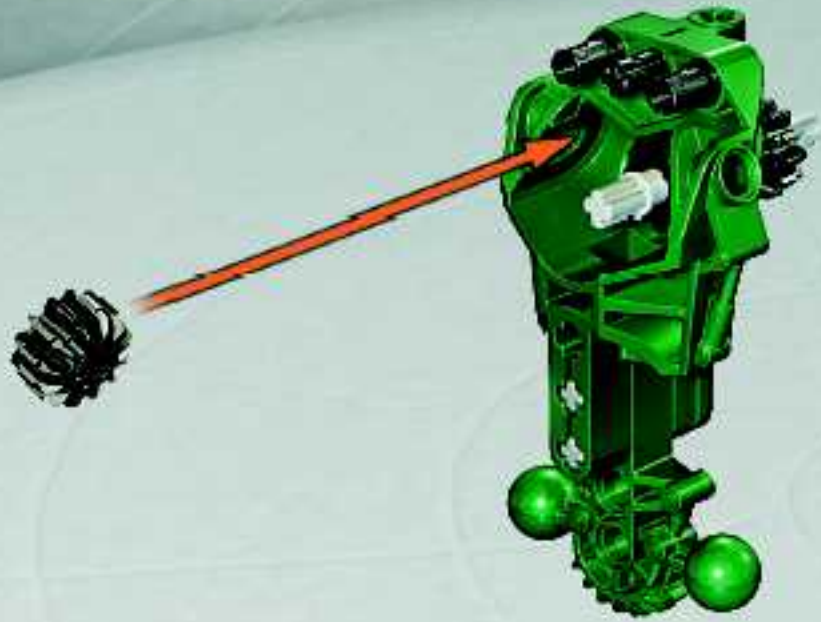

5



1



2



3



6

4



2x

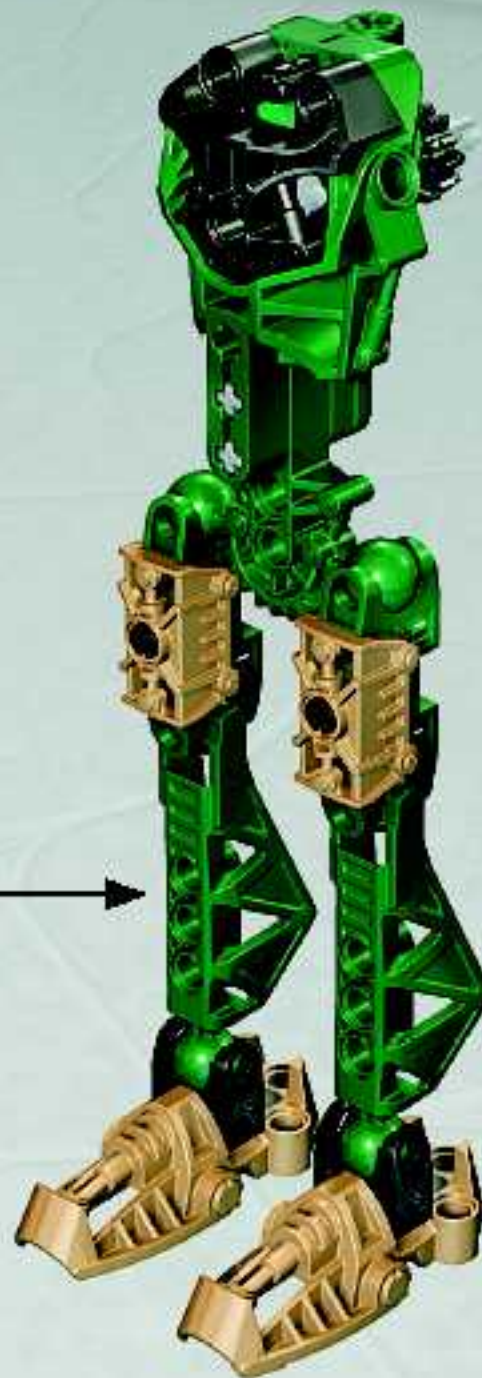

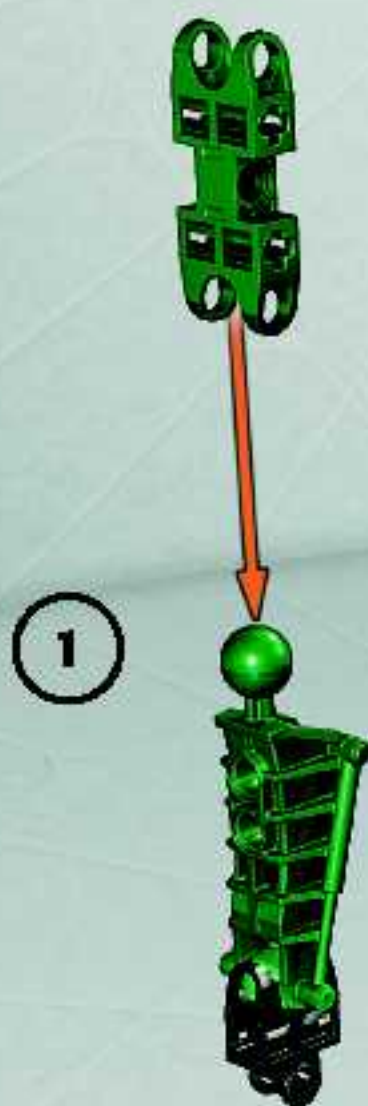

7

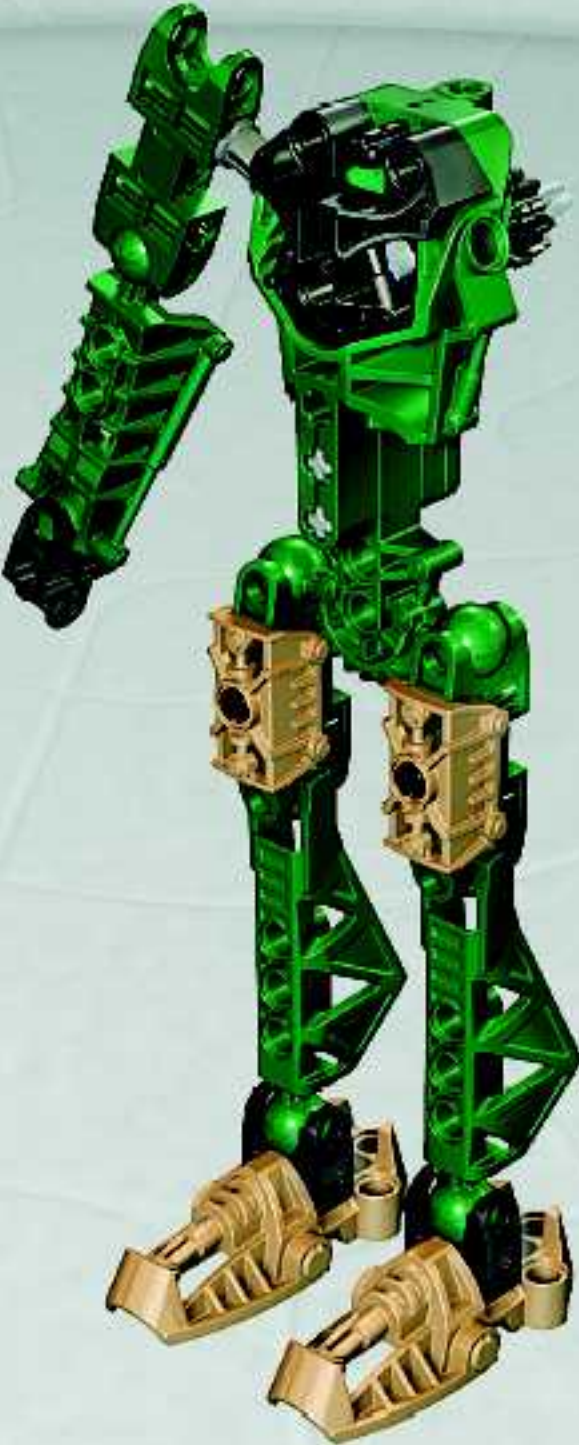

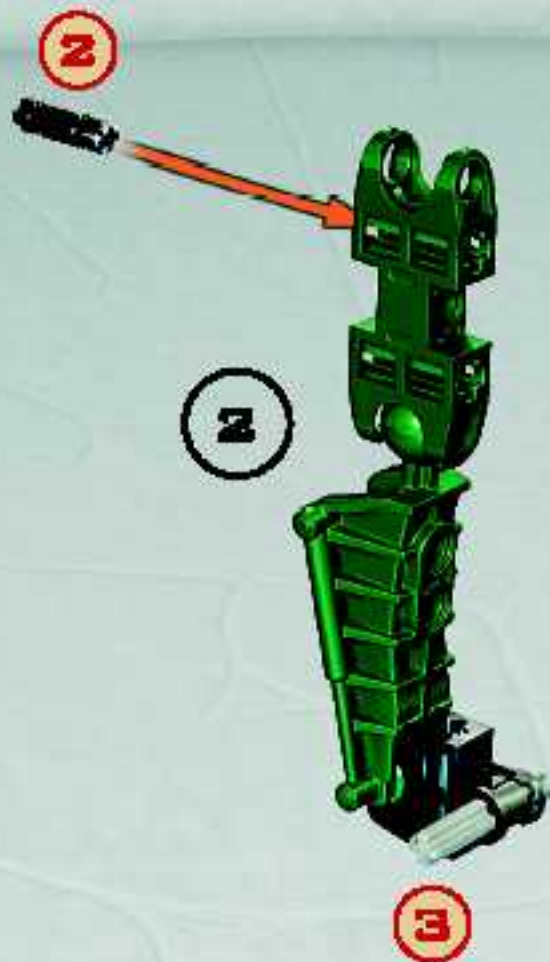
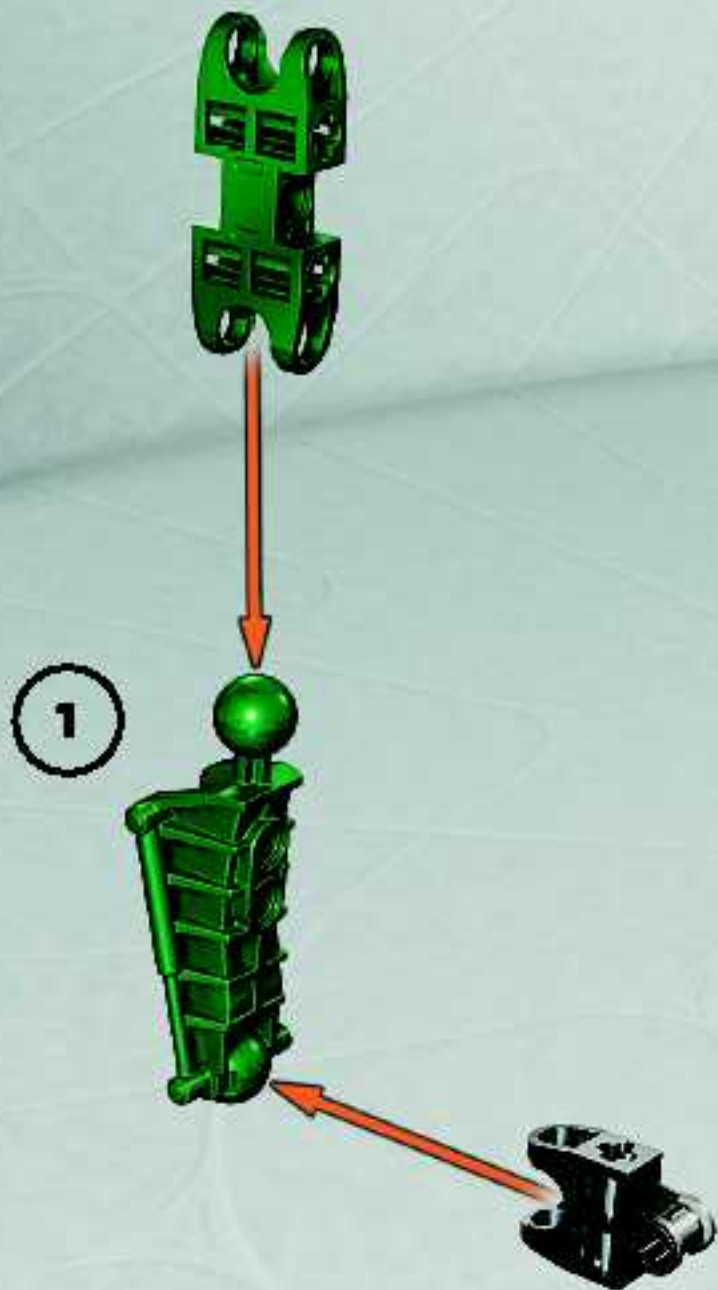

8



9



10

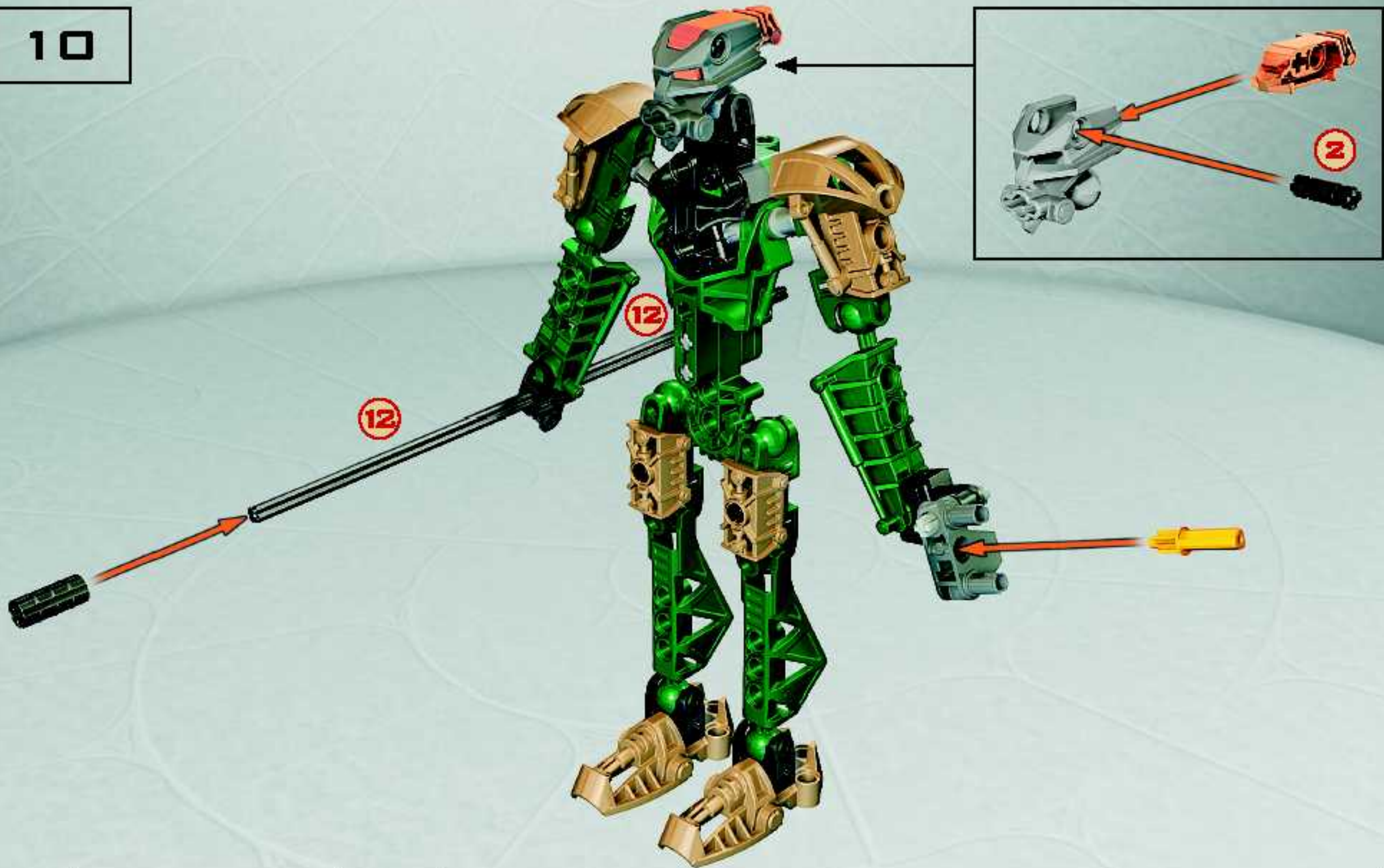

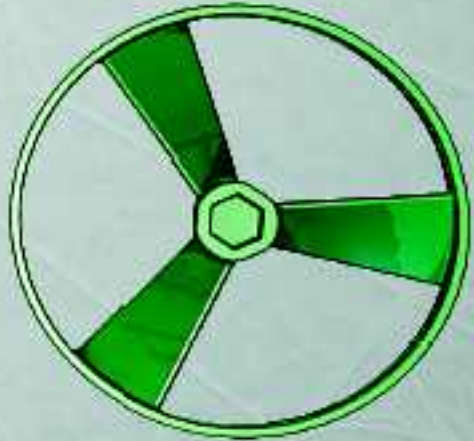

Discover the LEGO® UNIVERSE!



www.LEGOuniverse.com

LEGO SHOP at HOME

The
World's
Biggest
LEGO
Shop!

English Deutsch Français



LEGO club



Win! Gagne! Gewinne! 当たります



WIN LEGO® PRODUCTS

We would like to know what you think about our new LEGO® product. If you could help us by answering a few questions you are in with a chance of winning an exciting LEGO prize. It will only take you about 3 minutes! Log on to the web address below for further instructions.

We would really like to hear what you think about your new LEGO product. If you'd like to help us, go to the web address below for further instructions.



Estimado usuario LEGO®

Al contestar algunas preguntas en inglés, francés, alemán o japonés, en el sitio www.acnielsen.aim.dk/lego, podrá participar en el sorteo de algunos valiosos premios LEGO®.



抽選でLEGO®製品が当たります

私たちは、皆さんが新しいLEGO®製品についてどんな感想をお持ちか、知りたく思っています。質問に答えて、新しいLEGO®製品の抽選に当たってほしい。アンケートの回答では、皆さんの名前と住所の他に、お名前は、以下のウェブアドレスでアクセスしてください。



GAGNE DES PRODUITS LEGO®

Nous aimerions savoir ce que tu penses de ton nouveau produit LEGO®. Si tu veux bien nous aider en répondant à quelques questions, tu recevras peut-être bientôt un fantastique prix LEGO. Et cela ne te prendra que 3 minutes environ ! Tu obtiendras davantage d'informations en visitant le site Internet indiqué ci-dessous.

Nous aimerions savoir ce que tu penses de ton nouveau produit LEGO. Si tu souhaites nous aider, rends-toi à l'adresse Internet ci-dessous où tu trouveras des instructions supplémentaires.



Caro Consumidor de LEGO®

Ao responder a algumas perguntas em Inglês, Francês, Alemão ou Japonês no endereço www.acnielsen.aim.dk/lego irá participar num concurso para ganhar valiosos prémios de LEGO®.



GEWINNE LEGO® PRODUKTE

Wir sind sehr an deiner Meinung über dein neues LEGO® Produkt interessiert. Wenn du uns den Gefallen tust und ein paar Fragen beantwortest, kannst du einen tollen LEGO Preis gewinnen. Das Ganze dauert nur etwa 3 Minuten! Gehe einfach zu der unten angegebenen Webadresse - dort findest du weitere Informationen.

Wir möchten gerne wissen, was Sie von Ihrem neuen LEGO Produkt halten. Wenn Sie uns helfen möchten, besuchen Sie bitte die u.a. Website, auf der Sie alles Weitere erfahren.



Kedves Új LEGO® Vásárló

Ha ellátogat az www.acnielsen.aim.dk/lego honlapra és ott angol, francia, német vagy japán nyelven megválaszol az néhány kérdést, akkor részt vehet egy versenyben, amelyben értékes LEGO® díjakat nyerhet.

www.acnielsen.aim.dk/LEGO



LEGO, the LEGO logo, the CLICKITS logo and BIONICLE are trademarks of the LEGO Group.
©2005 The LEGO Group.
Ferrari, all associated logos and the distinctive designs are trademarks of Ferrari S.p.A.
The body of the Ferrari car is protected as Ferrari property under trade dress and/or design regulations.

2005

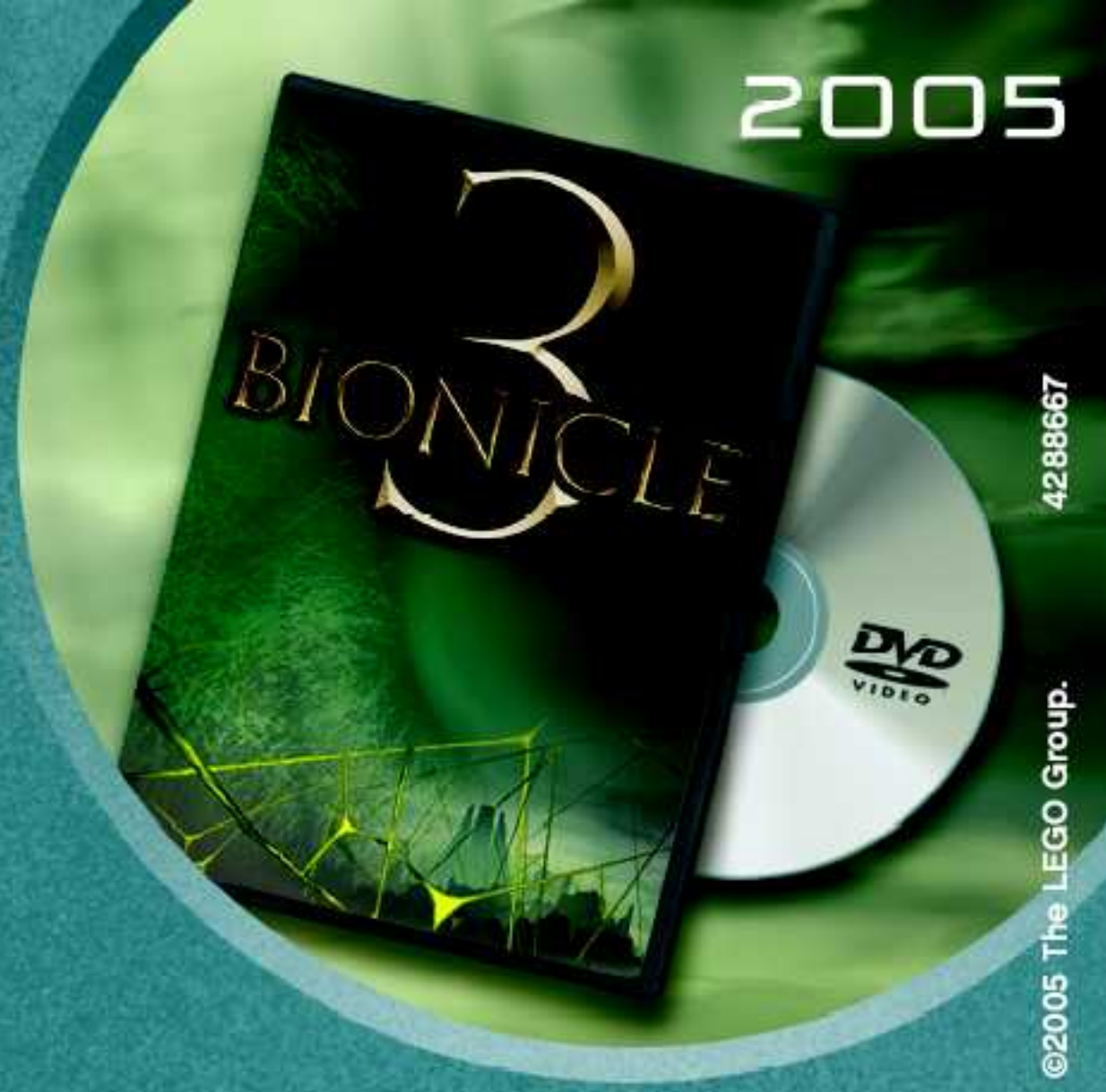

©2005 The LEGO Group. 4288667



www.bionicle.com

