



CITY

60371



1



### **Get excited about our new packaging!**

We're switching from plastic to paper-based packaging. That's why you might find a mix of paper and plastic in our boxes!

### **Nos nouveaux emballages vous emballeront !**

Nous passons des emballages en plastique aux emballages à base de papier. C'est pourquoi vous pourriez trouver un mélange de papier et de plastique dans nos boîtes !

### **¡Te presentamos nuestros nuevos empaques!**

Estamos sustituyendo las bolsas de plástico por bolsas con base de papel. ¡Por eso, puedes encontrar una mezcla de papel y de plástico en nuestras cajas!

**[LEGO.com/sustainable-packaging](https://www.lego.com/sustainable-packaging)**



# BUILDER



Apple and the Apple logo are trademarks of Apple Inc., registered in the U.S. and other countries and regions. App Store is a service mark of Apple Inc. Google Play and the Google Play logo are trademarks of Google LLC. Tencent and the Tencent logo are trademarks of Tencent Inc.

Q [LEGO.com/devicecheck](https://www.lego.com/devicecheck)

**EN** Ask parents' permission before going online | **DE** Eltern um Erlaubnis bitten, bevor du online gehst | **FR** Demande l'autorisation d'un parent avant d'aller en ligne | **IT** Chiedi il permesso ai tuoi genitori prima di andare online | **ES** Pídeles permiso a tus papás antes de conectarte a Internet | **PT** Pede autorização aos pais antes de acederes online | **JA** オンラインになる前に ほか者の方のきよかをもらおう | **ZH** 上网前应先征得父母的同意 | **KO** 온라인 접속 전에 보호자 동의가 필요합니다 | **RU** Спроси разрешения у родителей, прежде чем заходить в интернет | **PL** Poproś rodziców o zgodę, zanim wejdziesz do Internetu | **CS** Než půjdeš na internet, požádej rodiče o svolení | **SK** Skôr než pôjdeš na internet, vypýtaj si povolenie od rodičov | **HU** Kérj szülői engedélyt, mielőtt online csatlakoznál! | **RO** Cere permisiunea părinților înainte de a te conecta online | **BG** Поискайте разрешение от родител, преди да влезете онлайн | **LV** Pirms došanās tiešsaistē palūdz atļauju vecākiem | **ET** Enne Interneti kasutamist küsi vanematelt luba | **LT** Prieš prisijungdami prie interneto, atsklauskite tėvų

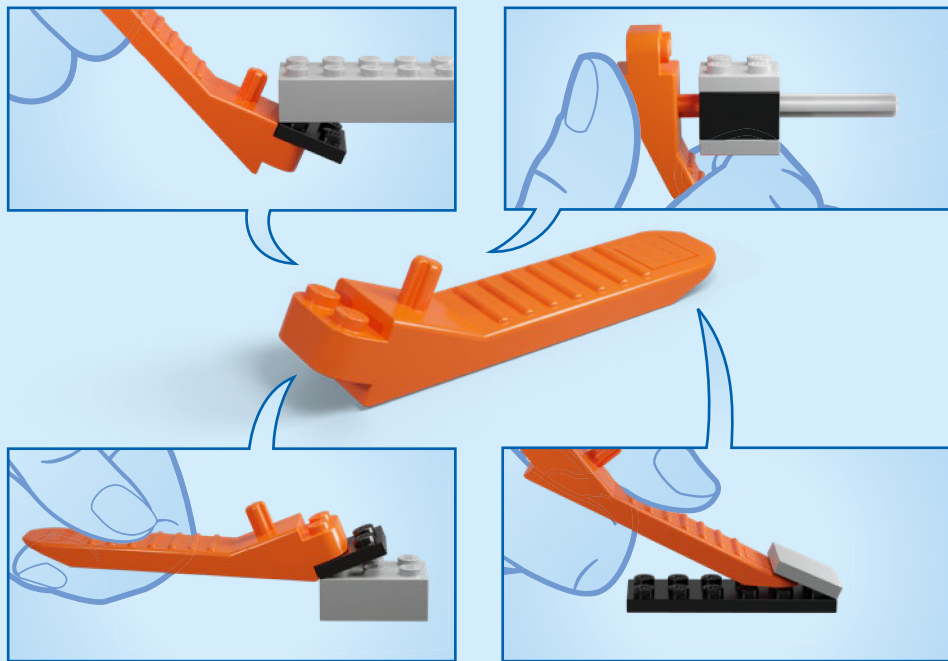



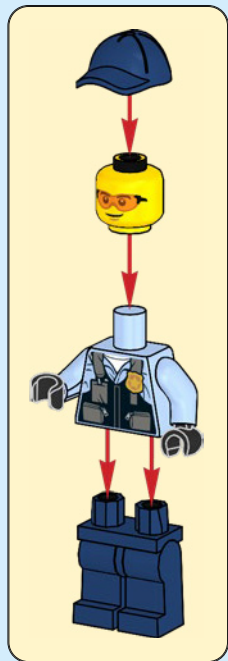

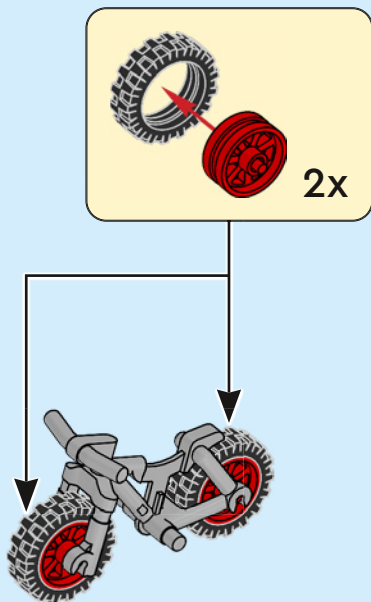

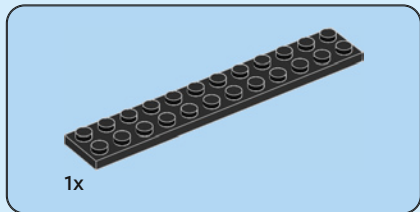

1

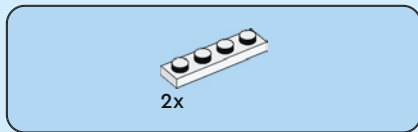
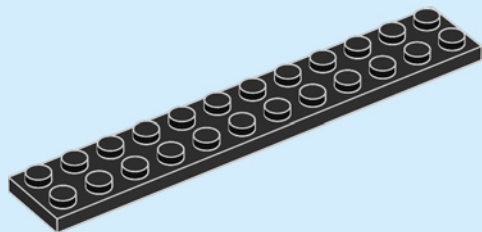

2

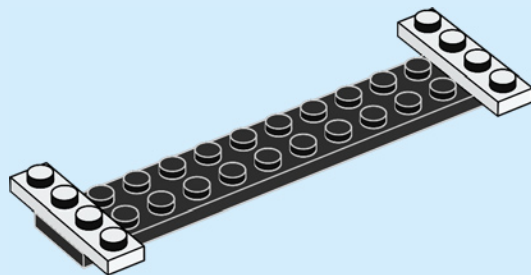





4x

3

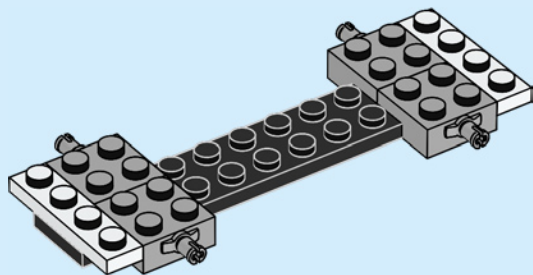

2x

4

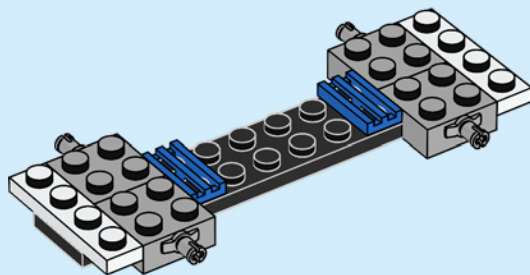

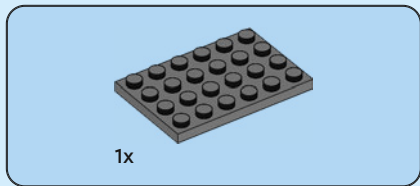

5

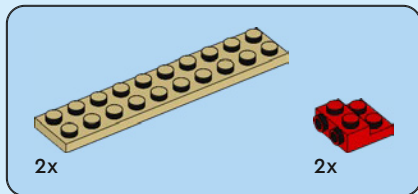
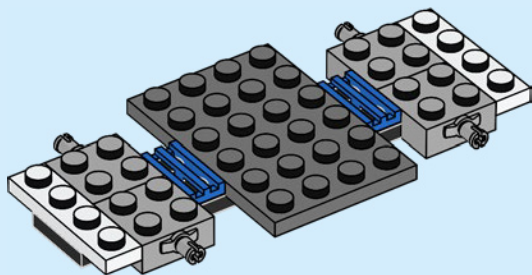

6

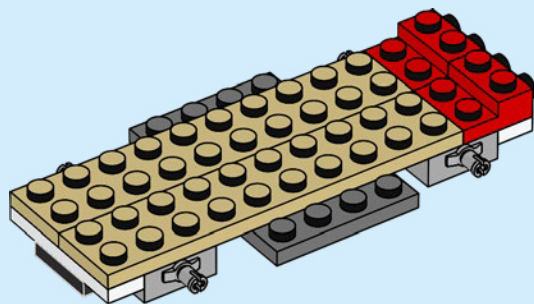

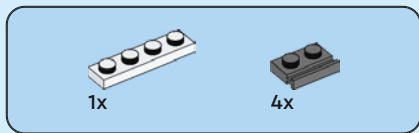

7

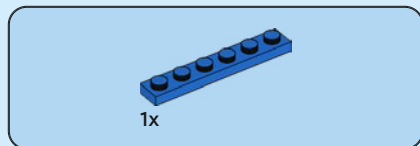
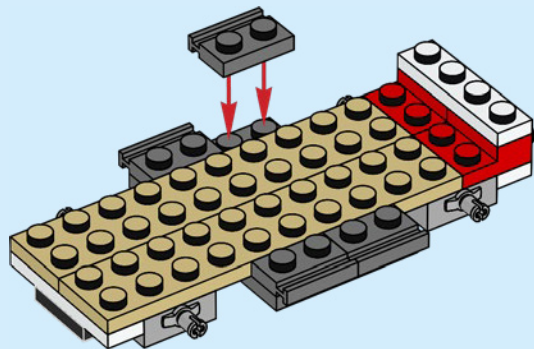

8

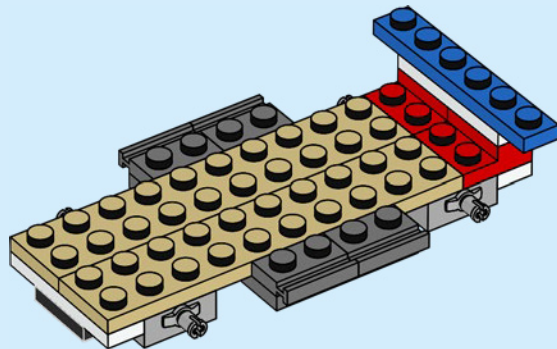

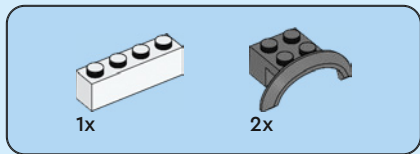

9

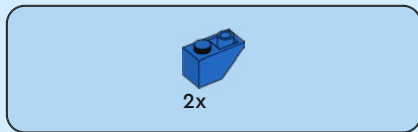
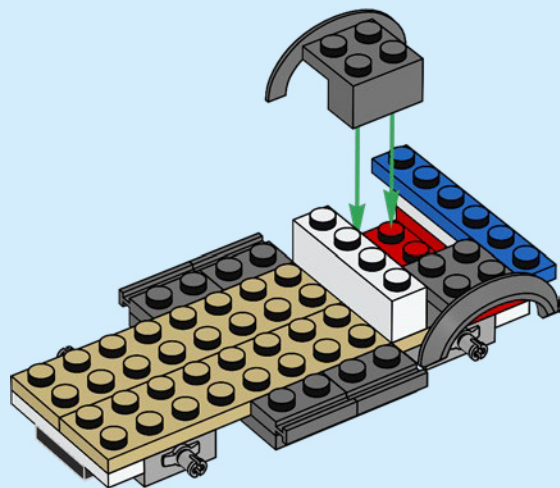

10

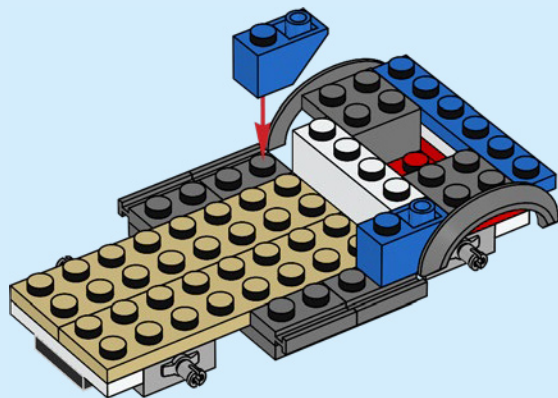

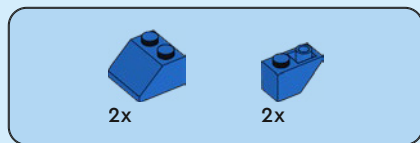

11

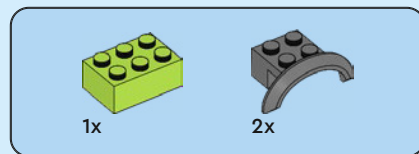
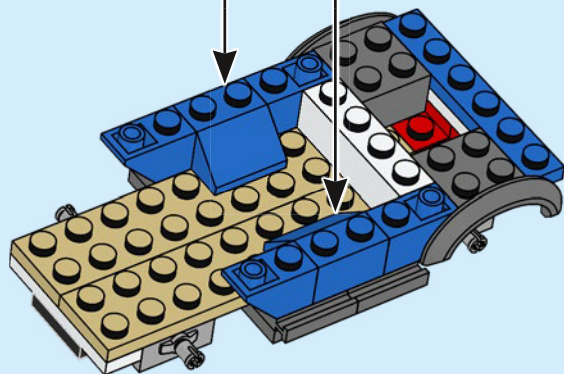
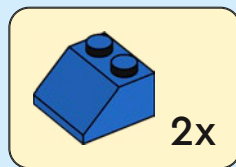

12

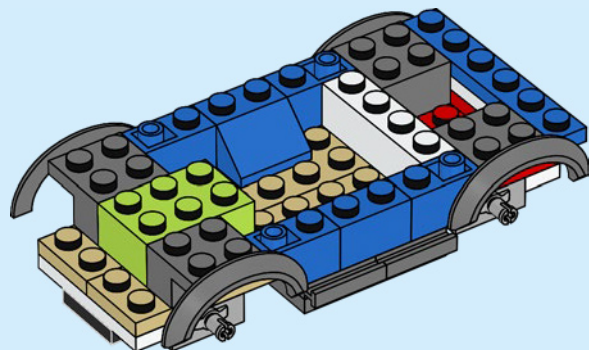

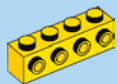

1x

13

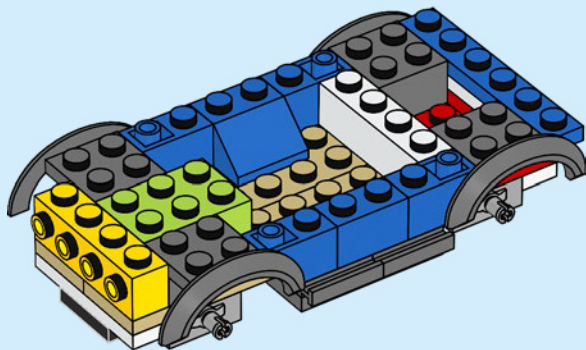

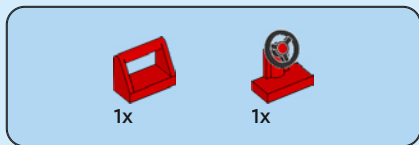

14

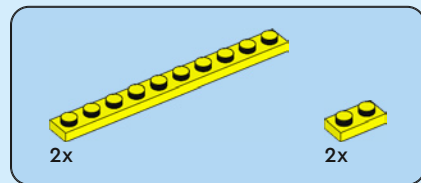
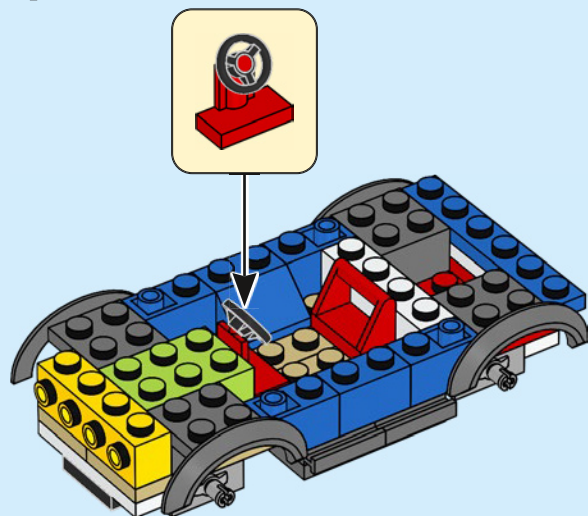

15

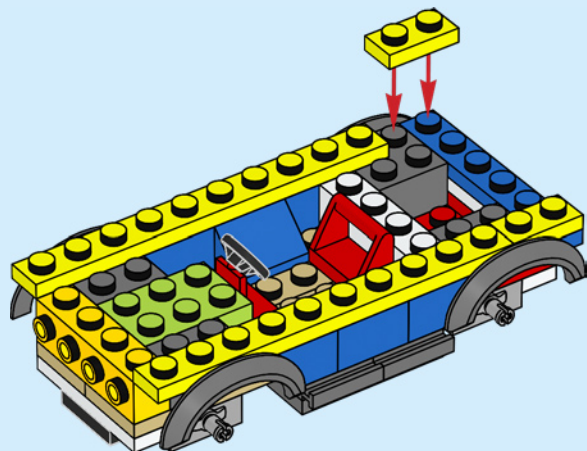



2x

16

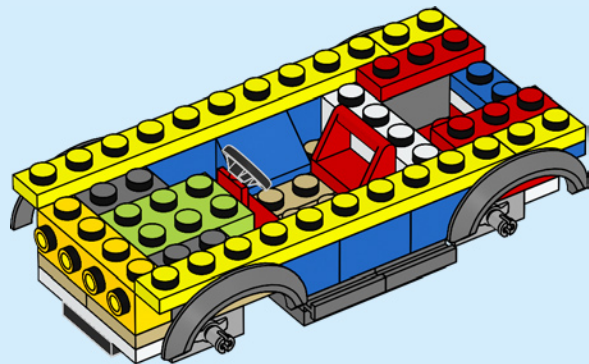



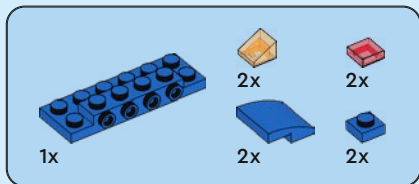

17

1

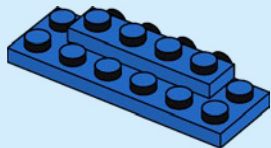

2

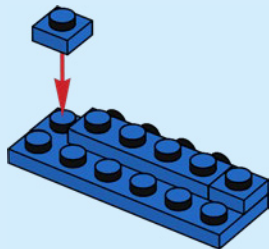

3

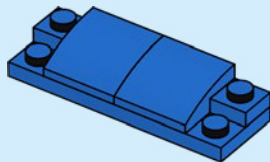

4

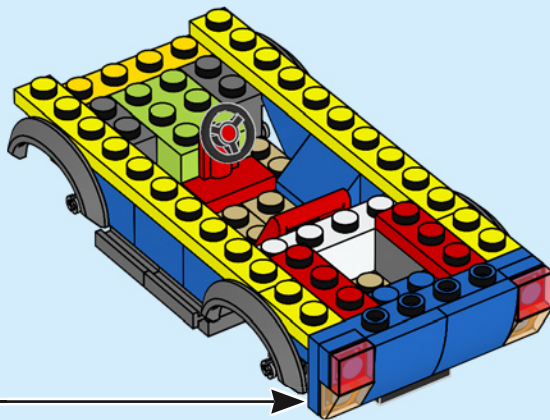
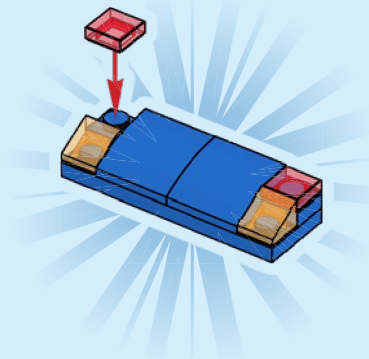



1x

18

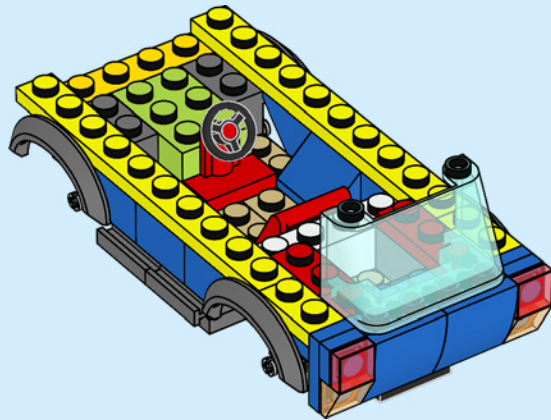



2x

19

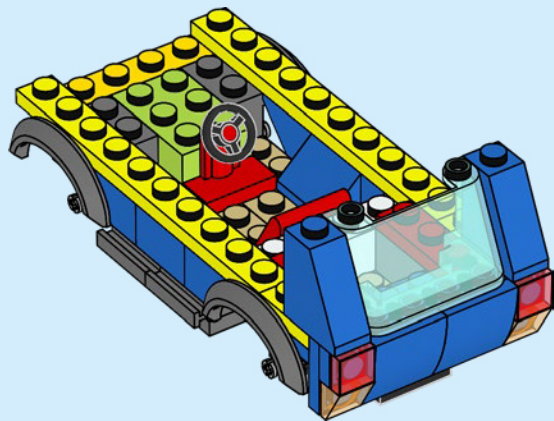



1x

20

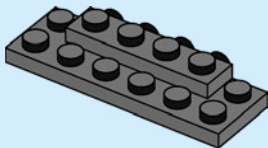

2x

21

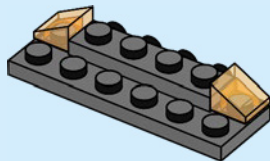



1x



2x

# 22

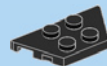
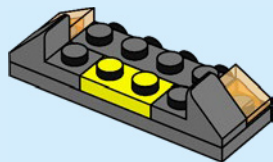

1x

# 23

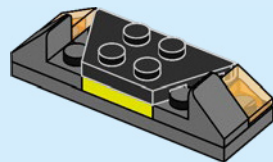

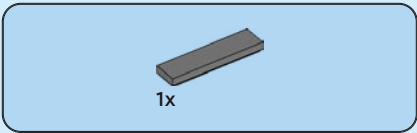

24

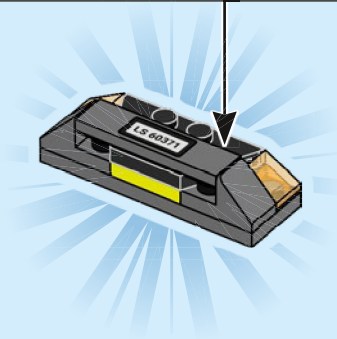
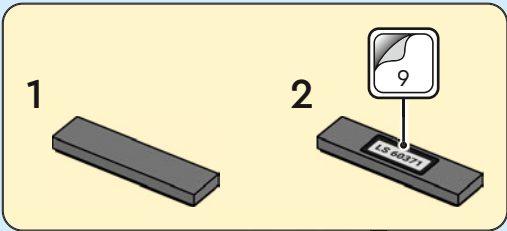

25

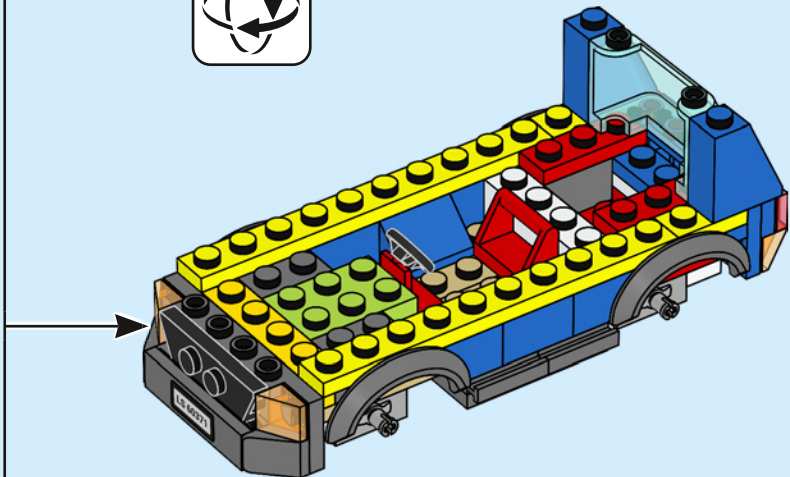
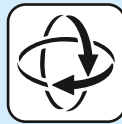



1x

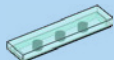

2x



2x

# 26

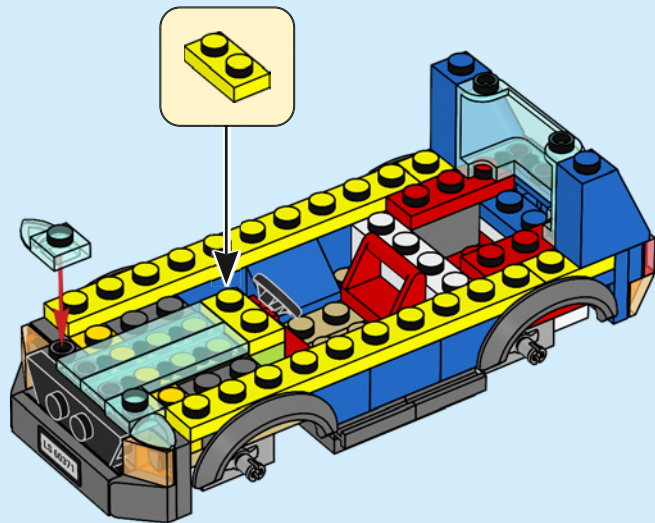





27

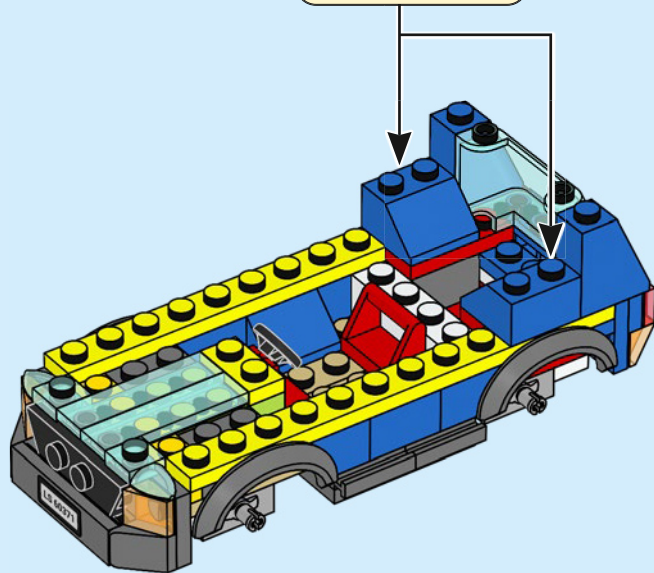
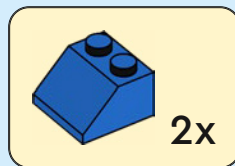

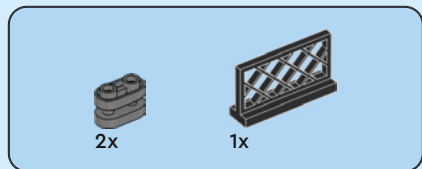

28

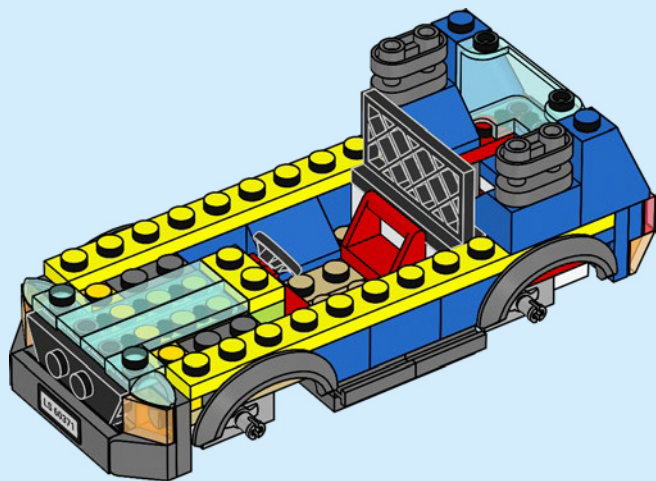



2x



2x

# 29

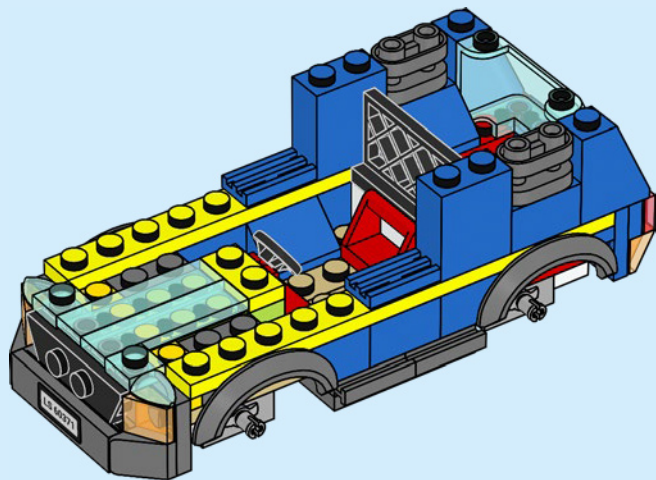



2x



2x

# 30

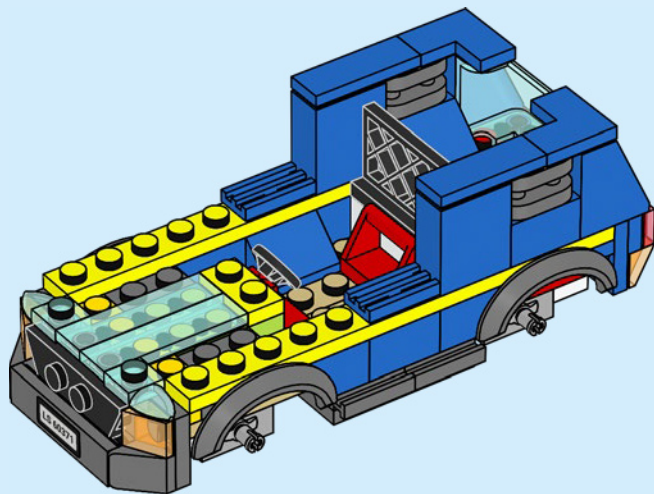



2x

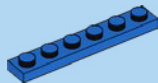

1x

# 31

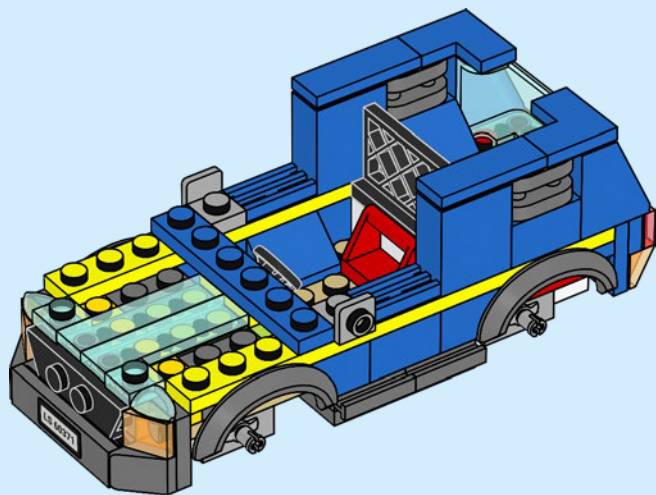

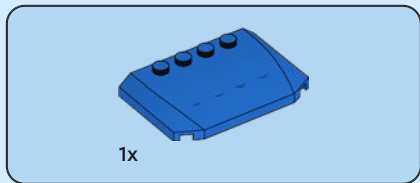

32

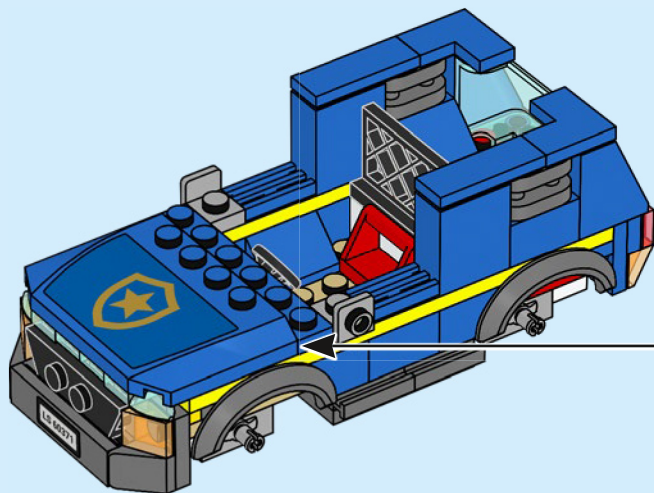
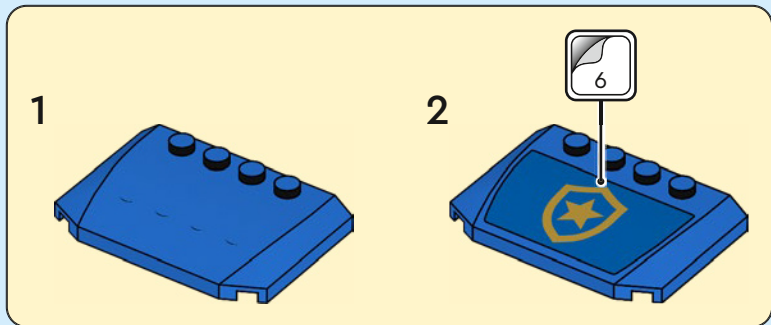

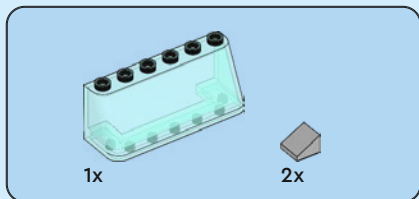

33

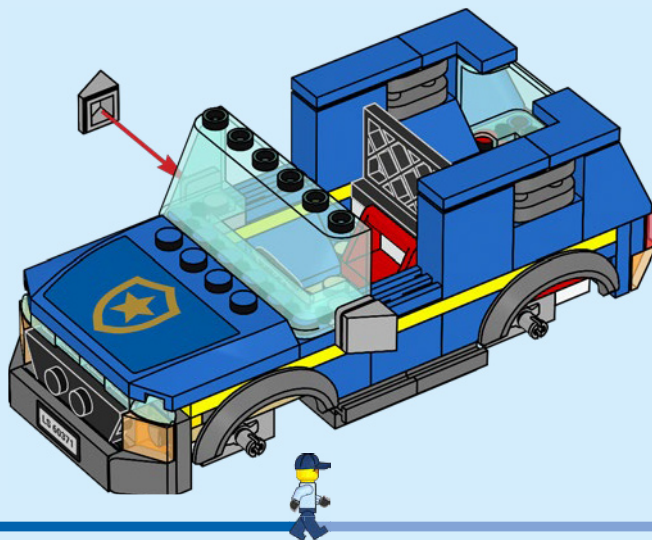

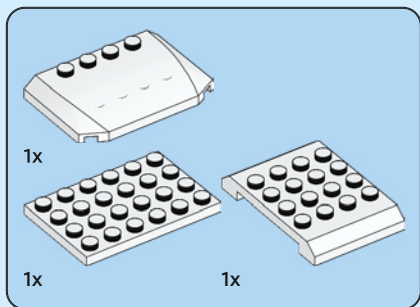

# 34

1

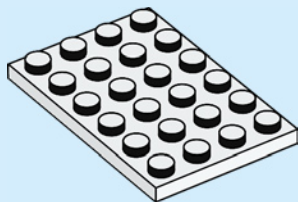

2

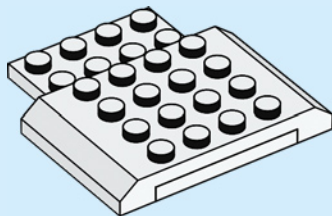

3

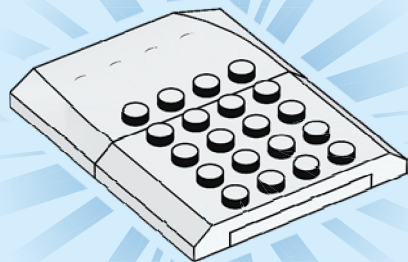



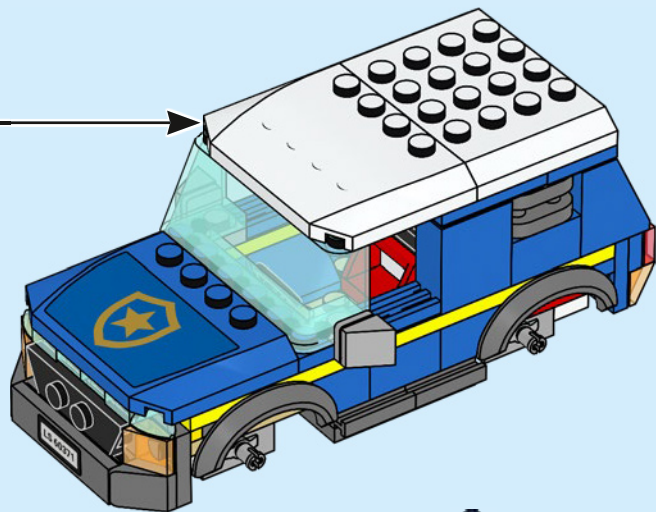

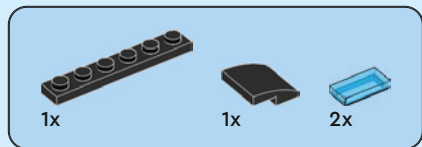

35

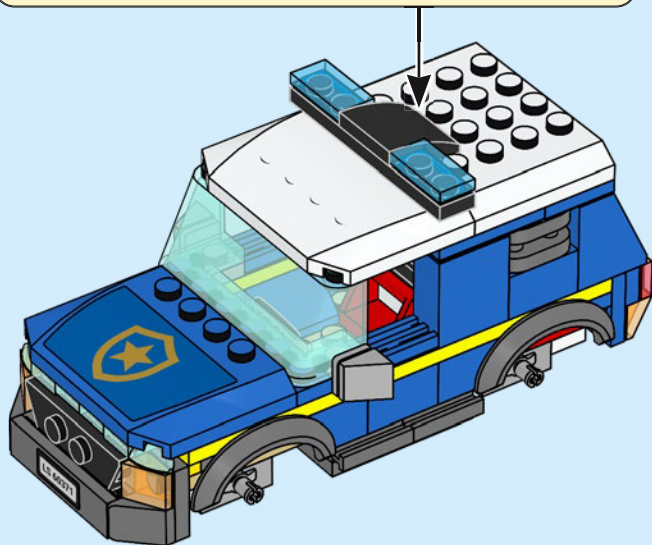
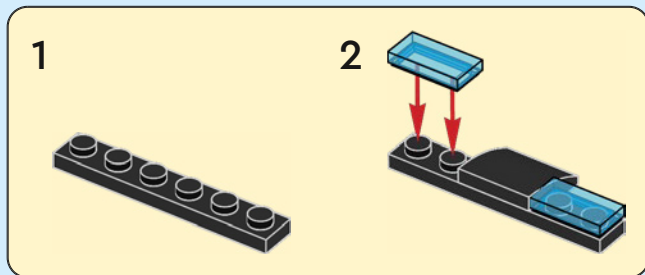



4x



4x

# 36

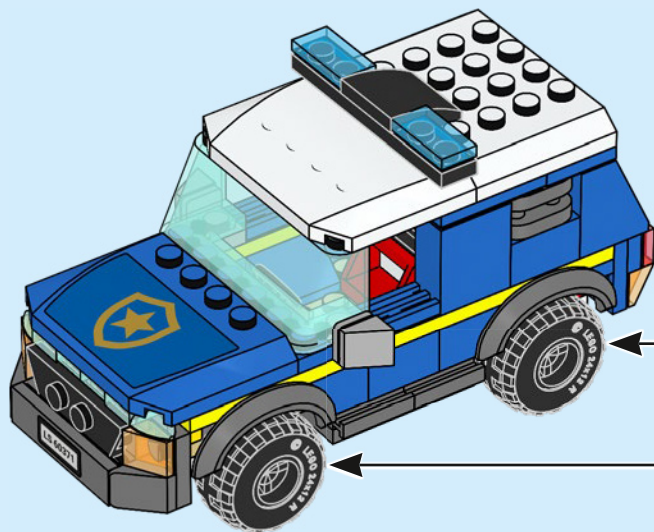

4x





1x

37

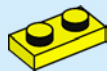

1x



1x

38





1x

39

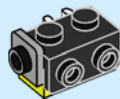

1x



1x

40

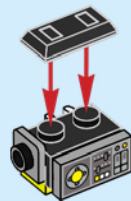



1x



1x

41

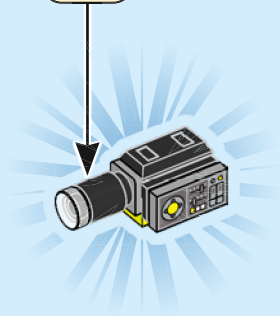
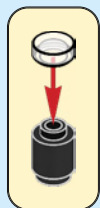

42

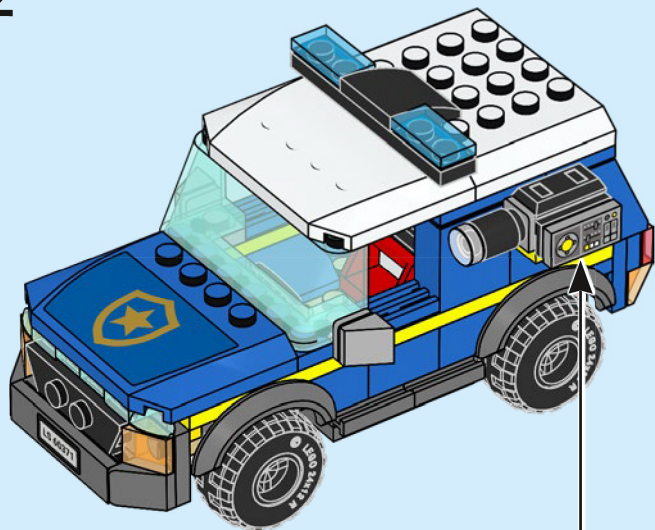

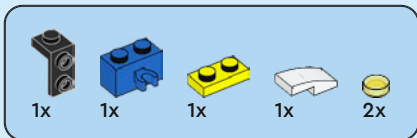

# 43









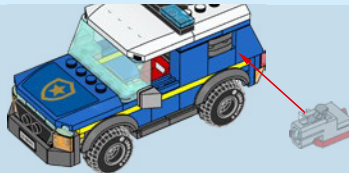
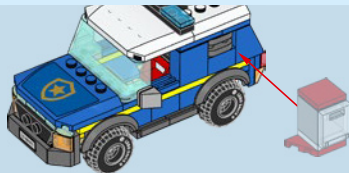
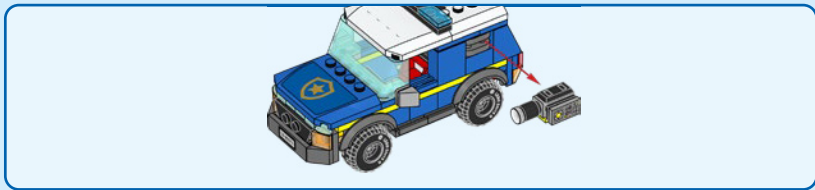

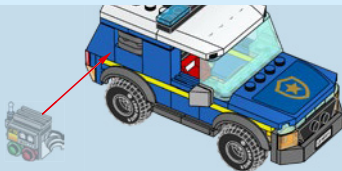
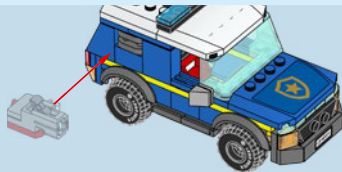
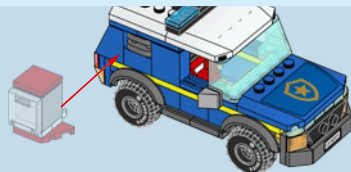
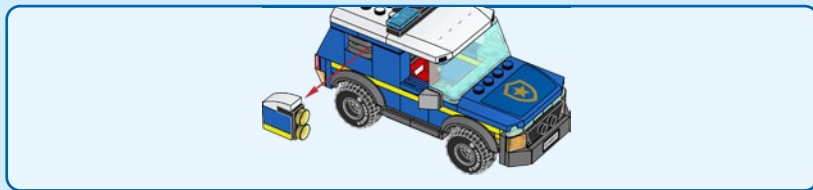



# CITY



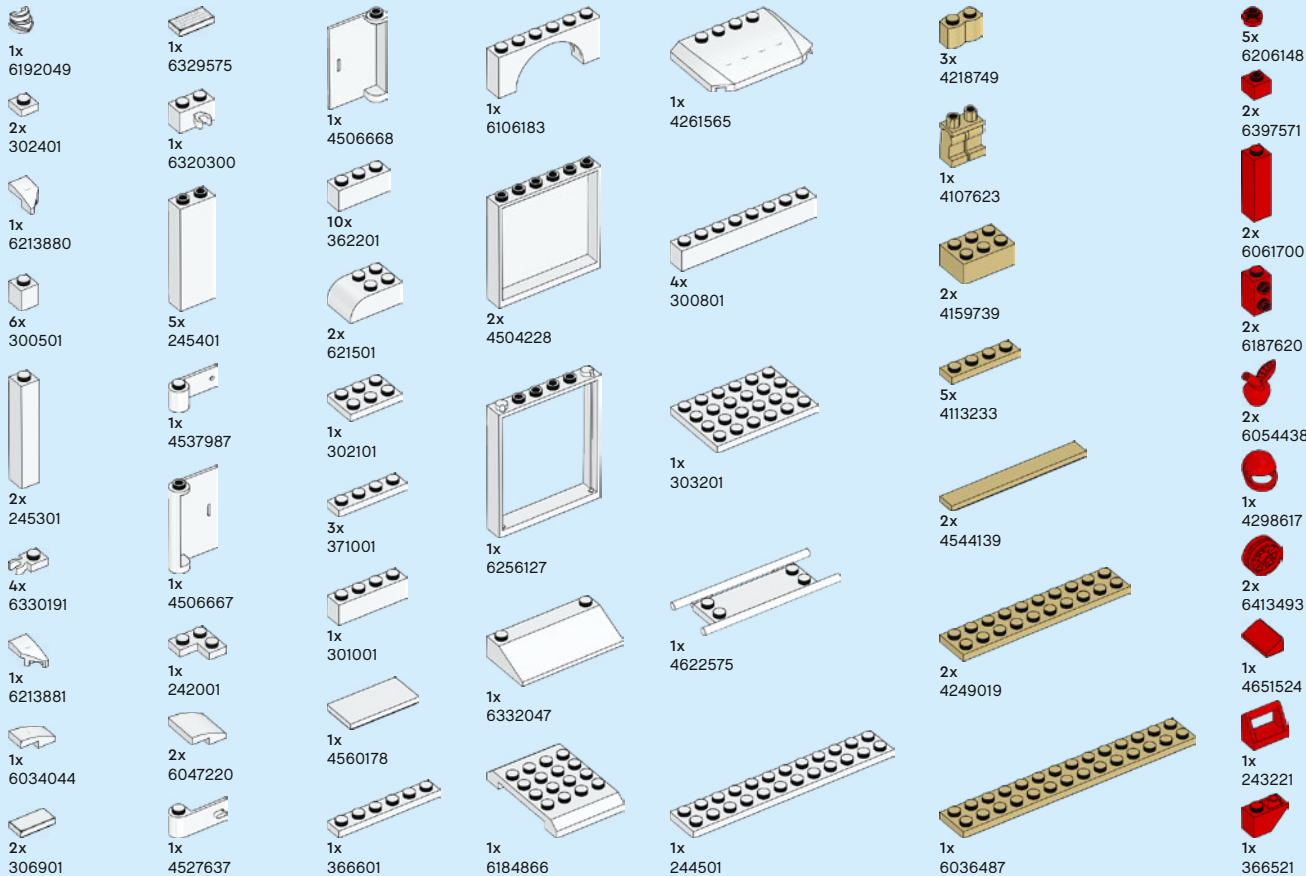



2x  
6252037



1x  
6019155



2x  
6089698



1x  
306821



2x  
242021



1x  
303921



2x  
6061711



1x  
407921



2x  
362321

46



4x  
428621



2x  
6056816



3x  
6023770



3x  
301021



1x  
4633914



1x  
302021



1x  
6275399



1x  
300921



1x  
6381760



4x  
6390262



1x  
6335578



1x  
379521



1x  
6432012



1x  
611121



1x  
6308885



1x  
6378410

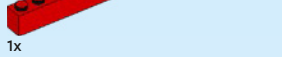

1x  
6378410



2x  
302423



2x  
6432005



2x  
4206482



4x  
241223



4x  
366523



2x  
6133724



2x  
6189189



1x  
407923



1x  
407923



1x  
6335309



1x  
300423



4x  
303923



2x  
6116786



2x  
6129747



1x  
368023



2x  
4587840



1x  
4560180



2x  
366623



2x  
366623



1x  
6331572



1x  
300923



1x  
6102539



1x  
4294739

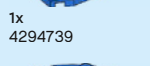

1x  
6432007

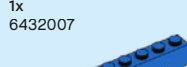

1x  
6057905



1x  
6432006



2x  
9552



1x  
6329589



1x  
6419089



1x  
6419092



1x  
6419093



1x  
6419091



1x  
389924



1x  
6168616



1x  
4164073

1x  
6170421



3x  
6321194



1x  
306226



3x  
4529236



1x  
300526



1x  
307026



1x  
6380236



1x  
6156414



1x  
4157108



3x  
6323189



1x  
4610232



1x  
4161332



4x  
6286850



2x  
4548180



1x  
6143335



1x  
6370669



1x  
6156991



2x  
6092585



1x  
306926



1x  
4539128



1x  
6184784



2x  
6114987



1x  
6016172



2x  
6000650



1x  
6117973



2x  
6064174



3x  
4225201



4x  
6029208



2x  
6266224



1x  
6170693



3x  
6053077



1x  
6192346



1x  
281726



4x  
6371450



2x  
6430580



1x  
4143875



1x  
6332022



4x  
6162541



2x  
408326



2x  
6168620



1x  
4531412



1x  
302126



1x  
4188953



1x  
6280168



1x  
395726



1x  
6324143



1x  
302026



1x  
4560182



6x  
366626



3x  
379526



2x  
6266348

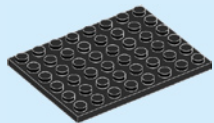

1x  
303626

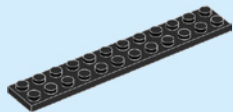

1x  
244526



1x  
6210271



1x  
4295260



1x  
6129807



1x  
6092586



2x  
6268814



7x  
371028

**48**



6x  
6182261



4x  
6141590



2x  
6266964

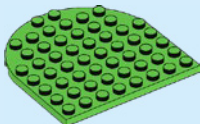

2x  
6378799



1x  
6432298



1x  
6430528



2x  
6274740



2x  
6251291



1x  
6274738



1x  
6244787



1x  
6247357



4x  
6208450



2x  
6254248



2x  
6250158



1x  
6390369



4x  
6274739



1x  
6238677



4x  
6292200



2x  
6244910



4x  
6253230



1x  
6240222



2x  
6252048



2x  
6370306



2x  
6252049



1x  
6253682



1x  
6240515



1x  
6240515



1x  
6240515



1x  
6240515

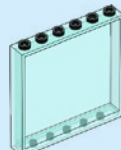

1x  
6245257



1x  
6245193



1x  
6255920

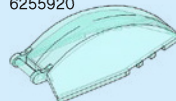

1x  
6301841



1x  
6214234



2x  
4159007

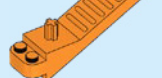

1x  
6240515



3x  
6240221



2x  
6252044



2x  
6245256



4x  
6251289



4x  
6240215



2x  
6278172



1x  
6213777



3x  
6217659



4x  
6328953



2x  
6399564





6x  
6428472



2x  
6393823



4x  
6430579



2x  
6217660



1x  
6223065



1x  
6331421



1x  
6251830



3x  
6209692



1x  
4220631



1x  
6092591



2x  
4626904



1x  
4550329



1x  
6056241



1x  
4162916



2x  
6331694



4x  
6167741



4x  
6245265



2x  
6171727



1x  
4650622



1x  
4206504



2x  
6092035



1x  
6096091



2x  
4622062



2x  
6133805



1x  
4226966



2x  
4270470



1x  
4211200



2x  
6055086



1x  
4211194



1x  
4221775



2x  
4521921



3x  
6258831



2x  
6278156



3x  
4211389



3x  
6335328



1x  
6430540



2x  
6296894



1x  
6329152



1x  
4540203



2x  
4211512



3x  
4211383



1x  
6329662



2x  
6329585



4x  
6029209



3x  
6337268



1x  
4641048



2x  
6266231



4x  
6371448



1x  
6212077



3x  
6065824



3x  
6326478



2x  
6360382



2x  
6267142



1x  
4211491



2x  
6171894



1x  
4211386



20x  
6257593



2x  
6057449



2x  
6262961



1x  
6349780



6x  
4211549



2x  
6163989

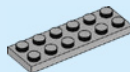

1x  
4211452

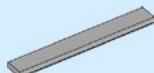

4x  
4211481

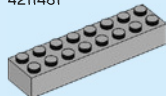

1x  
6037399



1x  
4166618

50

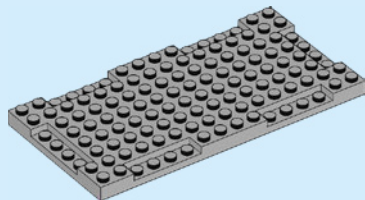

2x  
6417816

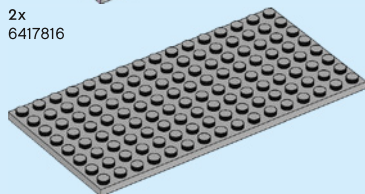

1x  
4598522



1x  
6361949



1x  
6252270



2x  
6360675



7x  
6390673



3x  
6221607



1x  
4222693



2x  
6069164



8x  
6092572



1x  
4211052



2x  
6029948



2x  
4211039



4x  
4543086



1x  
4211094



2x  
4211055



2x  
6313189



2x  
4211054



2x  
4218696



4x  
4211133



1x  
4211064



1x  
6395363



4x  
6170503



5x  
4211053



4x  
4560184



1x  
4211095



1x  
6413109



3x  
4211056

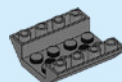

1x  
4658974



1x  
6401210



1x  
4211002

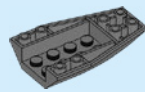

1x  
4636417

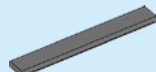

2x  
4211008



1x  
4211115



2x  
6311001

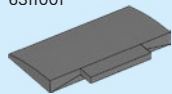

2x  
6325420

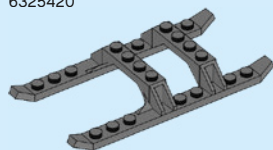

1x  
6259802

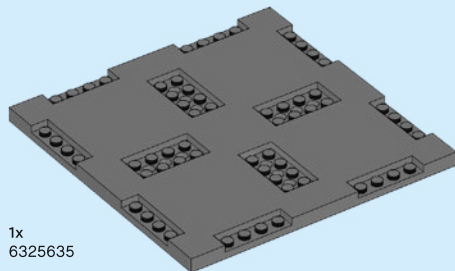

1x  
6325635



4x  
4633691



19x  
4619636



2x  
6158368



1x  
6223733



1x  
6097042



1x  
6152450



1x  
6378271



8x  
6382324



10x  
6392235



3x  
6380131



2x  
6380125



2x  
6380691



1x  
6381735



8x  
6381739

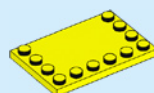

2x  
6383021

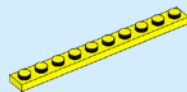

2x  
6377930



4x  
6057986



2x  
4656783



2x  
6022004



6x  
6055309



LEGO.com/service



YOU COULD **WIN**



Scan this QR code or go to **LEGO.COM/PRODUCTFEEDBACK** and give us your short feedback about this LEGO® set for a chance to win a cool LEGO prize.

Terms and Conditions apply\*



**DE: Du könntest GEWINNEN.** Es gelten die Teilnahmebedingungen\* **FR: Tu pourrais GAGNER.** Des conditions s'appliquent\* **IT: Potresti VINCERE tu.** Termini e condizioni sono applicabili\* **ES: Puedes GANAR.** Aplican términos y condiciones\* **PT: Poderá GANHAR.** Aplicam-se termos e condições\* **JA: プレゼント付き! 利用規約が適用されます\*** **ZH: 轻松获奖. 条款和条件适用\*** **KO: 상품의 주인이 되어보세요. 소정의 약관이 적용됩니다\*** **RU: Вы можете ВЫИГРАТЬ.** Действуют положения и условия\* **PL: Szansa na WYGRANĄ.** Obowiązują warunki korzystania\* **CS: Máte šanci VYHRÁT.** Platí všeobecné smluvní podmínky\* **SK: Máte šancu VYHRAŤ.** Platia všeobecné zmluvné podmienky\* **HU: TE IS NYERHETSZ.** Felhasználási feltételek érvényesek\* **RO: Ai putea CÂȘTIGA.** Se aplică termenii și condițiile\* **BG: Можете да СПЕЧЕЛИТЕ.** Има определени правила и условия\* **LV: Tu vari LAIMĒT.** Ir spēkā noteikumi un nosacījumi.\* **ET: Sul on võimalus VÕITA.** Kehtivad tingimused\* **LT: Jūs galite LAIMĖTI.** Taikomos sąlygos\*  
\*LEGO.com/productfeedback-terms