



Disney

43229





Get excited about our new packaging!

We're switching from plastic to paper-based packaging. That's why you might find a mix of paper and plastic in our boxes!

Nos nouveaux emballages vous emballeront !

Nous passons des emballages en plastique aux emballages à base de papier. C'est pourquoi vous pourriez trouver un mélange de papier et de plastique dans nos boîtes !

¡Te presentamos nuestros nuevos empaques!

Estamos sustituyendo las bolsas de plástico por bolsas con base de papel. ¡Por eso, puedes encontrar una mezcla de papel y de plástico en nuestras cajas!

[LEGO.com/sustainable-packaging](https://www.lego.com/sustainable-packaging)

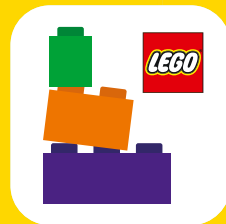

BUILDER



Apple and the Apple logo are trademarks of Apple Inc., registered in the U.S. and other countries and regions. App Store is a service mark of Apple Inc. Google Play and the Google Play logo are trademarks of Google LLC. Tencent and the Tencent logo are trademarks of Tencent Inc.

Q LEGO.com/devicecheck

EN Ask parents' permission before going online | DE Eltern um Erlaubnis bitten, bevor du online gehst | FR Demande l'autorisation d'un parent avant d'aller en ligne | IT Chiedi il permesso ai tuoi genitori prima di andare online | ES Pídeles permiso a tus papás antes de conectarte a Internet | PT Peça autorização aos pais antes de acederes online | ZH 上网前应先征得父母的同意 | PL Poproś rodziców o zgodę, zanim wejdziesz do Internetu | CS Než půjdeš na internet, požádej rodiče o svolení | SK Skôr než půjdeš na internet, vypýtaj si povolenie od rodičov | HU Kérj szülői engedélyt, mielőtt online csatlakoznál! | RO Cere permisiunea părinților înainte de a te conecta online | BG Поискайте разрешение от родител, преди да влезете онлайн | LV Pirms došanās tiešsaistē palūdz atļauju vecākiem | ET Enne Interneti kasutamist küsi vanematelt luba | LT Prieš prisijungdami prie interneto, atsiklauskite tėvų

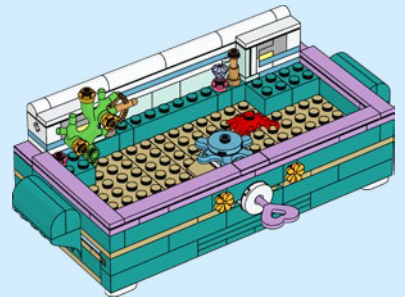
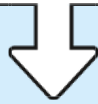
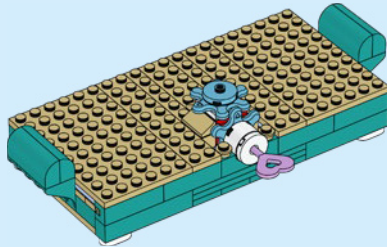
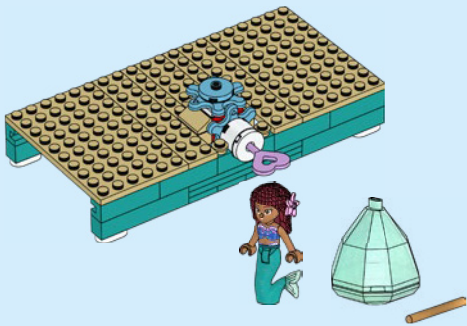
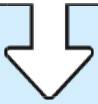

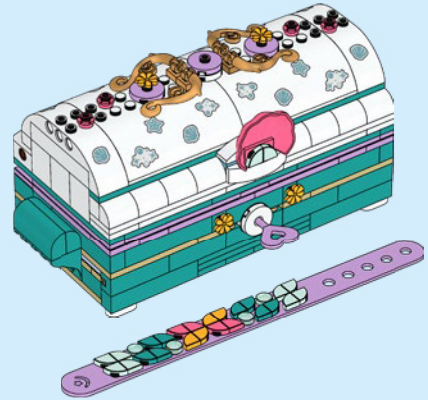
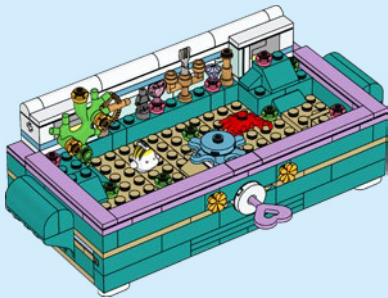
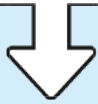

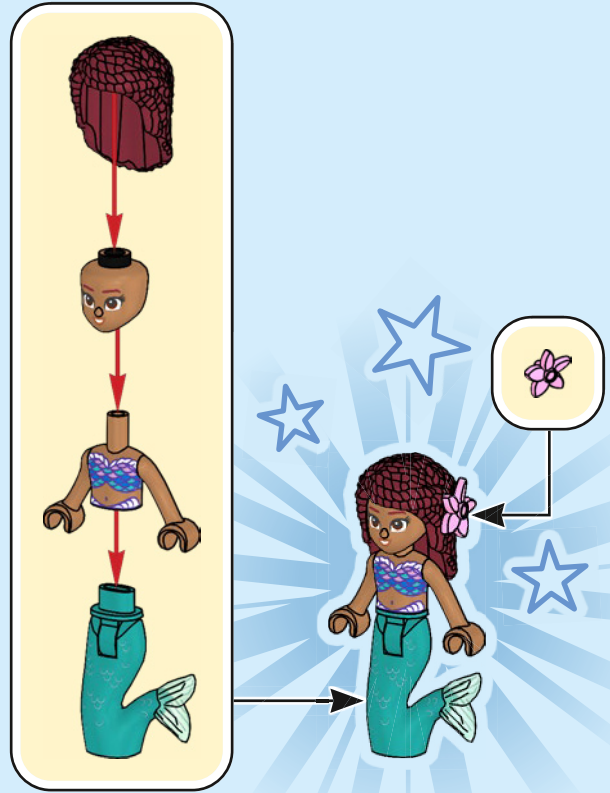

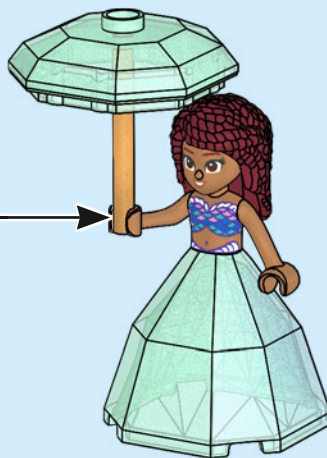
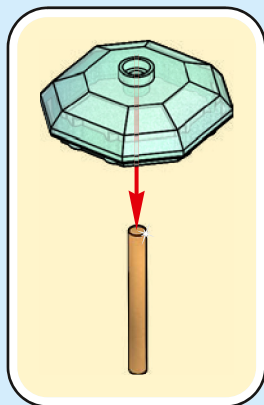
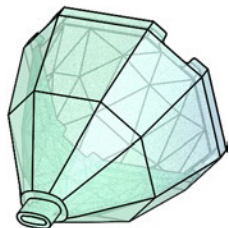

1

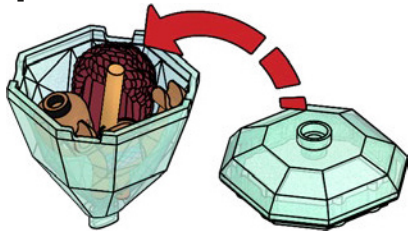

2

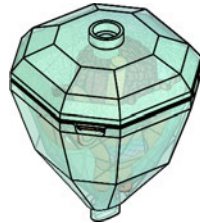

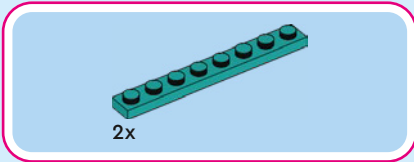
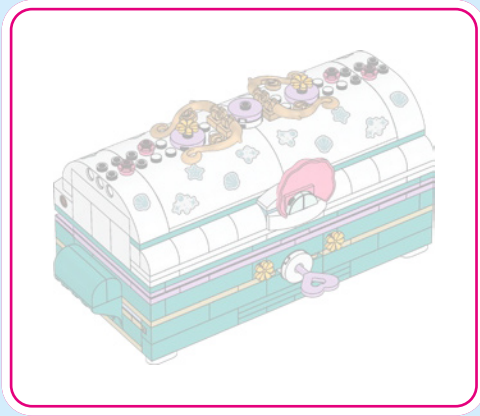

2x

1

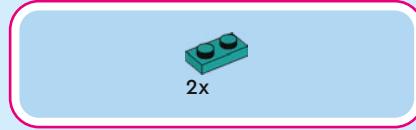
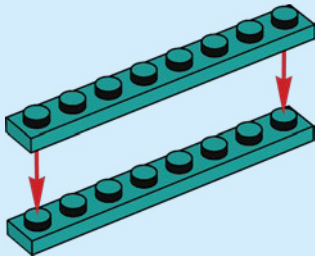

2x

2

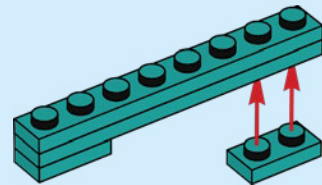

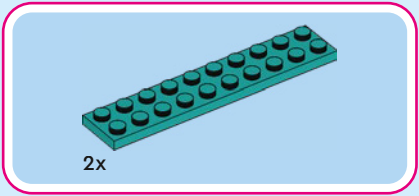

3

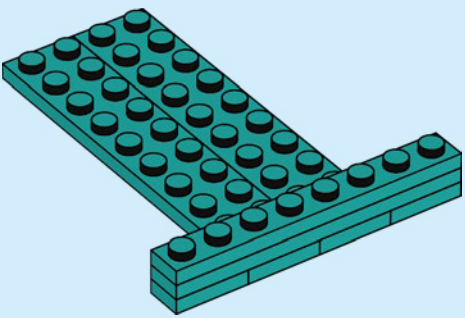

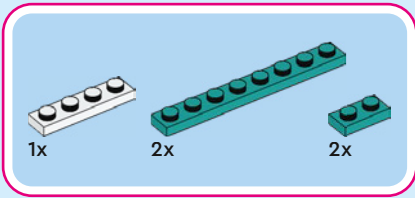

4

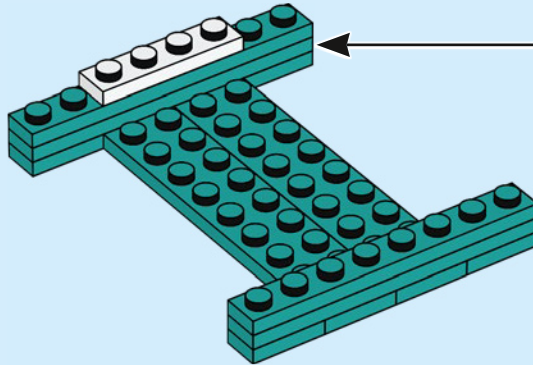
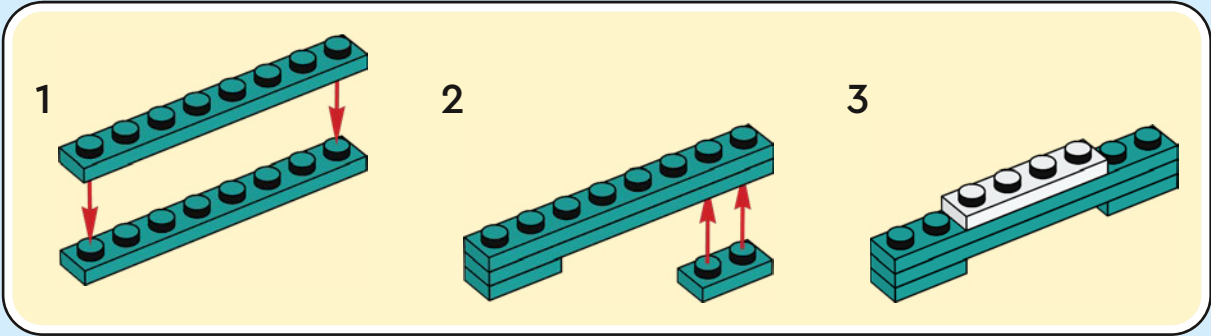

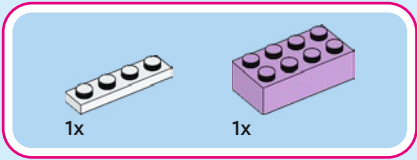

5

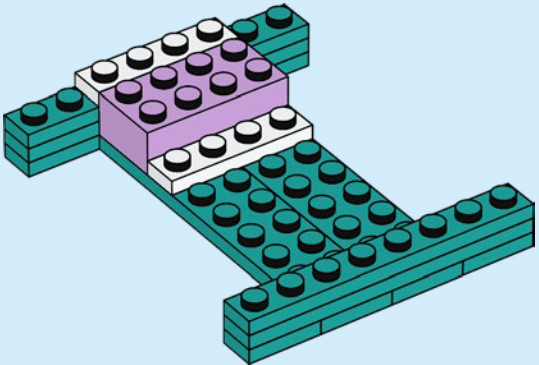



6

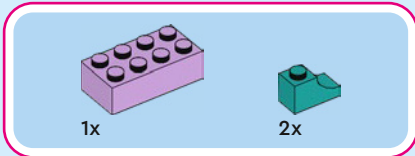
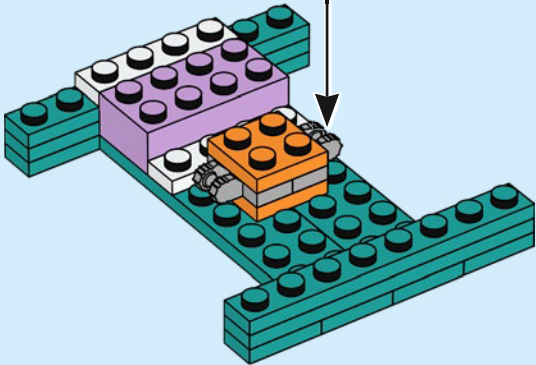
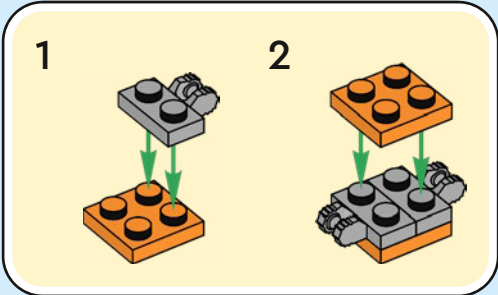

7

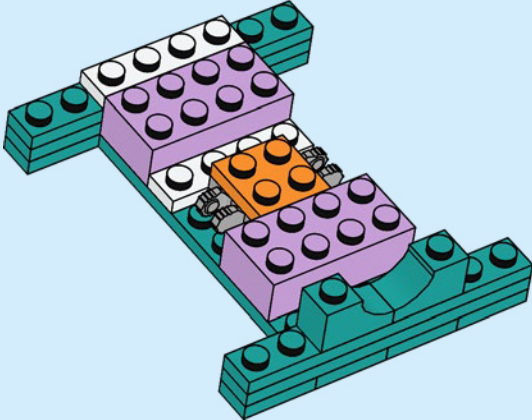

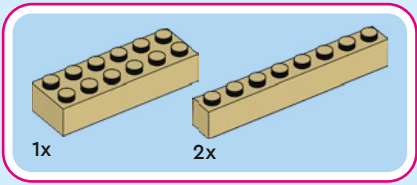

8

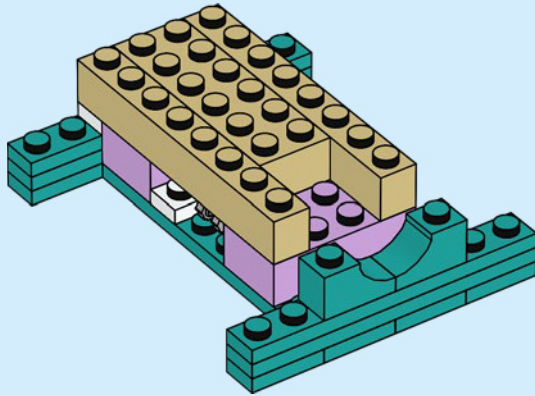

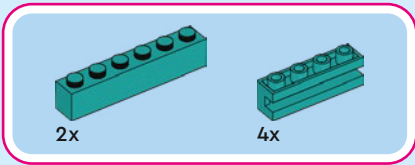

9

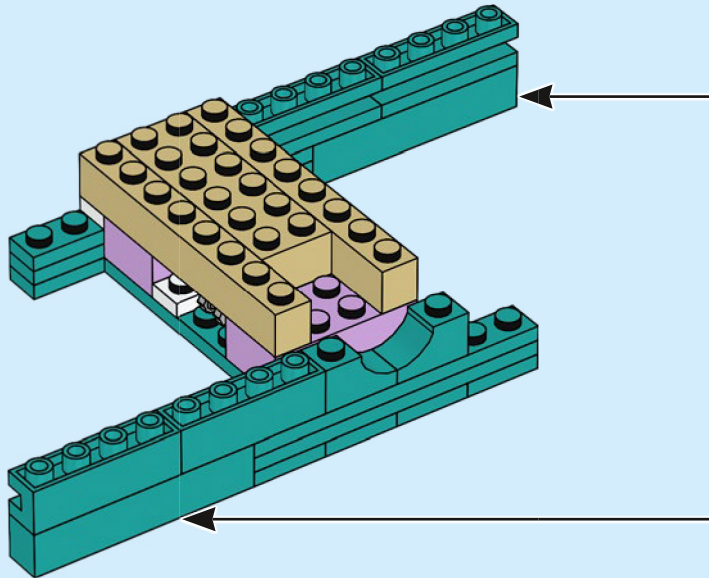
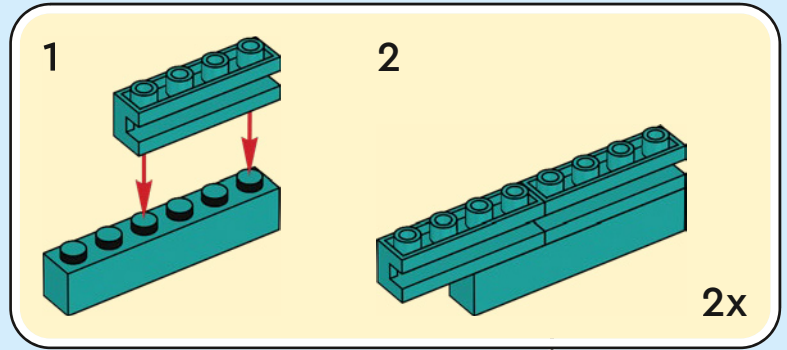

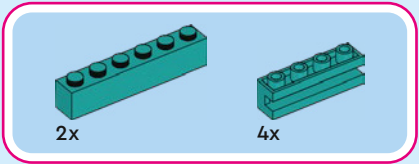

10

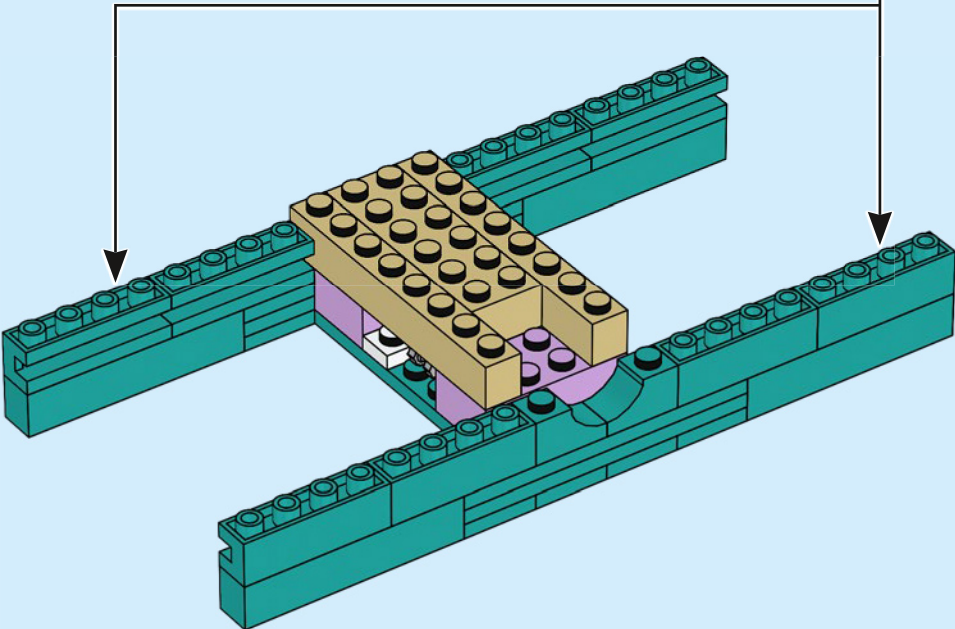
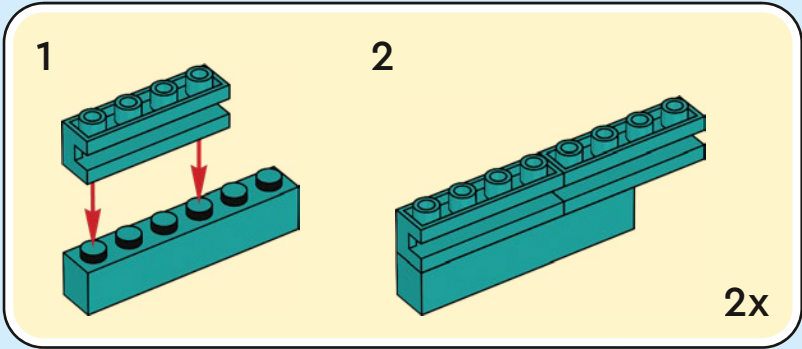



6x

11

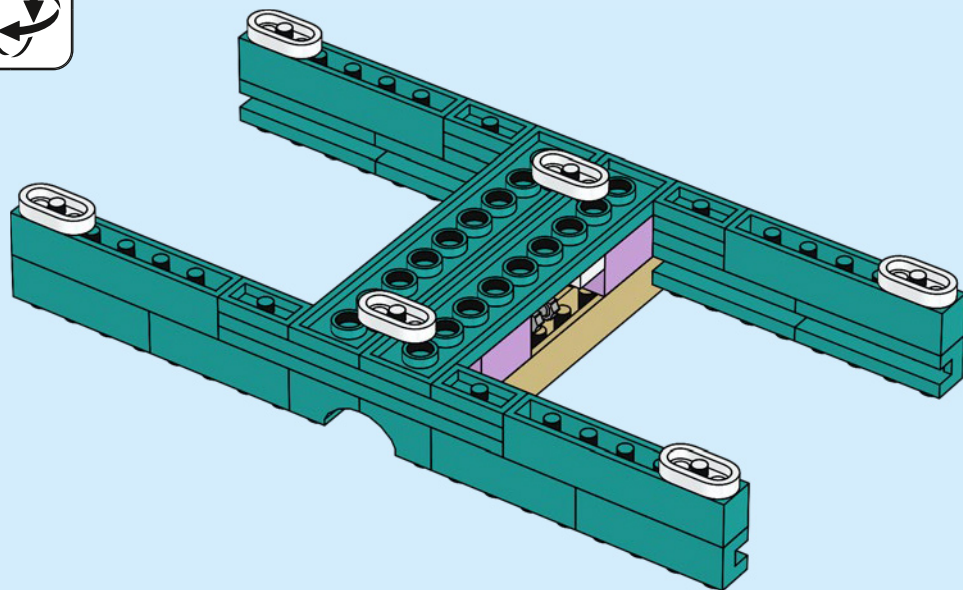

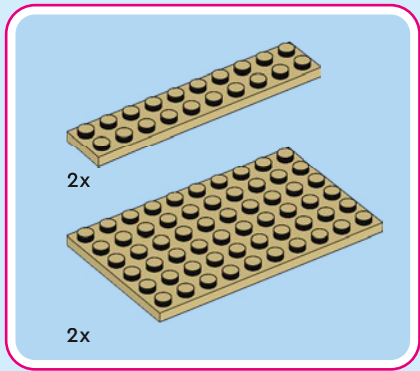

12

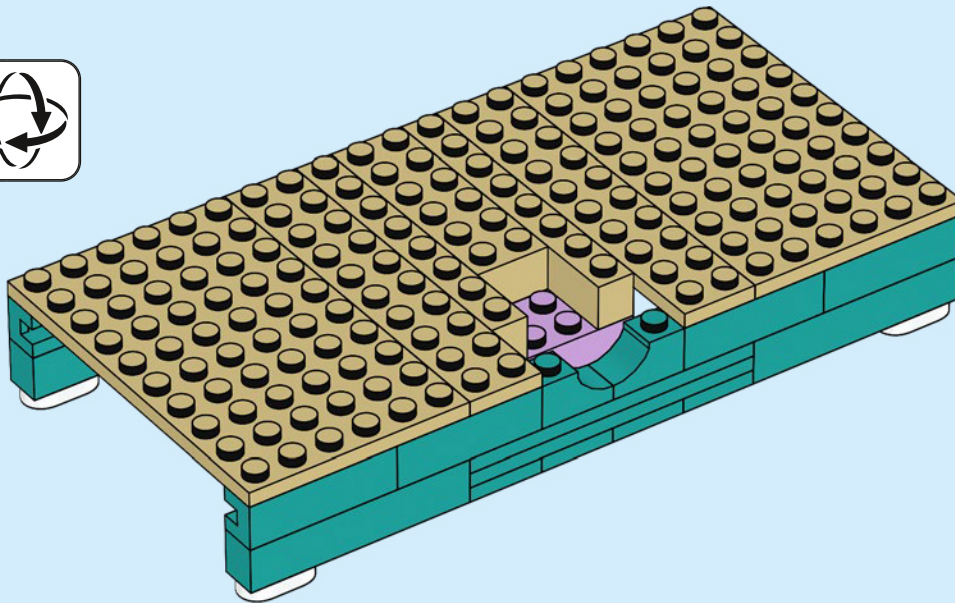
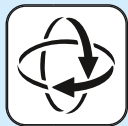



2x



3x

13

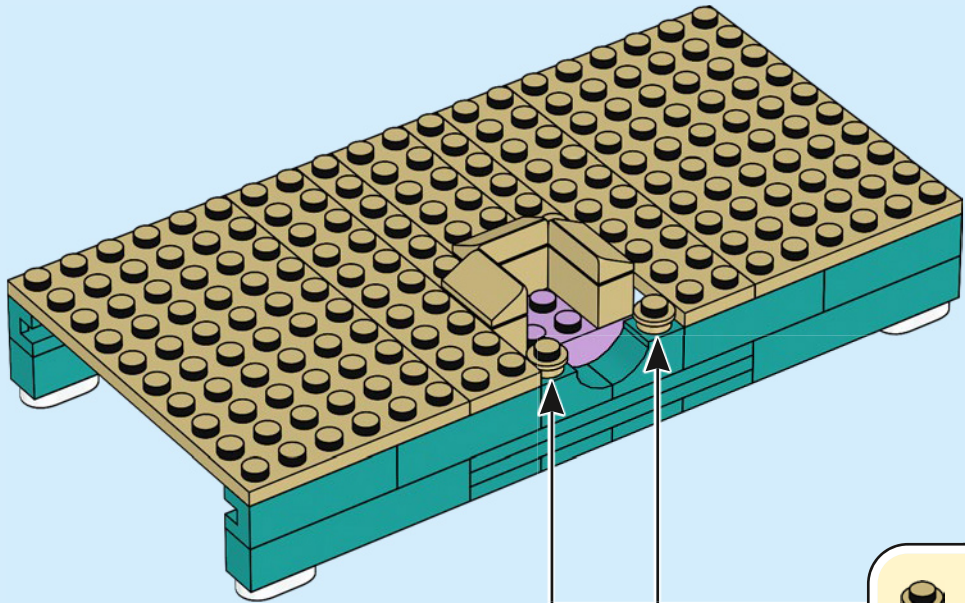

2x



1x

14

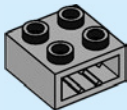

1x



1x

15

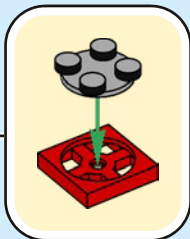

1x

16



1x



1x

17

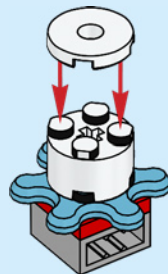

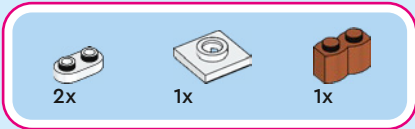

18

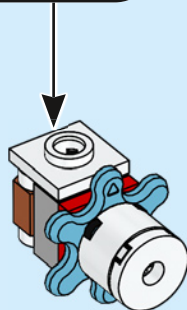
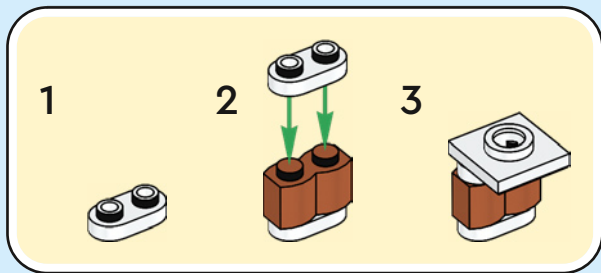

19

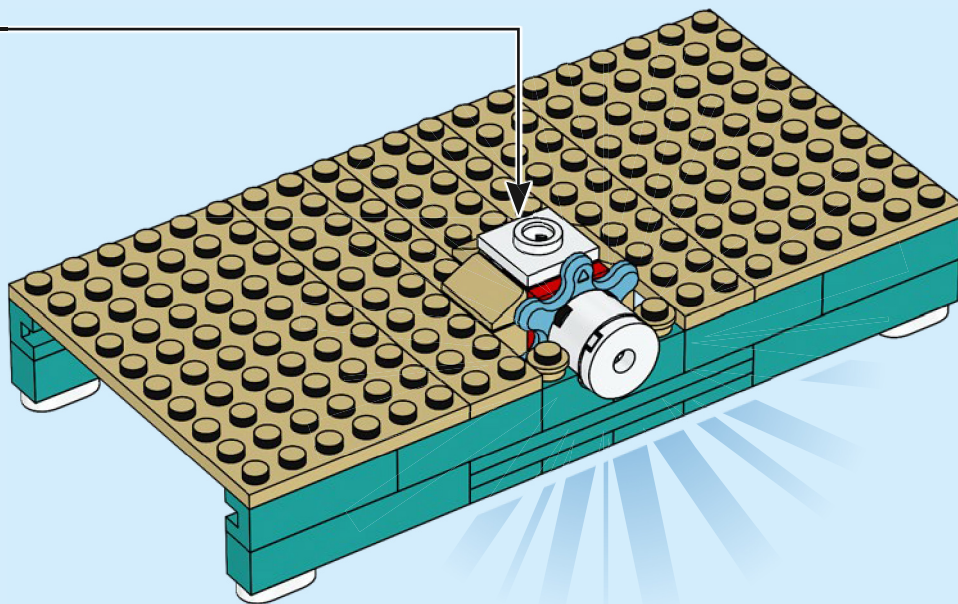

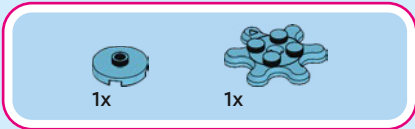

20

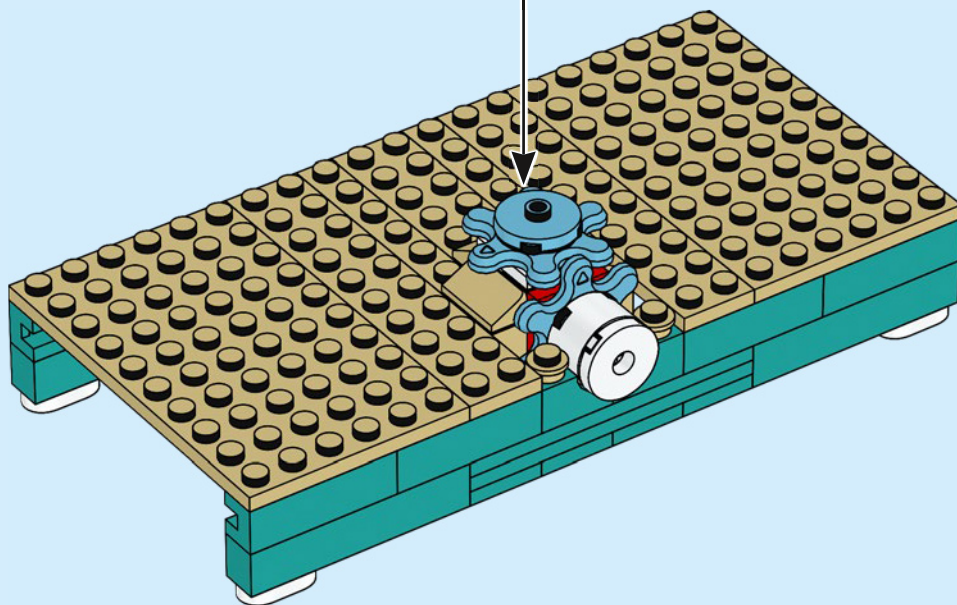
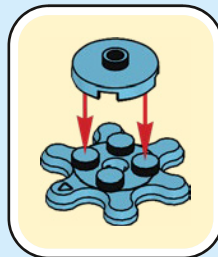

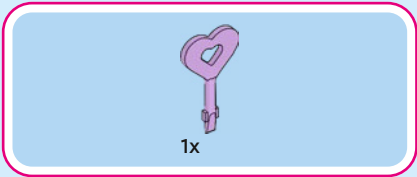

21

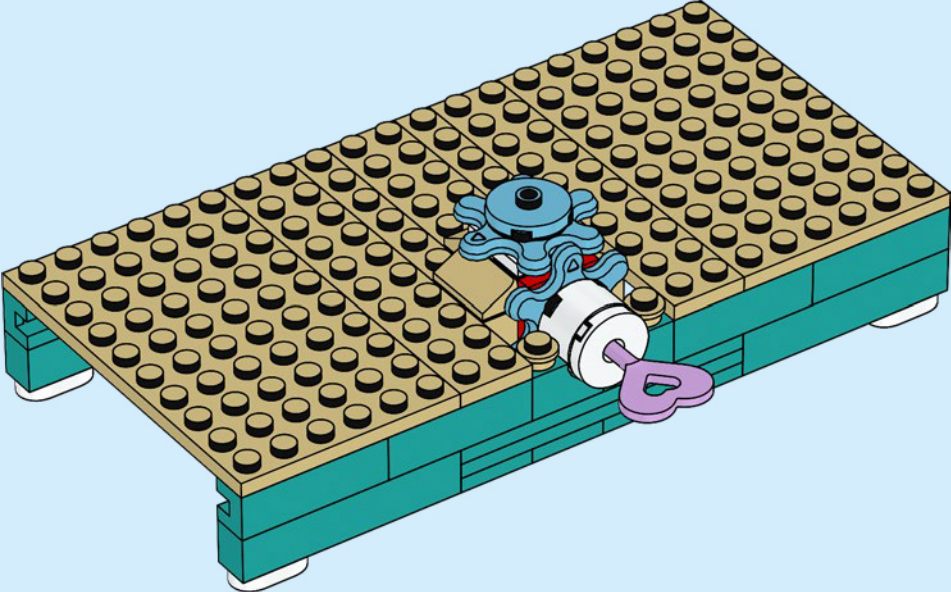
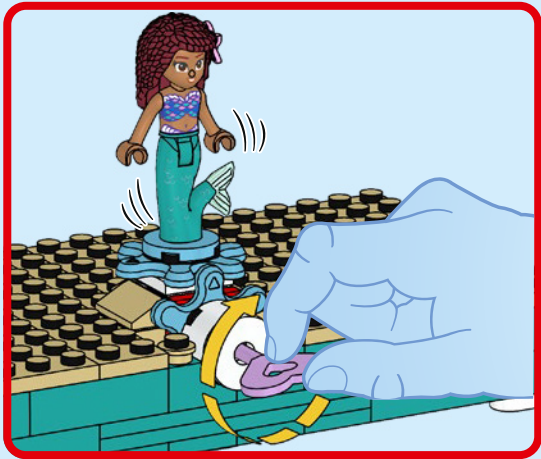

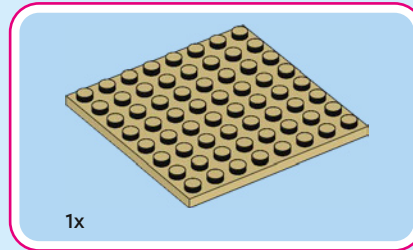
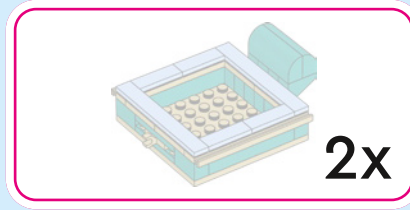

22

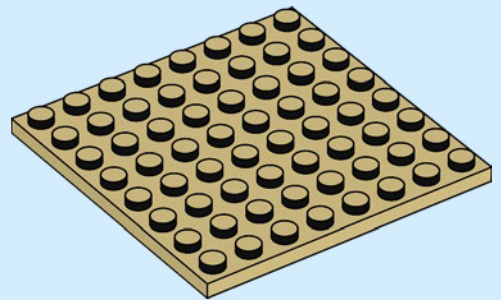

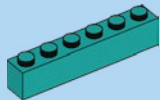

2x

23

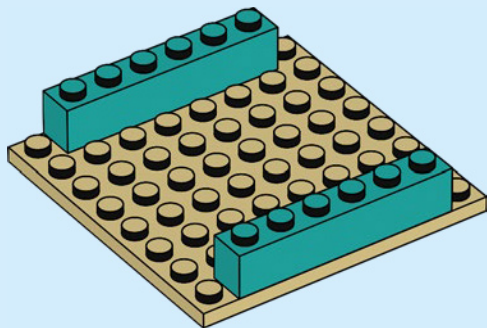

4x

24

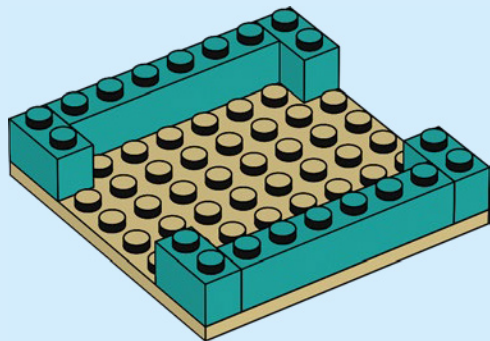

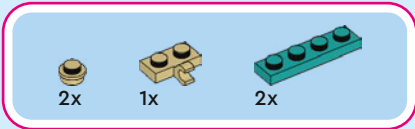

25

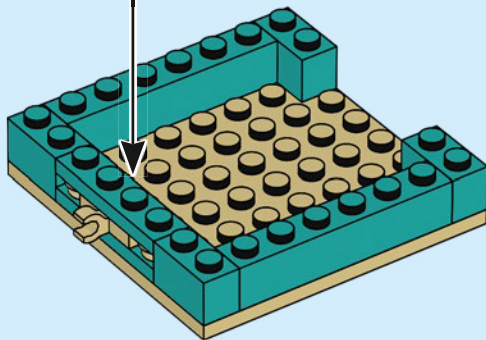
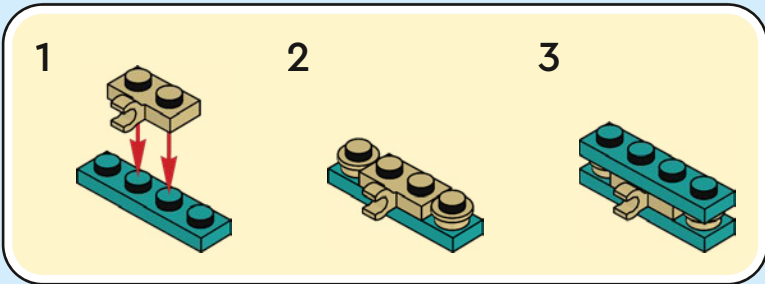

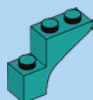

4x

26

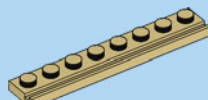
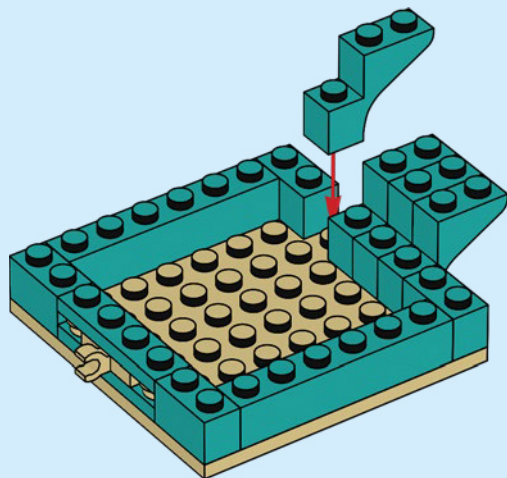

2x

27

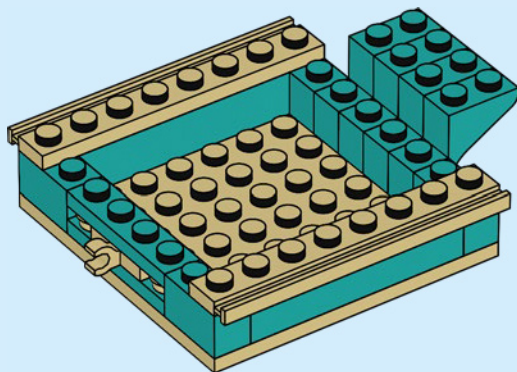

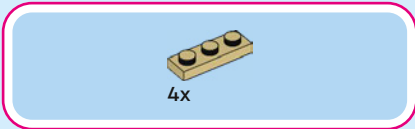

28

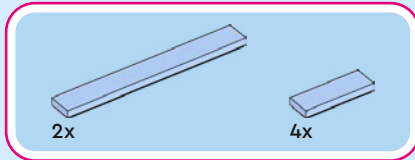
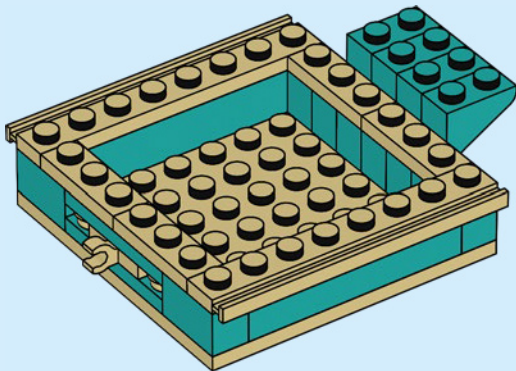

29

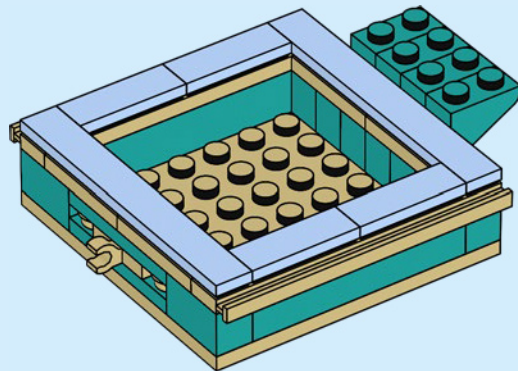



4x

30

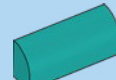
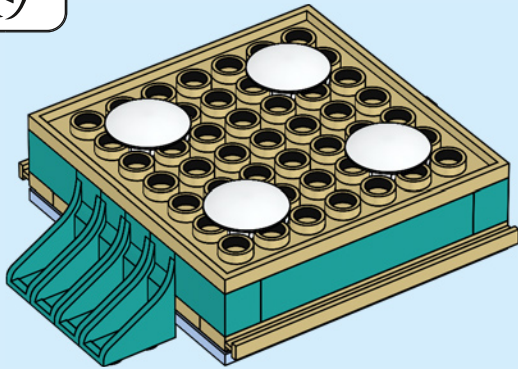

2x

31

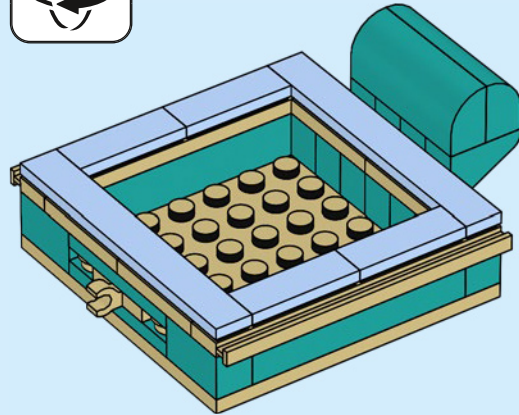

2x



32

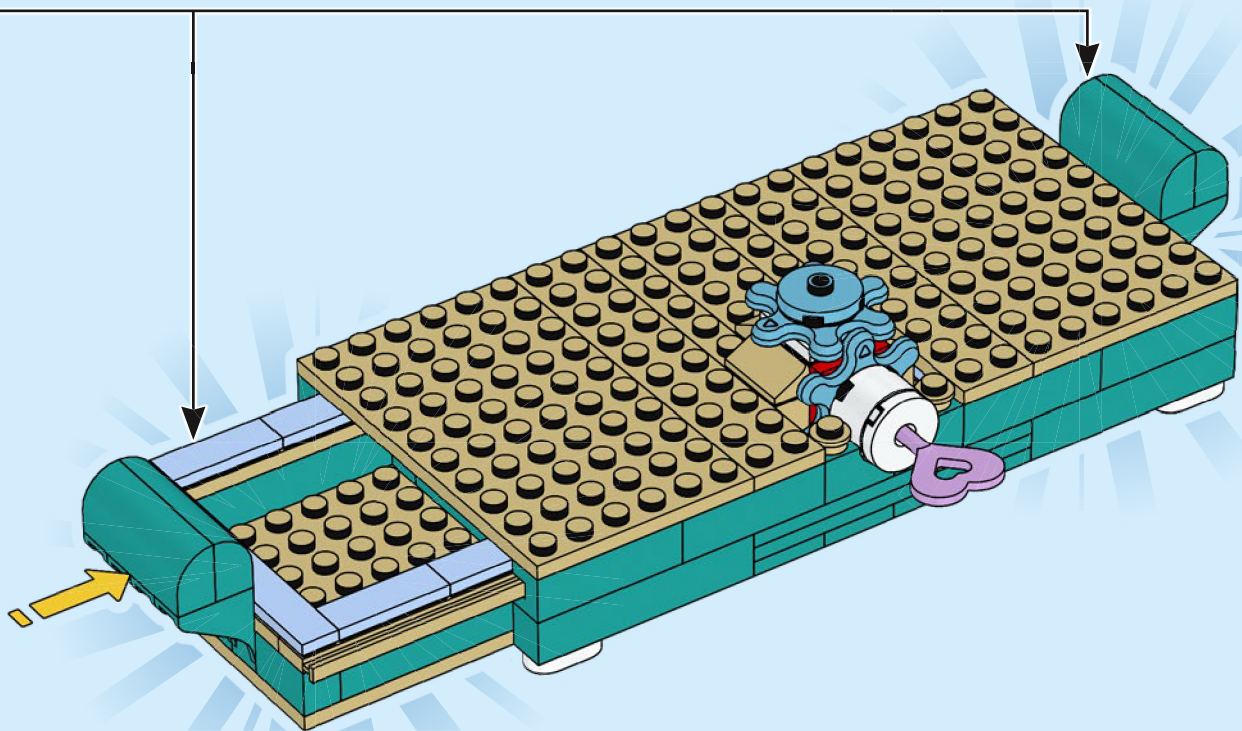

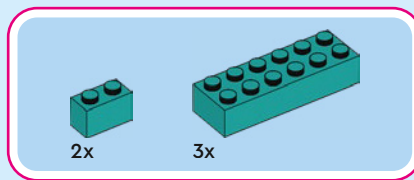

33

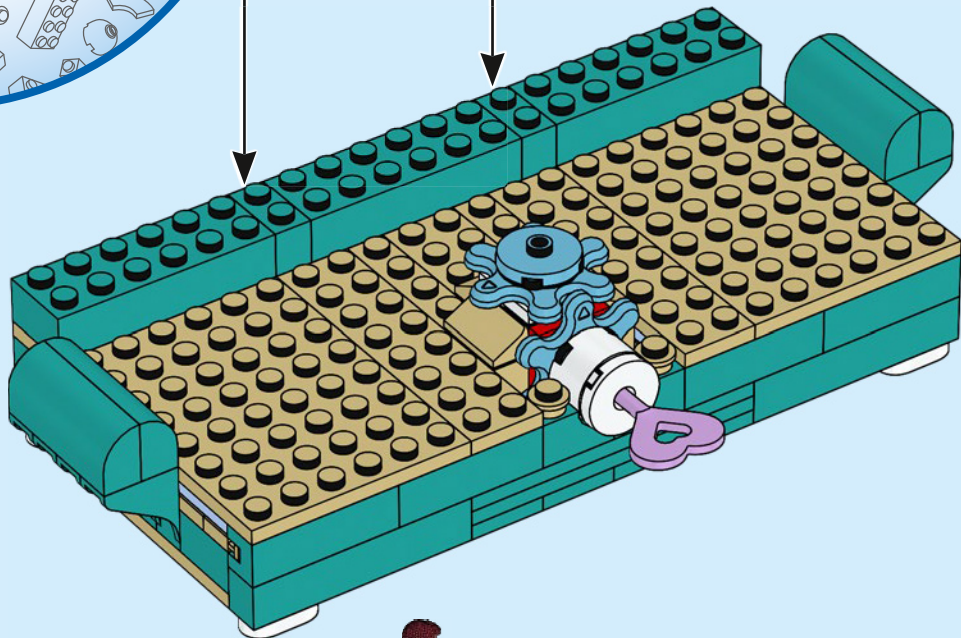
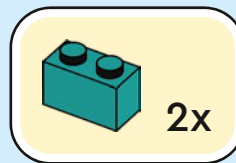

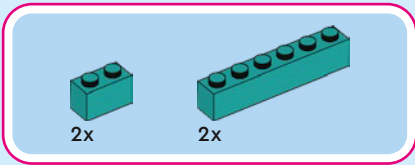

34

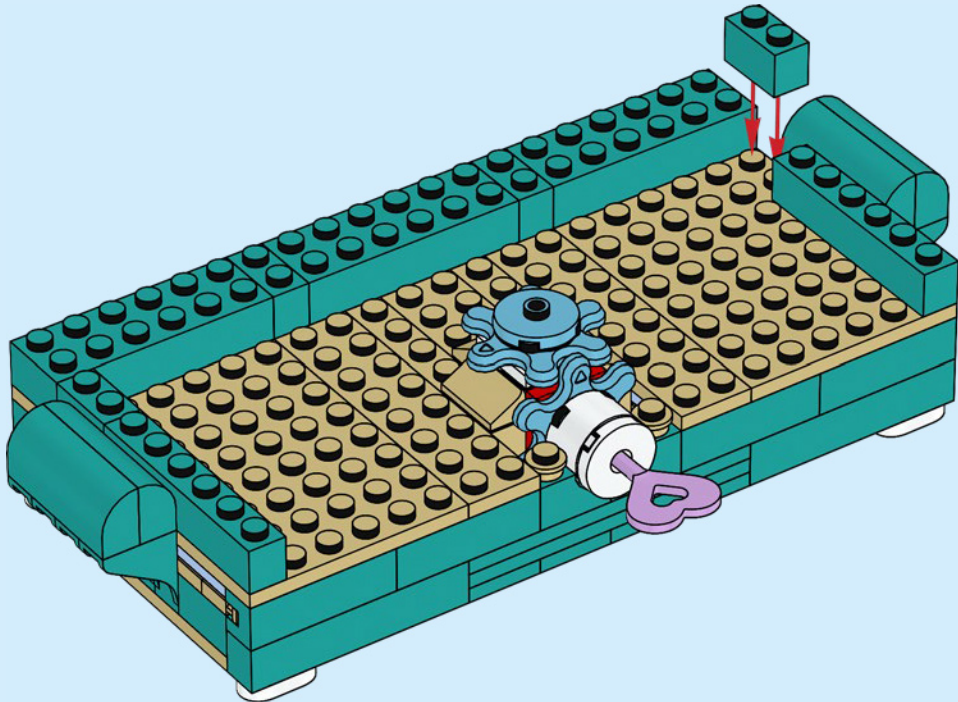

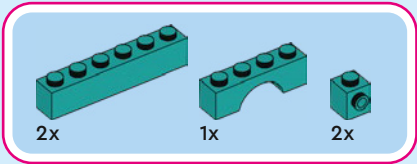

35

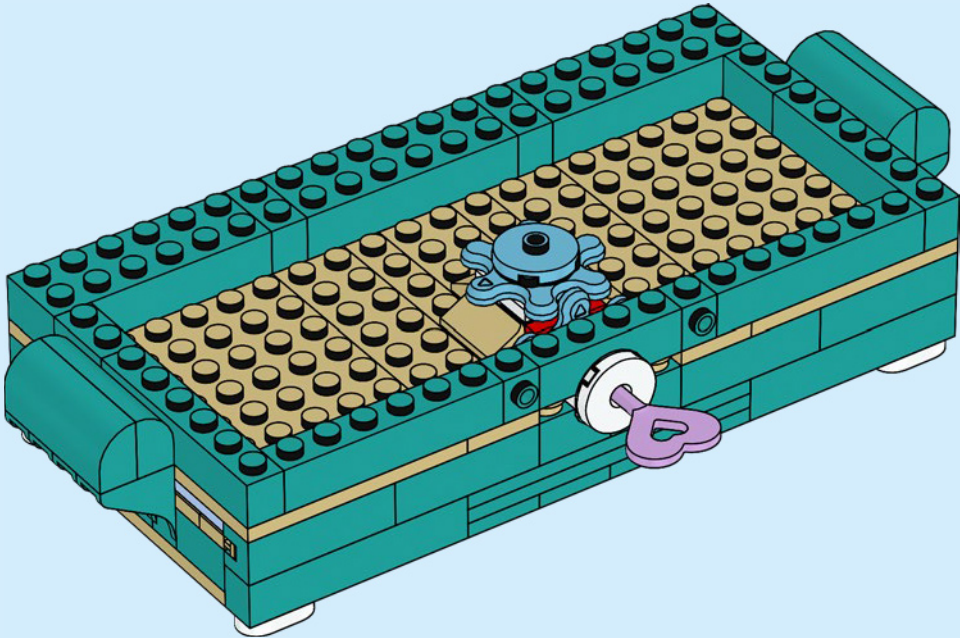

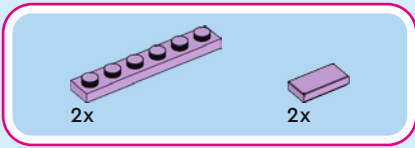

36

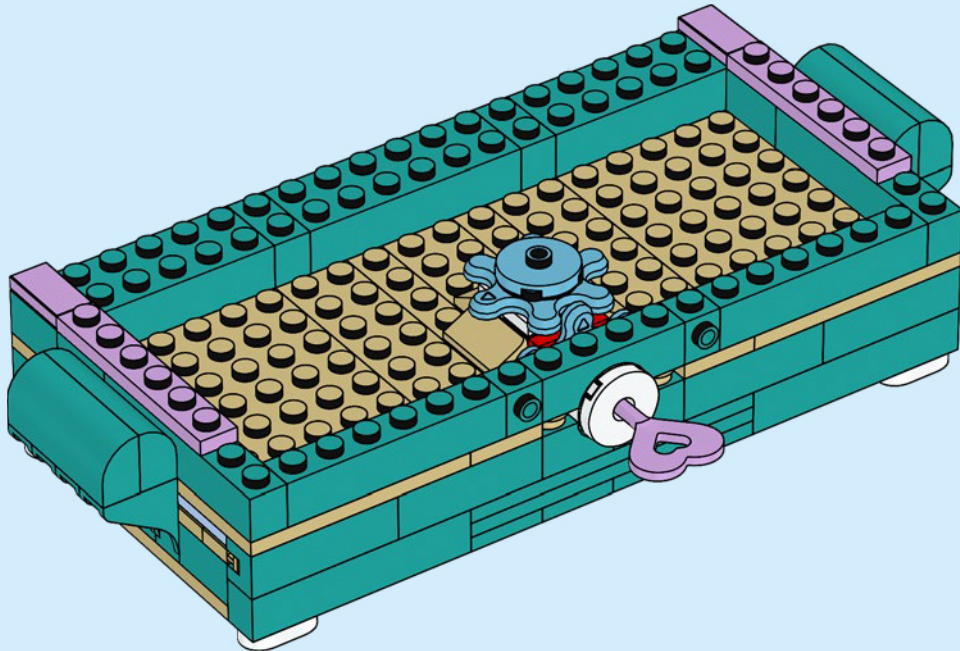

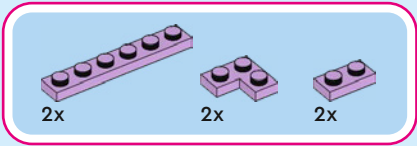

37

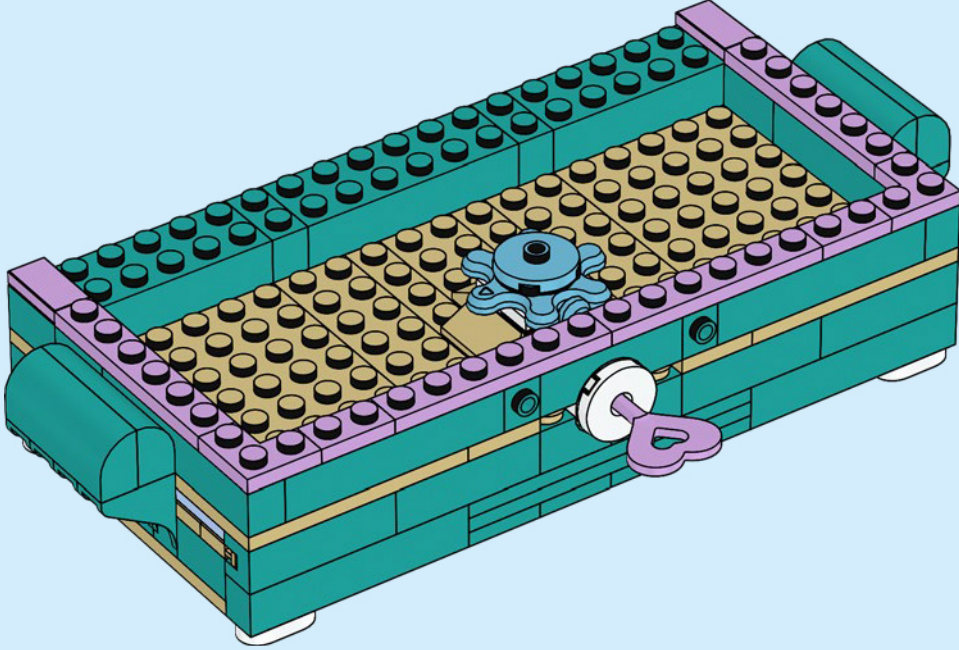



2x



2x

38

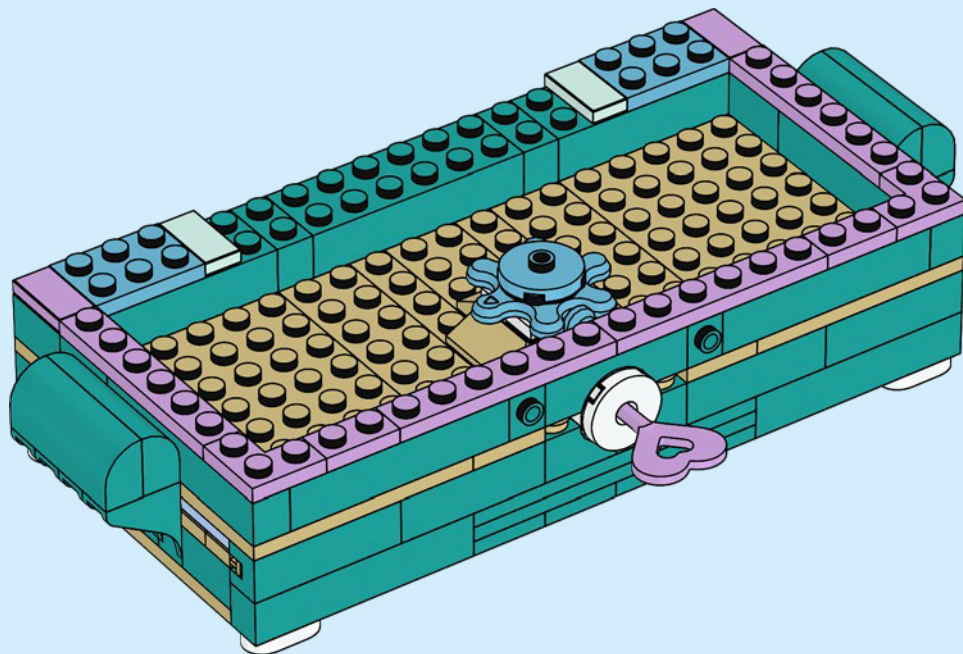



3x

39

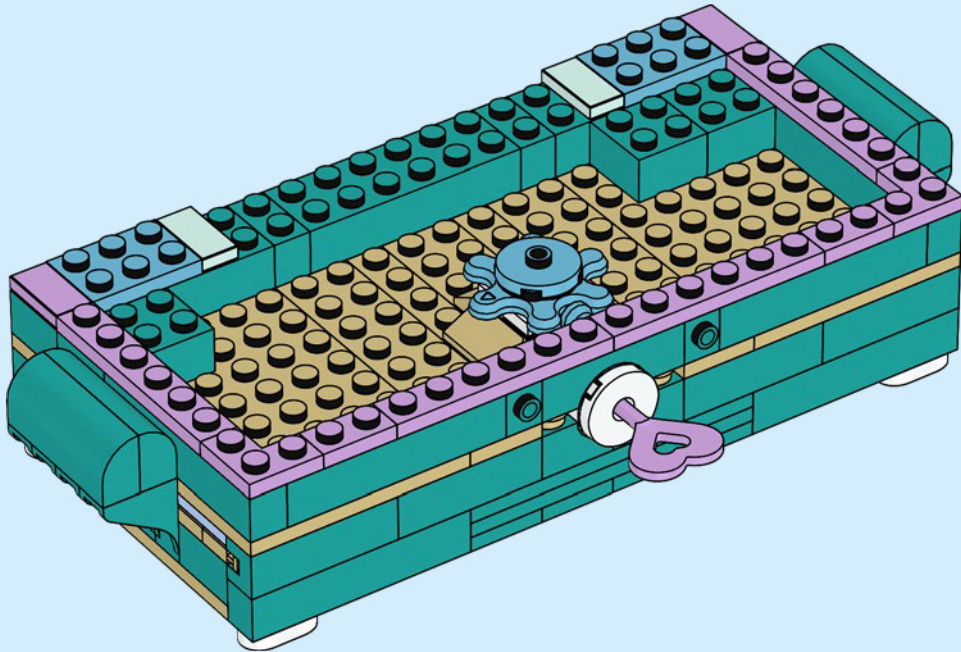



1x

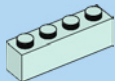

2x

40

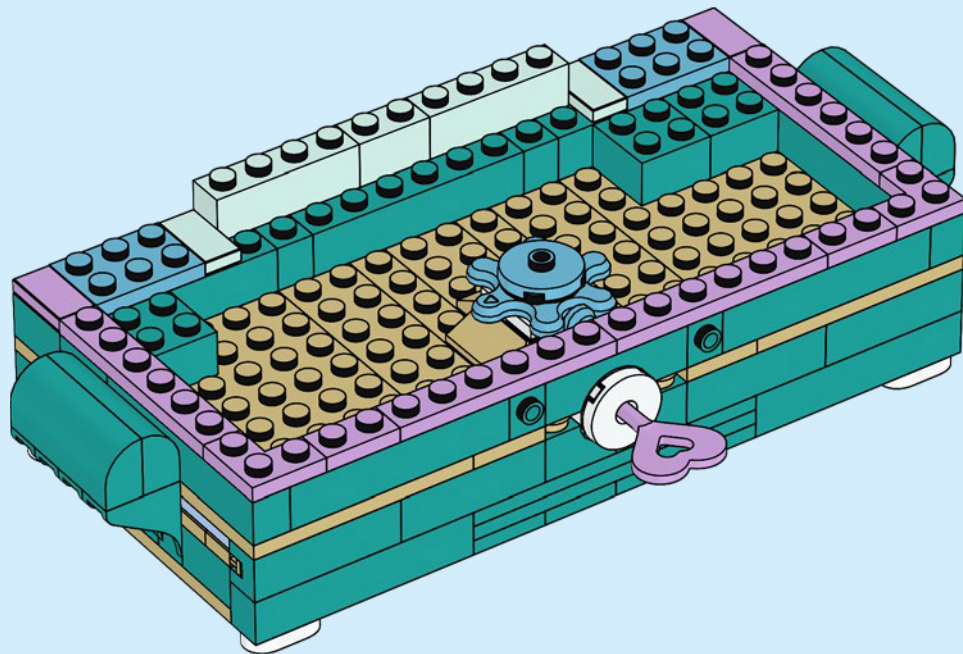

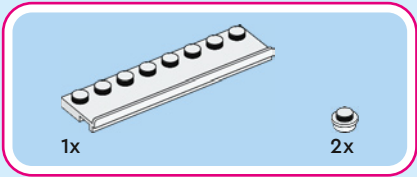

41

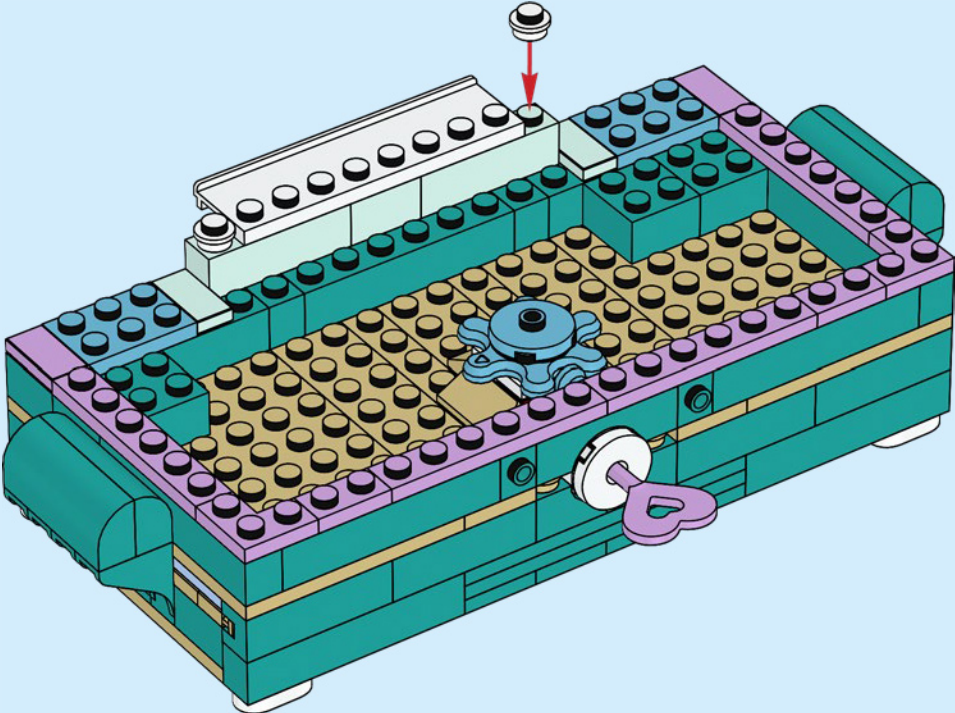

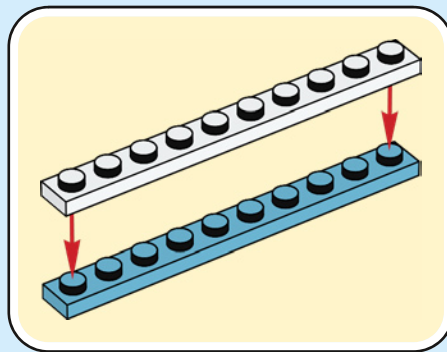
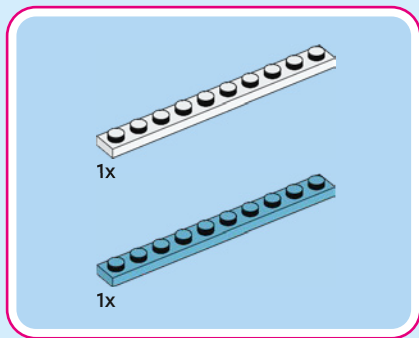

42

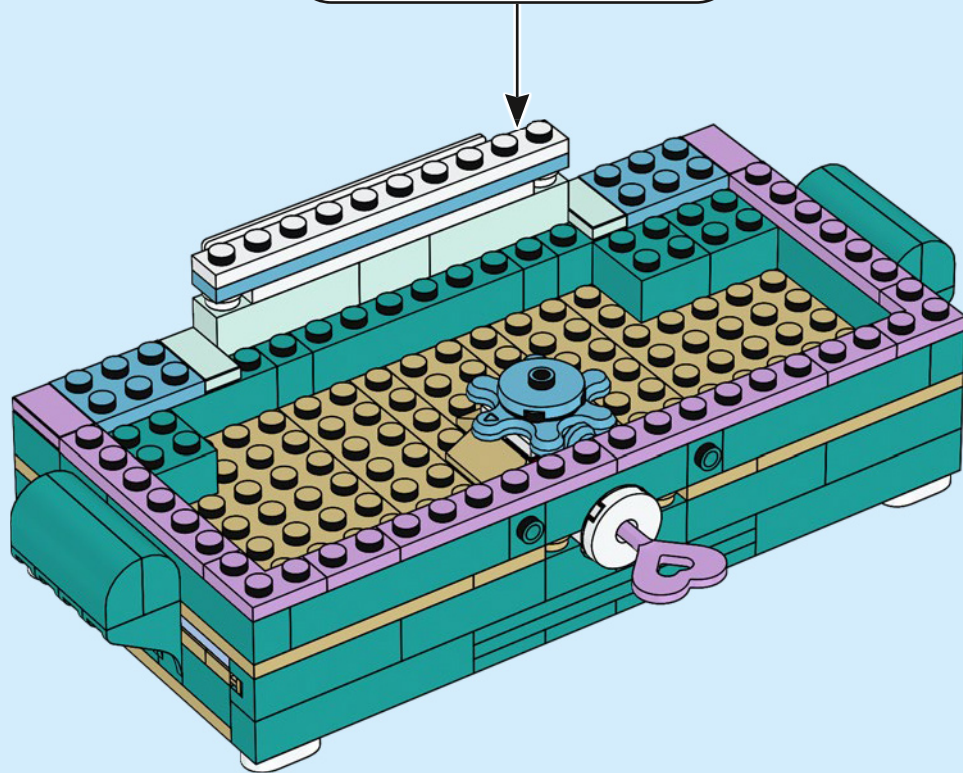



2x



1x

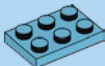

1x

43

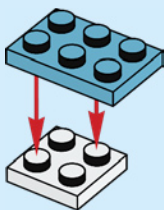

1x

44

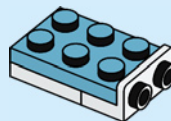

1x

45

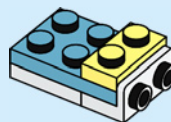

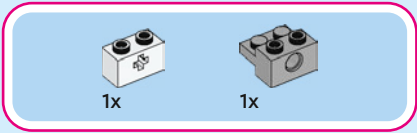

46

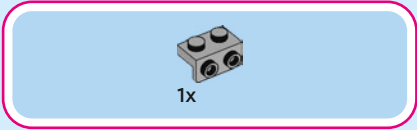
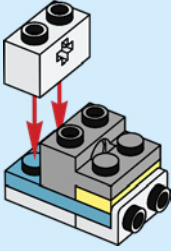

47

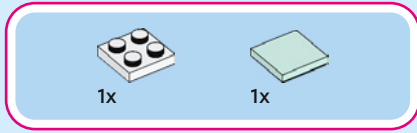
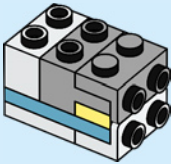

48

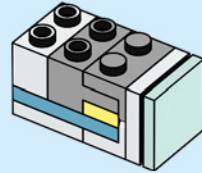
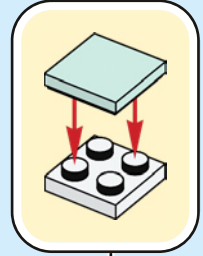

2x

49

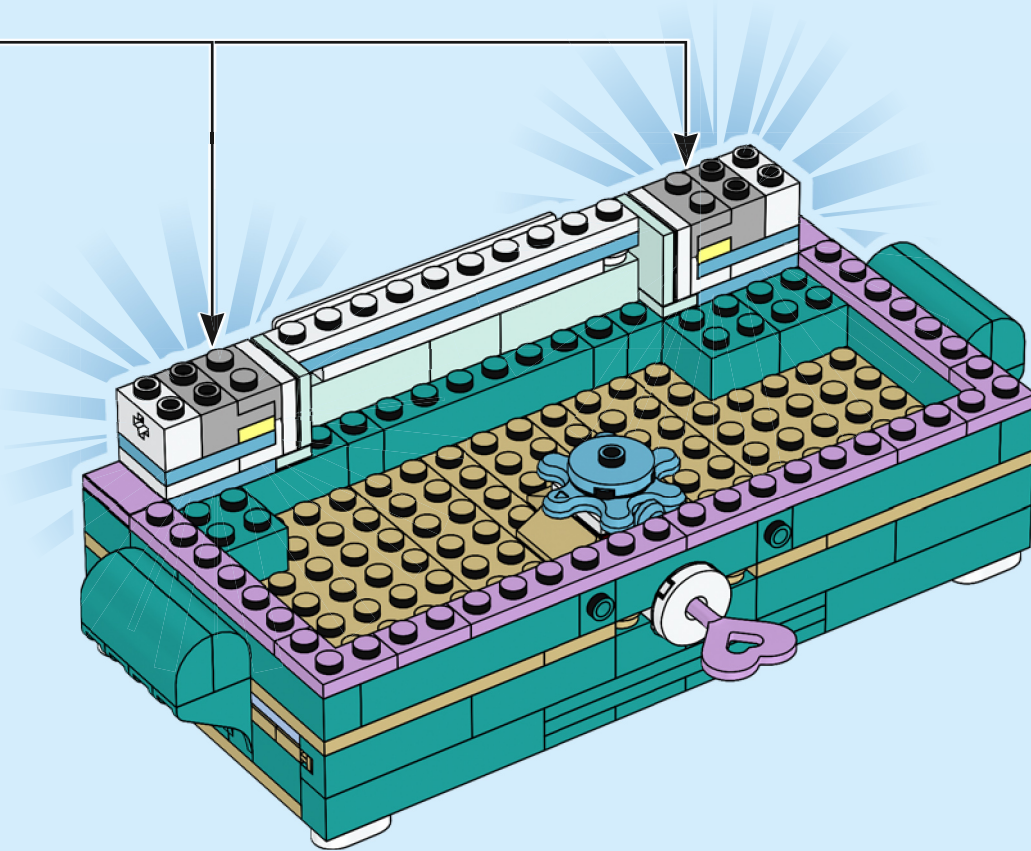

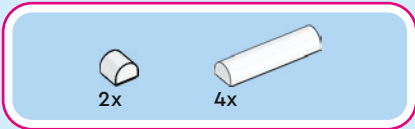

50

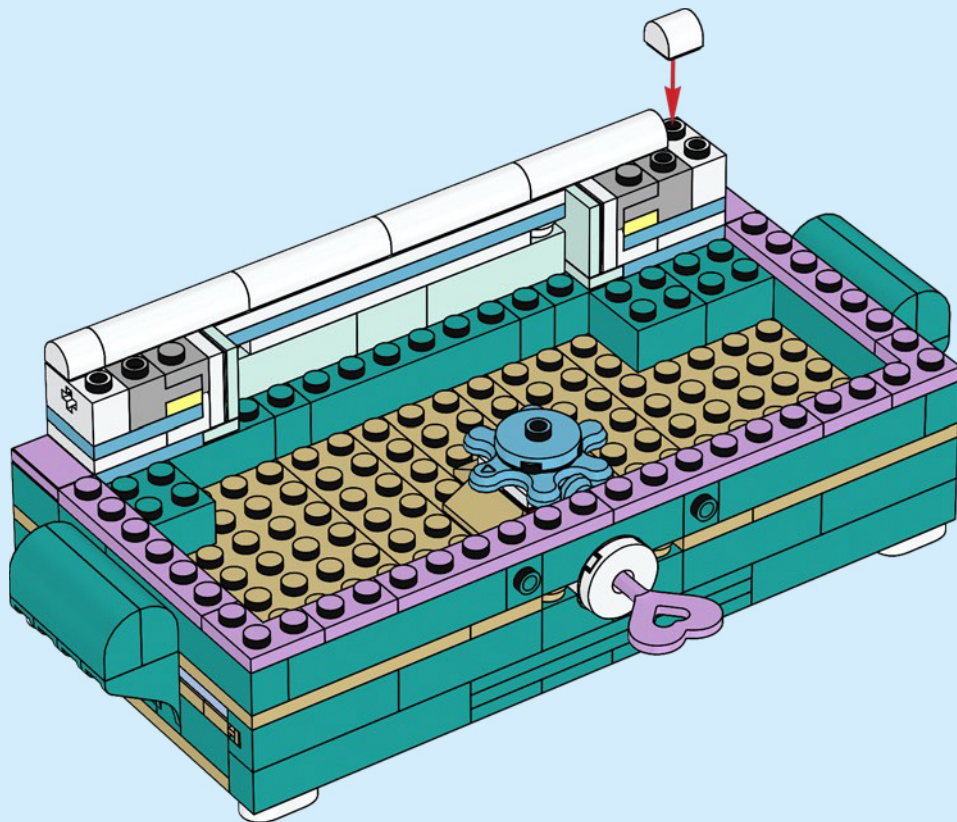



2x

51

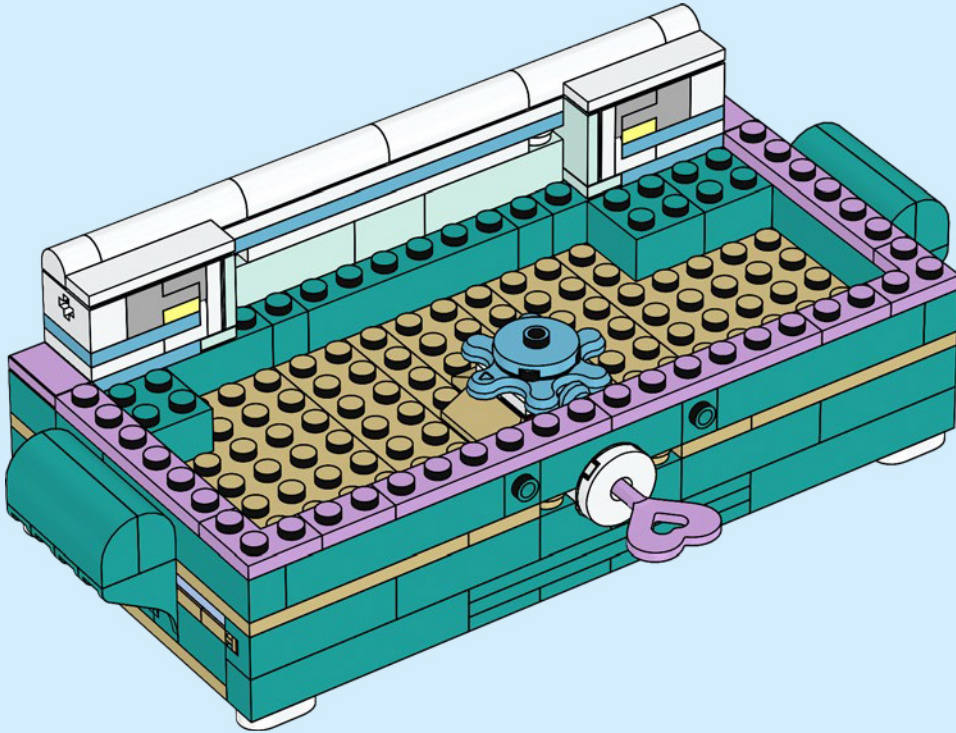



2x



1x

52

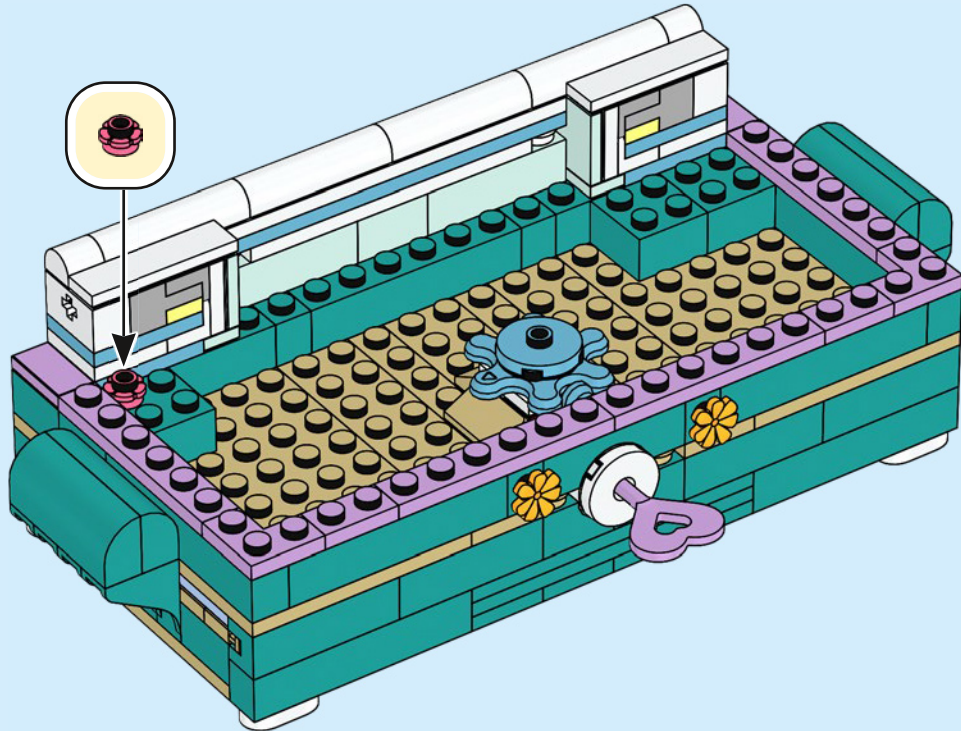



1x



1x

53

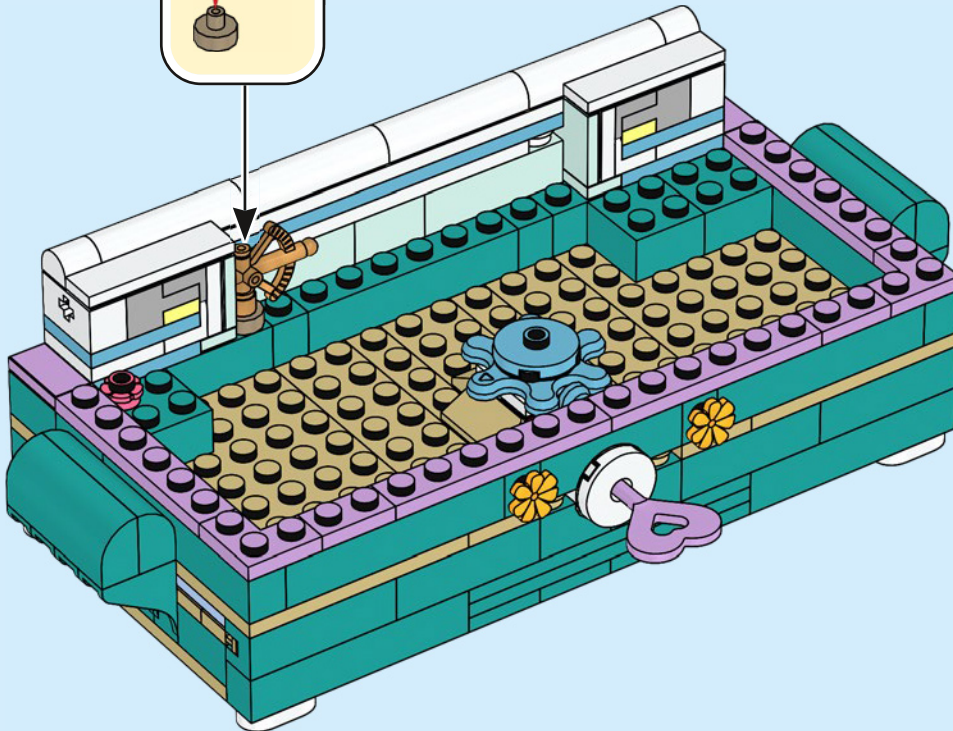
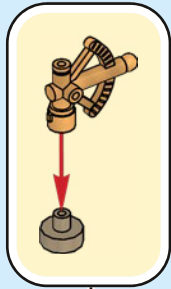

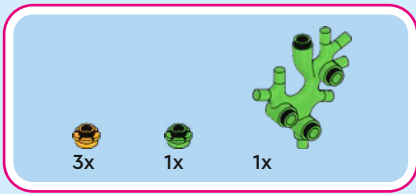

54

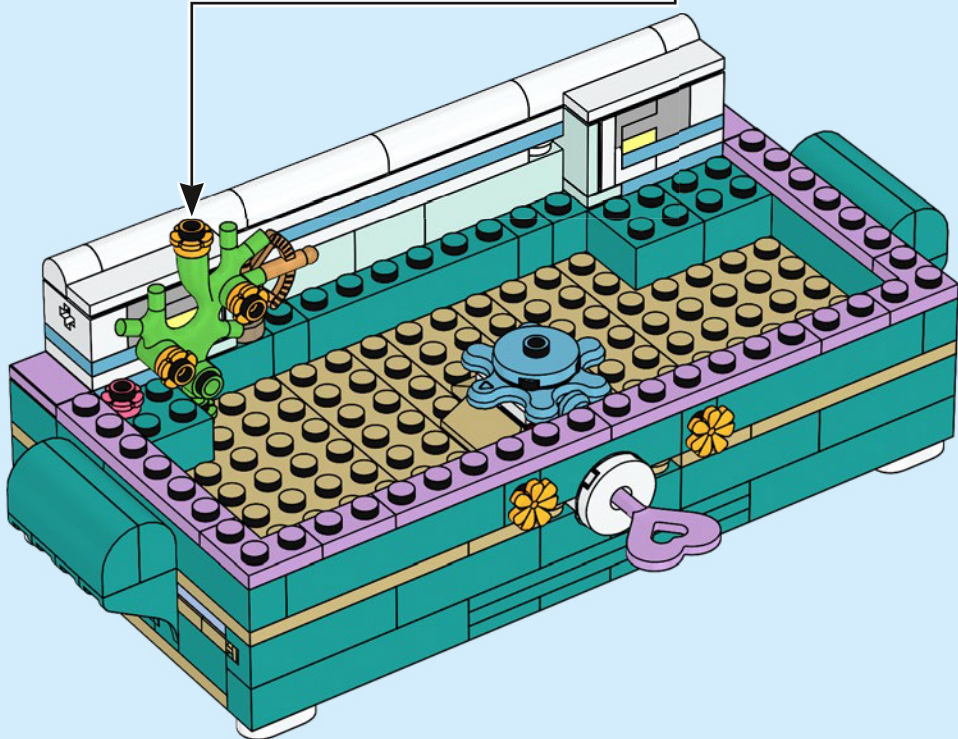
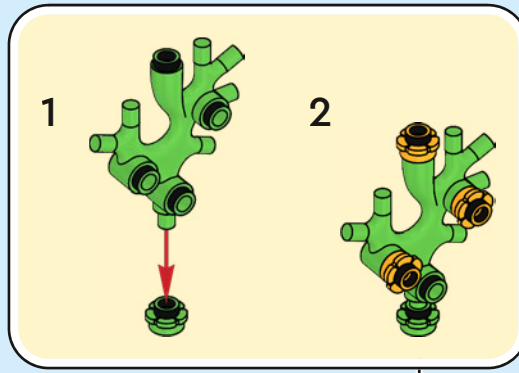

1x



1x



55

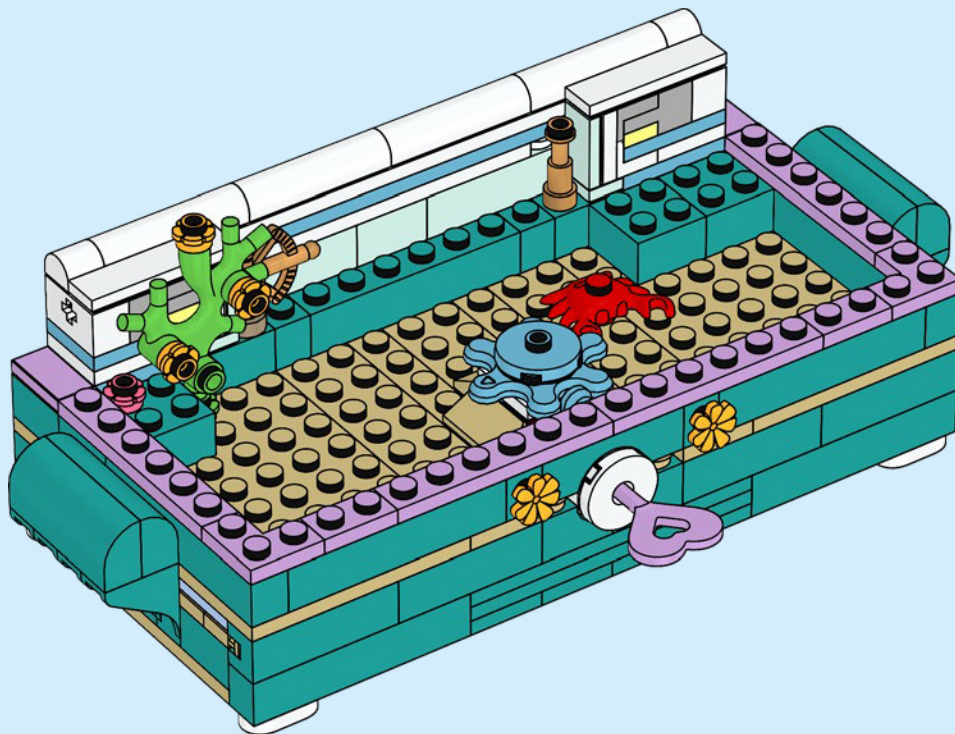



1x



1x

56

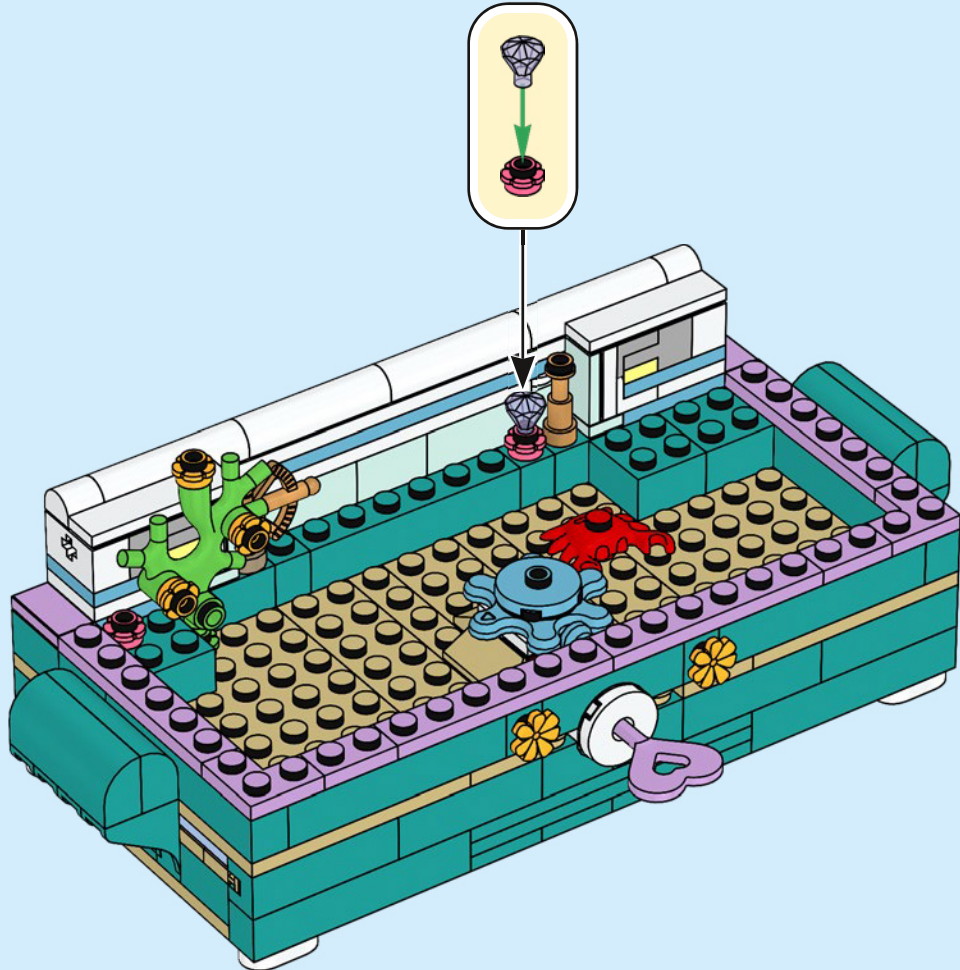

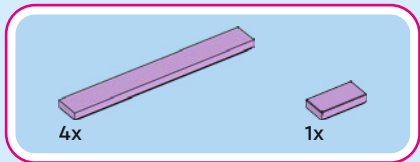

57

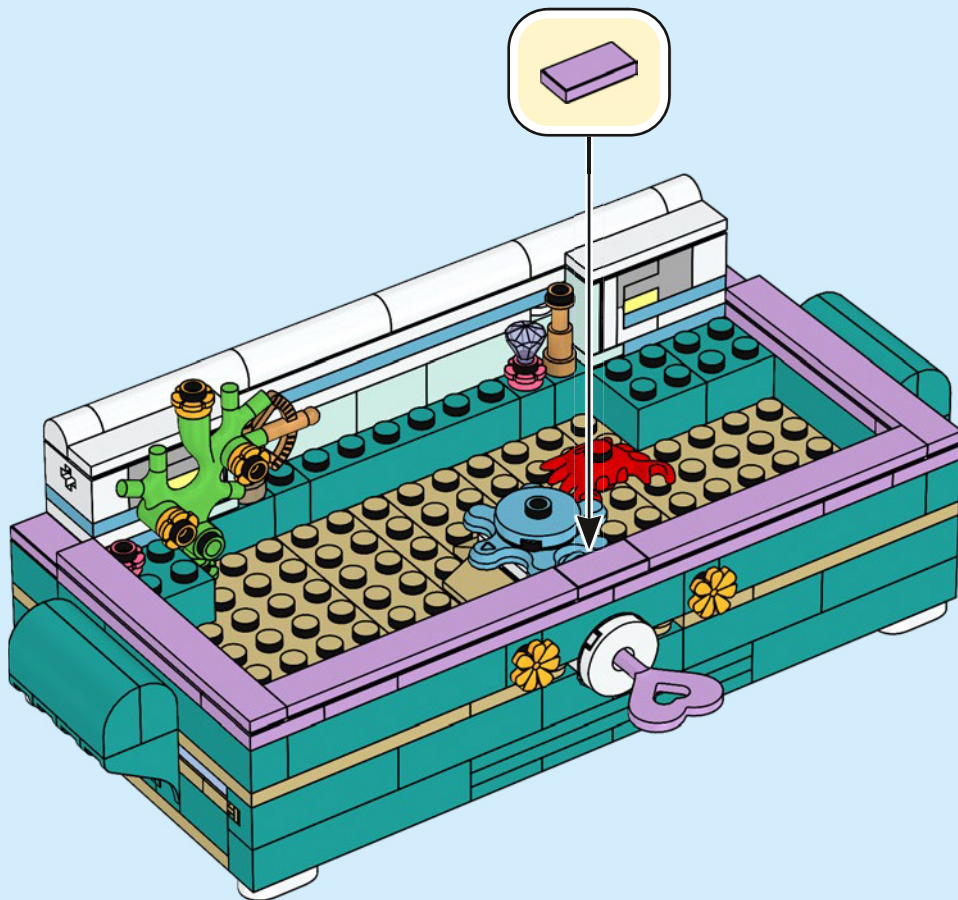

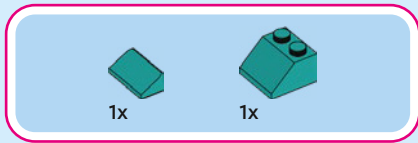

58

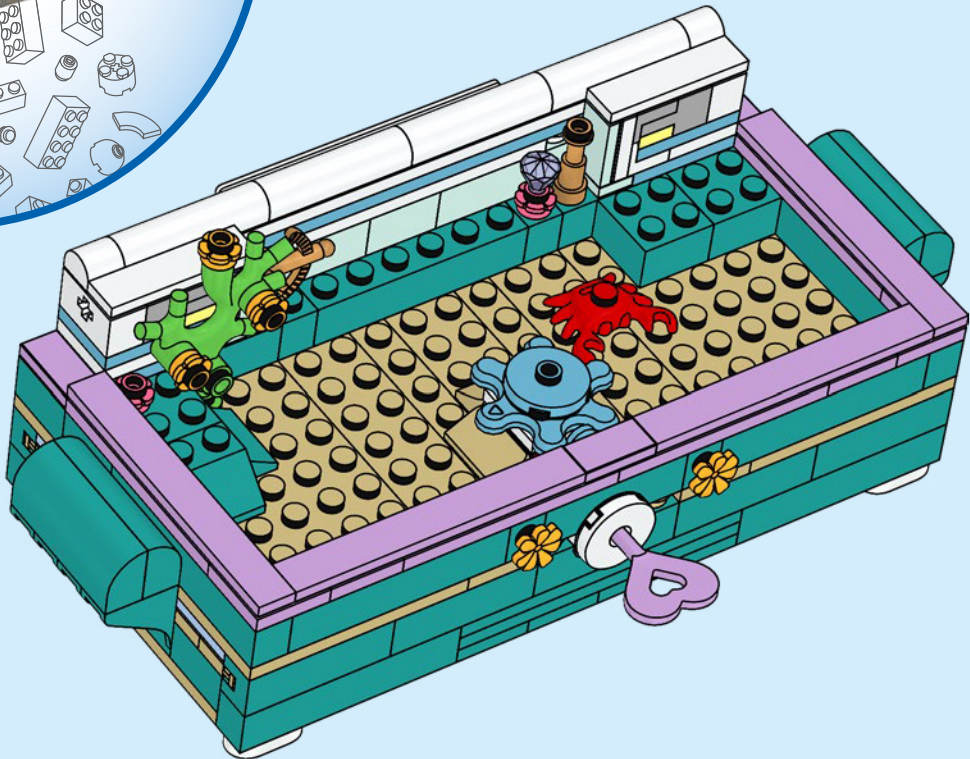

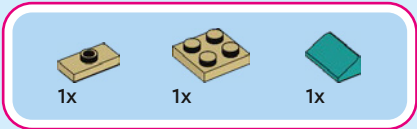

59

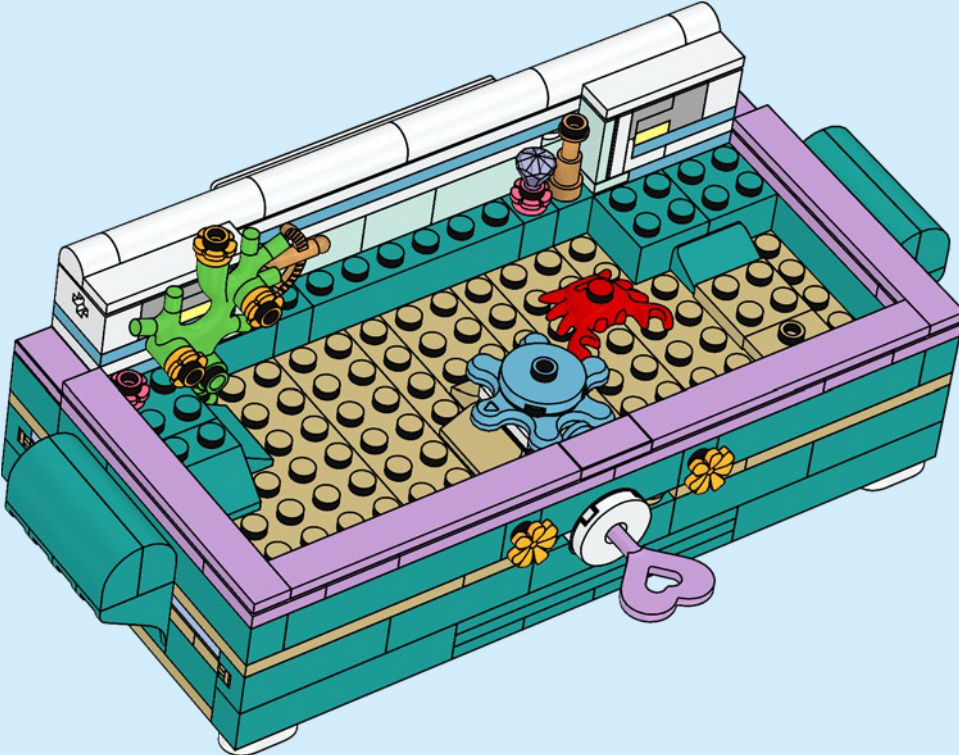



5x

60

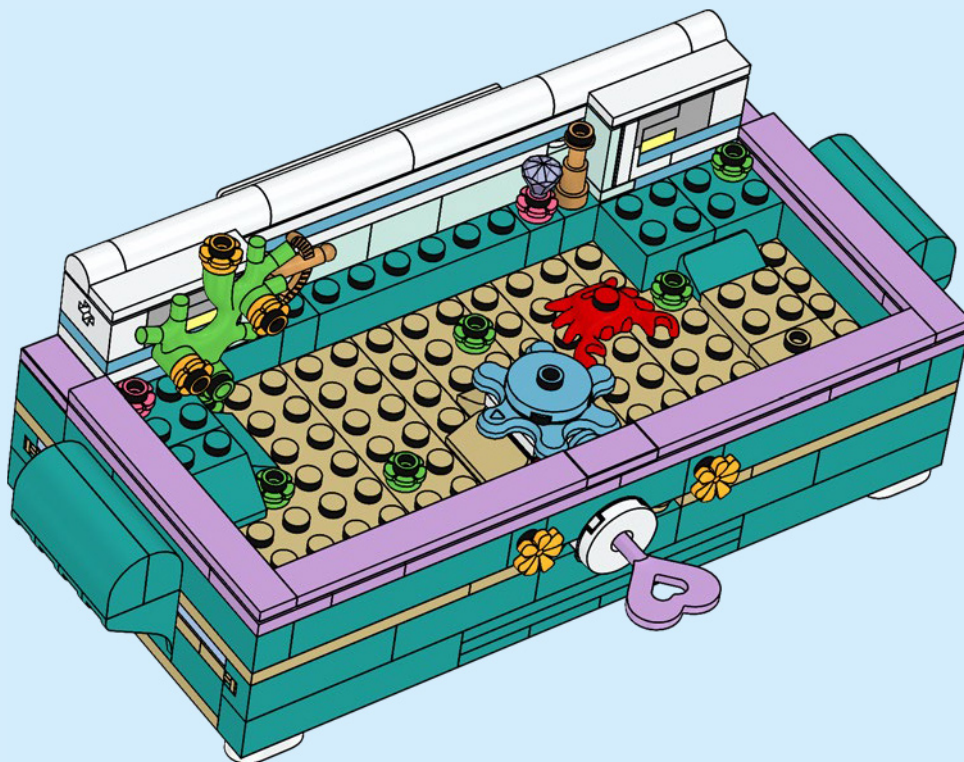

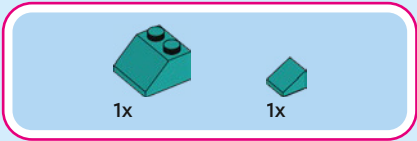

61

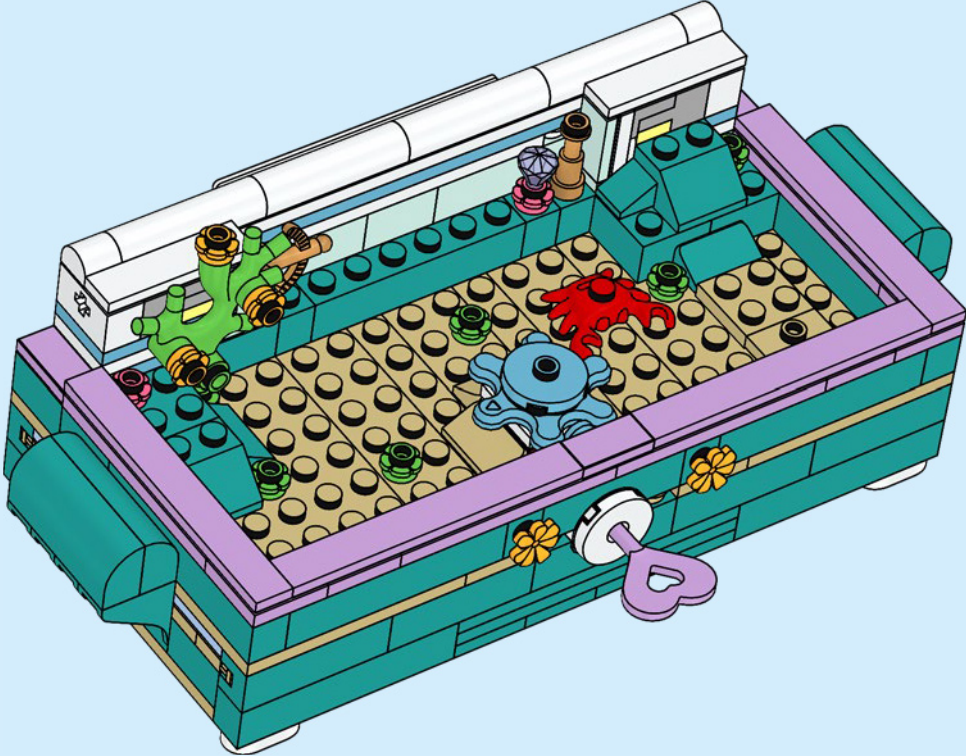

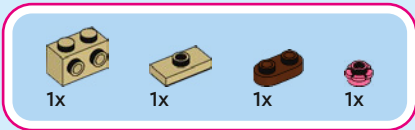

62

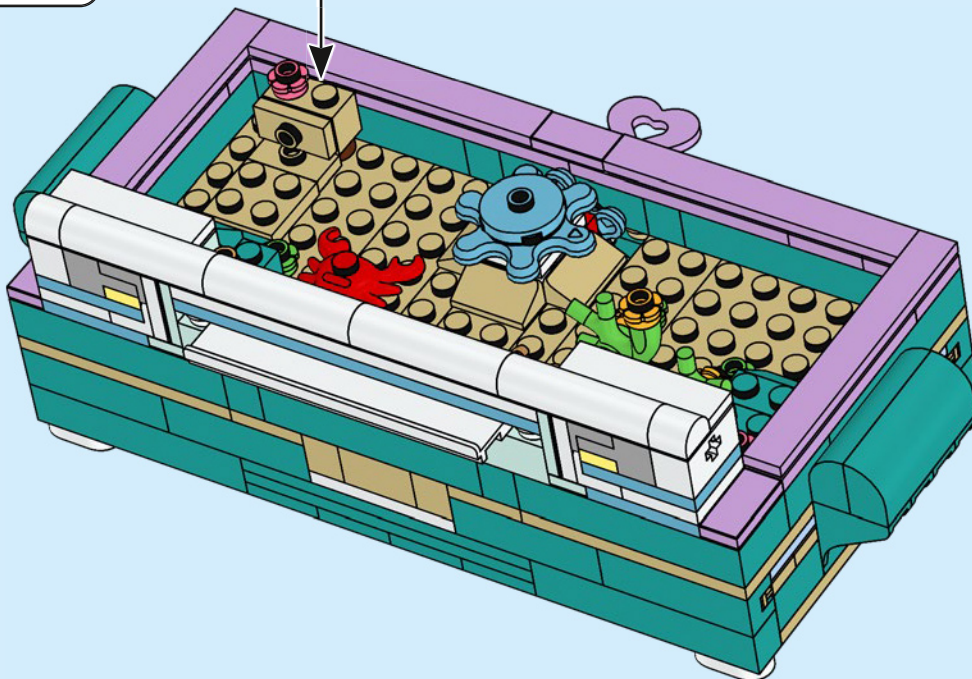
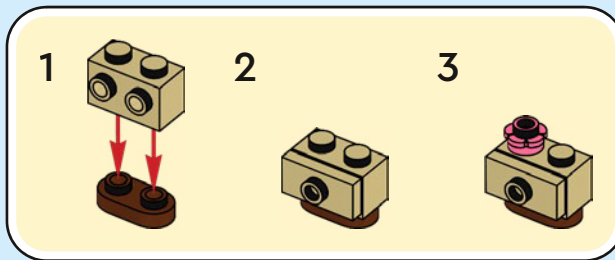



2x



2x

63

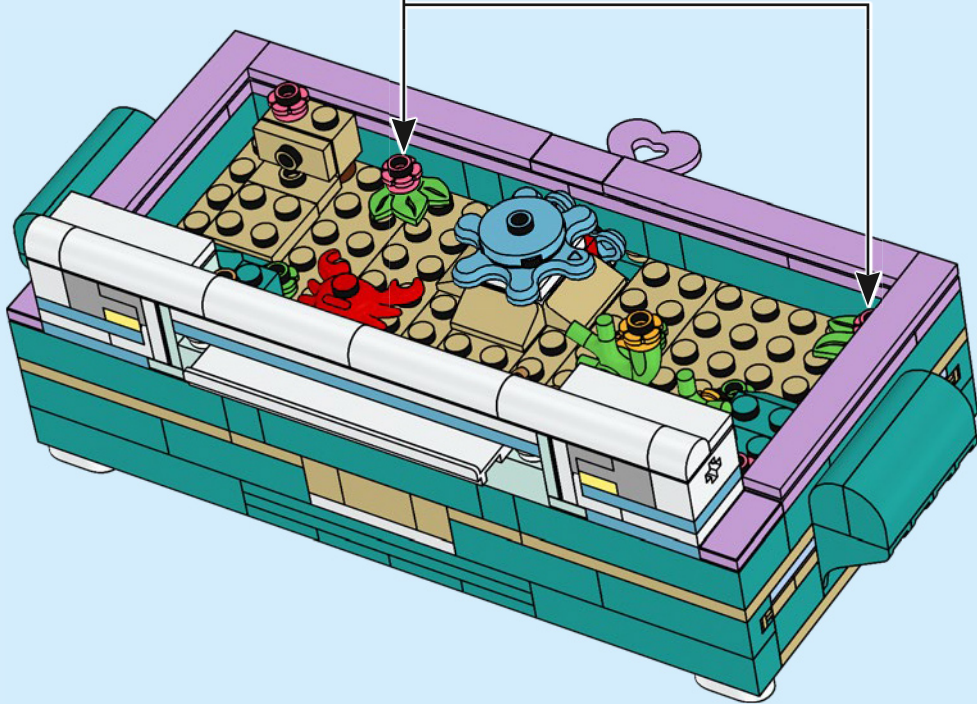
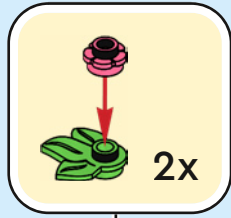

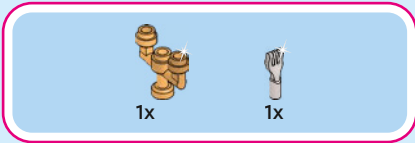

64

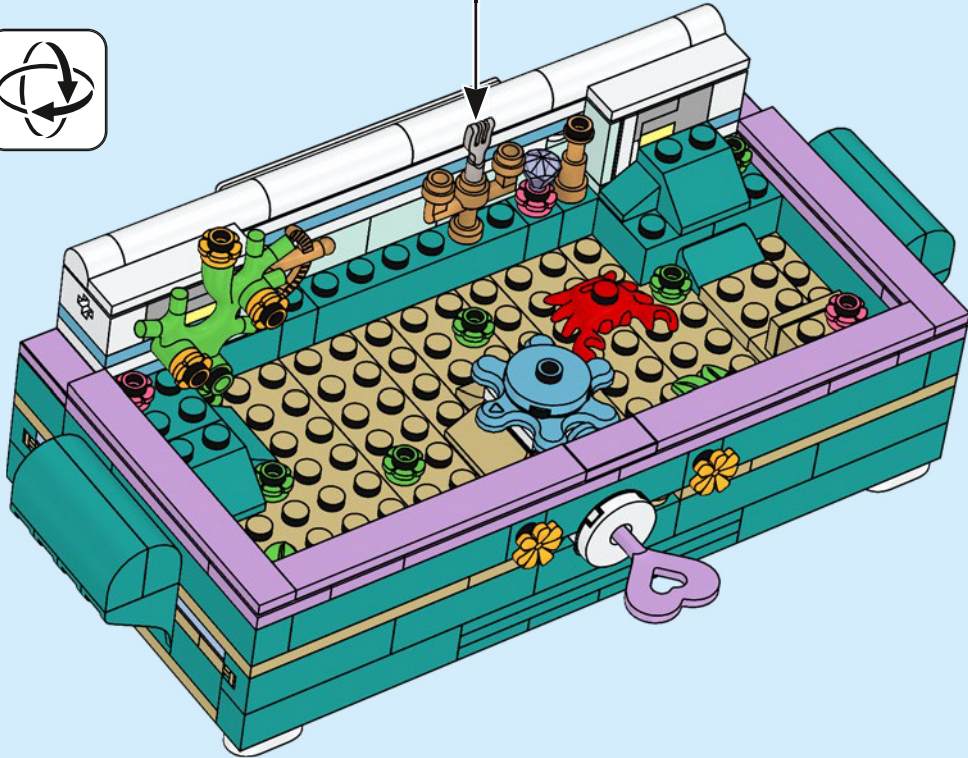
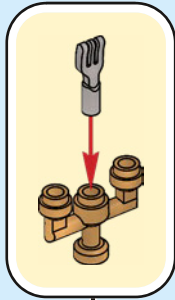



1x



1x

65

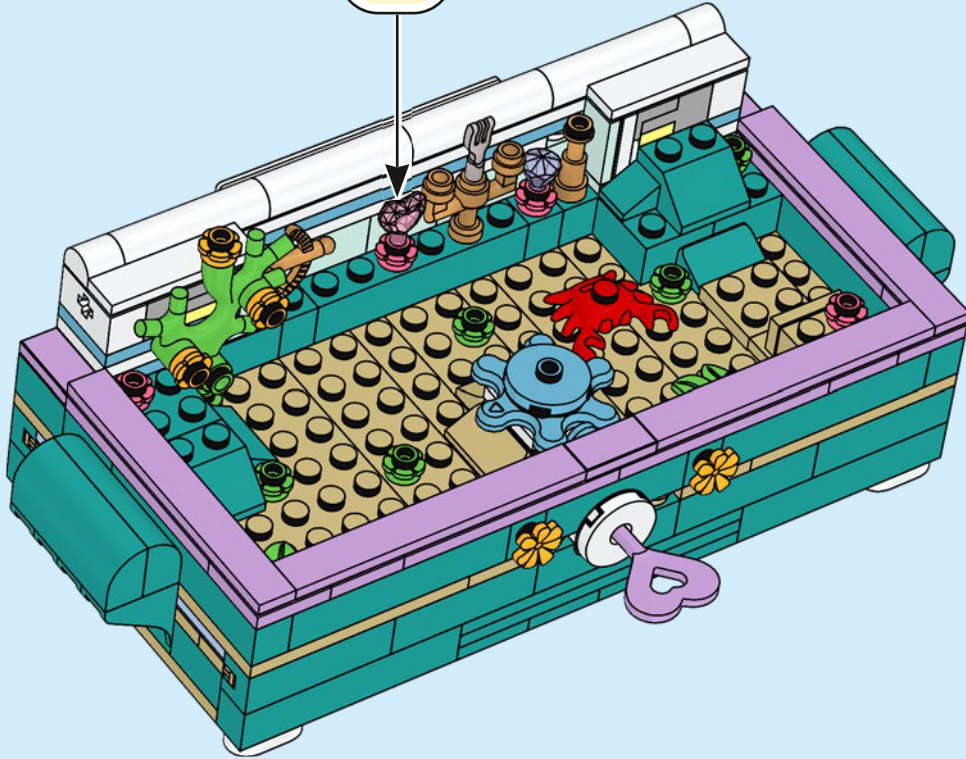
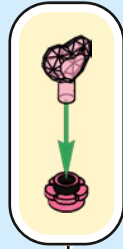



1x



1x

66

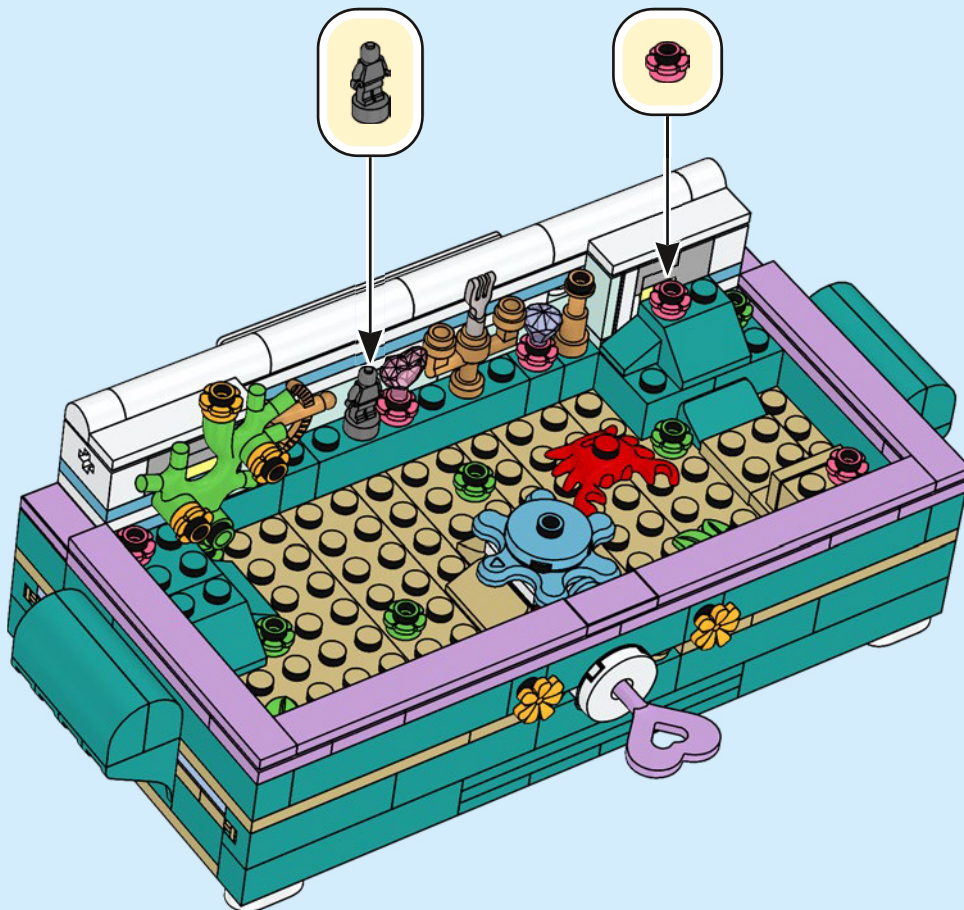



1x

67

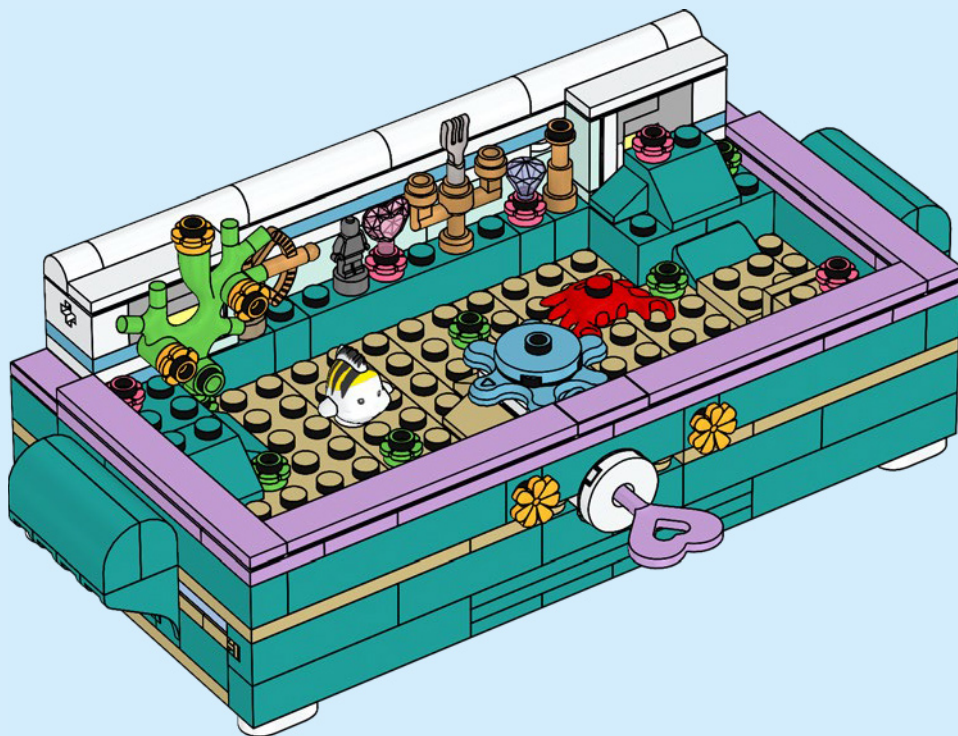

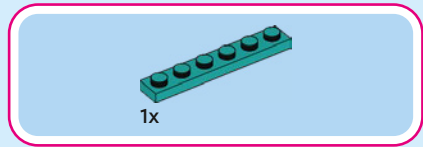
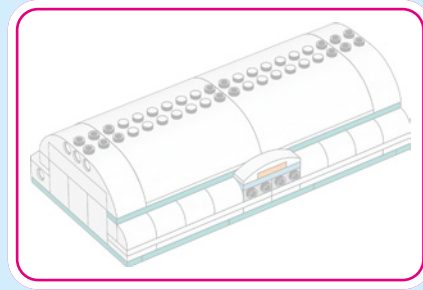

68

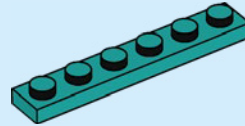



2x

69

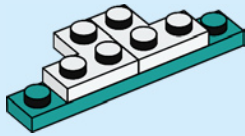

1x

70

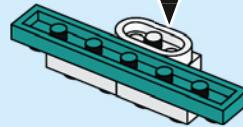

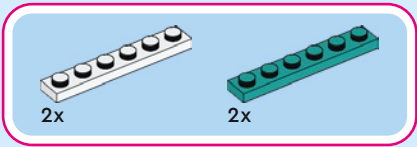

71

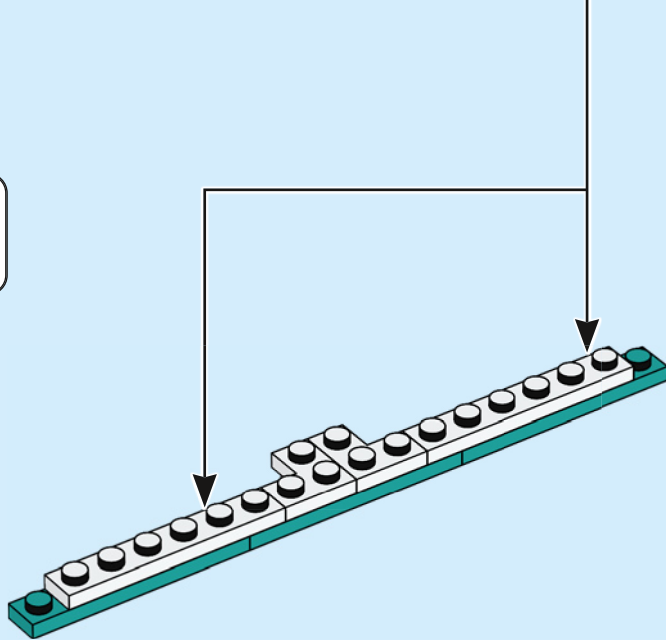
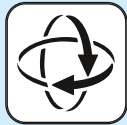
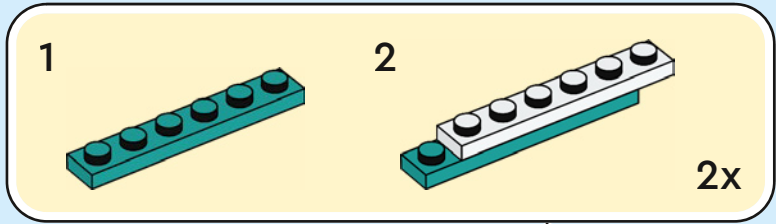



2x

72

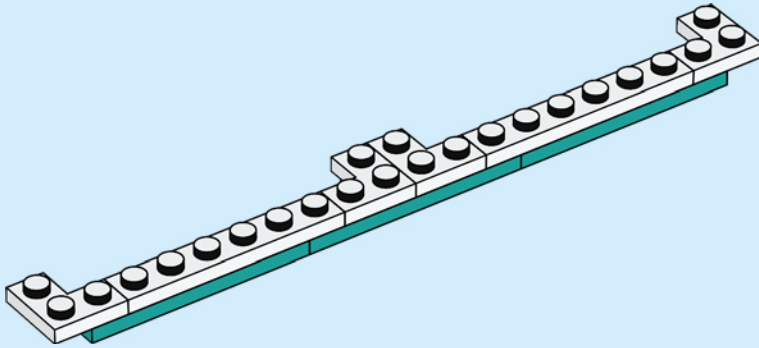

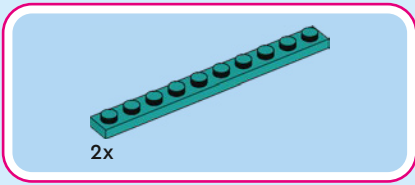

73

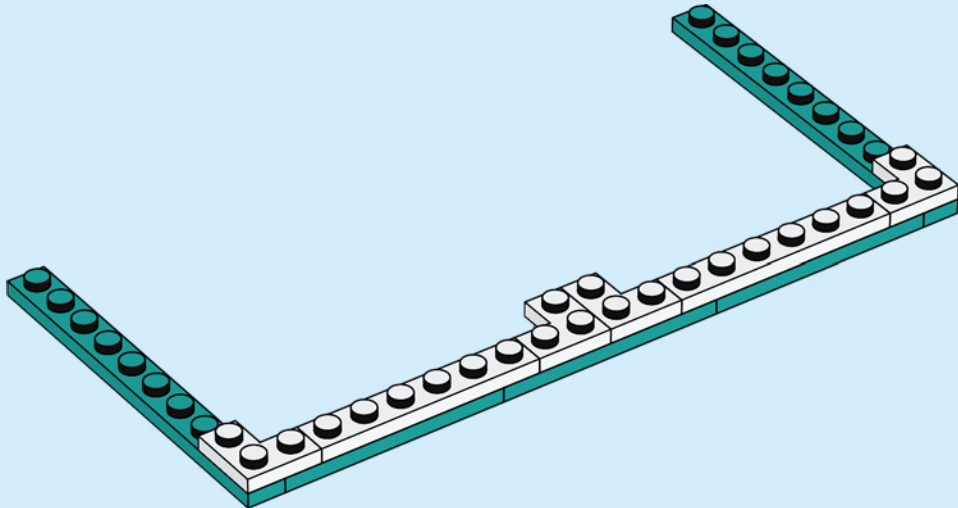

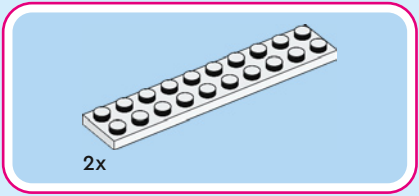

74

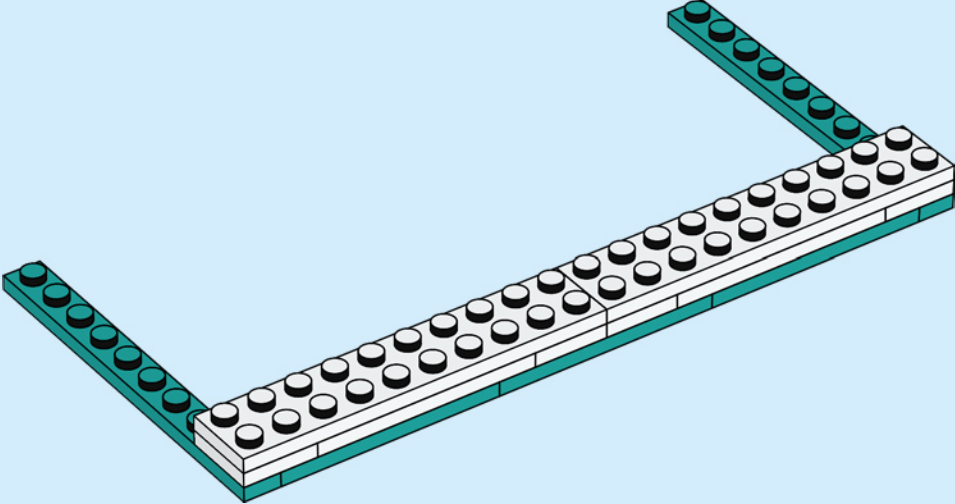

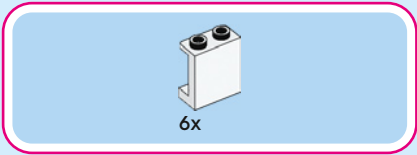

75

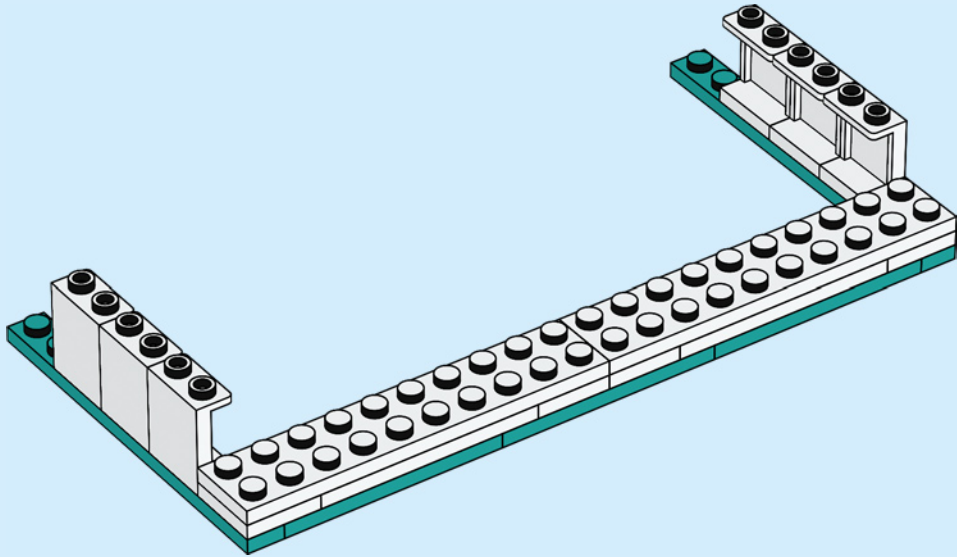

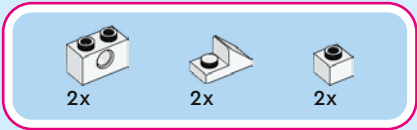

76

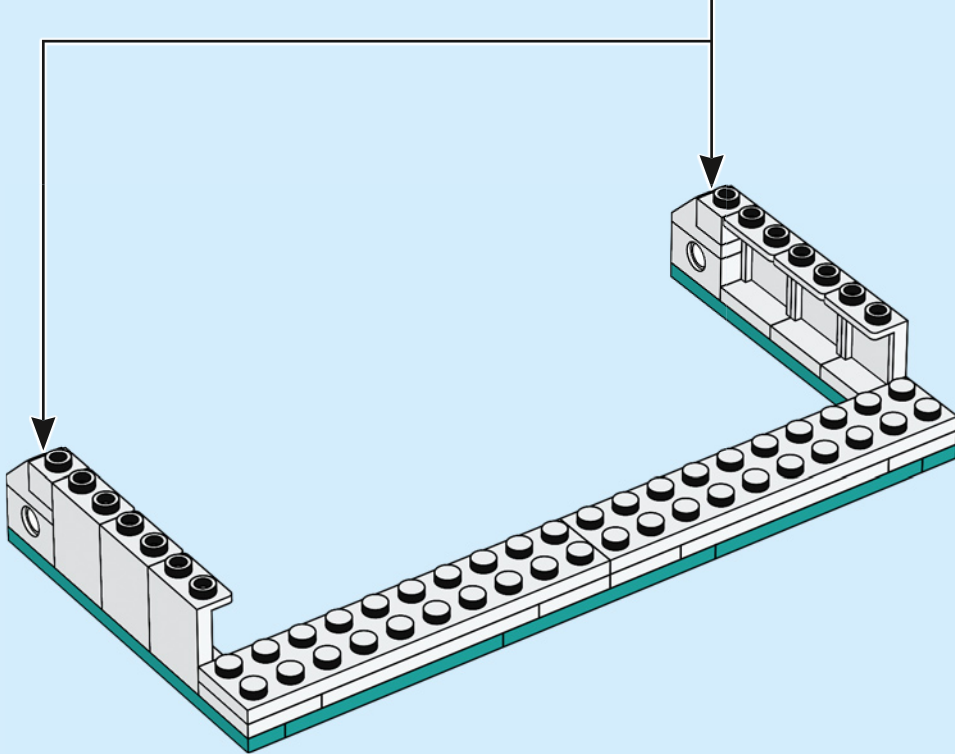
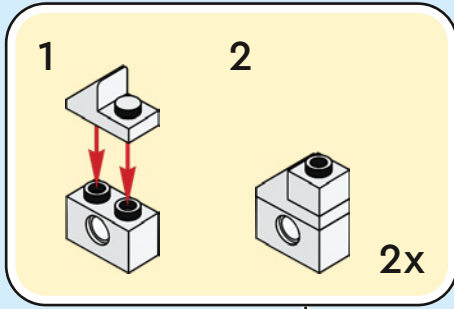

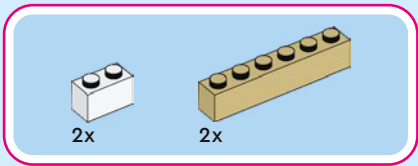

77

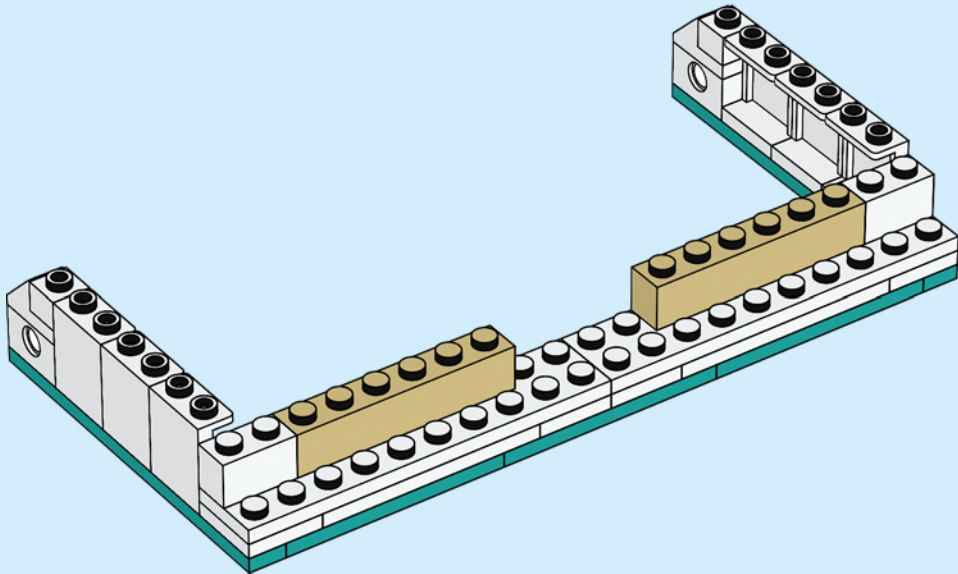

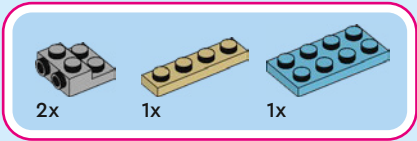

78

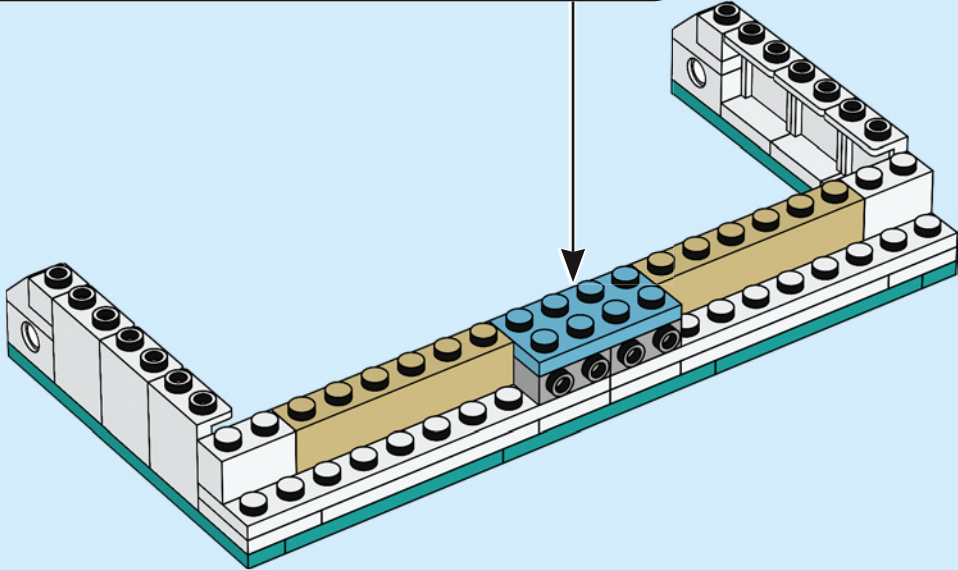
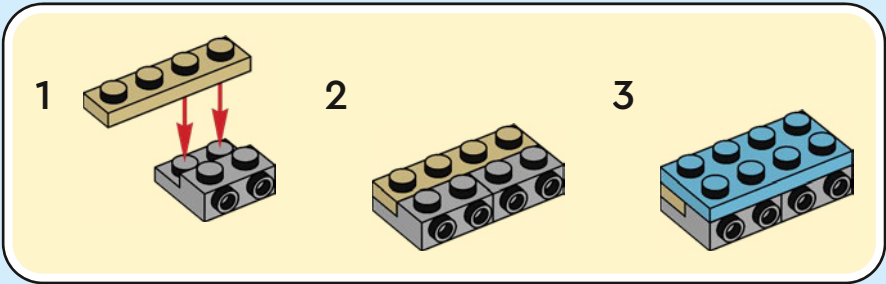



8x

79

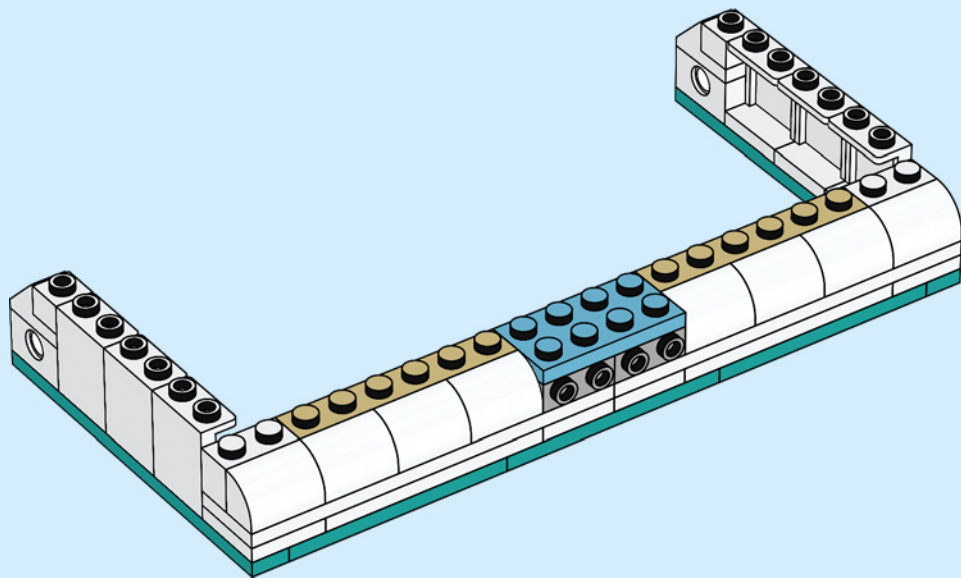

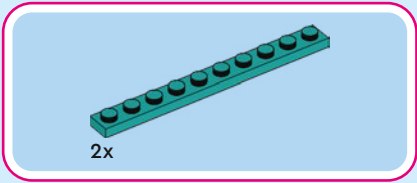

80

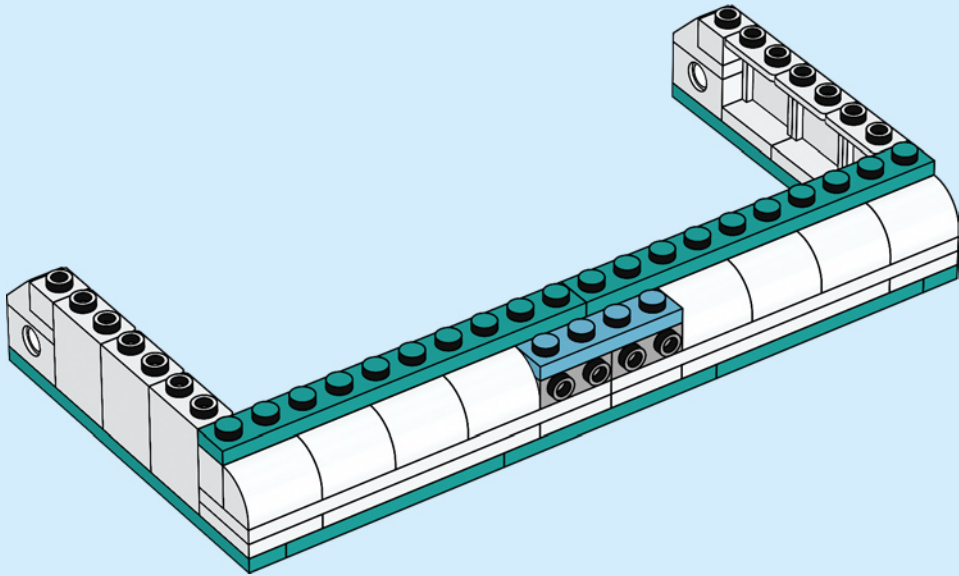

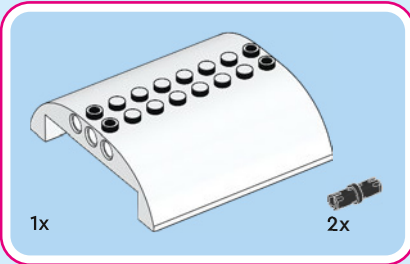
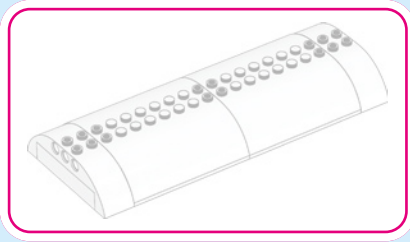

81

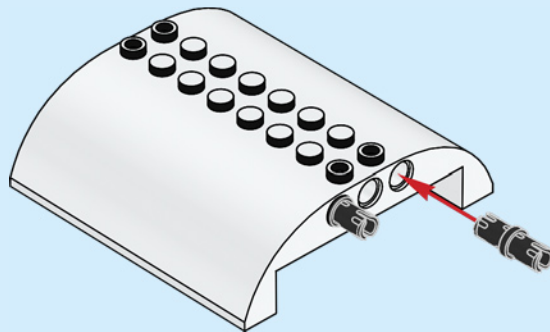

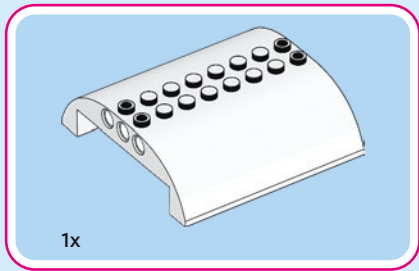

82

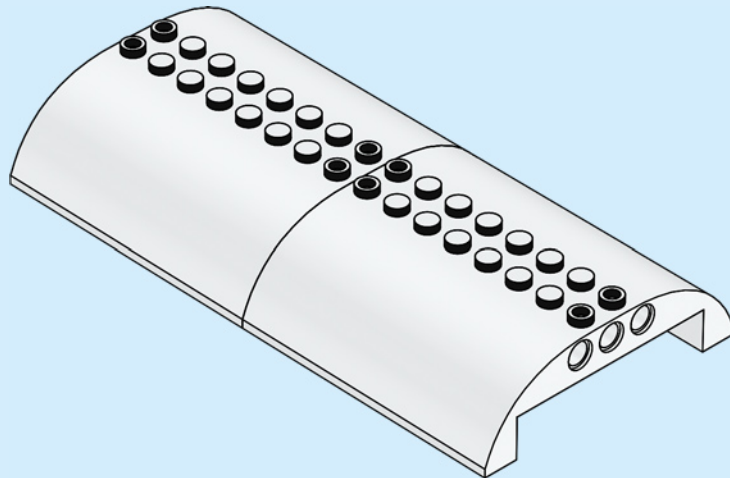

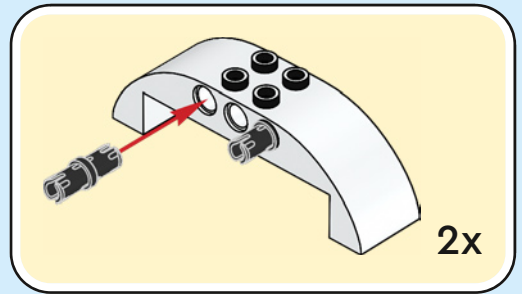
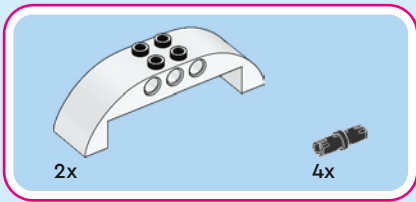

83

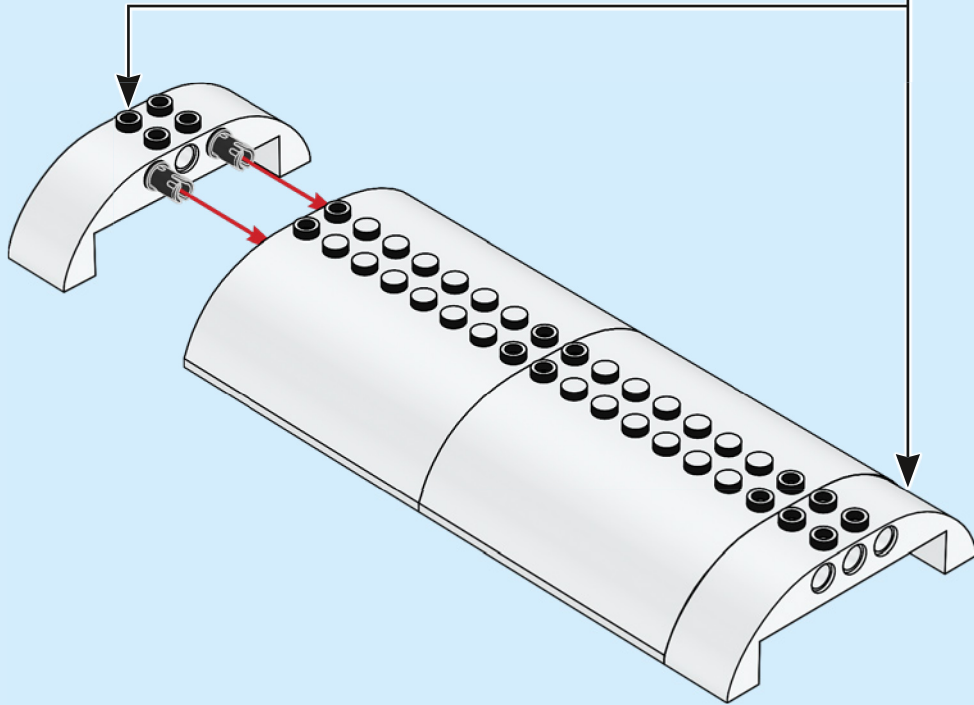



6x

84



6x

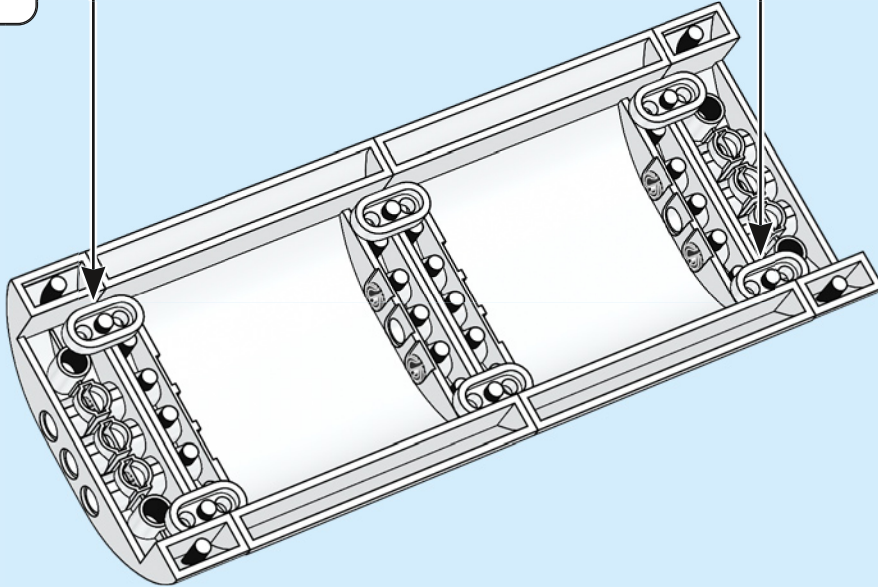

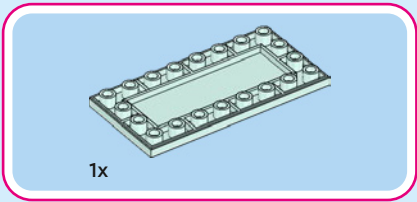

85

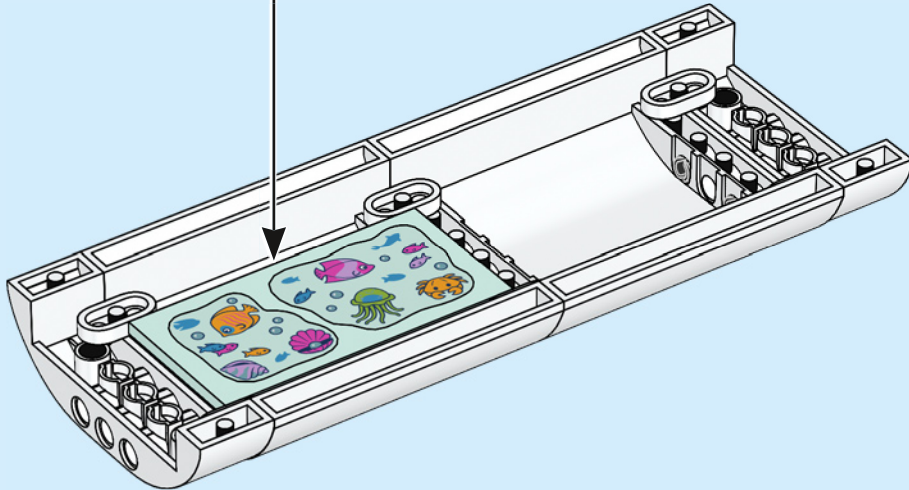
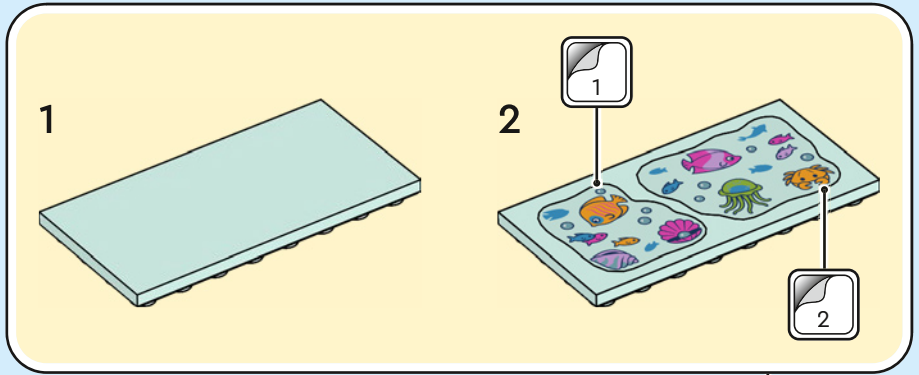

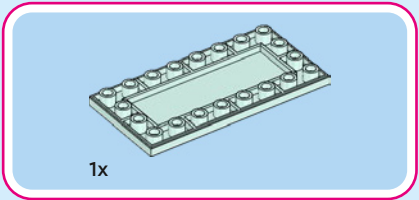

86

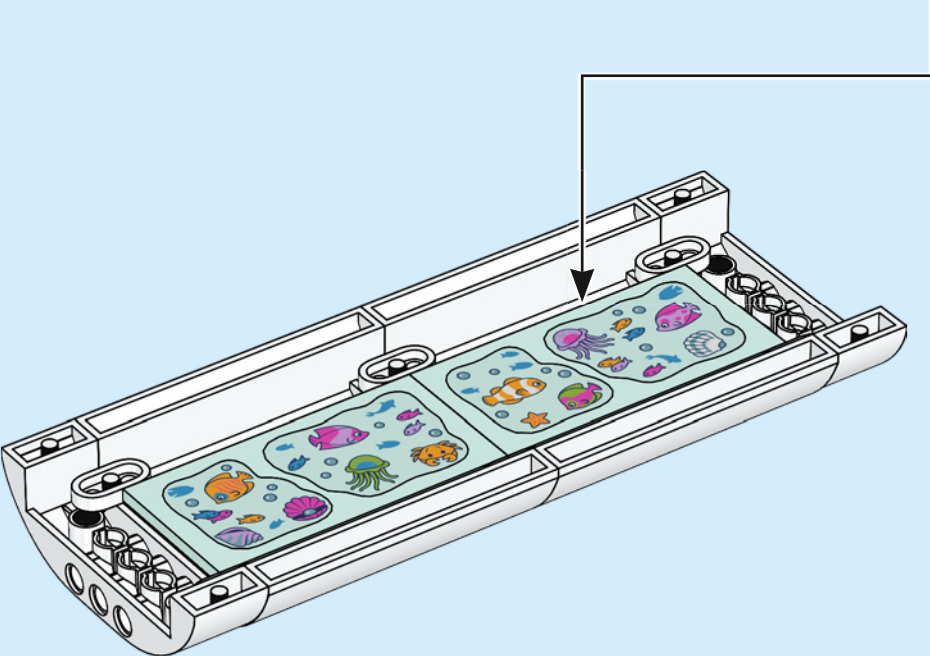
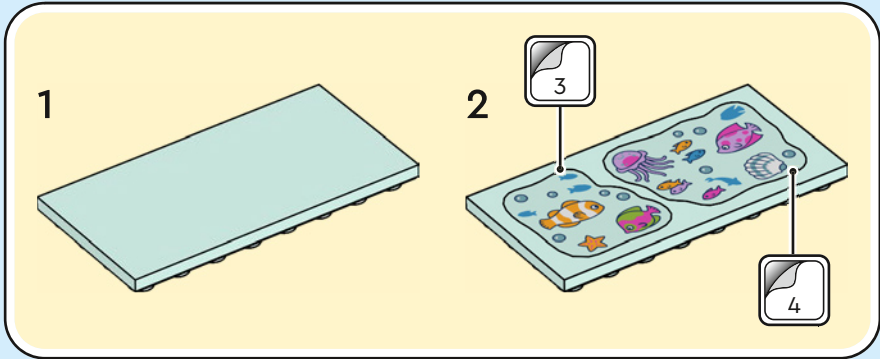

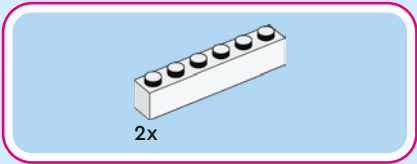

87

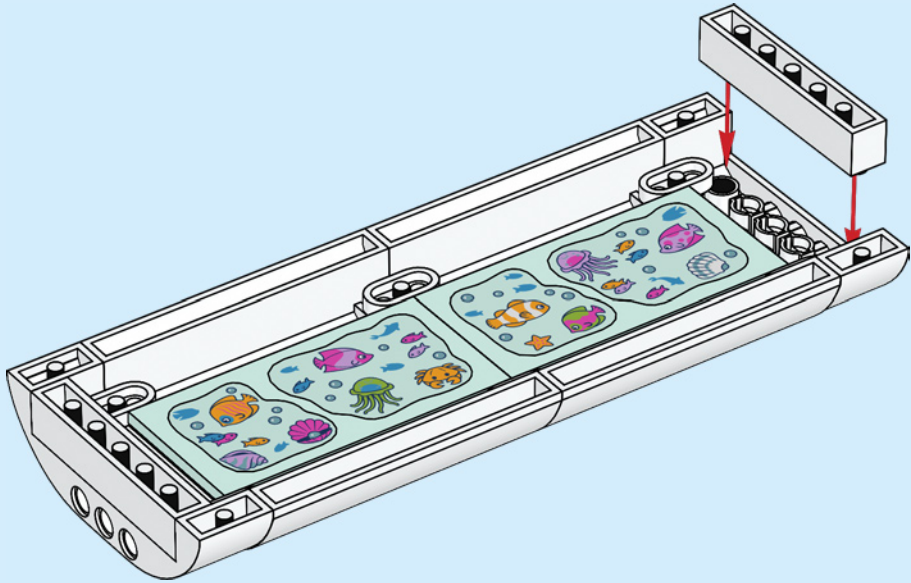

88

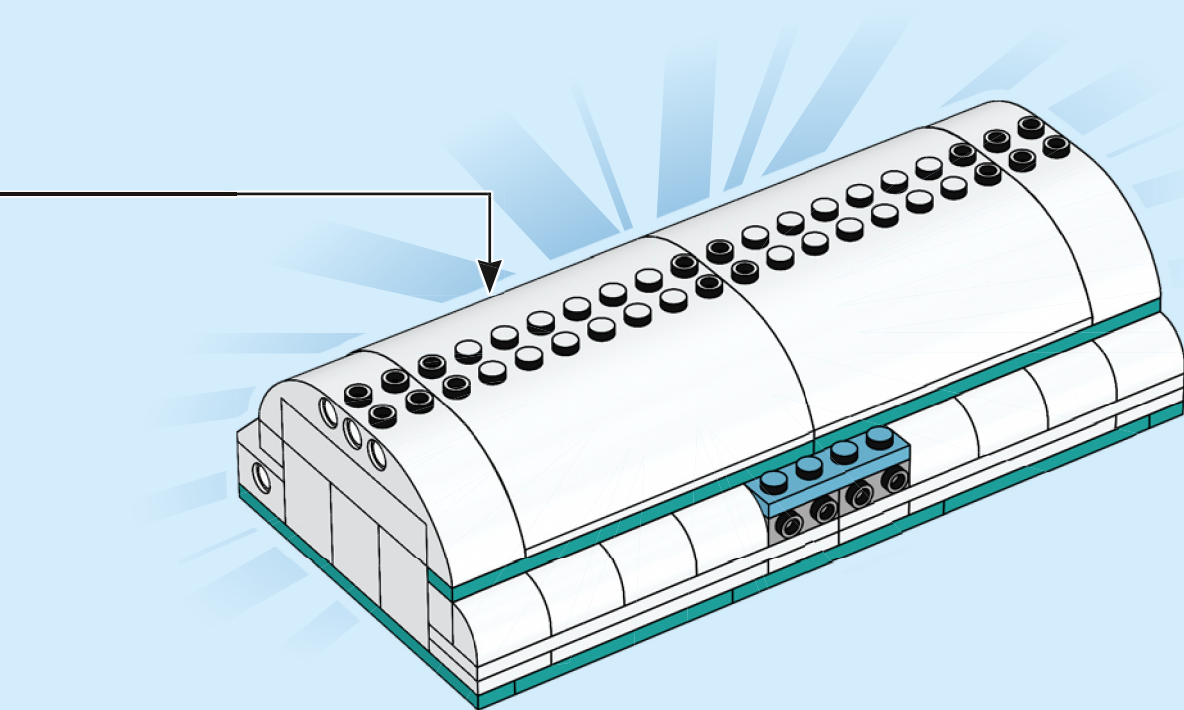



1x



1x

89

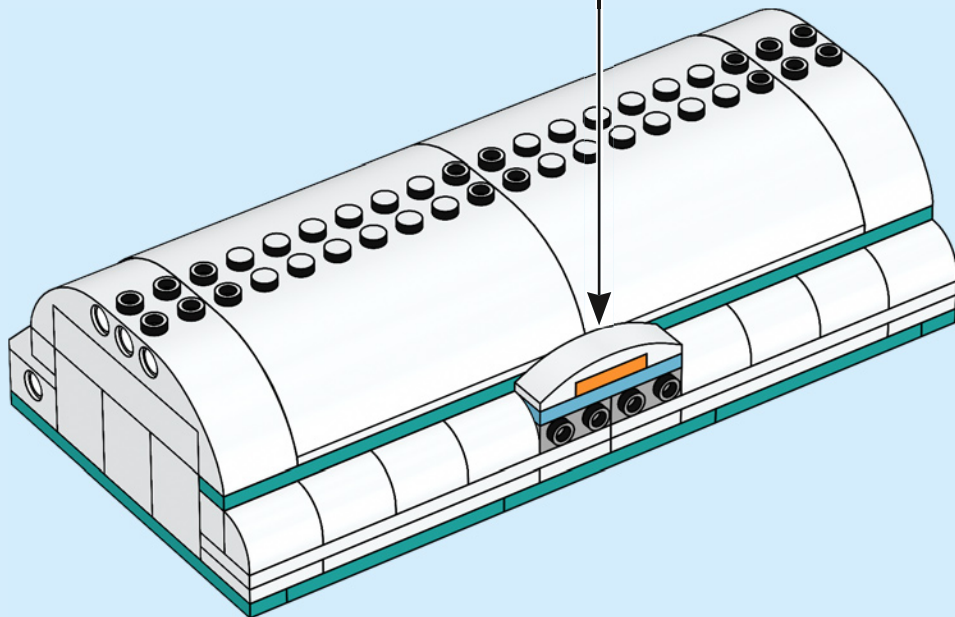
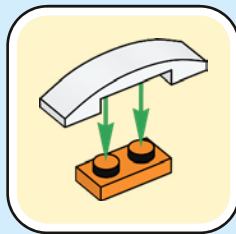

90

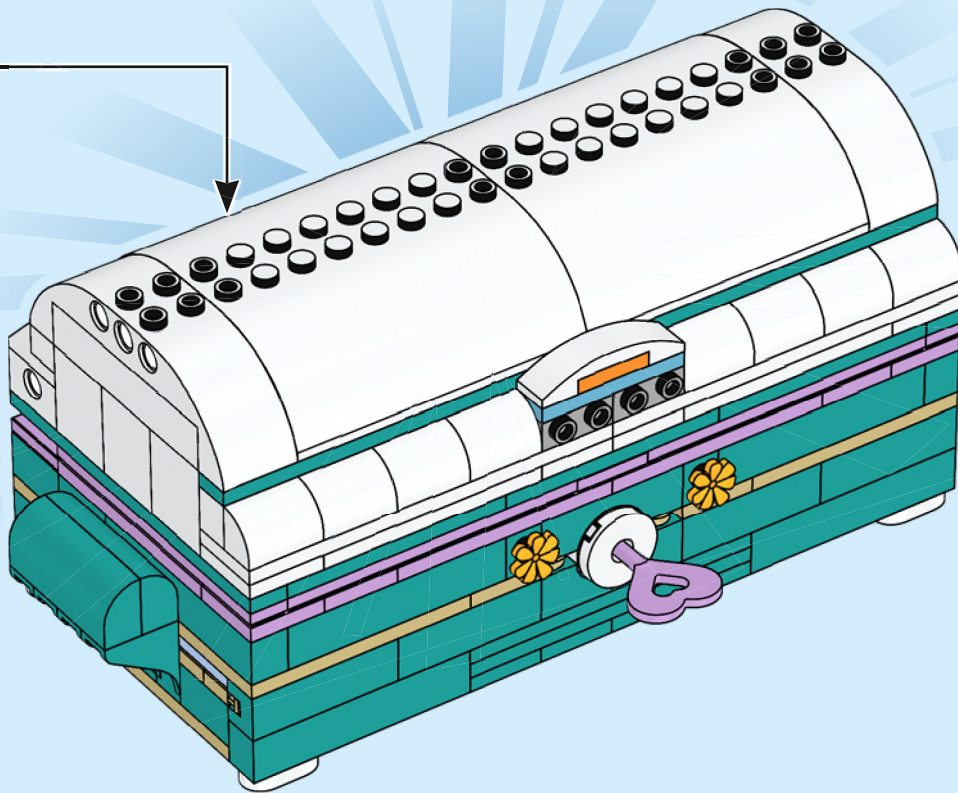

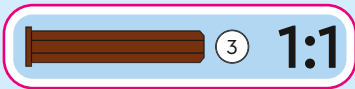
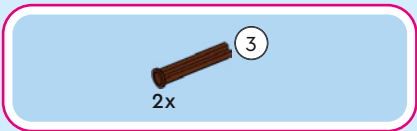

91

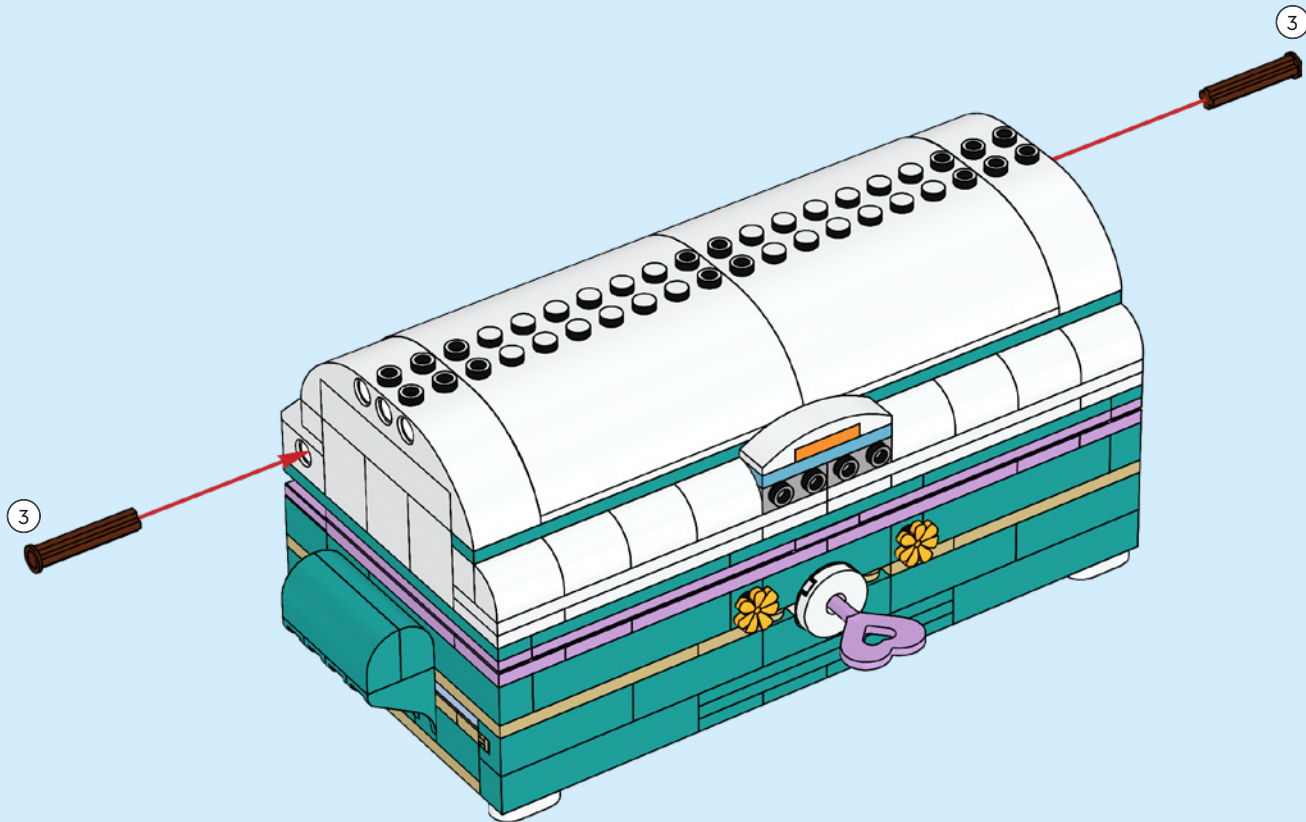

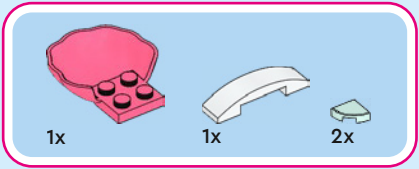

92

1



2



3



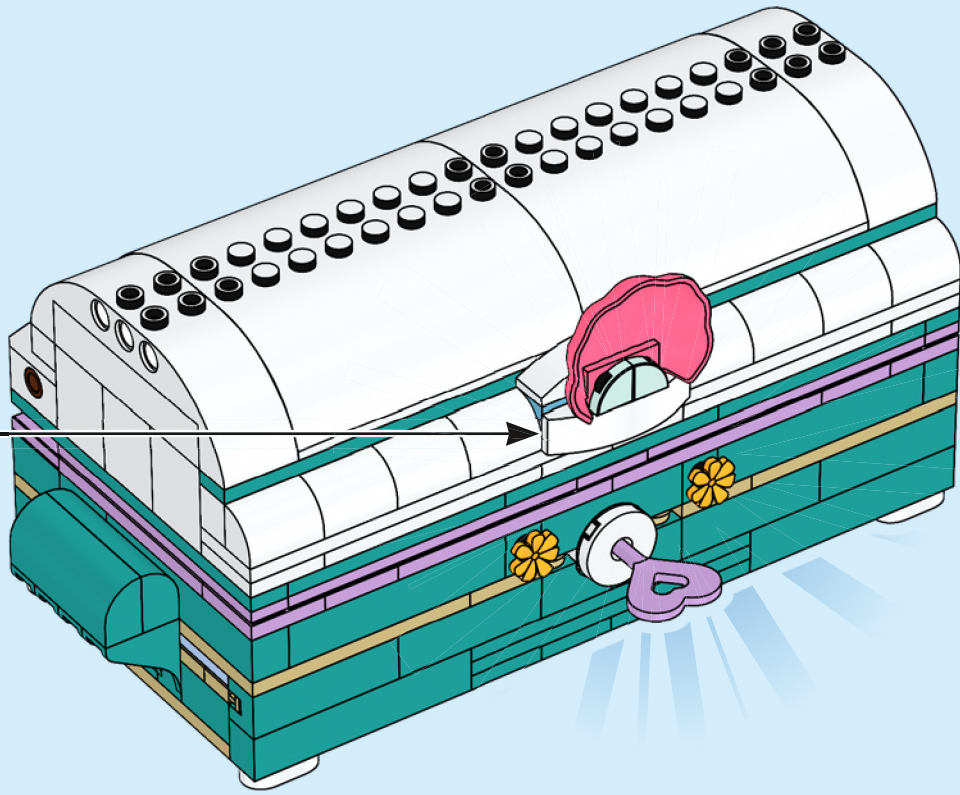

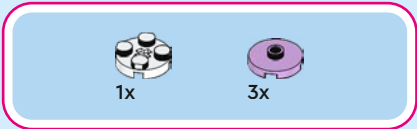

93

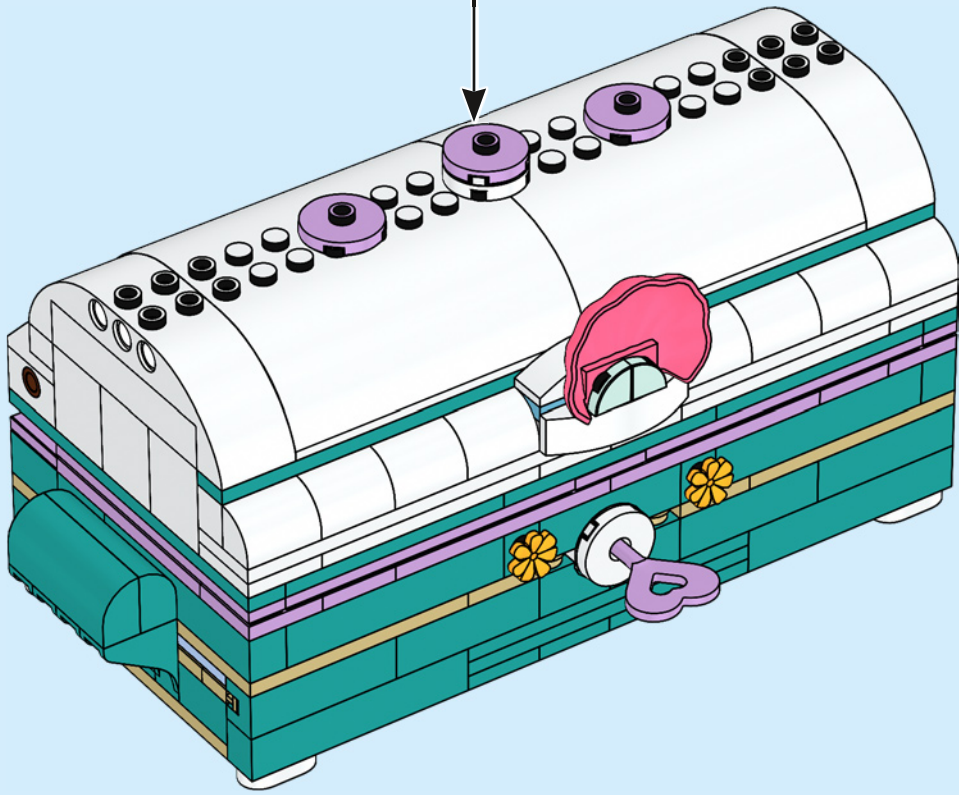
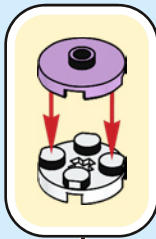



4x

94

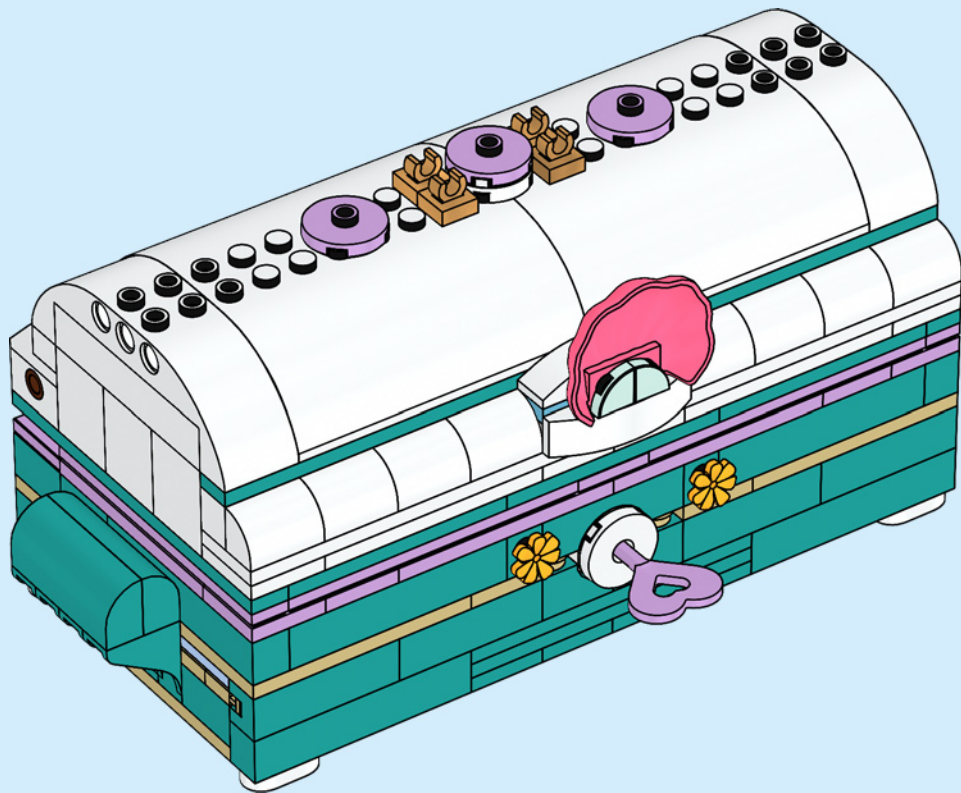



2x



4x

95

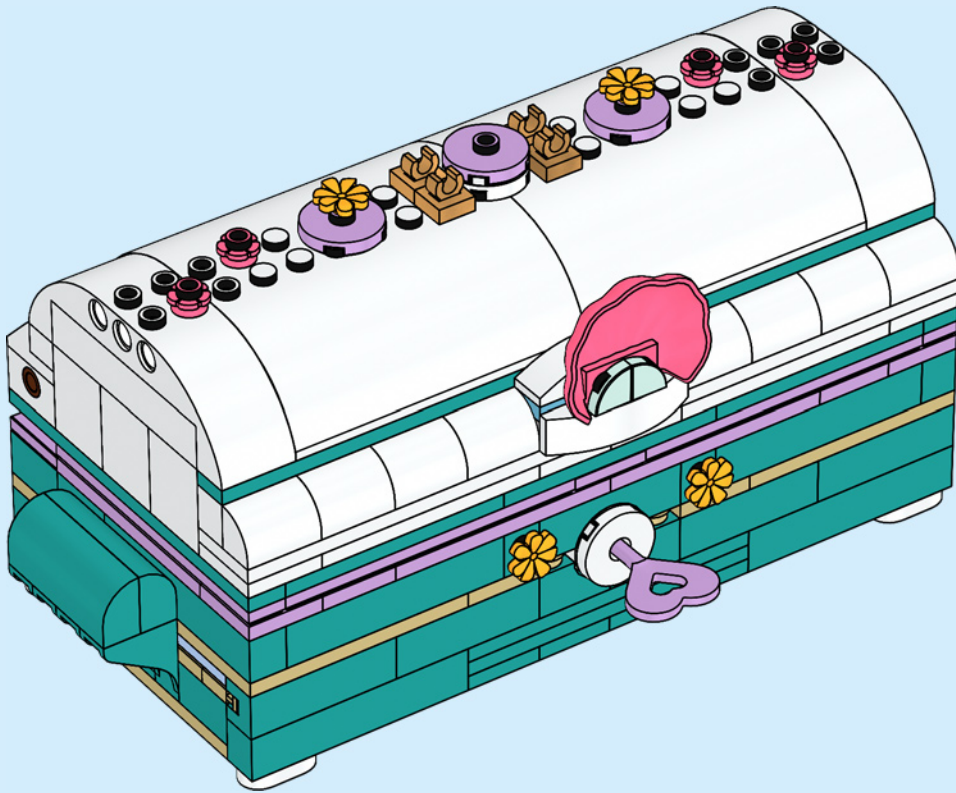



4x

96

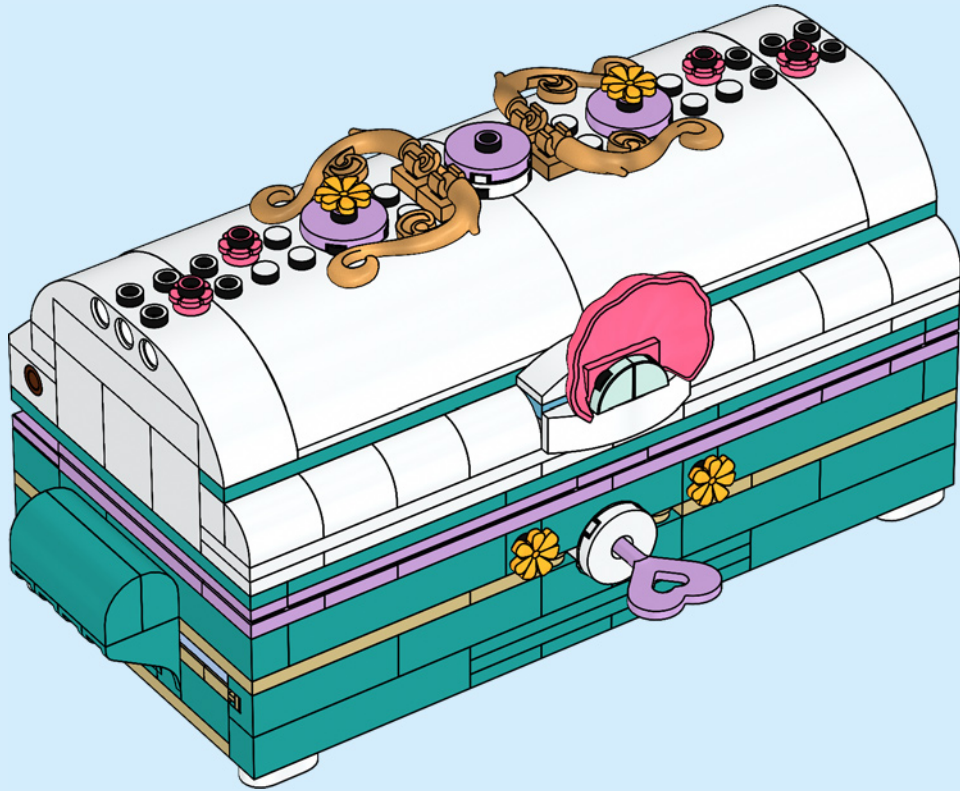

97

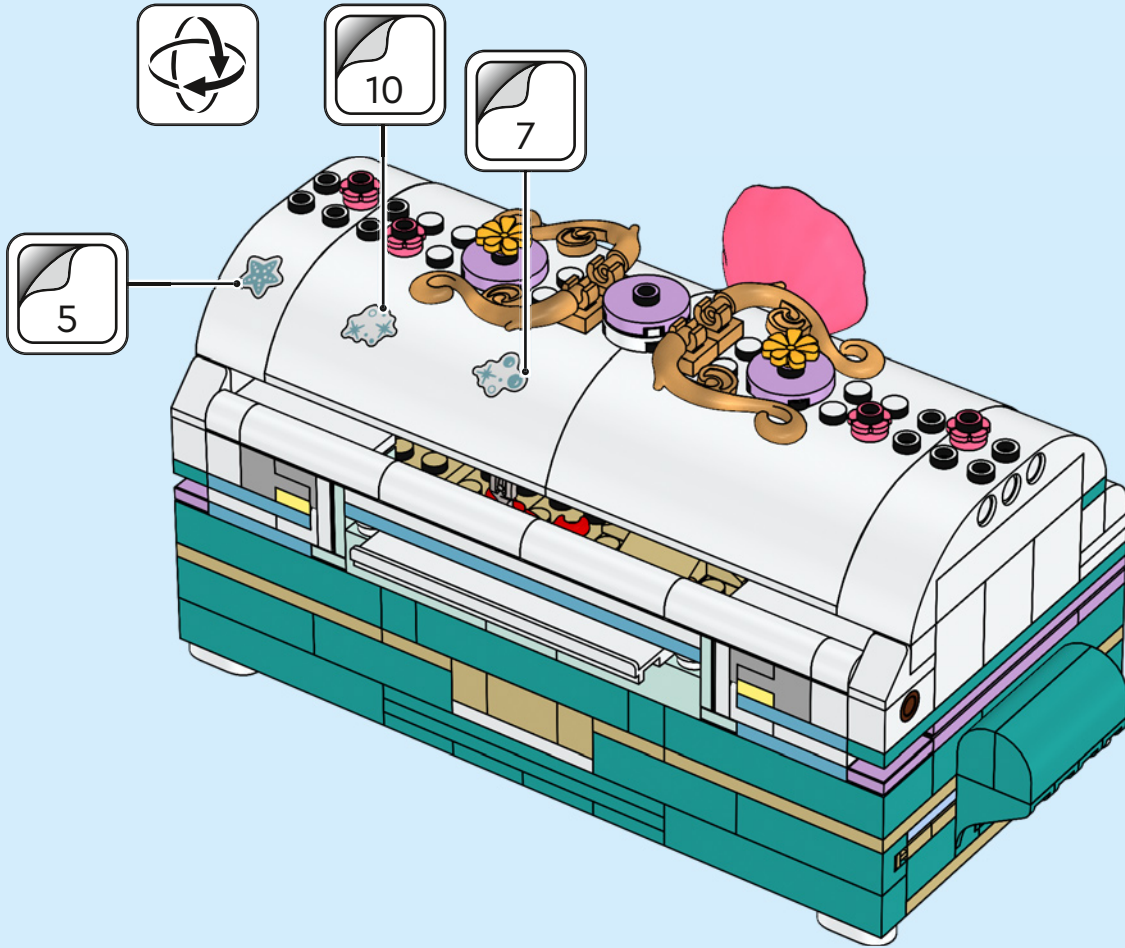

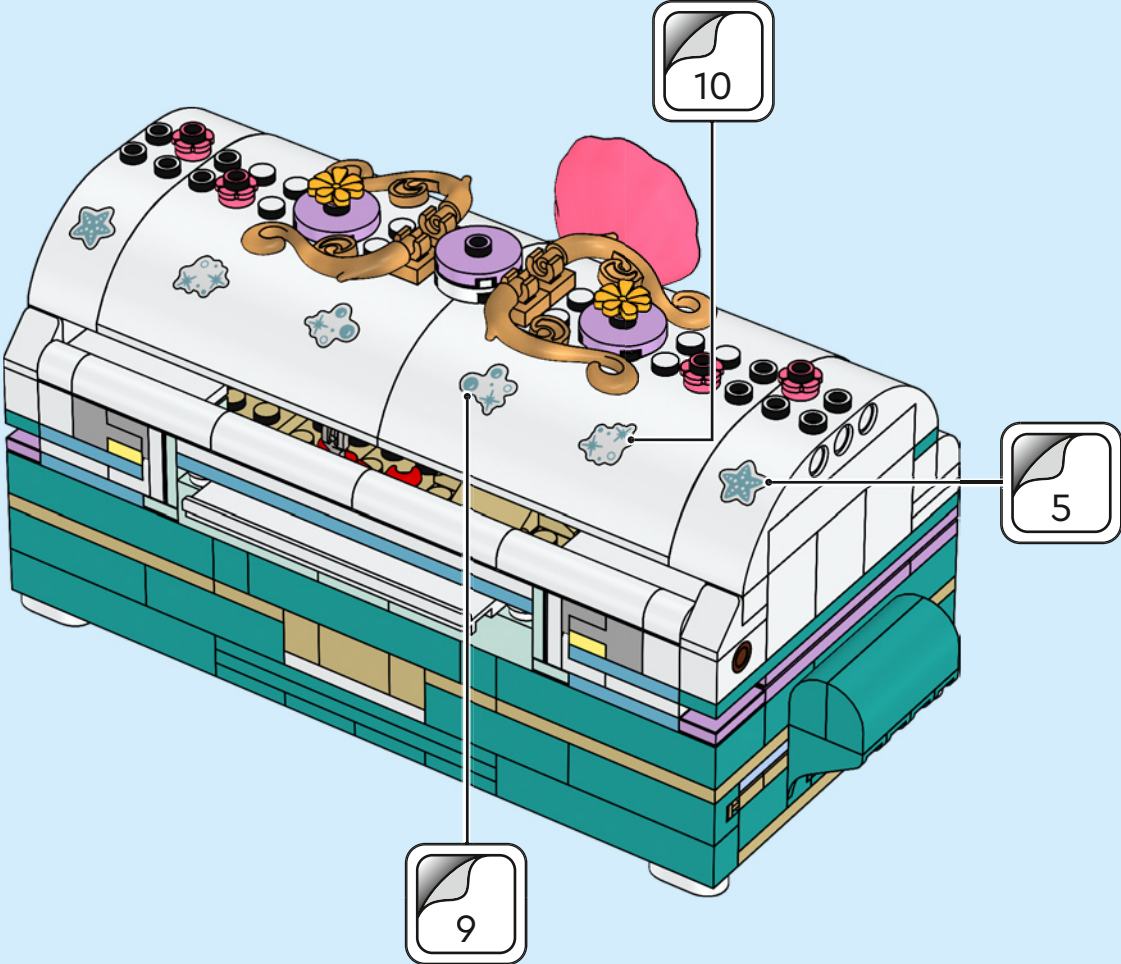

99

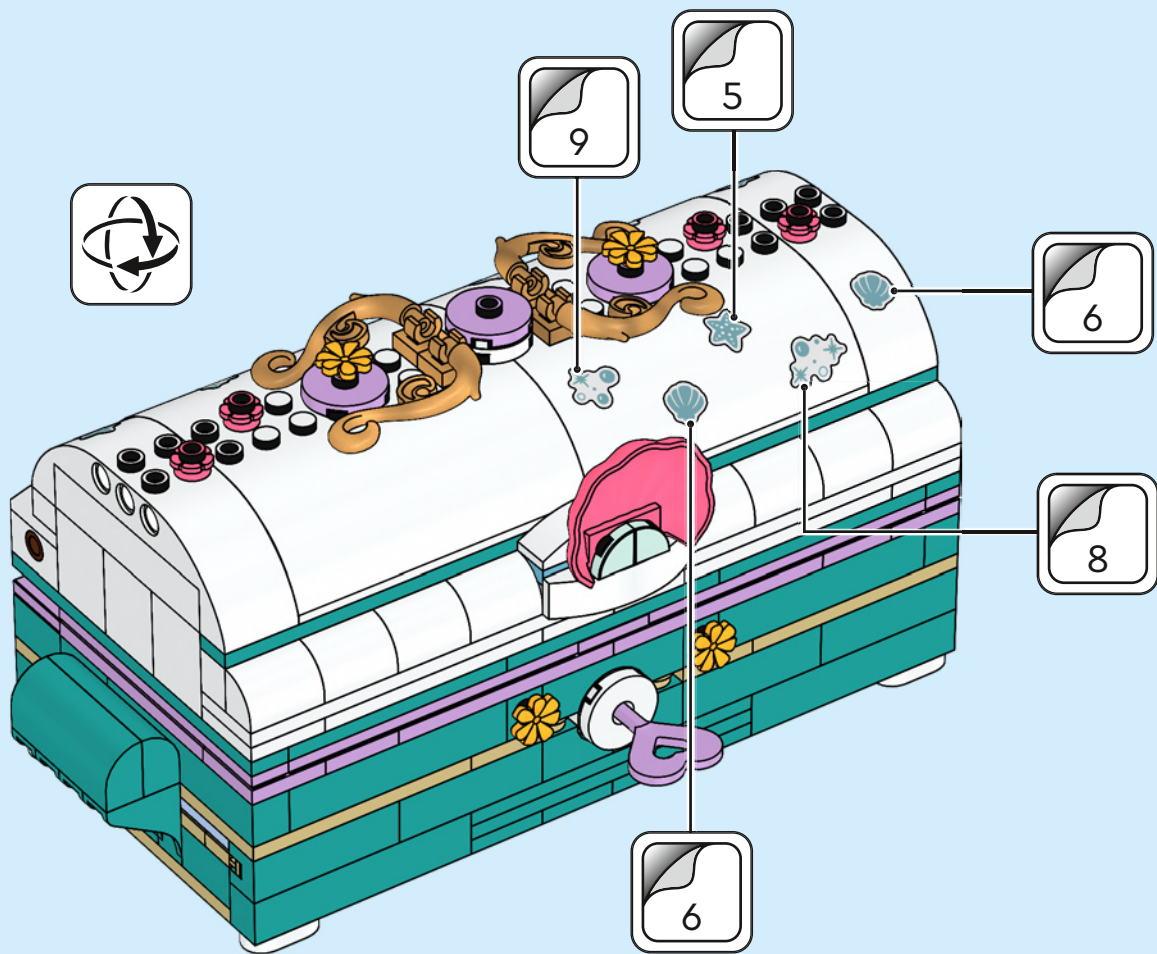

100

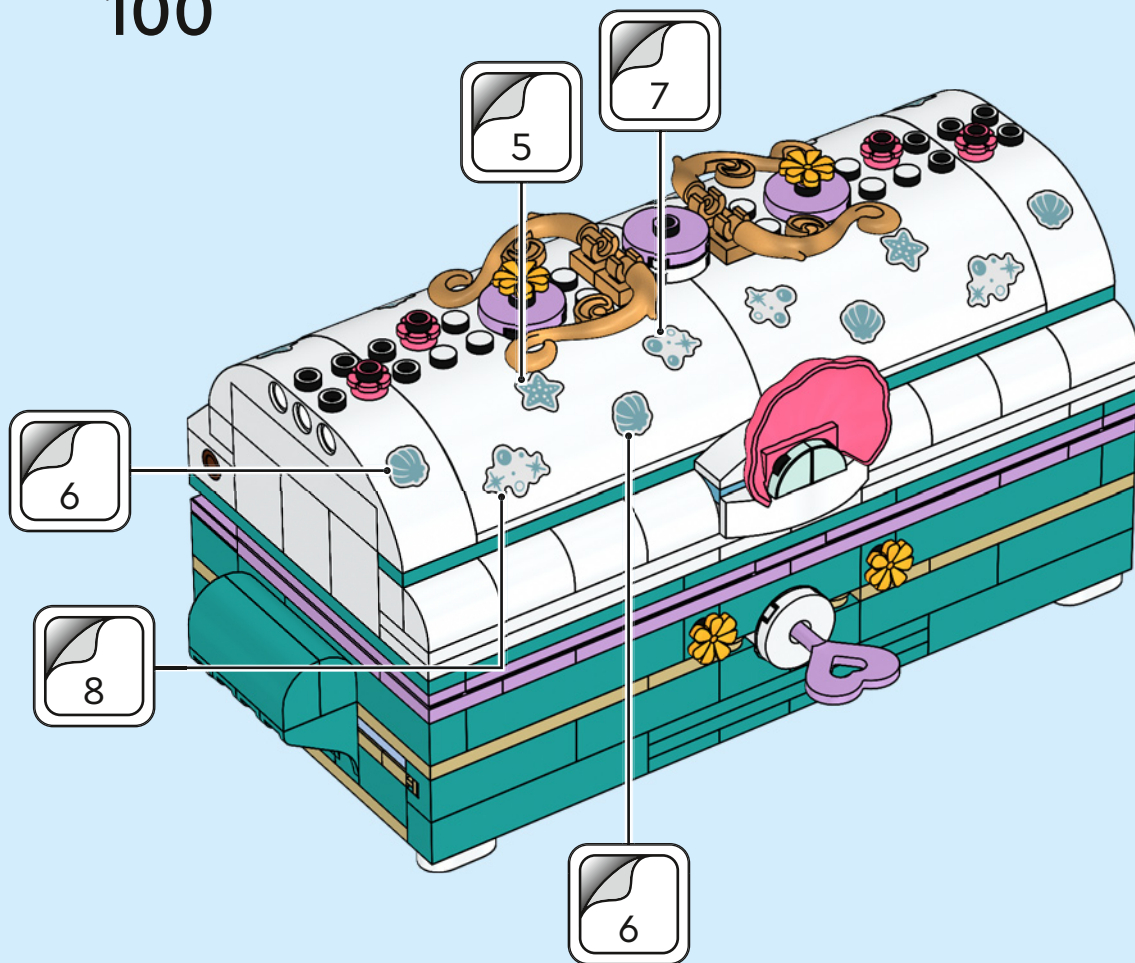



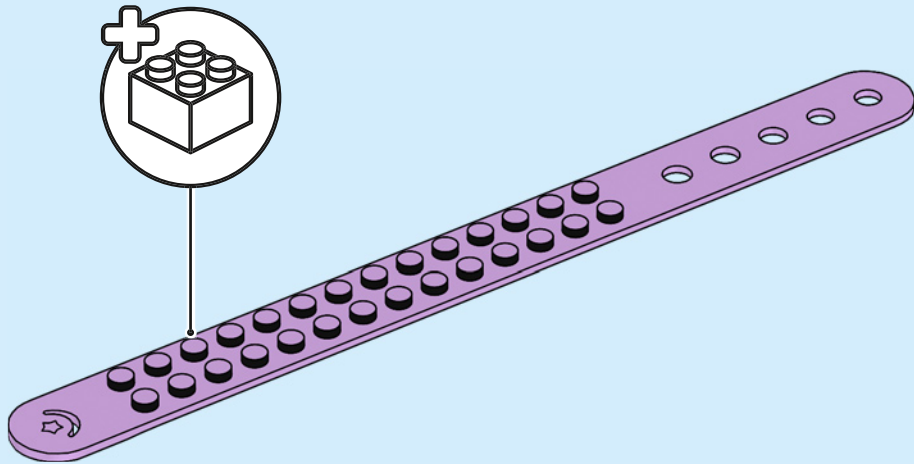



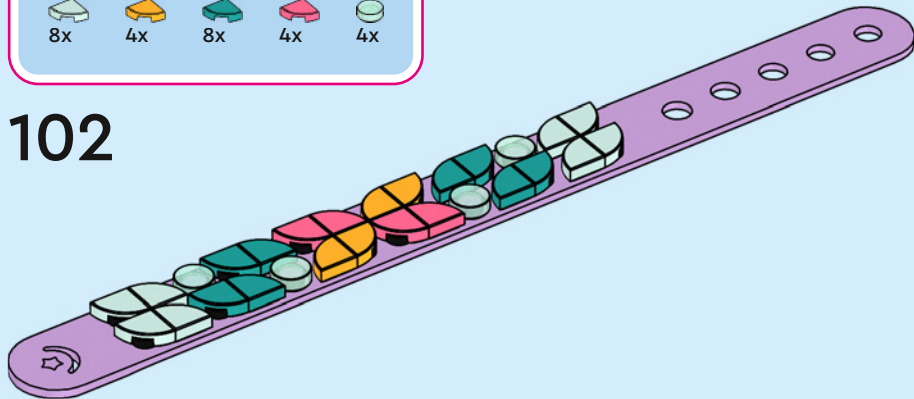











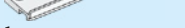











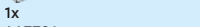
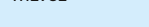









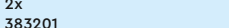
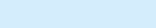











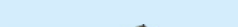



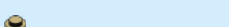
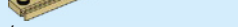



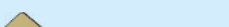
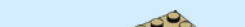

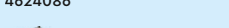
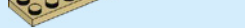

101

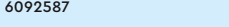

102

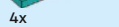

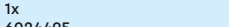

 2x 614101	 2x 6178921	 1x 4500878	 1x 4113233	 1x 368021	 2x 6431332
 2x 6383985	 2x 6070698	 1x 447701	 2x 4112982	 1x 6253363	 4x 6213777
 2x 6258135	 4x 242001	 1x 383201	 1x 4181134	 6x 6279875	 12x 6217659
 1x 6440861	 1x 6238334	 2x 302201	 2x 4159774	 6x 6206150	 3x 6314091
 15x 6210272	 4x 302201	 2x 4284006	 4x 4161443	 2x 6182261	 2x 6249419
 1x 403201	 2x 6023806	 6x 4161734	 2x 4249019	 1x 6336855	 8x 6290542
 8x 4278271	 4x 6378416	 3x 4624086	 2x 4624223	 1x 4666352	 8x 6440301
 1x 614301	 2x 371001	 2x 6092587	 1x 6024495	 2x 4159007	 1x 6253876
 6x 4585458	 2x 243101	 1x 6024495	 2x 6240467	 2x 6213781	 4x 6350418
 2x 370001	 2x 300901	 2x 6313119	 1x 4114084	 1x 6278172	 4x 6217667
 2x 6069002	 2x 366601	 1x 4114084	 8x 4121921	 8x 6240467	 3x 6291782
 8x 6248827	 2x 6265640	 2x 6313119	 2x 4624185	 1x 6390201	 12x 6396079
 2x 300401		 8x 4121921		 2x 6228967	

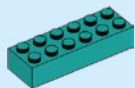

3x
6249420



4x
6259921



4x
6433414

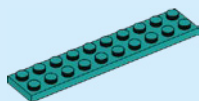

2x
6249538



1x
6240042



1x
6247799



1x
6300320



1x
6426063



3x
6209681



4x
6212994



4x
6214457



1x
6248944



2x
6135494



1x
4540203



2x
6266209



1x
6123809



2x
4654582



2x
6326478



2x
4654577



1x
6299494



8x
6372225

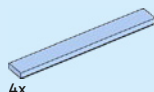

4x
6372121



1x
6096990



2x
6201647



4x
6262138



1x
6326425



1x
6323378



1x
4538126



1x
6147169



4x
6172437



1x
6422779



1x
6447710



1x
6361354



1x
6136419



4x
4619513



2x
6271207



1x
4655256



1x
6423273



10x
6199886



1x
6022032



2x
6133247



2x
6192270



2x
6218162

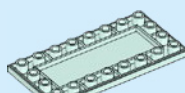

2x
6435048



11x
6295242



4x
6250022



1x
6287639



4x
6299900



1x
6376542



1x
6376535

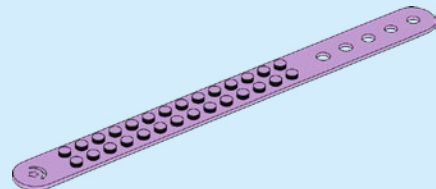

1x
6426229



1x
6385583



3x
6223598



2x
6099190



3x
6345796



2x
6400077



2x
6426723



4x
6204071



4x
6304891



 [LEGO.com/service](https://www.LEGO.com/service)

YOU COULD

WIN



Scan this QR code or go to
LEGO.COM/PRODUCTFEEDBACK and give us
your short feedback about this LEGO® set for a
chance to win a cool LEGO prize.

Terms and Conditions apply*

EN: YOU COULD WIN. Terms and Conditions apply* **DE: Du könntest GEWINNEN.** Es gelten die Teilnahmebedingungen* **FR: Tu pourrais GAGNER.** Des conditions s'appliquent* **IT: Potresti VINCERE tu.** Termini e condizioni sono applicabili* **ES: Puedes GANAR.** Aplican términos y condiciones* **PT: Poderá GANHAR.** Aplicam-se termos e condições* **ZH: 轻松获奖. 条款和条件适用*** **PL: Szansa na WYGRANĄ.** Obowiązują warunki korzystania* **CS: Máte šanci VYHRÁT.** Platí všeobecné smluvní podmínky* **SK: Máte šancu VYHRAŤ.** Platia všeobecné zmluvné podmienky* **HU: TE IS NYERHETSZ.** Felhasználási feltételek érvényesek* **RO: Ai putea CÂȘTIGA.** Se aplică termeni și condiții* **BG: Можете да СПЕЧЕЛИТЕ.** Има определени правила и условия* **LV: Tu vari LAIMĒT.** Ir spēkā noteikumi un nosacījumi.* **ET: Sul on võimalus VÕITA.** Kehtivad tingimused* **LT: Jūs galite LAIMĖTI.** Taikomos sąlygos*

*[LEGO.com/productfeedback-terms](https://www.lego.com/productfeedback-terms)