



# Disney

43215



1



**WARNING: CHOKING HAZARD.** Toy contains small parts and a small ball. Not for children under 3 years.



### **Get excited about our new packaging!**

We're switching from plastic to paper-based packaging. That's why you might find a mix of paper and plastic in our boxes!

### **Nos nouveaux emballages vous emballeront !**

Nous passons des emballages en plastique aux emballages à base de papier. C'est pourquoi vous pourriez trouver un mélange de papier et de plastique dans nos boîtes !

### **¡Te presentamos nuestros nuevos empaques!**

Estamos sustituyendo las bolsas de plástico por bolsas con base de papel. ¡Por eso, puedes encontrar una mezcla de papel y de plástico en nuestras cajas!

**[LEGO.com/sustainable-packaging](https://www.lego.com/sustainable-packaging)**



# BUILDER



Apple and the Apple logo are trademarks of Apple Inc., registered in the U.S. and other countries and regions. App Store is a service mark of Apple Inc. Google Play and the Google Play logo are trademarks of Google LLC. Tencent and the Tencent logo are trademarks of Tencent Inc.

Q [LEGO.com/devicecheck](https://www.lego.com/devicecheck)

**EN** Ask parents' permission before going online | **DE** Eltern um Erlaubnis bitten, bevor du online gehst | **FR** Demande l'autorisation d'un parent avant d'aller en ligne | **IT** Chiedi il permesso ai tuoi genitori prima di andare online | **ES** Pídeles permiso a tus papás antes de conectarte a Internet | **PT** Peça autorização aos pais antes de acederes online | **ZH** 上网前应先征得父母的同意 | **PL** Poproś rodziców o zgodę, zanim wejdiesz do Internetu | **CS** Než půjdeš na internet, požádej rodiče o svolení | **SK** Skôr než pôjdeš na internet, vypýtaj si povolenie od rodičov | **HU** Kérj szülői engedélyt, mielőtt online csatlakoznál! | **RO** Cere permisiunea părinților înainte de a te conecta online | **BG** Поискайте разрешение от родител, преди да влезете онлайн | **LV** Pirms došanās tiešsaistē palūdz atļauju vecākiem | **ET** Enne Interneti kasutamist küsi vanematelt luba | **LT** Prieš prisijungdami prie interneto, atsklauskite tėvų

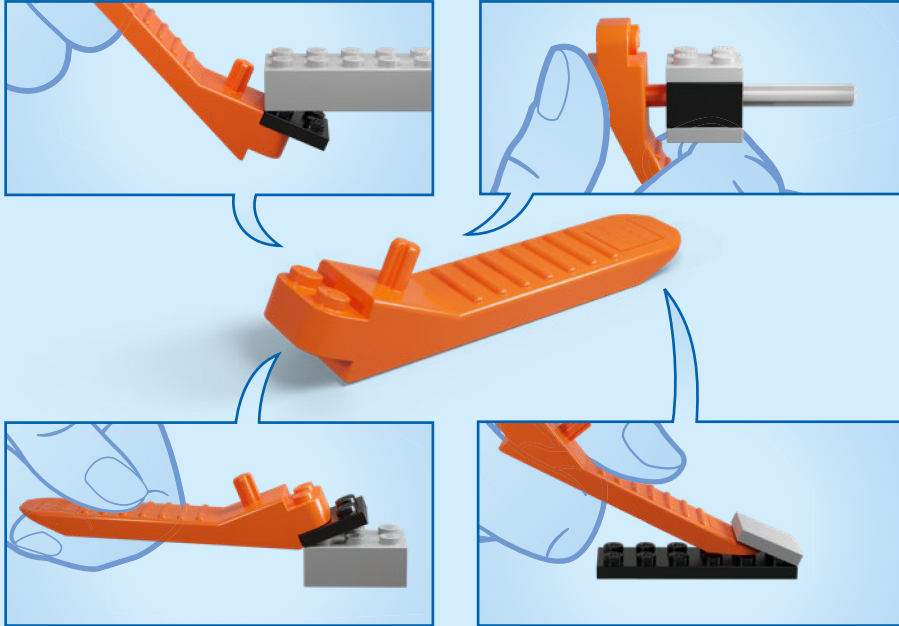

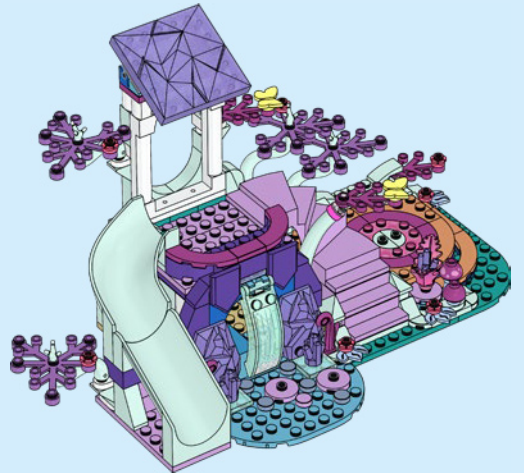
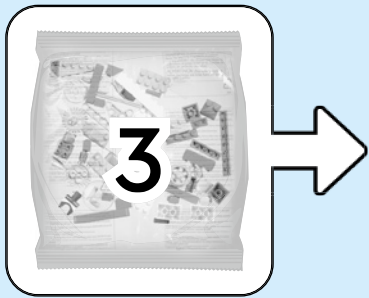
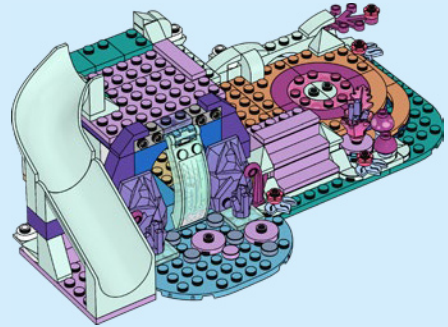
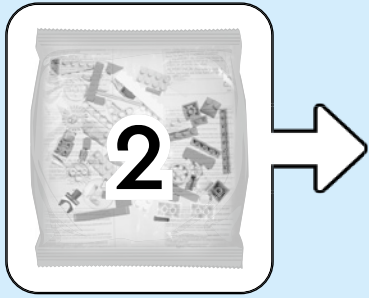
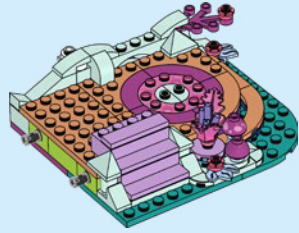
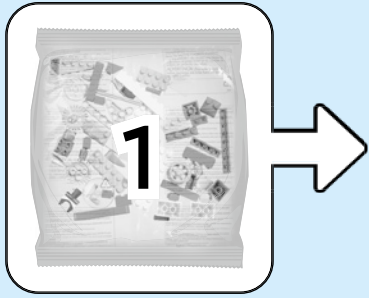



**AVERTISSEMENT :**  
**RISQUE D'ÉTOUFFEMENT.**

Le jouet contient des petites pièces ainsi qu'une petite boule. Il ne convient pas aux enfants de moins de 3 ans.



**ADVERTENCIA:**  
**PELIGRO DE ASFIXIA.**

Juguete que contiene partes pequeñas y una pelota pequeña. No recomendado para niños menores de 3 años.

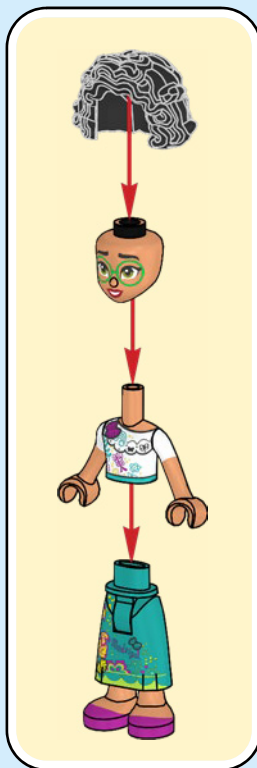

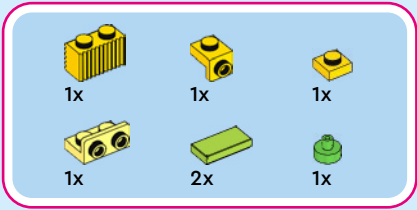

1

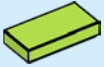

2



3

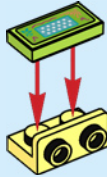

4



5



6



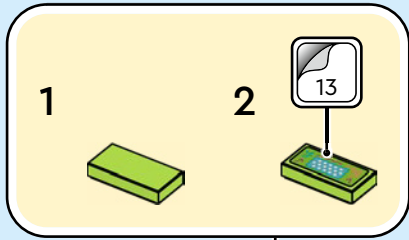

7

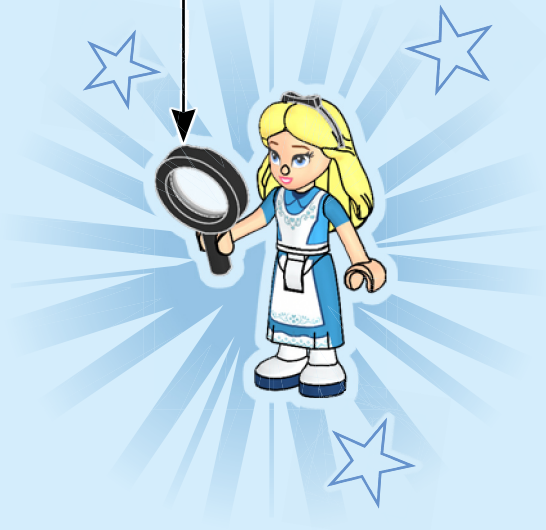



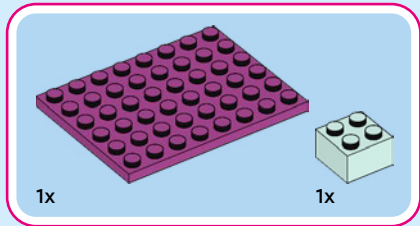
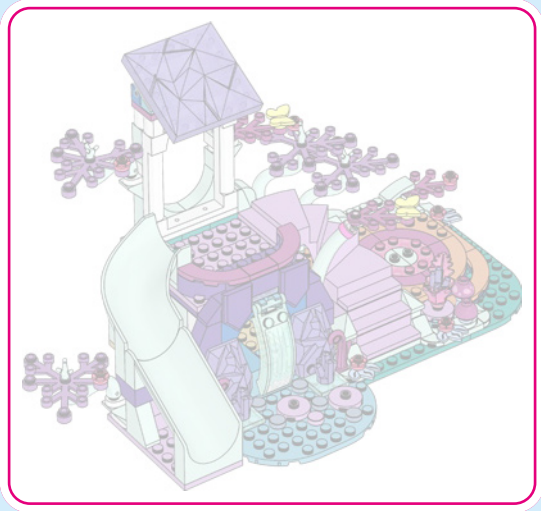

1

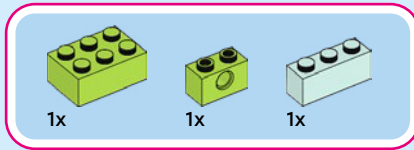
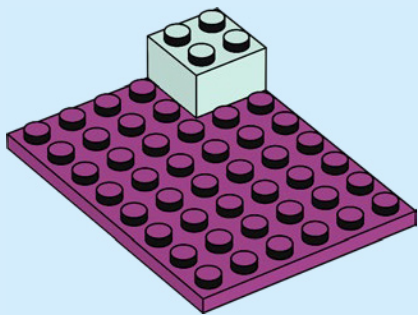

2

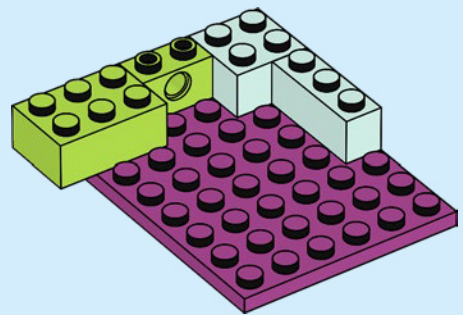

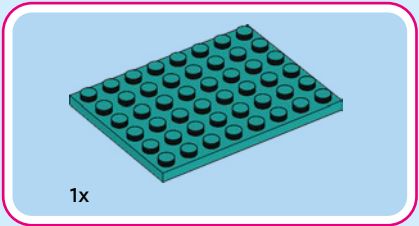

3

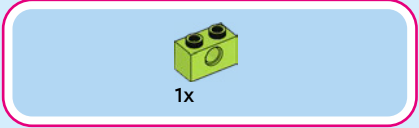
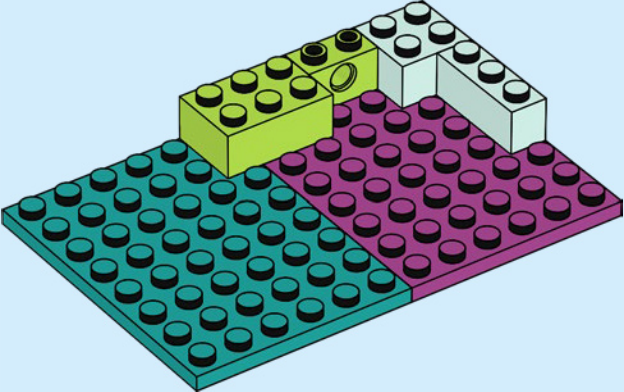

4

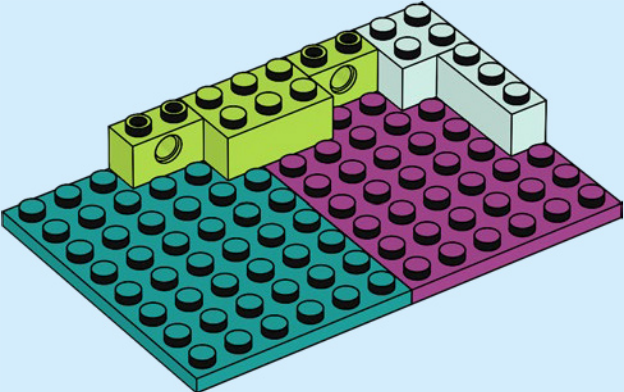

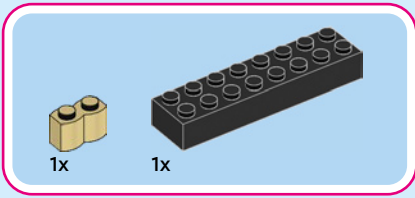

5

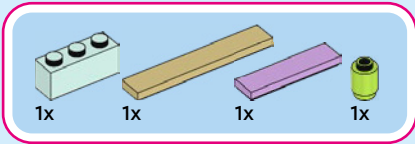
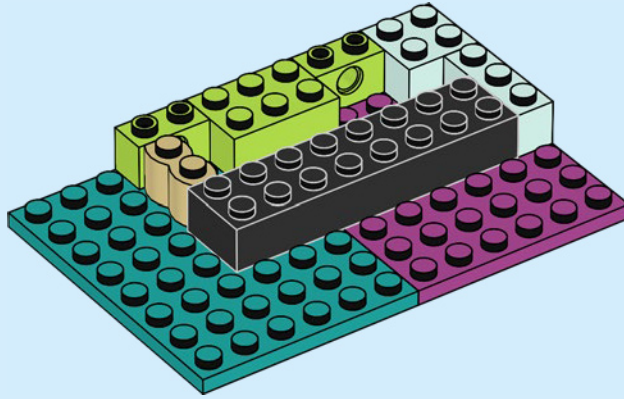

6

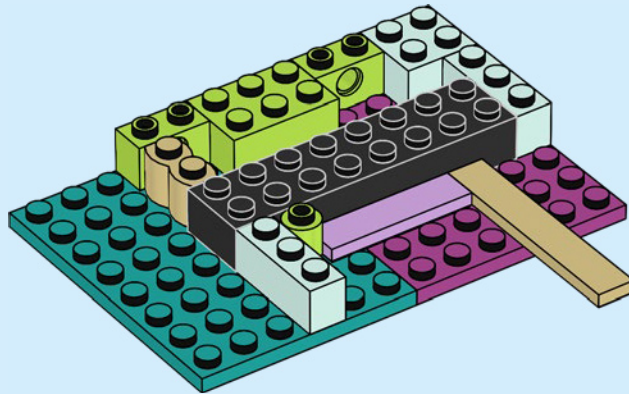

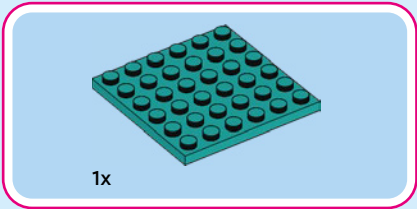

7

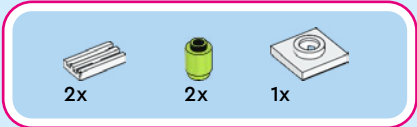
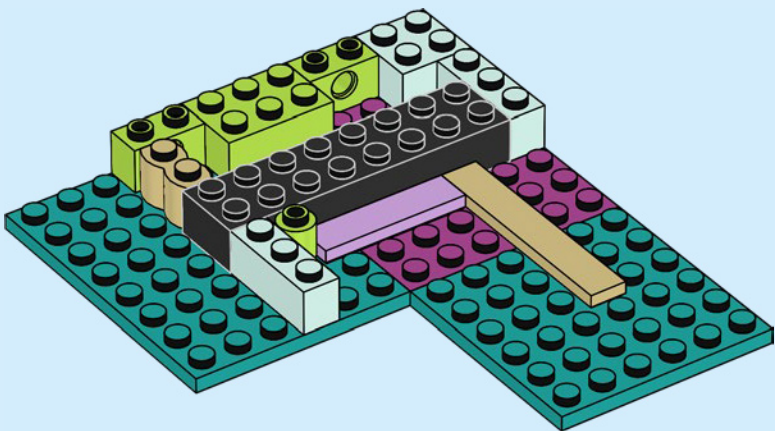

8

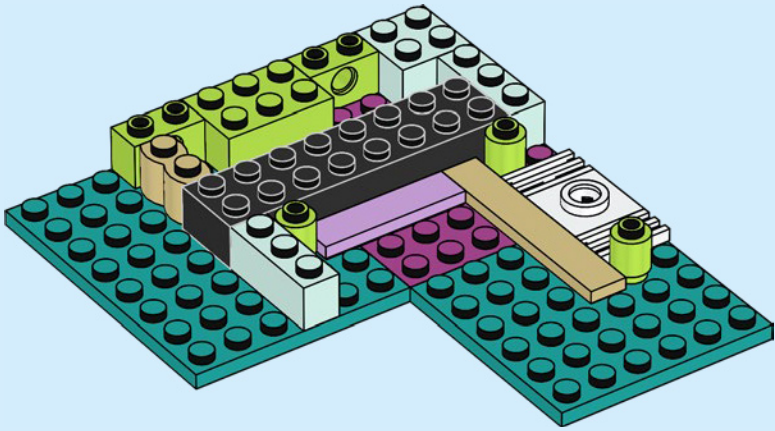

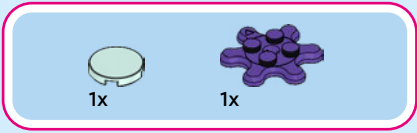

9

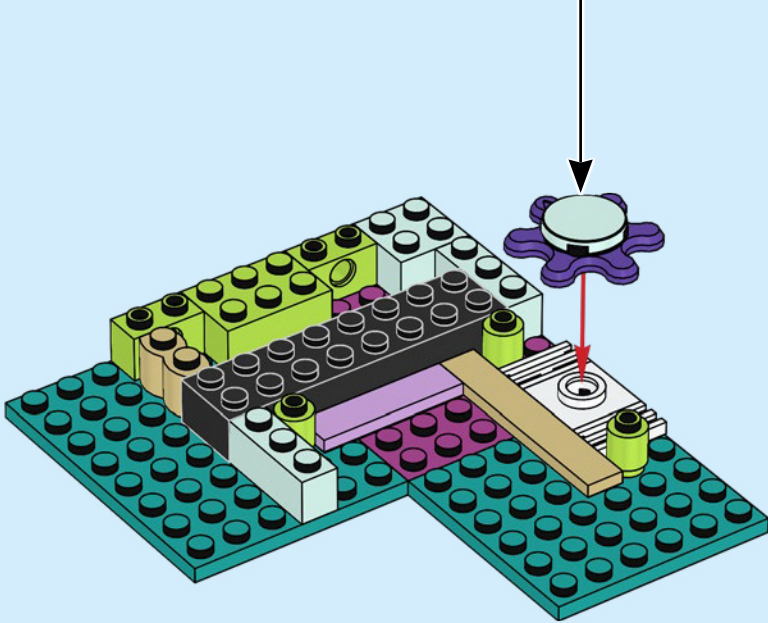
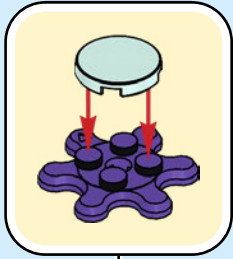

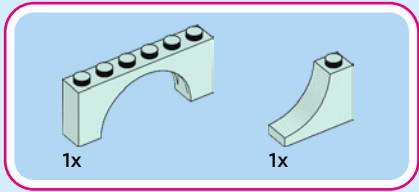

10

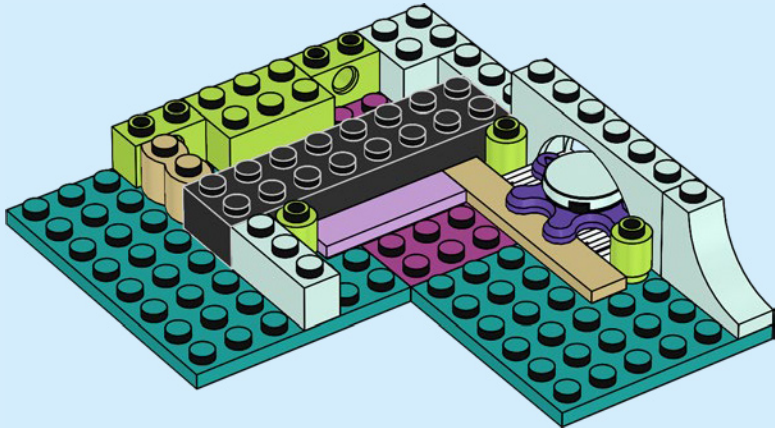

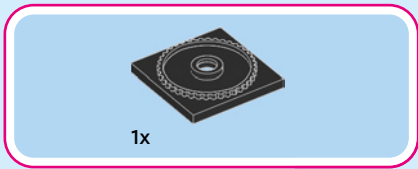

11

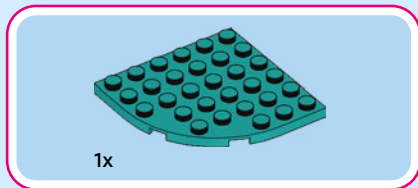
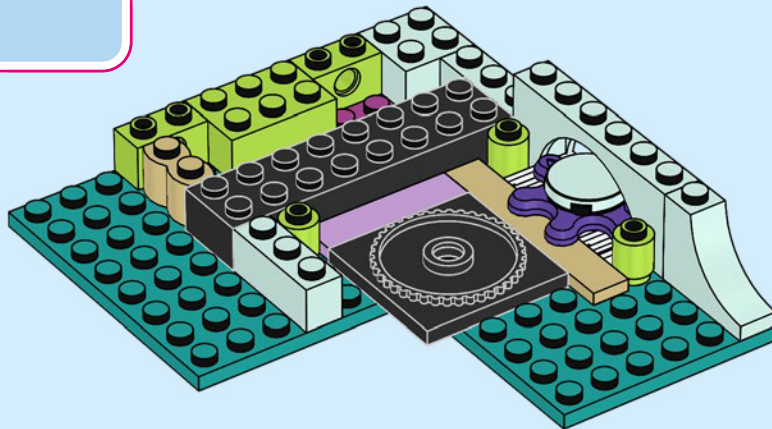

12

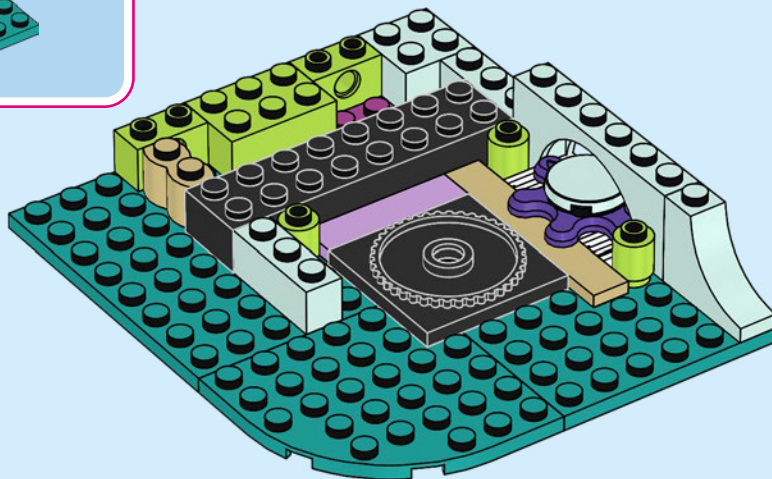



1x

13

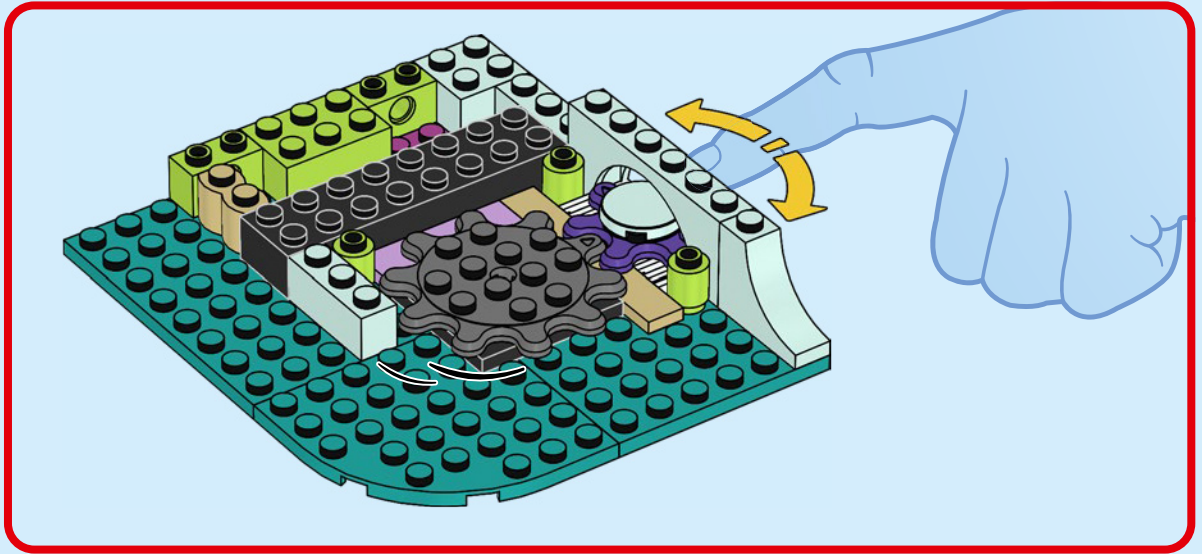
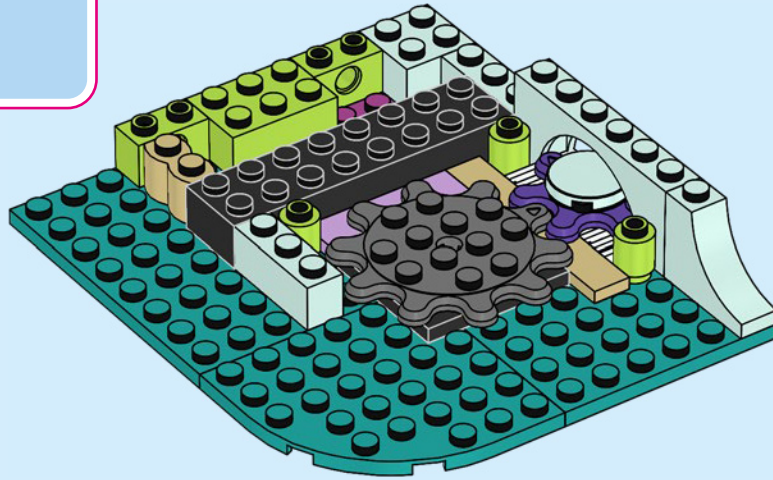



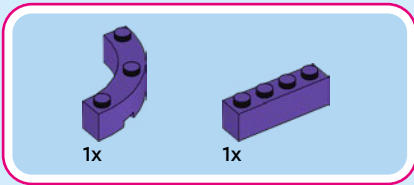

14

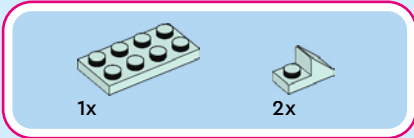
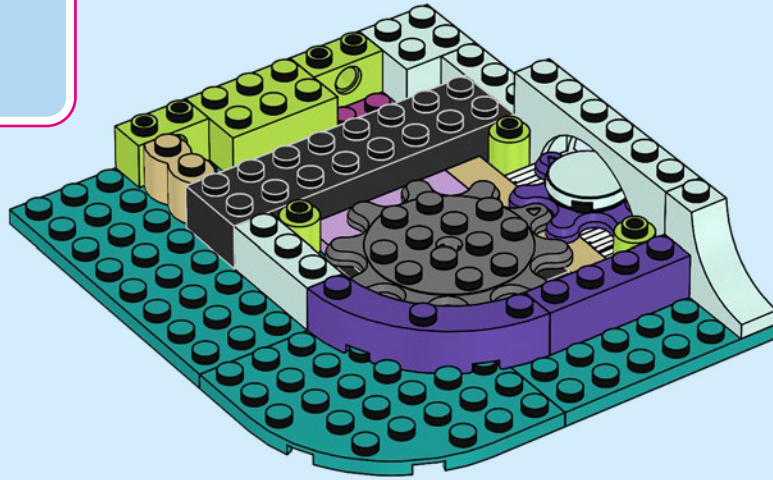

15

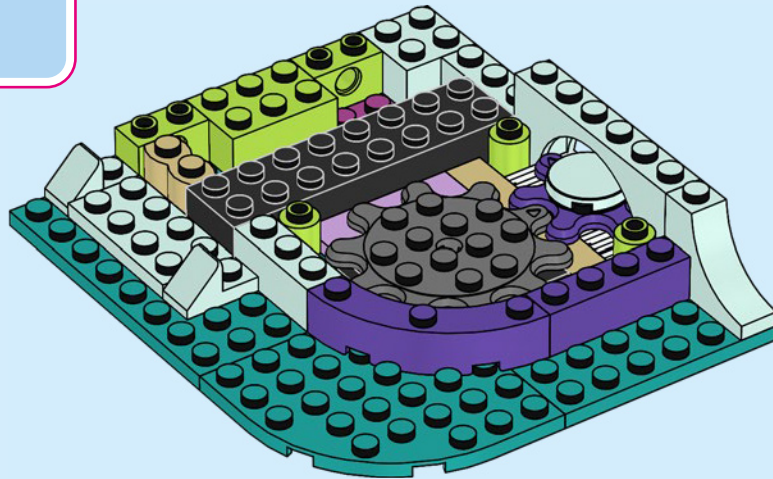

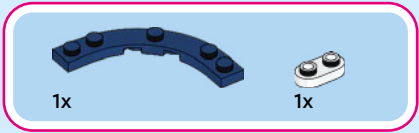

16

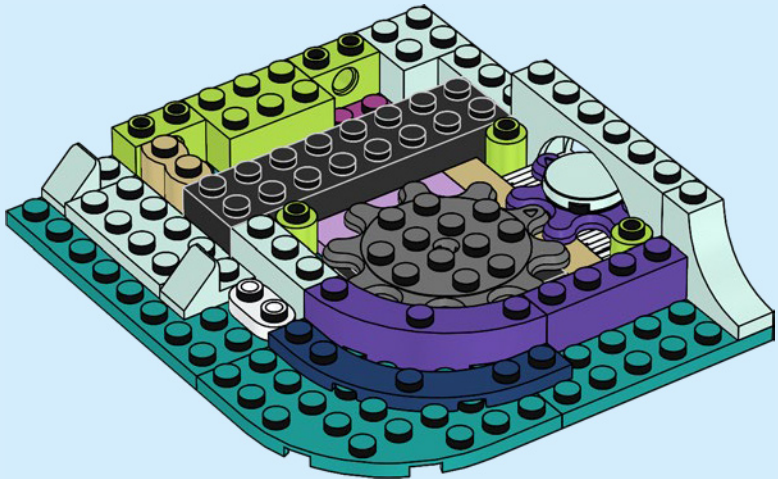



1x



1x

17

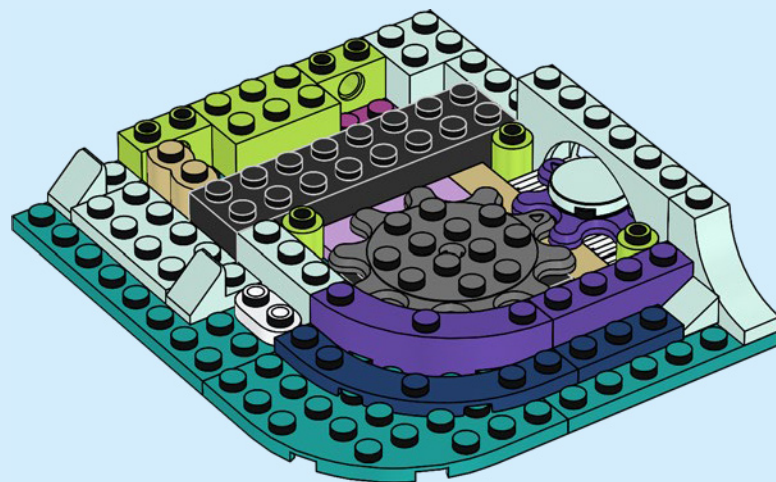

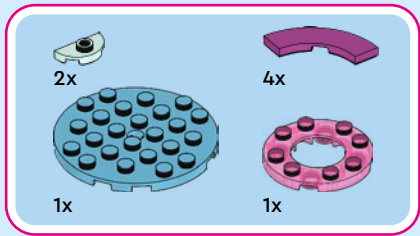

18

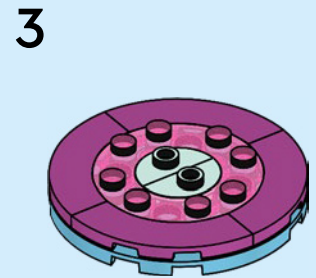
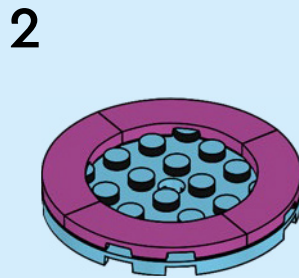
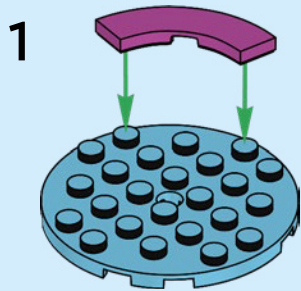

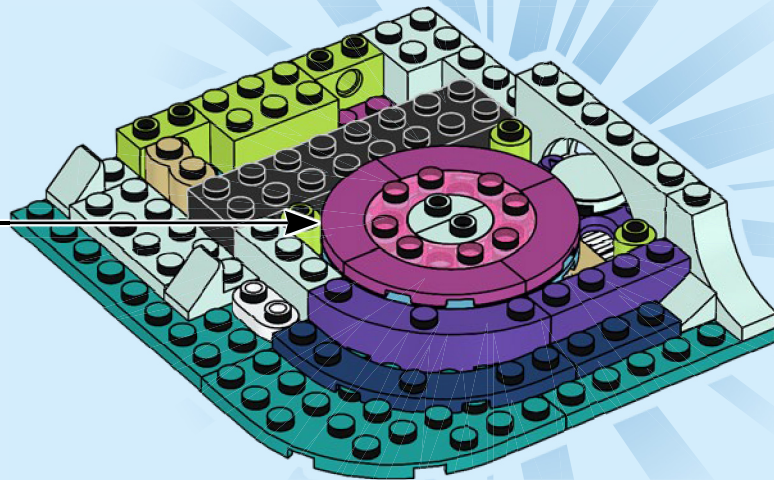

2x

1x

1x

19

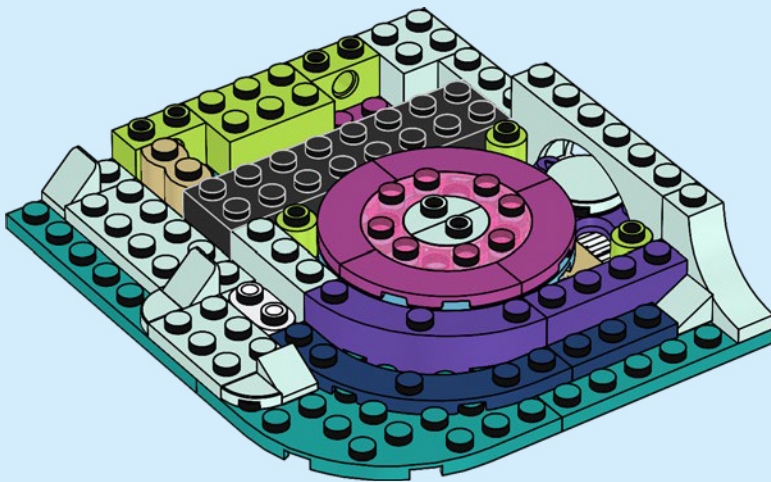

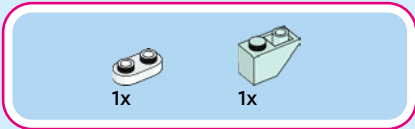

20

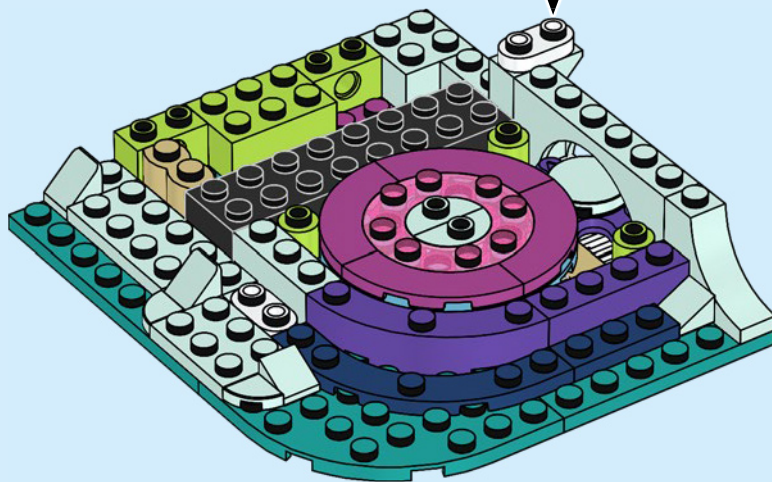
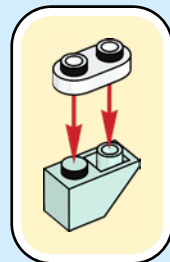

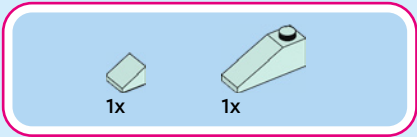

21

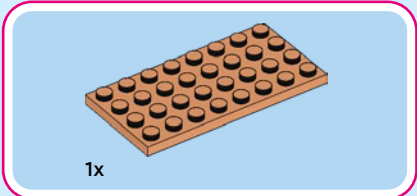
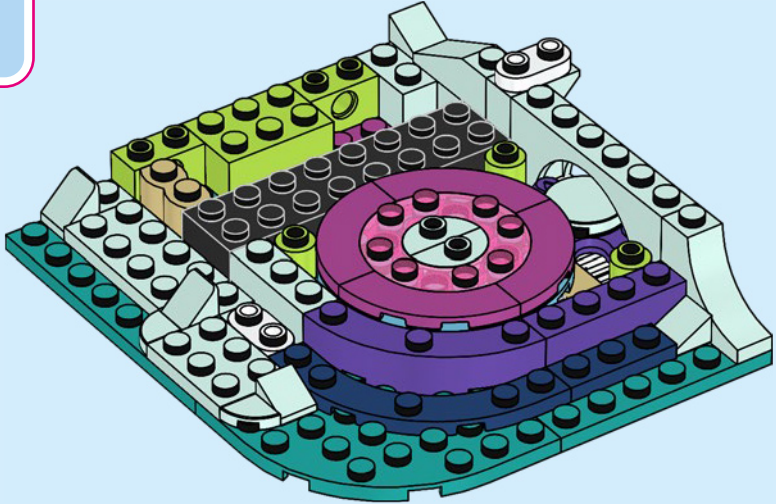

22

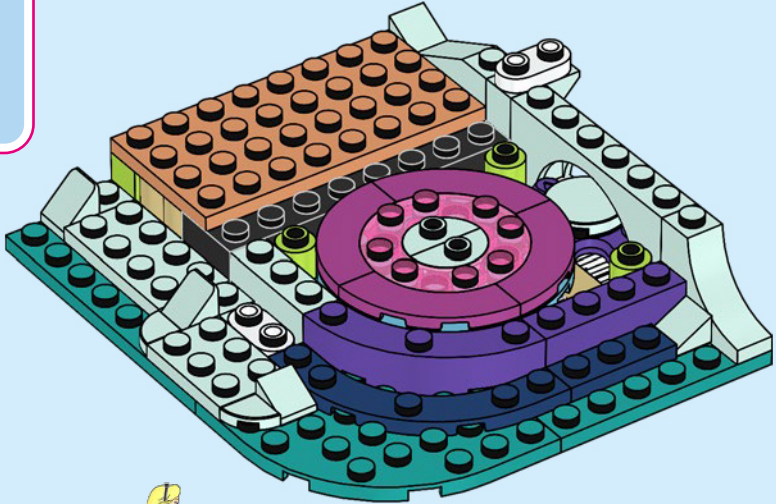



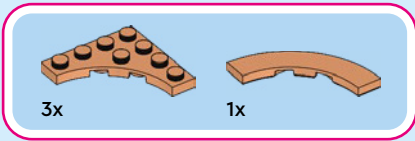

23

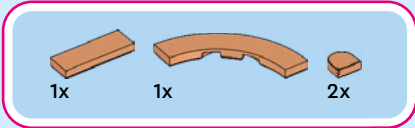
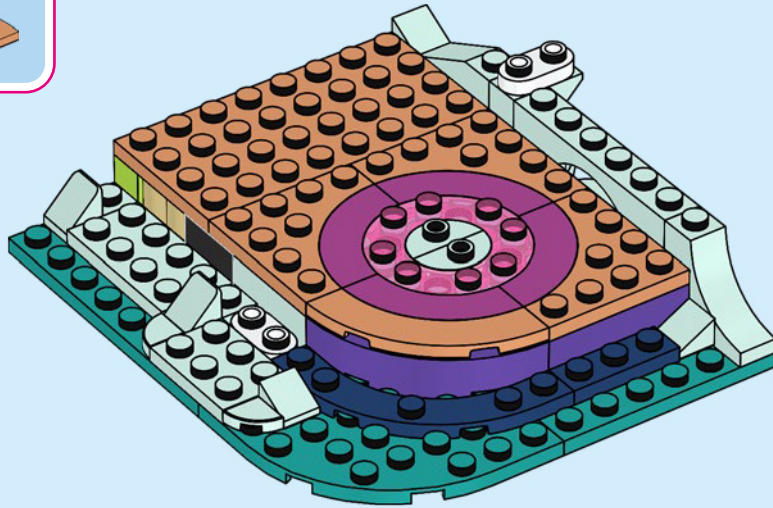

24

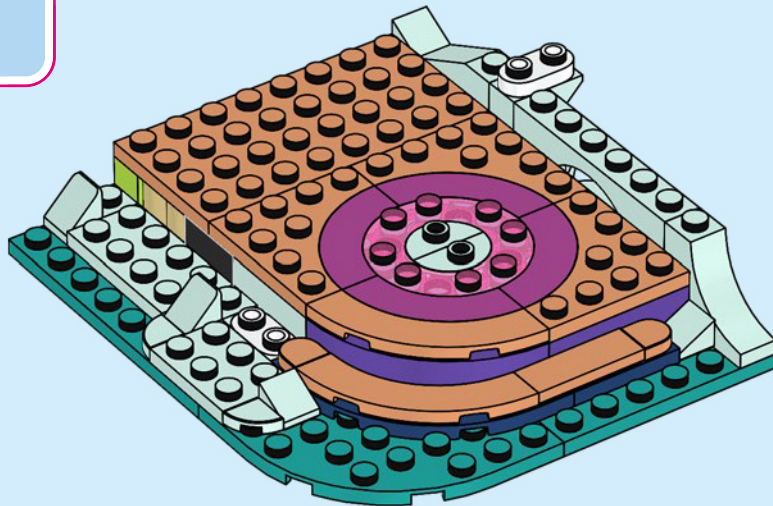

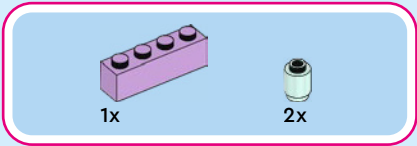

25

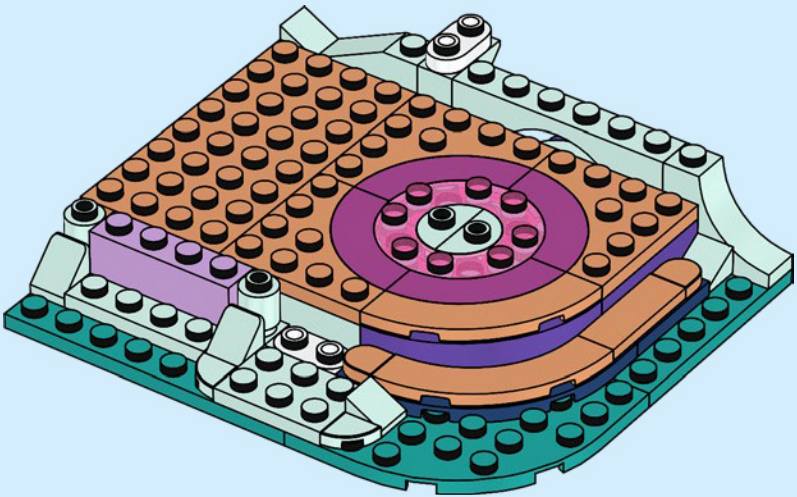



3x



1x

26

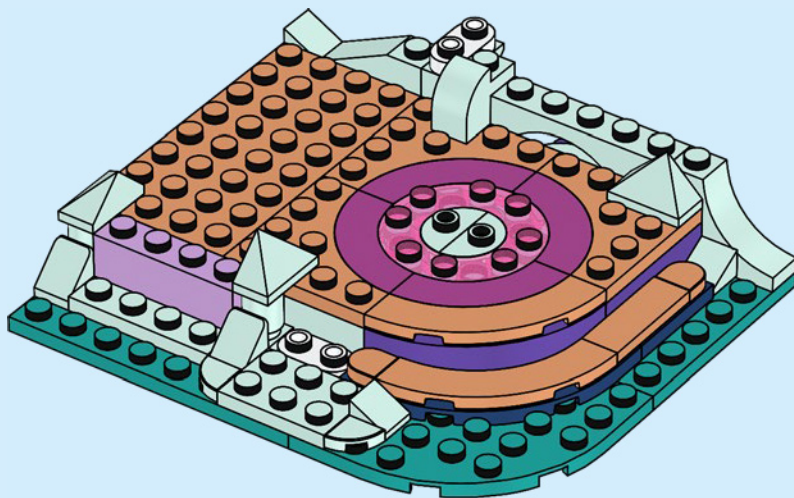

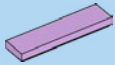

2x

27

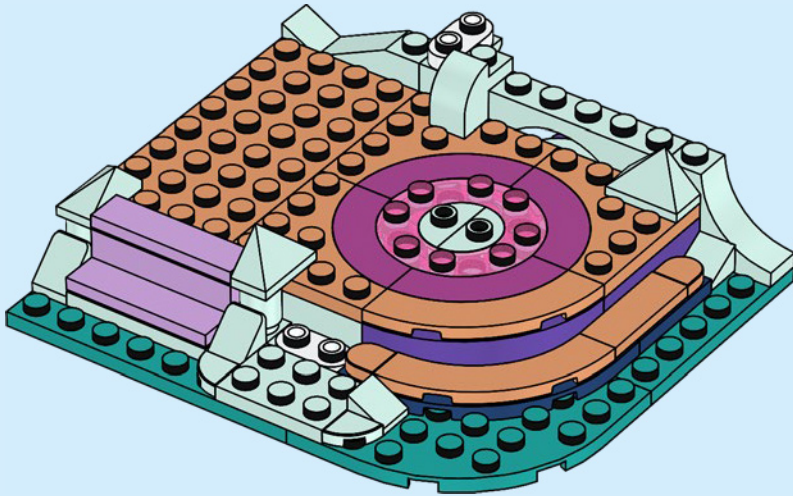

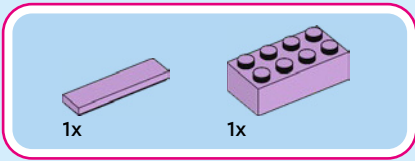

28

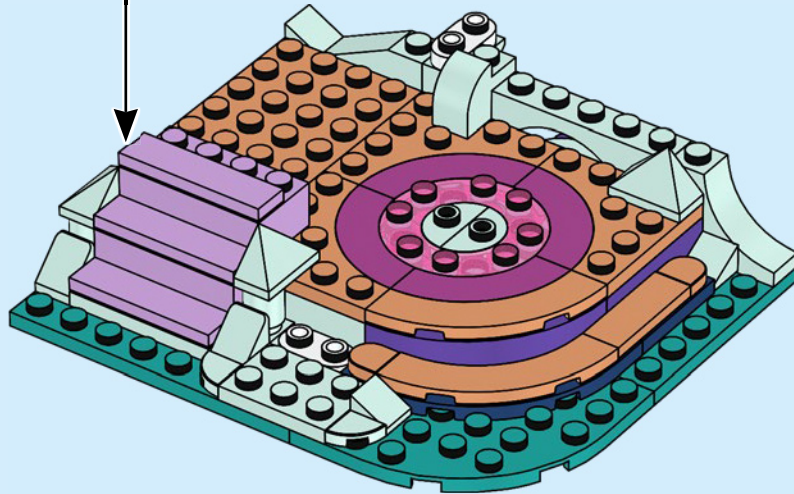
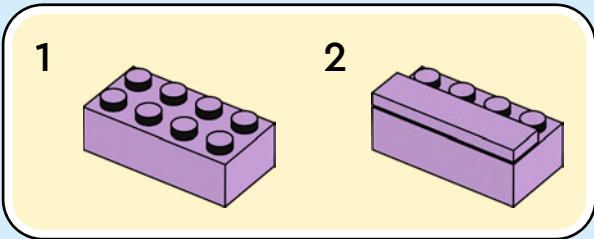

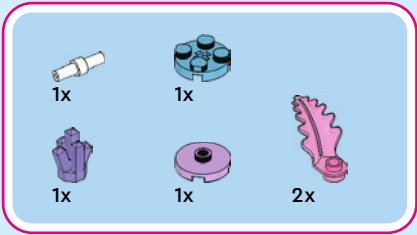

29

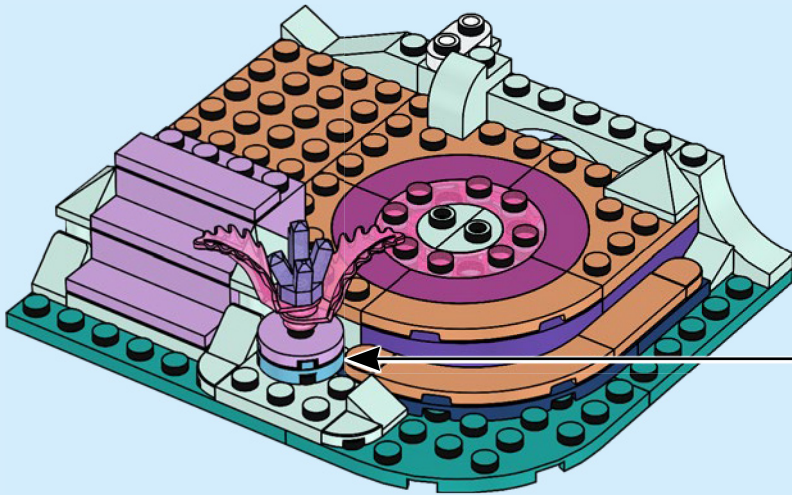
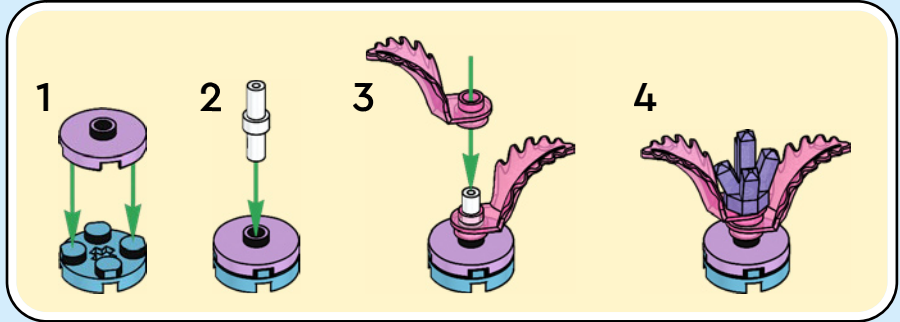



1x

30

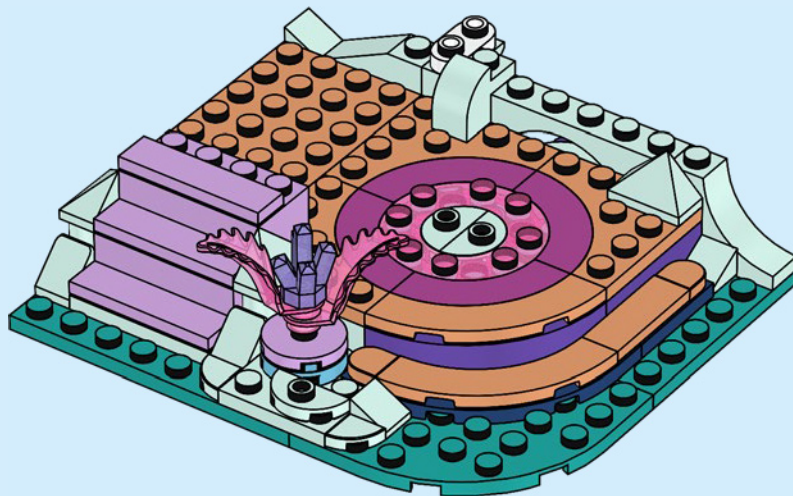



2x



2x

31

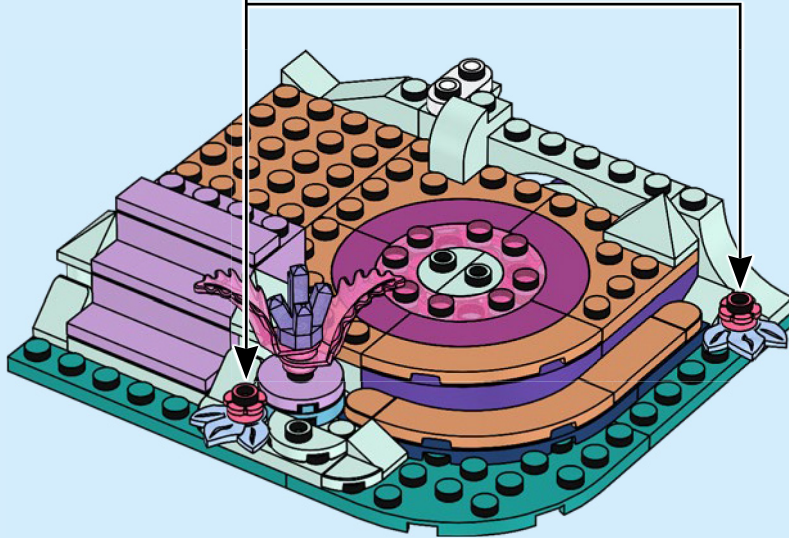
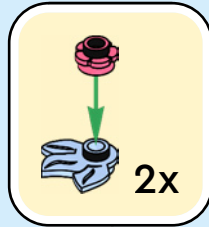





1x



1x

# 32

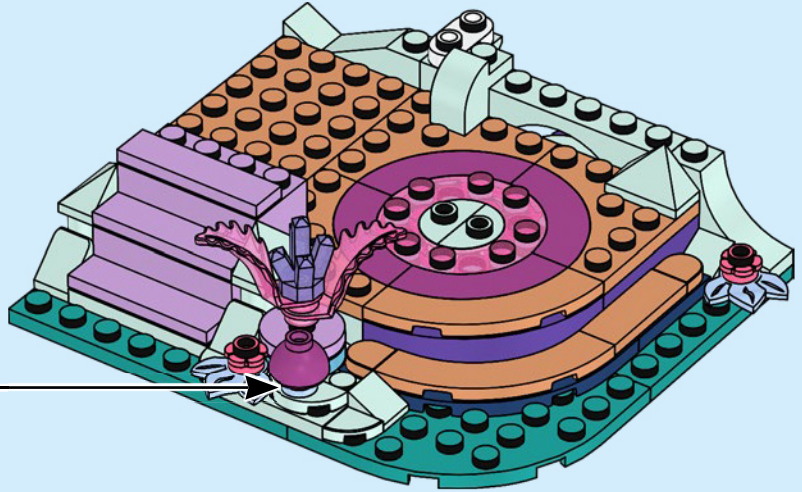
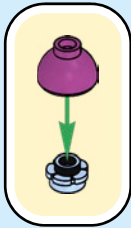

1x



1x



1x

# 33

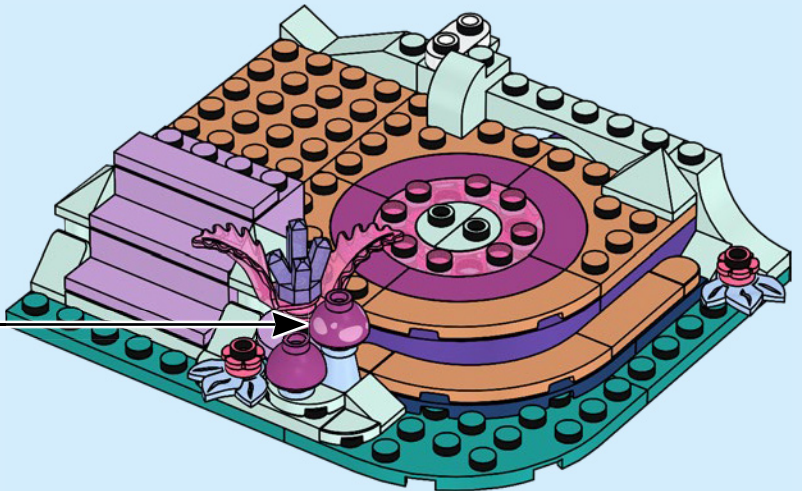
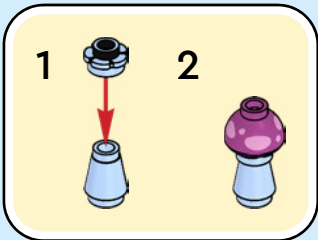



1x



1x

# 34

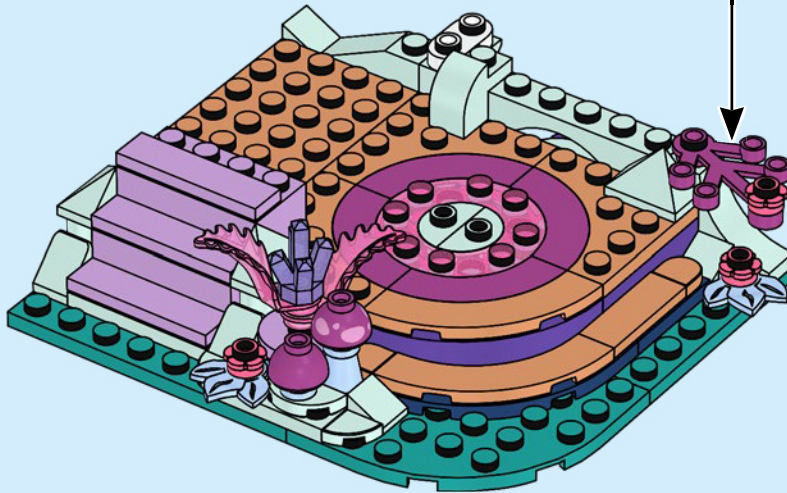
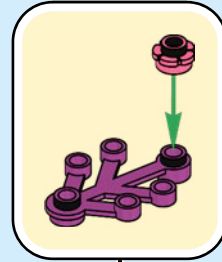



3x

35

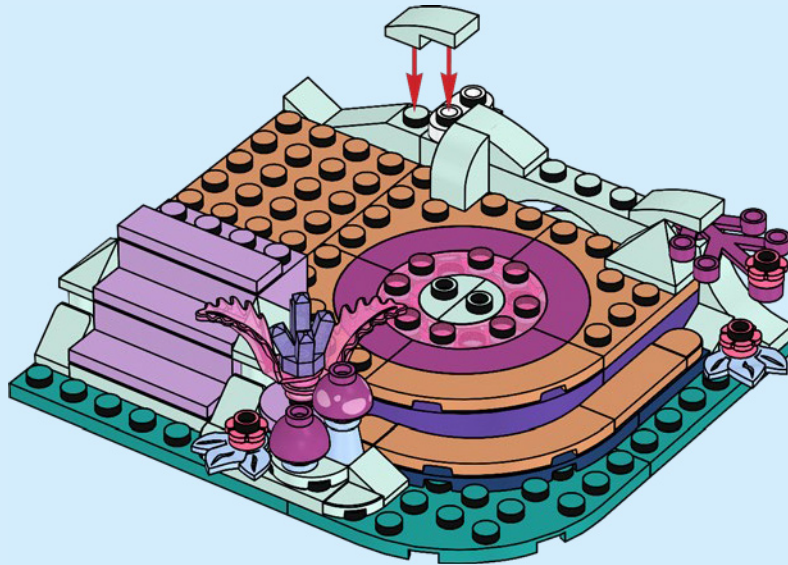



2x

36

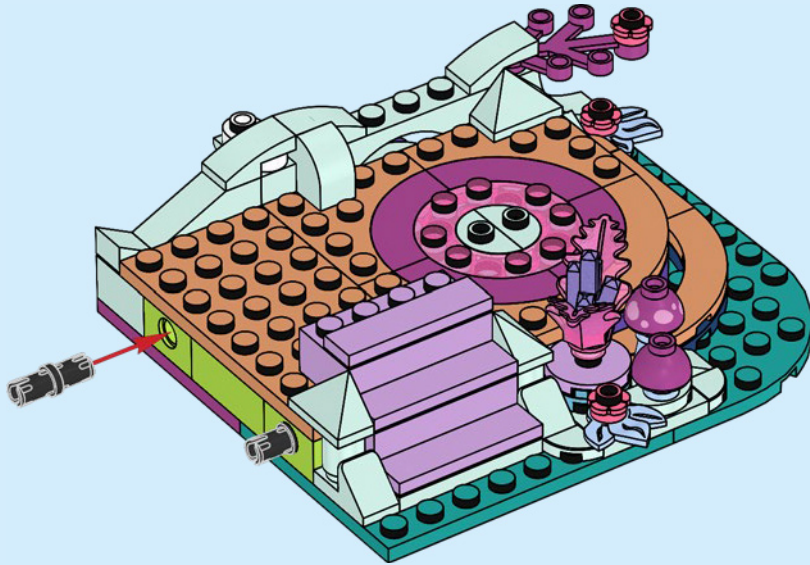

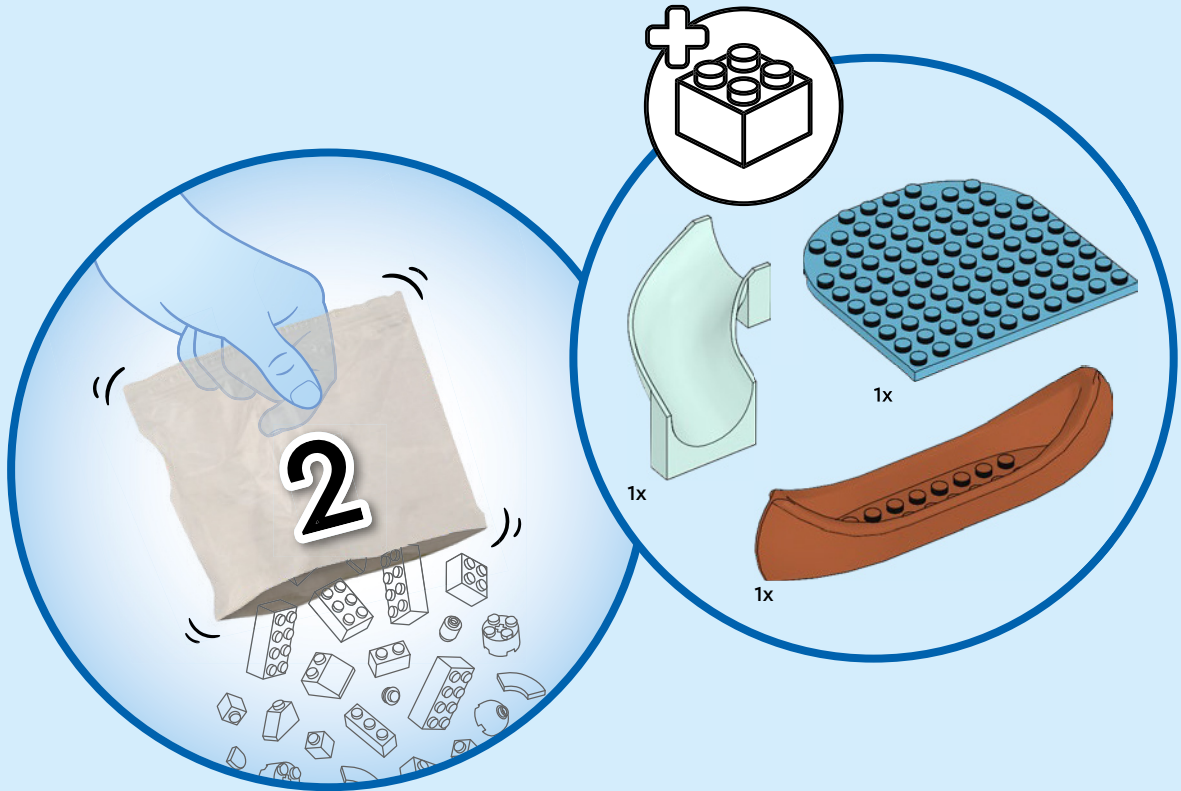

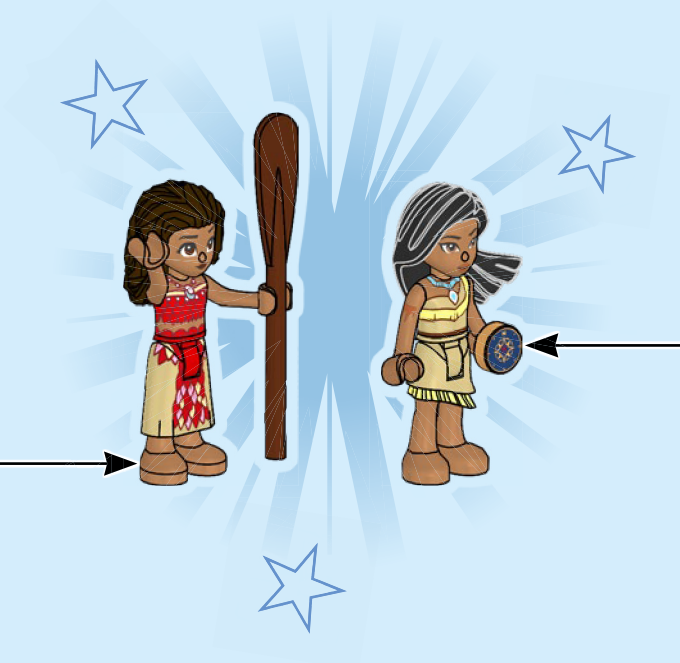
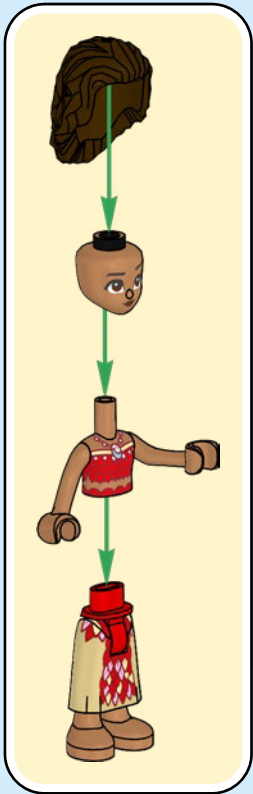

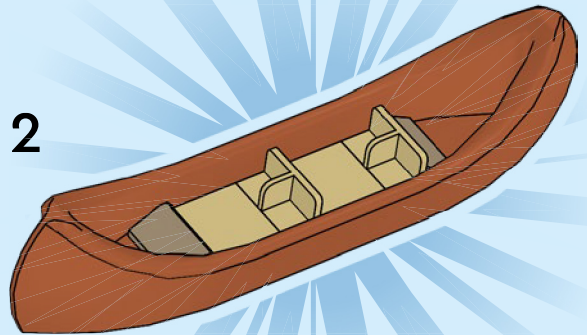
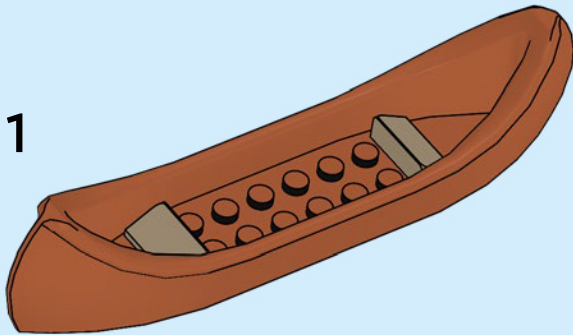
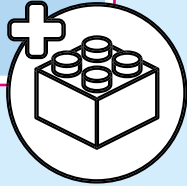
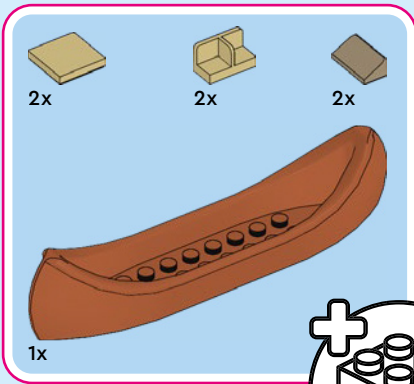





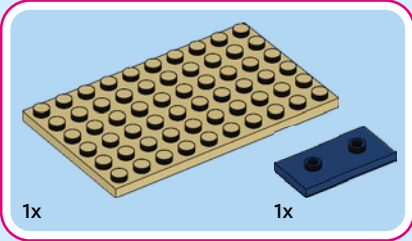
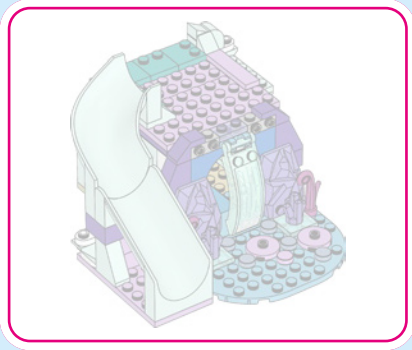

37

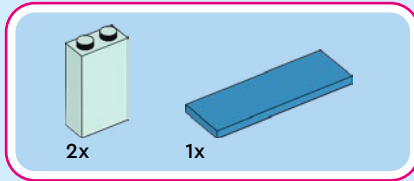
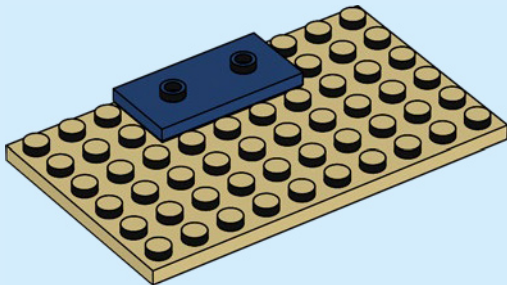

38

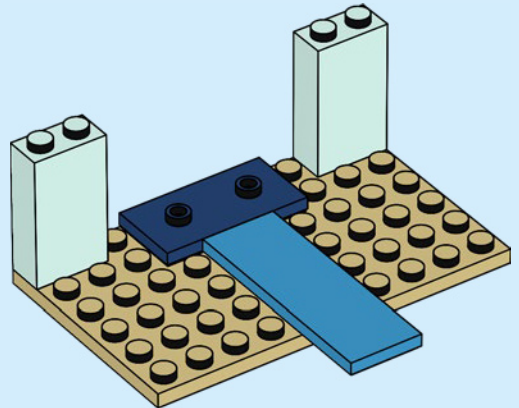

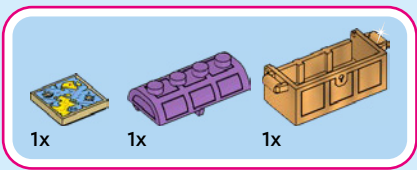

39

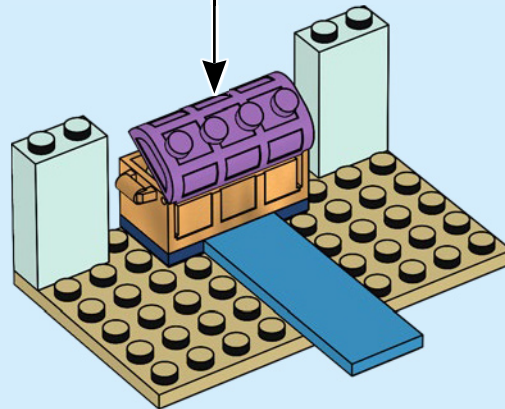
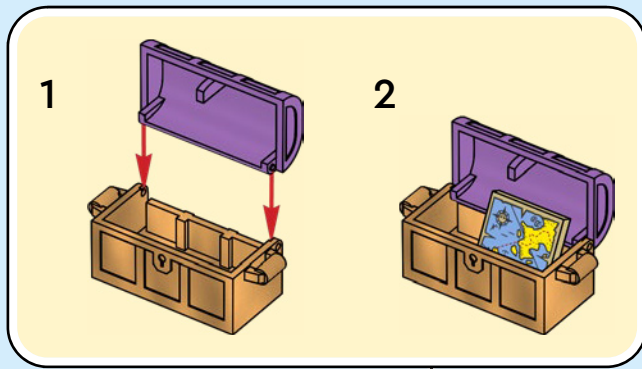

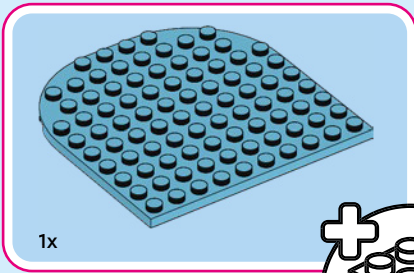

40

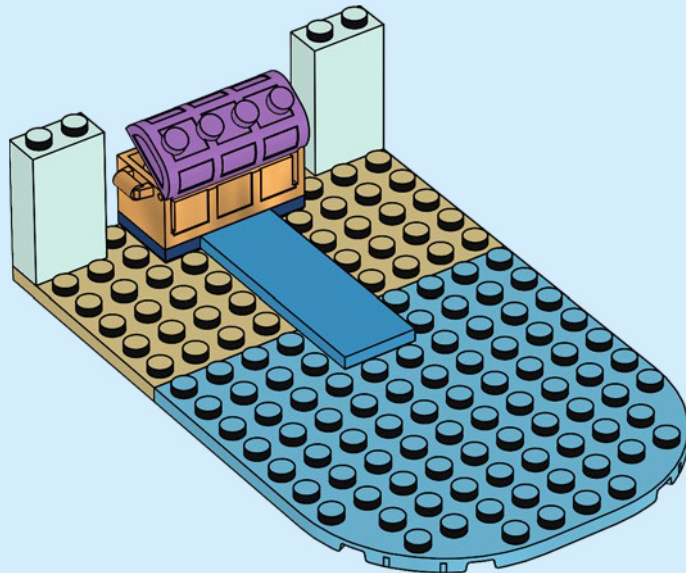
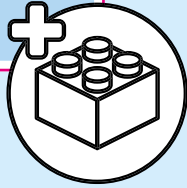



1x



2x



1x

41

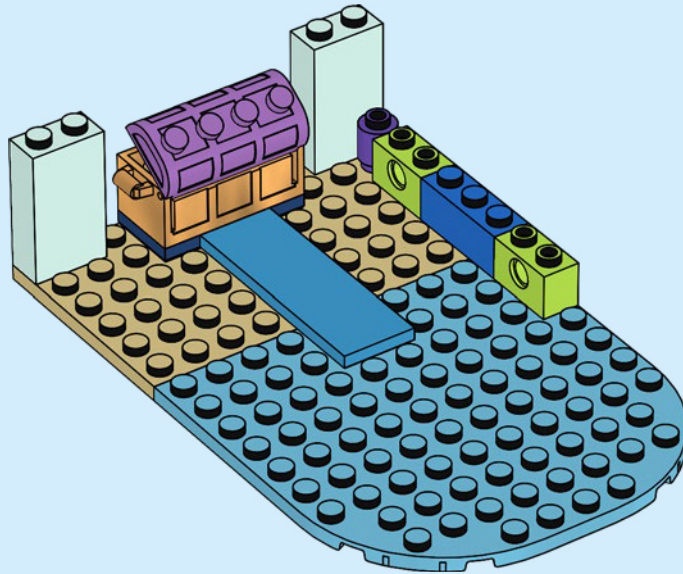

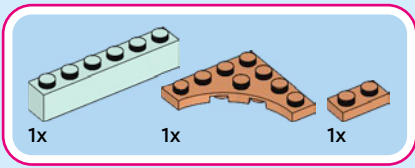

42

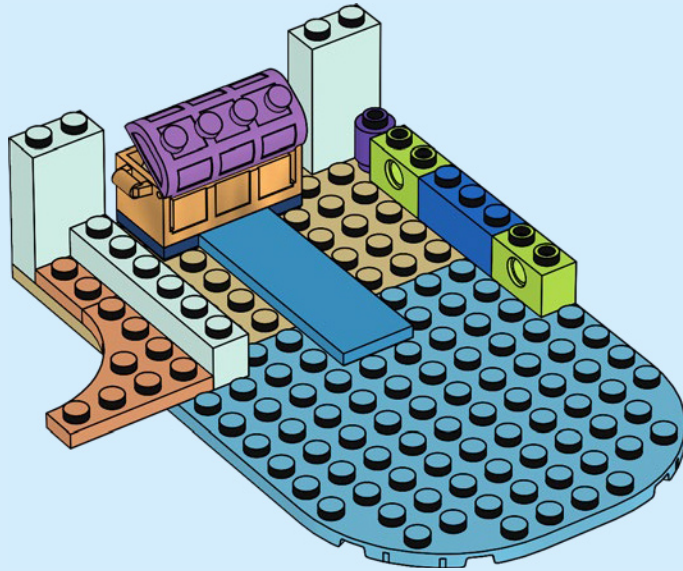

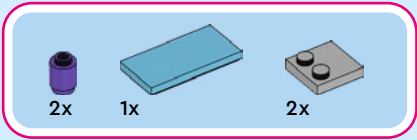

43

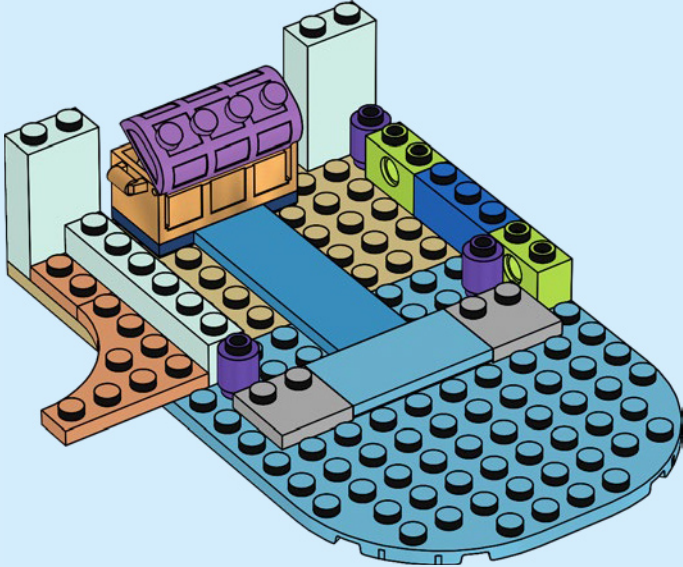

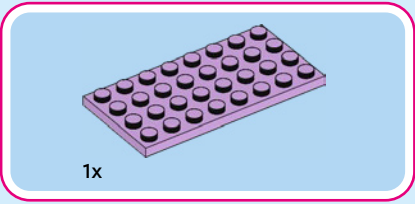

44

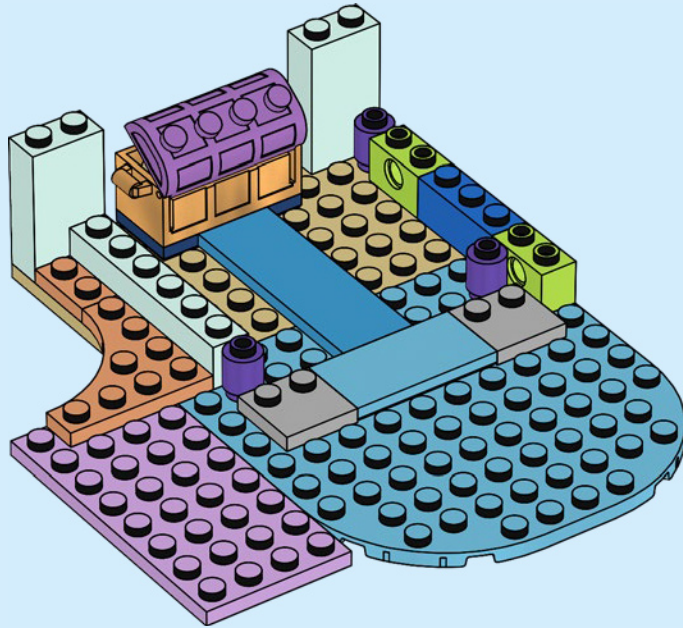

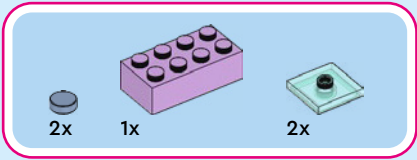

45

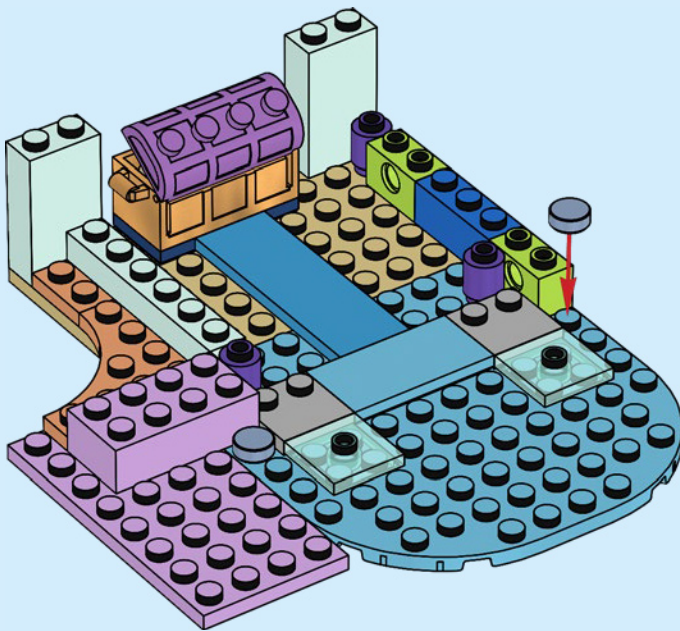



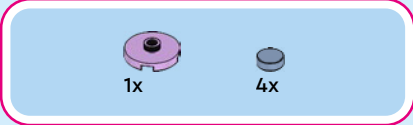

46

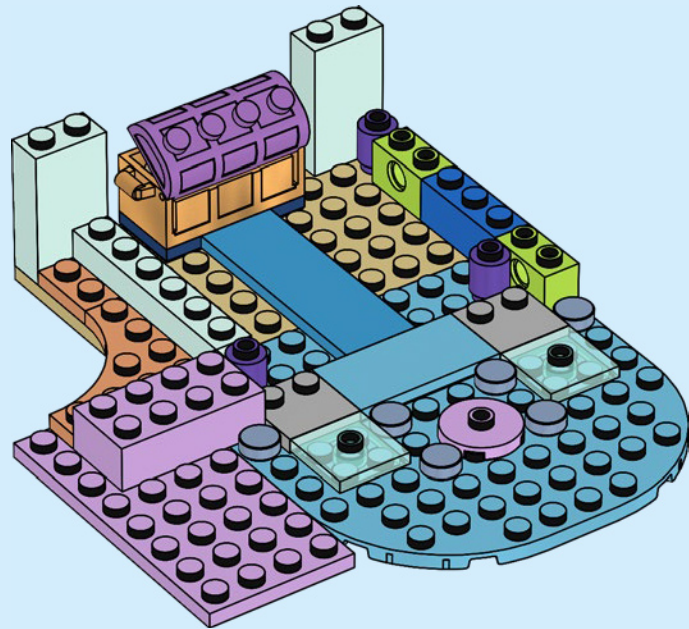

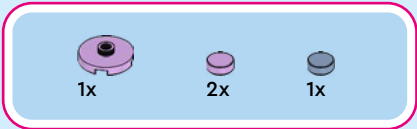

47

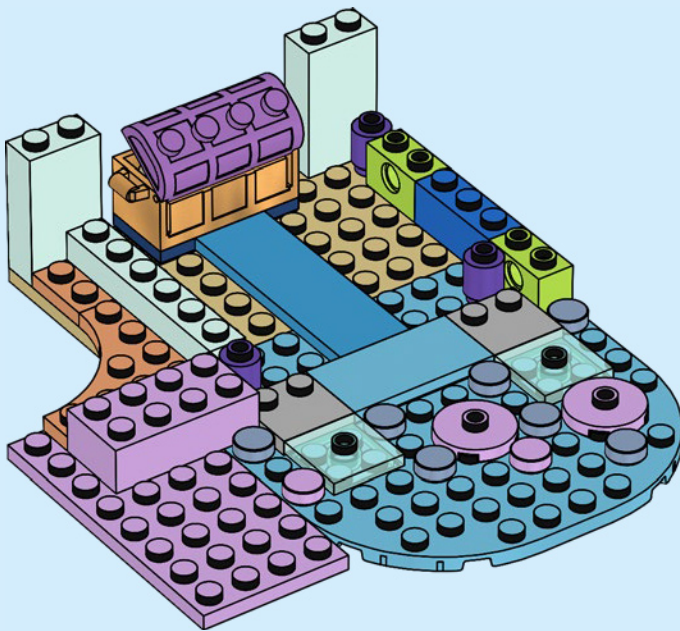



1x



1x

# 48

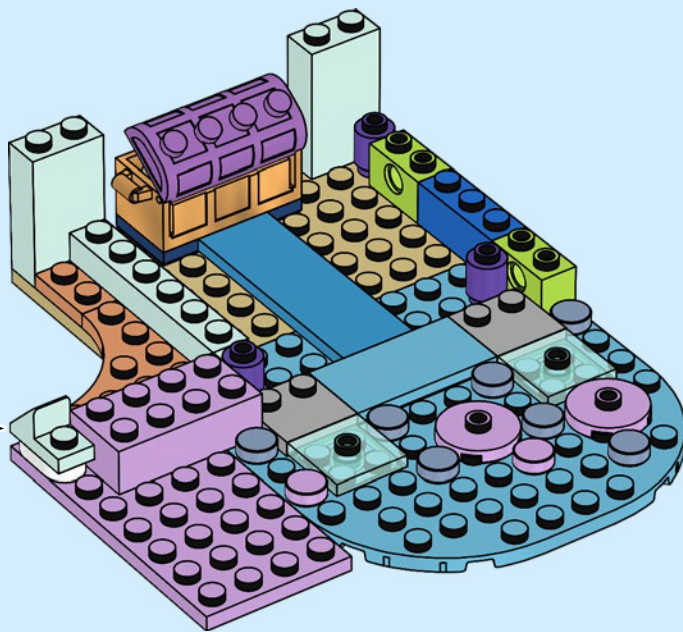
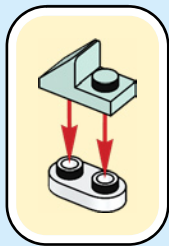



2x

# 49

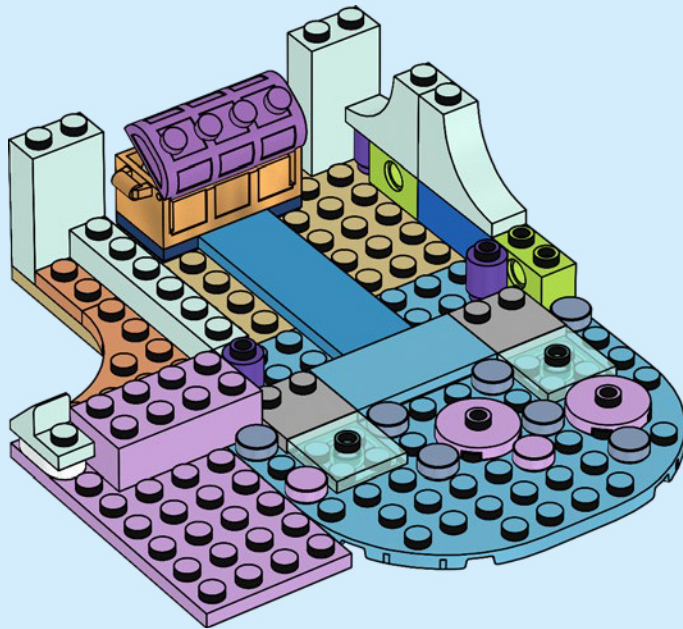



1x



1x

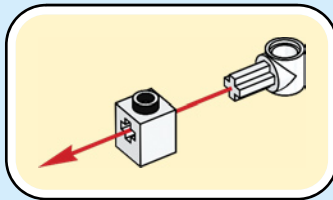

50

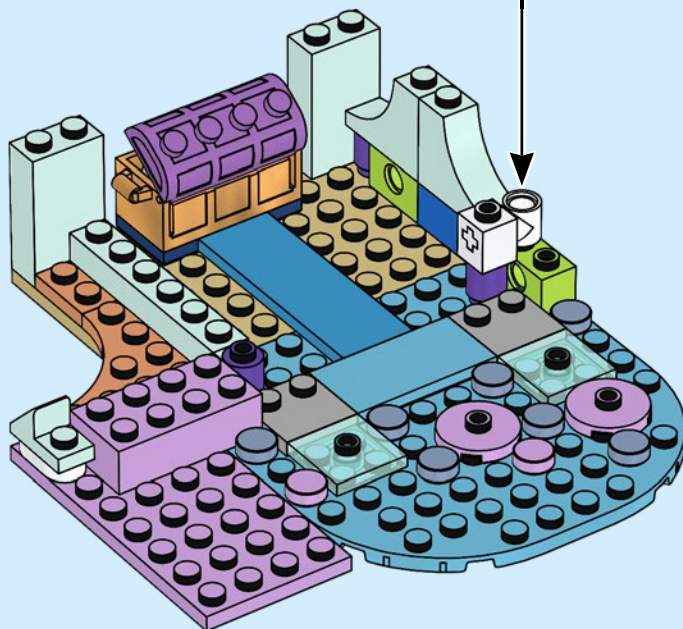

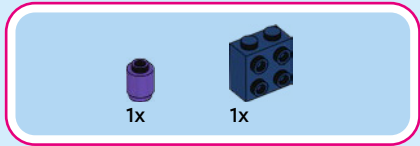

51

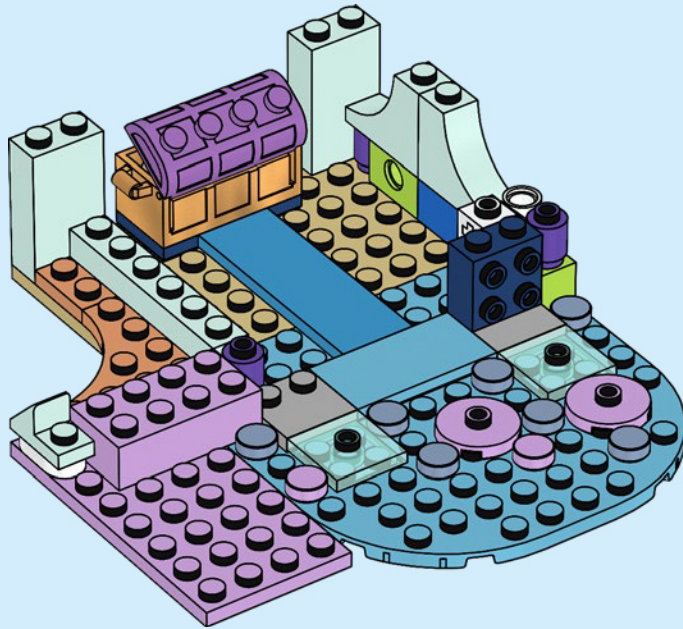



1x



1x

# 52

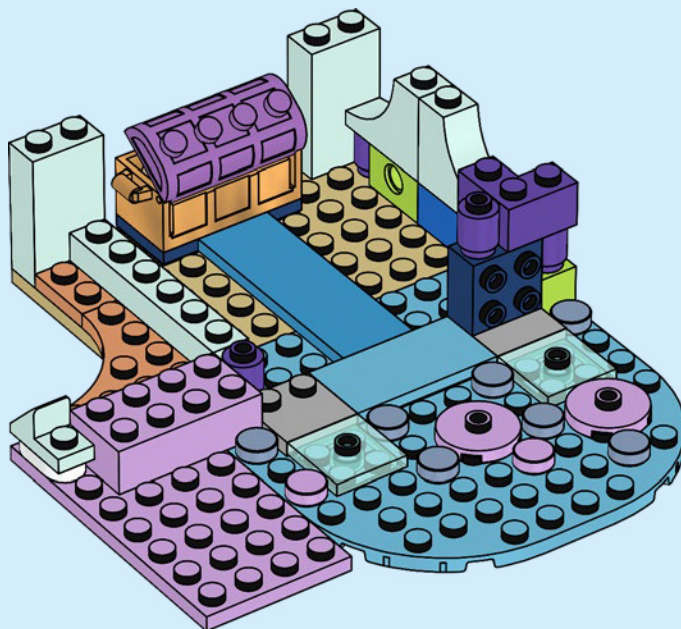

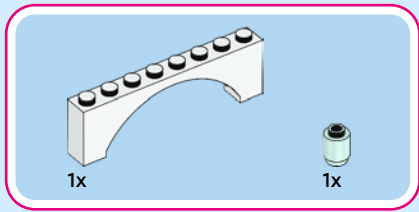

53

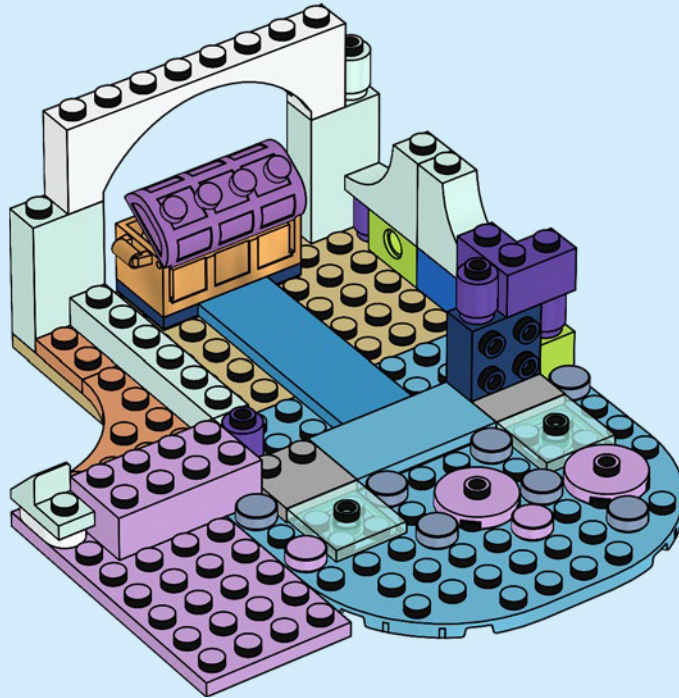



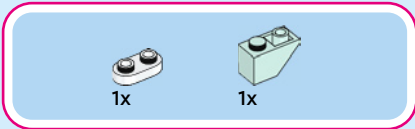

54

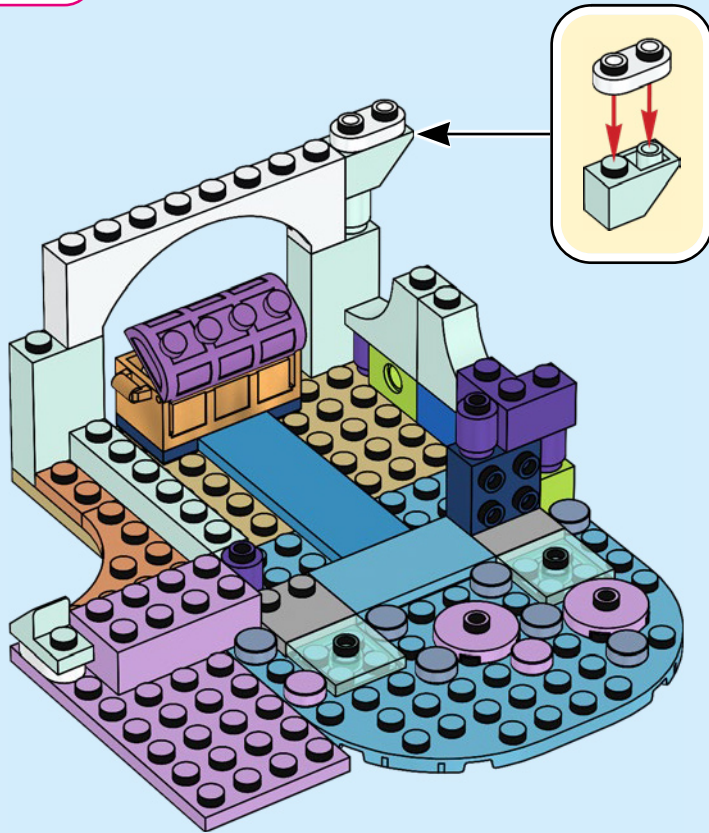

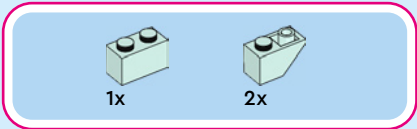

55

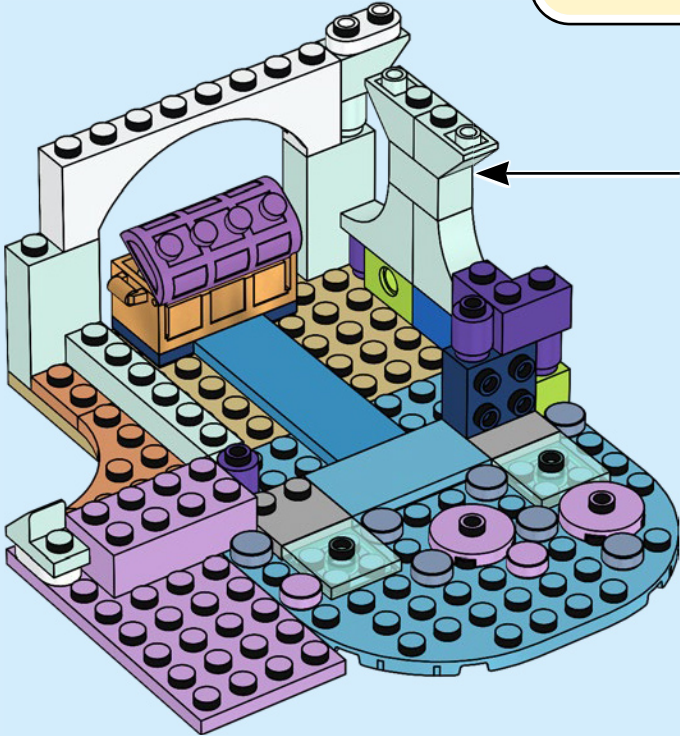
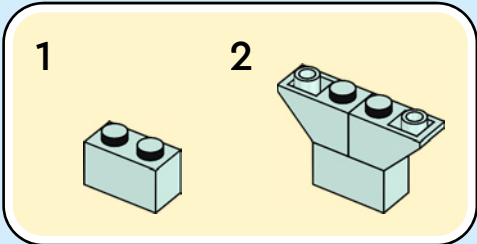

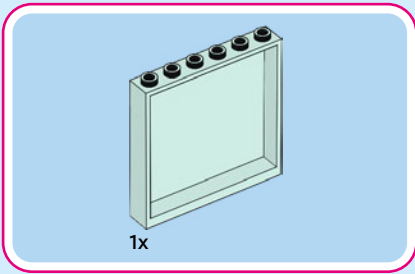

56

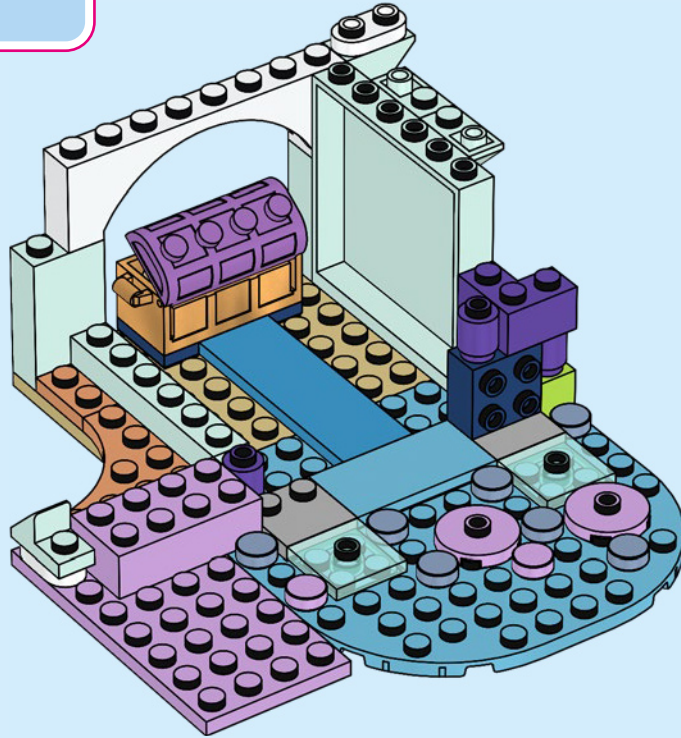

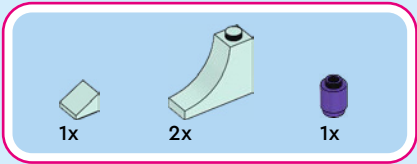

57

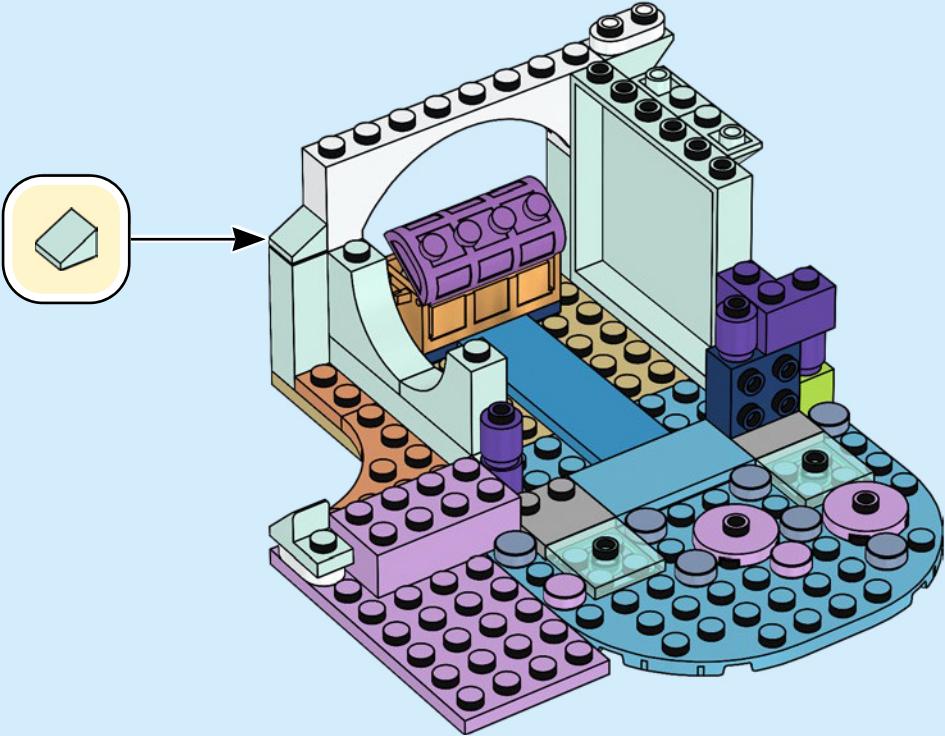

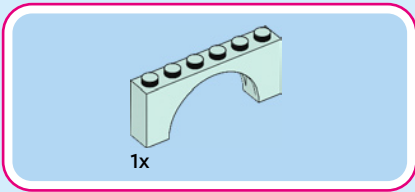

58

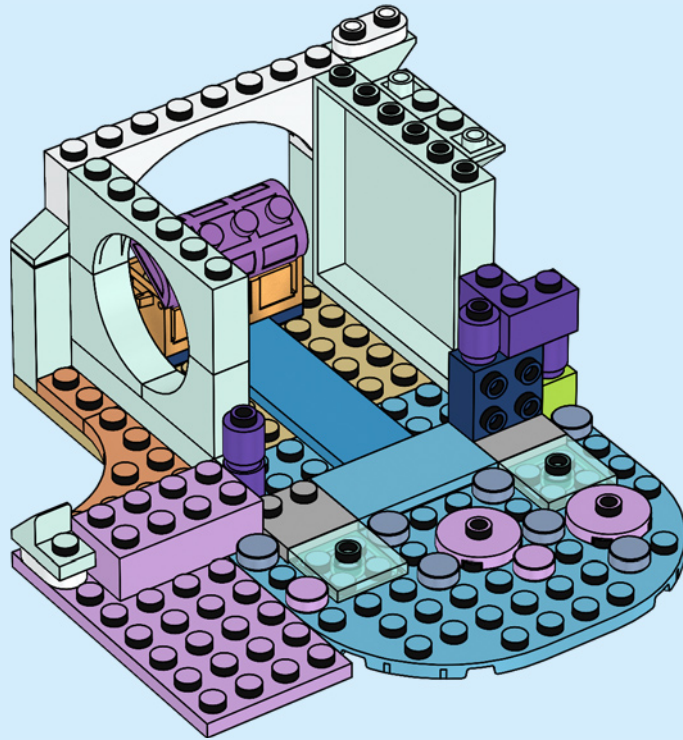

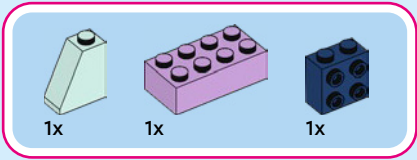

59

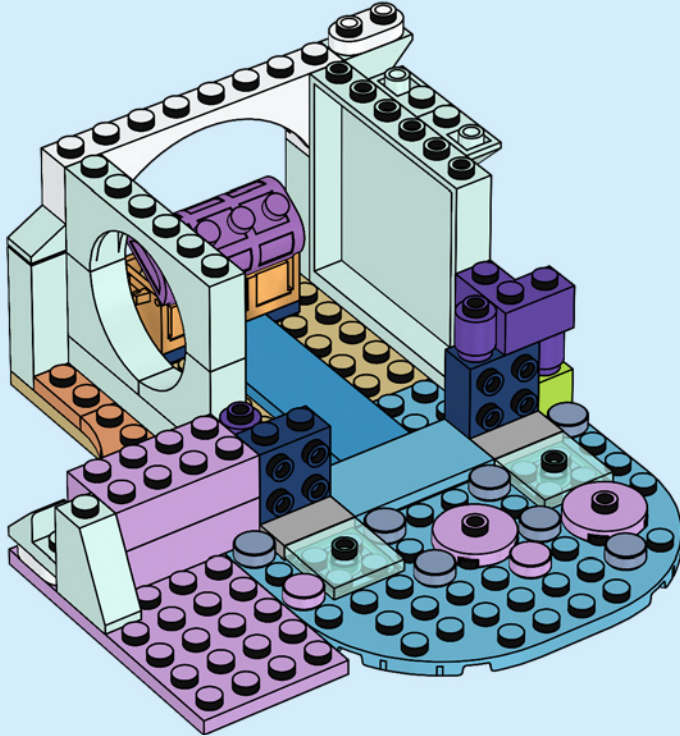



1x



1x

60

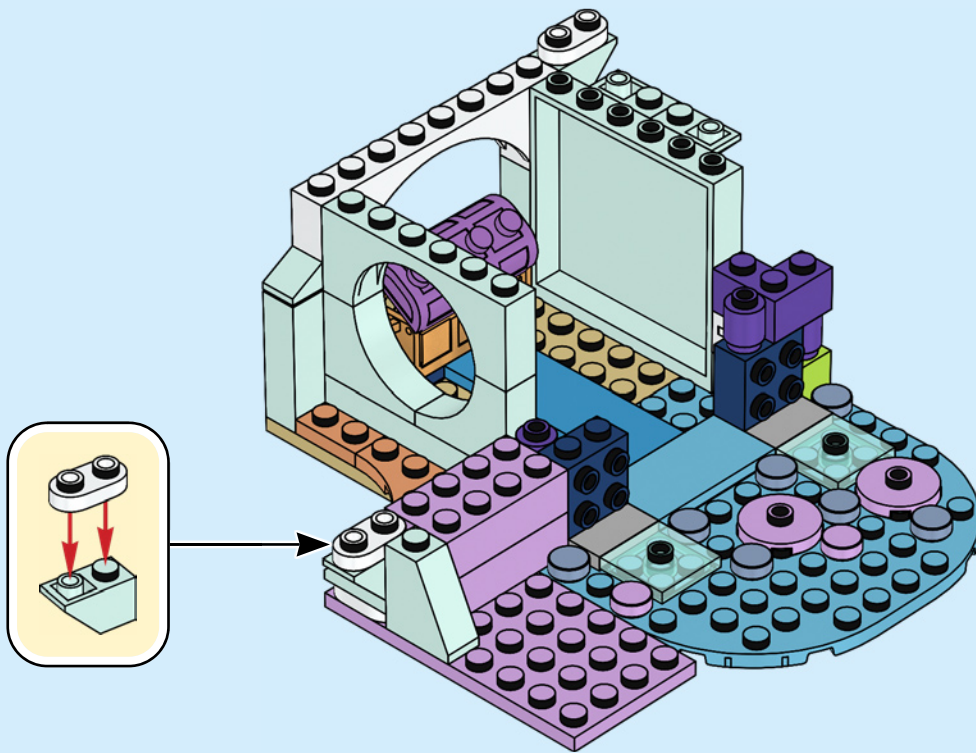

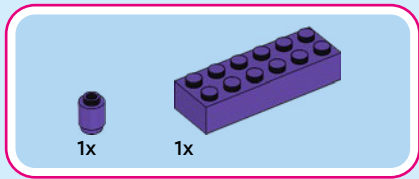

61

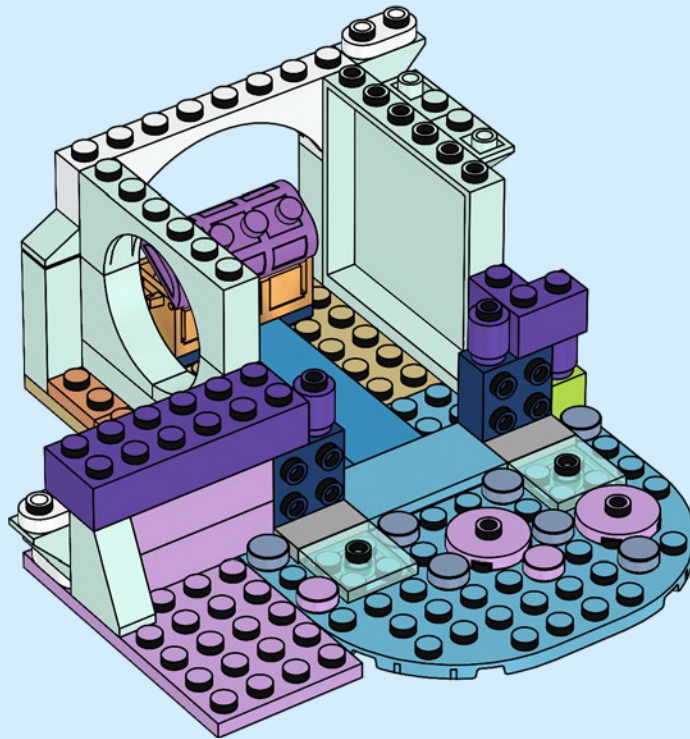



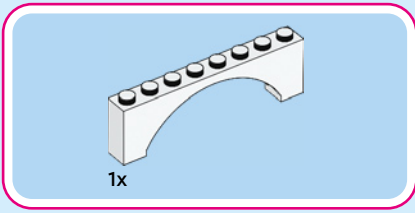

62

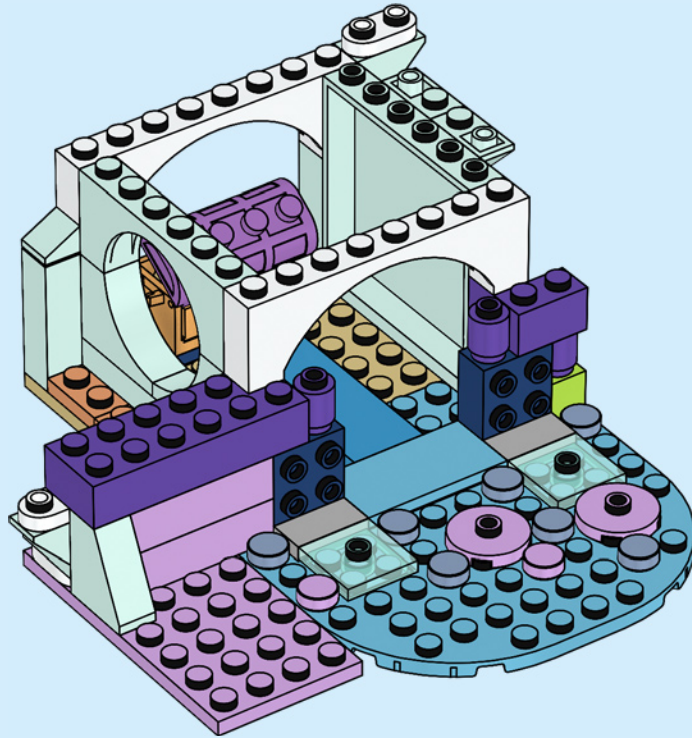

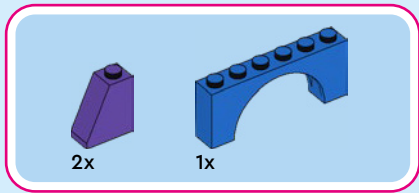

63

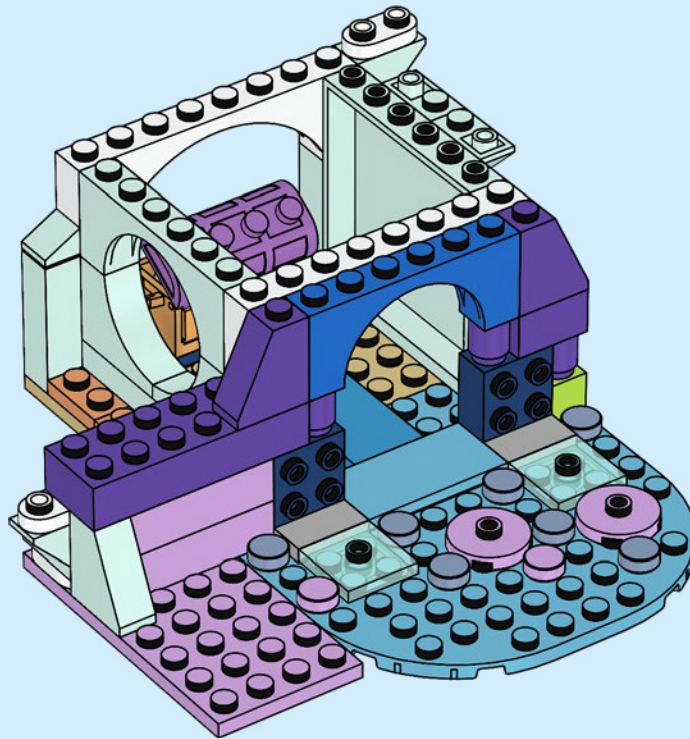

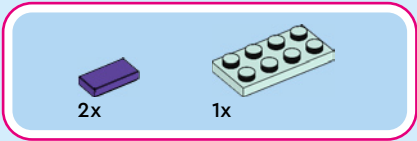

64

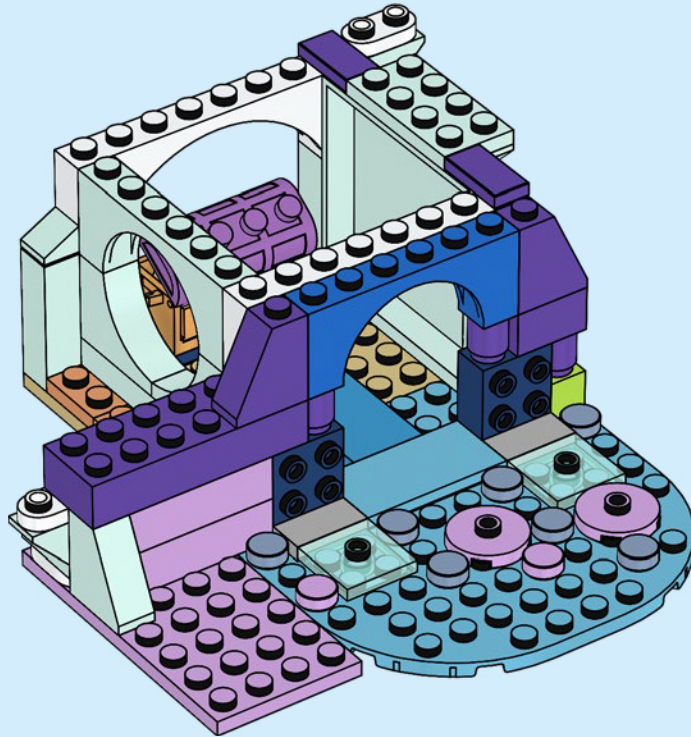

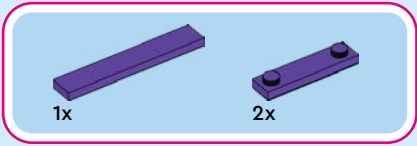

65

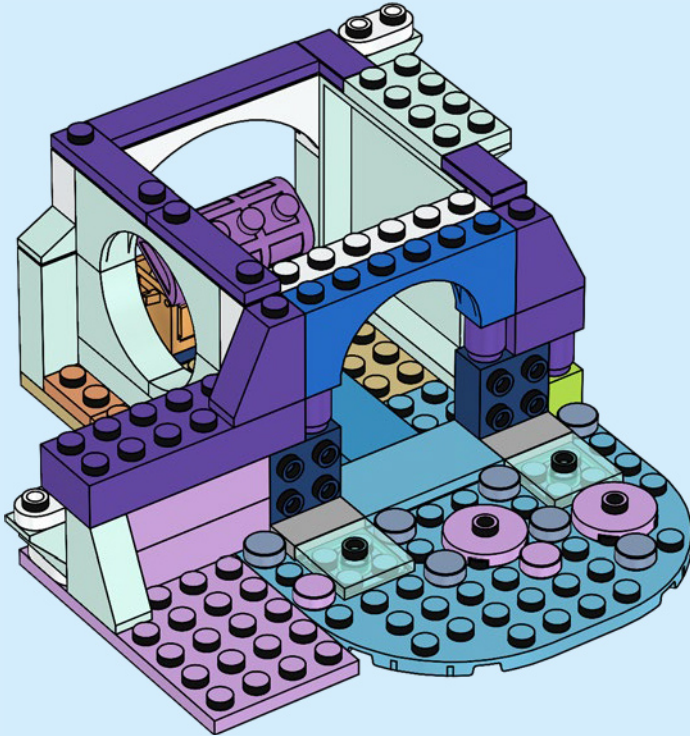



2x



2x

66

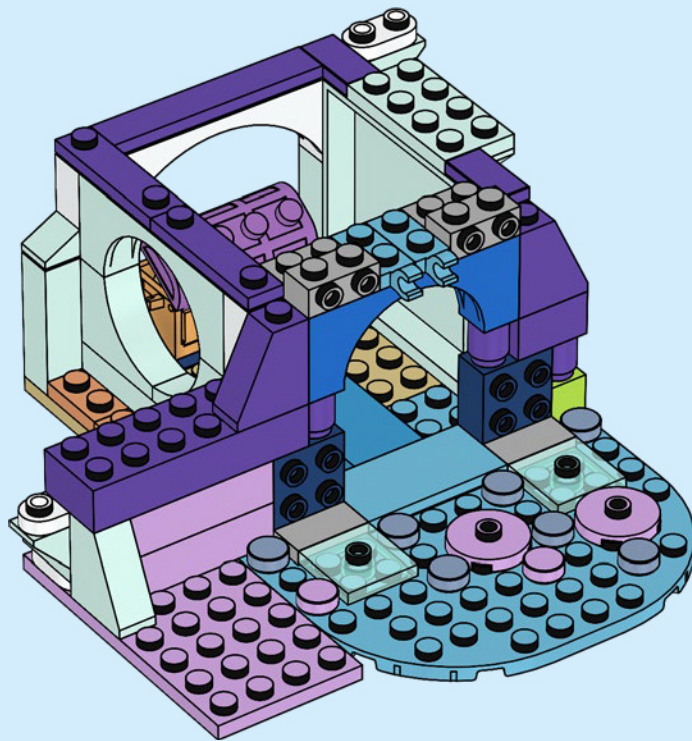

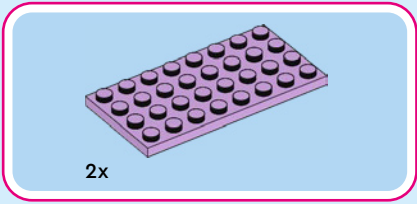

67

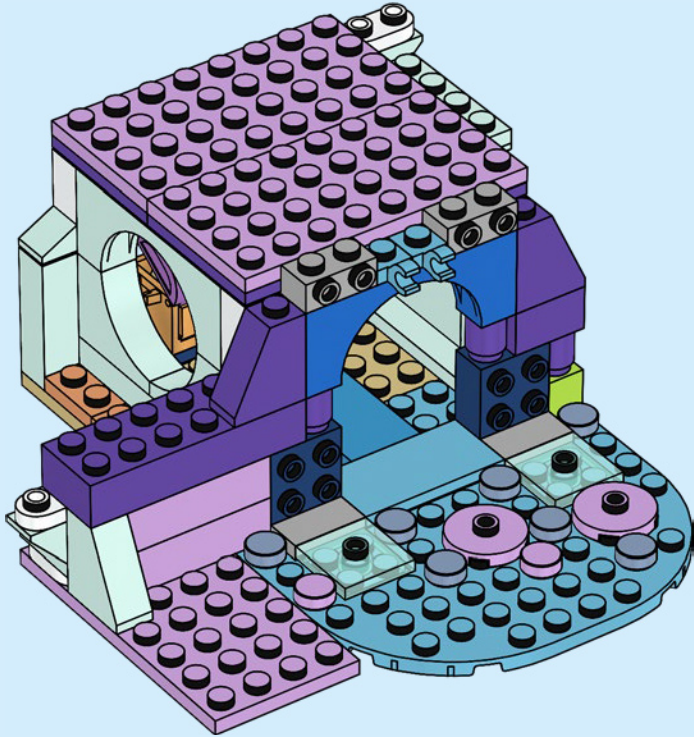

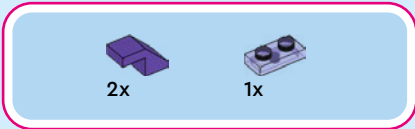

68

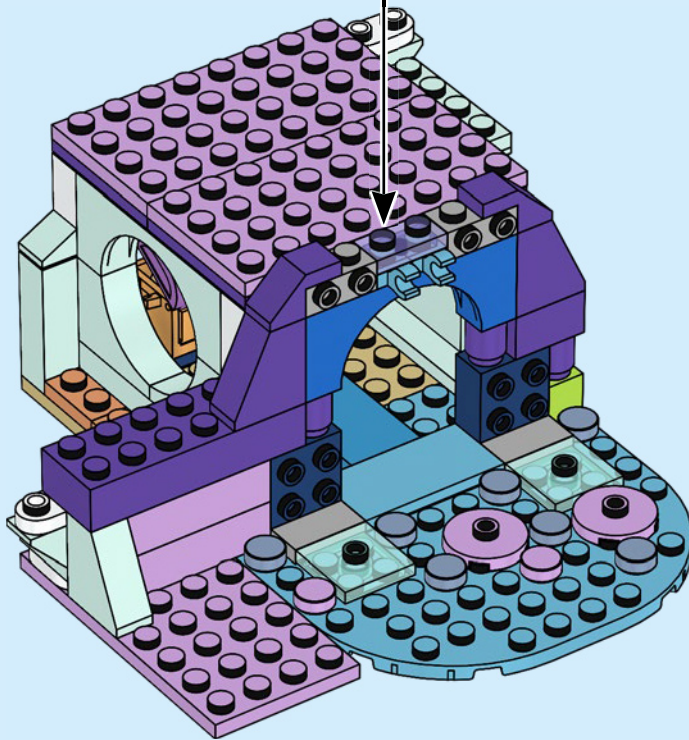

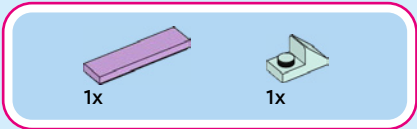

69

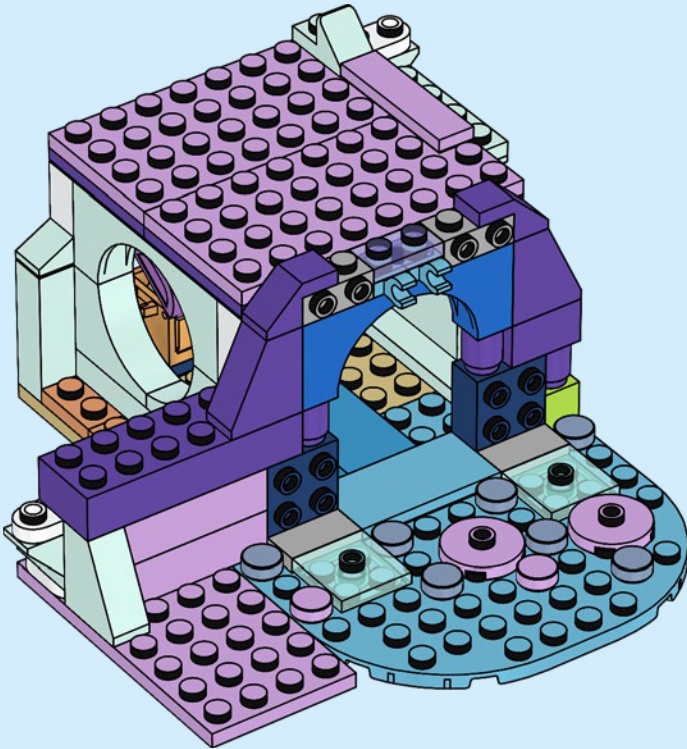



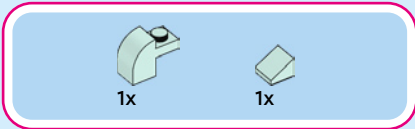

70

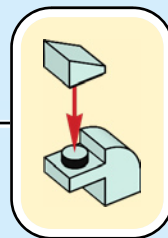
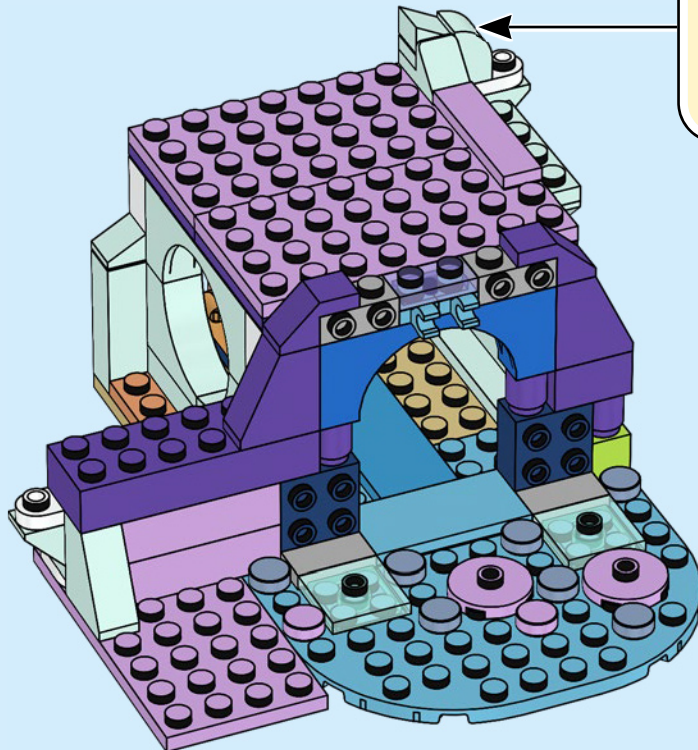



3x

71

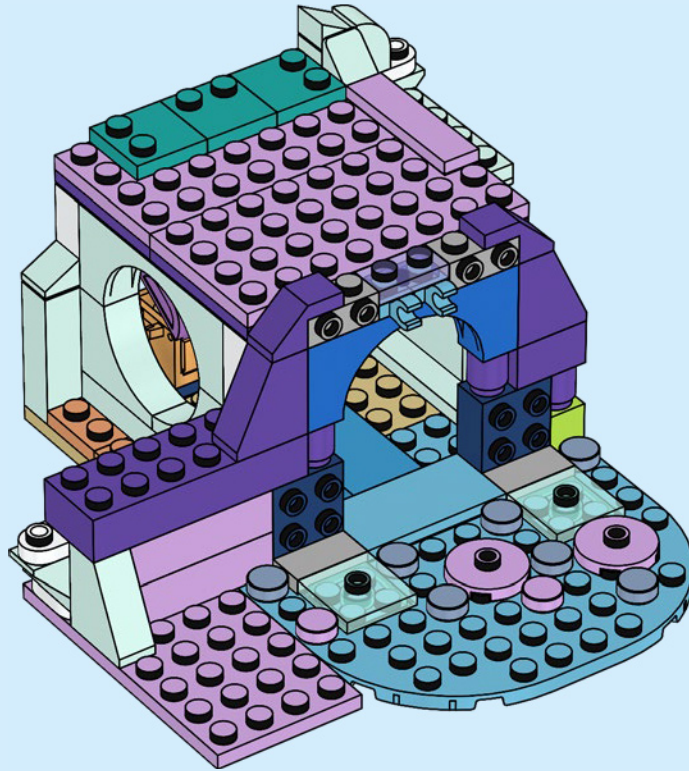



1x



1x

72

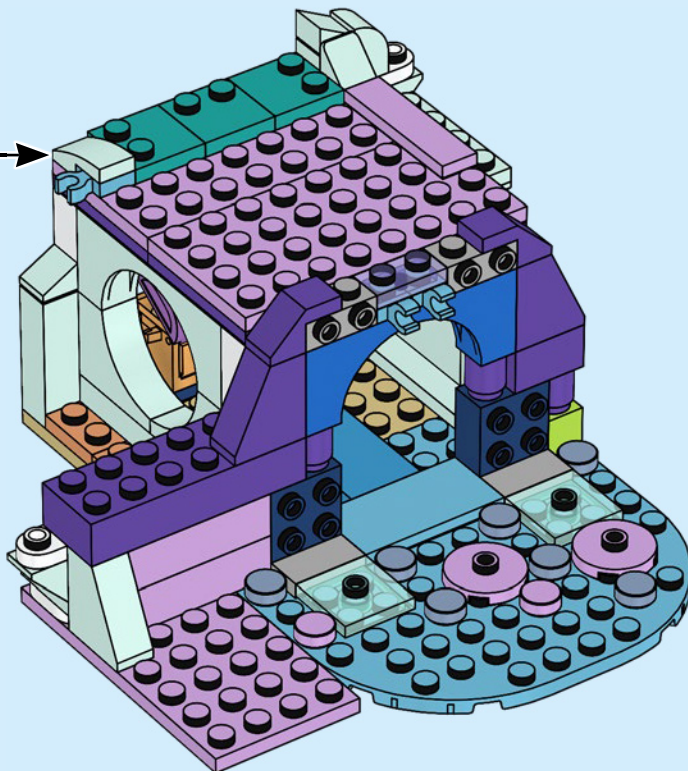
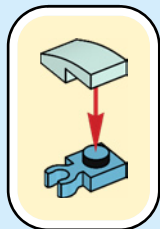



1x



2x

73

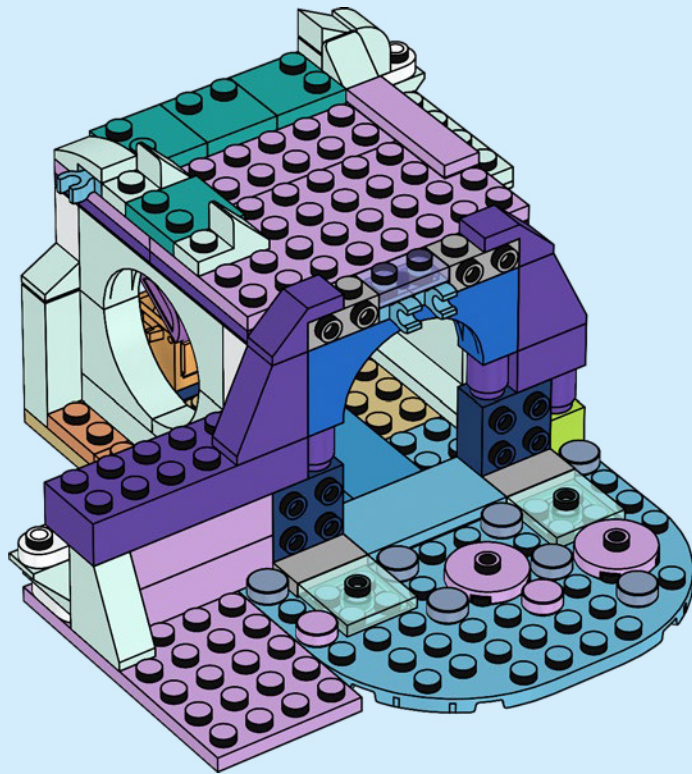

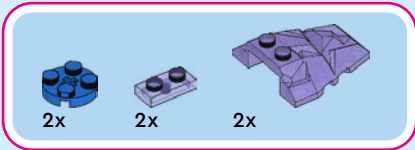

74

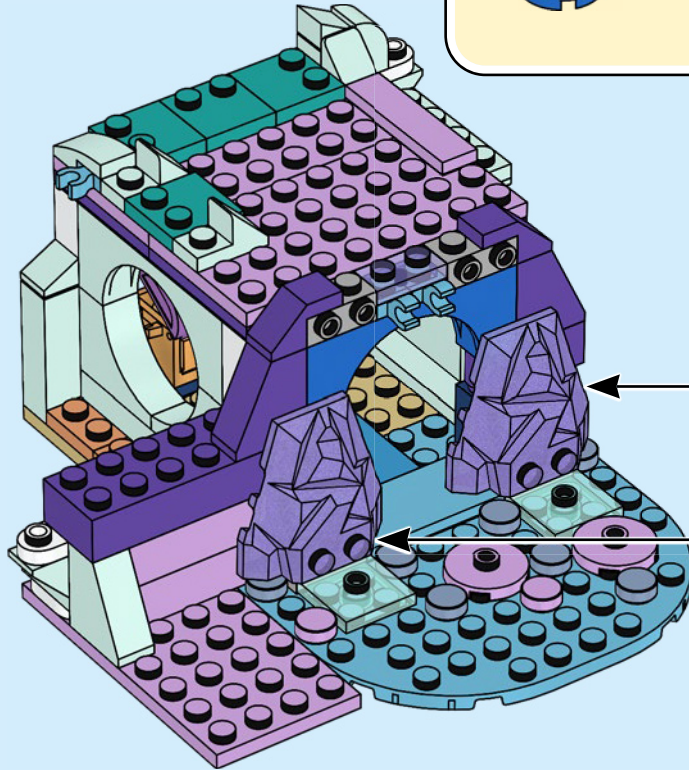
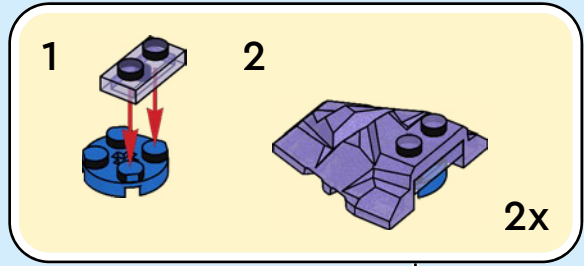



2x



2x

75

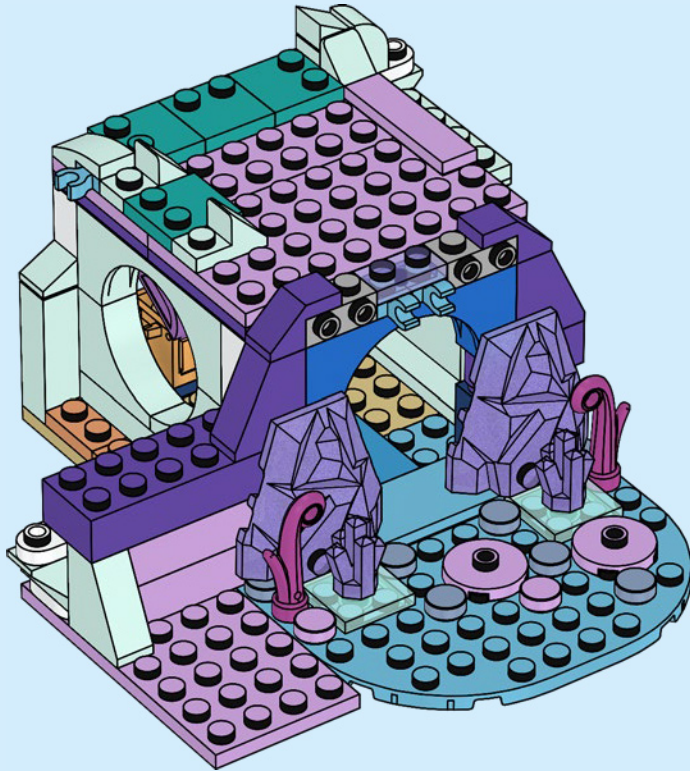

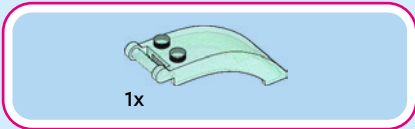

76

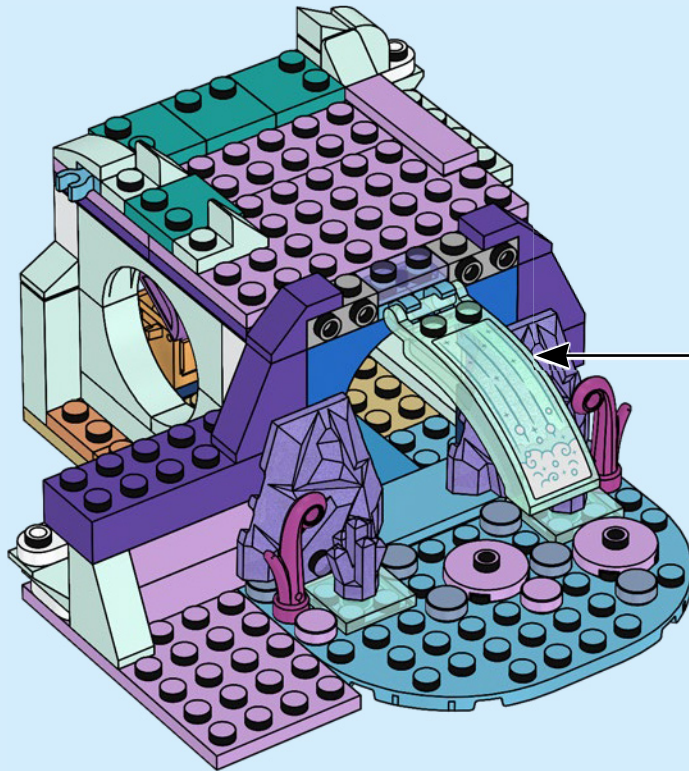
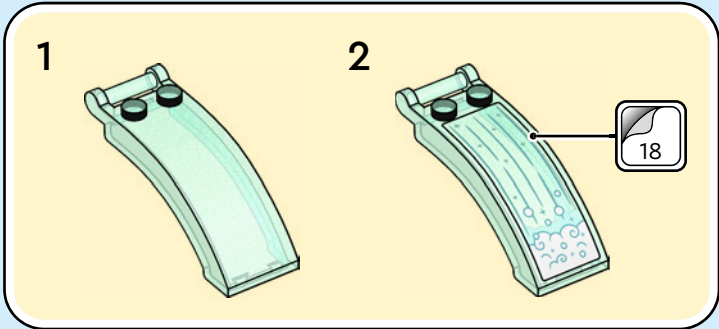

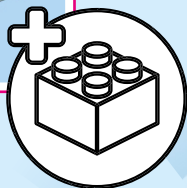
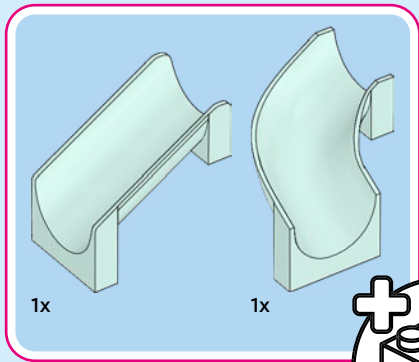

77

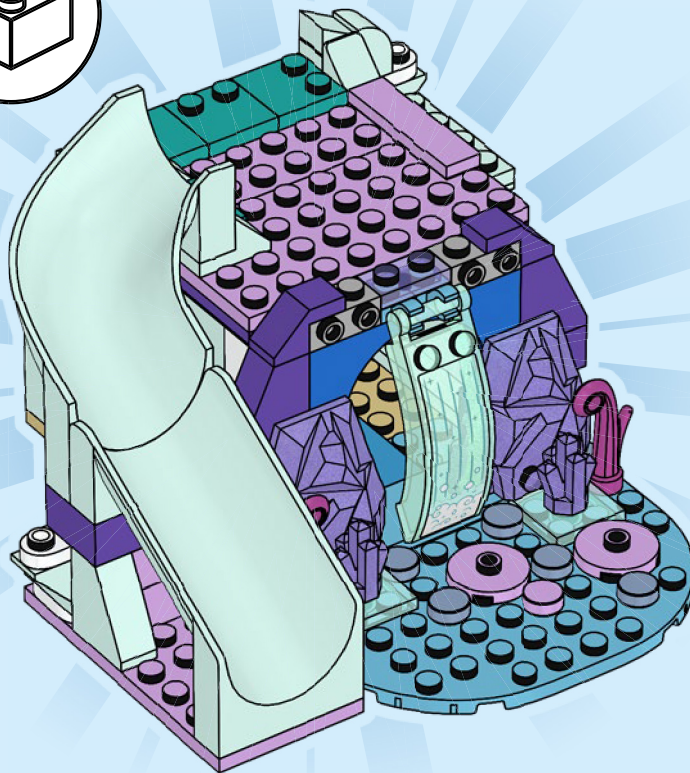



78

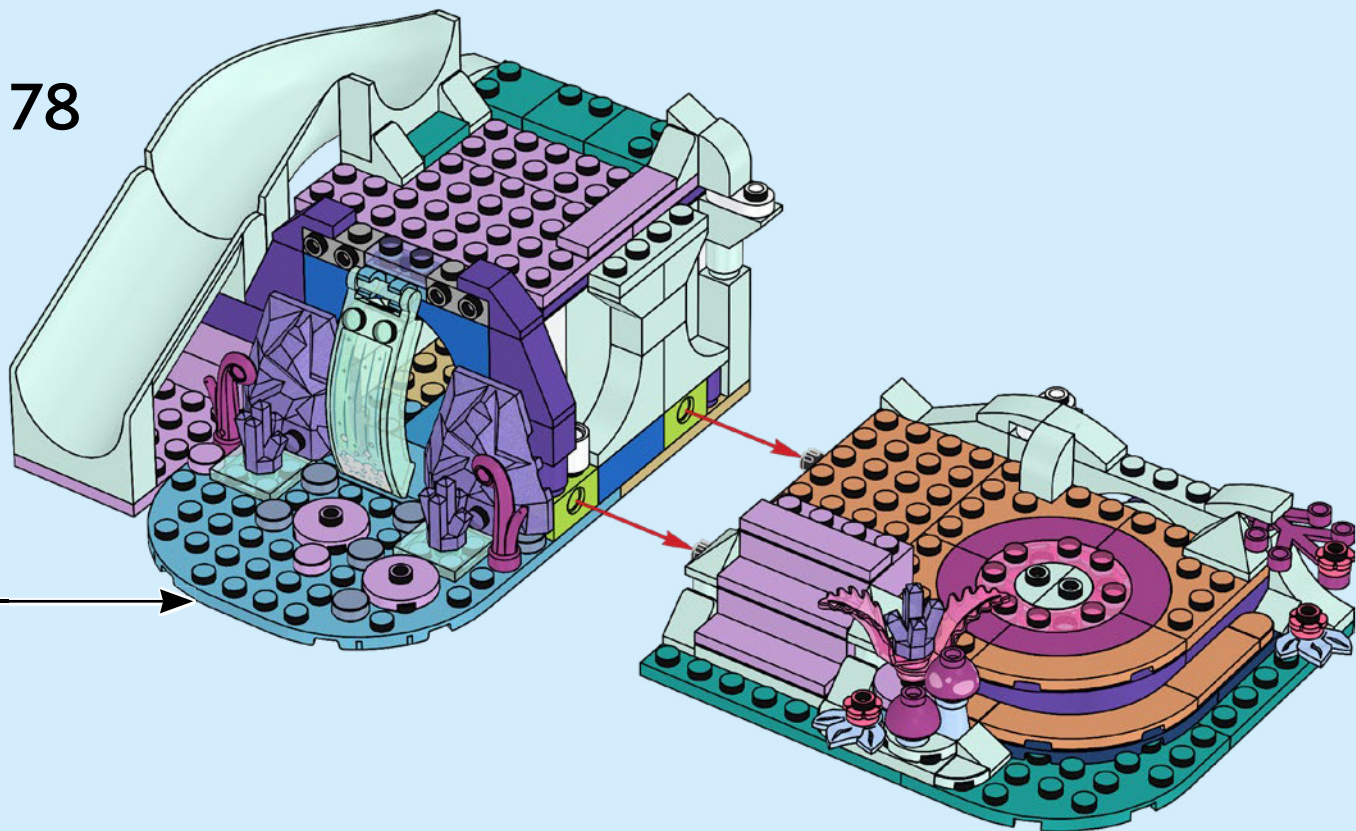



1x

79

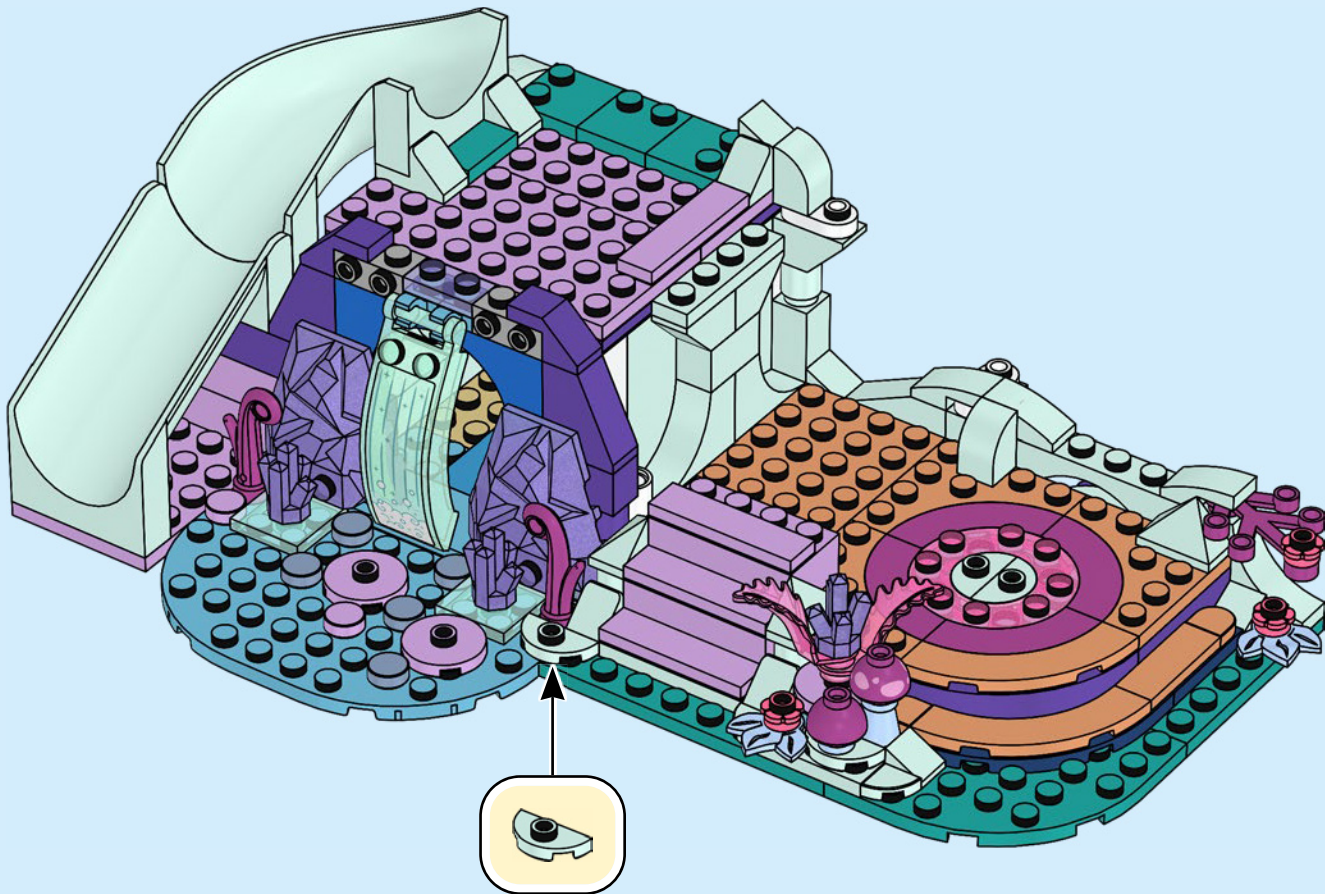



1x



1x

80

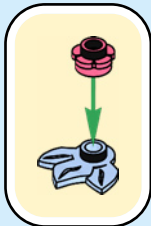
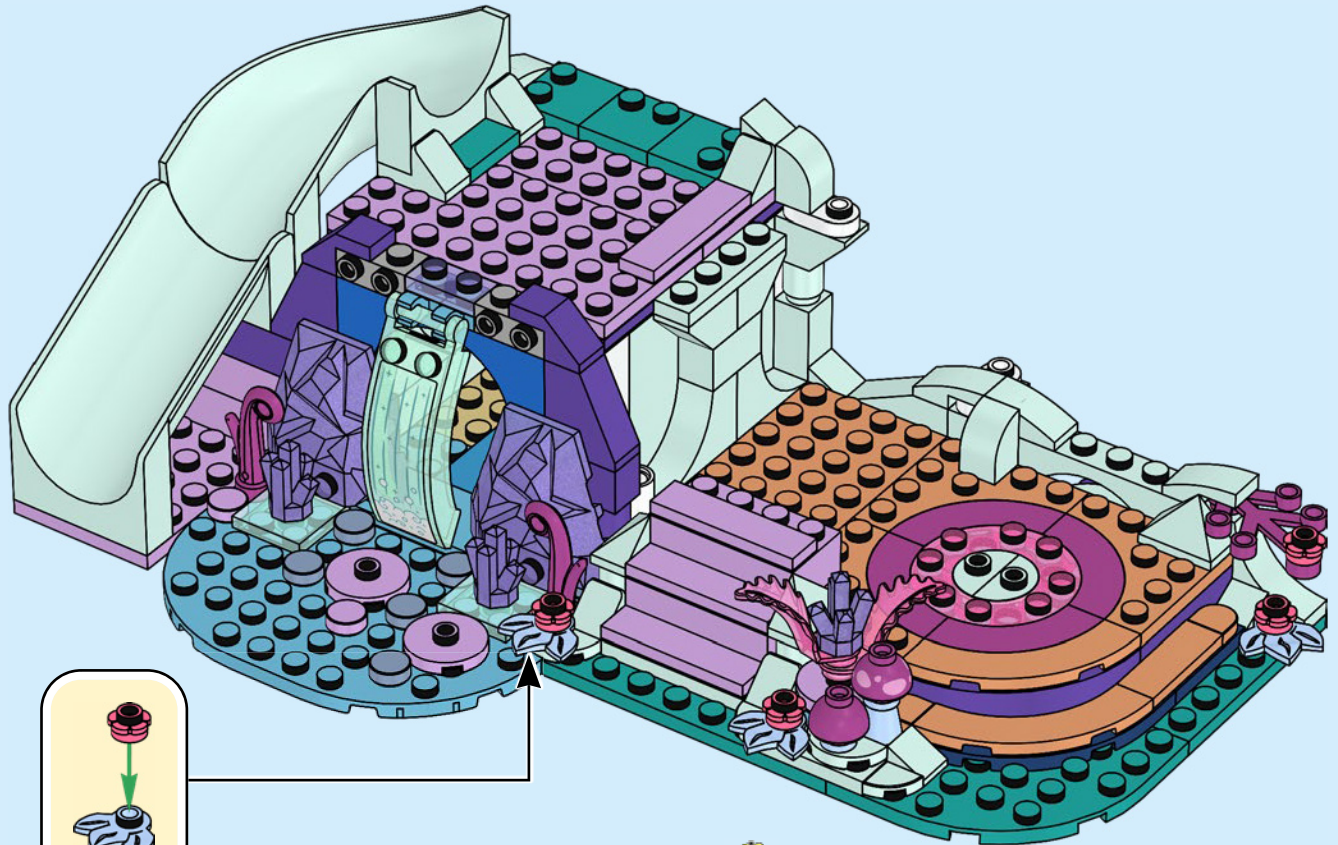

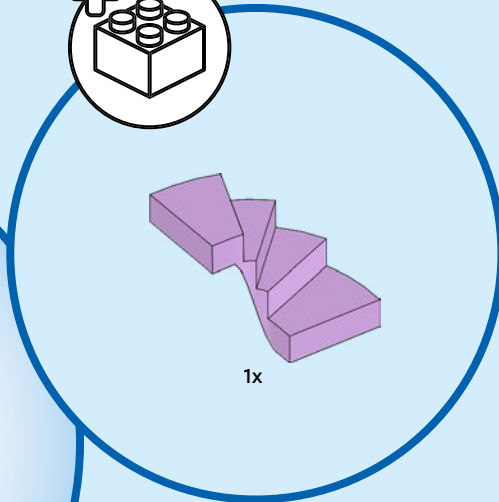
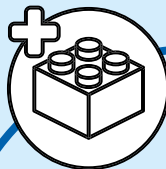

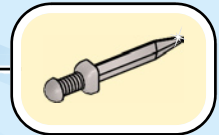
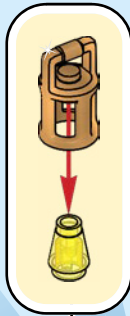
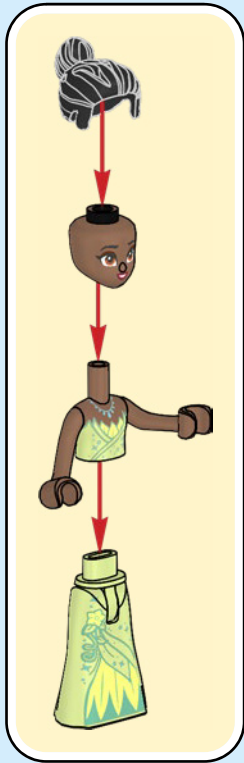

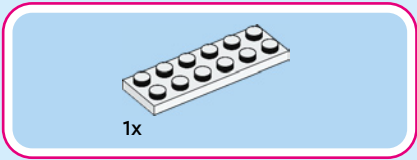
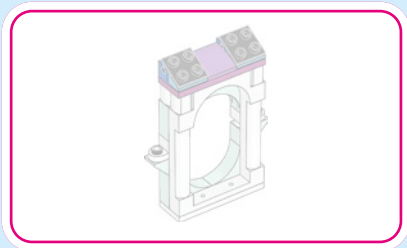

81

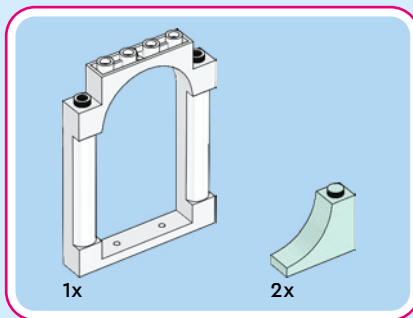
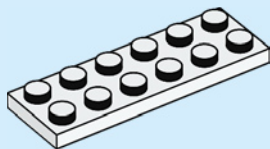

82

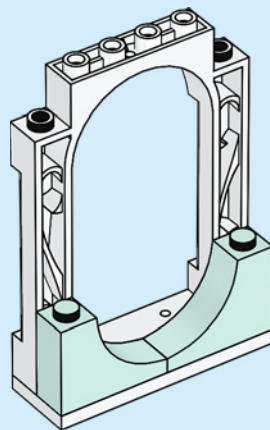



83

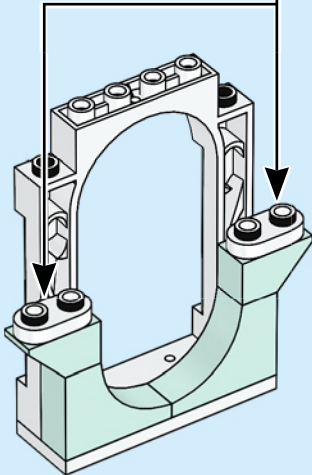
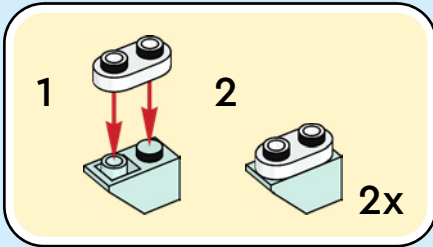

84

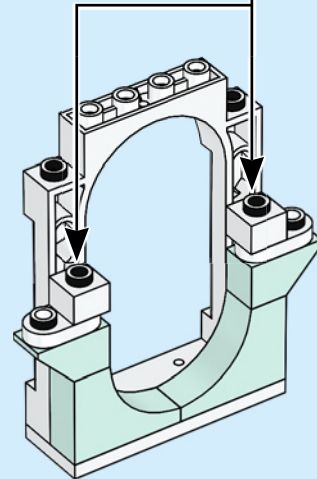
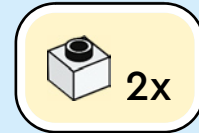

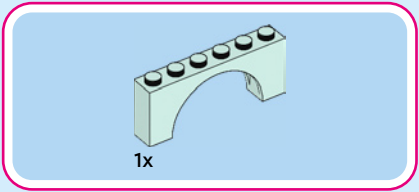

85

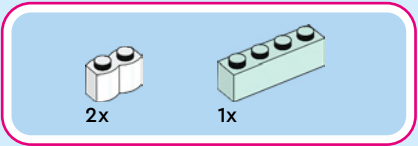
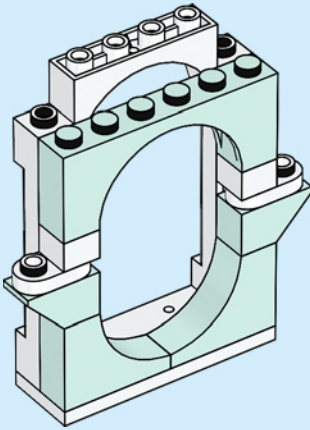

86

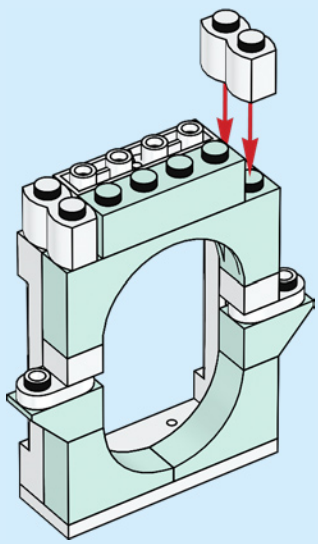



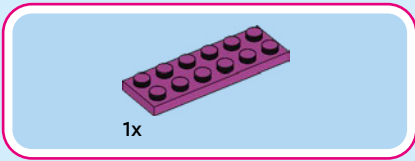

87

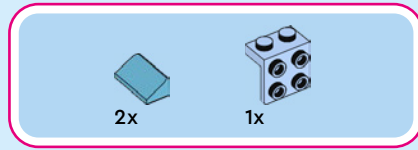
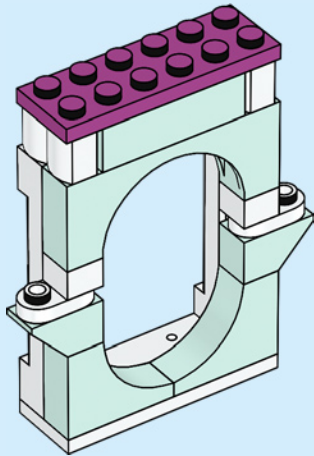

88

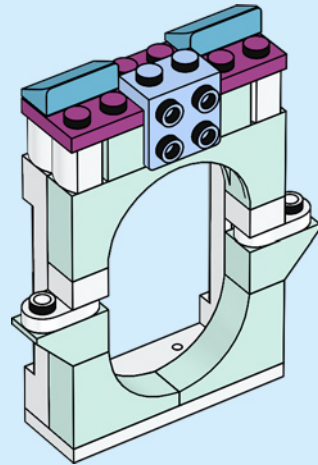



1x

89

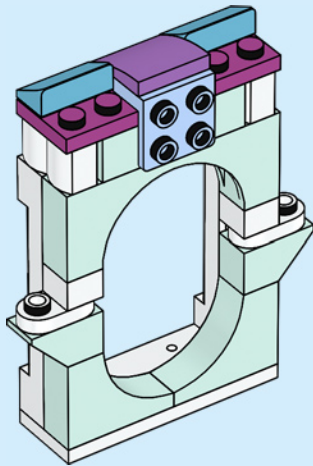

1x



1x

90

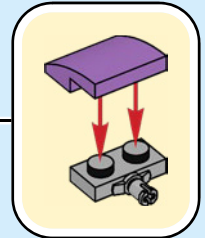
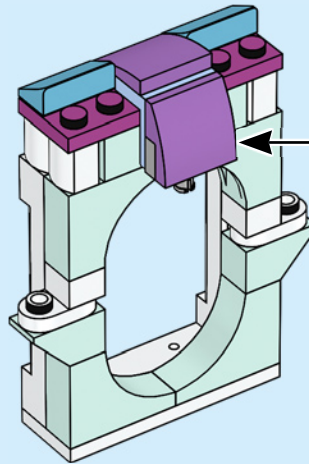



2x

91

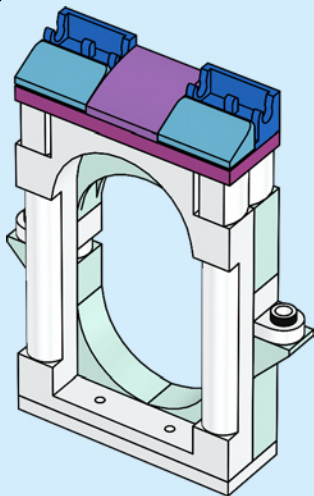

2x

92

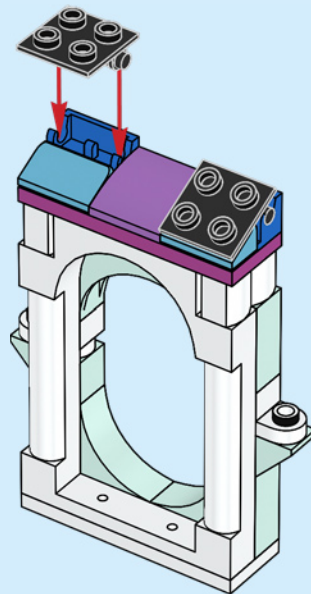

93

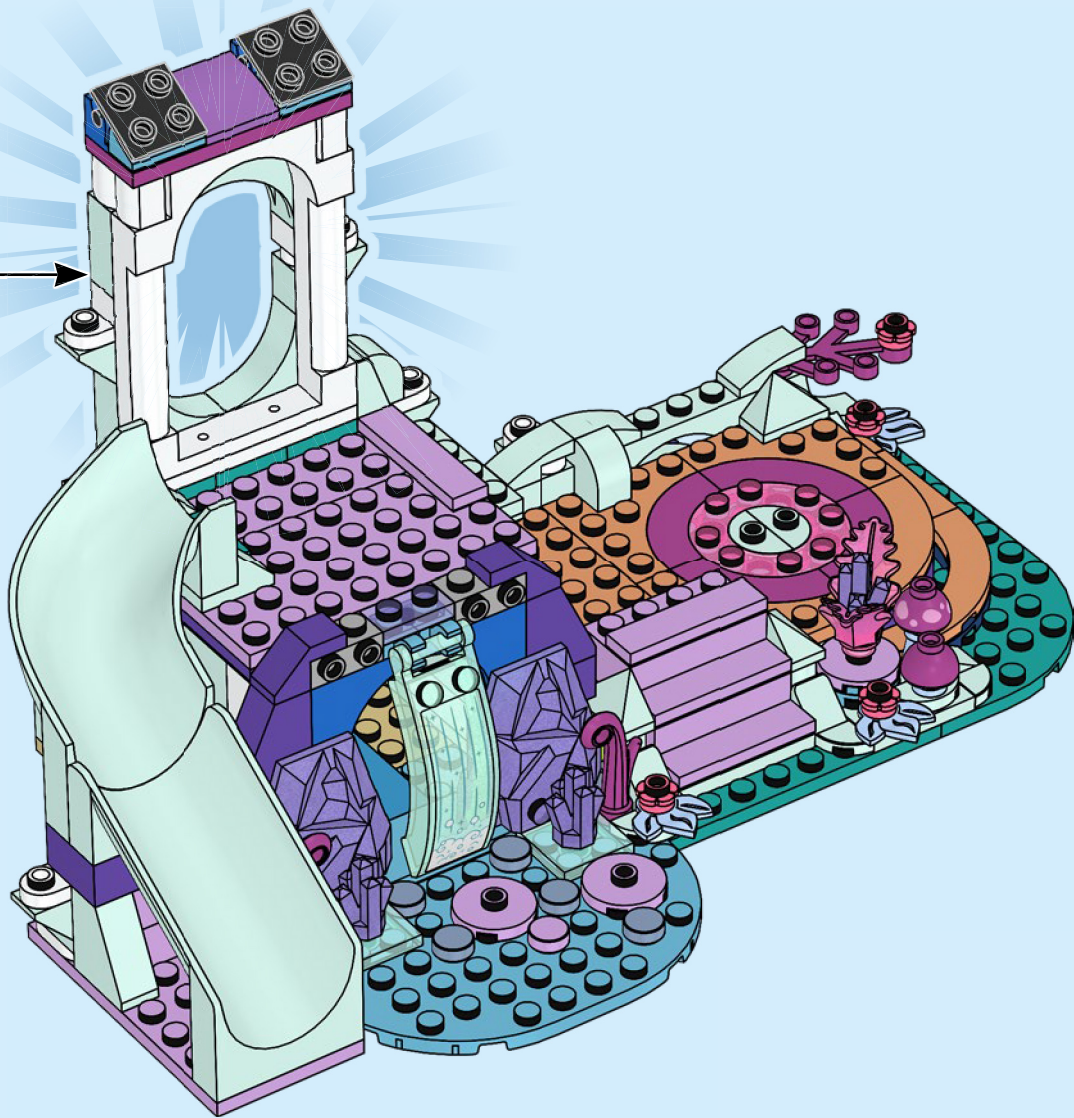

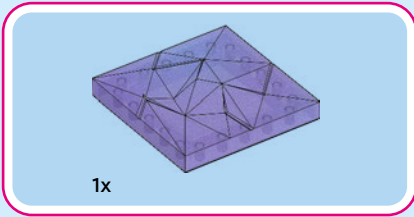

94

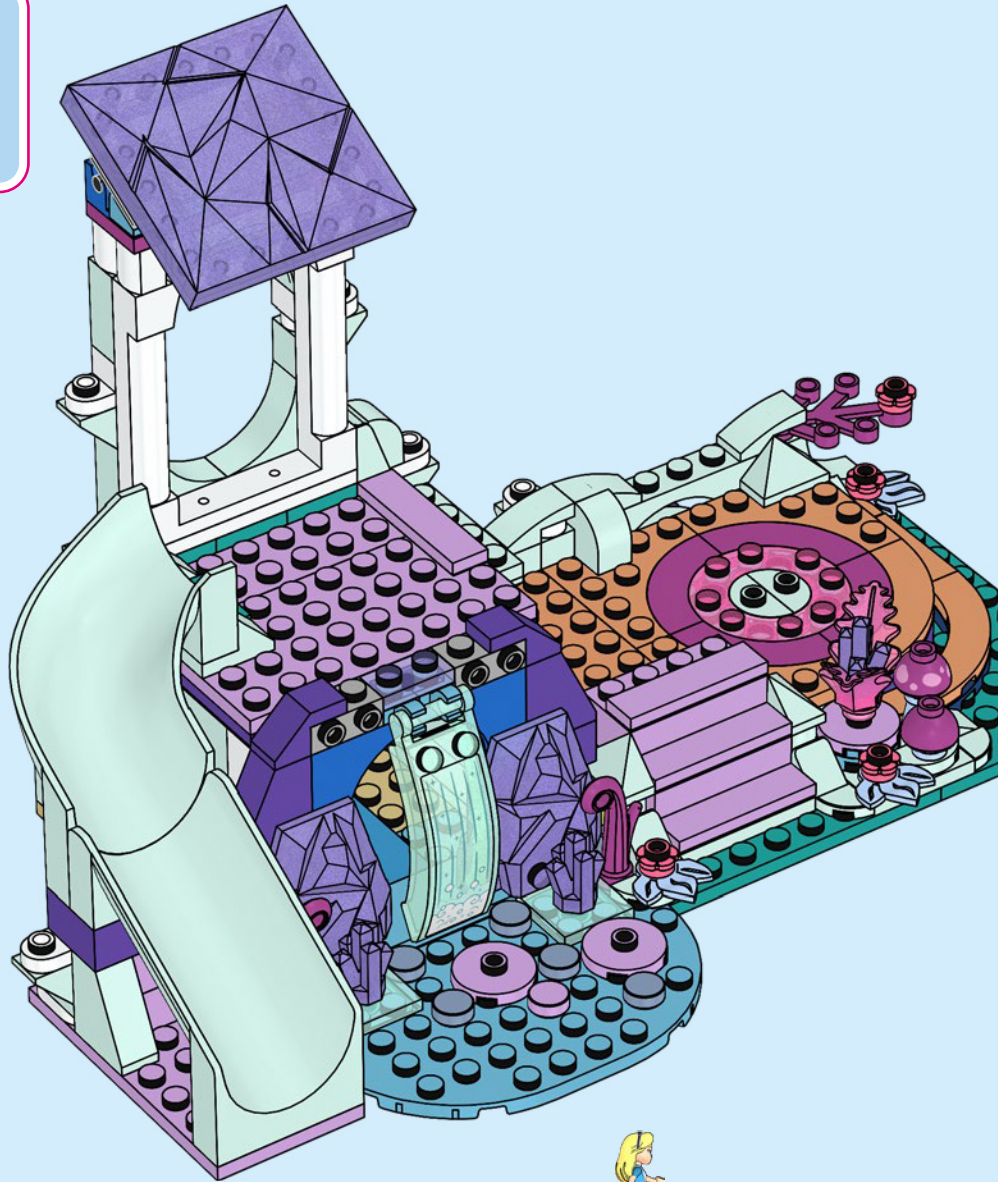

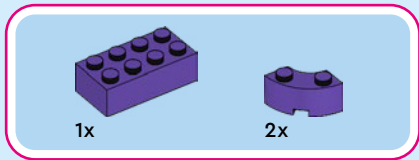

95

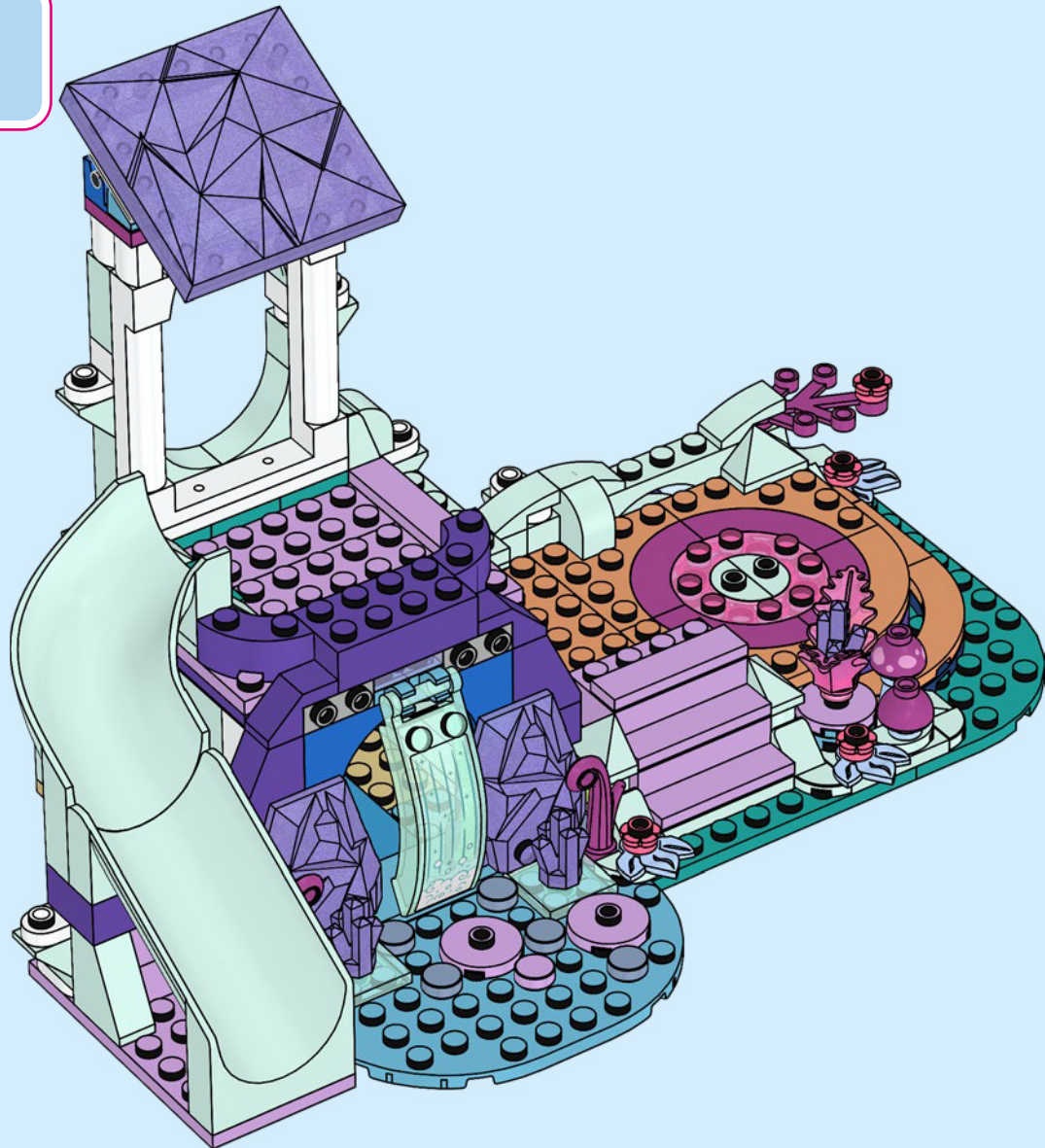

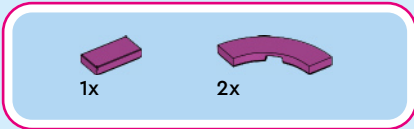

96

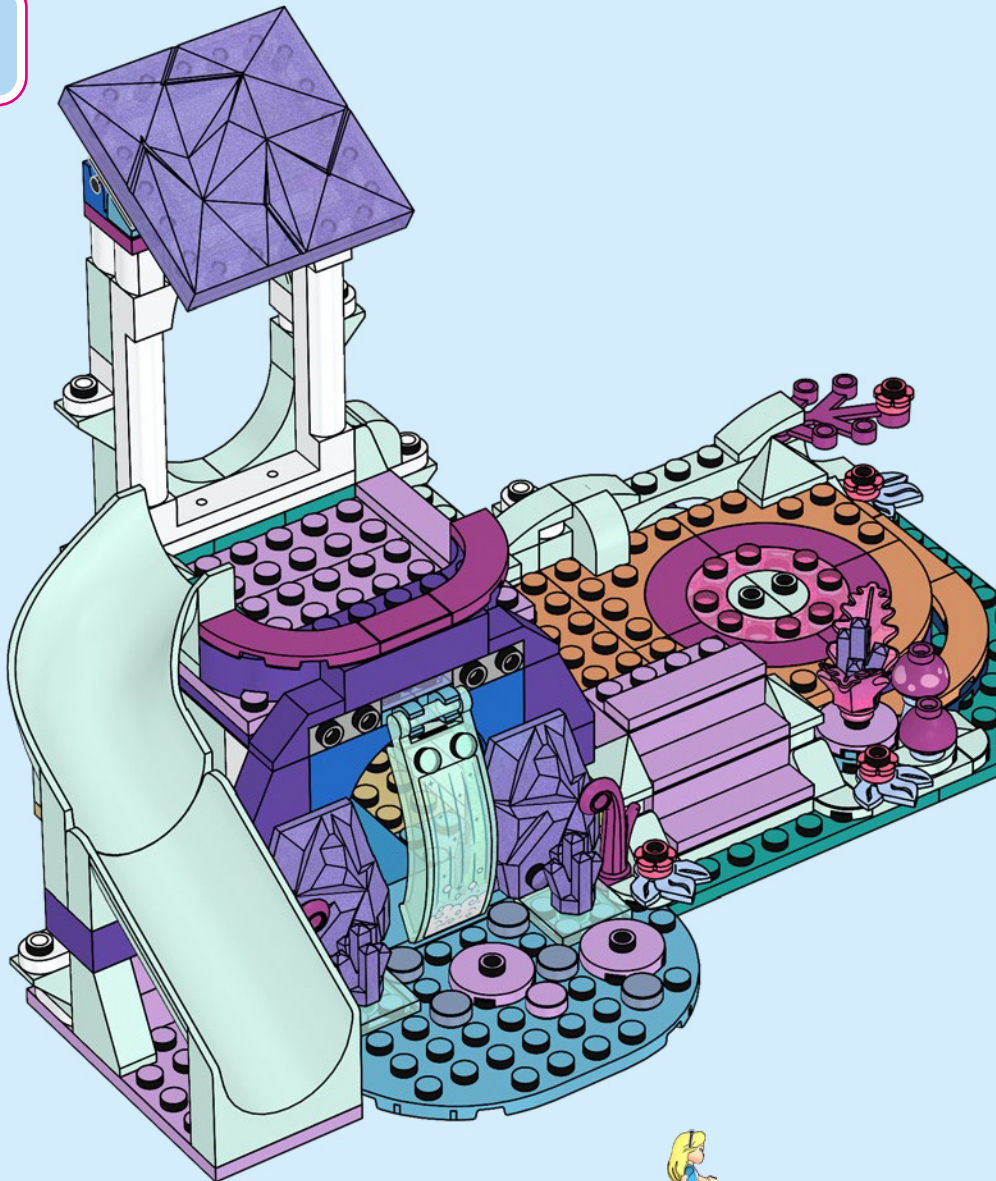



2x

97

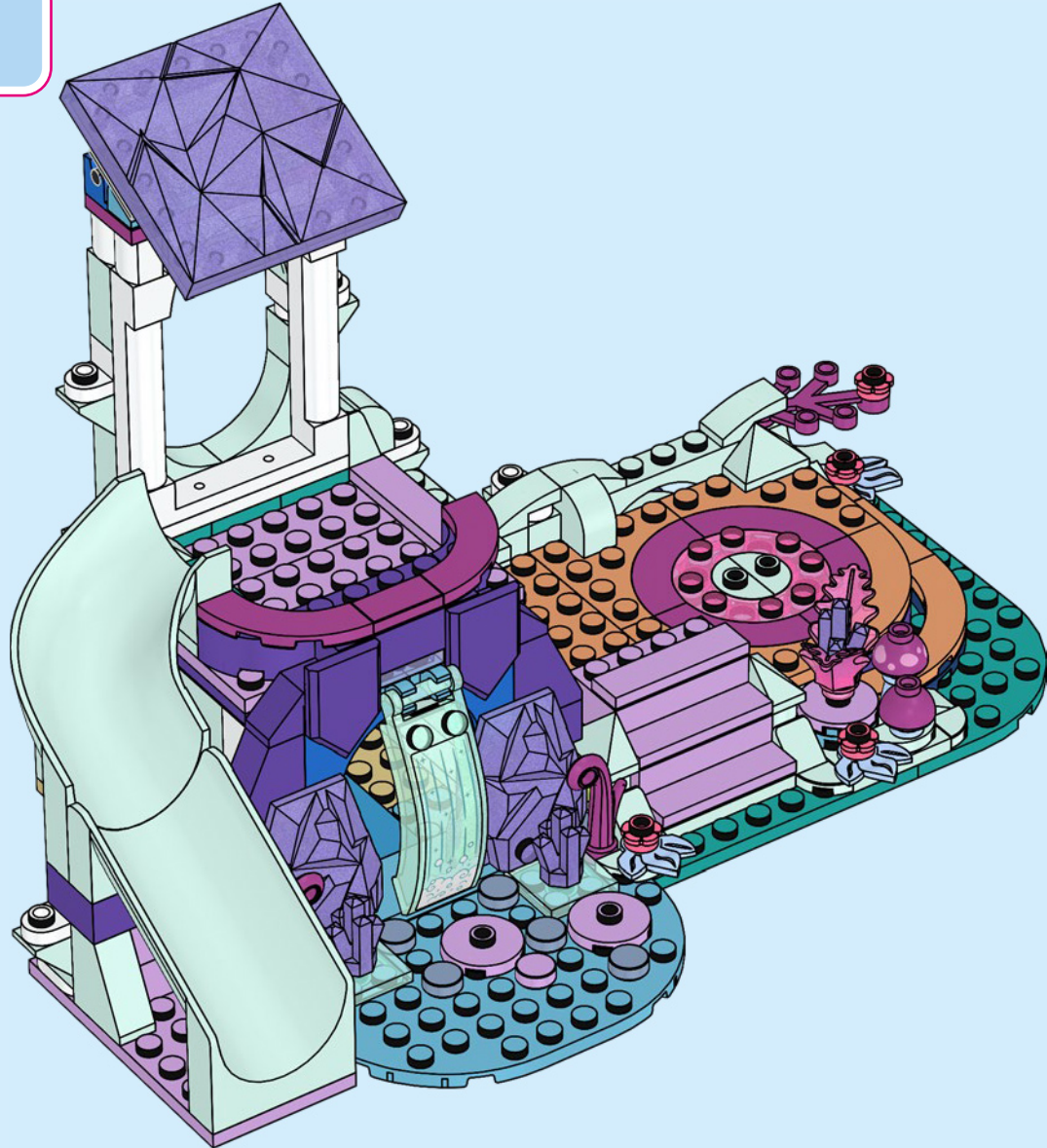



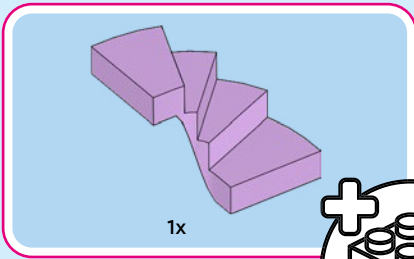

98

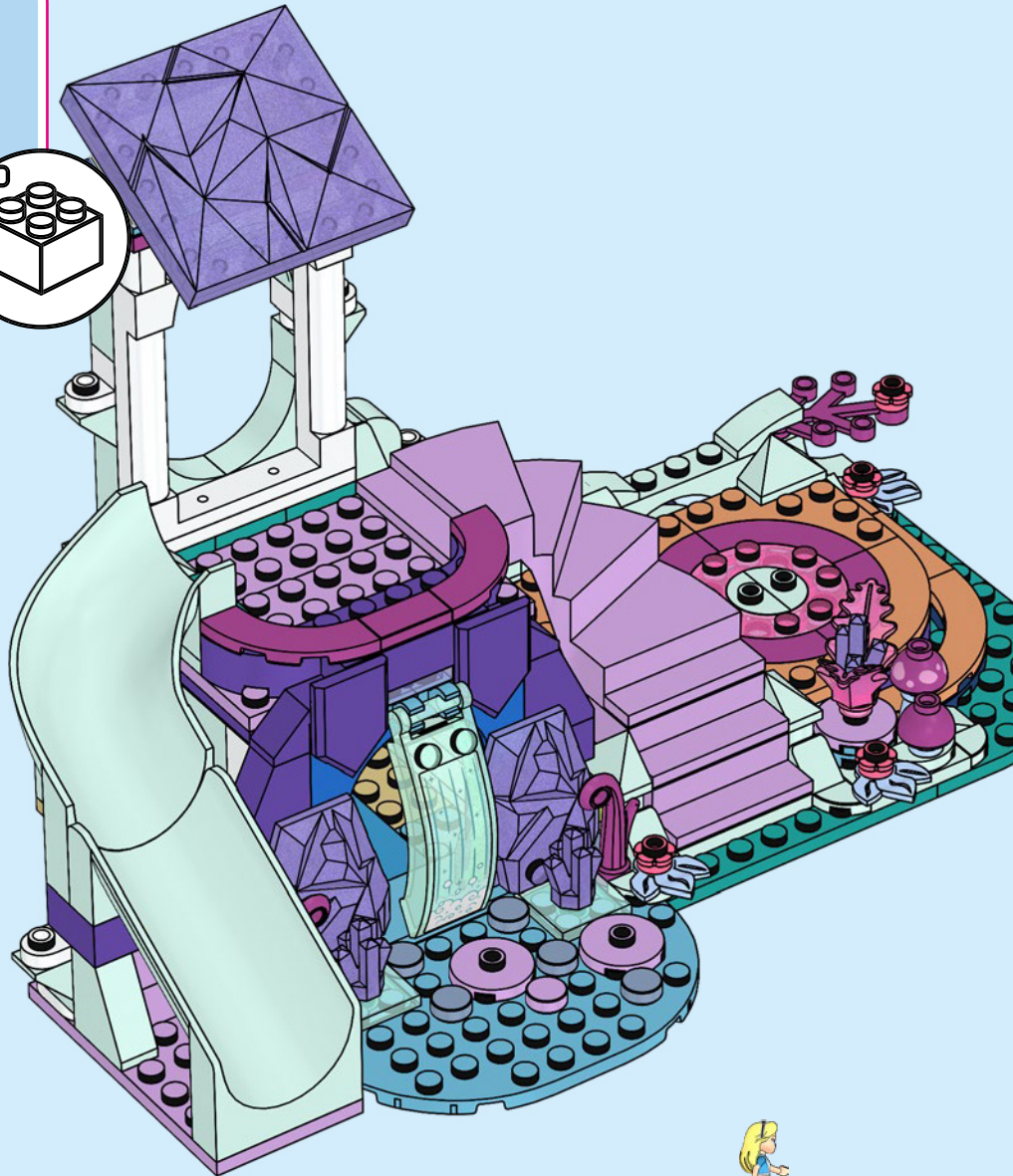



4x

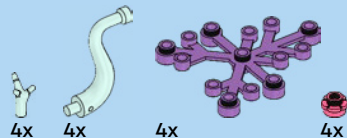

99

1

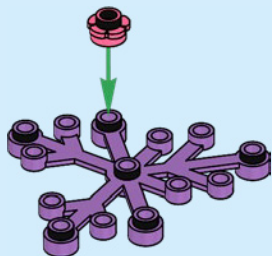

2

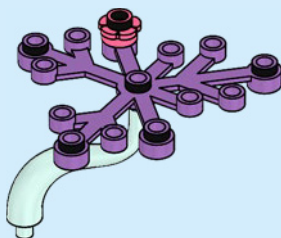

3

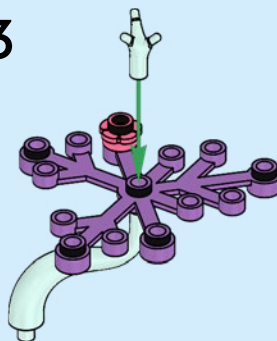

4x

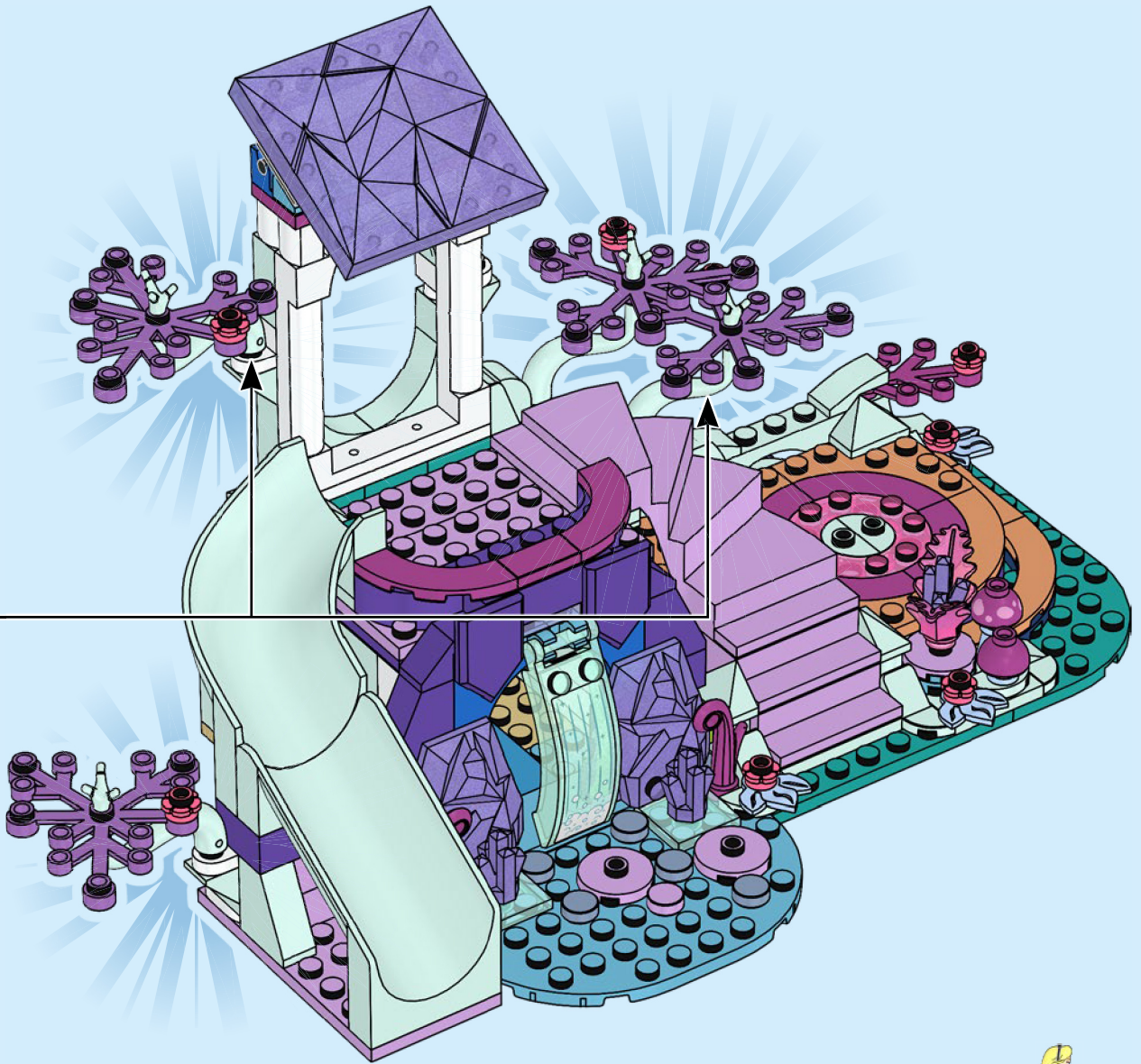

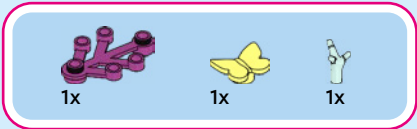

100

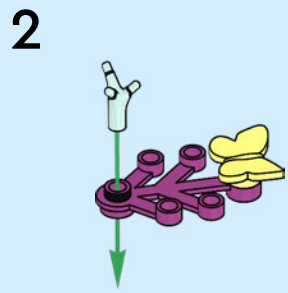
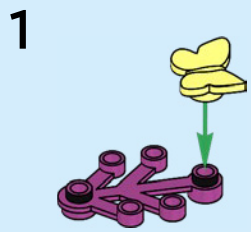

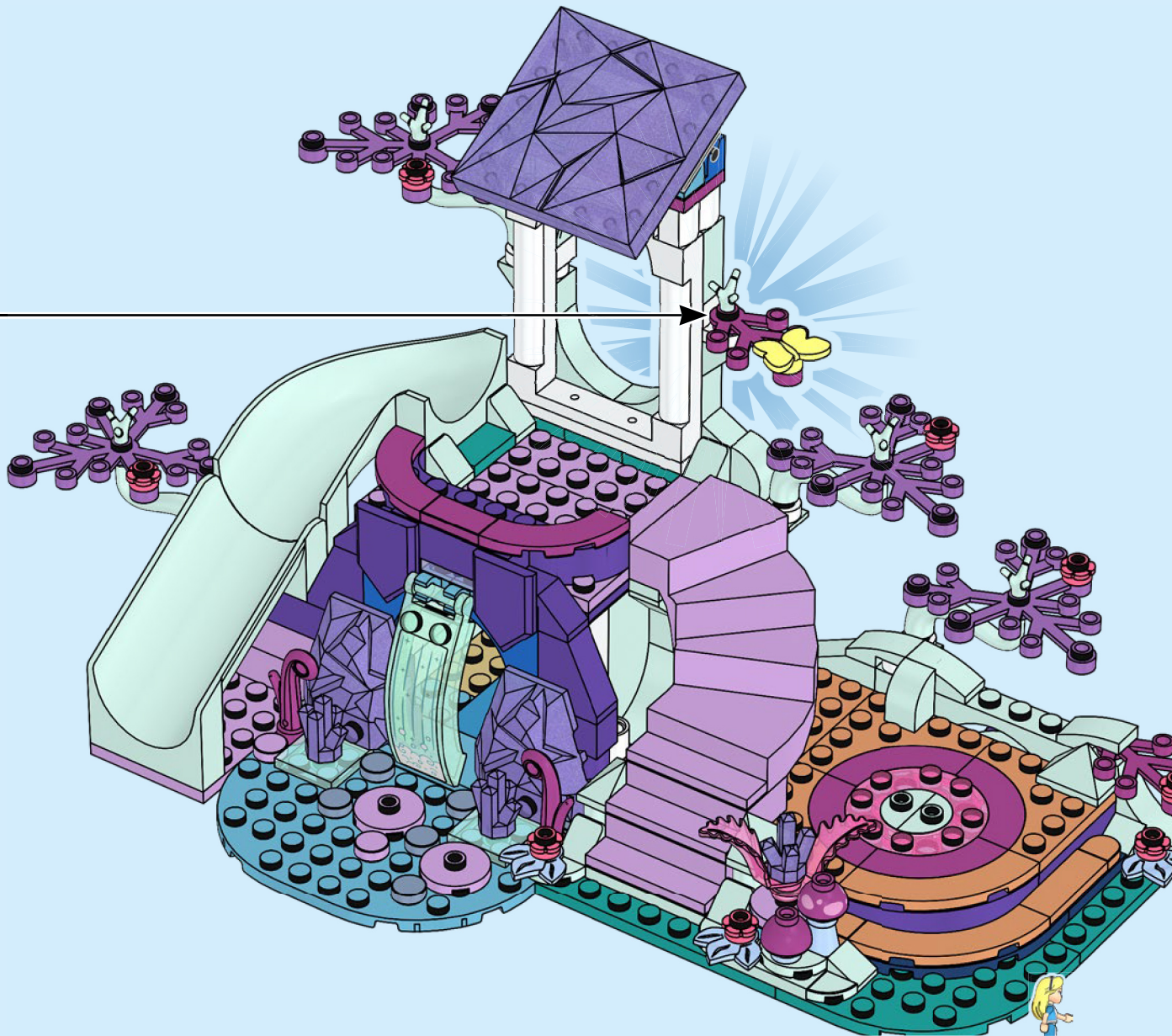

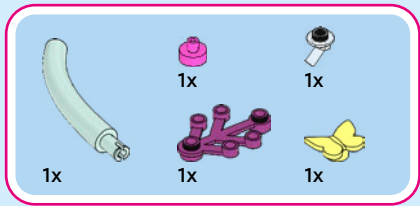

101

1

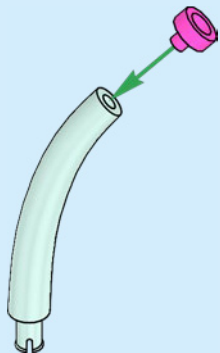

2

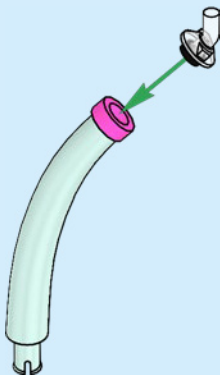

3

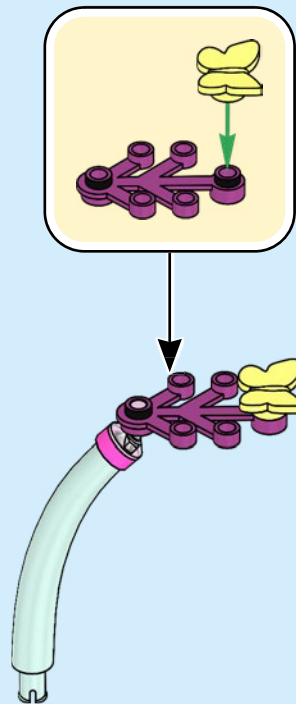

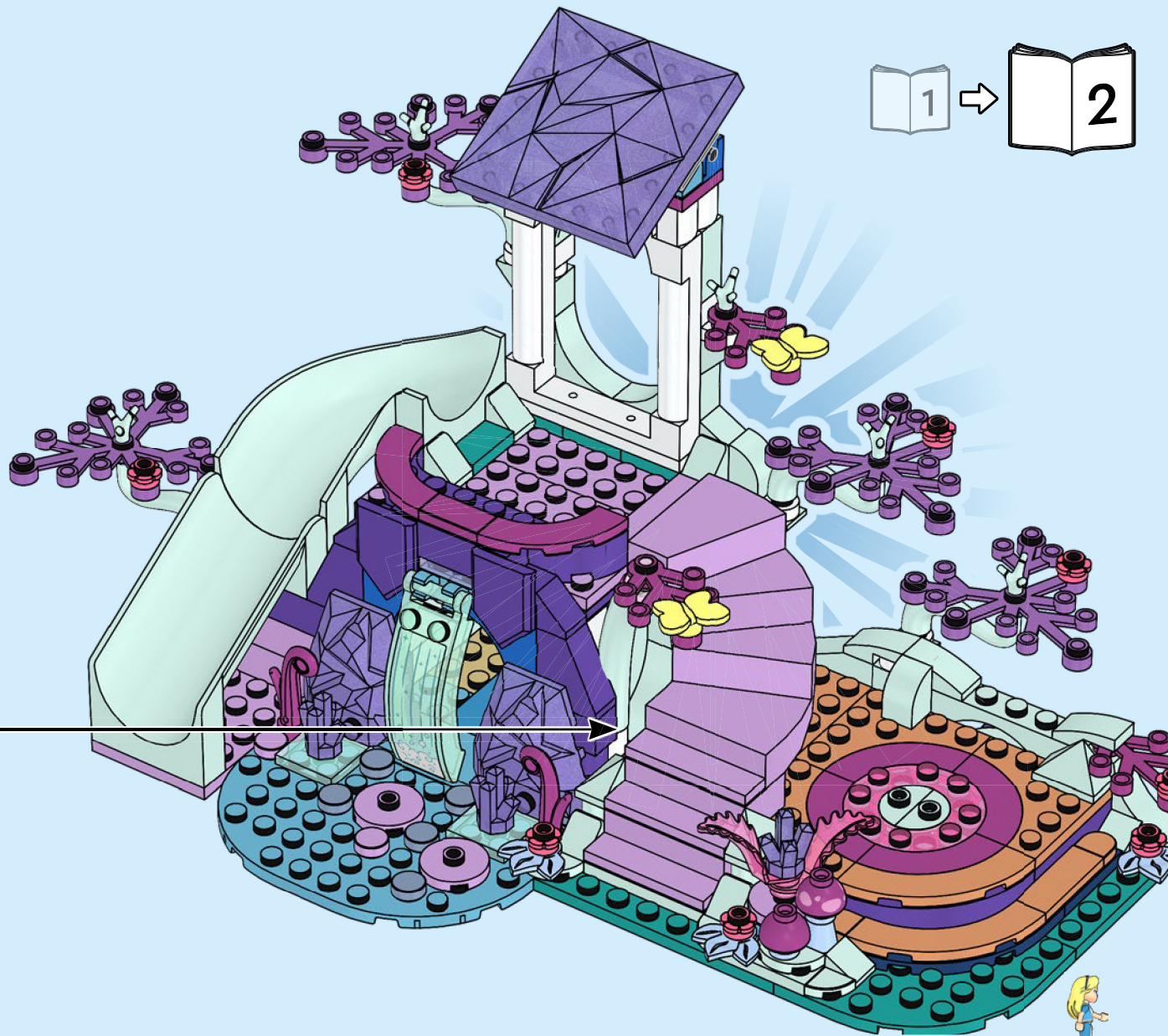
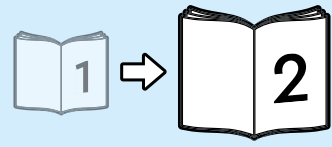

YOU COULD

WIN



Scan this QR code or go to  
**LEGO.COM/PRODUCTFEEDBACK** and give us  
your short feedback about this LEGO® set for a  
chance to win a cool LEGO prize.

Terms and Conditions apply\*

**EN: YOU COULD WIN.** Terms and Conditions apply\* **DE: Du könntest GEWINNEN.** Es gelten die Teilnahmebedingungen\* **FR: Tu pourrais GAGNER.** Des conditions s'appliquent\* **IT: Potresti VINCERE tu.** Termini e condizioni sono applicabili\* **ES: Puedes GANAR.** Aplican términos y condiciones\* **PT: Poderá GANHAR.** Aplicam-se termos e condições\* **ZH: 轻松获奖. 条款和条件适用\*** **PL: Szansa na WYGRANĄ.** Obowiązują warunki korzystania\* **CS: Máte šanci VYHRÁT.** Platí všeobecné smluvní podmínky\* **SK: Máte šancu VYHRAŤ.** Platia všeobecné zmluvné podmienky\* **HU: TE IS NYERHETSZ.** Felhasználási feltételek érvényesek\* **RO: Ai putea CÂȘTIGA.** Se aplică termeni și condiții\* **BG: Можете да СПЕЧЕЛИТЕ.** Има определени правила и условия\* **LV: Tu vari LAIMĒT.** Ir spēkā noteikumi un nosacījumi.\* **ET: Sul on võimalus VÕITA.** Kehtivad tingimused\* **LT: Jūs galite LAIMĖTI.** Taikomos sąlygos\*

\*[LEGO.com/productfeedback-terms](https://www.lego.com/productfeedback-terms)

LEGO and the LEGO logo are trademarks of the/ont des marques de commerce du/son marcas registradas de LEGO Group.  
©2023 The LEGO Group. ©Disney

6468546