



# Friends

42618



LEGO® Builder



LEGO.com/sustainable-packaging



FR  
**DONNEZ**  
OU  
**RECYCLEZ**



ASSOCIATION

OU



MAGASIN

OU



DÉCHÈTERIE

Adresses sur [quefairedemesdechets.fr](http://quefairedemesdechets.fr)

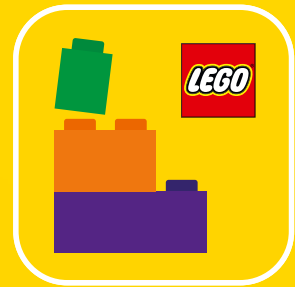

Q LEGO® Builder

# BUILDER



Apple and the Apple logo are trademarks of Apple Inc., registered in the U.S. and other countries and regions. App Store is a service mark of Apple Inc. Google Play and the Google Play logo are trademarks of Google LLC. Tencent and the Tencent logo are trademarks of Tencent Inc.

Q [LEGO.com/devicecheck](https://LEGO.com/devicecheck)

EN Ask parents' permission before going online | DE Eltern um Erlaubnis bitten, bevor du online gehst | FR Demande l'autorisation d'un parent avant d'aller en ligne | IT Chiedi il permesso ai tuoi genitori prima di andare online | ES Pídeles permiso a tus papás antes de conectarte a Internet | PT Peça autorização aos pais antes de acederes online | ZH 上网前应先征得父母的同意 | PL Poproś rodziców o zgodę, zanim wejdiesz do Internetu | CS Než půjdeš na internet, požádej rodiče o svolení | SK Skôr než pôjdeš na internet, vypýtaj si povolenie od rodičov | HU Kérj szülői engedélyt, mielőtt online csatlakoznál! | RO Cere permisiunea părinților înainte de a te conecta online | BG Поискайте разрешение от родител, преди да влезете онлайн | LV Pirms došanās tiešsaistē palūdz atļauju vecākiem | ET Enne Interneti kasutamist küsi vanematelt luba | LT Prieš prisijungdami prie interneto, atsklauskite tėvų

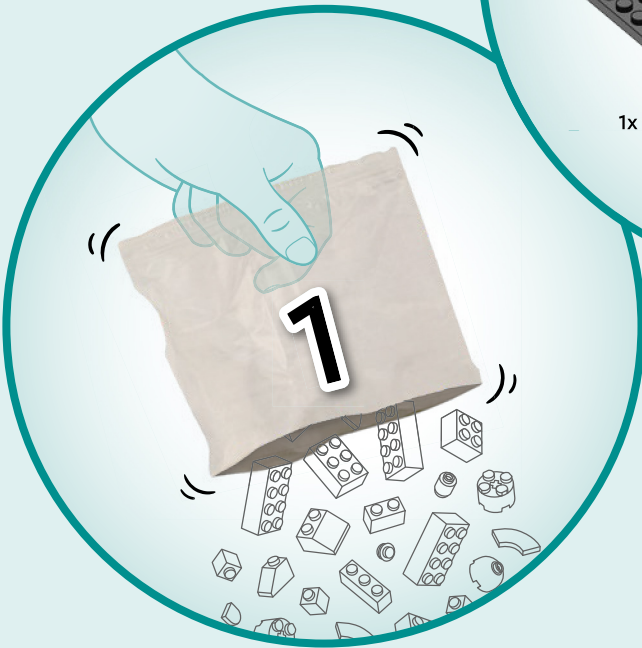
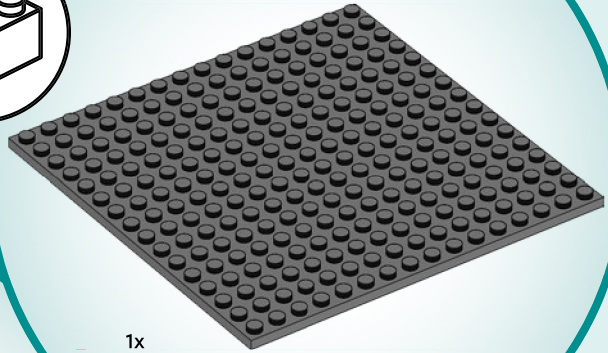
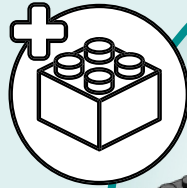

OLLY

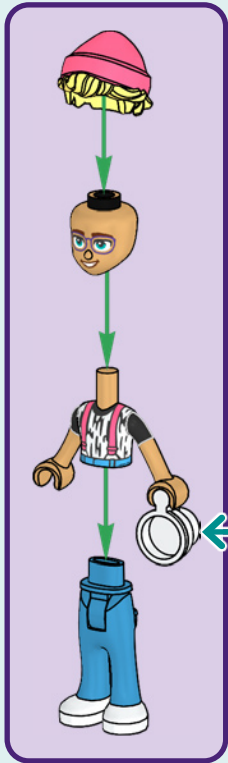
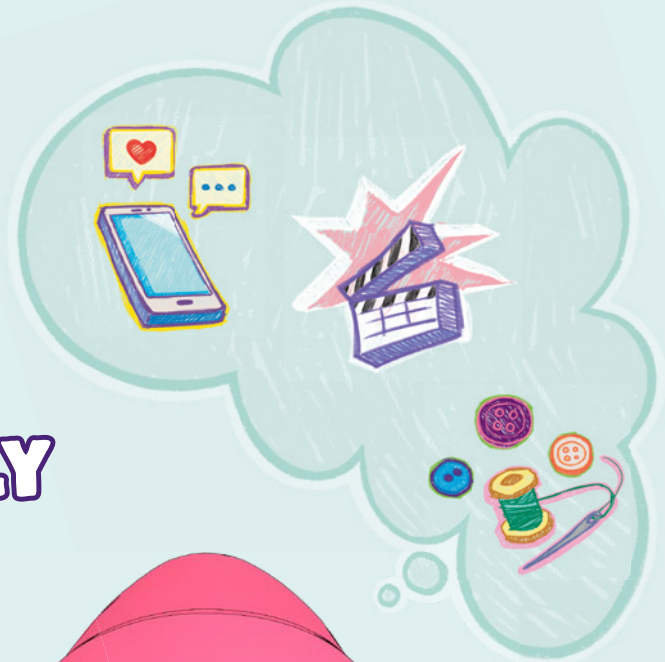

# PAISLEY

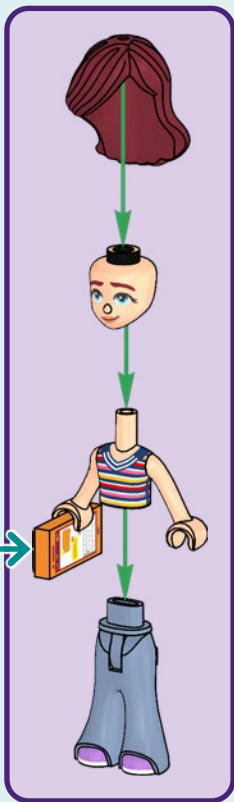

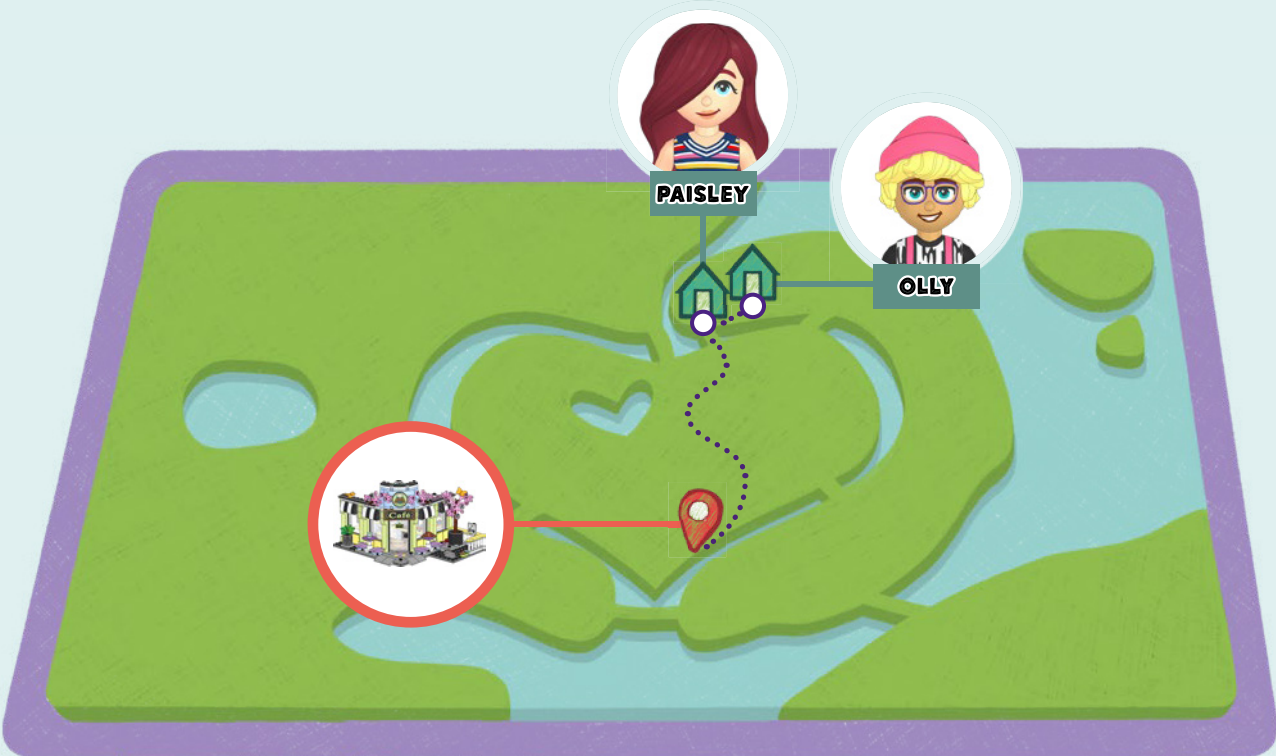

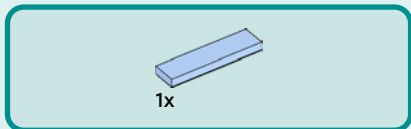

1

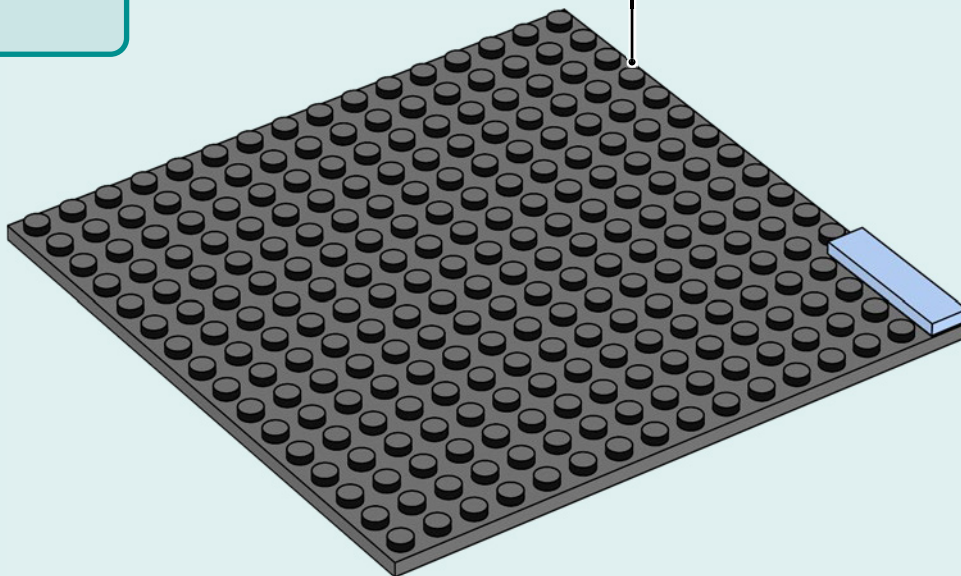
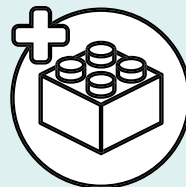





2x

2

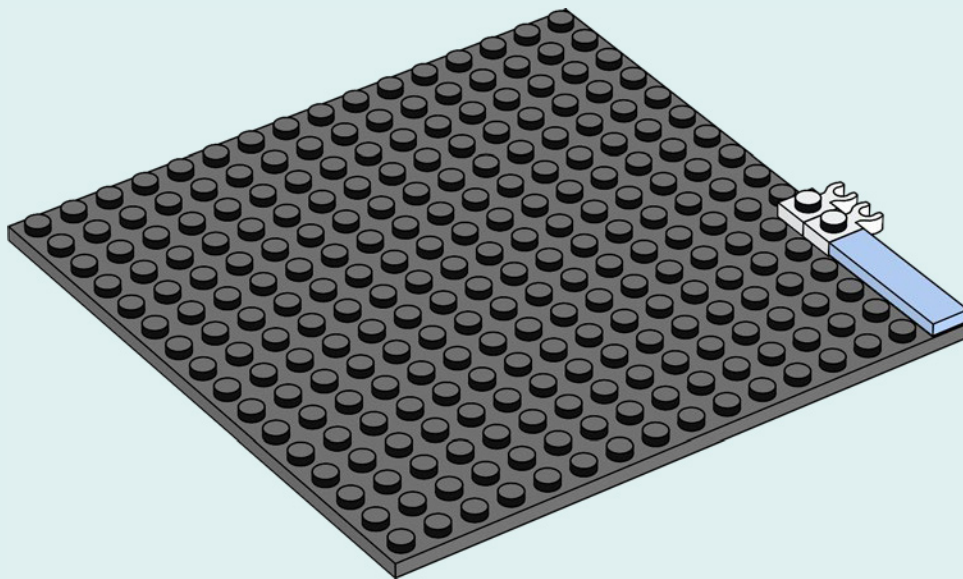



2x

3

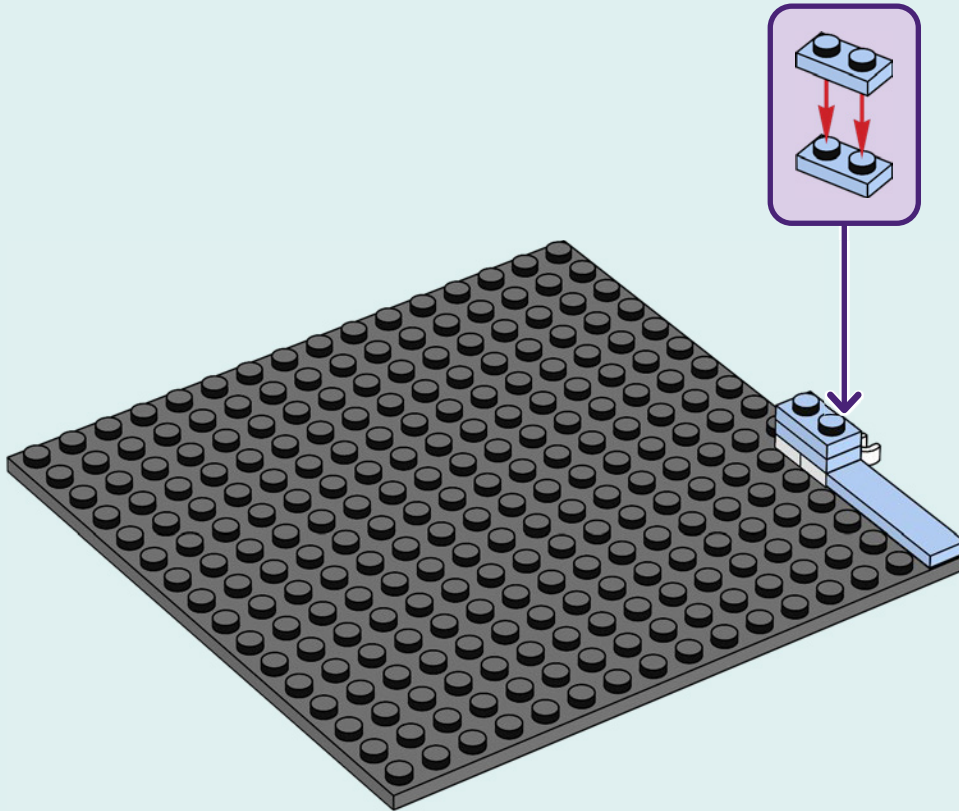

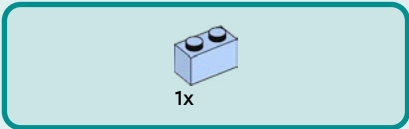

4

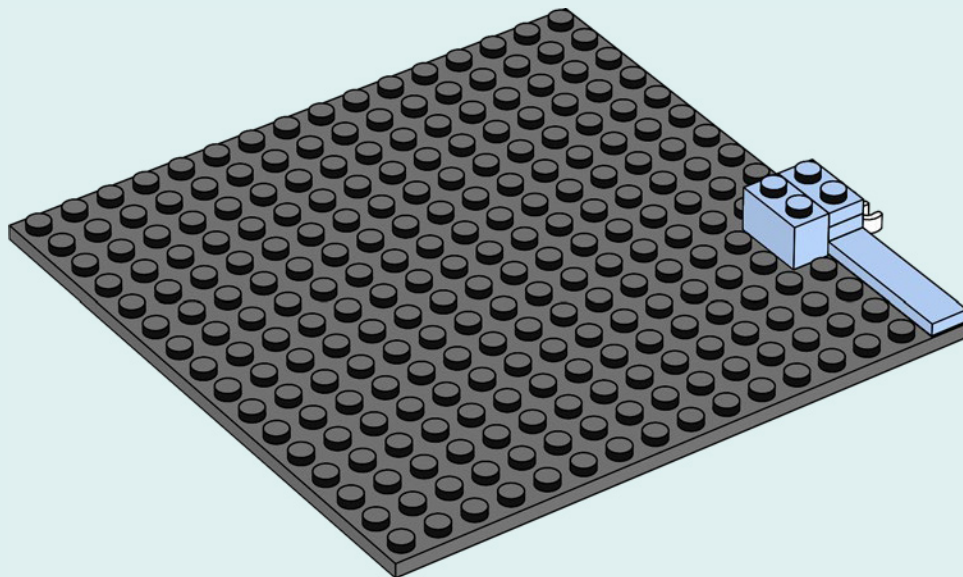



2x

5

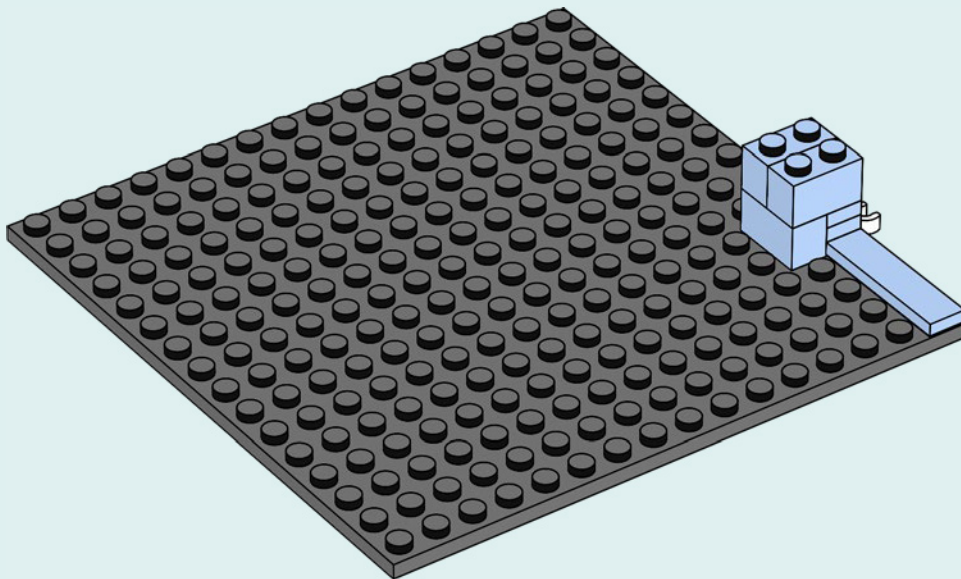



2x

6

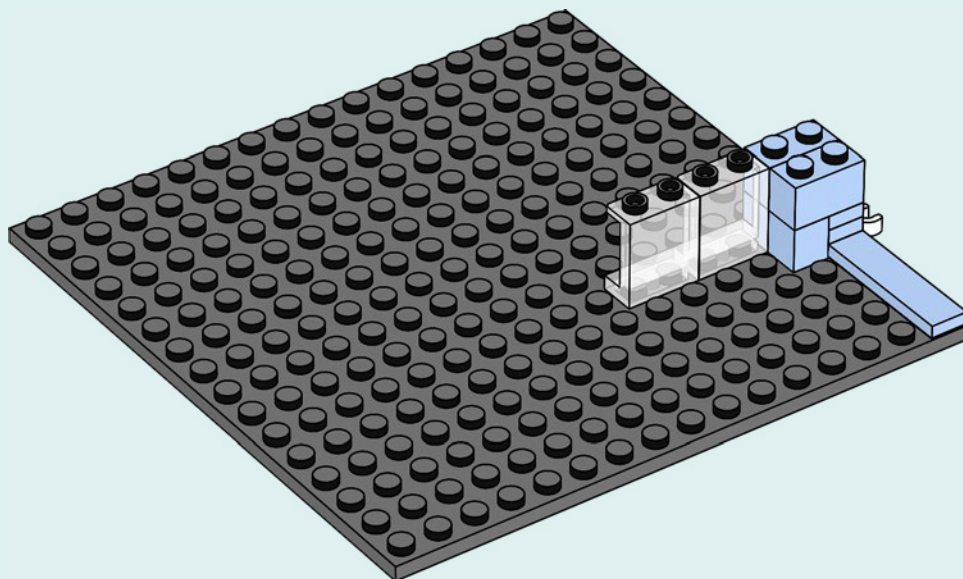

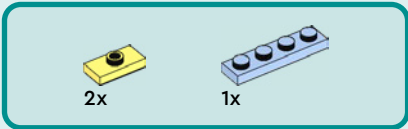

7

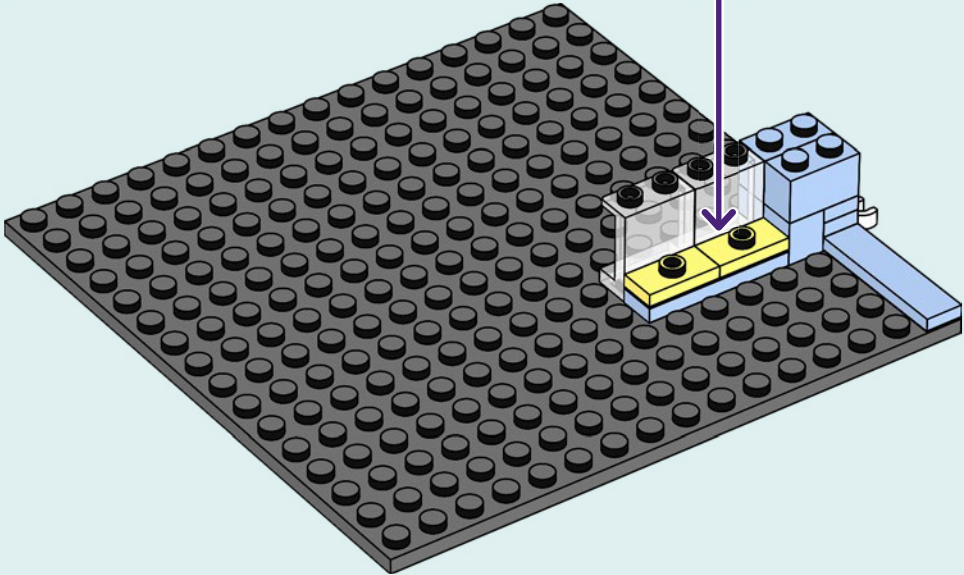
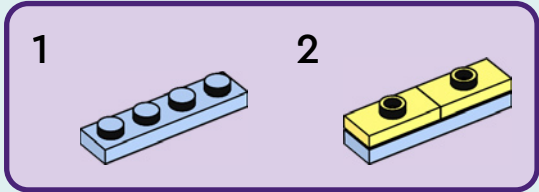



8

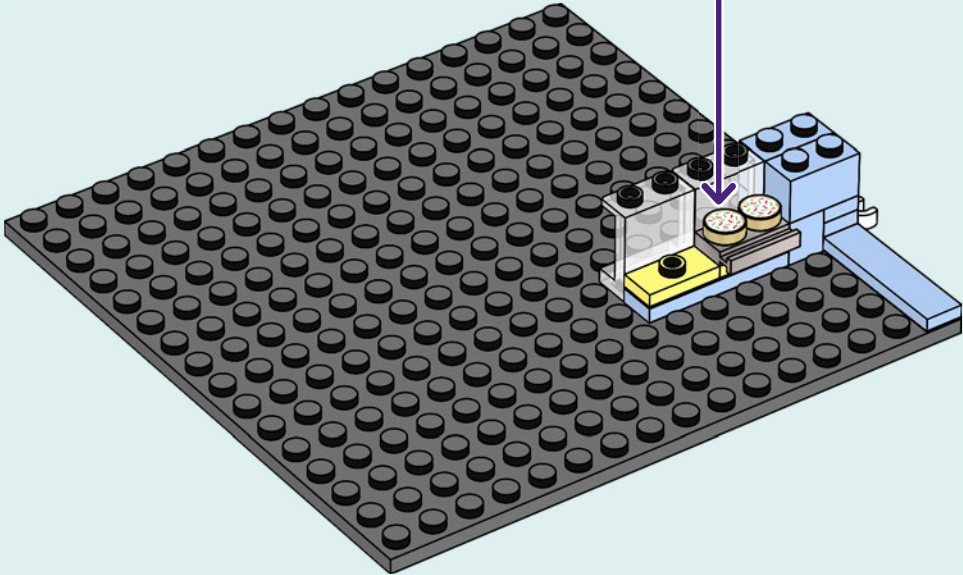
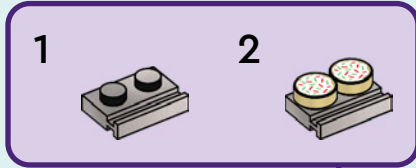



1x



2x

9

1



2

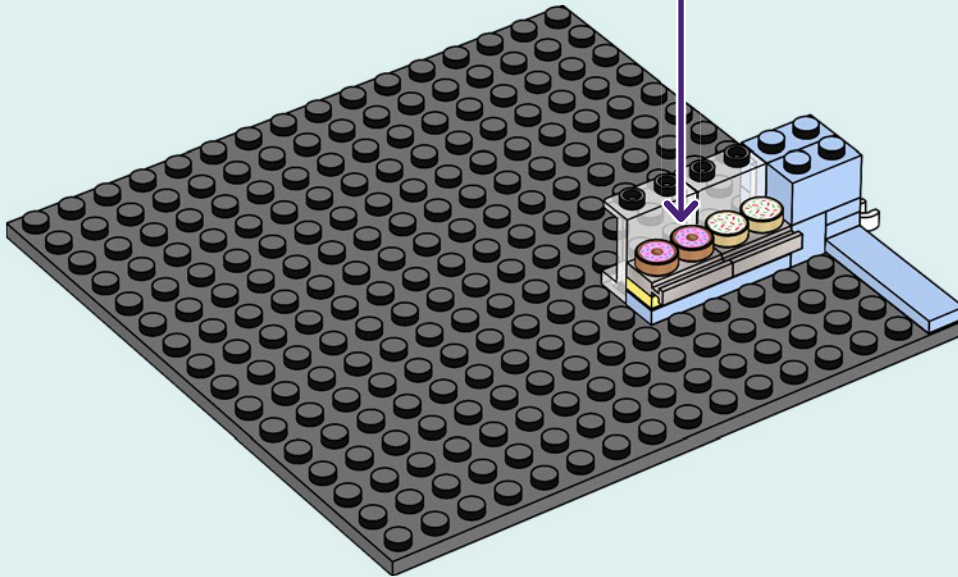





2x

10

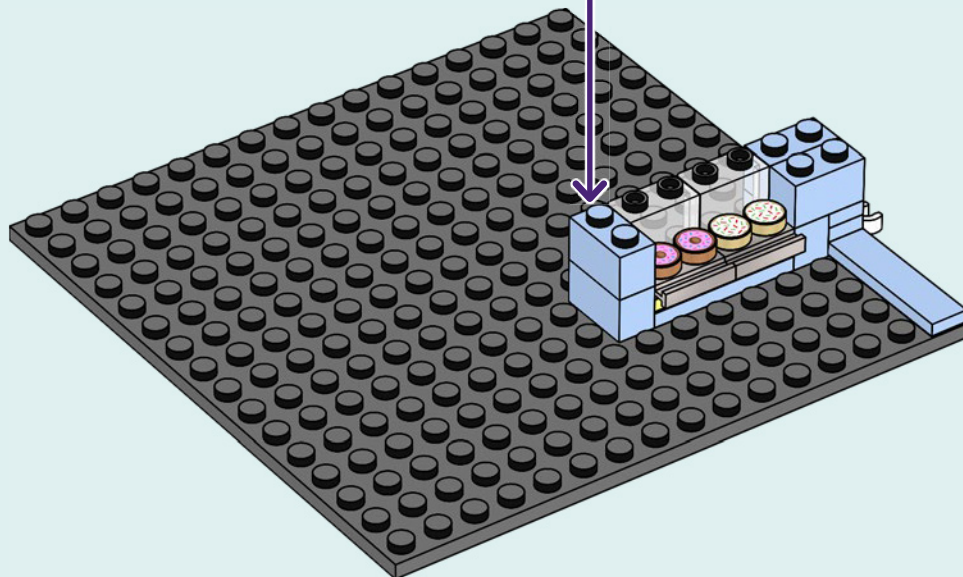
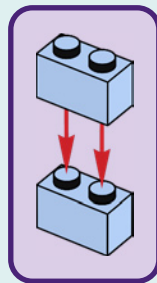

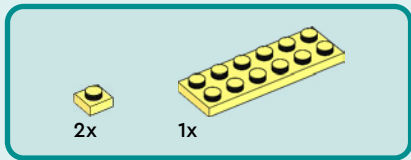

11

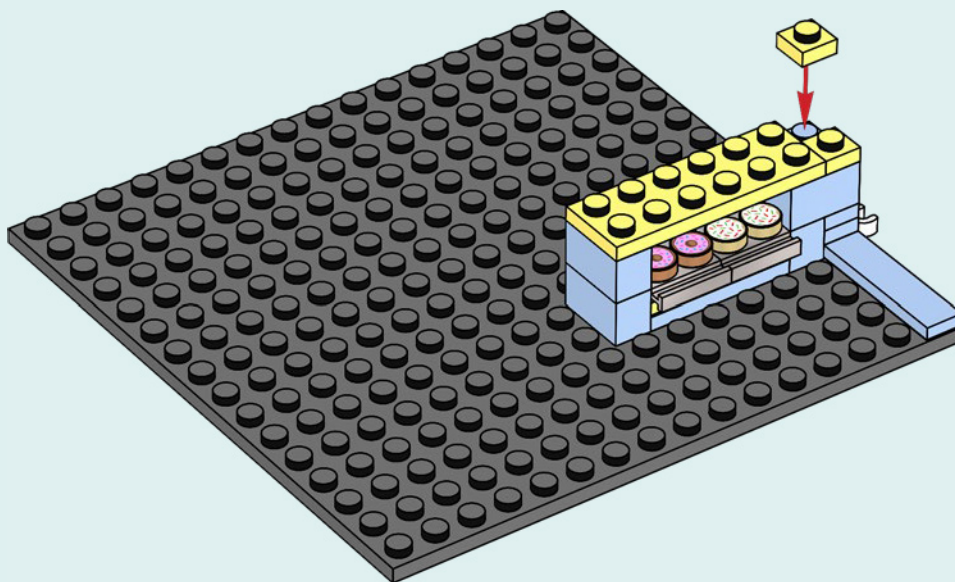



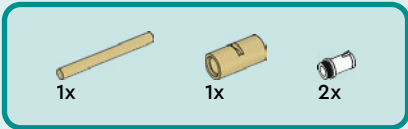

# 13

1

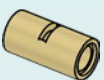

2

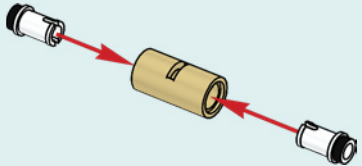

3

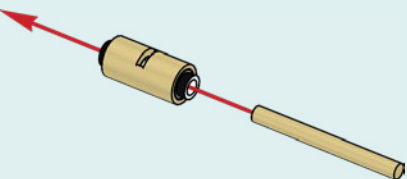

4



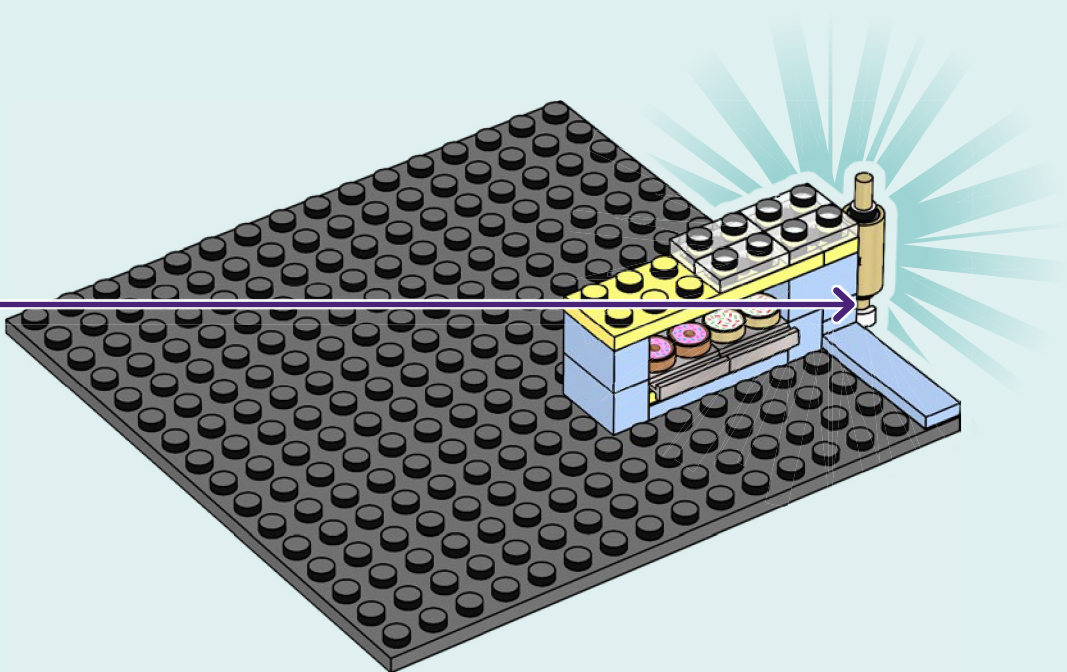



2x



2x



2x



2x

# 14

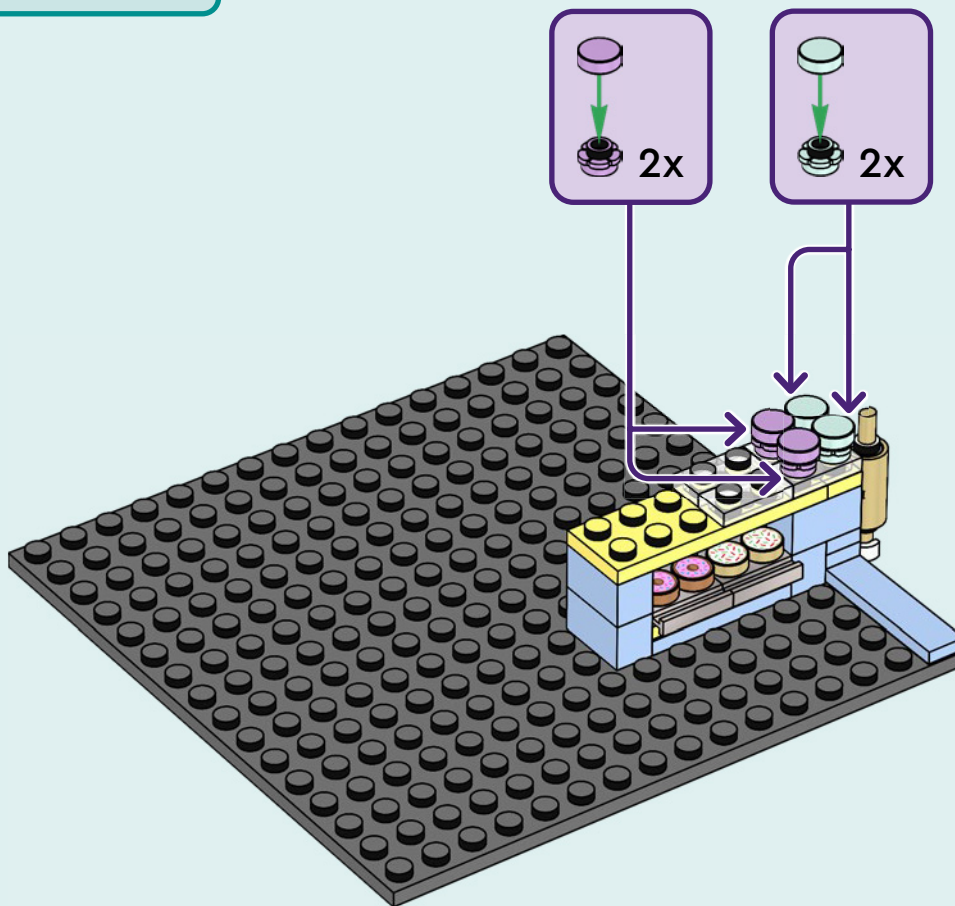

2x 2x 2x 2x

15

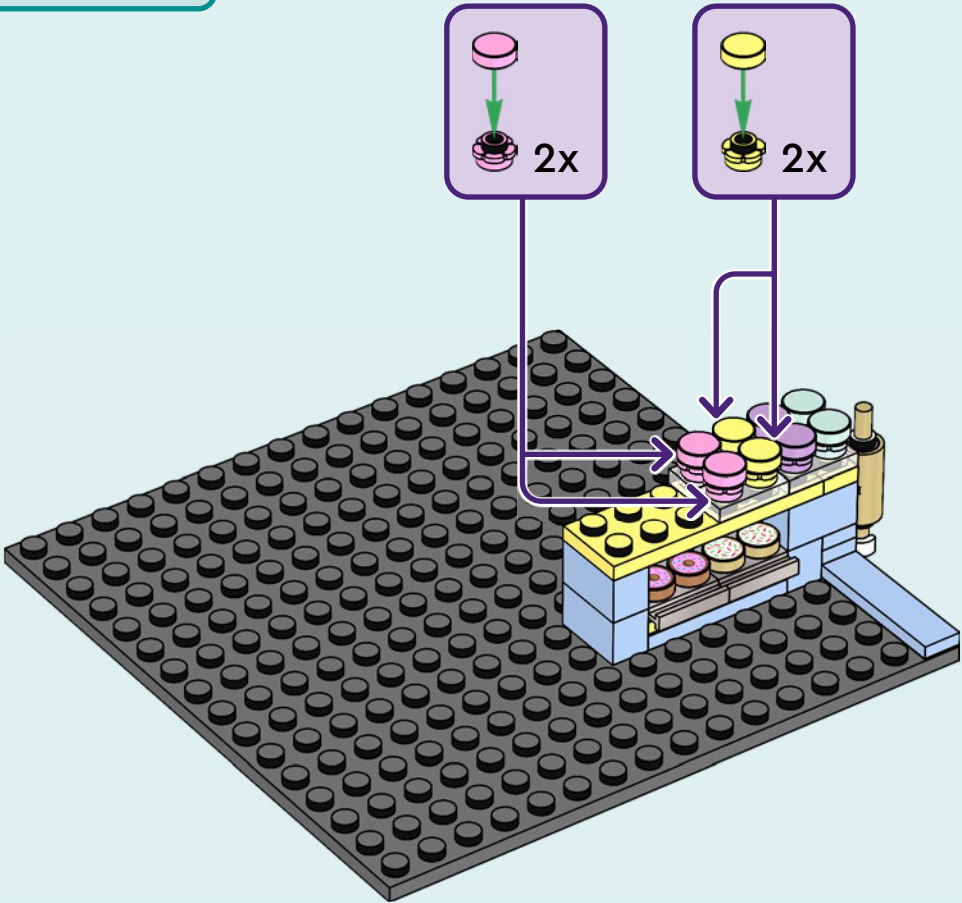

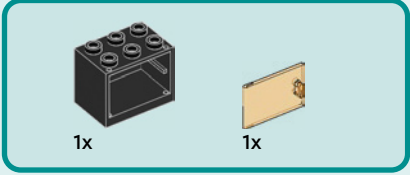
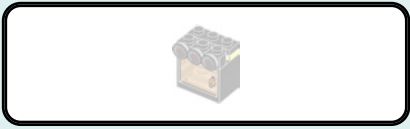

16

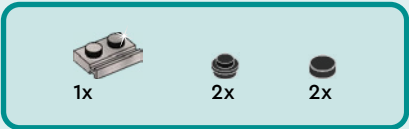
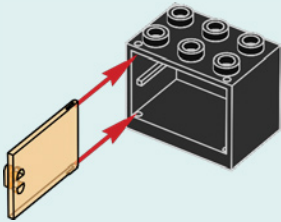

17

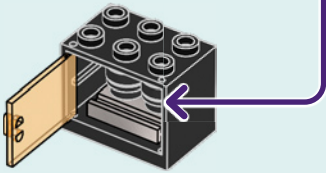





1x

18

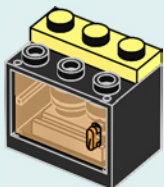

3x

19

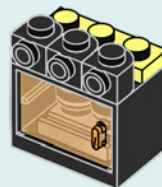



1x

20

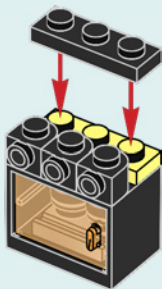

3x

21



22

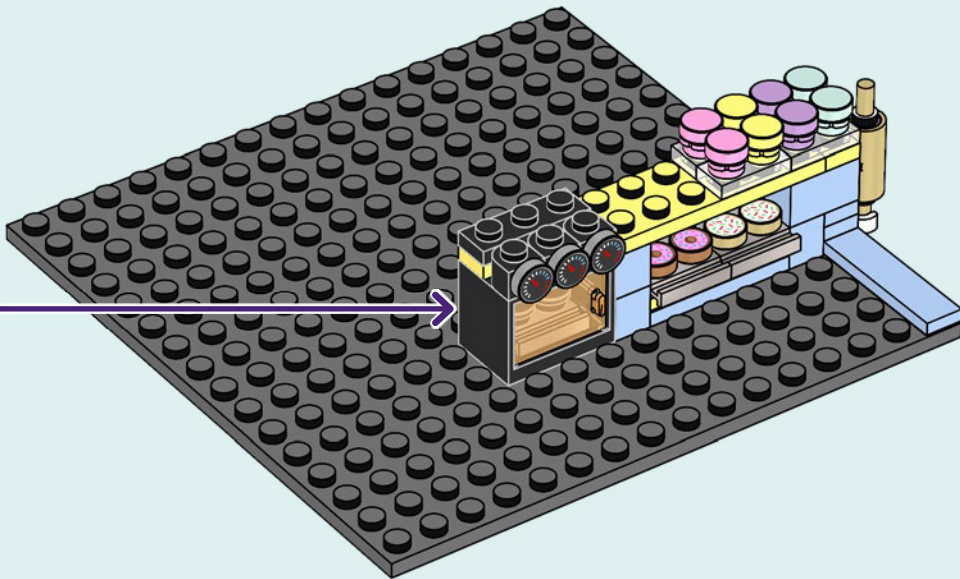



3x

23

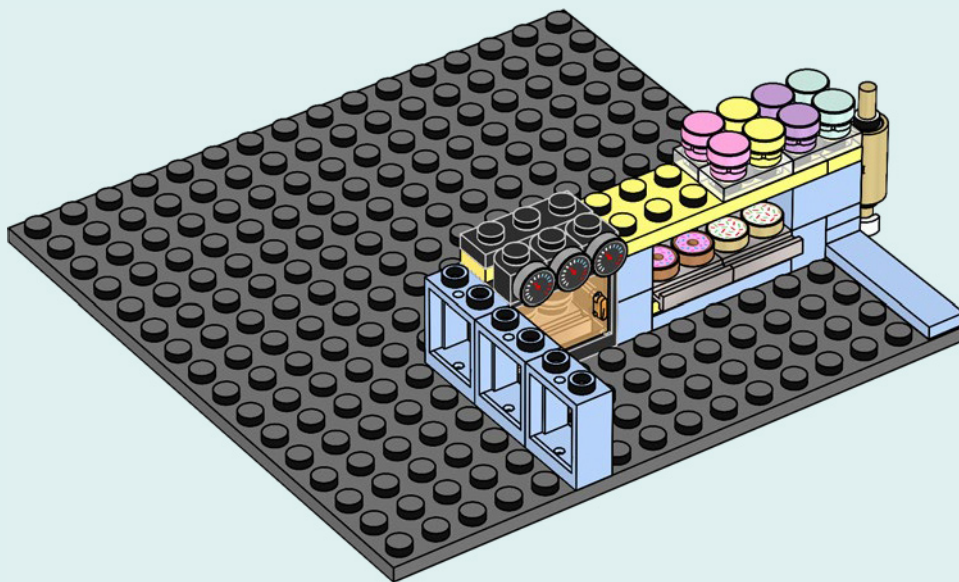



3x

24

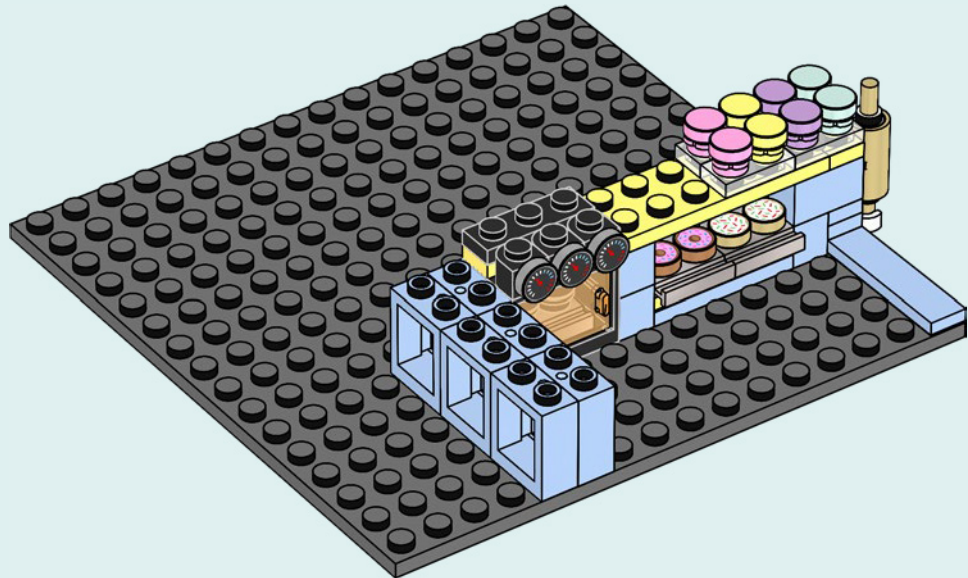



3x

25

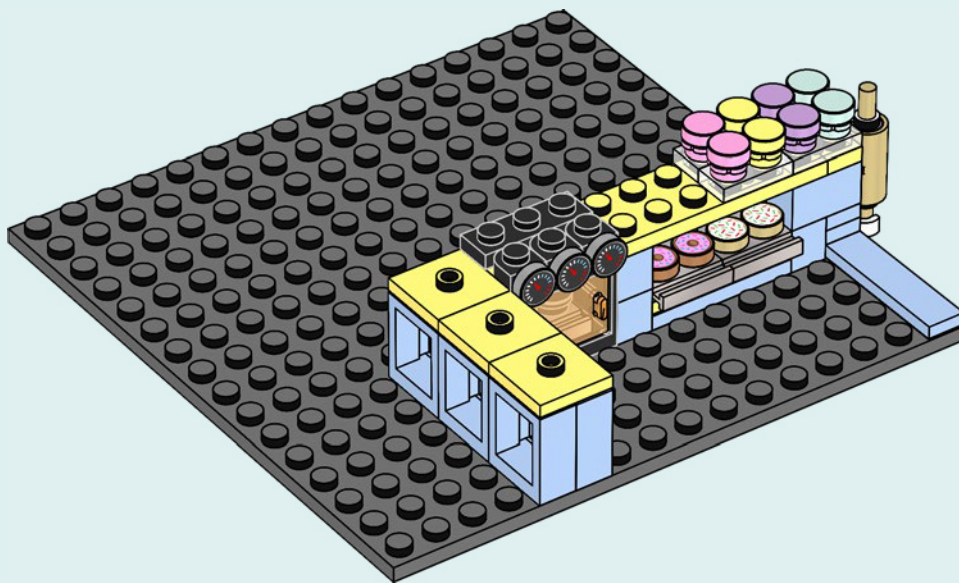

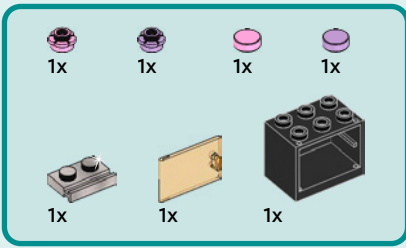

26

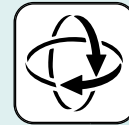
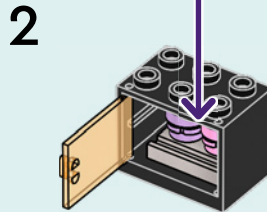
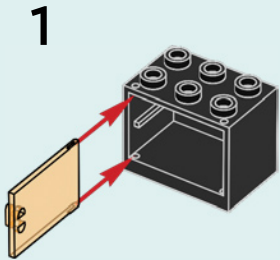
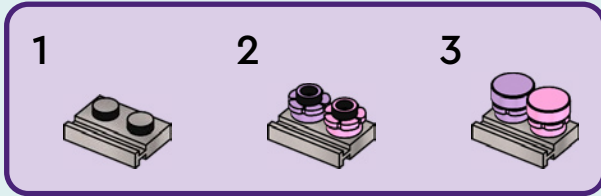

3



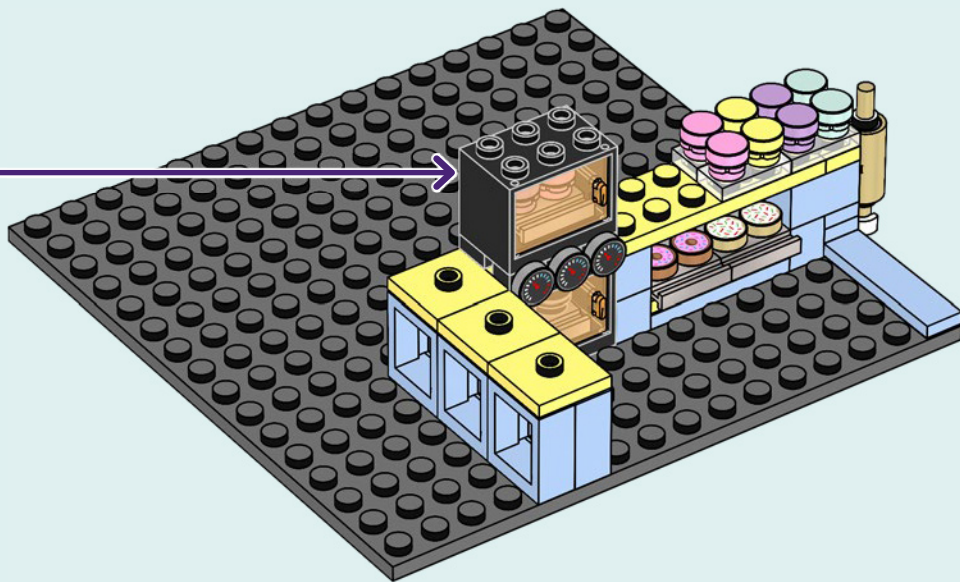



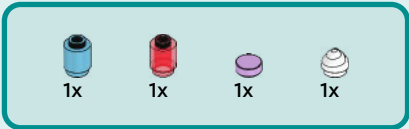

27

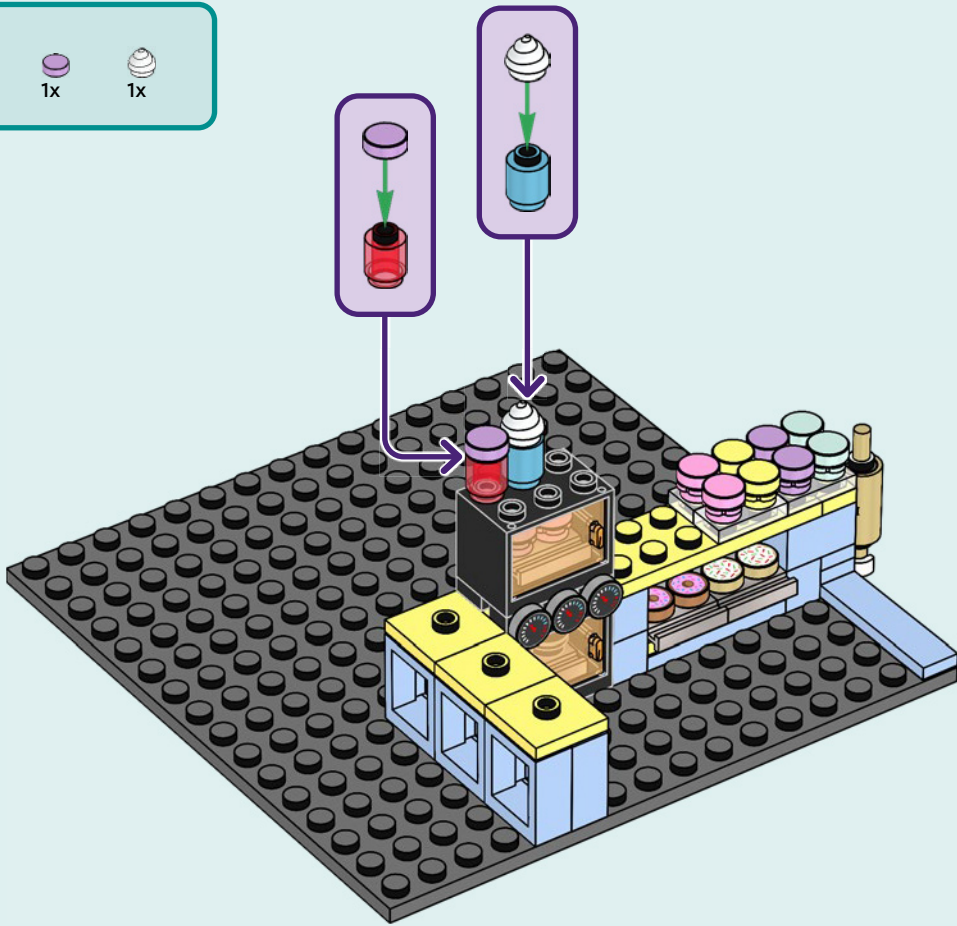



1x



1x

28

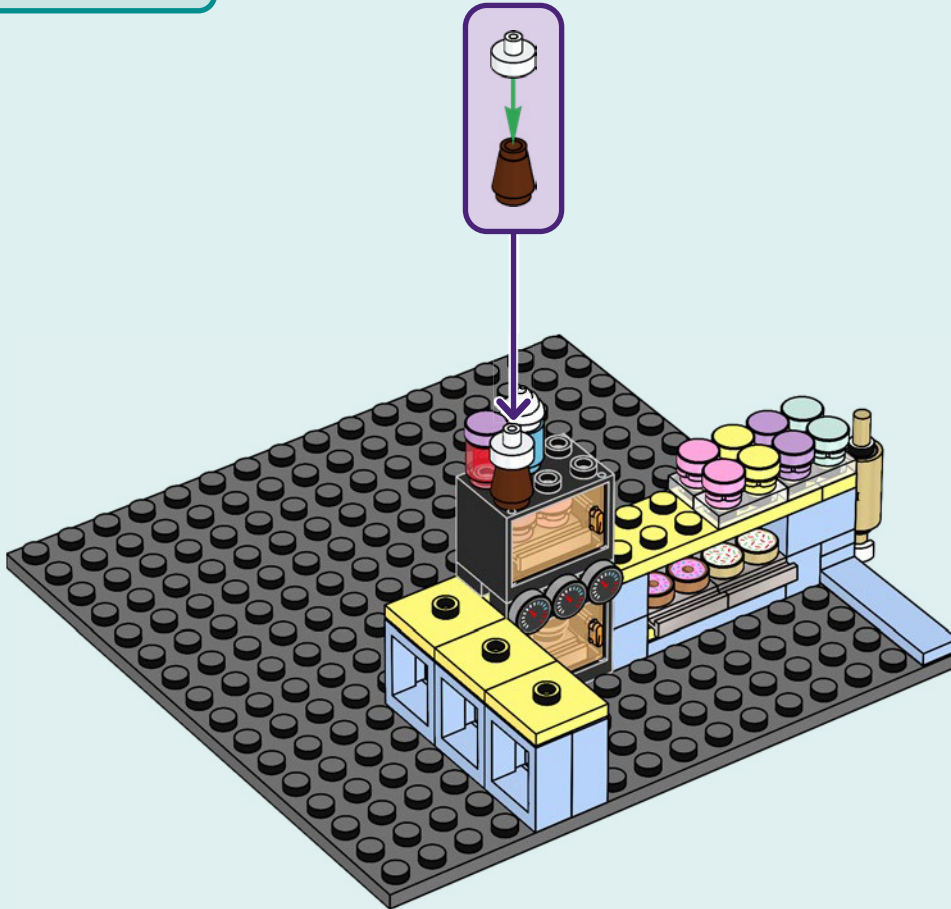

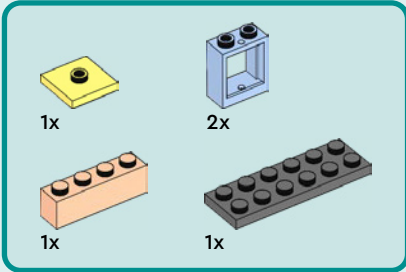
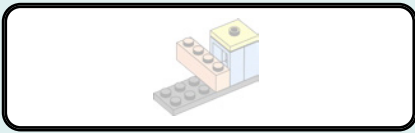

29

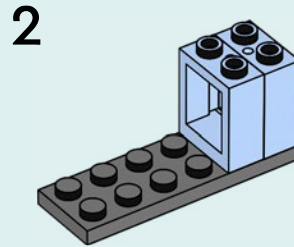
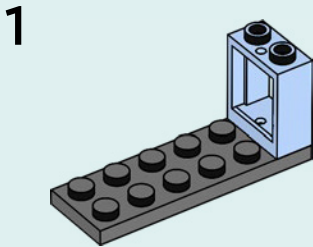

3

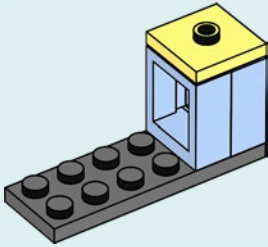

4

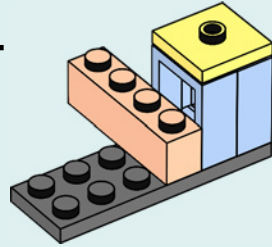

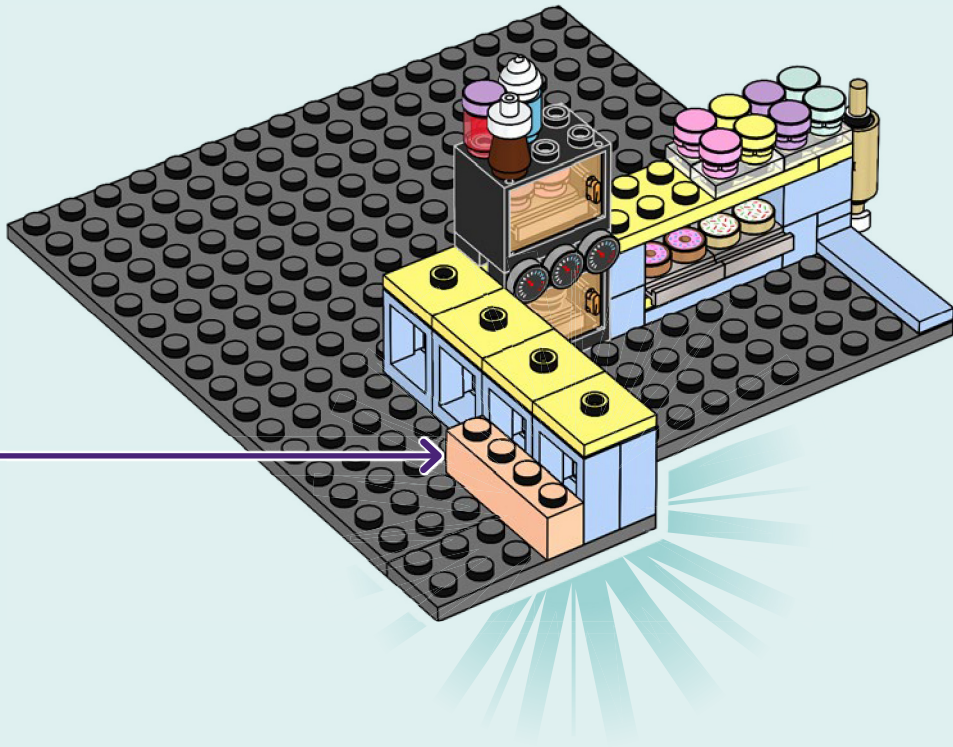



1x



1x

# 30

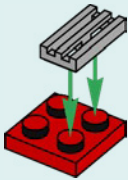

1x

# 31

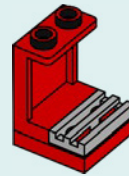

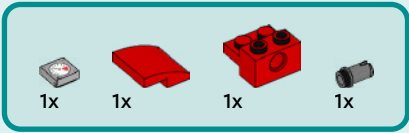

32

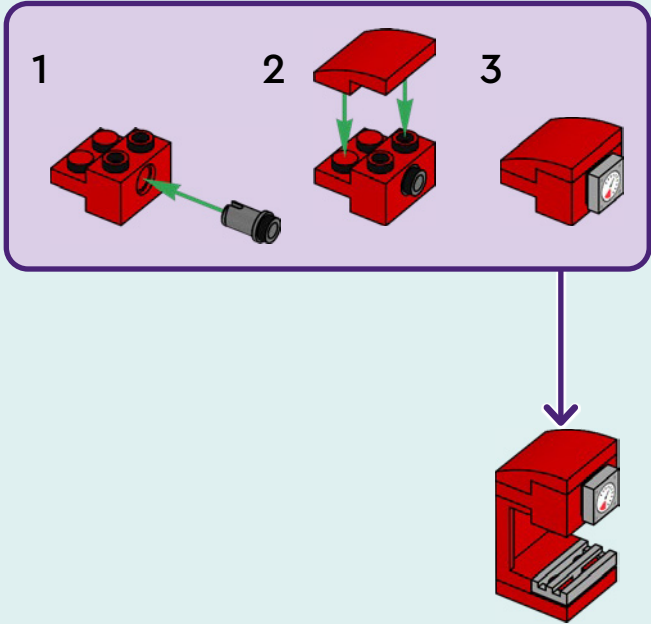

33

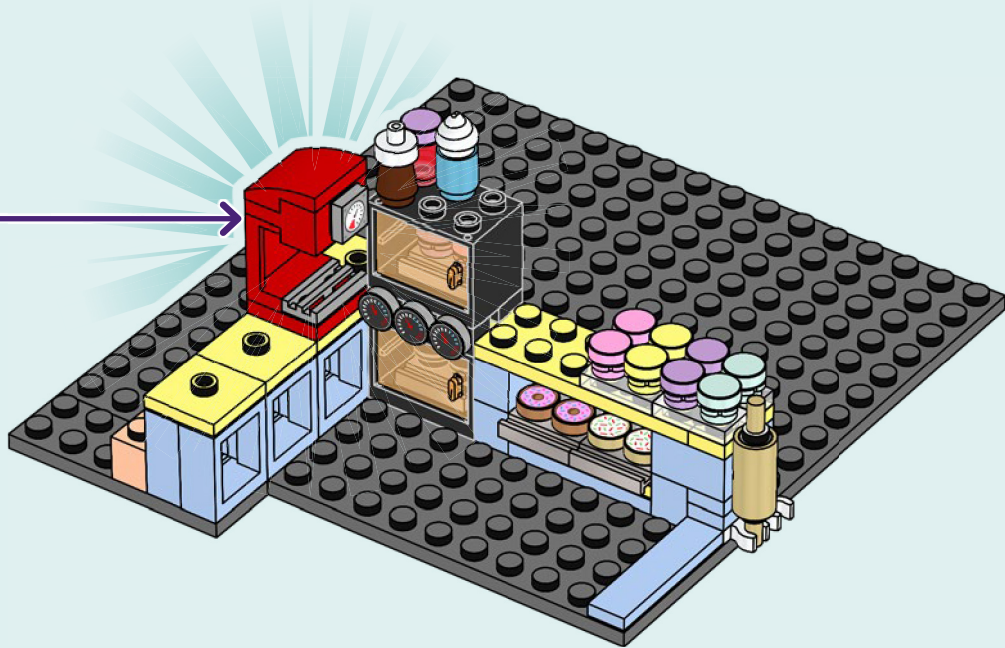





1x

34



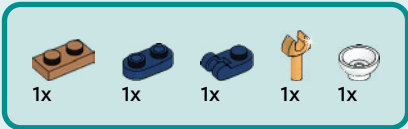

# 35

1

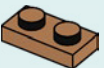

2



3



4



5





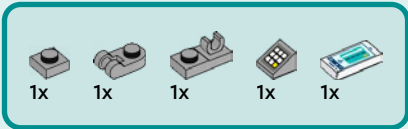

# 36

1

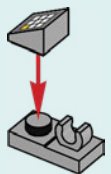

2

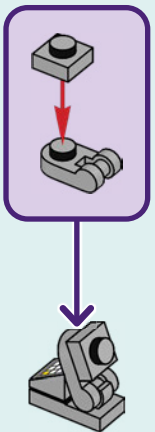

3

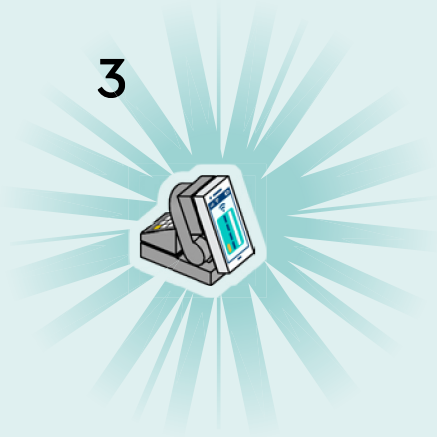

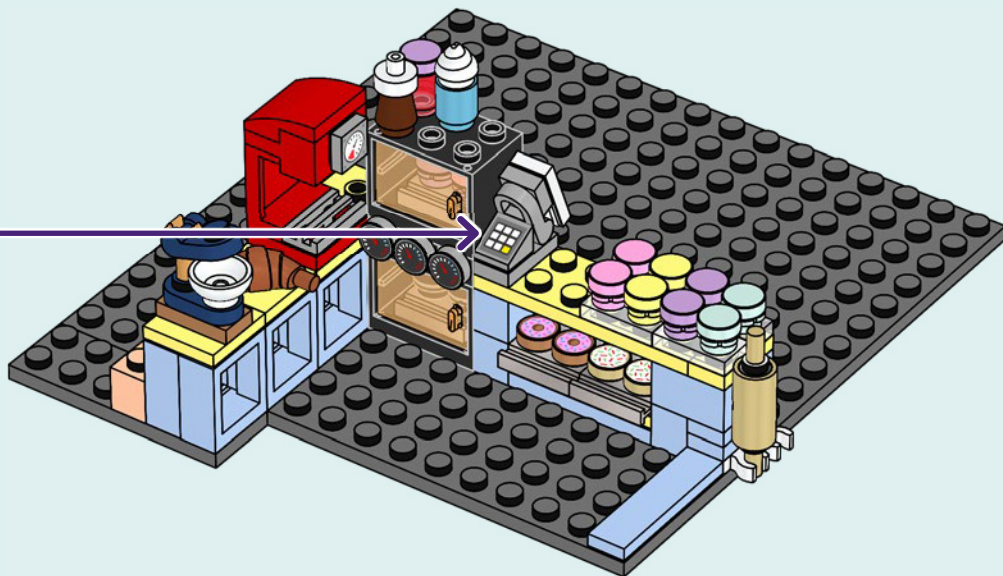

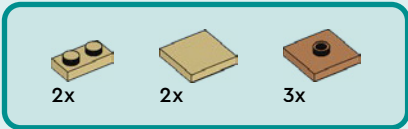

37



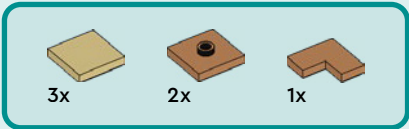

38



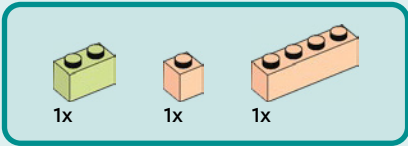

39





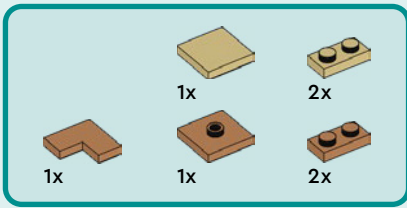

40



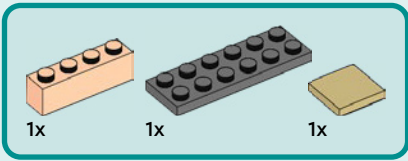

41

1

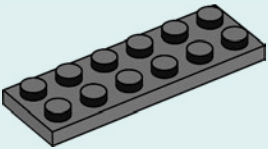

2

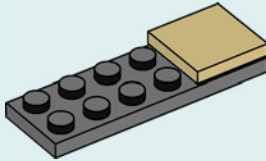

3

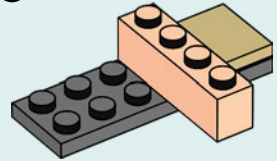



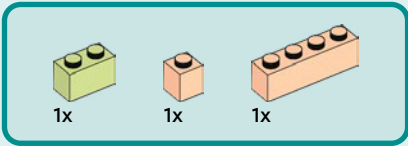

42

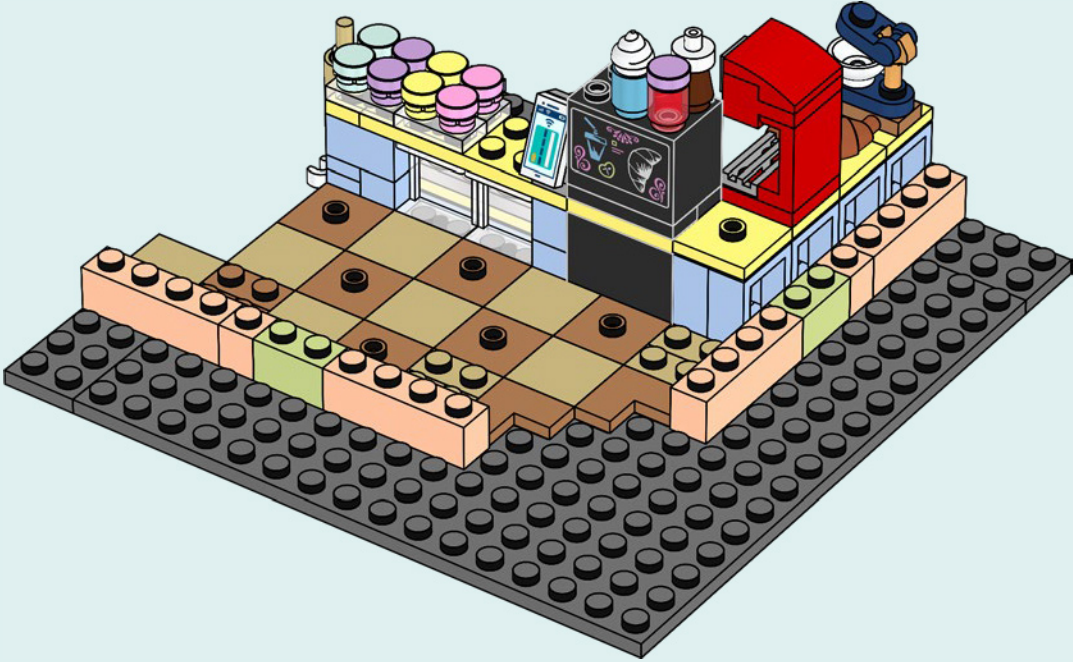



43

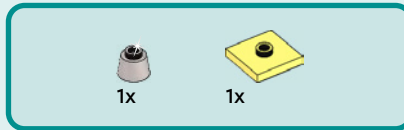

44

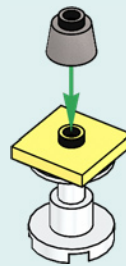



# 45

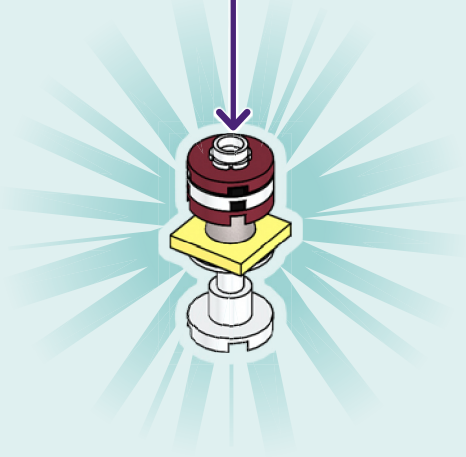
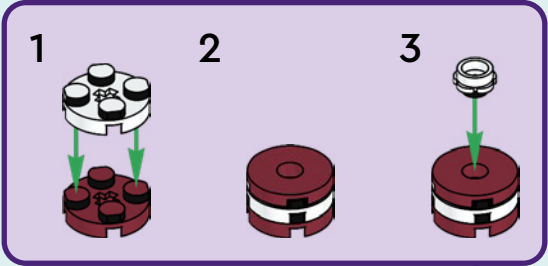

46

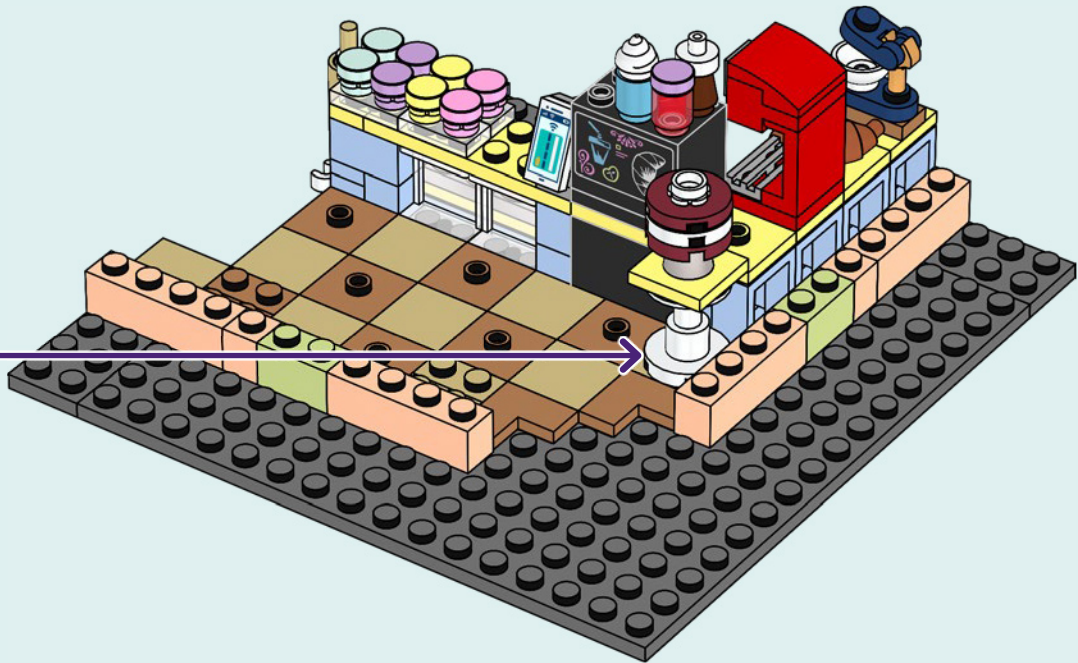

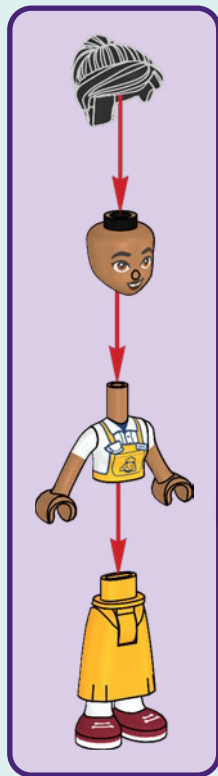

**BEATRIZ**

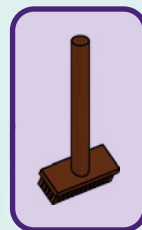



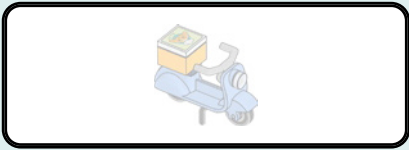

1

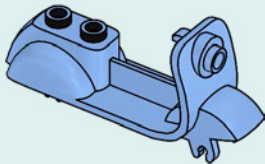

2

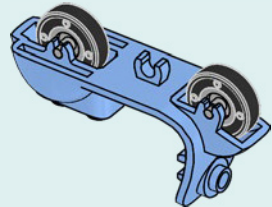



1x

3

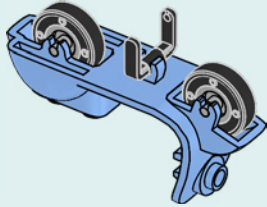

1x



1x

4

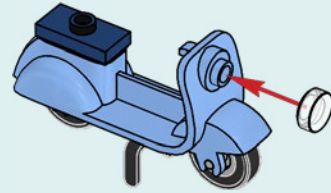
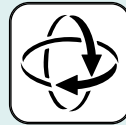



5

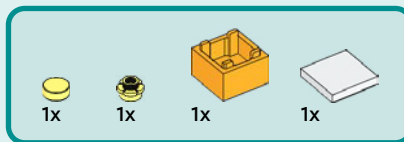
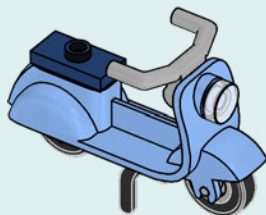

6

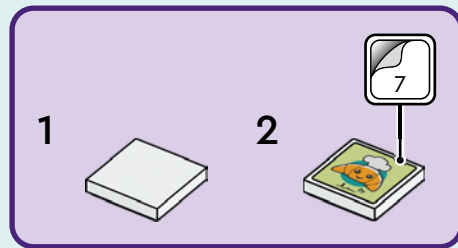

1

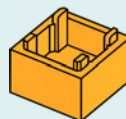

2

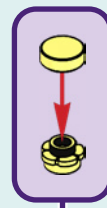

3



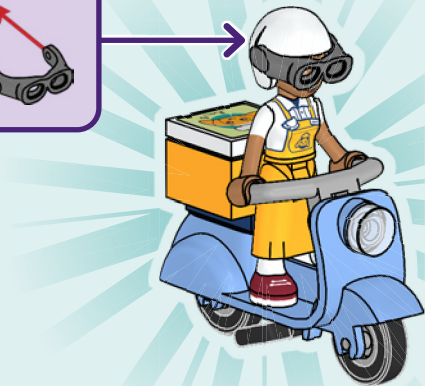
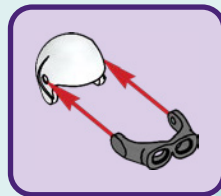
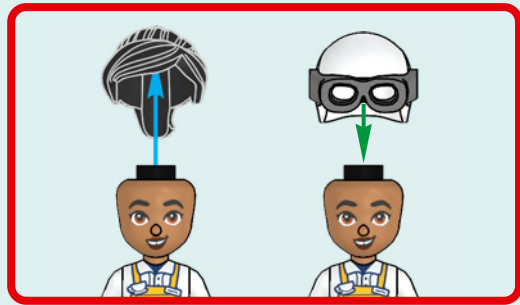
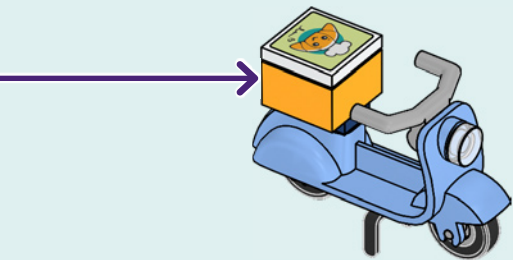

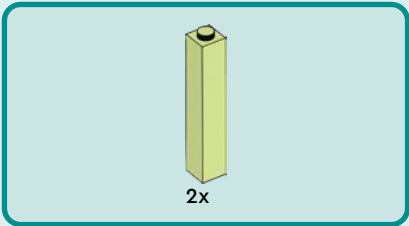

47



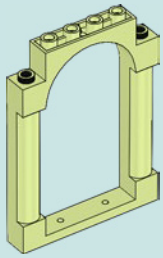

2x

48





2x

49





4x



4x

50



4x





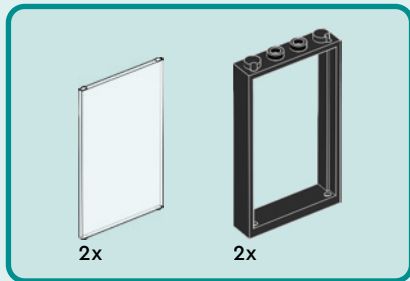

51

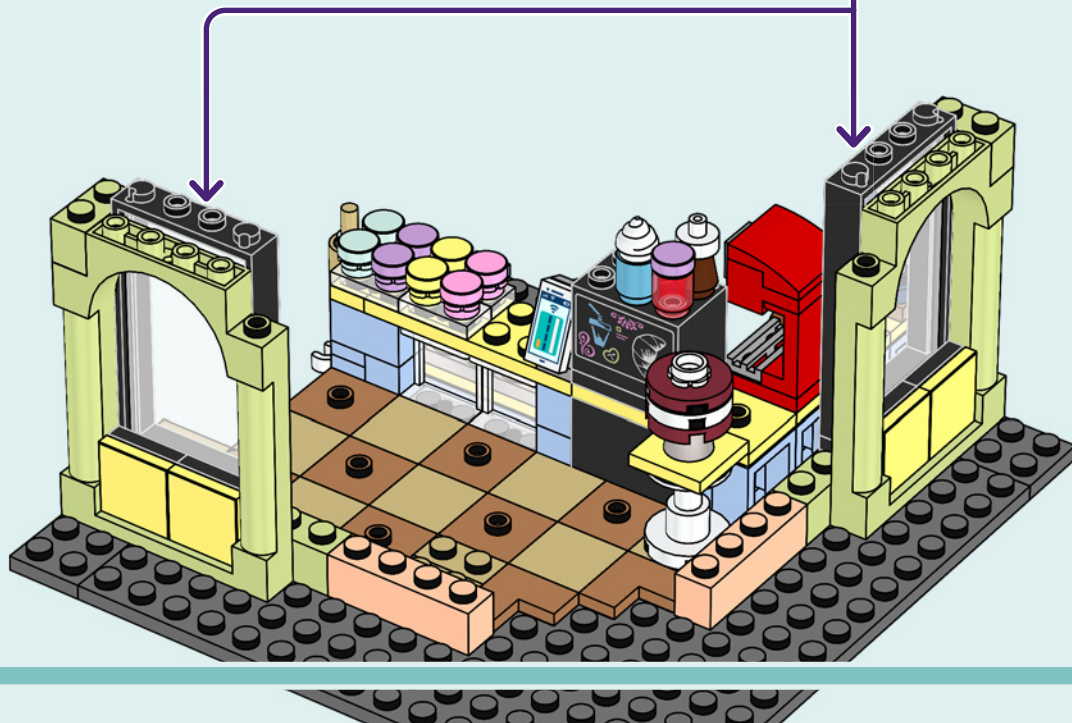
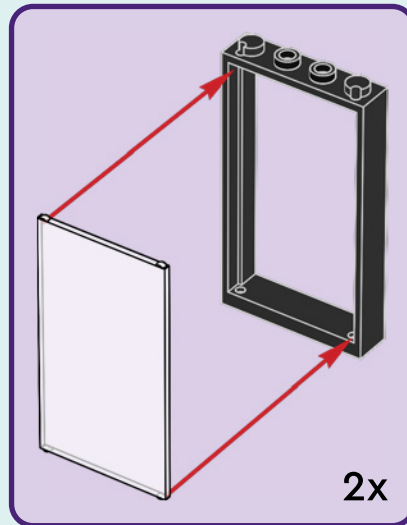

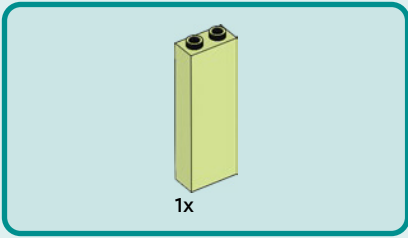

52

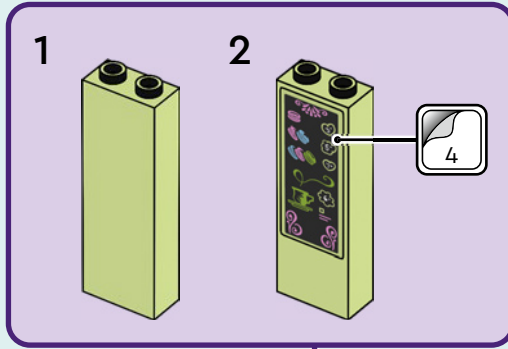

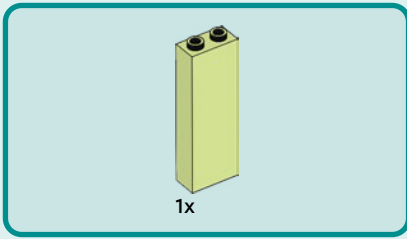

53



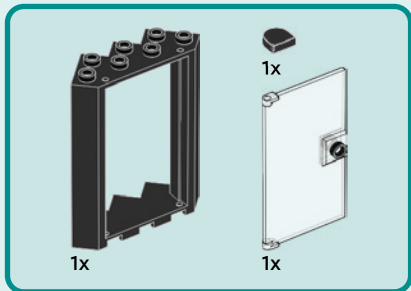

54

1

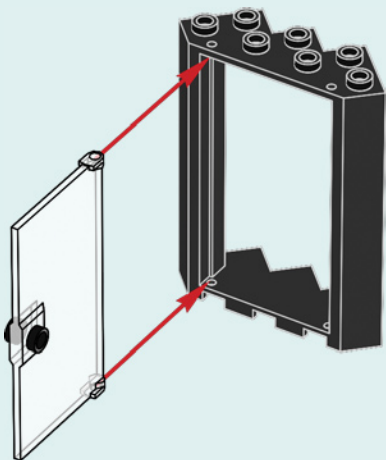

2





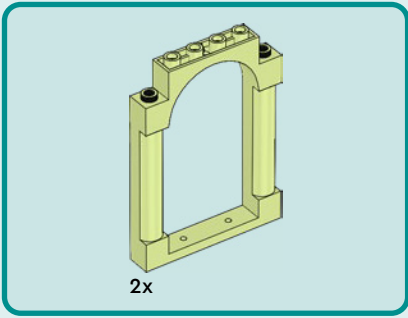

55





4x

56

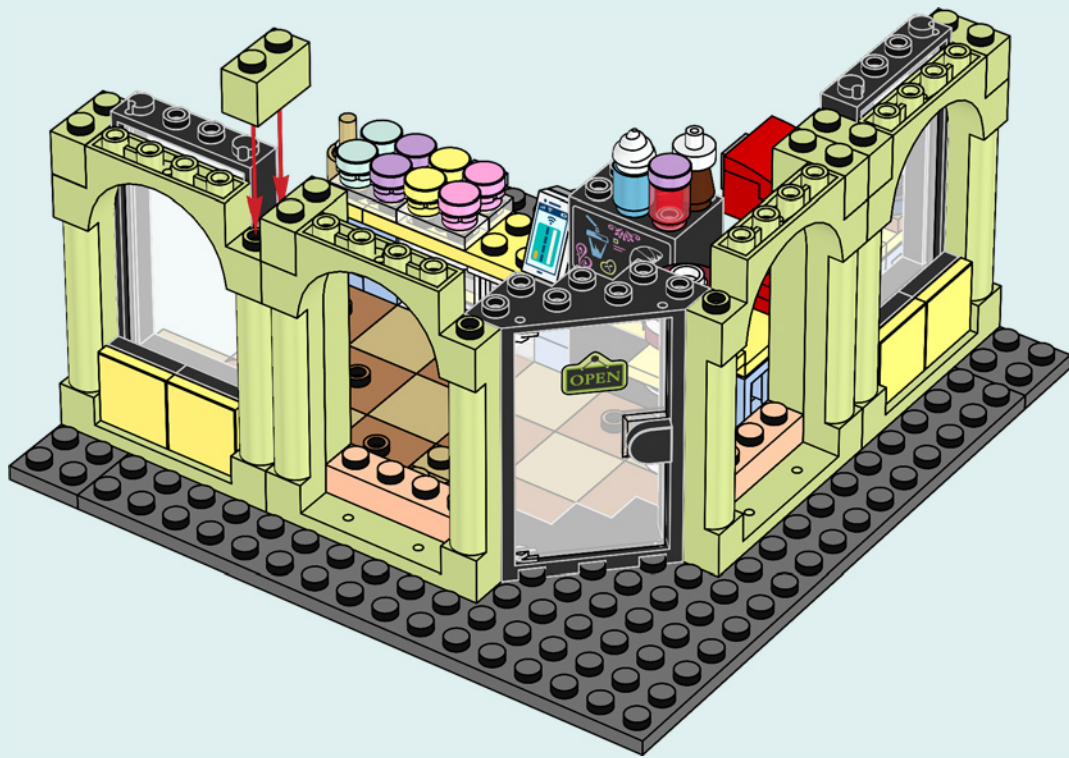



4x



4x

57

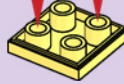
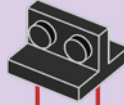

4x

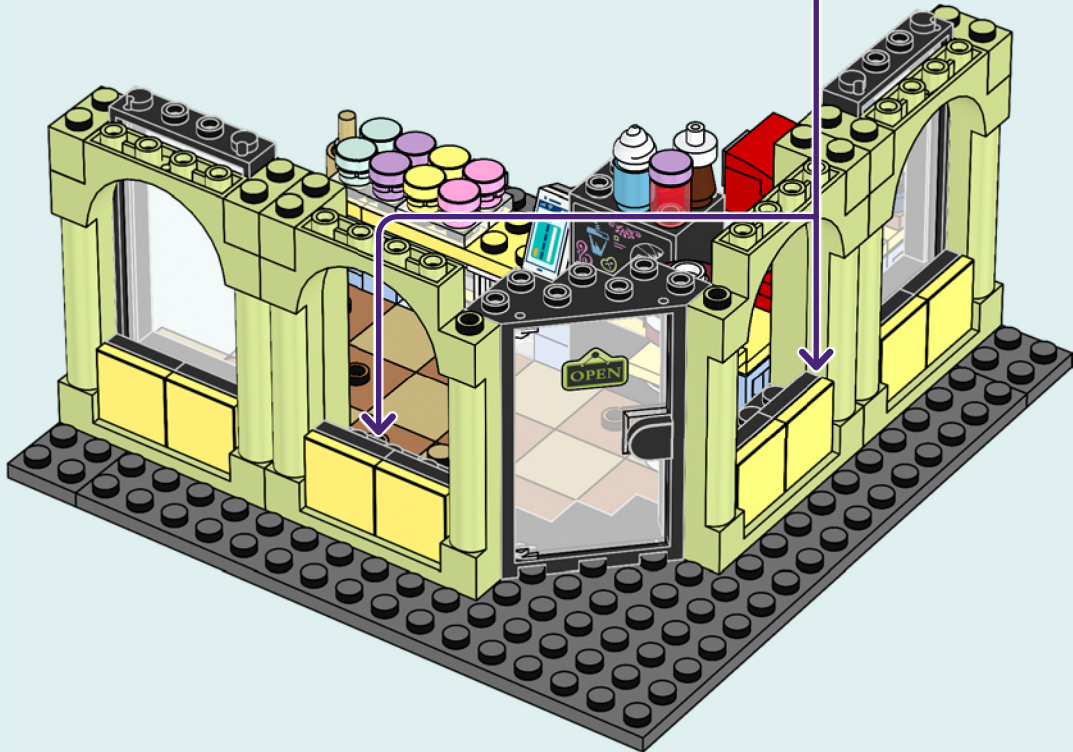



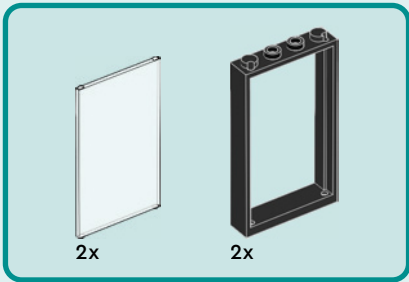

58

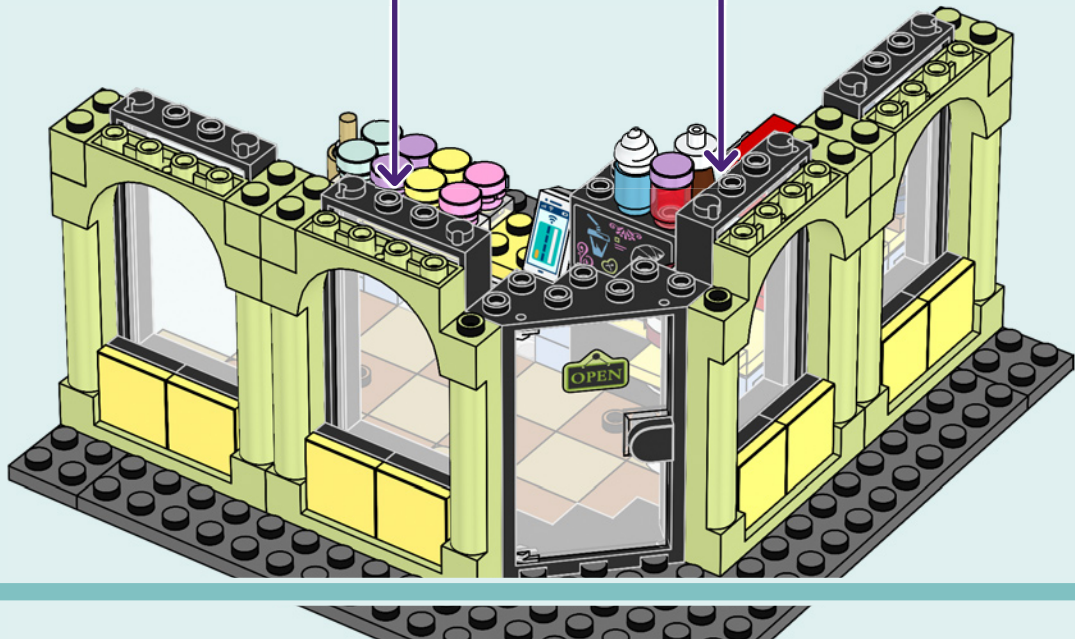
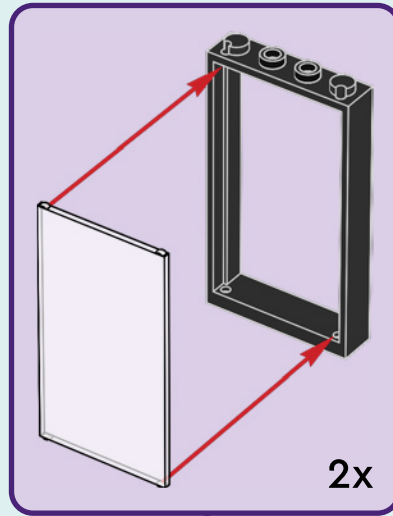



2x

59



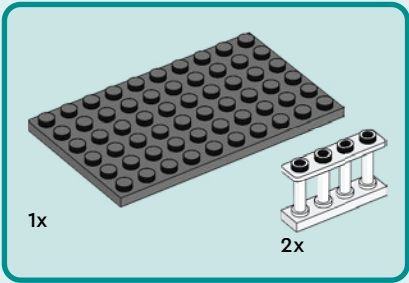

60

1

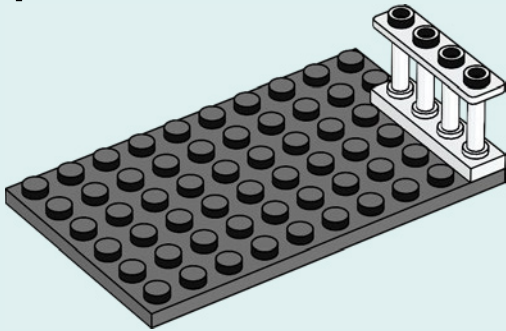

2

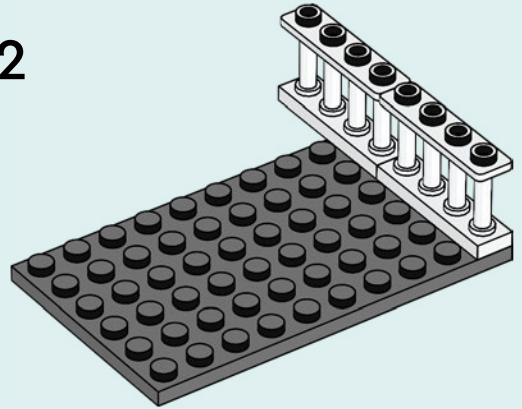



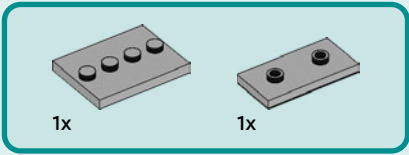

62



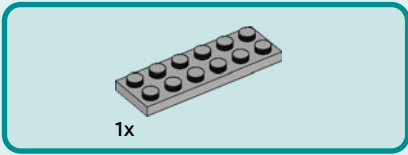

63

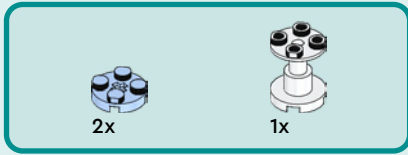
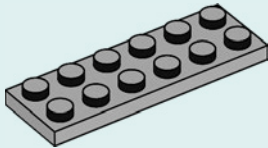

64

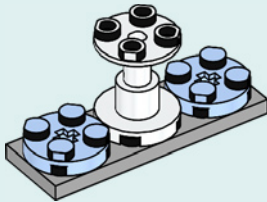

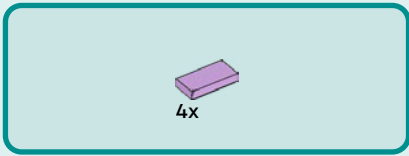

65

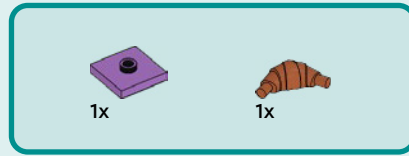
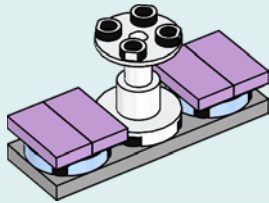

66

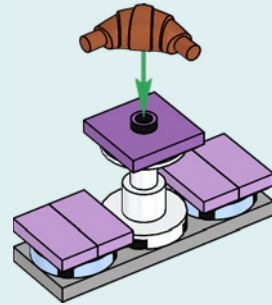

67





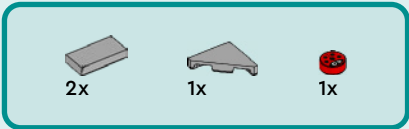

68



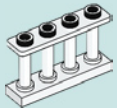

1x

69



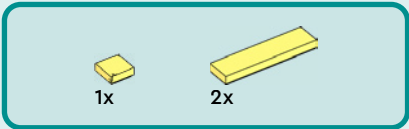

70





2x

71



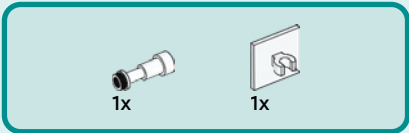

72

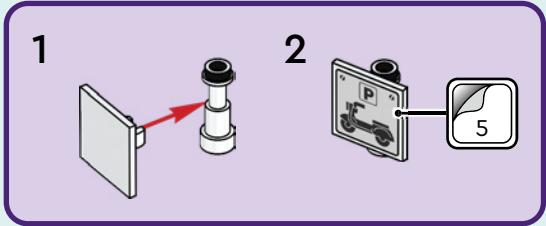

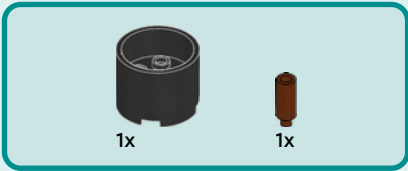

73

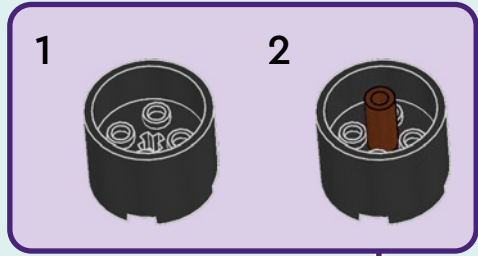



4x



1x

# 74



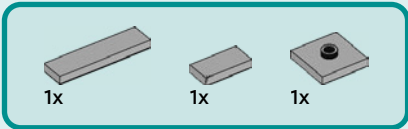

75







1x



2x



2x

# 76





1x



1x

77



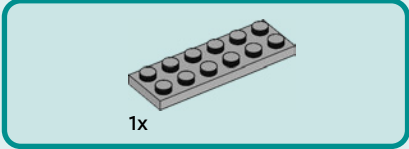
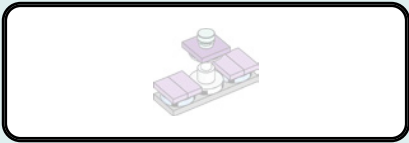

78

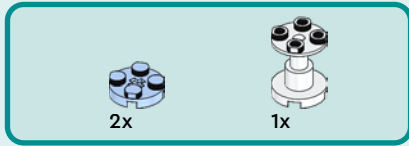
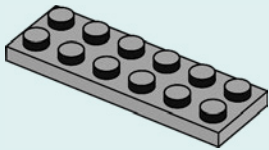

79

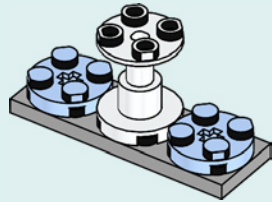

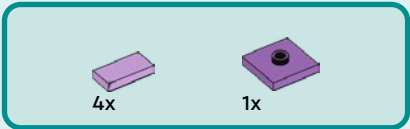

80

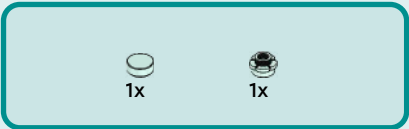
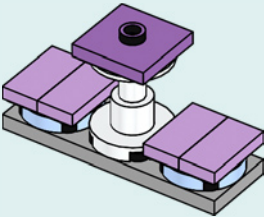

81

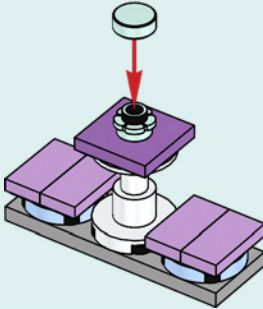

82



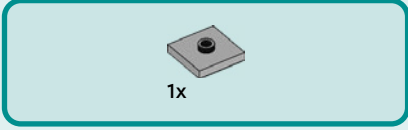

83

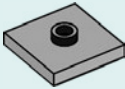

84

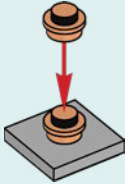



1x

85

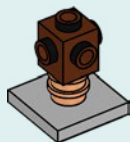

4x

86

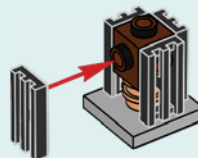



87

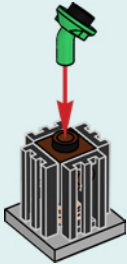

88

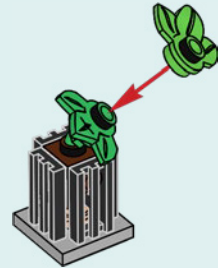



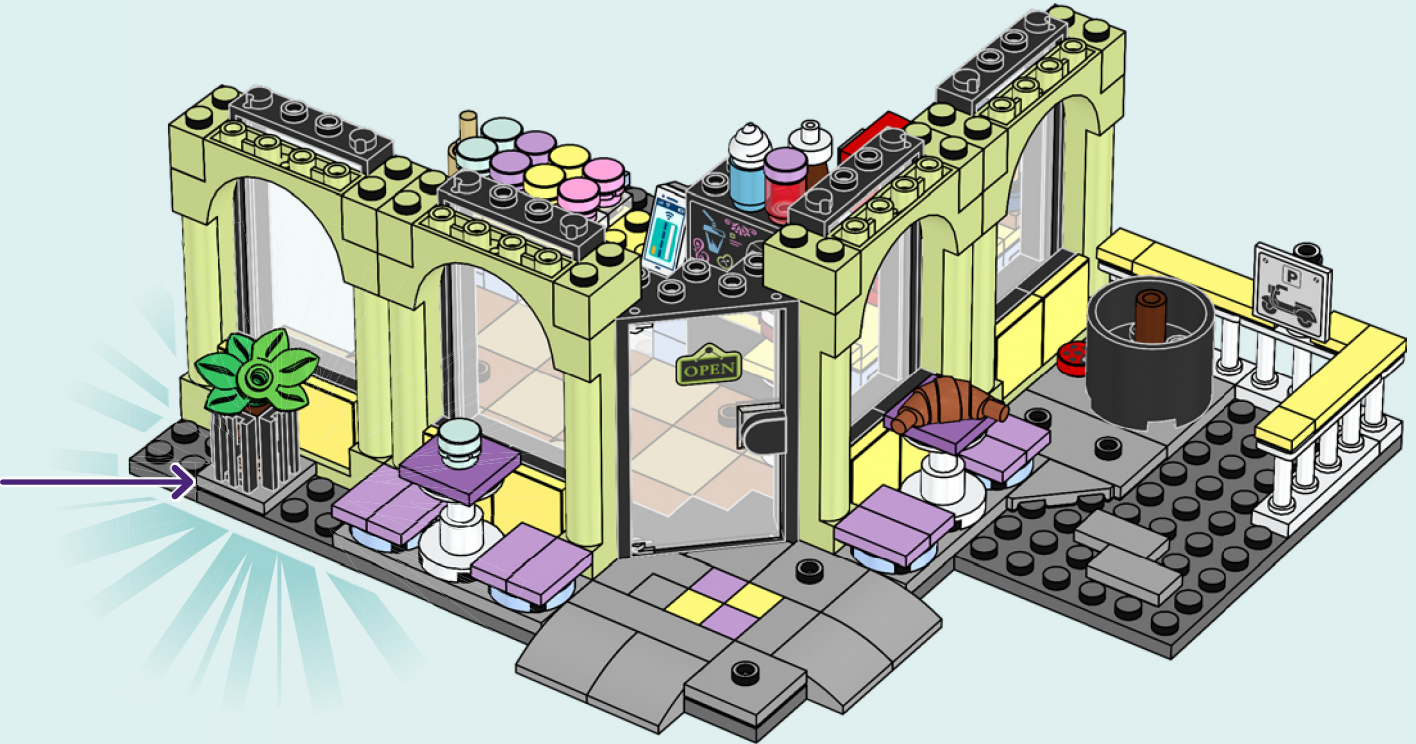

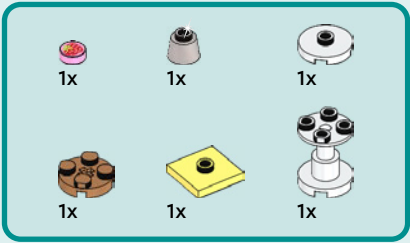

90

1



2

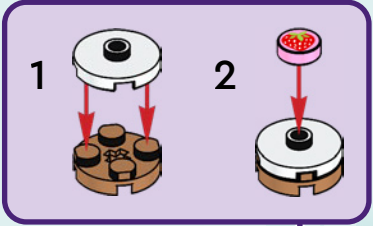
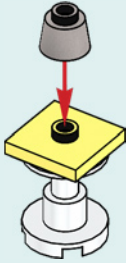

3

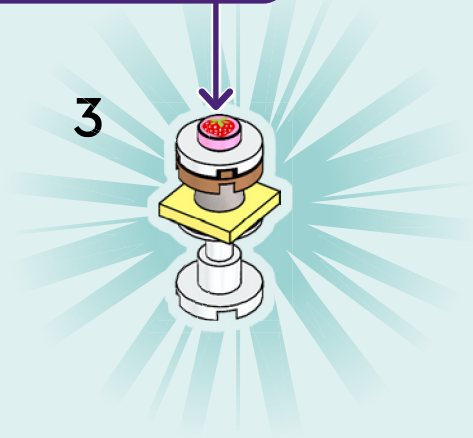

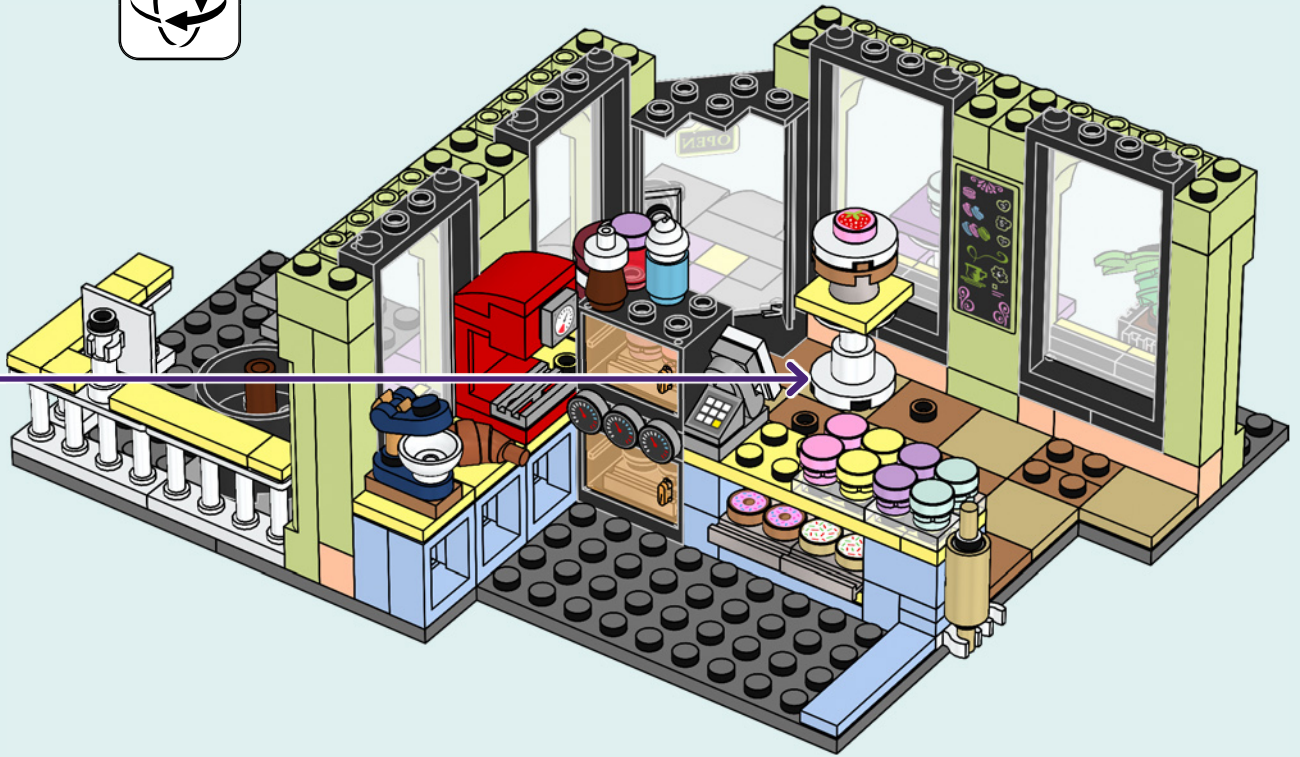





2x

91



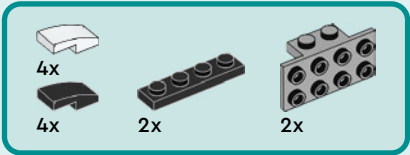
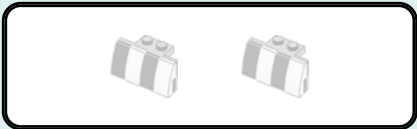

92

1

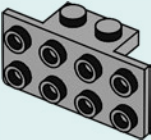

2

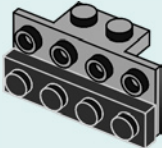

3

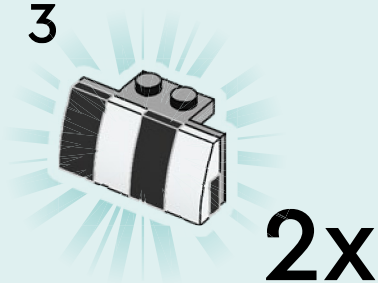

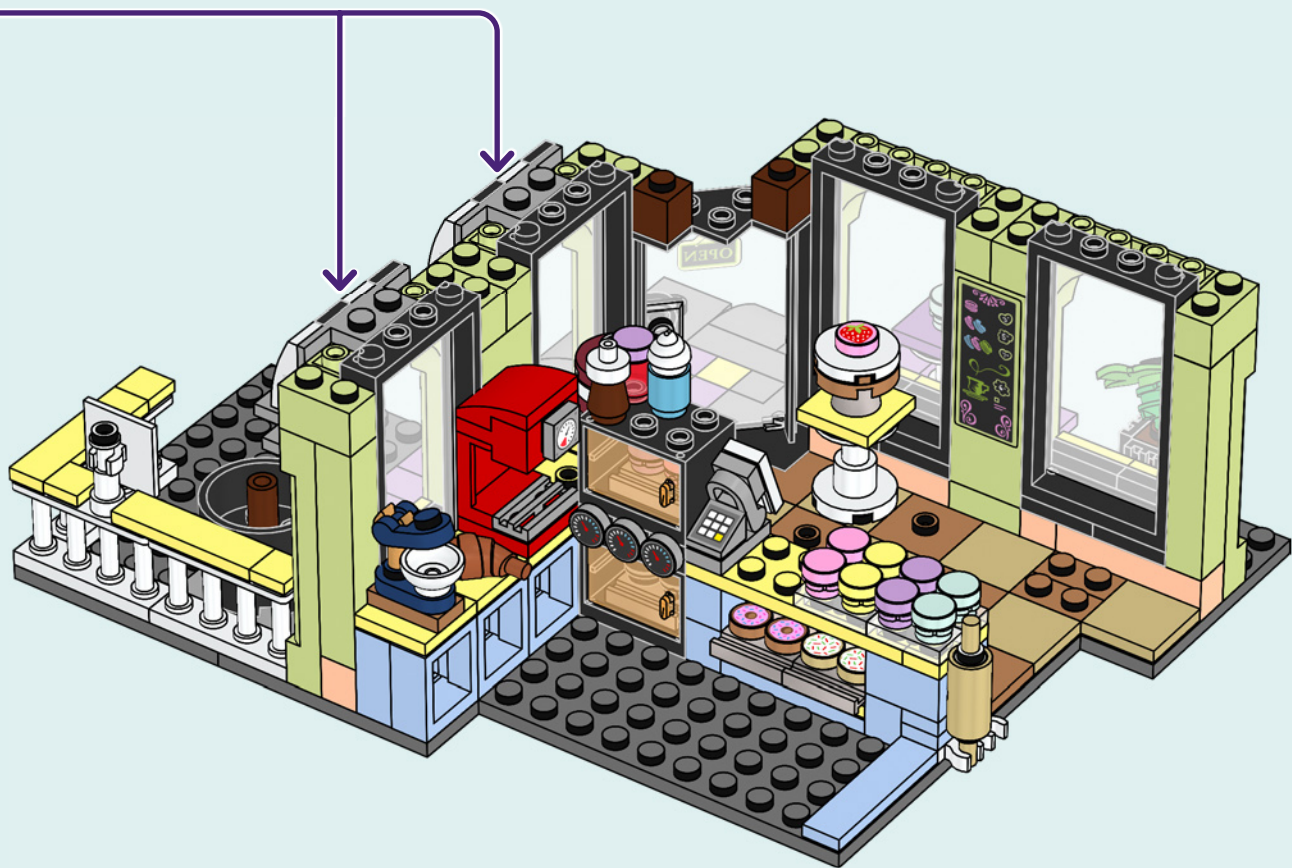

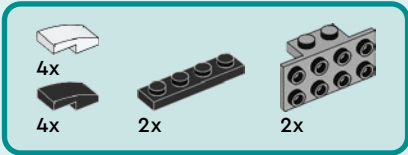
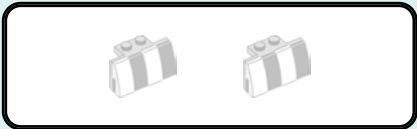

# 93

1

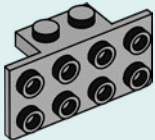

2

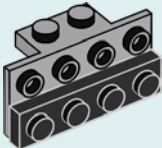

3

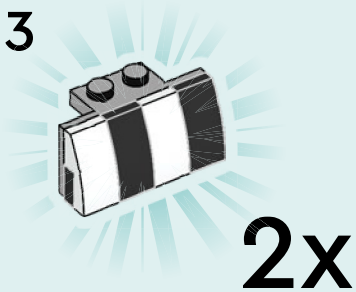



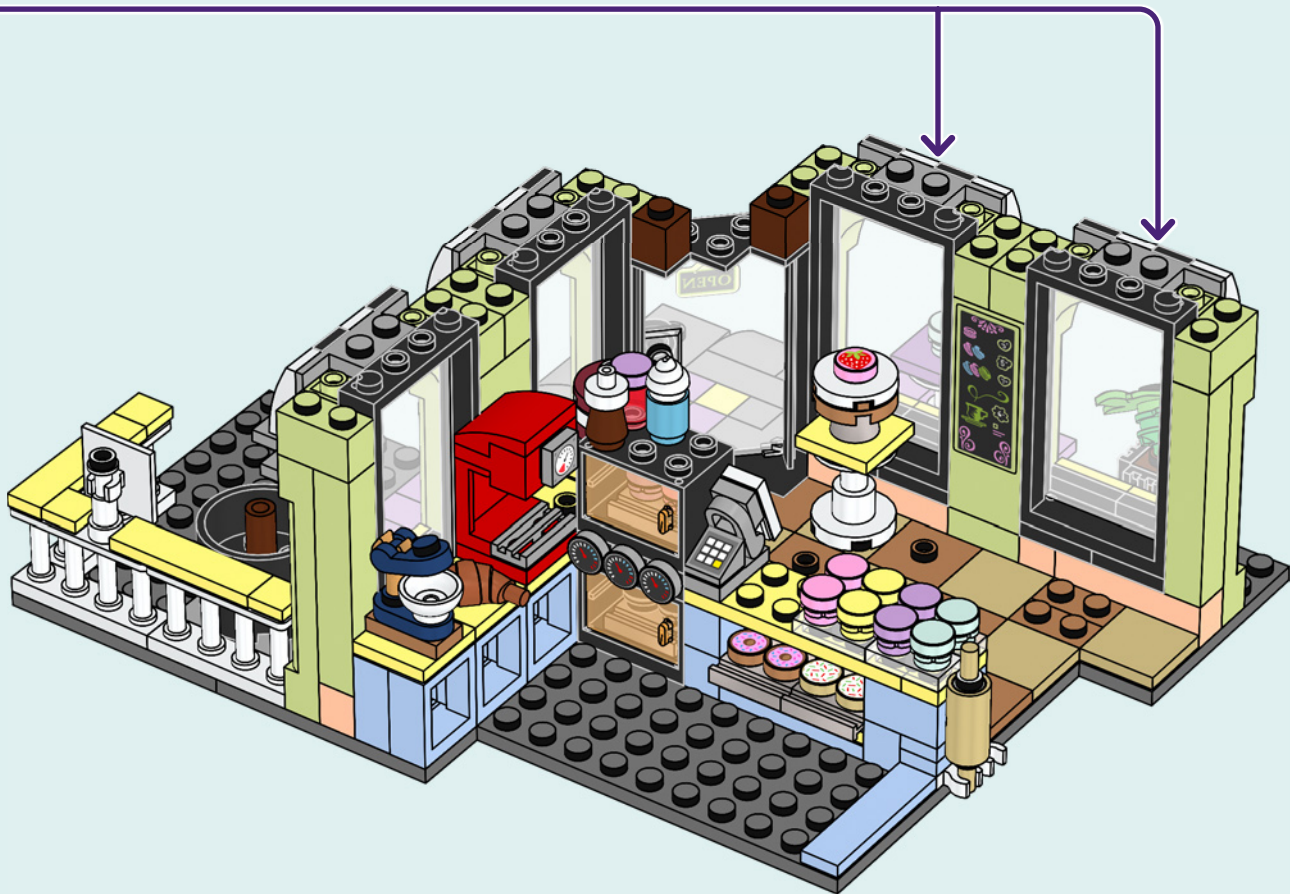



8x

94





2x



4x

95



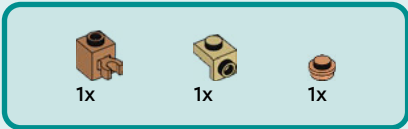

96

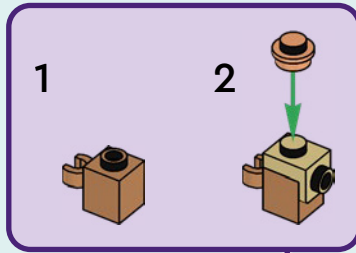



2x



2x

97





4x



2x

98





2x

99





2x

100





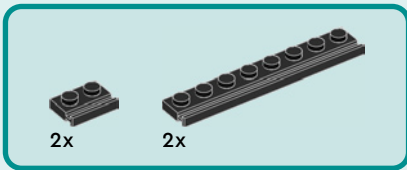

101





1x

102





1x

# 103





1x

104



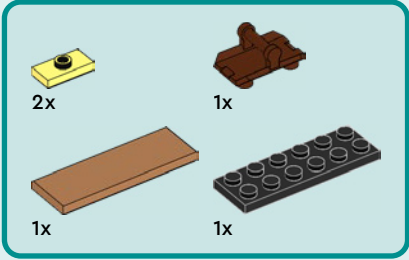

105

1



2

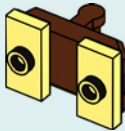

3

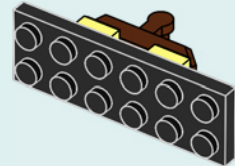

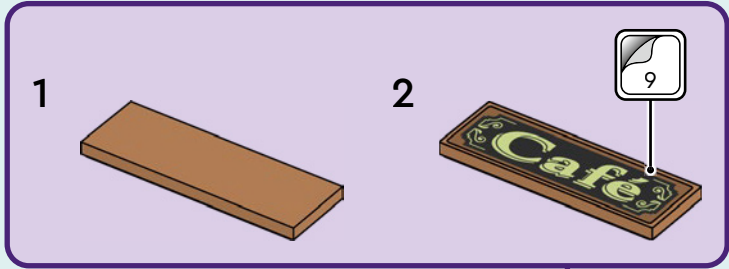





# 106

1



2



3







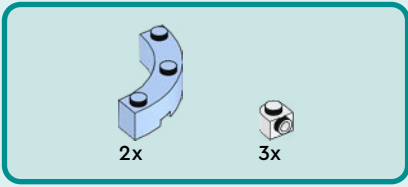

107

1

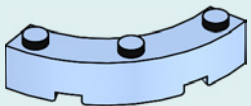

2

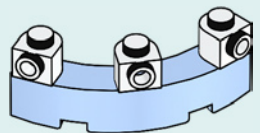

3

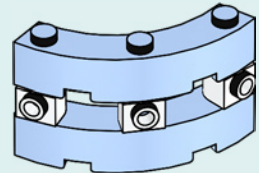

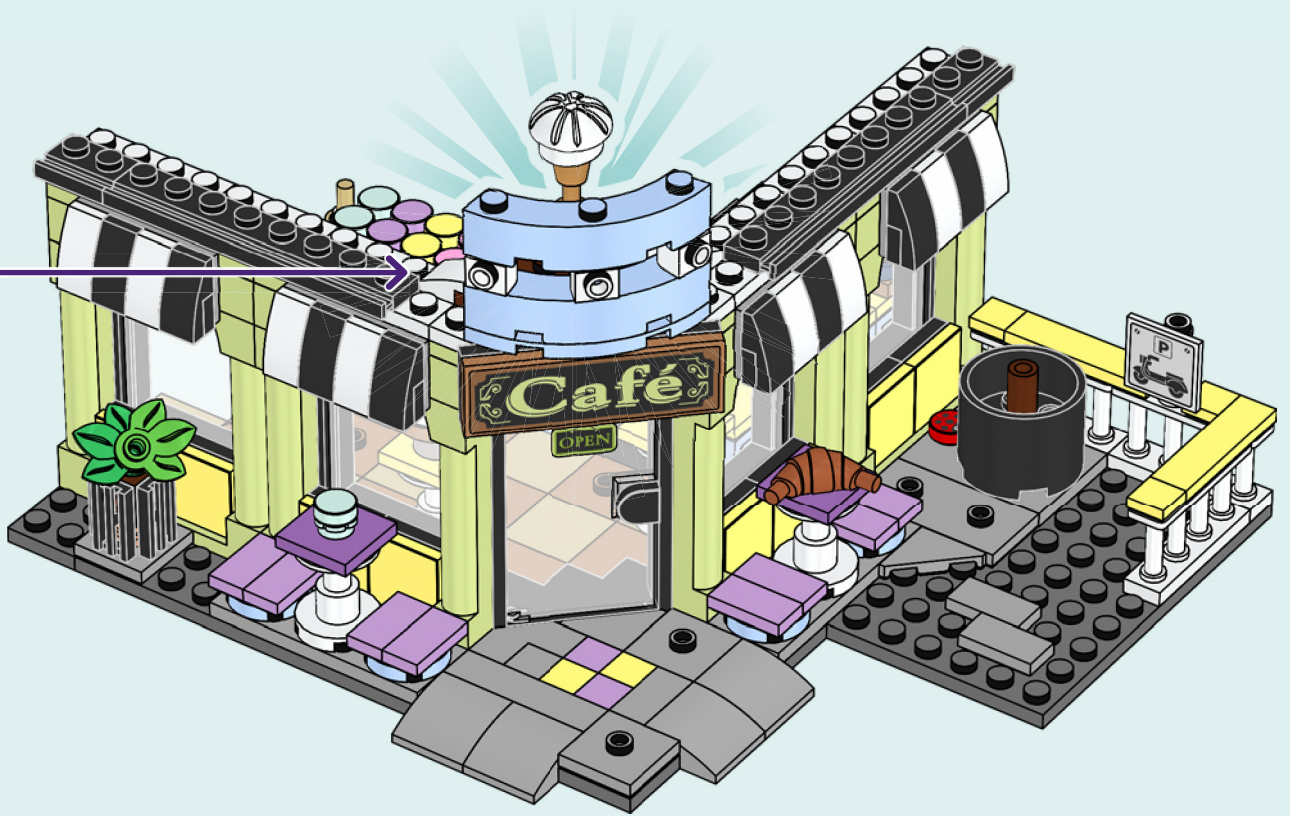

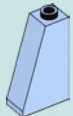

2x

108

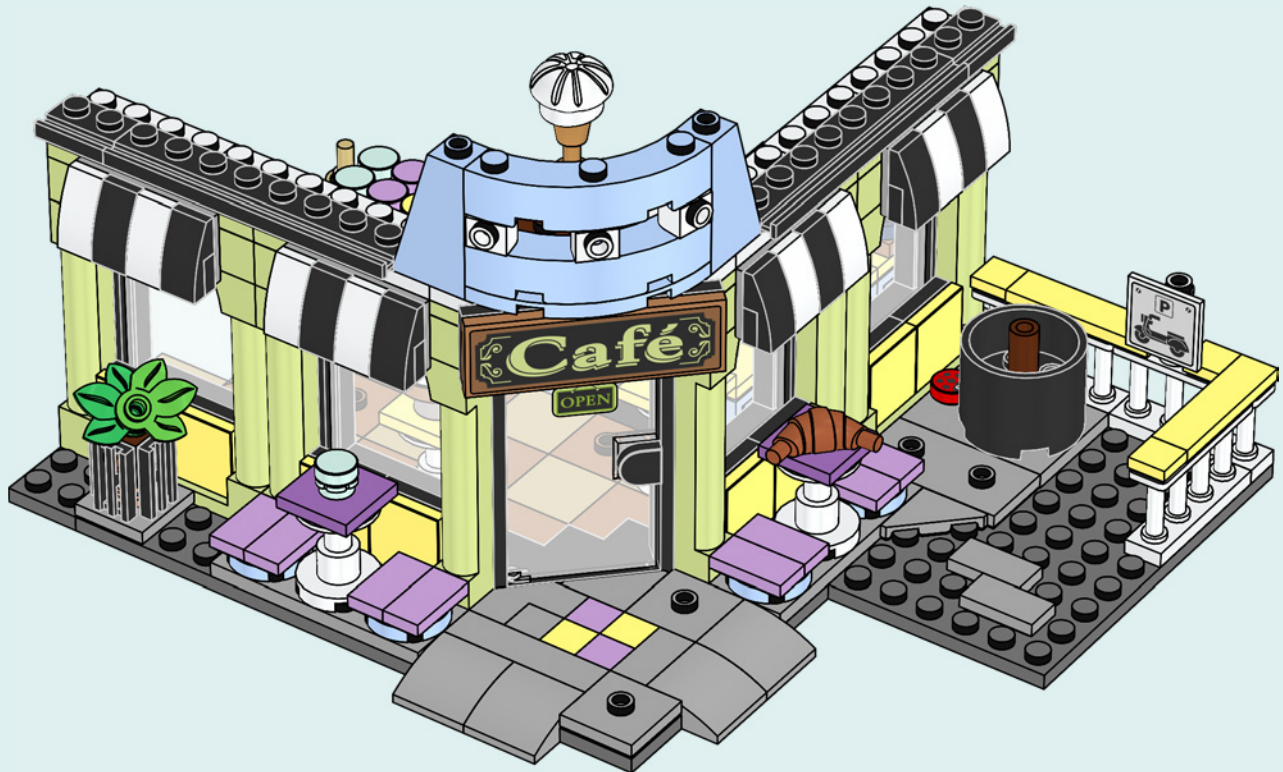



2x



1x

# 109



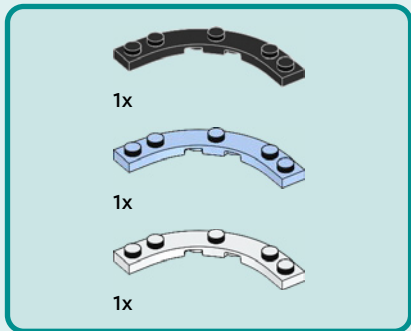

110

1



2

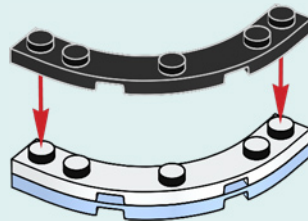

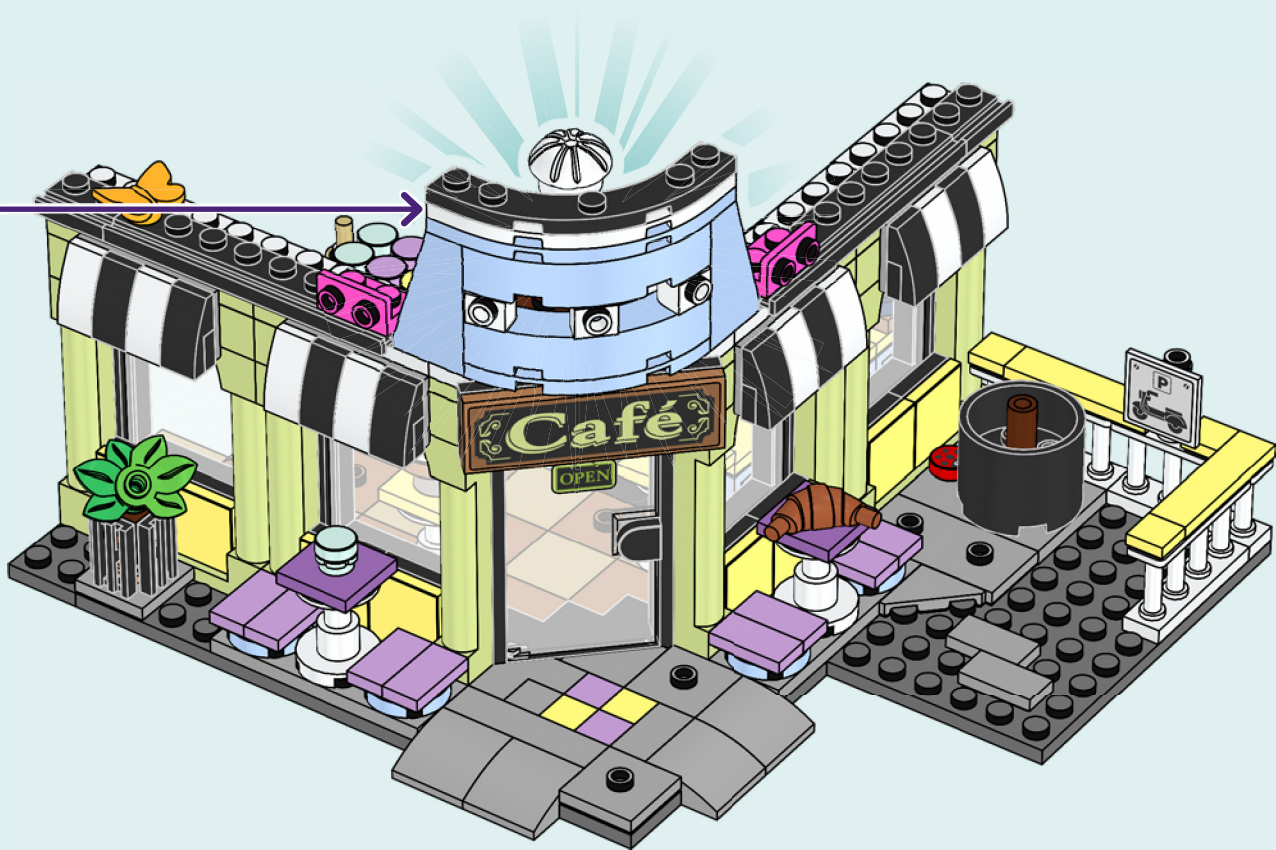

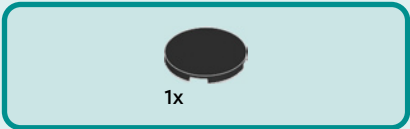

111







4x

112





3x



3x



3x

113





2x



2x



2x

# 114

1



2

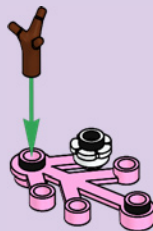

2x





1x



1x



1x

# 115

1



2





1x

116



JUNO



1x



3x

117

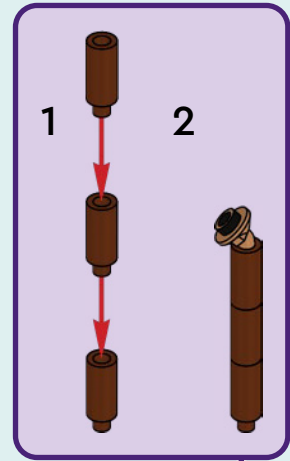

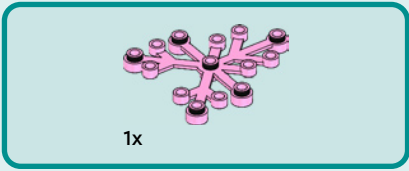

118

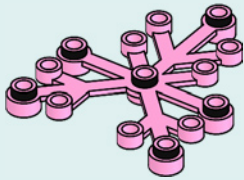

119

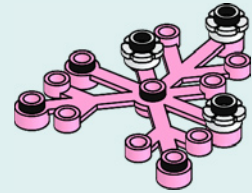



3x

120

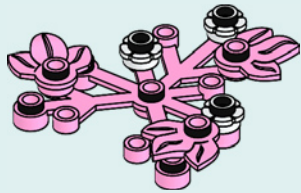

1x



1x

121

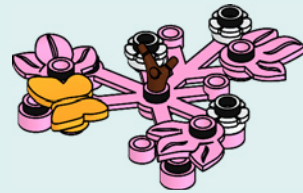



122



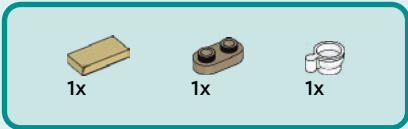

123

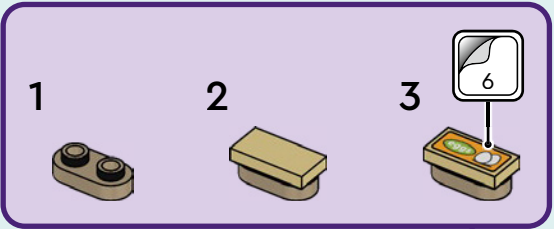

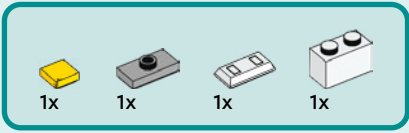

124

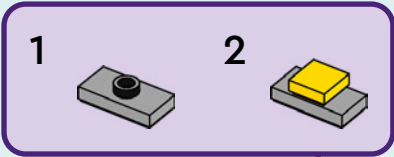
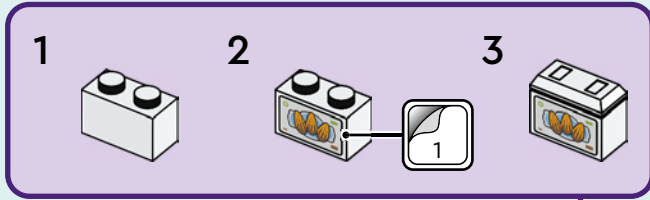



125



126

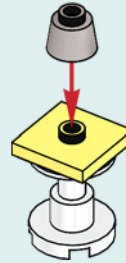

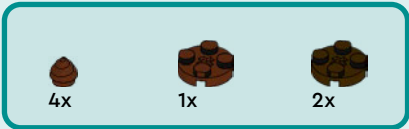

127

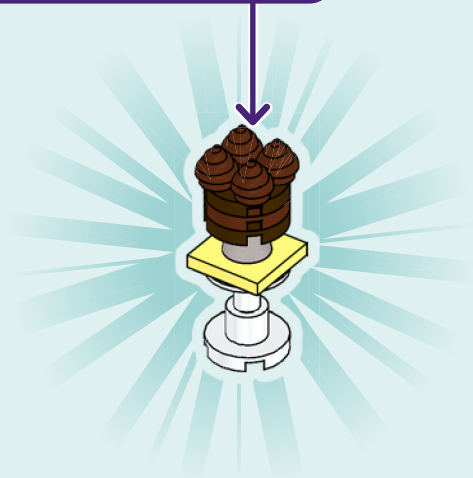







# Friends



## WATCH SERIES ONLINE



WATCH SERIES ONLINE  
SCHAU DIR DIE SERIE ONLINE AN  
REGARDE LA SÉRIE EN LIGNE  
GUARDA LA SERIE ONLINE  
MIRA LA SERIE EN INTERNET  
ASSISTIR À SÉRIE ONLINE  
在线观看  
OGLĄDAJ SERIAL W INTERNECIE

SLEDUJ SERIÁL ONLINE  
POZRI SI SERIÁL ONLINE  
NÉZD A SOROZATOT ONLINE  
VIZIONEAZĂ SERIALUL ONLINE  
ГЛЕДАЙТЕ СЕРИАЛА ОНЛАЙН  
SKATIES SERIĀLU TIEŠSAISTĒ  
VAATA SARJA VEEBIST  
ŽIŪRĒK SERIALĄ INTERNETU





**LEGO**

**Friends**



**42624**



**42630**



**42618**



**42622**

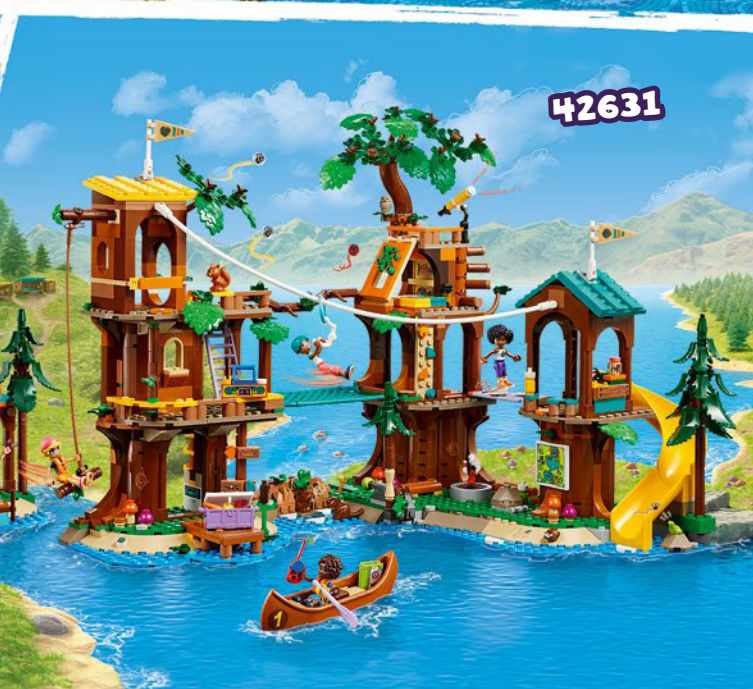

**42631**

1x 6186681	1x 300401	4x 4113917	1x 6245281		2x 6253231	1x 6448317	1x 4211157
12x 6206149	1x 6210076	1x 4114026	2x 6285598	4x 6337273	1x 6409769	1x 6409769	1x 4211159
1x 6438901	10x 6034044	7x 4185177	1x 6365482	1x 6177156	4x 6256058	1x 6315199	1x 6157942
3x 6446788	1x 6416469	1x 6116614	1x 6047276	1x 6247362	1x 6247362	2x 6478830	2x 4211150
2x 6388018	1x 6070327	3x 6391270	8x 6047276	1x 6238673	1x 6466782	1x 6466782	2x 4211150
2x 6235083	1x 6070327	1x 6324417	4x 241226	1x 6274739	2x 6370534	1x 6328480	1x 6328480
1x 6474222	2x 6117940	1x 4570470	8x 6250020	1x 379526	1x 6466782	1x 4283660	1x 4283660
1x 6252744	1x 306801	1x 6385920	2x 4107761	1x 6372045	1x 6238673	3x 6329581	3x 6329581
1x 6323185	2x 302101	1x 302221	1x 6376695	2x 4286009	1x 6489994	1x 6439231	1x 6439231
2x 6330191	3x 6047813	1x 6105976	1x 6375973	1x 6229130	1x 6329699	4x 6422088	1x 4211415
1x 6452529	4x 302001	1x 307024	1x 362326	1x 6182261	1x 6264062	3x 6345847	1x 4211399
1x 6478249	1x 6399559	2x 614126	1x 6229130	2x 6424035	1x 6416452	1x 4529242	1x 6329584
1x 403201	2x 6361753	2x 6284070	1x 6229130	1x 6182261	1x 6231386	1x 4529242	1x 6225246
5x 6284507	1x 6374192	3x 6424674	1x 6138479	2x 6424035	1x 6236571	4x 6438899	1x 6066097
1x 6093053	1x 6365624	1x 6256435	2x 371026	1x 6274738	1x 6251253	2x 4211242	1x 6326078
		1x 6388352	4x 371026	4x 6240204	1x 6092588	1x 6133765	3x 4211414

1x 4211350  
 2x 6217876  
 3x 6126082  
 4x 6102357  
 1x 6177078  
 1x 4644102  
 4x 6118827  
 1x 4211356  
 1x 6472550  
 1x 6079461  
 2x 4211452  
 1x 6471952  
 1x 6395635  
 1x 6170695

2x 4211002  
 1x 4211114  
 1x 6004927  
 4x 6383134  
 5x 6100322  
 8x 6441765  
 2x 6136397  
 2x 6362254  
 2x 6343585

1x 6361988  
 1x 6468267  
 1x 6383102  
 1x 6383092  
 2x 4623298  
 3x 6317181  
 4x 6132264

8x 6424046  
 10x 6104578  
 2x 6478829  
 2x 6472295  
 4x 6476787

2x 6099449  
 3x 6212501  
 3x 6284587  
 1x 6287844  
 10x 6443651  
 2x 6329957  
 1x 6195274  
 3x 6343806  
 3x 6426463  
 5x 6275877  
 2x 6058014  
 4x 6195266  
 8x 6298527  
 7x 6375350  
 1x 6296492

2x 6289722  
 1x 6175294  
 1x 6416490  
 2x 6369191  
 1x 6484986  
 4x 6378419  
 1x 4505990  
 1x 6453281  
 1x 6416639  
 2x 6349274  
 1x 6472227  
 1x 6484987  
 1x 6381921

1x 6287856  
 2x 6329593  
 1x 6510192  
 1x 6478245  
 2x 6215606  
 1x 6360035  
 1x 6167643  
 7x 6218360  
 6x 6102994

1x 6430979  
 1x 4620909  
 3x 6322818  
 3x 6251854  
 2x 6177195  
 4x 6322820  
 3x 6214235  
 2x 6211403  
 8x 6345796

 [LEGO.com/service](https://www.LEGO.com/service)

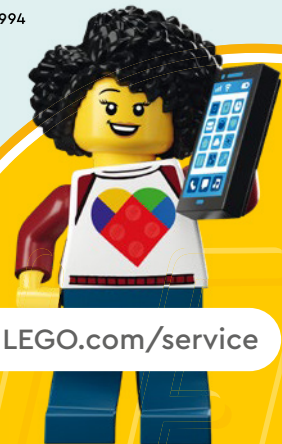

YOU COULD **WIN**

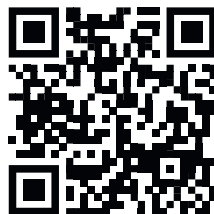

Scan this QR code or go to **LEGO.COM/PRODUCTFEEDBACK** and give us your short feedback about this LEGO® set for a chance to win a cool LEGO prize.

Terms and Conditions apply\*

**EN: YOU COULD WIN.** Terms and Conditions apply\* **DE: Du könntest GEWINNEN.** Es gelten die Teilnahmebedingungen\* **FR: Tu pourrais GAGNER.** Des conditions s'appliquent\* **IT: Potresti VINCERE tu.** Termini e condizioni sono applicabili\* **ES: Puedes GANAR.** Aplican términos y condiciones\* **PT: Poderá GANHAR.** Aplicam-se termos e condições\* **ZH: 轻松获奖. 条款和条件适用\*** **PL: Szansa na WYGRANĄ.** Obowiązują warunki korzystania\* **CS: Máte šanci VYHRÁT.** Platí všeobecné smluvní podmínky\* **SK: Máte šancu VYHRAŤ.** Platia všeobecné zmluvné podmienky\* **HU: TE IS NYERHETSZ.** Felhasználási feltételek érvényesek\* **RO: Ai putea CÂȘTIGA.** Se aplică termeni și condiții\* **BG: Можете да СПЕЧЕЛИТЕ.** Има определени правила и условия\* **LV: Tu vari LAIMĒT.** Ir spēkā noteikumi un nosacījumi.\* **ET: Sul on võimalus VÕITA.** Kehtivad tingimused\* **LT: Jūs galite LAIMĖTI.** Taikomos sąlygos\*

\*[LEGO.com/productfeedback-terms](https://www.lego.com/productfeedback-terms)

LEGO, the LEGO logo and the Friends LOGO are trademarks of the LEGO Group. ©2024 The LEGO Group.

6521564