



40644





## **Get excited about our new packaging!**

We're switching from plastic to paper-based packaging. That's why you might find a mix of paper and plastic in our boxes!

## **Nos nouveaux emballages vous emballeront !**

Nous passons des emballages en plastique aux emballages à base de papier. C'est pourquoi vous pourriez trouver un mélange de papier et de plastique dans nos boîtes !

## **¡Te presentamos nuestros nuevos empaques!**

Estamos sustituyendo las bolsas de plástico por bolsas con base de papel. ¡Por eso, puedes encontrar una mezcla de papel y de plástico en nuestras cajas!

**[LEGO.com/sustainable-packaging](https://LEGO.com/sustainable-packaging)**



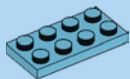

1x



1x

1

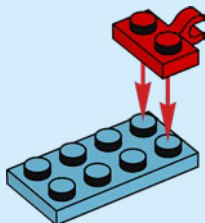



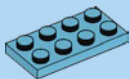

1x

2

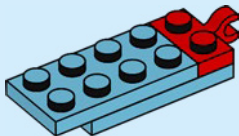

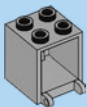

1x



1x

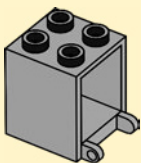

3

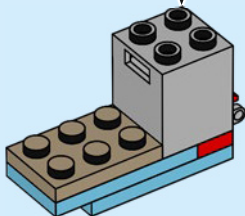



1x



1x



2x



2x

4

1

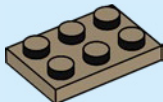

2

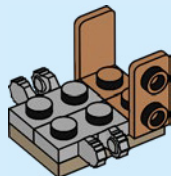

3

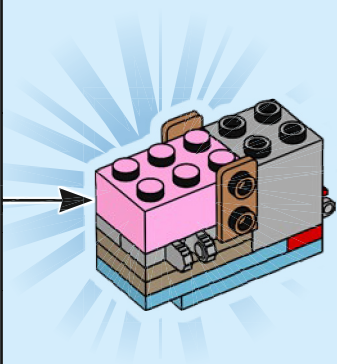
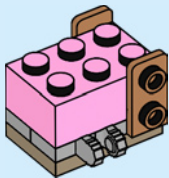



1x



2x

5

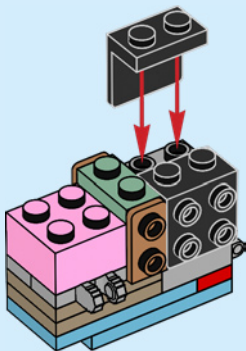



2x

6

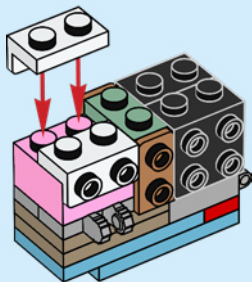

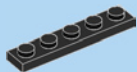

2x

7

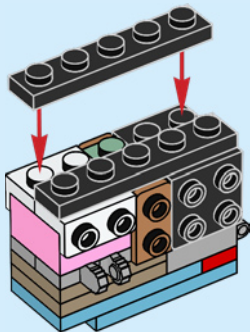



1x



1x

8

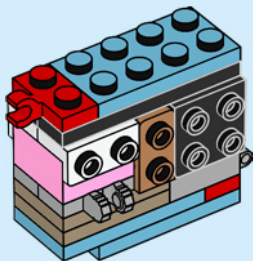





1x



1x

9

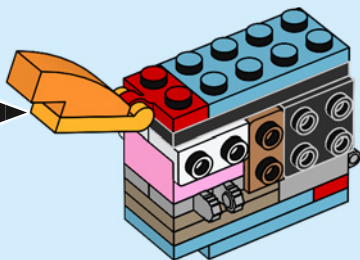
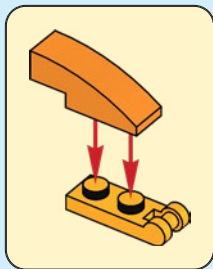



2x

10

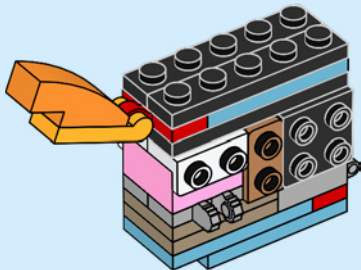



1x



2x

# 11

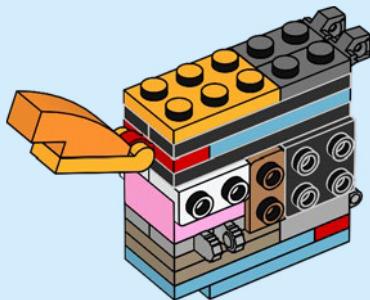



1x



2x

12

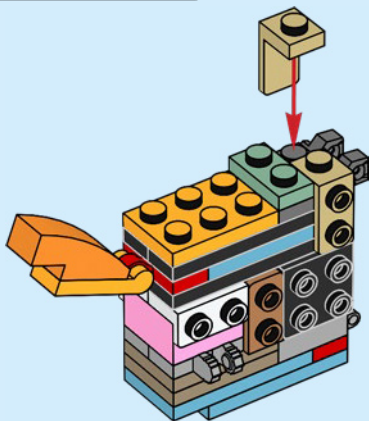

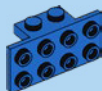

2x

13

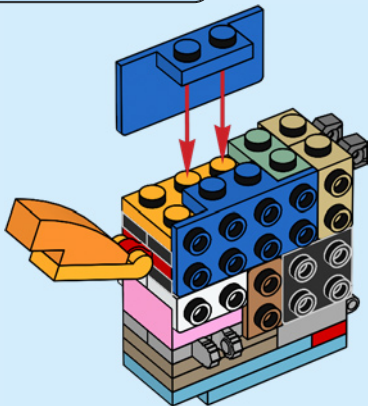

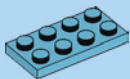

1x

14

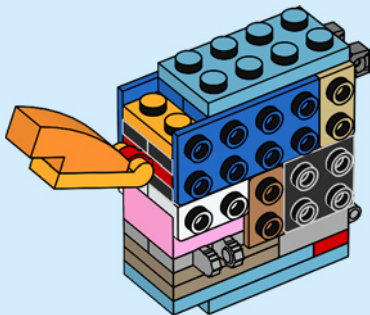



2x



1x

15

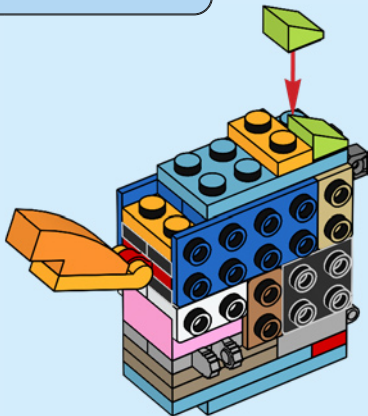



2x



2x

16

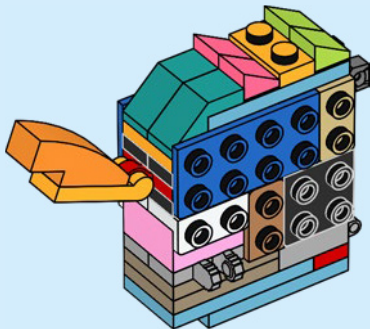





1x

17

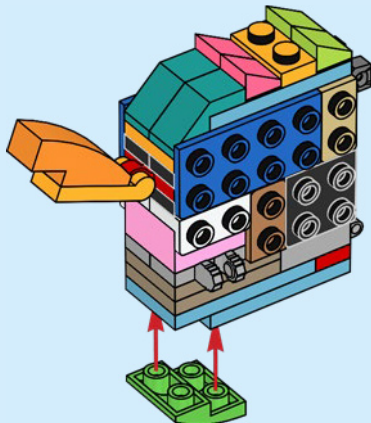



2x



1x



3x

# 18

1



2

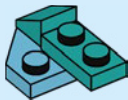

3

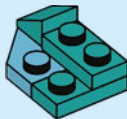

4

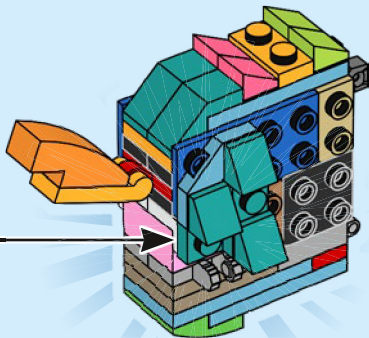
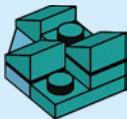

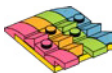

1x



1x

# 19

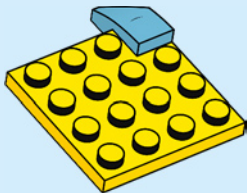



2x



1x

20

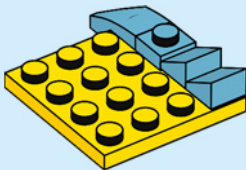



1x



1x



2x

# 21

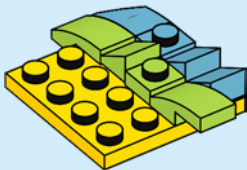



2x



1x



1x

# 22

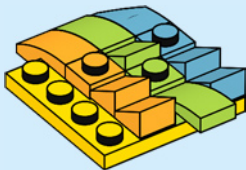



2x



1x



1x

# 23

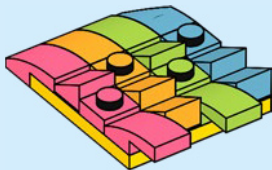



24

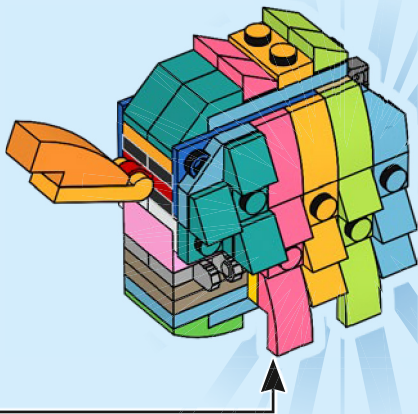



2x



1x



3x

# 25

1

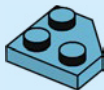

2

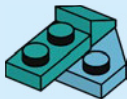

3

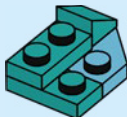

4

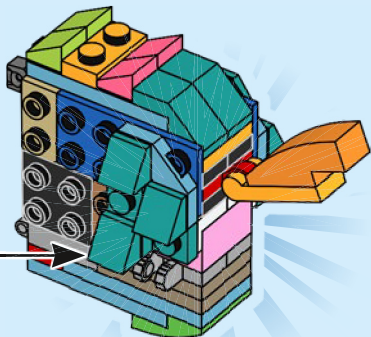
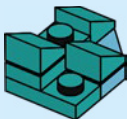

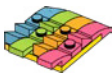

1x



1x

# 26

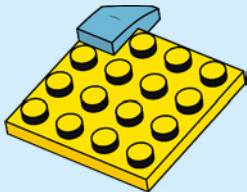



2x



1x

27

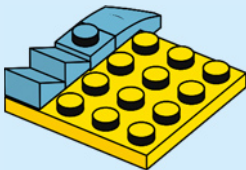



1x



1x



2x

# 28

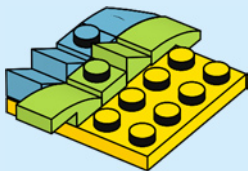



2x



1x



1x

# 29

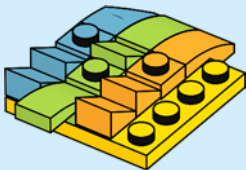



2x



1x



1x

# 30

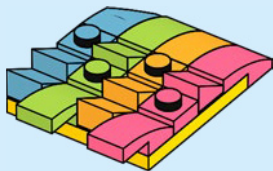



31

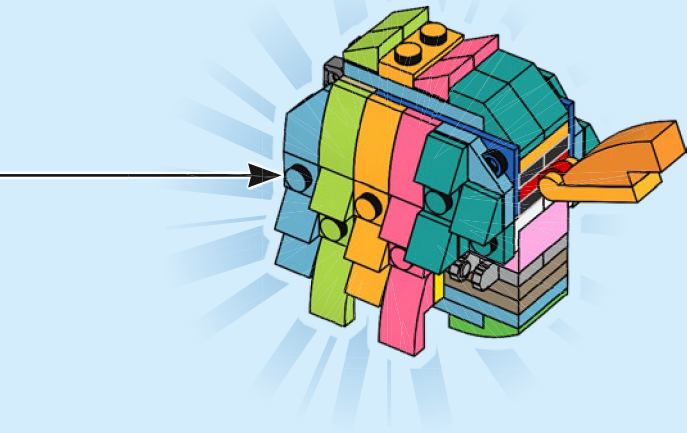

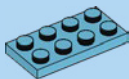
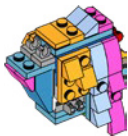

2x

# 32

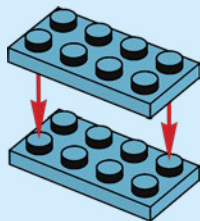



2x



2x

# 33

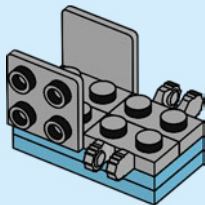



2x

34

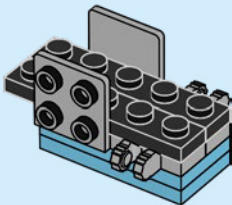

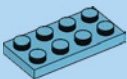

1x



1x

# 35

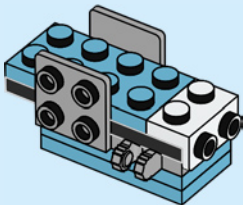





2x



1x

37

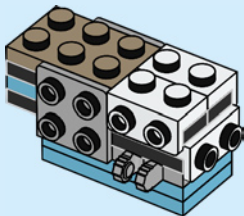



2x

38

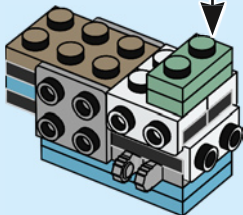
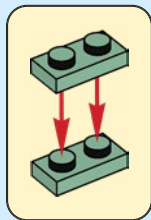





1x



1x



1x

# 39

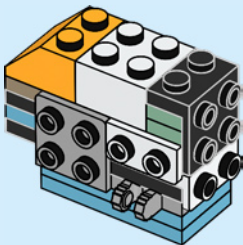

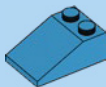

1x

40

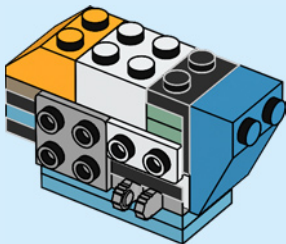



2x

41

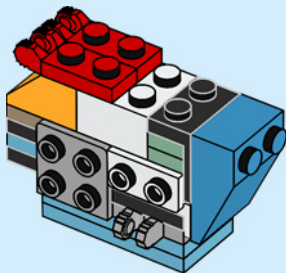



1x

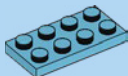

1x

# 42

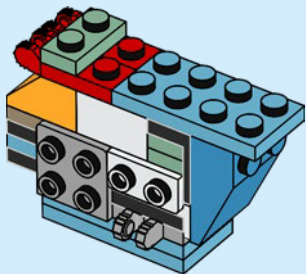



2x

43

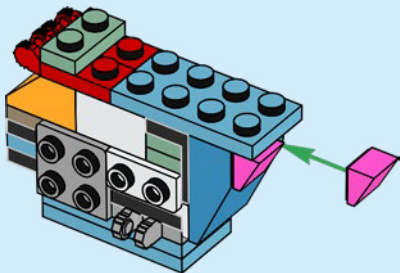

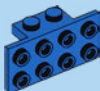

2x



2x

44

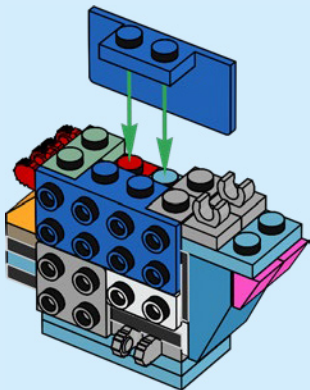

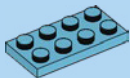

1x

45

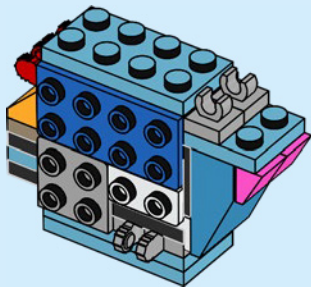



1x



1x



1x



2x

# 46

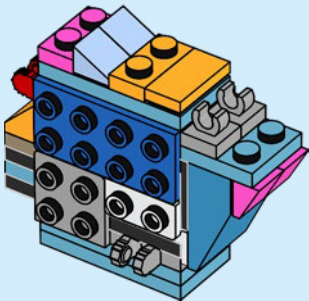





2x



1x

47

1



2

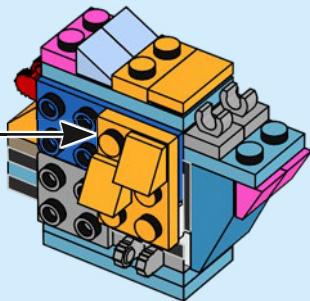

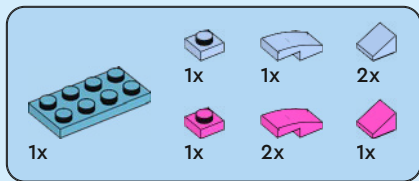

# 48

## 1

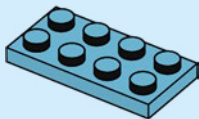

## 2

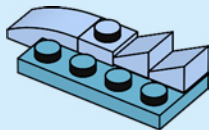

3

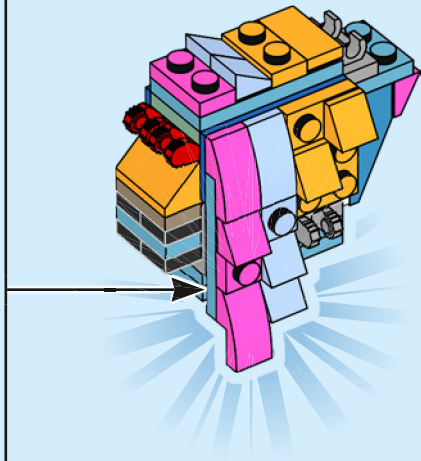
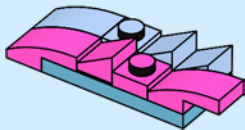



2x



1x

# 49

1



2

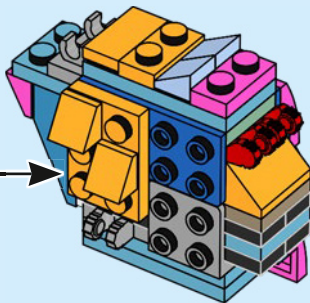

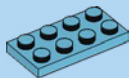

1x



1x



1x



2x



1x



2x



1x

50

1

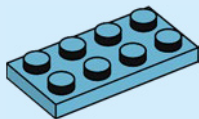

2

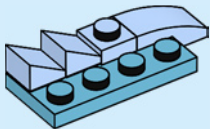

3

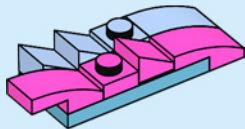

51

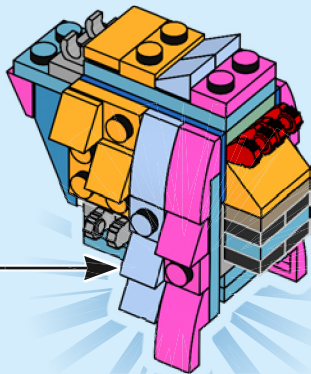



1x



1x

52

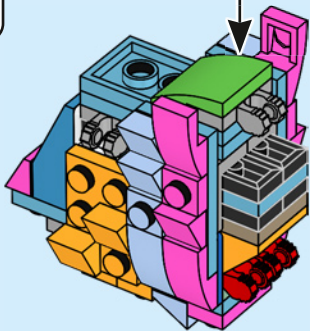
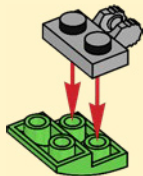



53

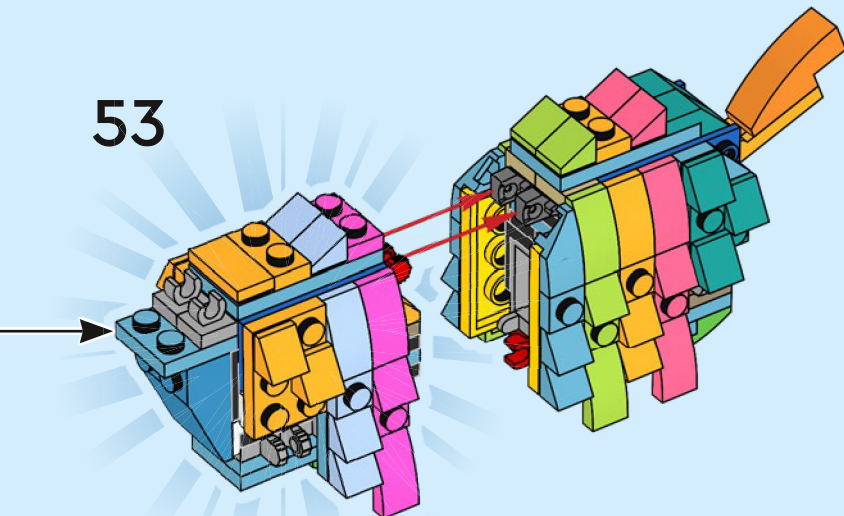



1x



1x



2x

# 54

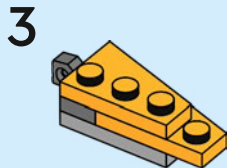
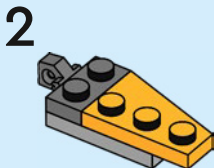
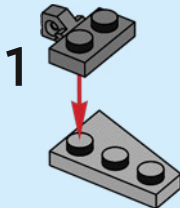

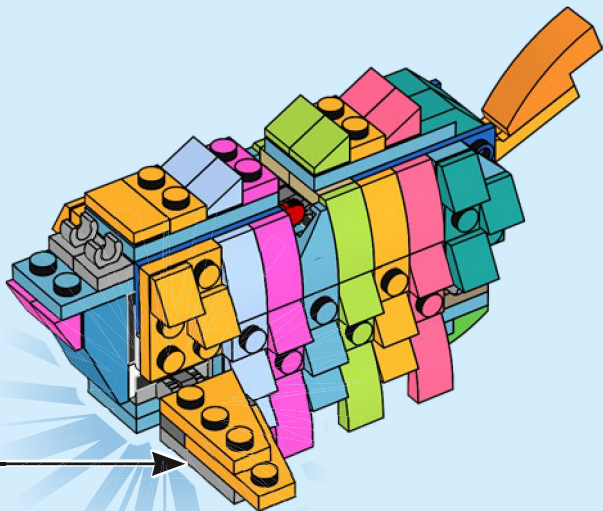



1x



1x



2x

# 55

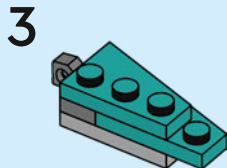
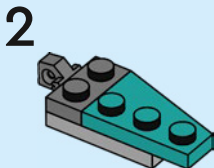
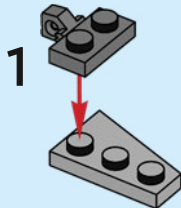

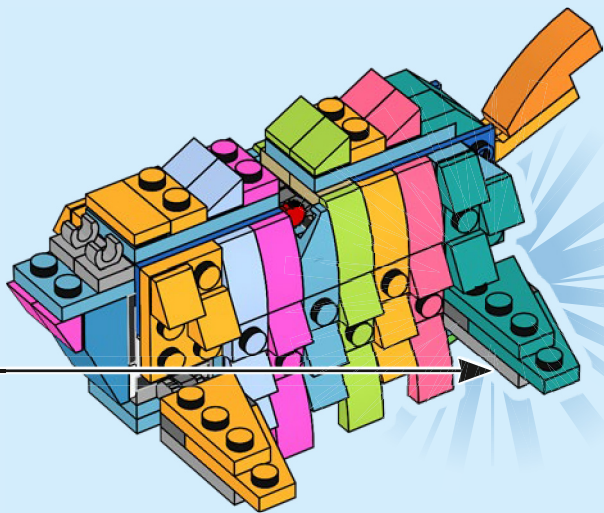



1x



1x



2x

# 56

1

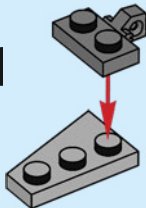

2



3

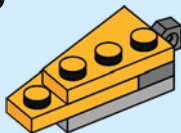

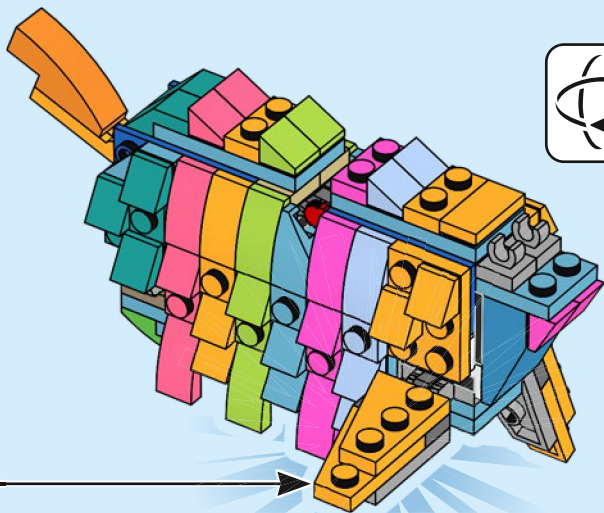



1x



1x



2x

# 57

1

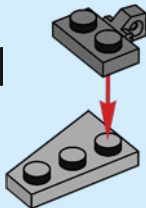

2

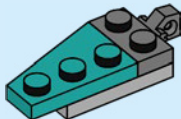

3

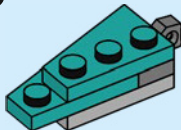



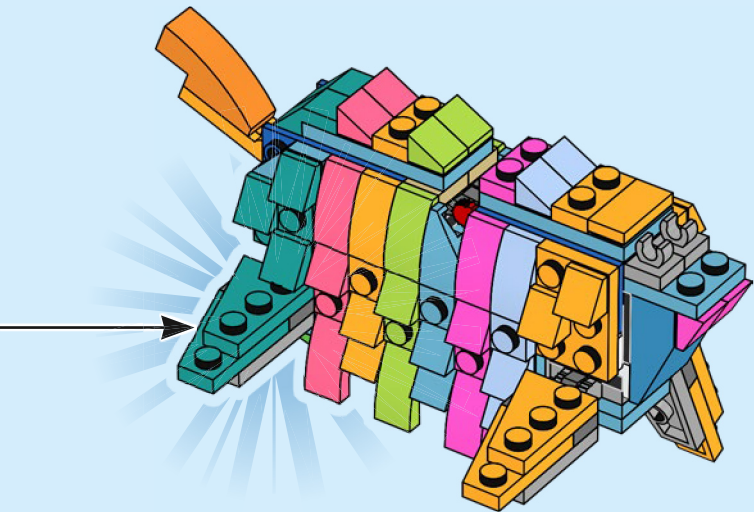



1x



1x

# 58

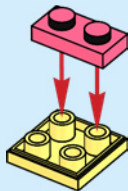



2x

59





2x

60





2x



2x

# 61



2x

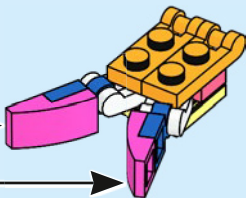



2x

62

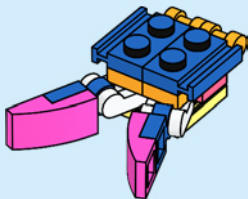



2x

63

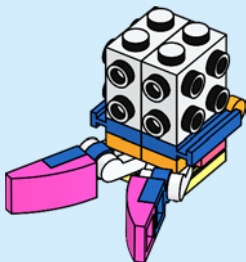



1x

64

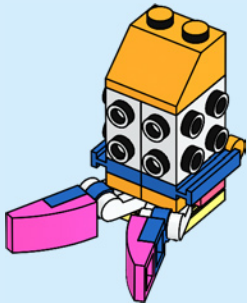





2x

65

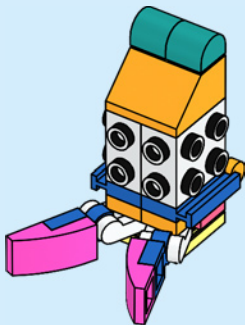



1x



1x

66

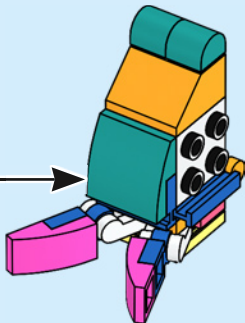
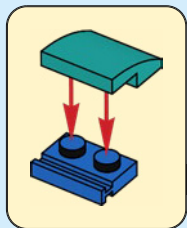



1x

67

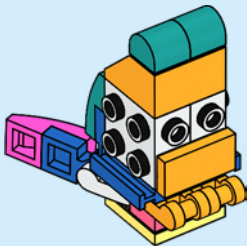



1x



1x

68

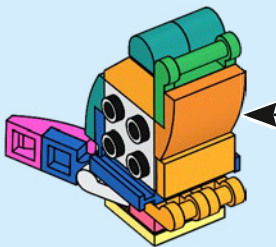
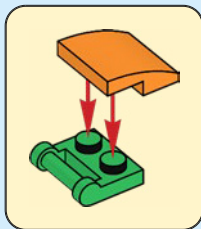



1x



1x



1x

# 69

1

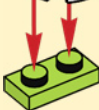

2

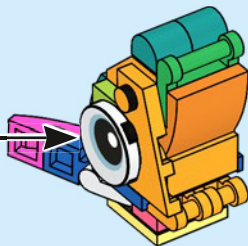



1x



1x



1x

70

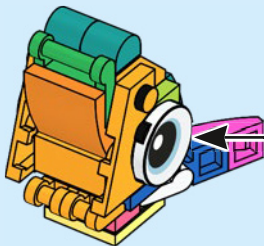

1



2



71

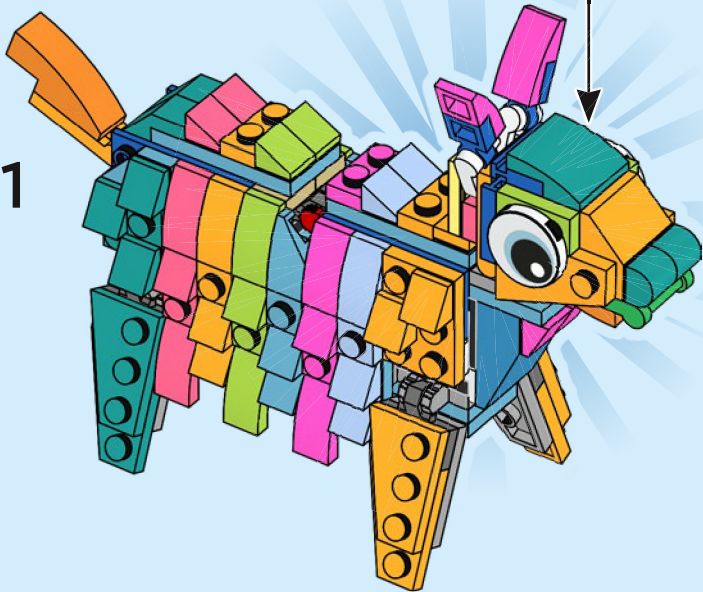



2x



2x



2x



# 72

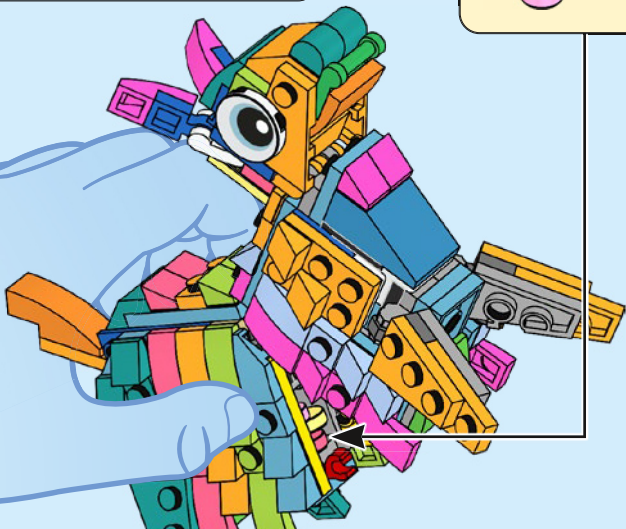



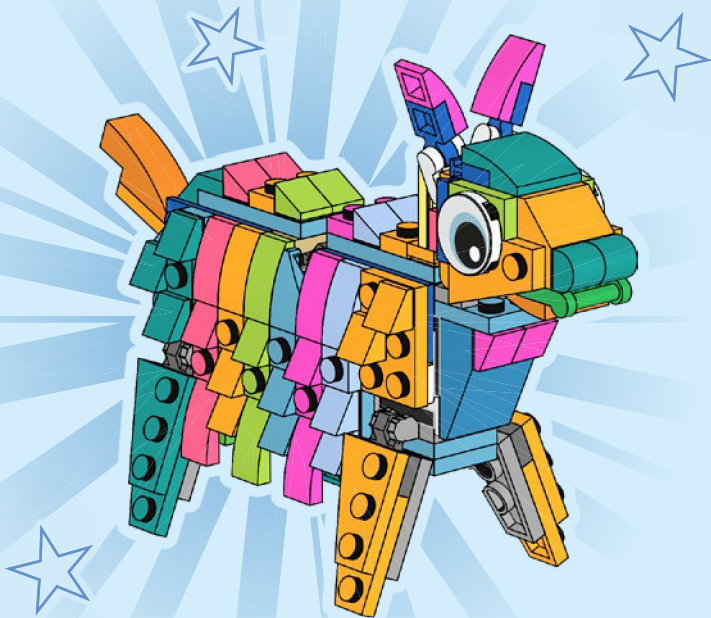



2x  
6174937



5x  
6018774



2x  
6312480



1x  
300301



2x  
6252746



2x  
6374151



2x  
6313120



2x  
6267049



2x  
6352221



3x  
6179330



4x  
6194751



2x  
4243817



3x  
6117973



8x  
6350415



1x  
4521931



2x  
6404643



1x  
6067913



1x  
4251969



6x  
6278172



2x  
6295358



2x  
6291006



2x  
6291004



4x  
6213777



2x  
6430965



1x  
6223665



4x  
4504372



2x  
4621557



4x  
6069006



2x  
4164037



3x  
6035540



5x  
4655080



8x  
6023173



2x  
6073040



3x  
6020145



3x  
6020146



2x  
6028736



2x  
6099728



2x  
4622062



2x  
6020181



3x  
6248671



3x  
6097503



2x  
4211791



2x  
4211794



5x  
6266209



2x  
6326078



2x  
4654580



1x  
4211491



4x  
6266248



2x  
6266225



6x  
6372124



2x  
6184484



2x  
6335524



2x  
6217797



4x  
6127601



1x  
6057387



6x  
6132918



2x  
6380634



1x  
6298527



4x  
6343806



1x  
6021566



4x  
6284587



1x  
4518892



4x  
4619520



2x  
6097493



1x  
6296904



1x  
6296901



2x  
6249415



11x  
4655256



4x  
6311436



4x  
6258098



2x  
6258091



4x  
6258075



1x  
6258094



[LEGO.com/service](https://www.lego.com/service)

YOU COULD

# WIN



Scan this QR code or go to  
**LEGO.COM/PRODUCTFEEDBACK** and give us  
your short feedback about this LEGO® set for  
a chance to win a cool LEGO prize.

Terms and Conditions apply\*



**DE: Du könntest GEWINNEN.** Es gelten die Teilnahmebedingungen\* **FR: Tu pourrais GAGNER.** Des conditions s'appliquent\* **IT: Potresti VINCERE tu.** Termini e condizioni sono applicabili\* **ES: Puedes GANAR.** Aplican términos y condiciones\* **PT: Poderá GANHAR.** Aplicam-se termos e condições\* **JA: プレゼント付き! 利用規約が適用されます\*** **ZH: 轻松获奖. 条款和条件适用\*** **KO: 상품의 주인이 되어보세요. 소정의 약관이 적용됩니다\*** **RU: Вы можете ВЫИГРАТЬ.** Действуют положения и условия\* **PL: Szansa na WYGRANĄ.** Obowiązują warunki korzystania\* **CS: Máte šanci VYHRÁT.** Platí všeobecné smluvní podmínky\* **SK: Máte šancu VYHRAŤ.** Platia všeobecné zmluvné podmienky\* **HU: TE IS NYERHETSZ.** Felhasználási feltételek érvényesek\* **RO: Ai putea CÂȘTIGA.** Se aplică termenii și condiții\* **BG: Можете да СПЕЧЕЛИТЕ.** Има определени правила и условия\* **LV: Tu vari LAIMĒT.** Ir spēkā noteikumi un nosacījumi.\* **ET: Sul on võimalus VÕITA.** Kehtivad tingimused\* **LT: Jūs galite LAIMĖTI.** Taikomos sąlygos\*

\*LEGO.com/productfeedback-terms

LEGO and the LEGO logo are trademarks of the/son des marques de commerce du/  
son marcas registradas de LEGO Group. ©2023 The LEGO Group.

6449463