



# BRICK SKETCHES™

40457



Disney  
**MICKEY**  
AND FRIENDS

# Minnie Mouse

Some time ago I was a part of an artists' group on a popular social media platform. Many of the artists were doing marker sketches on small cardstock as a way to engage with their fans. I thought this was a fantastic idea, but I wanted to put my own spin on it using LEGO® bricks. This led to the creation of the very first Brick Sketch. I posted it to my social media channels with some apprehension, not entirely sure how my fans would react. Thankfully, they loved the concept and wanted to see more!

After some experimenting, I nailed down the basics: Brick Sketches would be plate-based artwork that featured a front-facing character on a 12x16 canvas. Given that Brick Sketches are somewhat three-dimensional, it was also important that they have correct relief wherever possible; for example, the character's chin shouldn't extend further out than the nose. The challenge was to use LEGO pieces creatively to build detailed character artwork on a relatively small canvas.

Brick Sketches became far more popular than I ever expected. Fans loved suggesting new characters and often asked me to create instructions so that they could build their favorites. It was difficult to set aside the concept when I started working at the LEGO Group, but through an amazing series of events, Brick Sketches are now available from the LEGO Group itself. It's a dream come true.



*LEGO® designer Chris McVeigh*

# Minnie Mouse

Il y a quelque temps, je faisais partie d'un groupe d'artistes sur la plate-forme d'un média social très connu. De nombreux artistes réalisaient des croquis au marqueur sur de petits cartons pour interagir avec leurs fans. Cette idée me plaisait beaucoup, mais je voulais y apporter ma touche personnelle à l'aide de briques LEGO®. J'ai donc eu l'idée de créer le tout premier croquis en briques. Je l'ai publié sur mes réseaux sociaux avec une certaine appréhension, car je ne savais pas comment mes fans allaient réagir. Heureusement, ils ont adoré le concept et en ont redemandé !

Après quelques expérimentations, je me suis fixé des règles : les croquis en briques devaient être des œuvres montées sur une plaque et ils devaient représenter un personnage de face sur une toile de 12 x 16 tenons. Comme les croquis en briques sont tridimensionnels, il était également important qu'ils soient correctement proportionnés dans la mesure du possible. Le menton du personnage ne devait pas être plus long que le nez, par exemple. Le défi consistait à utiliser des pièces LEGO de manière créative pour construire des représentations détaillées de personnages sur une toile relativement petite.

Les croquis en briques ont eu beaucoup plus de succès que je ne l'aurais imaginé. Les fans adoraient me suggérer de nouveaux personnages et me demandaient souvent de créer des instructions pour pouvoir les construire eux-mêmes. Lorsque j'ai commencé à travailler pour le Groupe LEGO, j'ai eu du mal à mettre ce concept de côté, mais suite à un concours de circonstances incroyable, le Groupe LEGO a fini par proposer lui-même les croquis en briques. Un rêve est devenu réalité.



*Le designer LEGO® Chris McVeigh*

# Minnie Mouse

Hace tiempo, fui miembro de un grupo de artistas en una popular red social. Muchos de ellos hacían dibujos con marcadores en pequeños lienzos de cartulina para interactuar con sus fans. Me pareció una idea fantástica, pero quise darle mi propio toque personal usando bricks LEGO®. Eso fue lo que condujo a la creación del primer Brick Sketch. Lo publiqué en mis canales de las redes sociales con cierta desconfianza, sin estar del todo seguro de cómo reaccionarían mis fans. ¡Afortunadamente, les encantó el concepto y querían ver más!

Luego de experimentar un poco, definí lo básico: un Brick Sketch sería un diseño a base de placas que representaría a un personaje, de frente, sobre un lienzo de 12x16. Dado que los Brick Sketches son, en cierto modo, tridimensionales, también era importante recrear el relieve correcto donde fuera posible; por ejemplo, la barba de un personaje no debía sobresalir más que su nariz. El desafío consistía en usar piezas LEGO con creatividad para construir retratos detallados de personajes sobre un lienzo relativamente pequeño.

Los Brick Sketches acabaron haciéndose mucho más populares de lo que esperaba. A los fans les encantaba sugerir nuevos personajes y, a menudo, me pedían que creara las instrucciones necesarias para construir a sus favoritos. Fue difícil apartarme de la idea cuando empecé a trabajar en The LEGO Group. Sin embargo, luego de una sorprendente serie de acontecimientos, los Brick Sketches vuelven a estar disponibles, ahora oficialmente, como productos LEGO. Es un sueño hecho realidad.



*El diseñador de LEGO® Chris McVeigh*





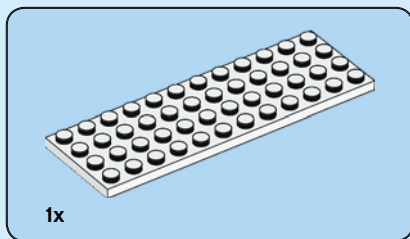

1

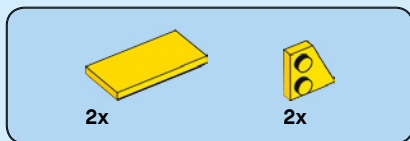
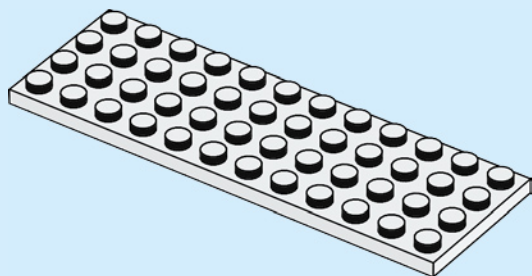

2

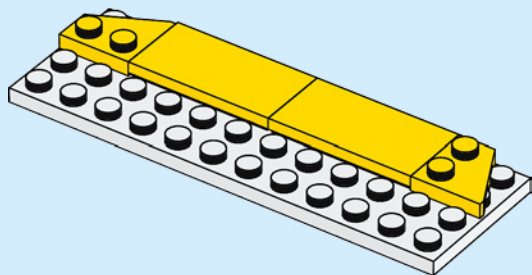



4x



1x

3

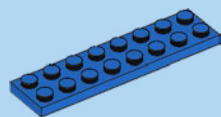
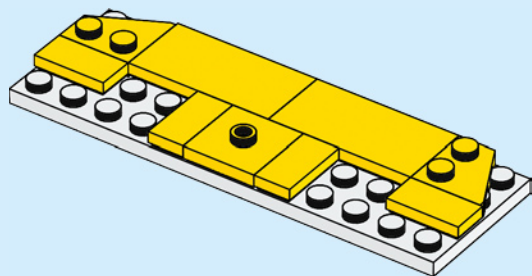

2x

4

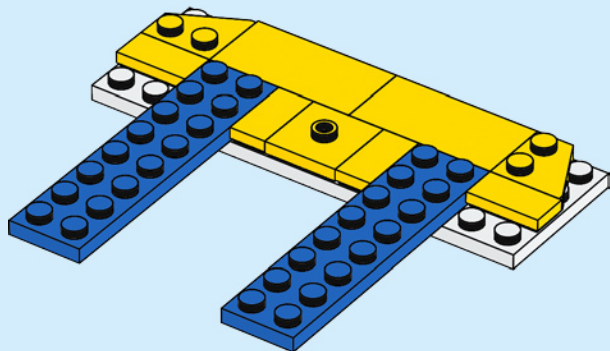

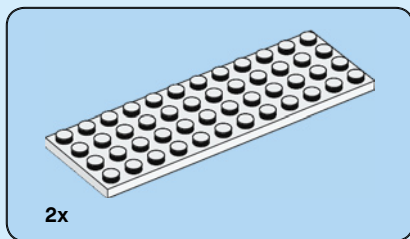

5

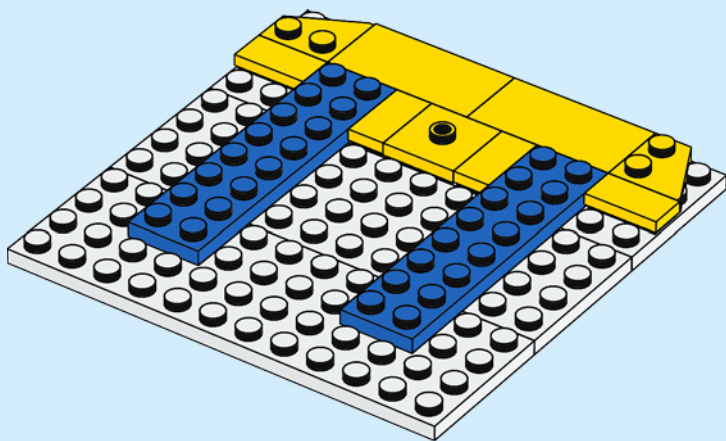

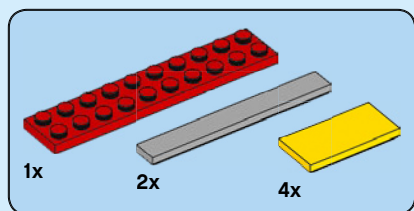

6

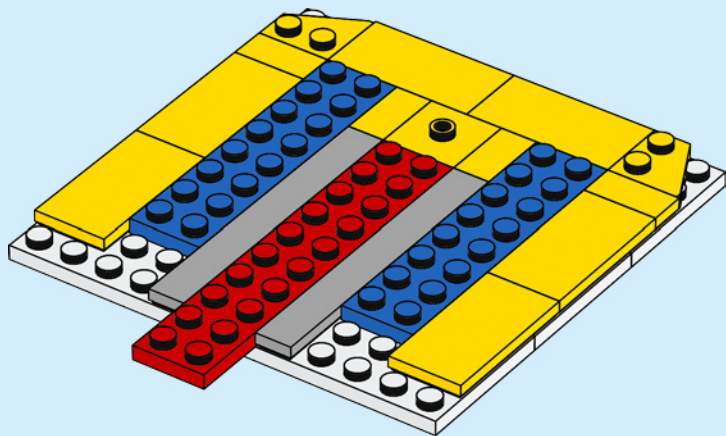

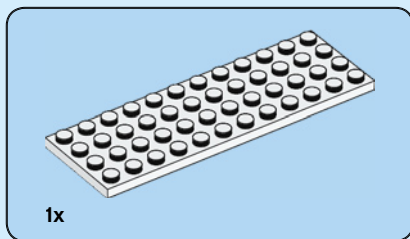

7

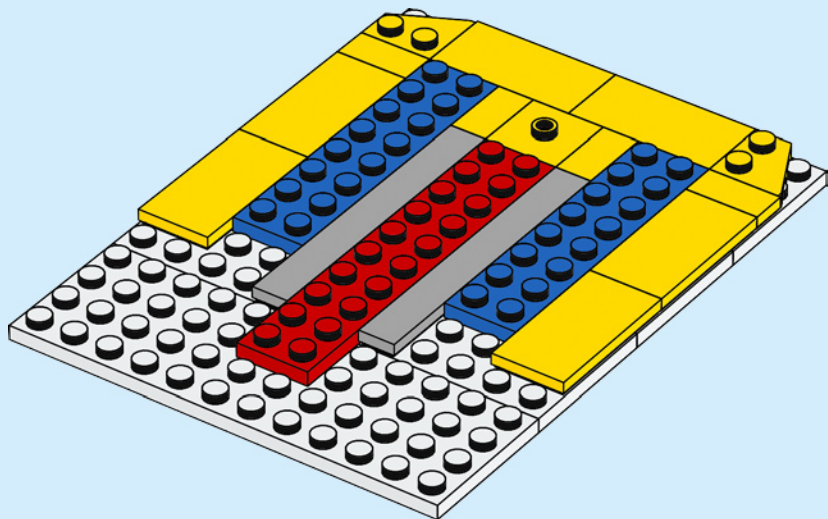

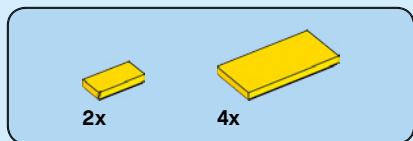

8

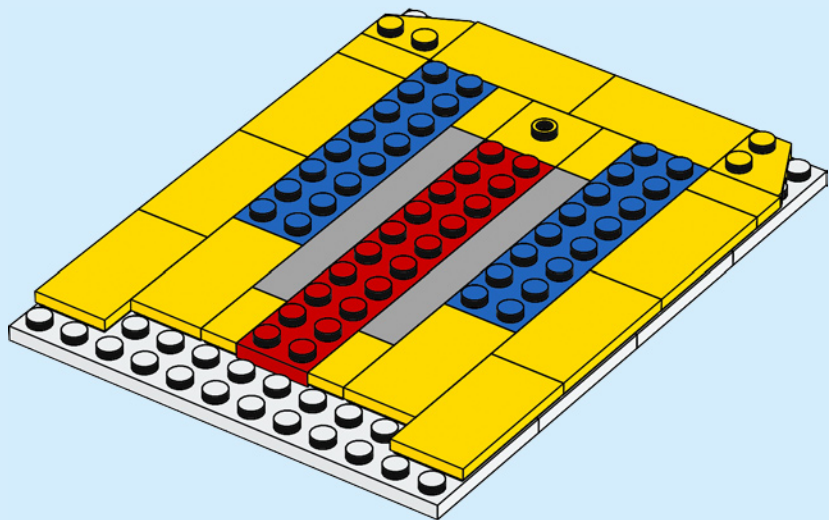

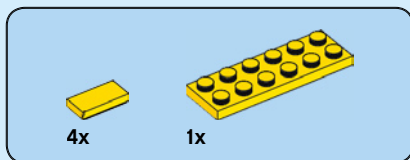

9

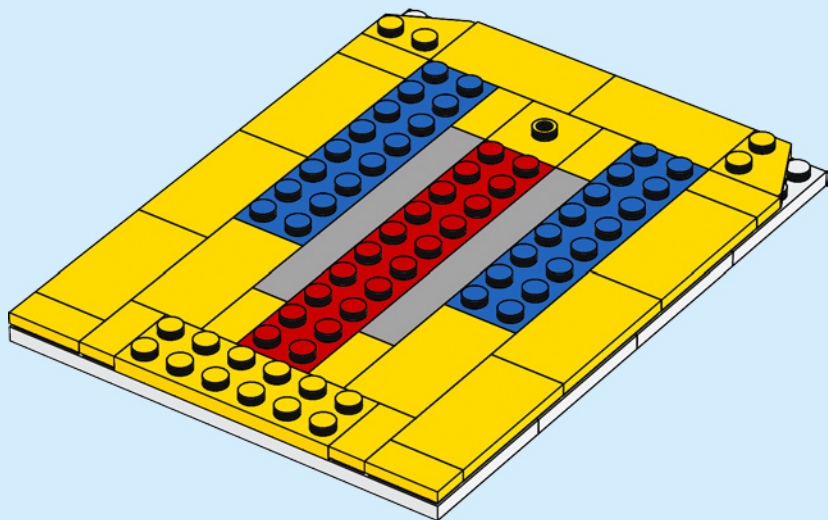

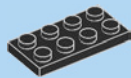

2x



1x

# 10

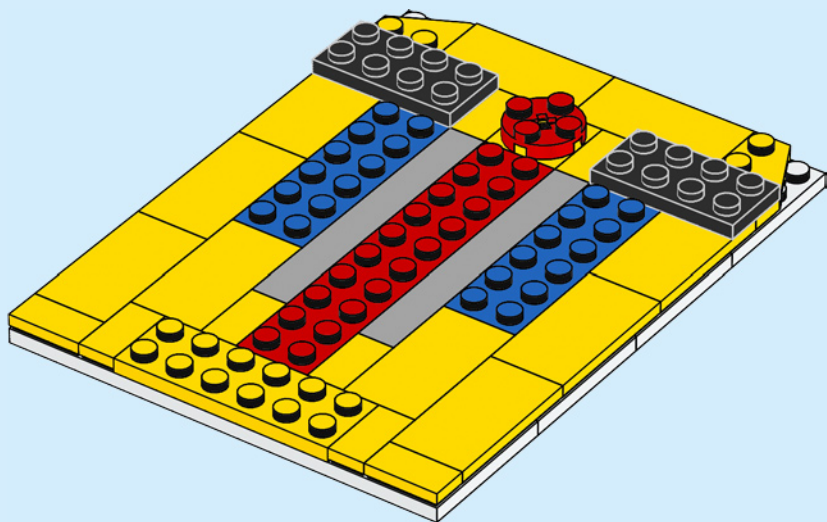



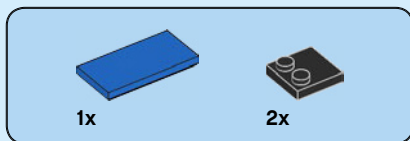

11

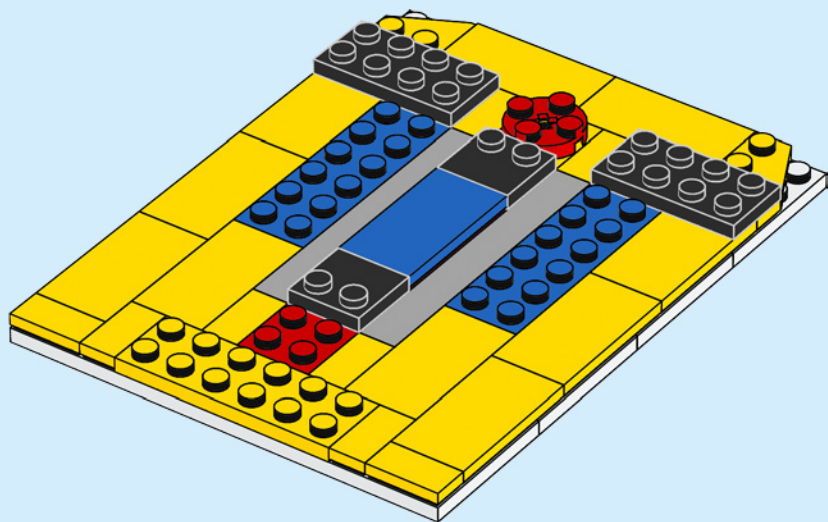

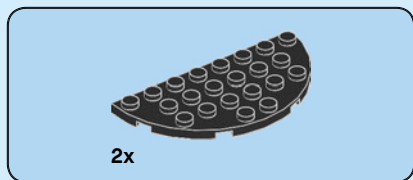

12

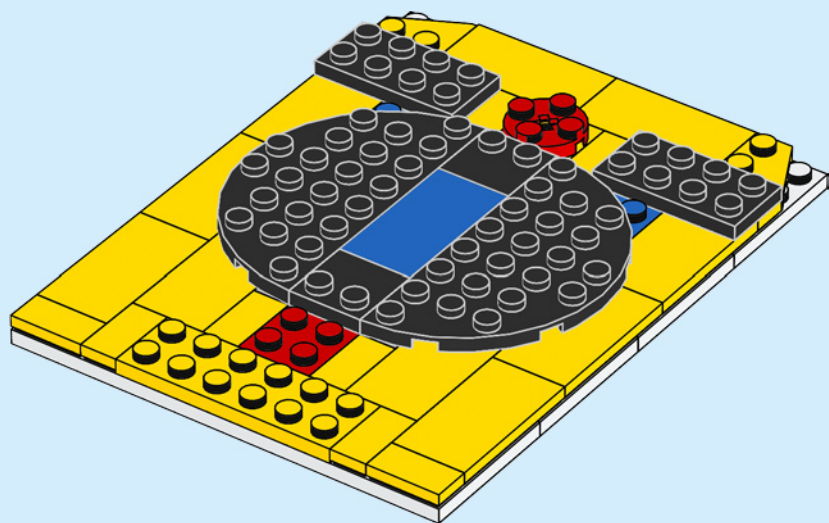

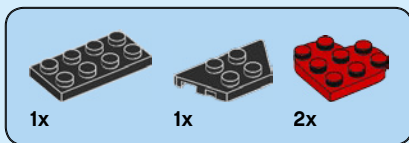

# 13

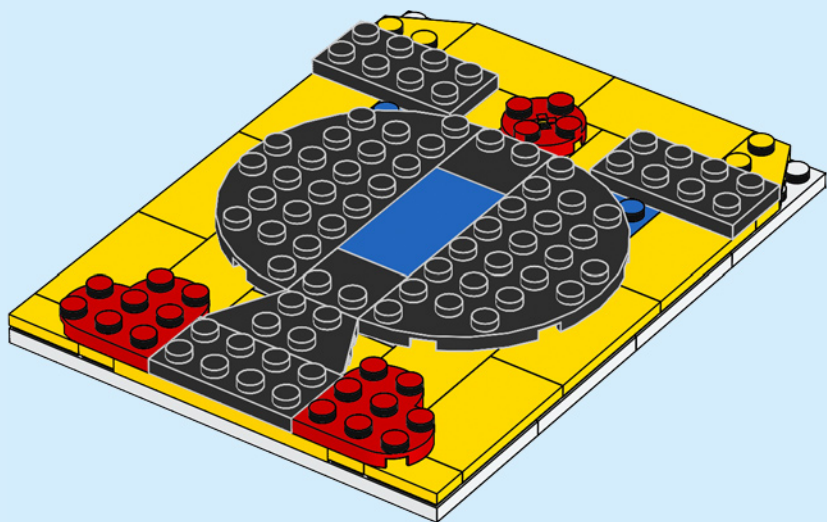

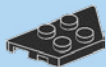

1x

14

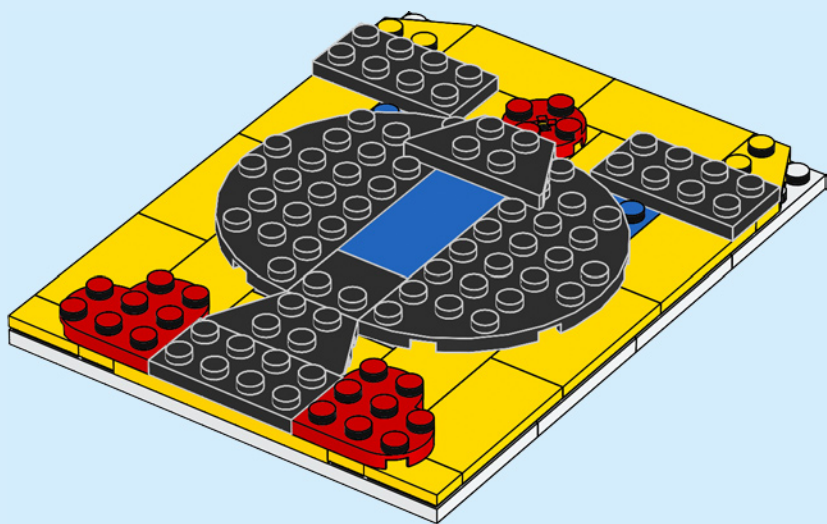

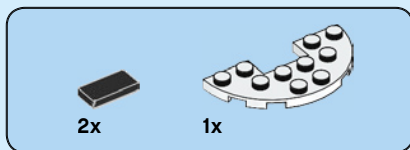

# 15

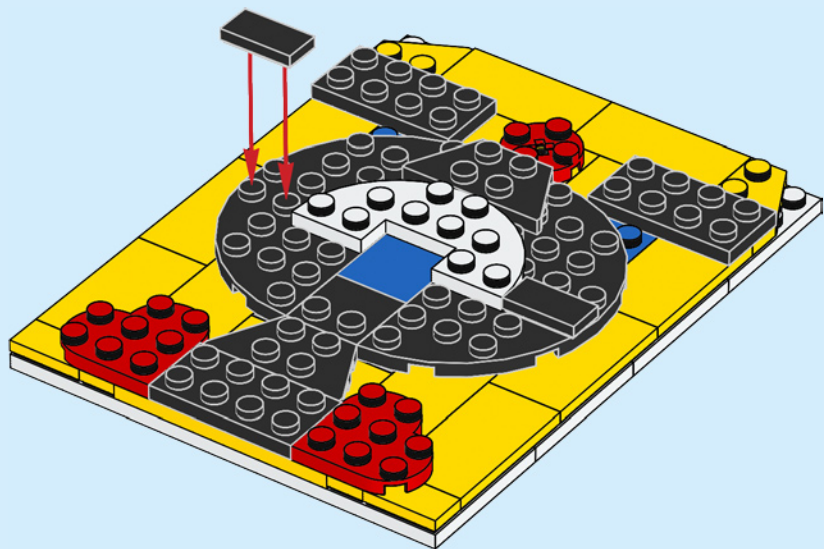



1x



1x

# 16

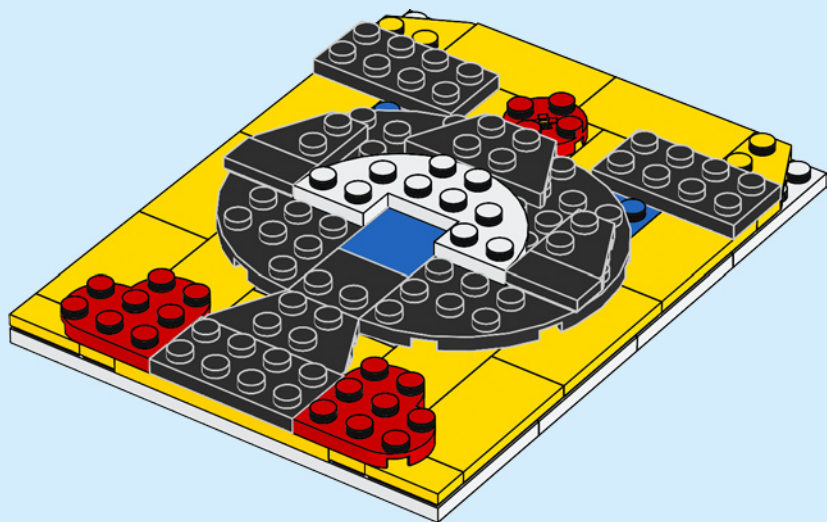

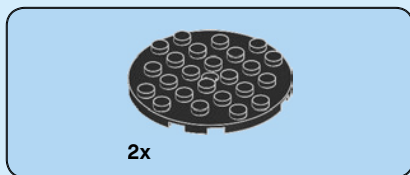

17

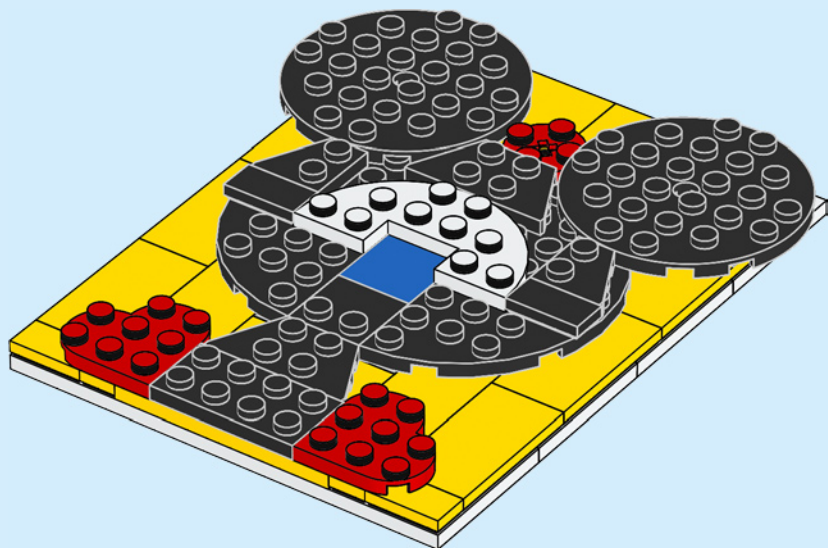

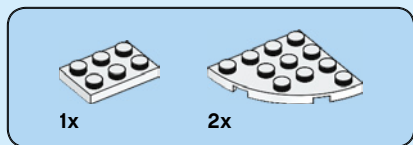

18

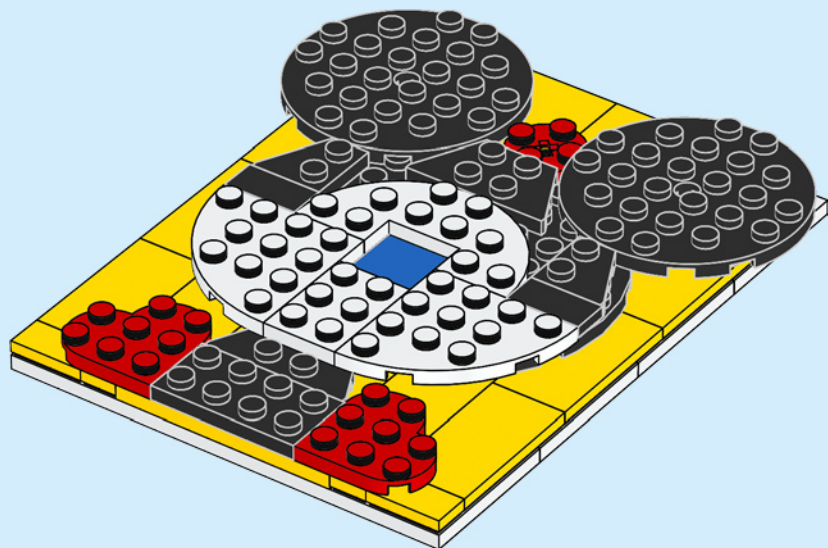





2x



2x



1x

# 19

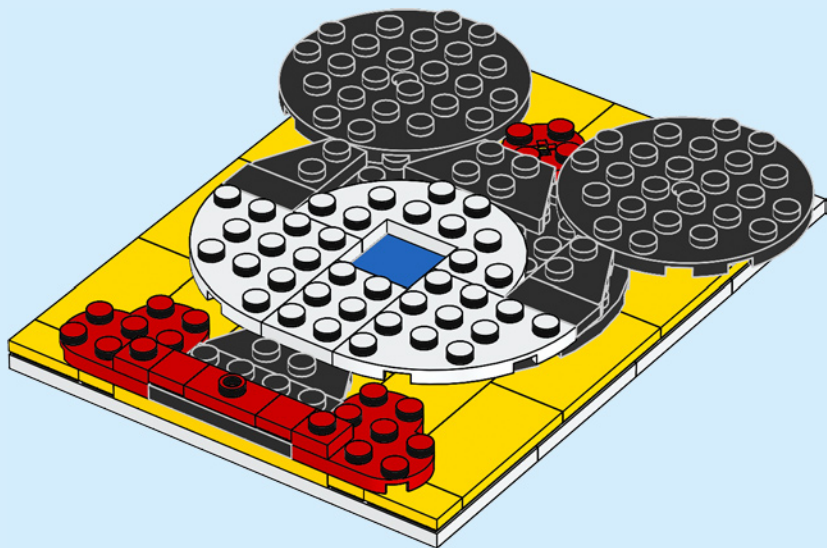



2x



4x

# 20

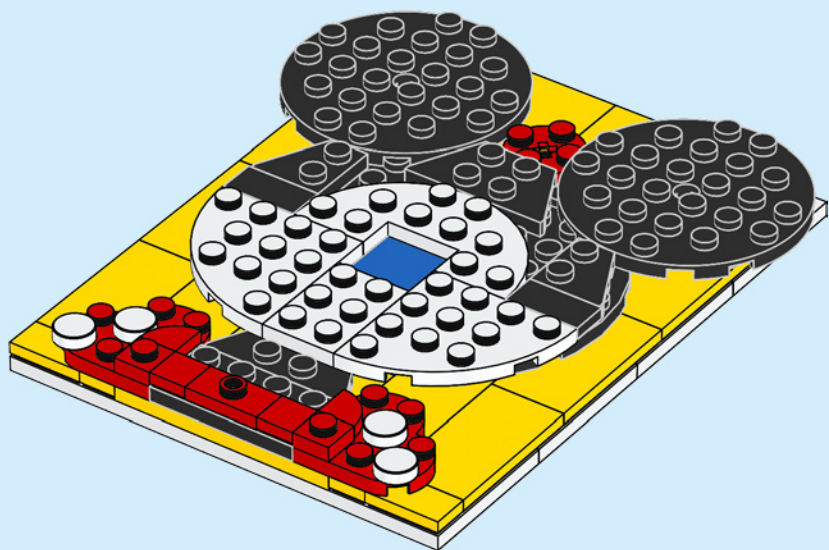

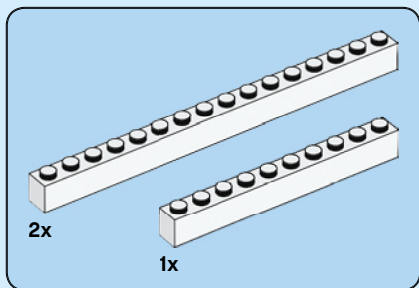

21

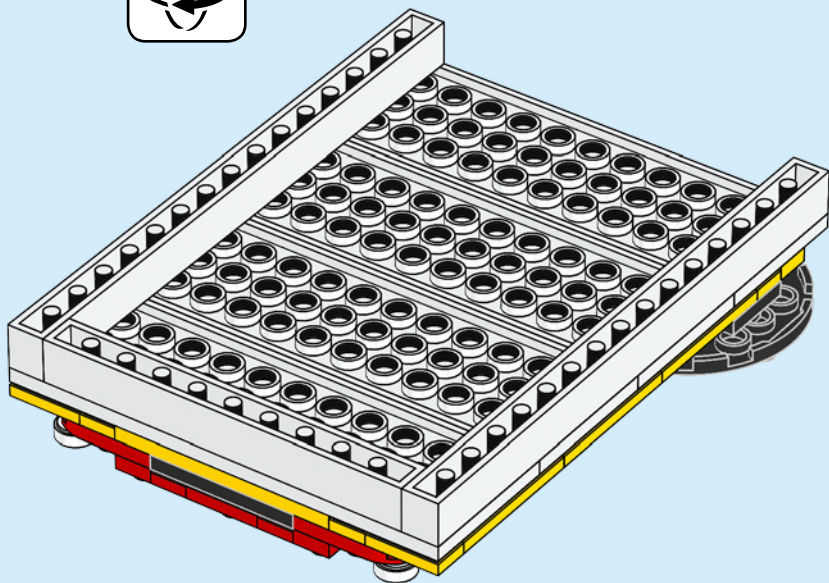

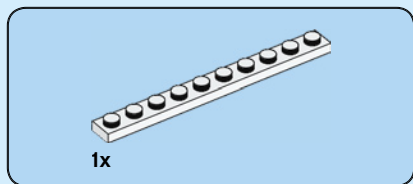

22

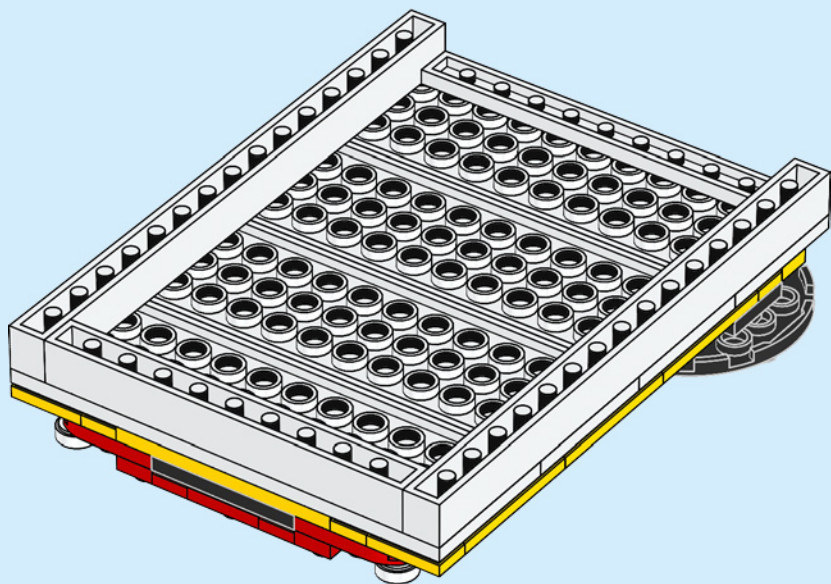



2x



1x

# 23

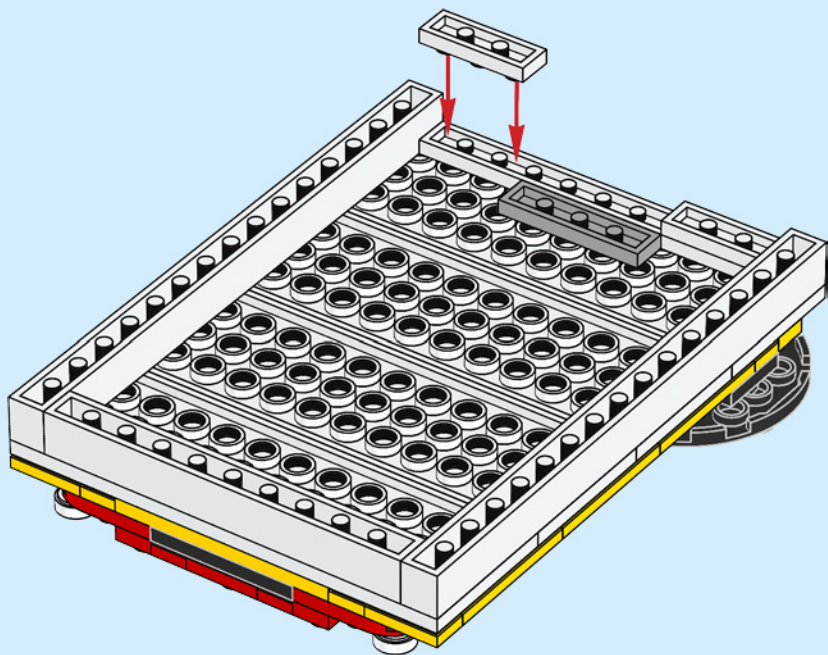



1x



2x

# 24

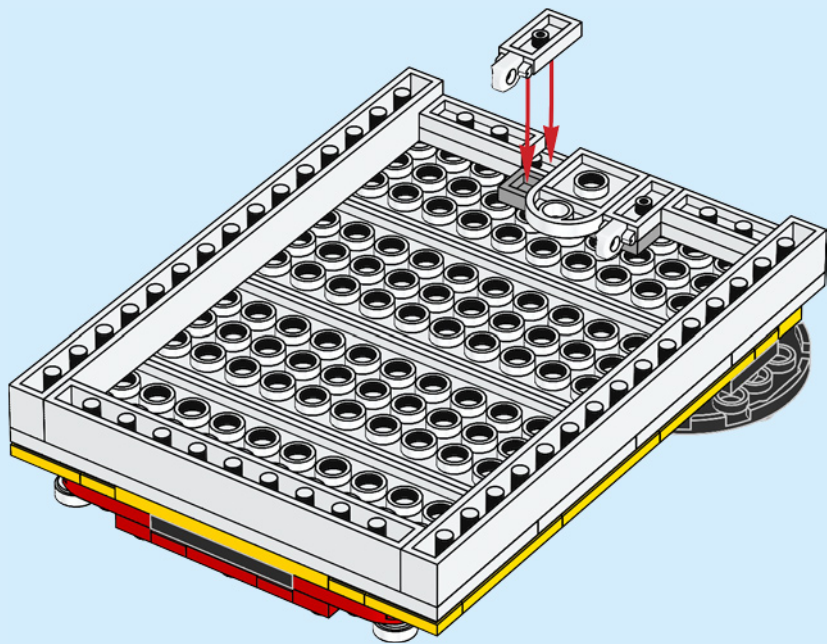

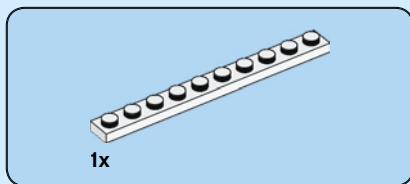

25

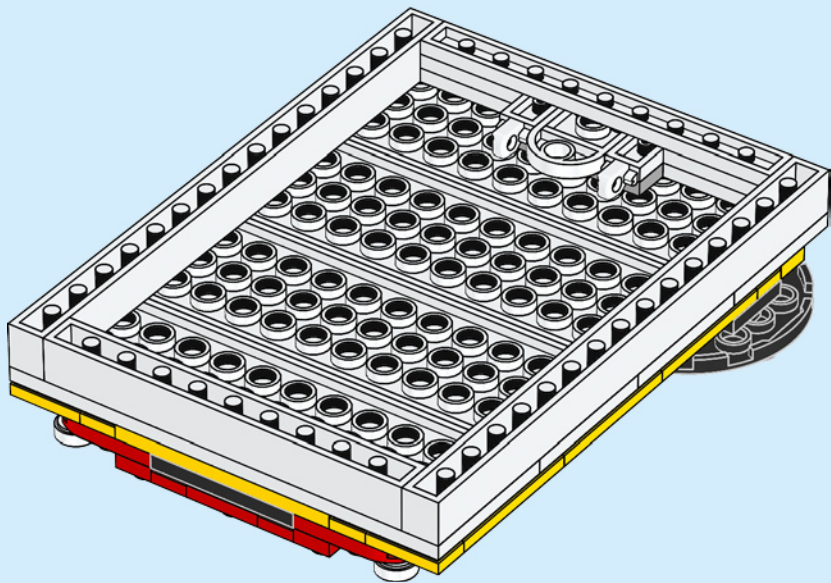

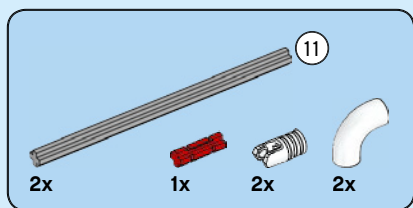

# 26

1

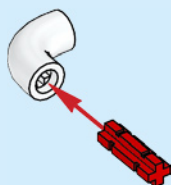

2



3

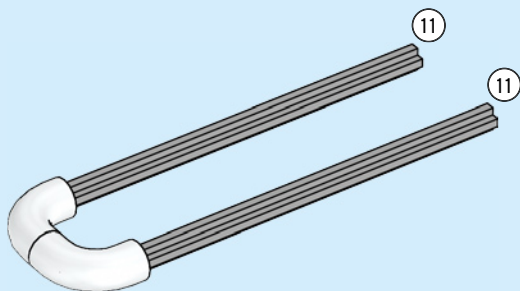



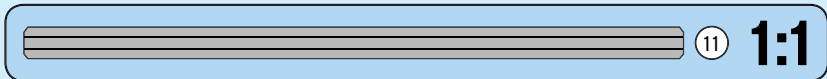

4

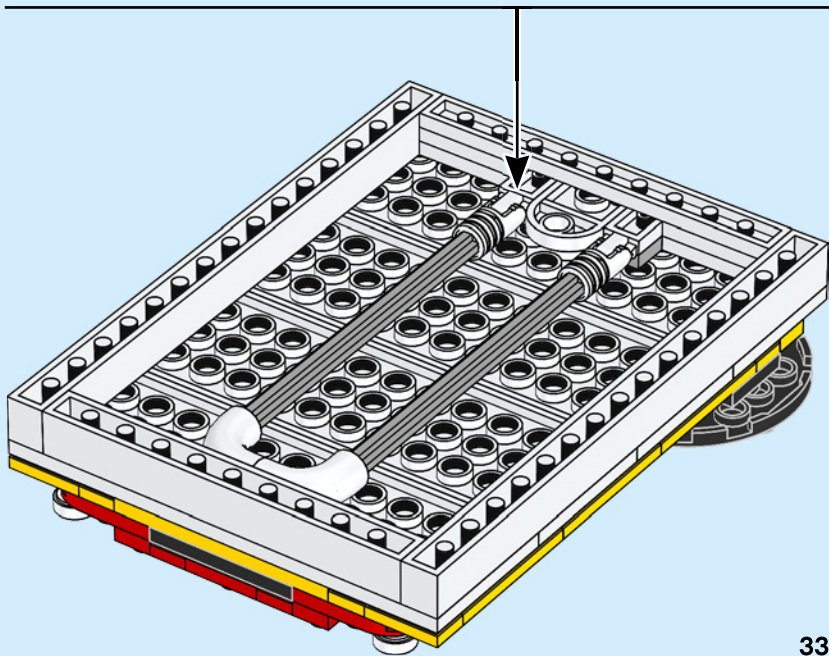
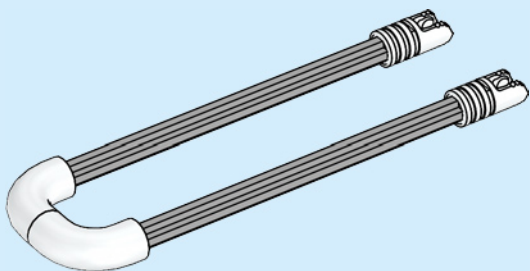



4x

27

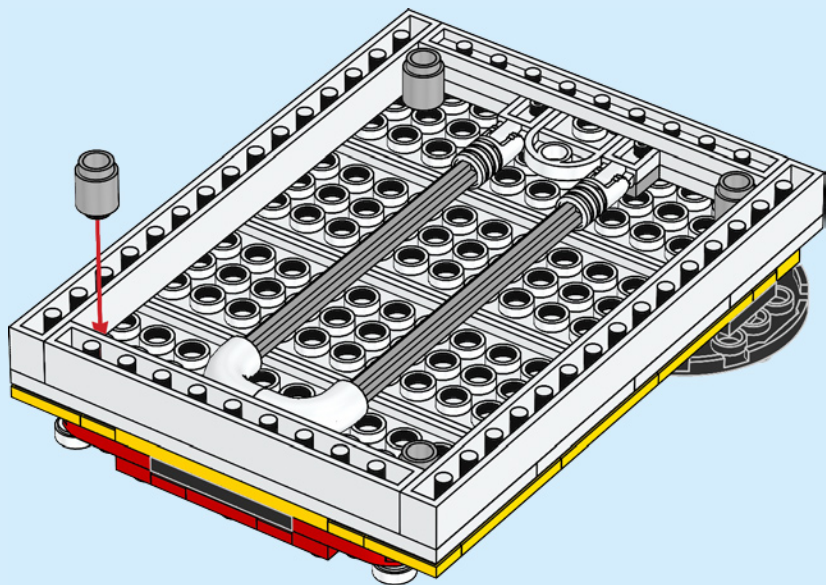



4x

28

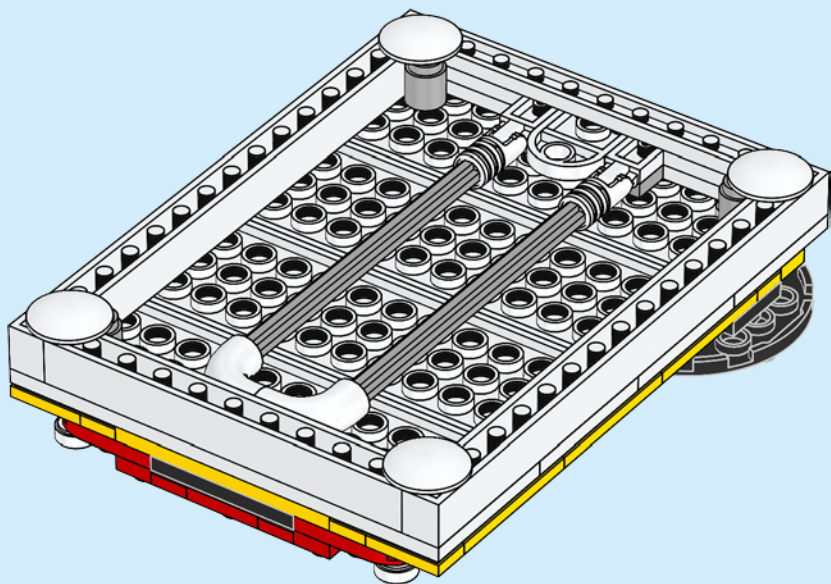



2x



2x



1x

# 29

1



2



3

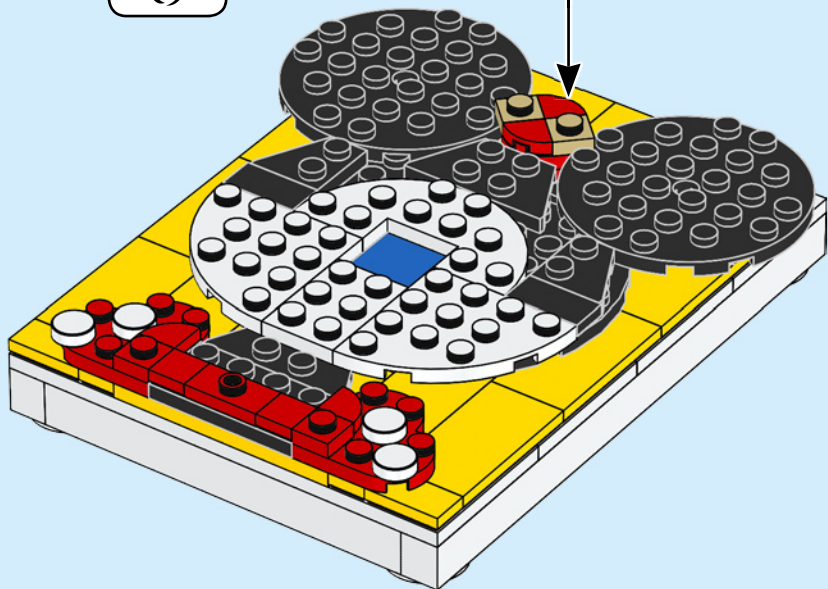
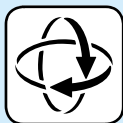

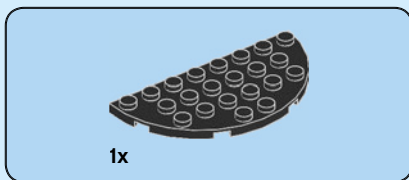

30

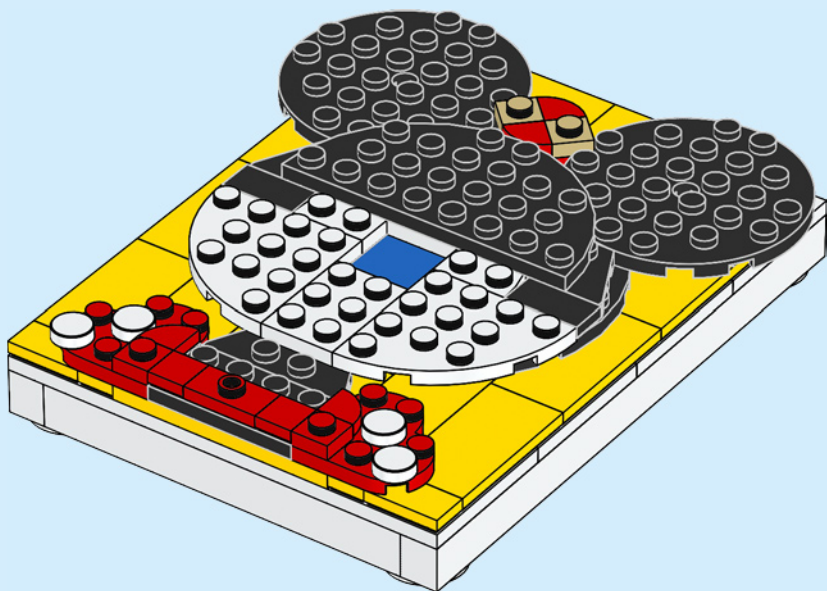

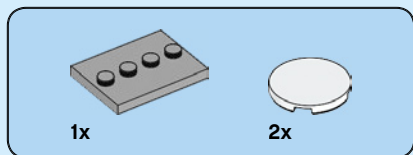

**31**

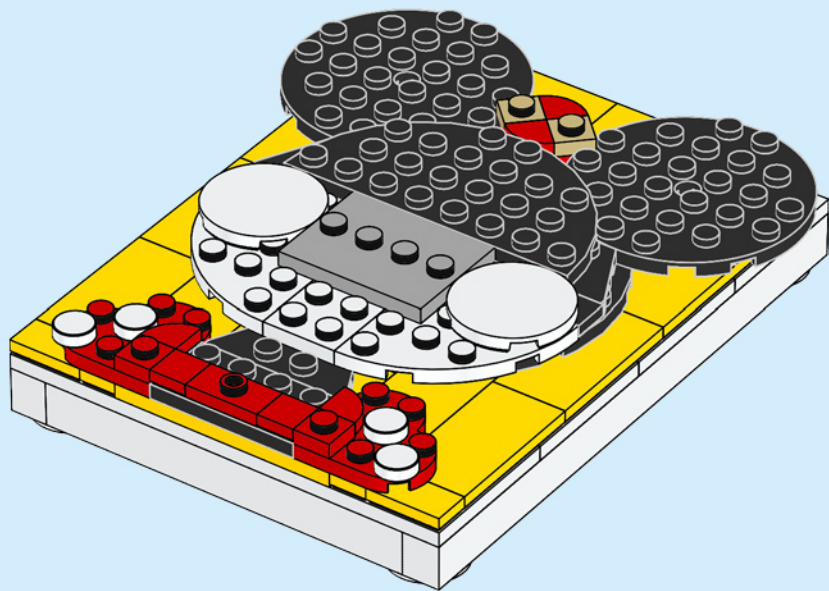

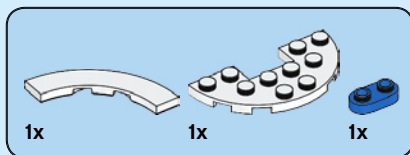

32

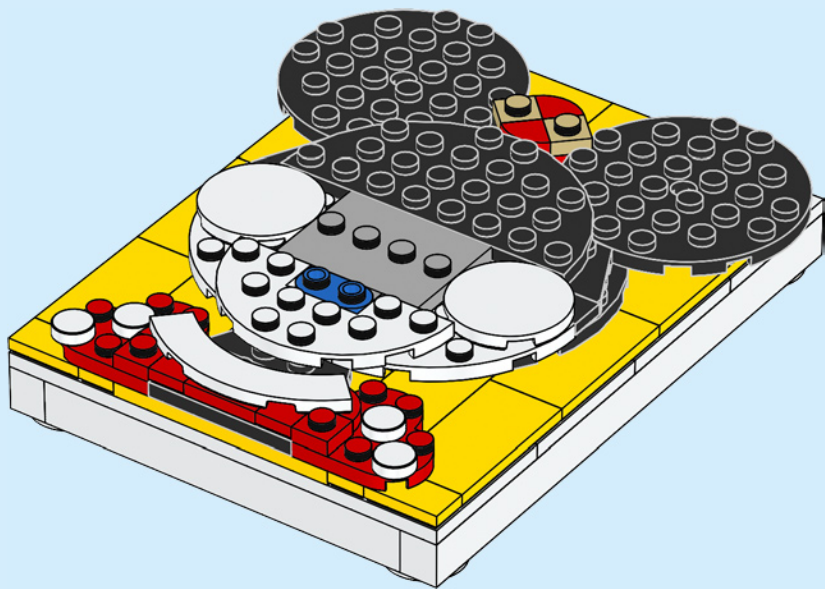

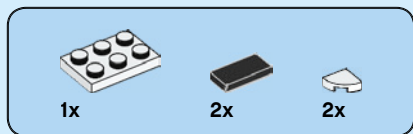

33

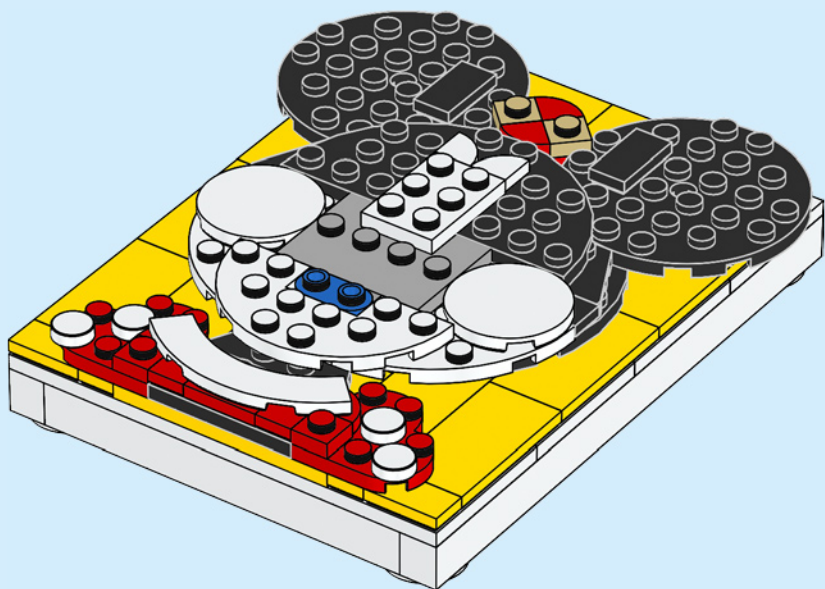



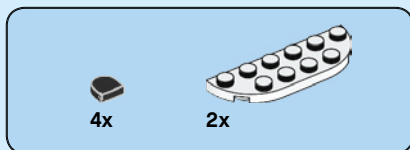

# 34

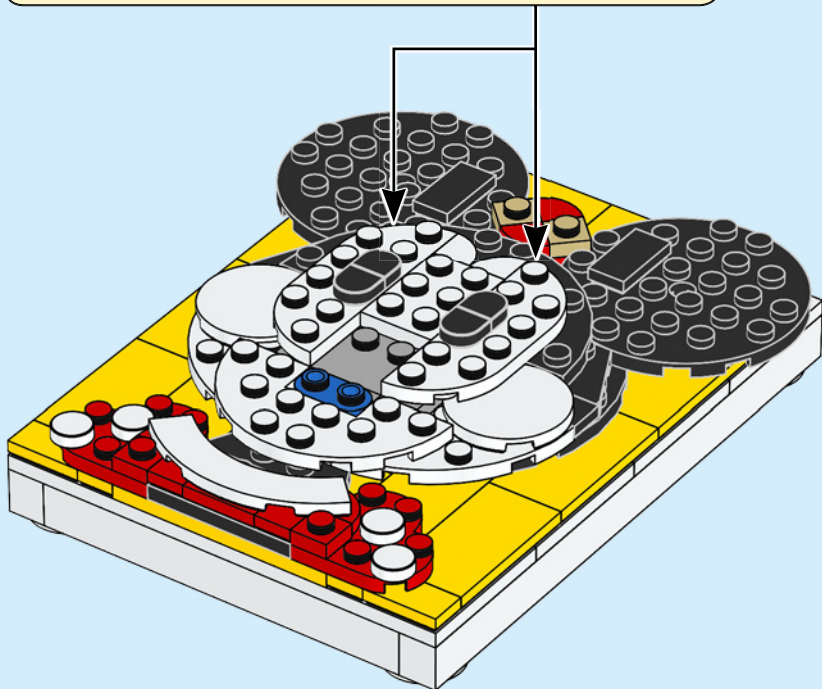
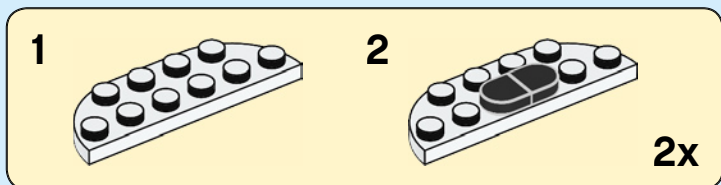



1x



1x



2x

# 35

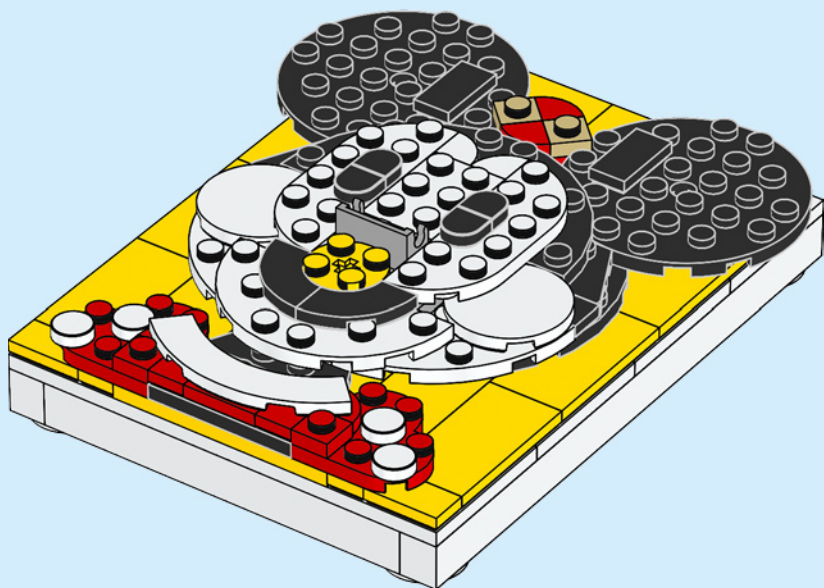



36

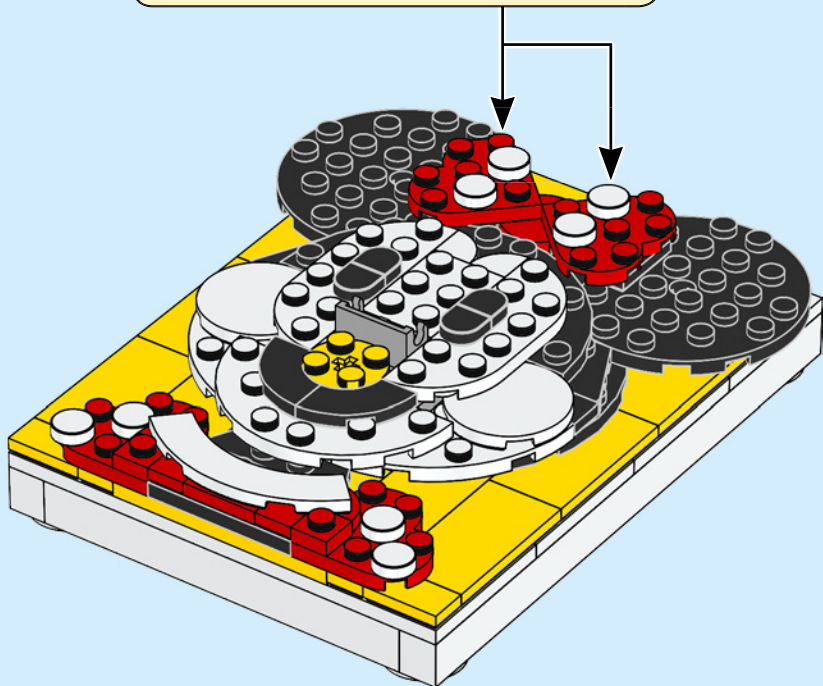
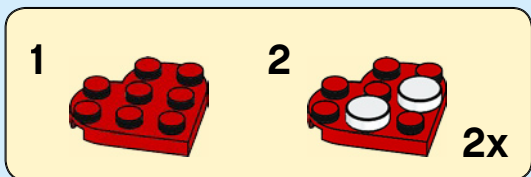



1x

37

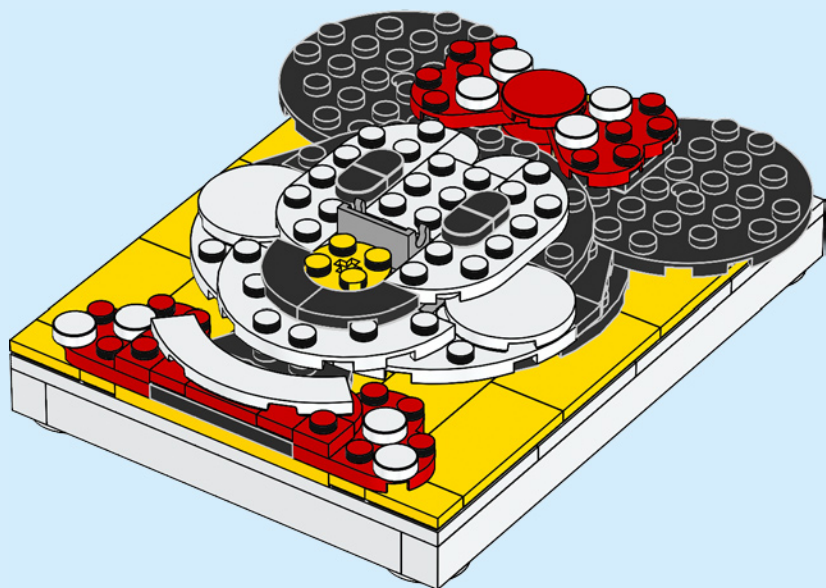

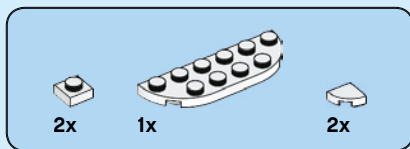

# 38

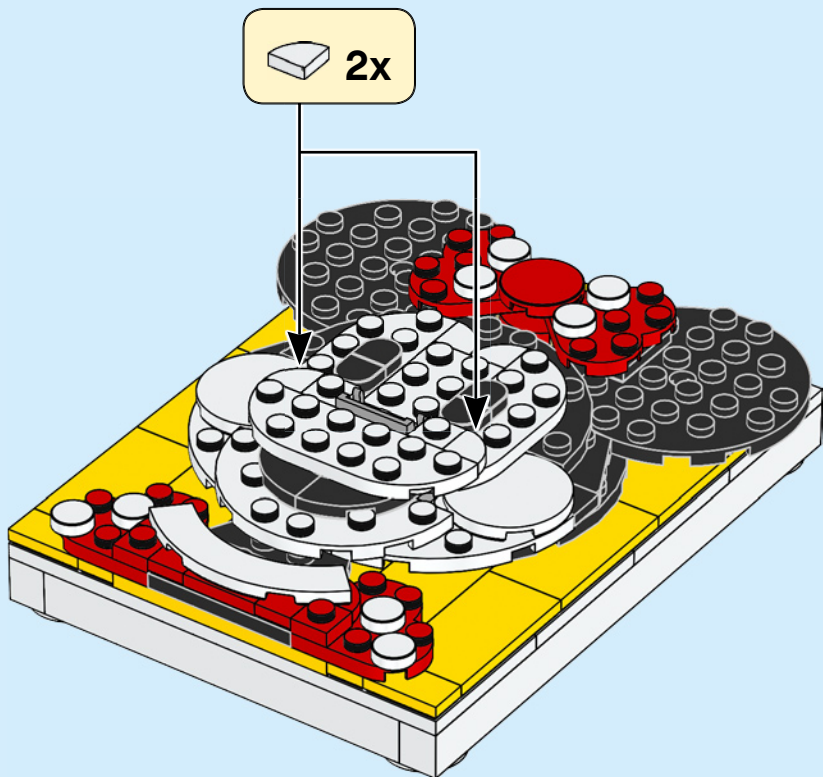
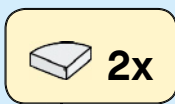



2x

39

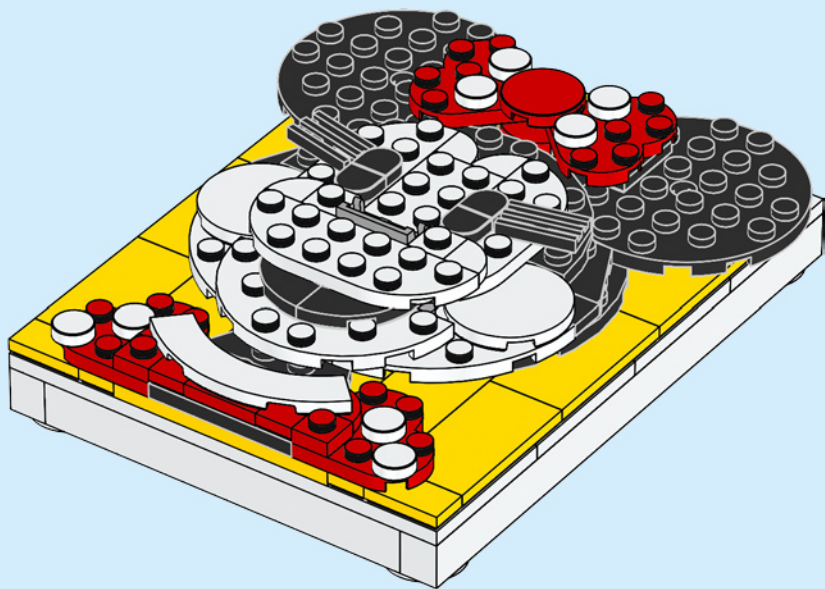

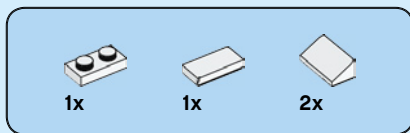

40

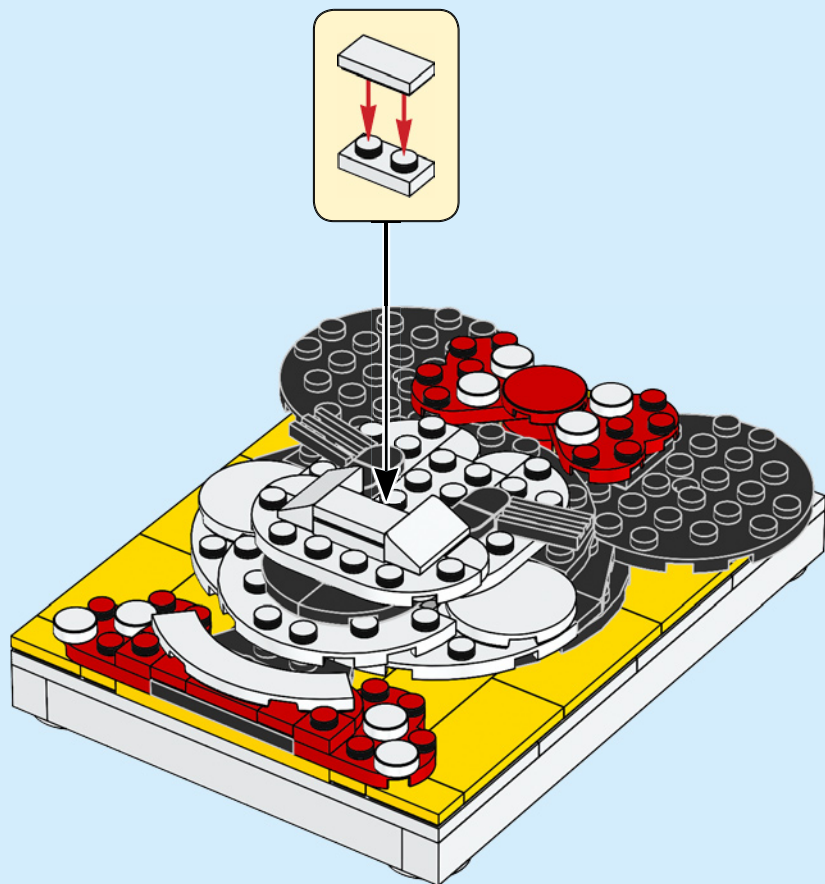

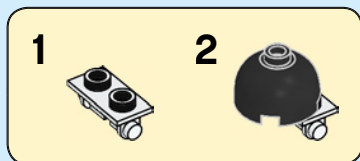

41

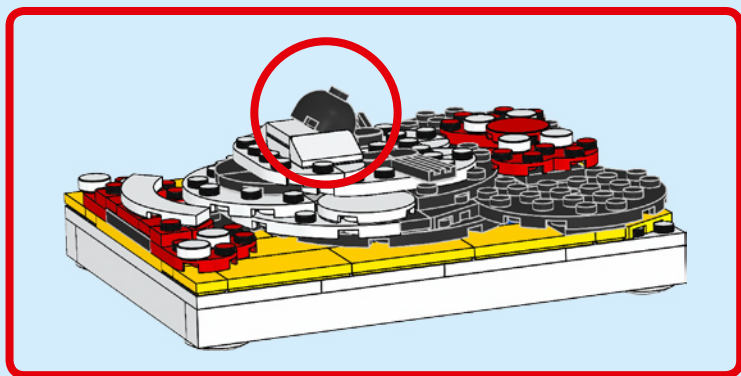
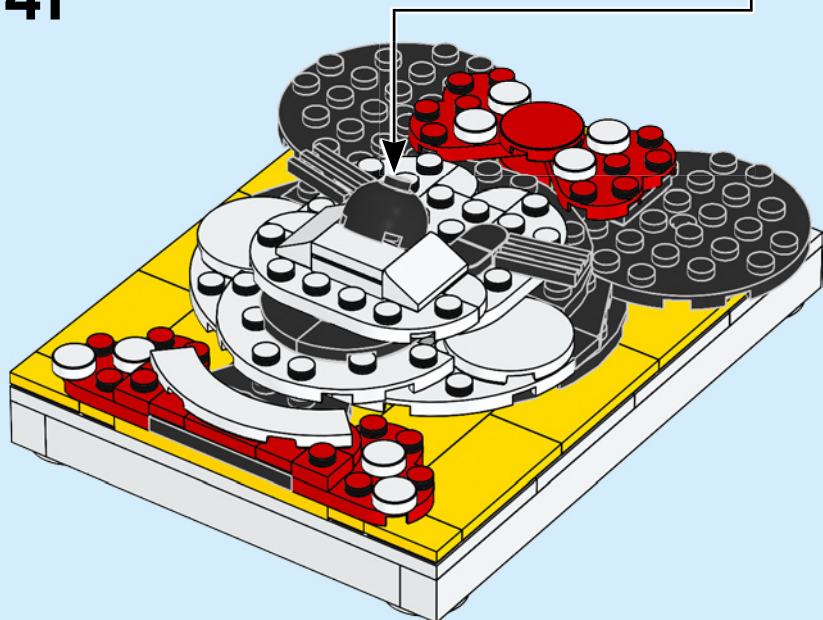



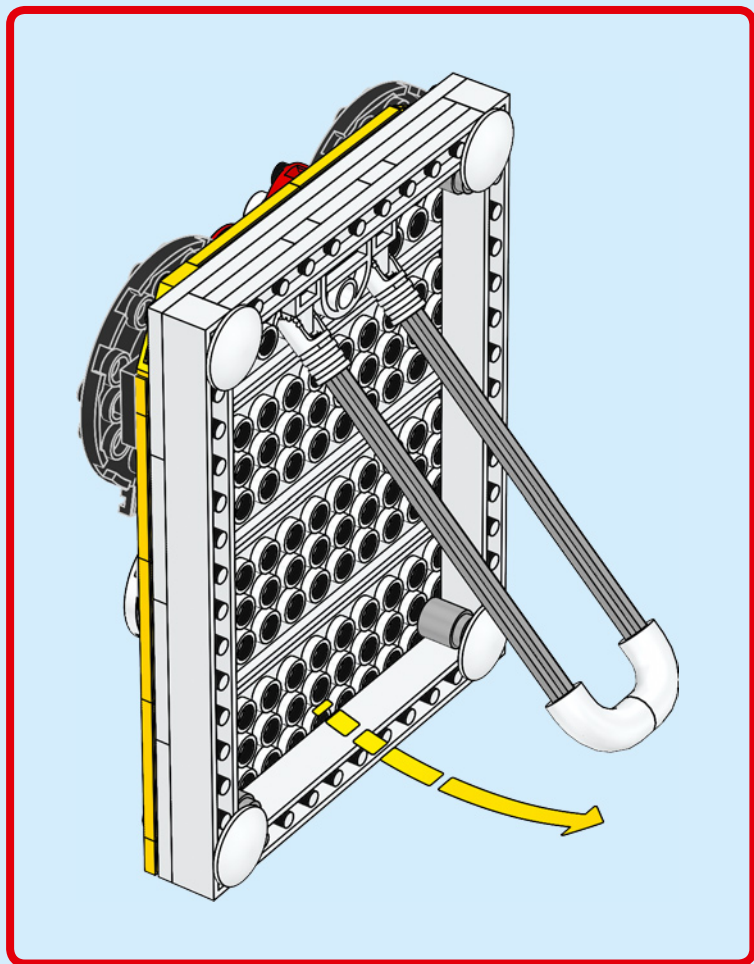

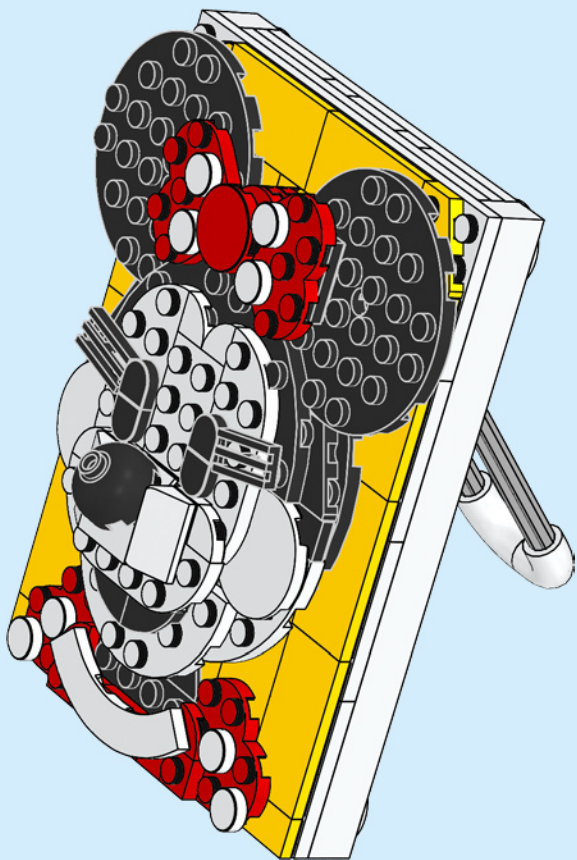

8x  
6284572



2x  
302401



4x  
6172366



2x  
4547489



4x  
4278271



2x  
6194851



2x  
6271540



1x  
393801



1x  
302301



1x  
306901



2x  
6266219



2x  
6300017



2x  
362301



1x  
6089696



2x  
302101



3x  
6147792



2x  
6192352



1x  
6195358



2x  
4178429



1x  
611101



2x  
447701



4x  
4168072



2x  
246501



1x  
383221

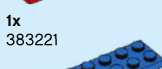

2x  
303423



2x  
6178172



2x  
4159553



2x  
302421



2x  
307021



4x  
6170390



1x  
4142865



2x  
403221



1x  
6066342



1x  
6092565



4x  
6276193



1x  
6315482



1x  
4560180



3x  
302026



2x  
6187587



3x  
6133200



2x  
4211481



2x  
6132201



1x  
403224



10x  
306924



1x  
6126050



10x  
4560181



1x  
379524



4x  
4211412



1x  
4211445



1x  
6079461



4x  
6256435



1x  
6141554



1x  
6141556



1x  
4216660



4x  
306926



2x  
241226



2x  
6192346



2x  
6191630



2x  
4531412



1x  
4211469



1x  
4211469



1x  
4211469



1x  
4211469



1x  
4211469



1x  
4211469



1x  
4211469



11



Customer Service

Kundenservice

Service Consommateurs

Servicio Al Consumidor

LEGO.com/service or dial



: 00800 5346 5555

: 1-800-422-5346

# WIN

GO TO [WWW.LEGO.COM/PRODUCTFEEDBACK](http://WWW.LEGO.COM/PRODUCTFEEDBACK)  
AND GIVE US YOUR SHORT **FEEDBACK**  
ABOUT THIS LEGO® SET FOR A CHANCE  
TO WIN A COOL LEGO PRIZE.

Terms & Conditions apply



## LEGO.com/productfeedback

### GEWINNE

Erzähle uns auf  
[www.LEGO.com/productfeedback](http://www.LEGO.com/productfeedback)

etwas über die Erfahrungen, die du mit  
diesem LEGO® Set gemacht hast, und  
sichere dir die Chance auf einen coolen  
LEGO Preis!

Es gelten die Teilnahmebedingungen

### GAGNE

Rends-toi sur  
[www.LEGO.com/productfeedback](http://www.LEGO.com/productfeedback)

et donne-nous quelques commentaires  
sur ce produit LEGO® pour avoir une  
chance de gagner un prix LEGO !

Voir Conditions Générales

### GANA

Visita  
[www.LEGO.com/productfeedback](http://www.LEGO.com/productfeedback)

y envíanos tu opinión acerca de este  
set LEGO®. ¡Participarás en el sorteo  
de un premio LEGO!

Términos y Condiciones aplicables

### 获取奖品

登录  
[www.LEGO.com/productfeedback](http://www.LEGO.com/productfeedback)

给出关于此乐高®套装的简短反馈，  
就有机会获得炫酷乐高奖品

《条款及条件》适用

### 경품 당첨 기회

[www.LEGO.com/productfeedback](http://www.LEGO.com/productfeedback)

페이지로 이동하여 이 레고® 세트에 대한  
간략한 피드백을 보내 주시고 멋진 레고  
경품을 탈 수 있는 기회를 잡으십시오

약관 적용

### ЗАПОЛНИ АНКЕТУ И ПОЛУЧИ ПРИЗ

Перейди по ссылке  
[www.LEGO.com/productfeedback](http://www.LEGO.com/productfeedback)

ответь всего на несколько во-  
просов об этом наборе LEGO®,  
и у тебя появится шанс выиграть за-  
мечательный приз от компании LEGO.

Применяются Условия и правила  
участия

LEGO and the LEGO logo are trademarks of the/son des marques de commerce du/  
son marcas registradas de LEGO Group. ©2021 The LEGO Group.



©Disney  
[www.disney.com](http://www.disney.com)

6355622