

ATLANTIS

TREASURE



3851



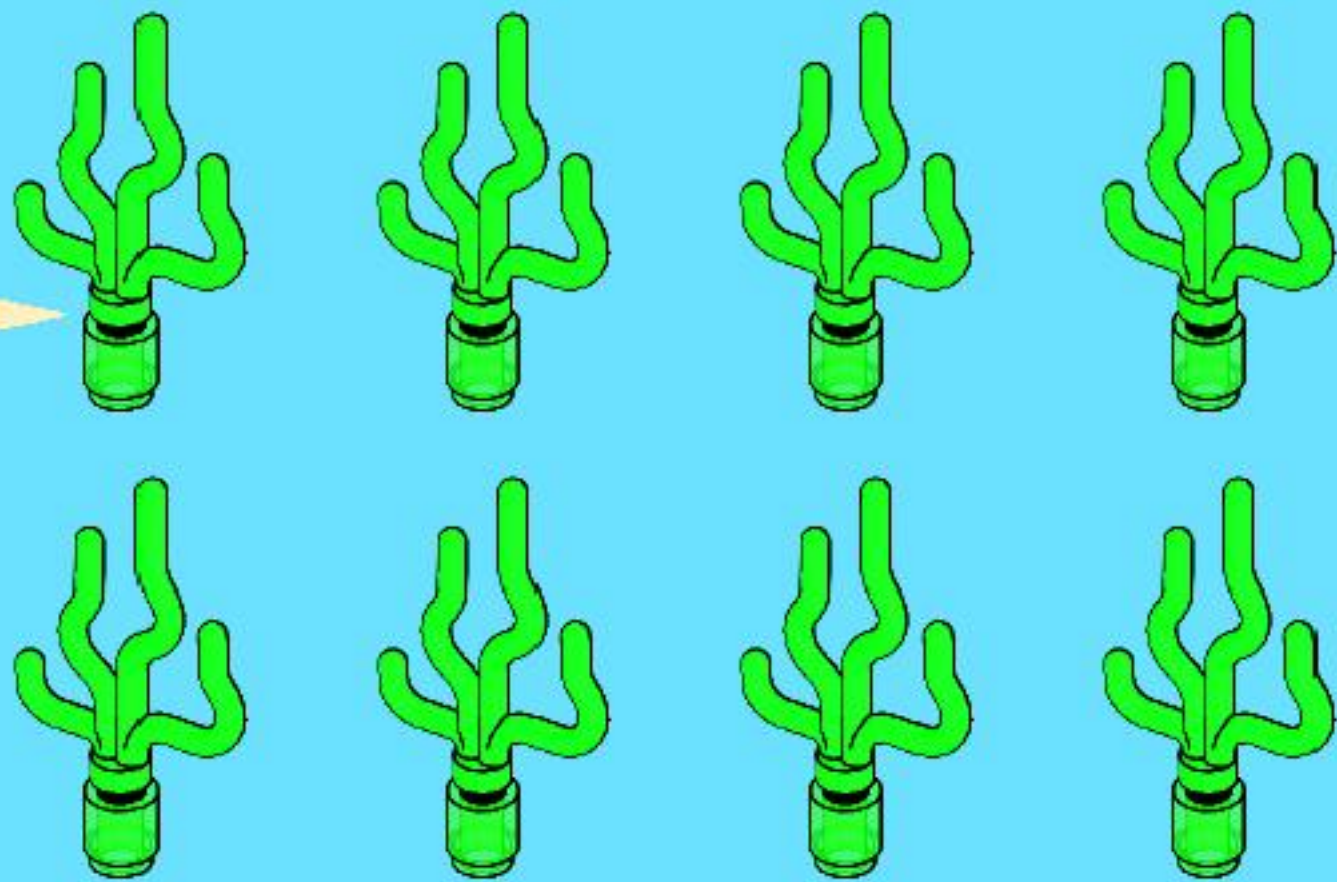
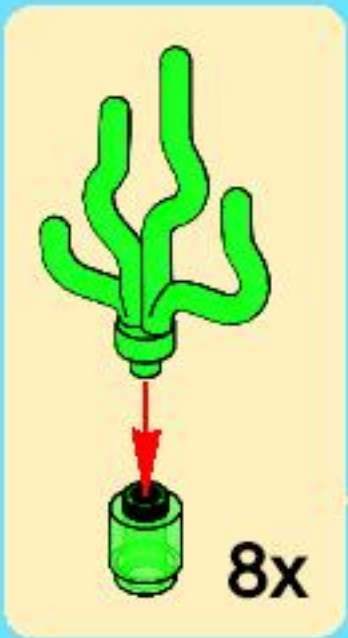
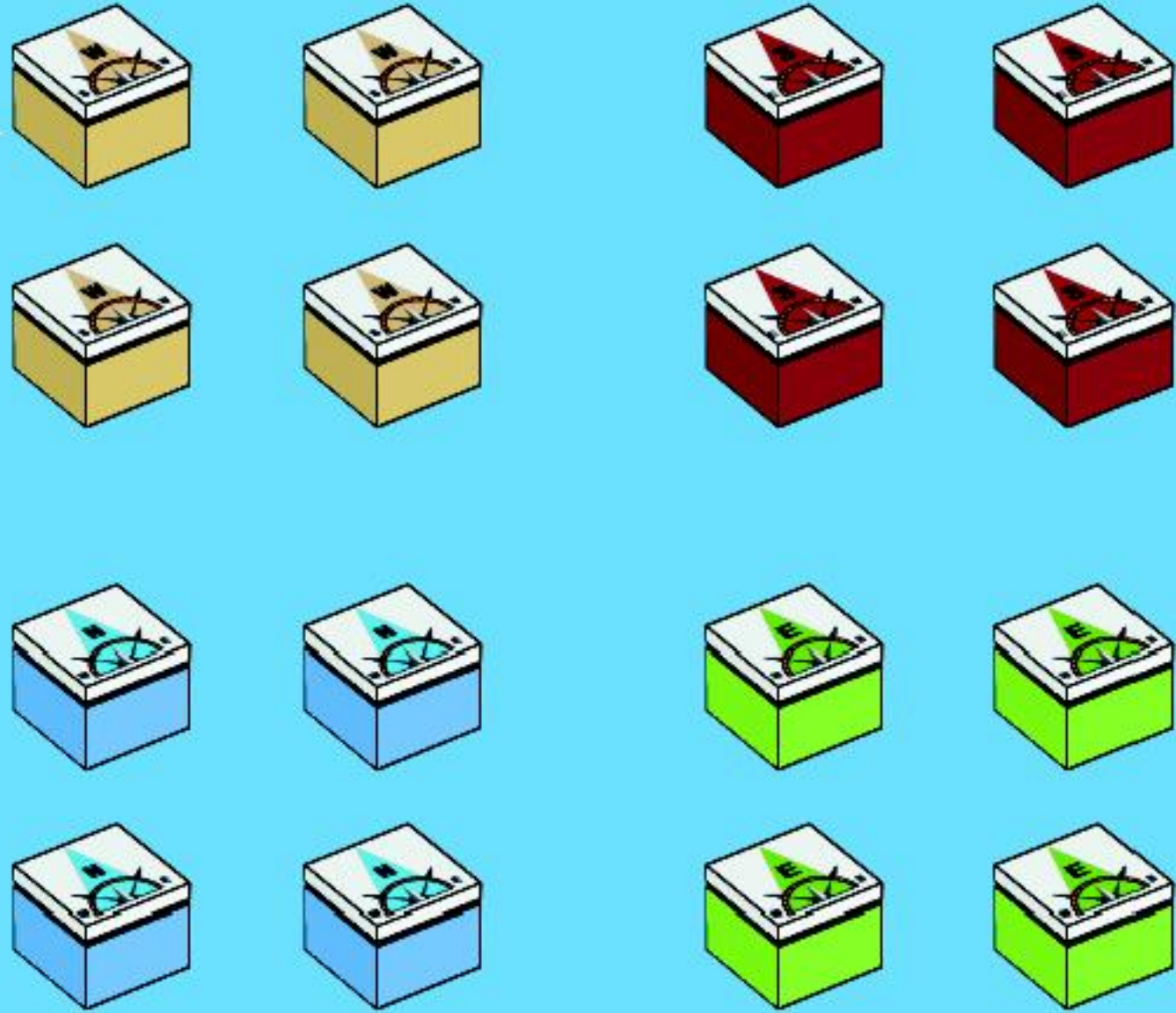
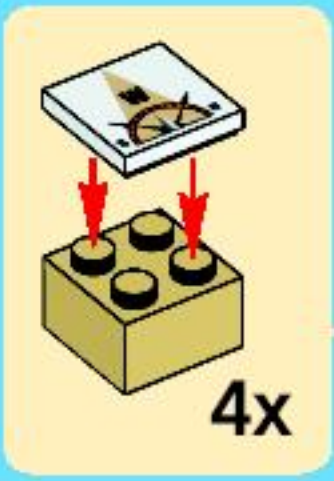

1



2



3



4



5

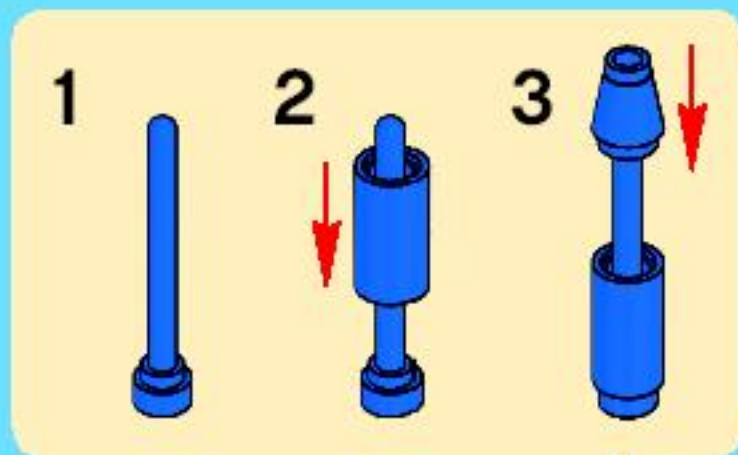

6



1



2



3



4



5



1



2

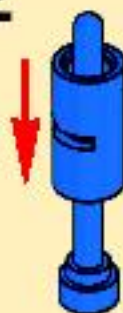

3



6



1



2



3



4



5



6



1



2

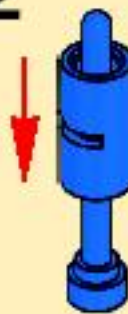

3

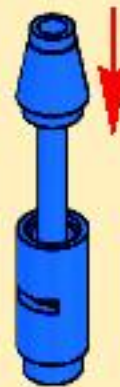

7



1



2



3

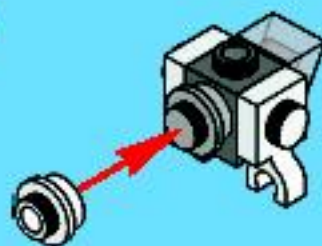

4



5



6



1

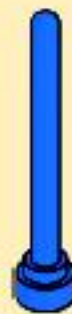

2

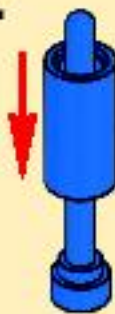

3

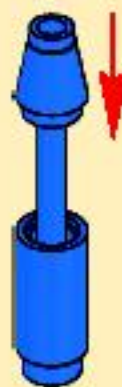

7



1



2

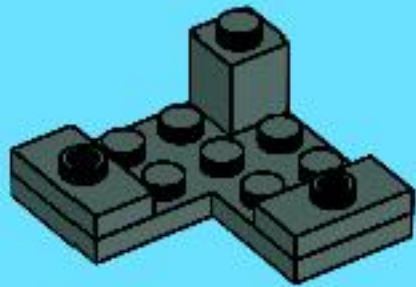

3

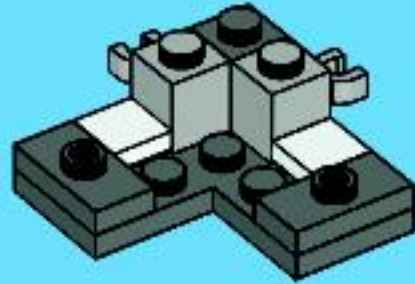

4

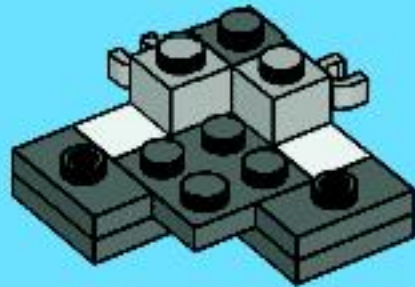

5

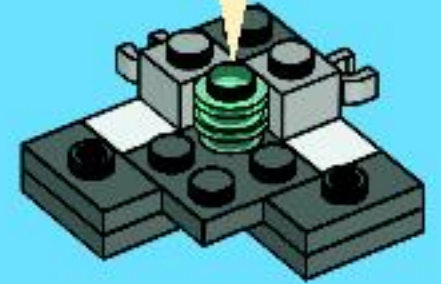

6

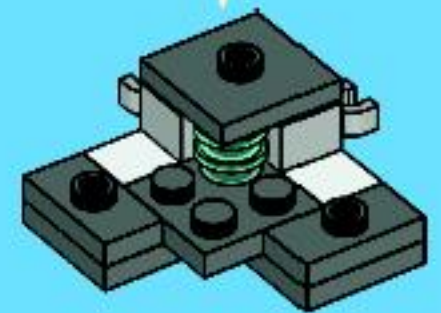
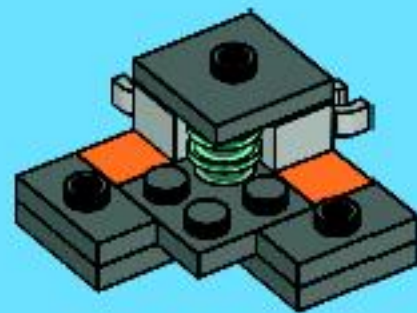
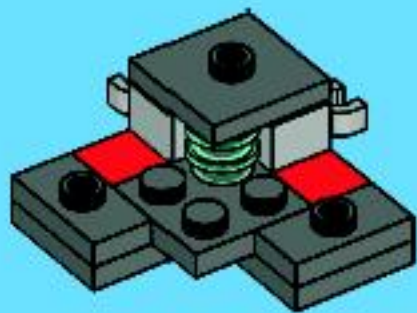
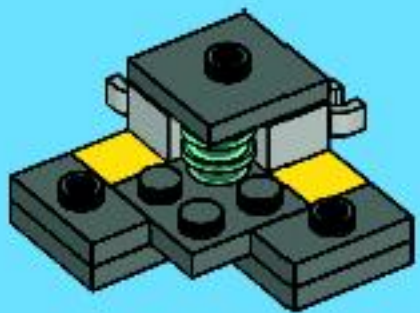
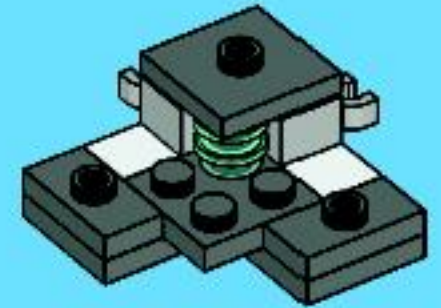



1

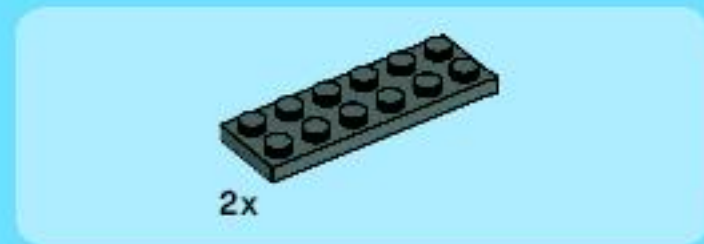

2

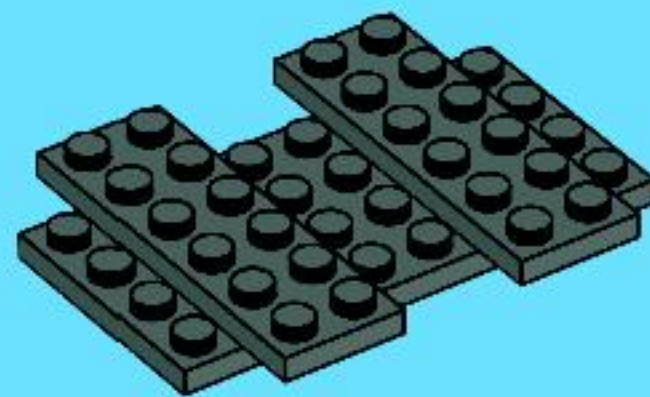

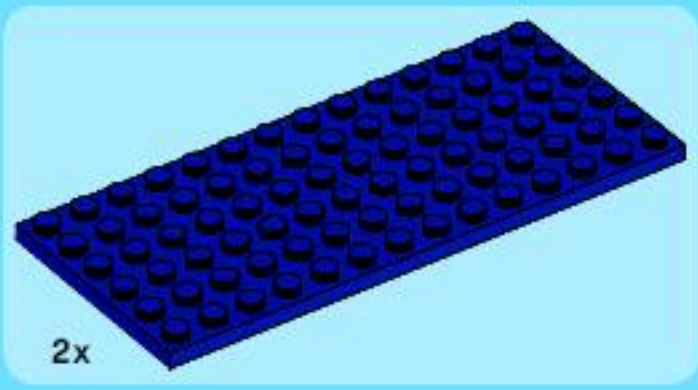

3

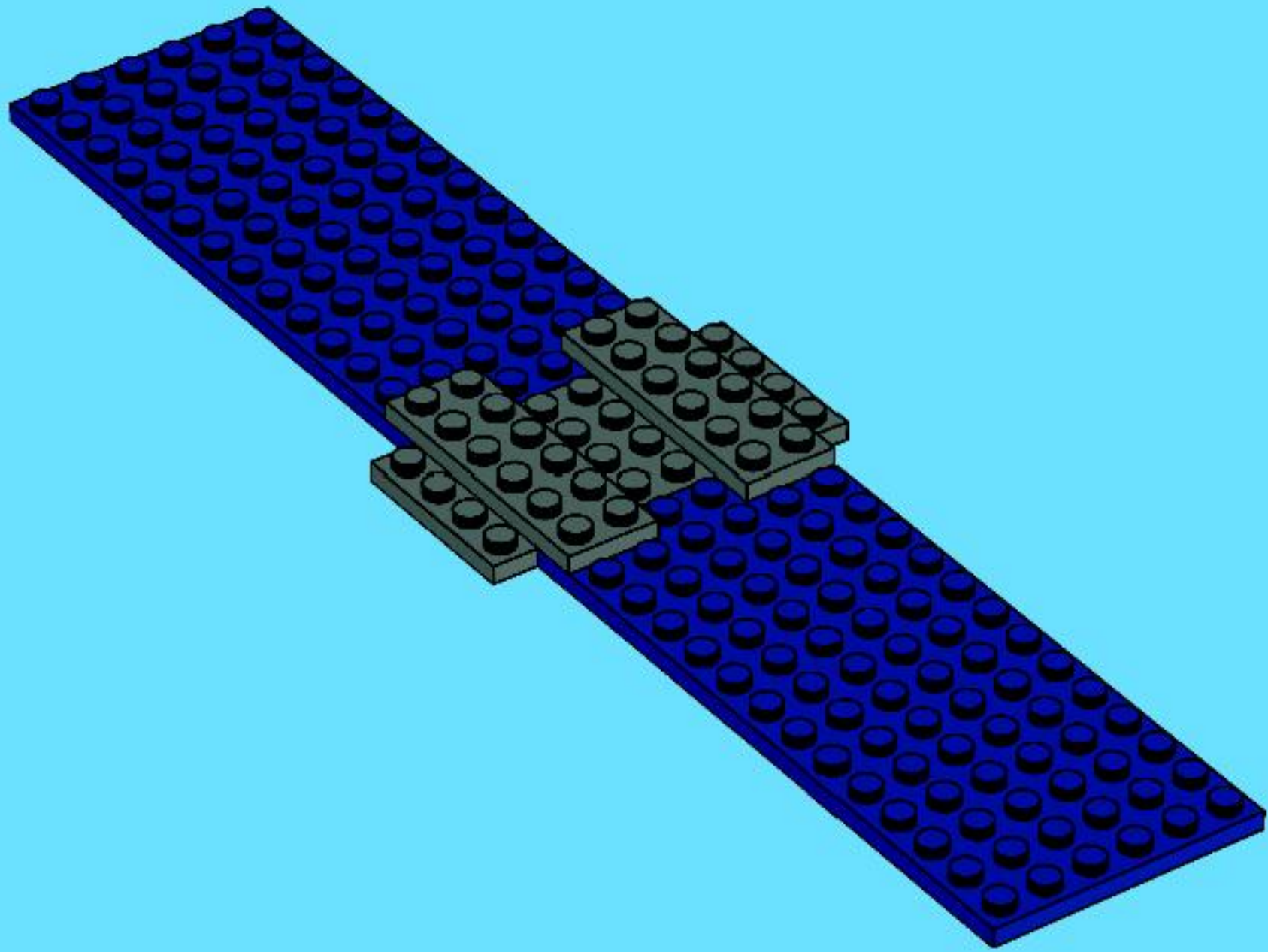

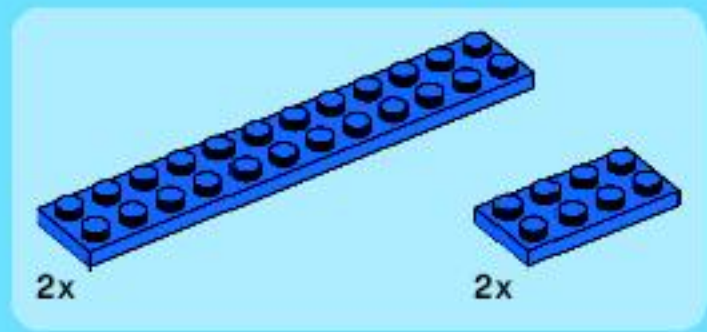

4

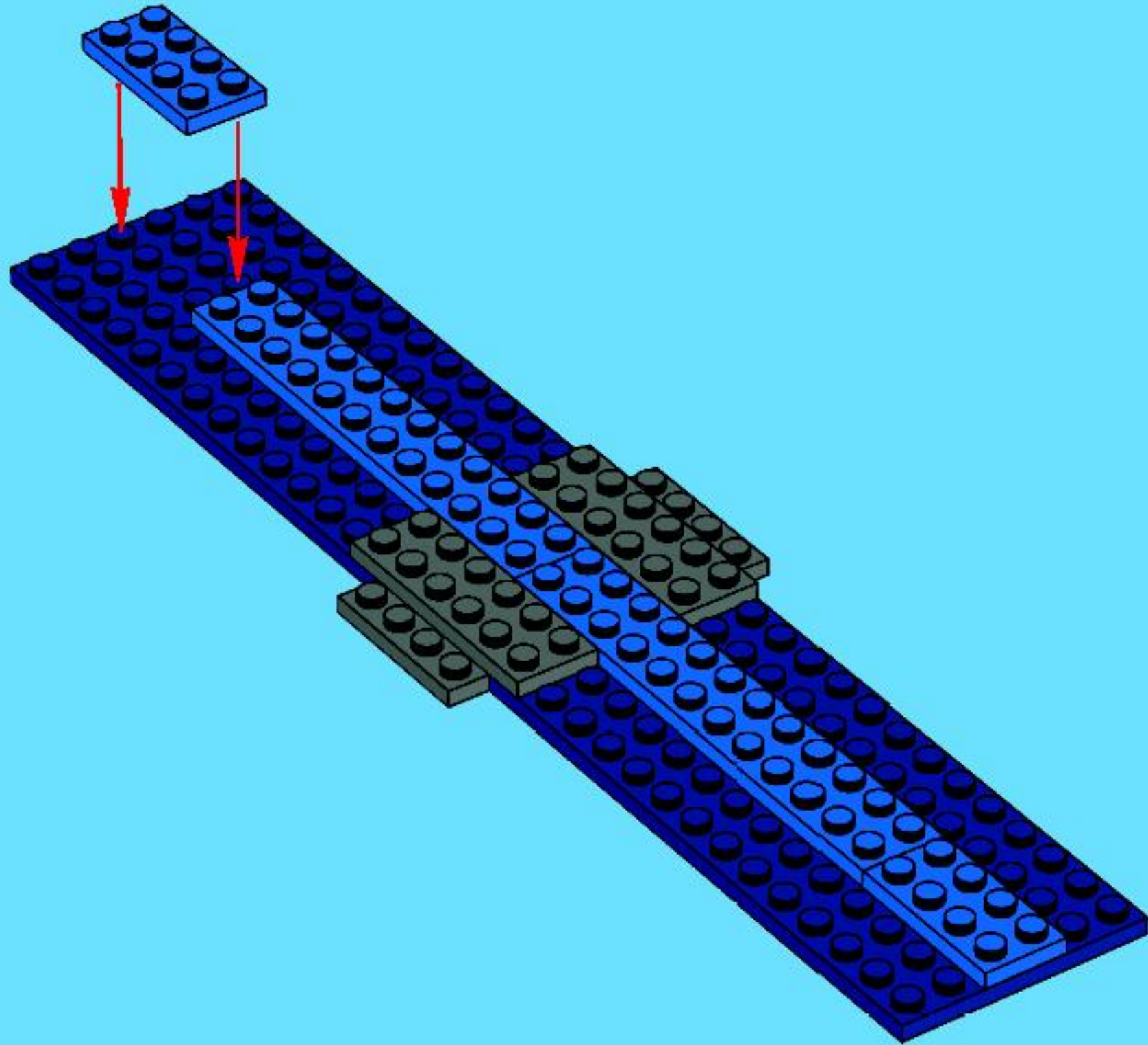

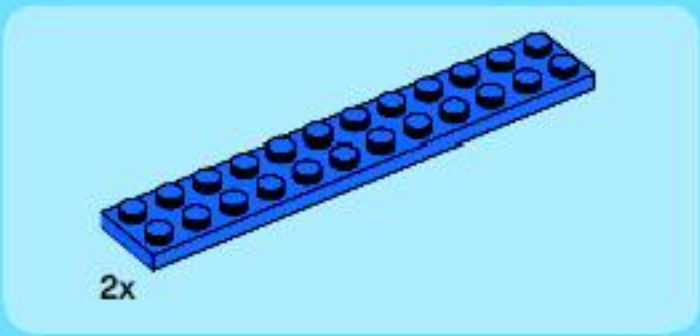

5

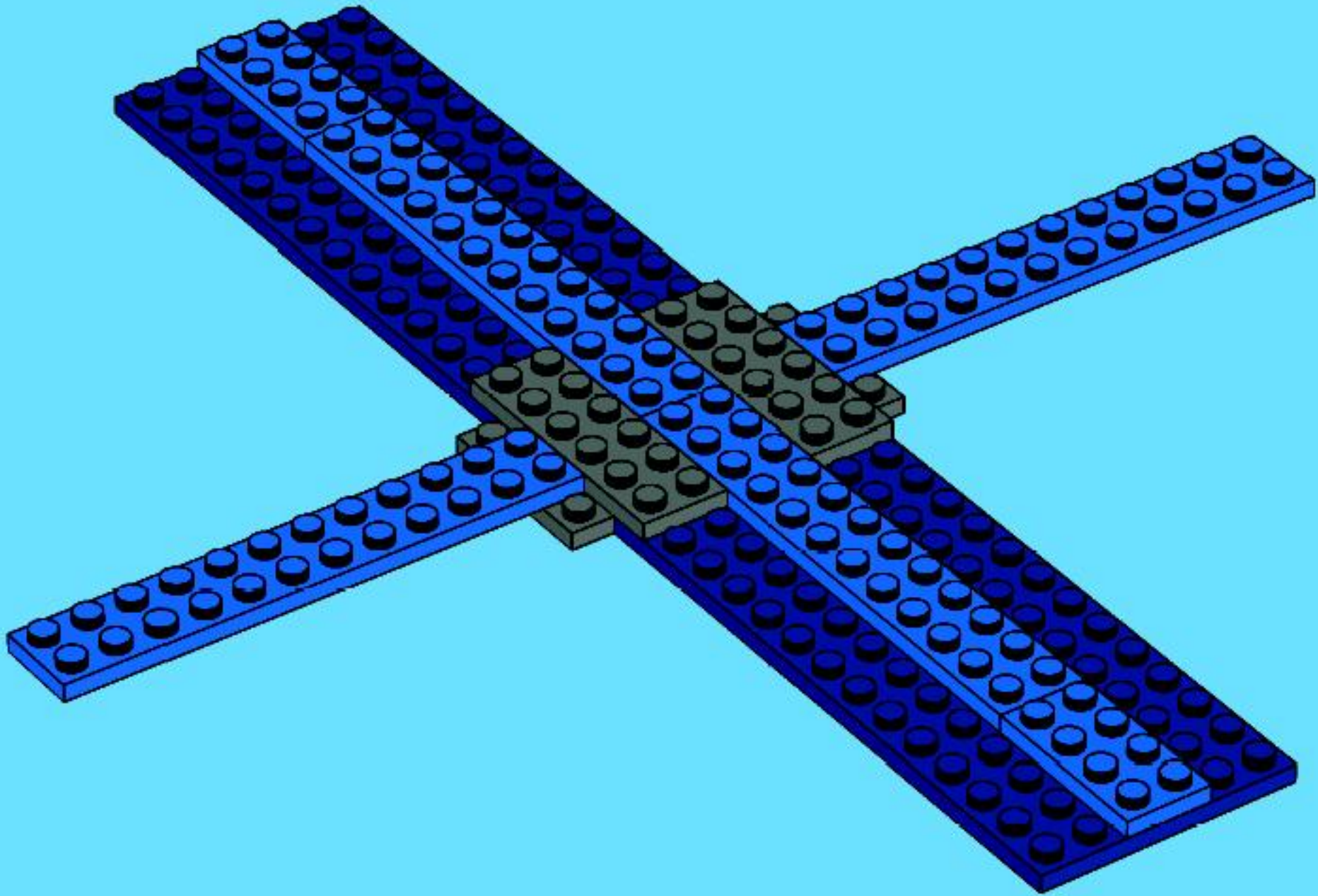

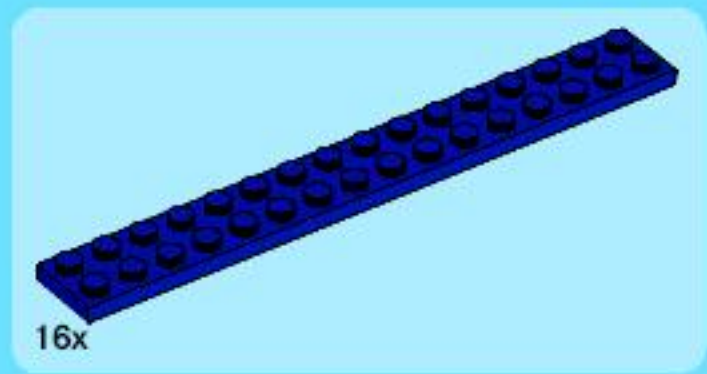

6

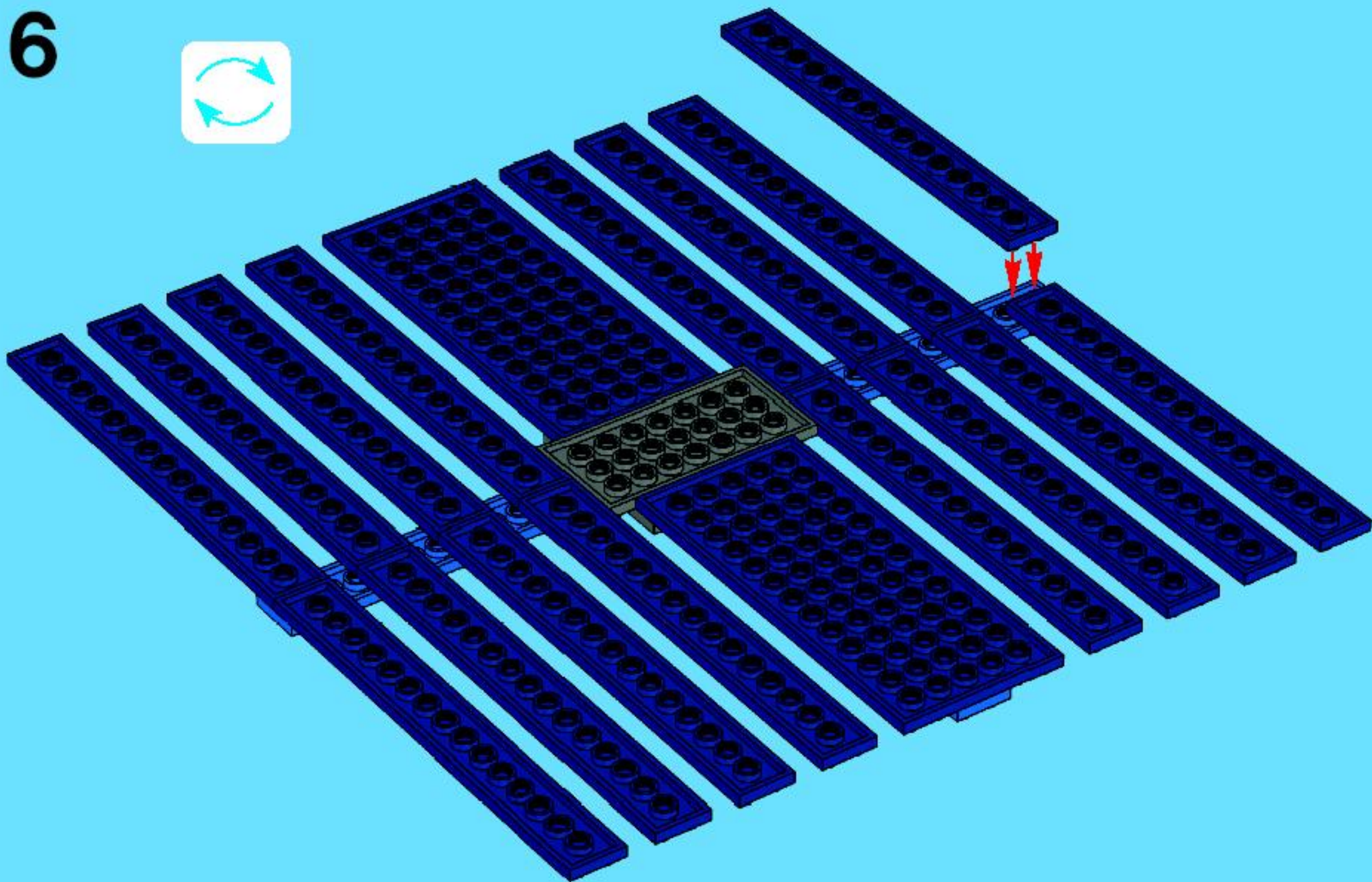

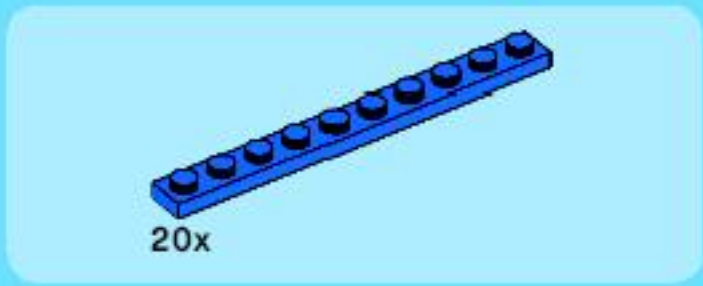

7

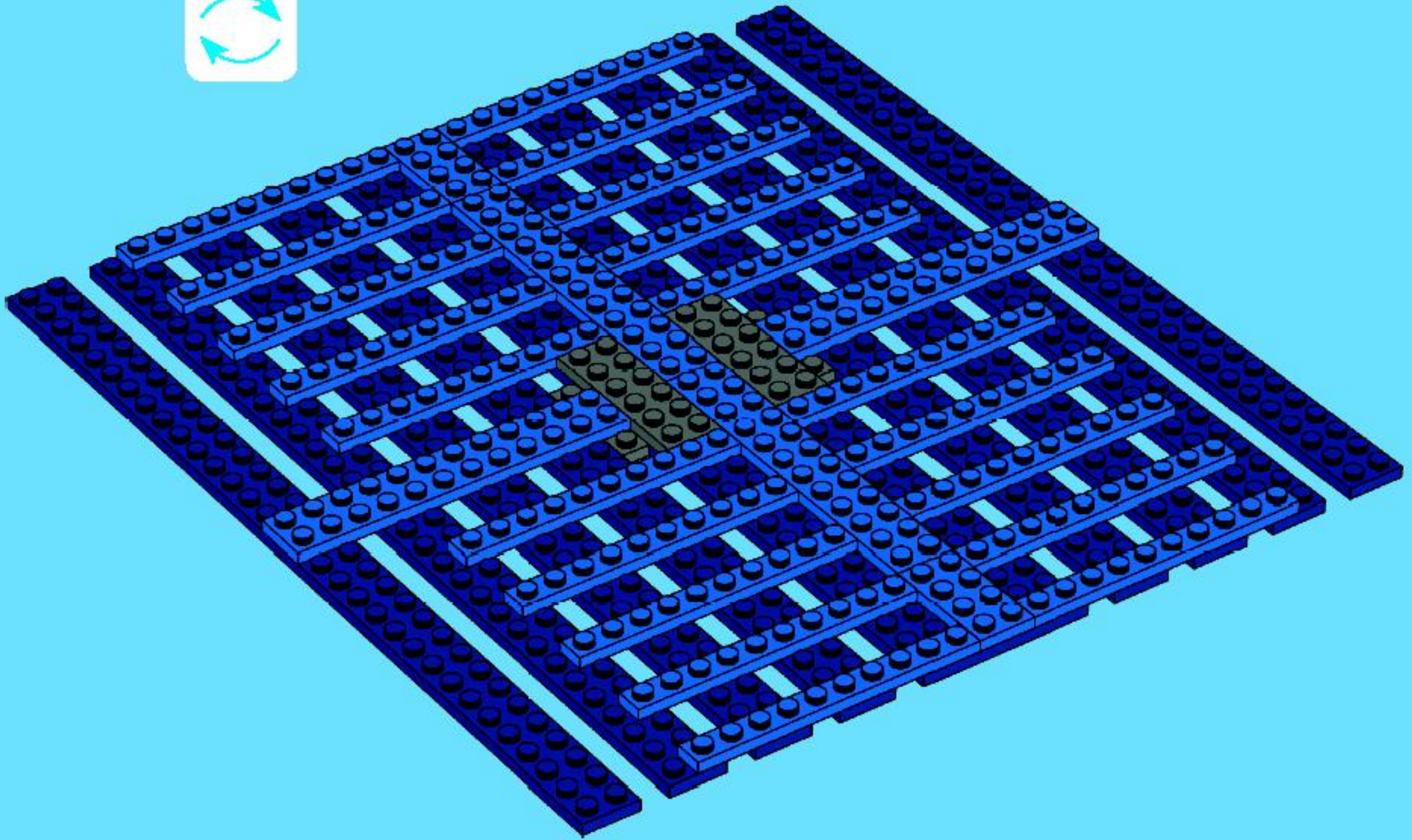



16x

8

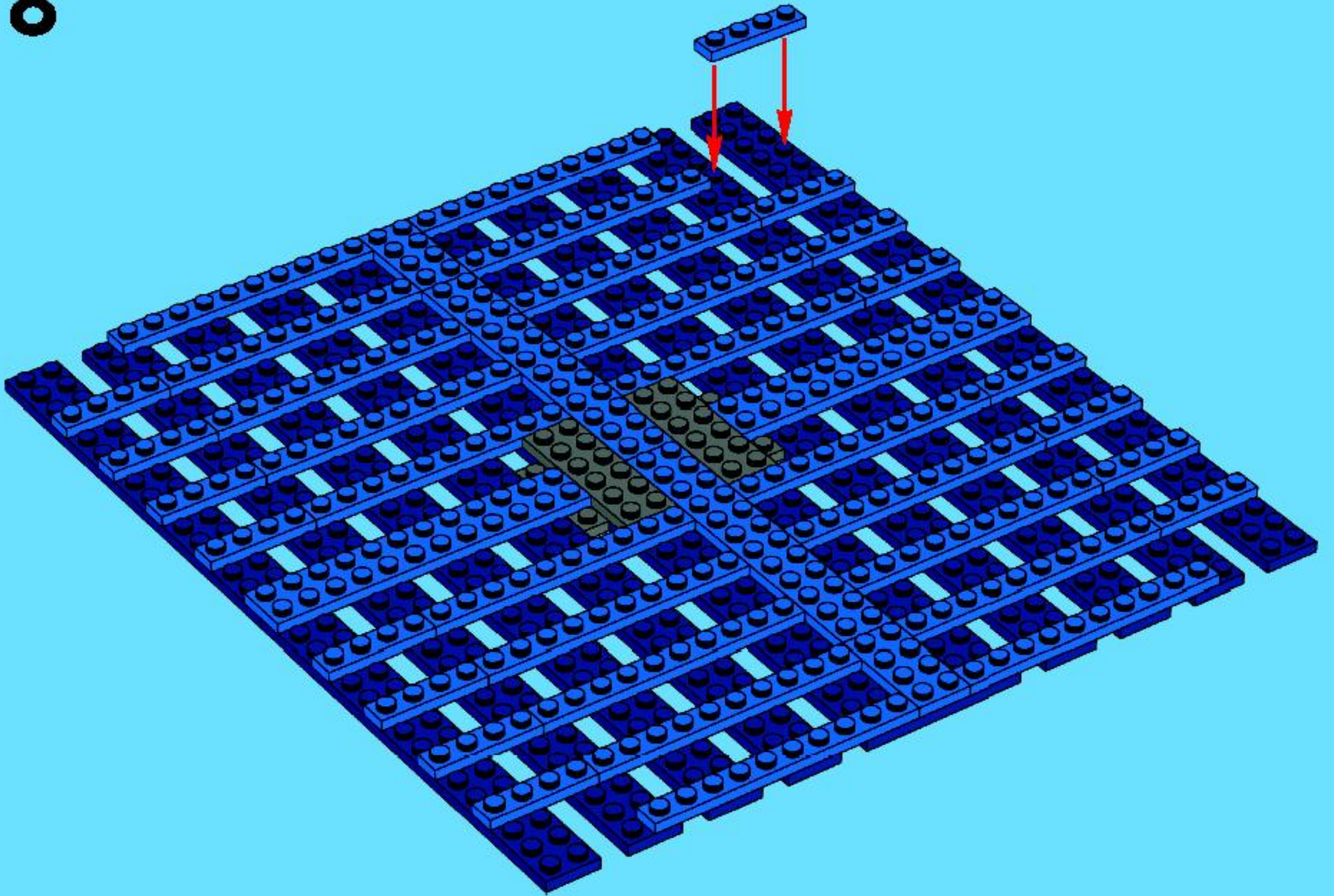

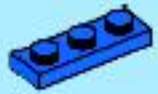

4x

9

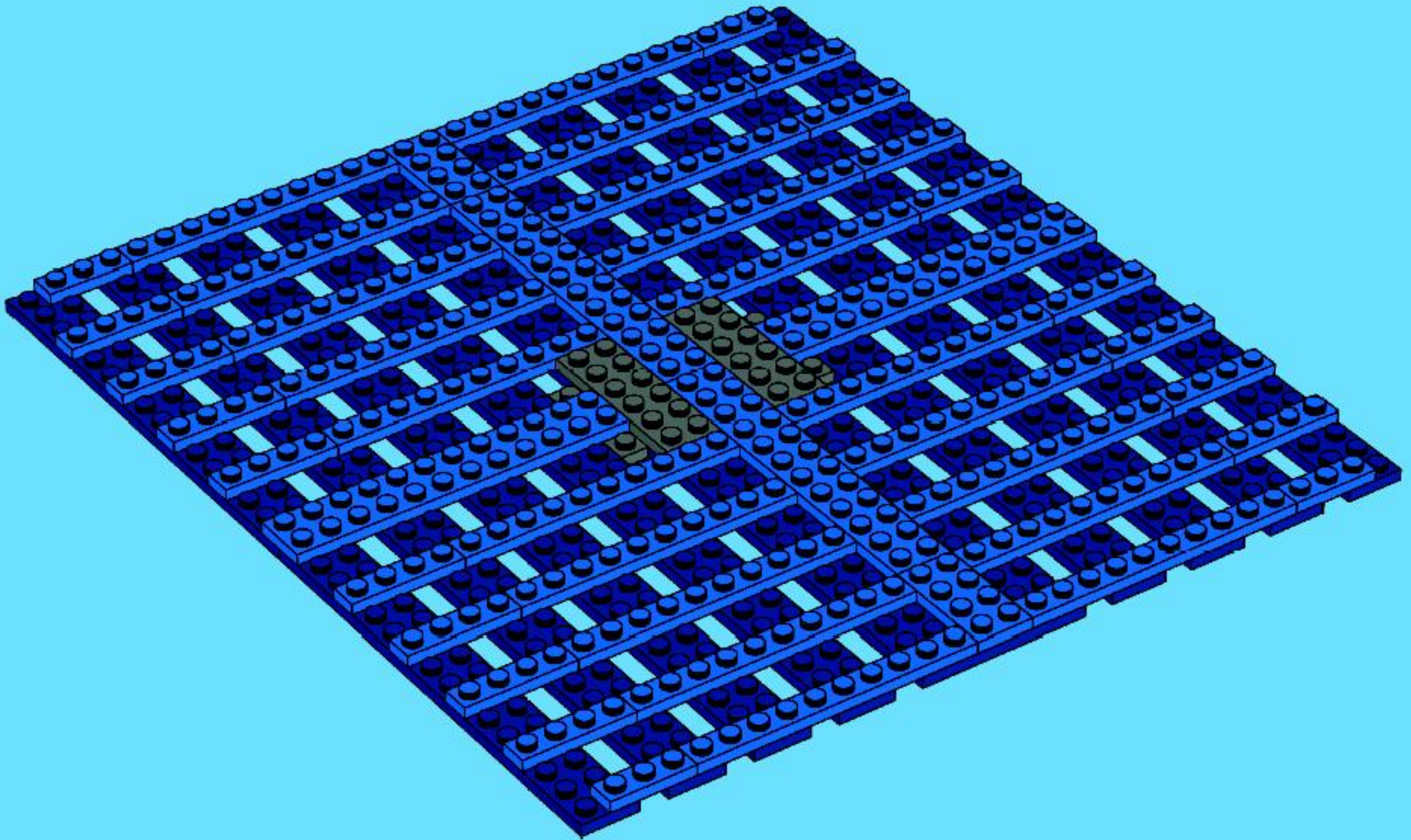



12x



1x

10

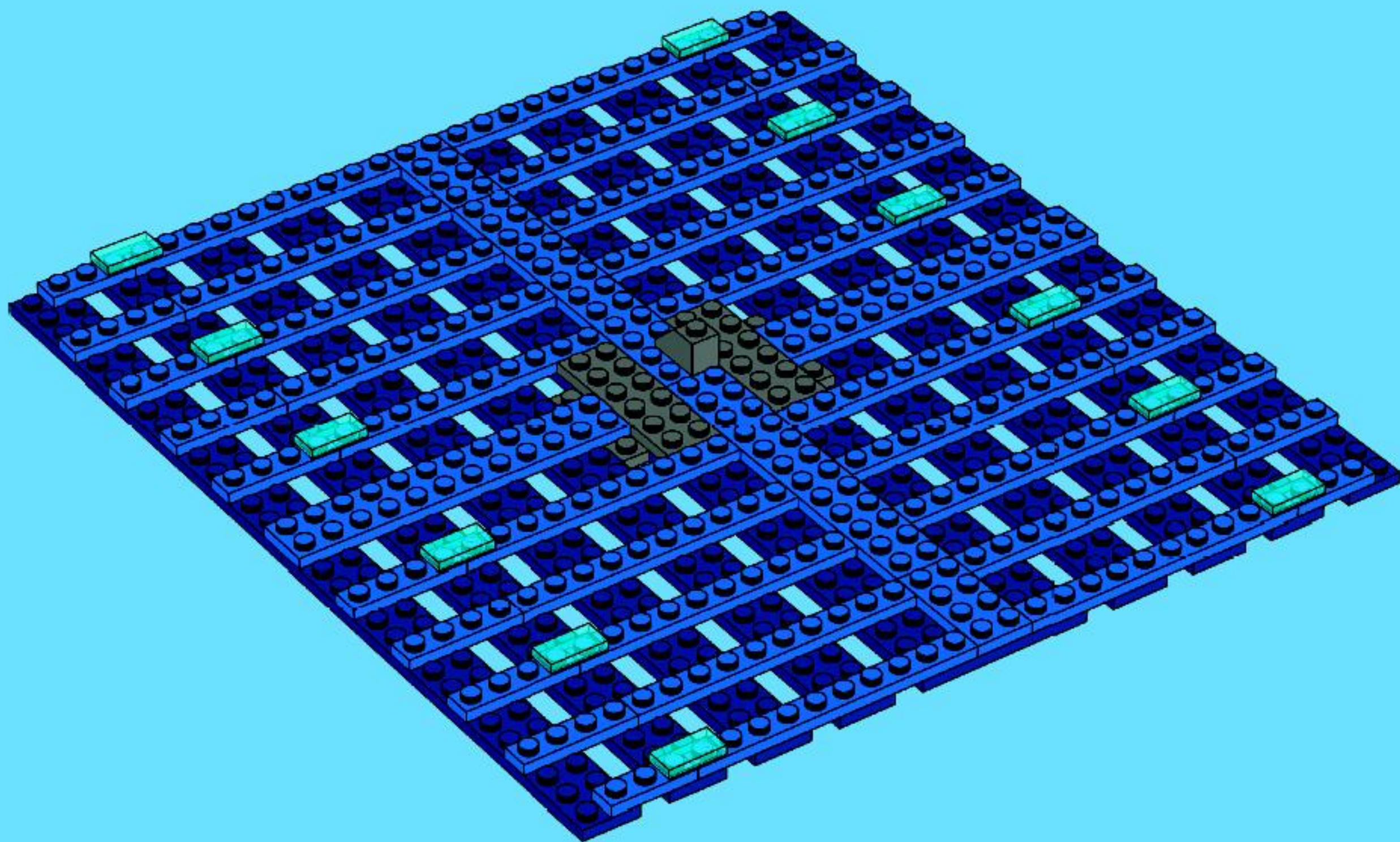



3x

11

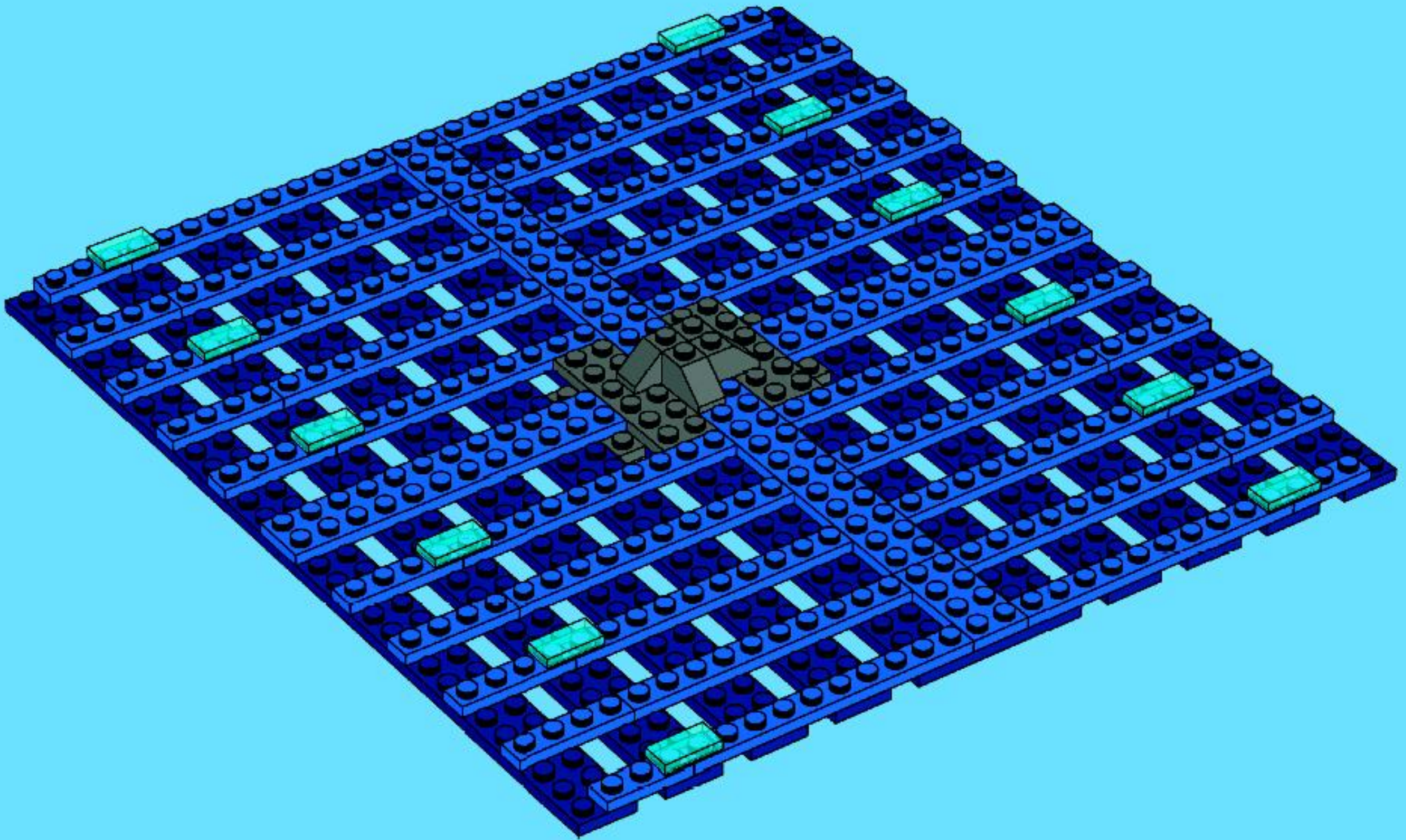



4x

12

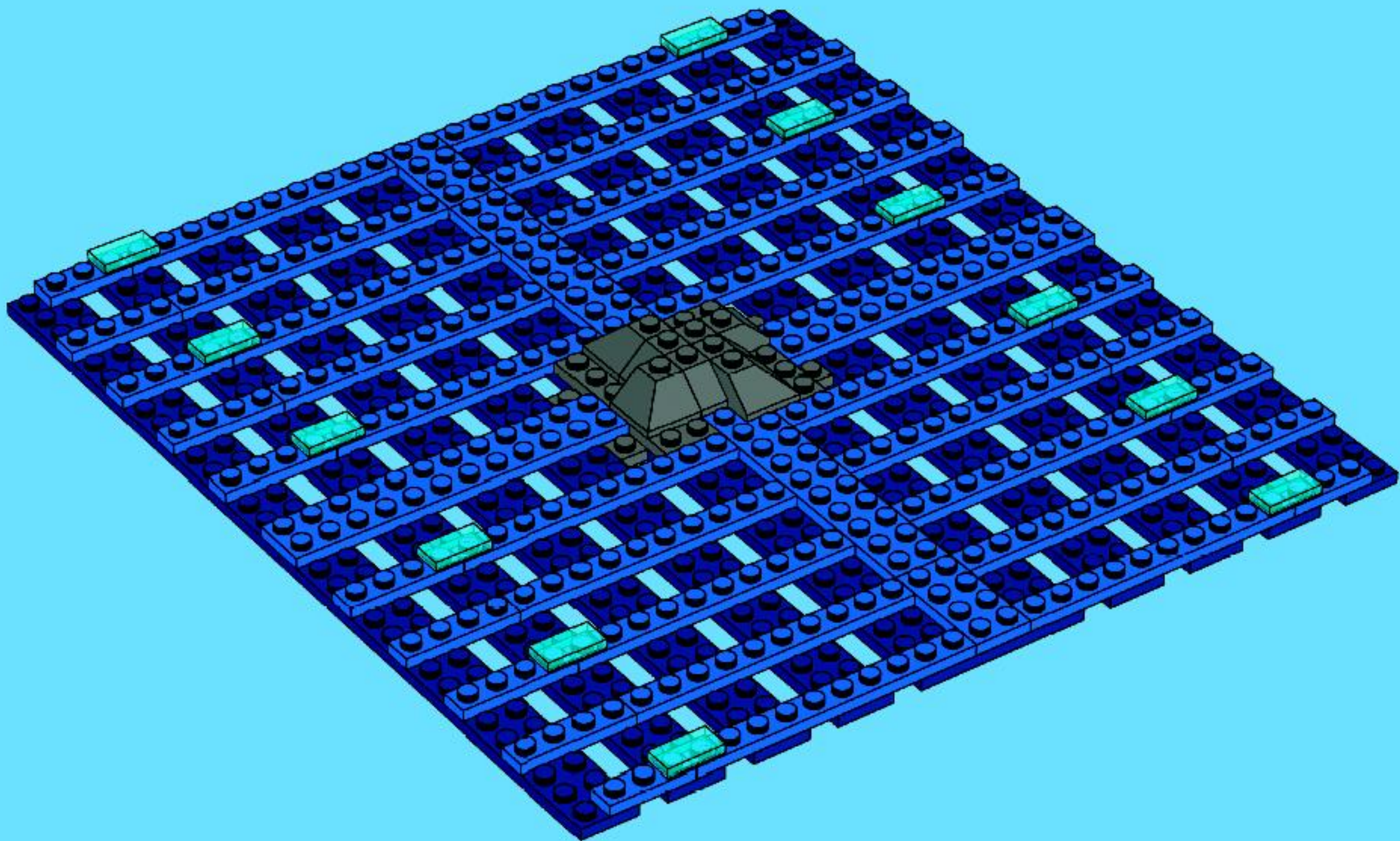

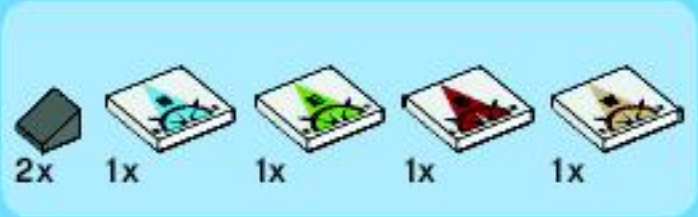

13

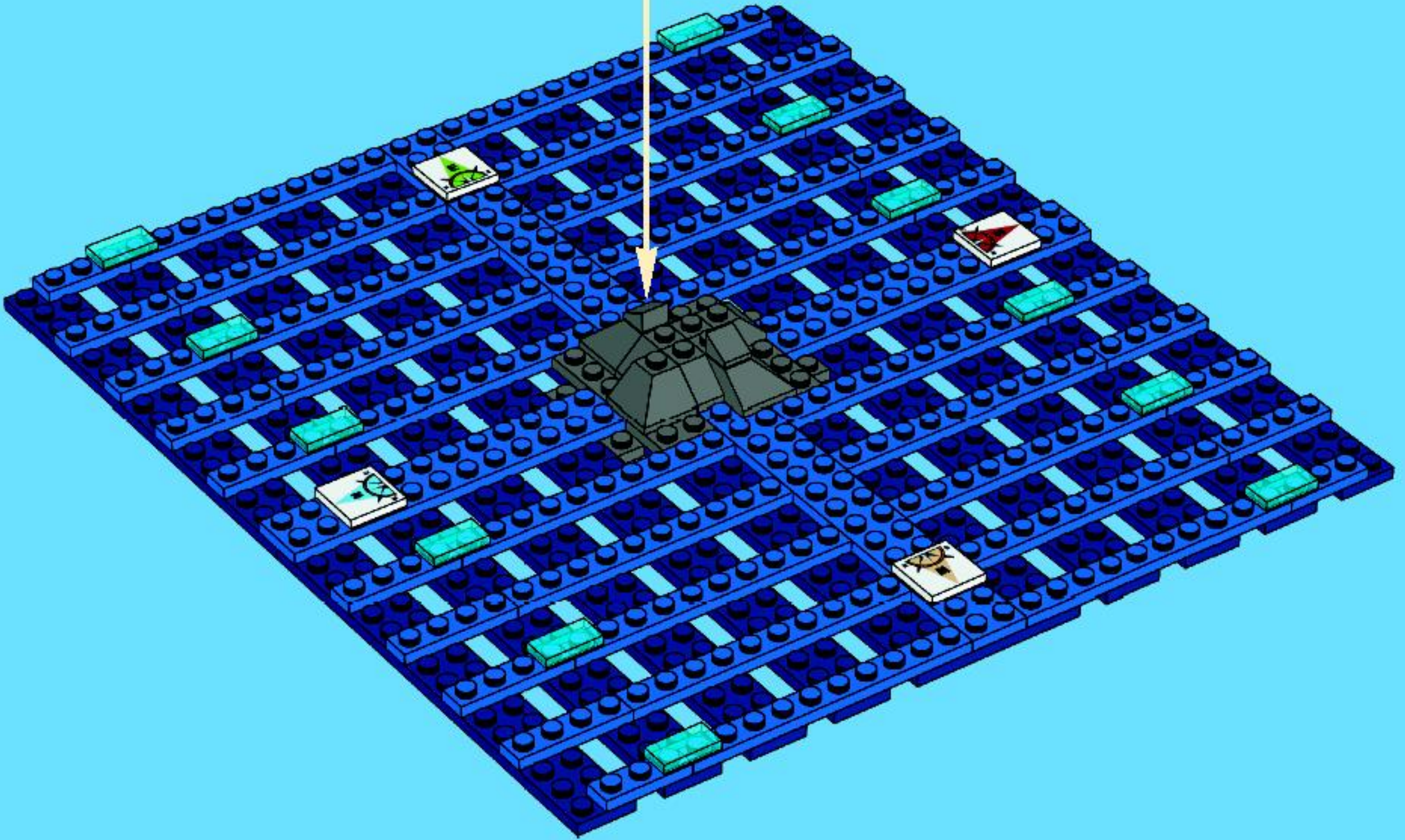



8x



8x

14

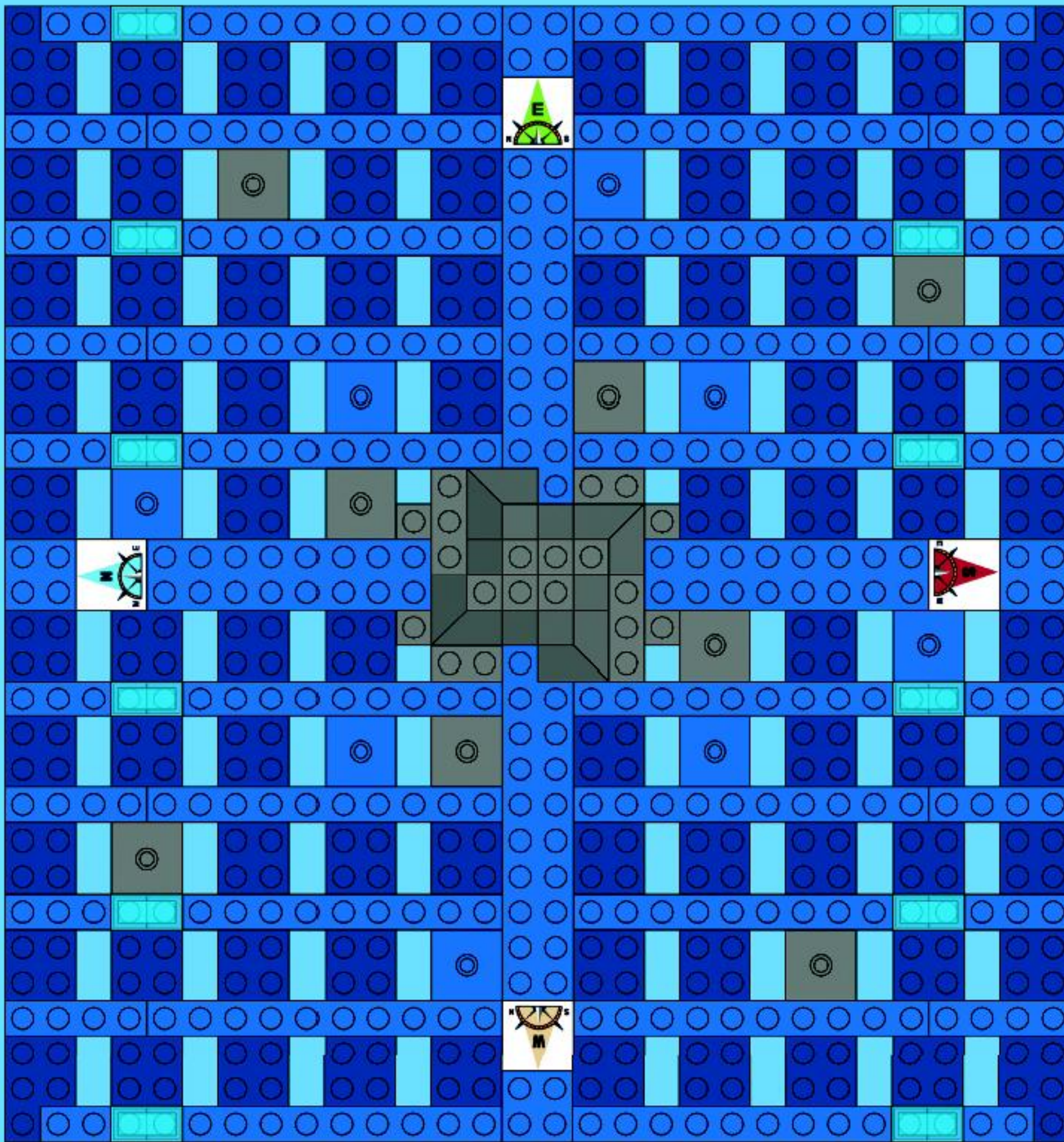

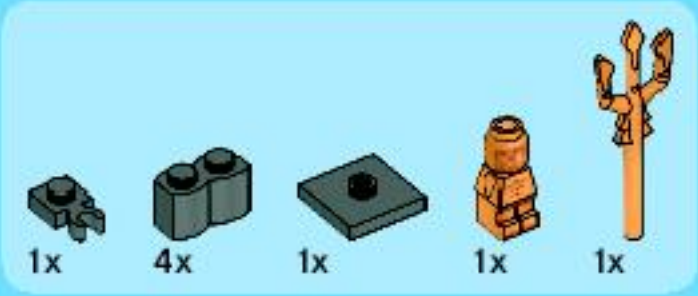

15

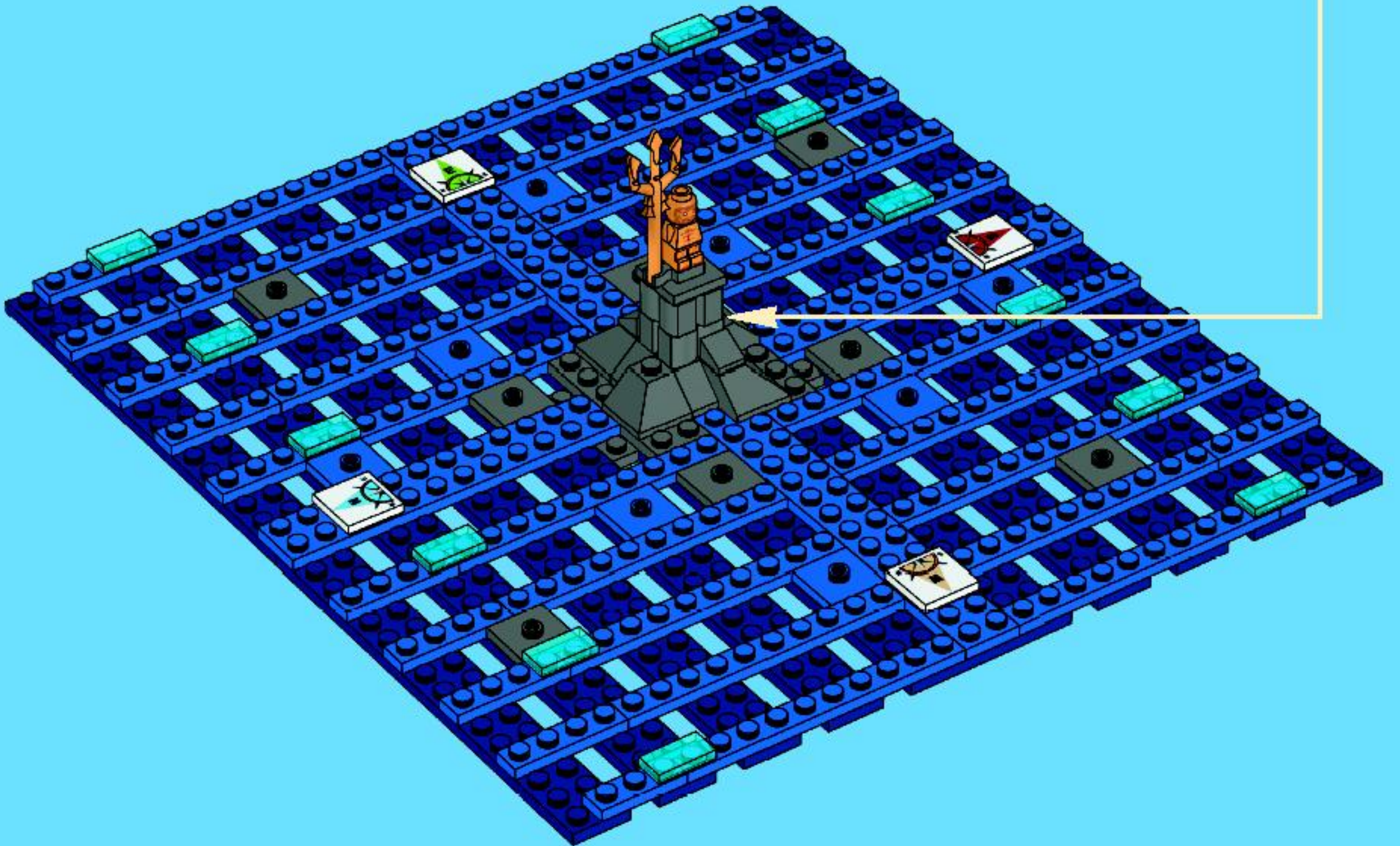
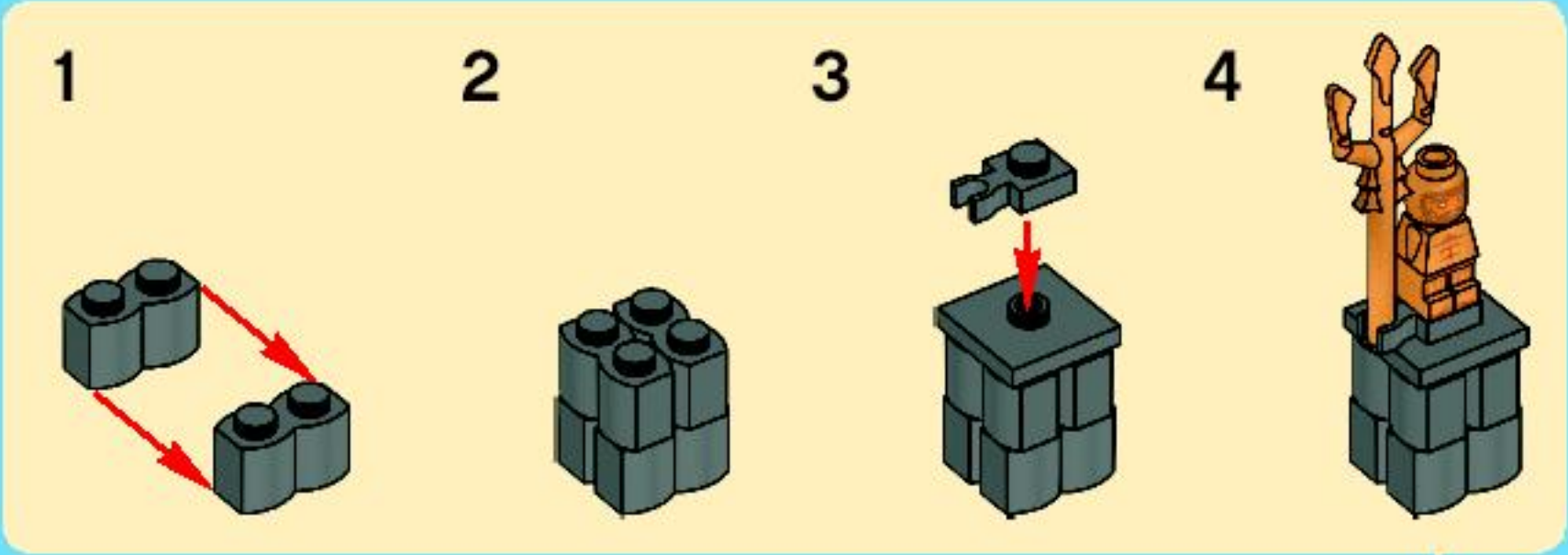



8x

16

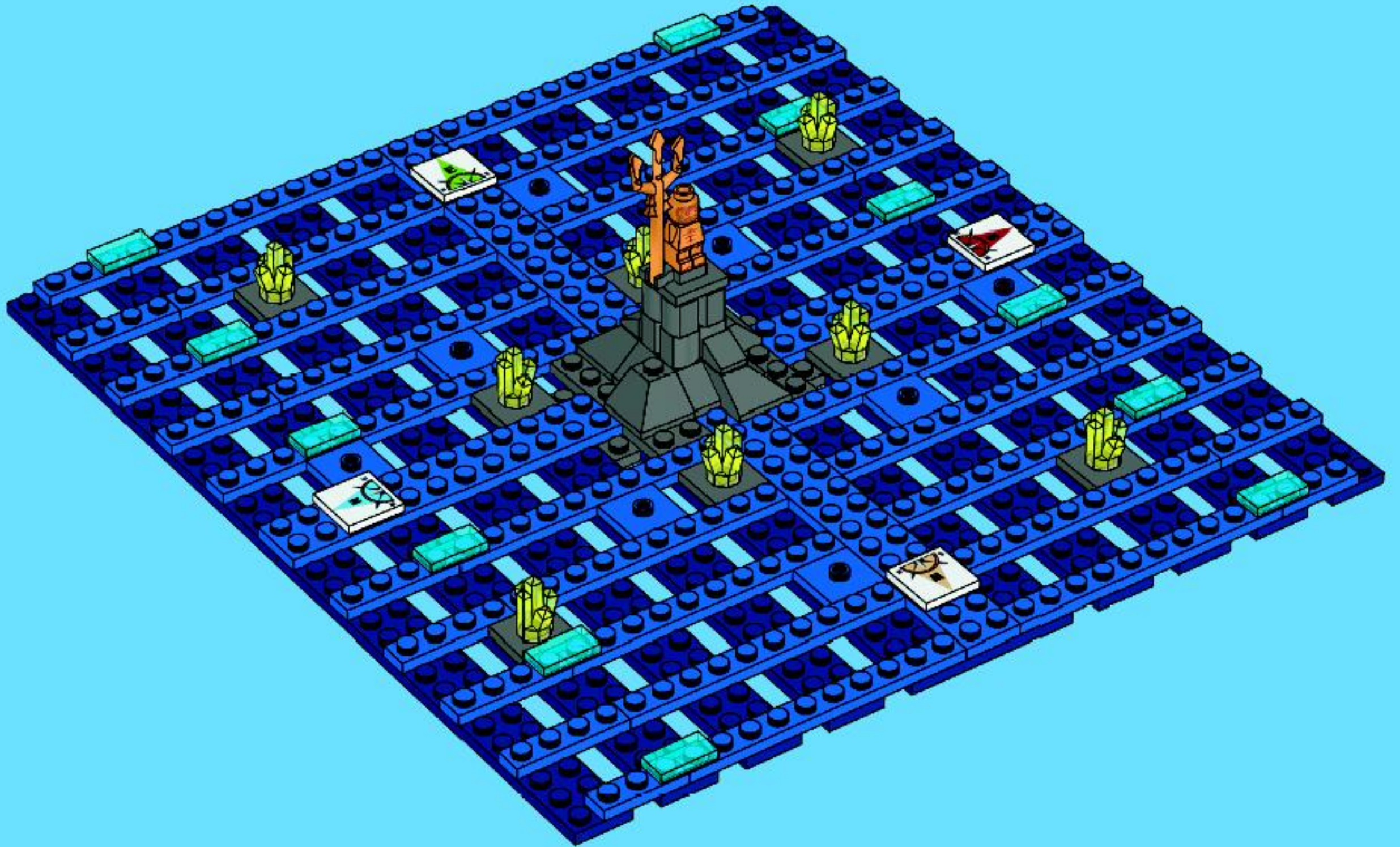

17

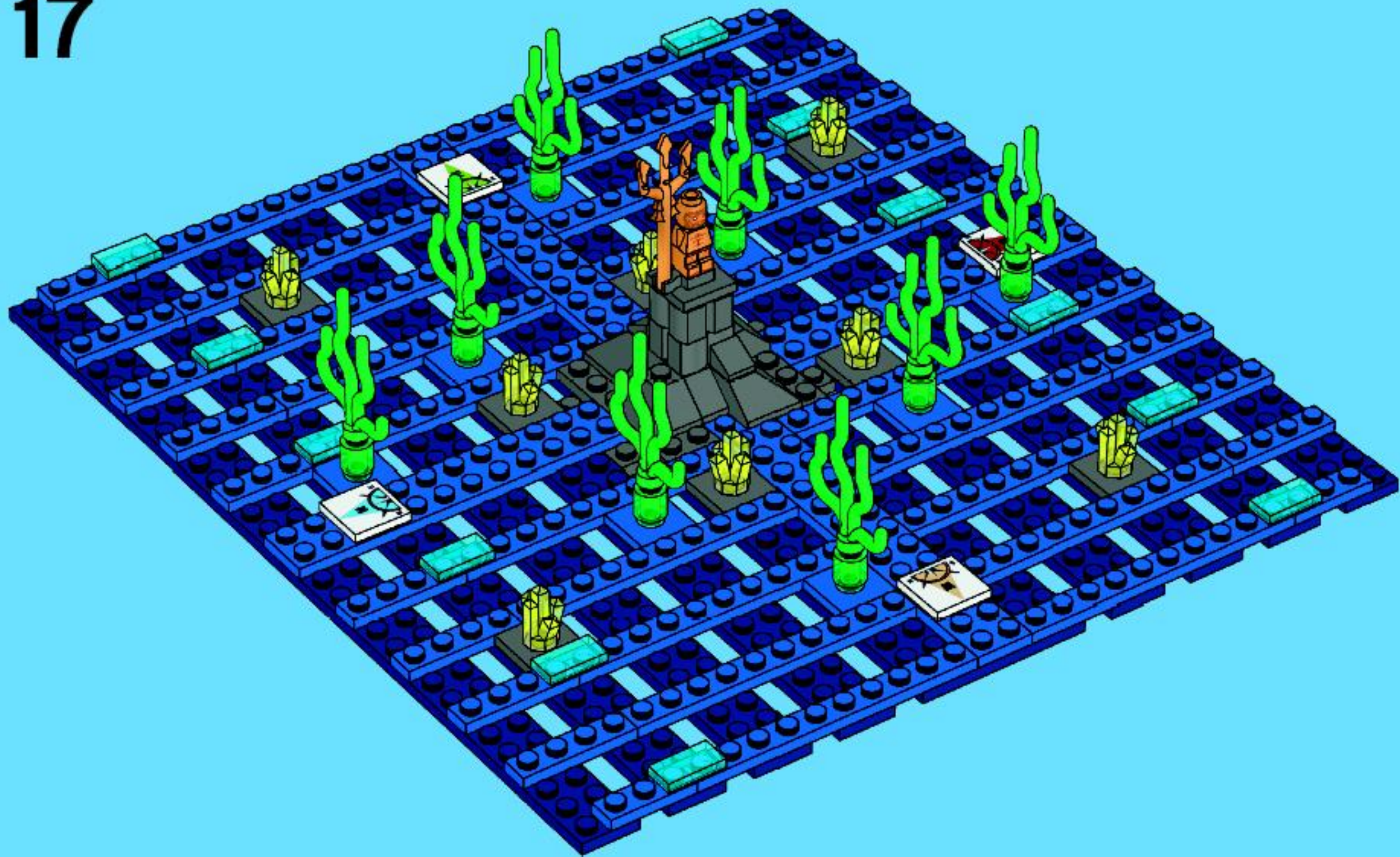

18



19





- 1x 4587212
- 8x 4211119
- 13x 4565322
- 3x 4211051
- 4x 4211098
- 4x 4210700
- 4x 4211095
- 2x 4504378
- 4x 4211135
- 4x 4210646
- 4x 4211094
- 4x 4539429
- 2x 4211002
- 1x 4211061

- 4x 4220632
- 4x 4539104
- 1x 4547649
- 2x 307001
- 6x 4594308
- 6x 4594220
- 6x 4594223
- 6x 4594221
- 1x 4595224
- 2x 4538353
- 1x 4224792
- 4x 4114306
- 8x 3006848
- 8x 4540417

- 2x 307021
- 1x 302321
- 2x 4524644
- 1x 4585146
- 16x 4595189
- 2x 4595163
- 4x 4529235
- 4x 362323
- 8x 4565319
- 4x 4166140
- 16x 371023
- 2x 302023
- 20x 447723
- 4x 244523

- 4x 4595160
- 12x 4113854
- 8x 4163917
- 4x 4244368
- 2x 307024
- 2x 4540040
- 1x 241224
- 1x 4169960
- 1x 4107762
- 8x 4568215
- 4x 4201235
- 2x 4558595
- 2x 4593773
- 1x 4157103

- 8x 4533772
- 1x 4211398
- 1x 4211525
- 8x 4539481
- 2x 4211701
- 1x 400626
- 1x 4539364
- 1x 4290713
- 1x 4594202
- 1x 4595077

Customer Service
Kundenservice
Service Consommateurs
Servicio Al Consumidor

www.lego.com/service or dial

: 00800 5346 5555
 : 1-800-422-5346





3848
Pirate Plank
2-4 7+ 10-20



3849
Orient Bazaar
2-4 7+ 10-20



3862
Harry Potter™ Hogwarts™
2-4 8+ 20-40



games.LEGO.com



games.LEGO.COM





Harry Potter™ HOGWARTS™



3862
Harry Potter™ Hogwarts™



2-4



8+



20-40

TM & © Warner Bros. Entertainment Inc.
(©10)





WIN!

Go to www.nielsen.com/LEGO
to fill out a survey for a chance
to win a cool LEGO® Product.
No purchase necessary.
Open to all residents where not prohibited.



www.nielsen.com/LEGO

GEWINNE! WIN!

Nimm an der Umfrage auf
www.nielsen.com/LEGO
teil und hab die Chance ein cooles
LEGO® Produkt zu gewinnen!

Die Teilnahme am Gewinnspiel führt zu keinerlei
Kaufverpflichtungen. Teilnahme in allen nicht
ausgeschlossenen Ländern möglich.

4598887

Ga naar www.nielsen.com/LEGO,
vul een enquêteformulier in en
maak kans op een
cool LEGO® product.

Geen aankoopverplichting.
Iedereen mag deelnemen, uitgezonderd
ingezetenden
van landen waar een enquêteverbod geldt.

GAGNE! 当てよう!

Visite www.nielsen.com/LEGO
pour répondre à un questionnaire
et avoir une chance de gagner
un produit LEGO® très cool!

Aucune obligation d'achat.
Ouvert à tous les résidents des pays
autorisés.

www.nielsen.com/LEGOにアクセスして、アンケ
ートにご記入ください。当選者にはレゴ製品を
差し上げます。

お買い上げの必要はありません。

禁止されていない限り、すべての年齢にご利用いただけます。