

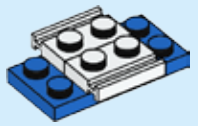

1



2



3

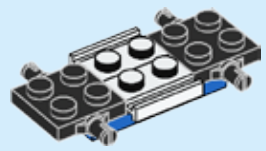

4



5

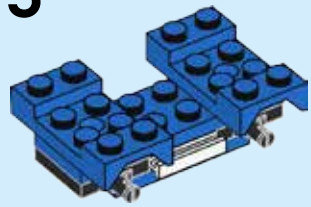

6

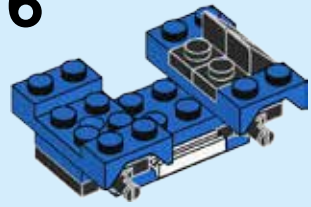

7

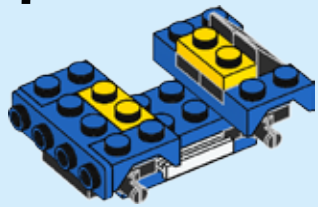

8

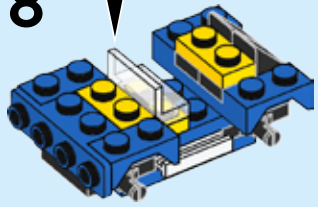

9

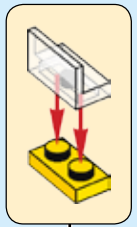
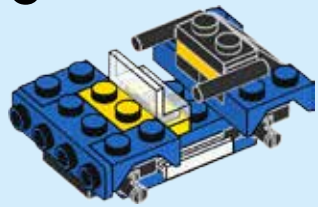

10

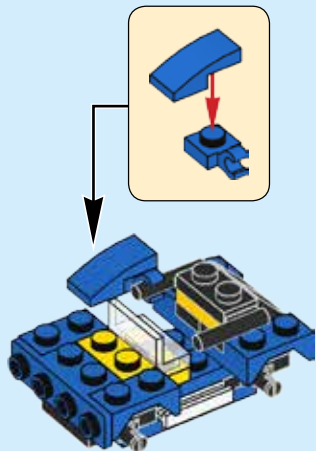

11

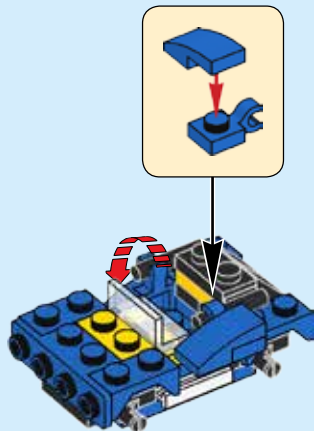

12

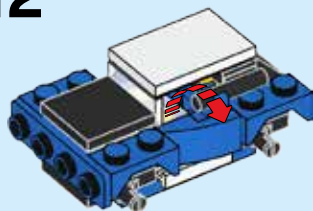

13

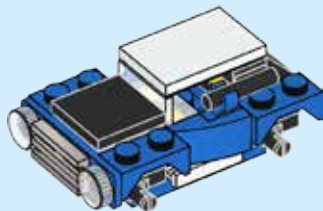

14

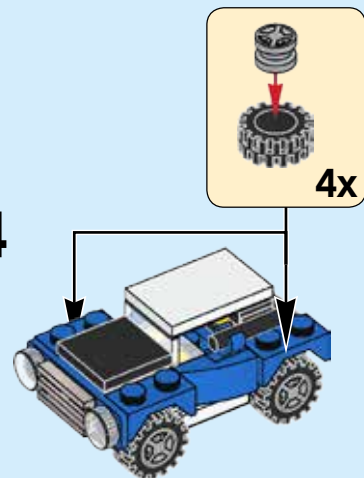

LEGO.com/service

LEGO and the LEGO logo are trademarks of the LEGO Group.
©2017 The LEGO Group.

6188846