



MINECRAFT

21255



Q LEGO® Builder



Get excited about our new packaging!

We're switching from plastic to paper-based packaging. That's why you might find a mix of paper and plastic in our boxes!

Nos nouveaux emballages vous emballeront !

Nous passons des emballages en plastique aux emballages à base de papier. C'est pourquoi vous pourriez trouver un mélange de papier et de plastique dans nos boîtes !

¡Te presentamos nuestros nuevos empaques!

Estamos sustituyendo las bolsas de plástico por bolsas con base de papel. ¡Por eso, puedes encontrar una mezcla de papel y de plástico en nuestras cajas!

[LEGO.com/sustainable-packaging](https://www.lego.com/sustainable-packaging)

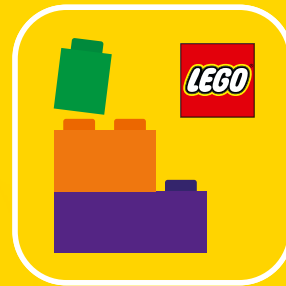

BUILDER



Apple and the Apple logo are trademarks of Apple Inc., registered in the U.S. and other countries and regions. App Store is a service mark of Apple Inc. Google Play and the Google Play logo are trademarks of Google LLC. Tencent and the Tencent logo are trademarks of Tencent Inc.

LEGO.com/devicecheck

EN Ask parents' permission before going online | DE Eltern um Erlaubnis bitten, bevor du online gehst | FR Demande l'autorisation d'un parent avant d'aller en ligne | IT Chiedi il permesso ai tuoi genitori prima di andare online | ES Pídeles permiso a tus papás antes de conectarte a Internet | PT Peça autorização aos pais antes de acederes online | ZH 上网前应先征得父母的同意 | PL Poproś rodziców o zgodę, zanim wejdiesz do Internetu | CS Než půjdeš na internet, požádej rodiče o svolení | SK Skôr než pôjdeš na internet, vypýtaj si povolenie od rodičov | HU Kérj szülői engedélyt, mielőtt online csatlakoznál! | RO Cere permisiunea părinților înainte de a te conecta online | BG Поискайте разрешение от родител, преди да влезете онлайн | LV Pirms došanās tiešsaistē palūdz atļauju vecākiem | ET Enne Interneti kasutamist küsi vanematelt luba | LT Prieš prisijungdami prie interneto, atsilkauskite tėvų



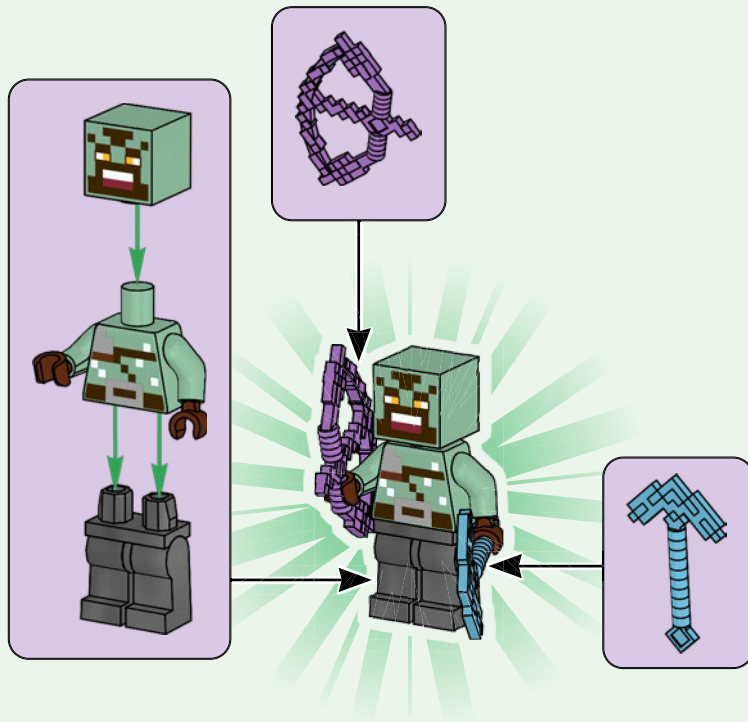

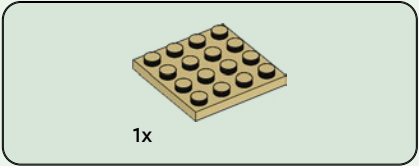
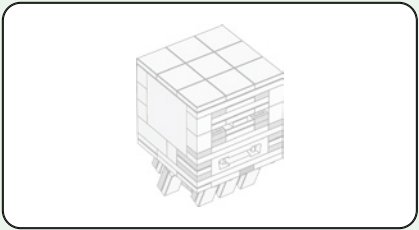

1

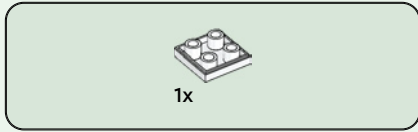

2

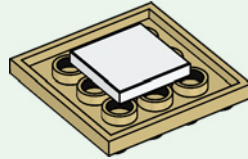

3

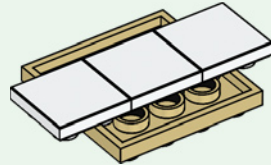



6x

4

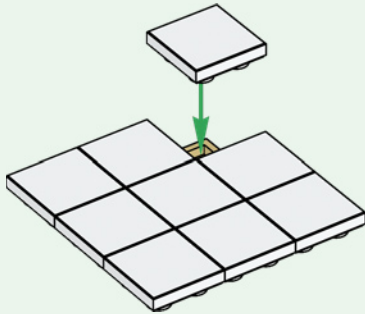

2x

5

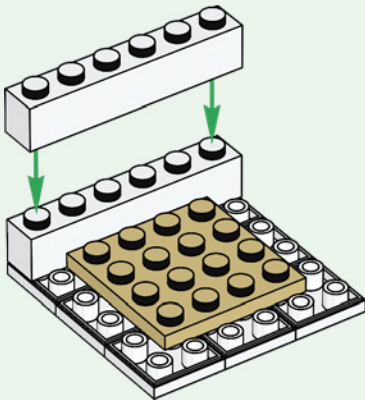

2x

6

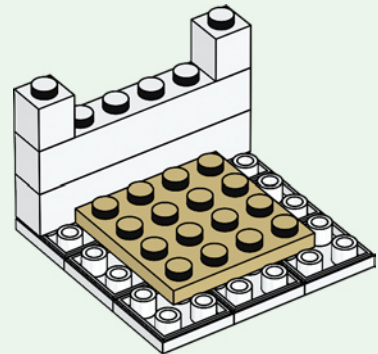

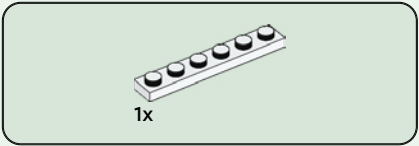

7

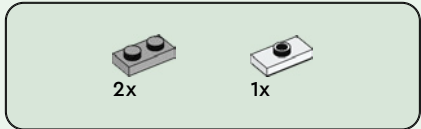
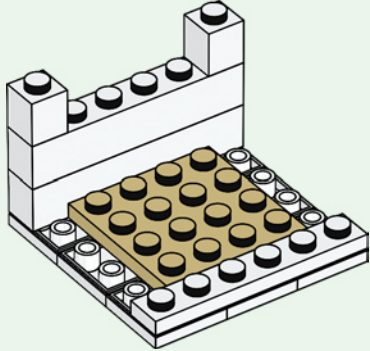

8

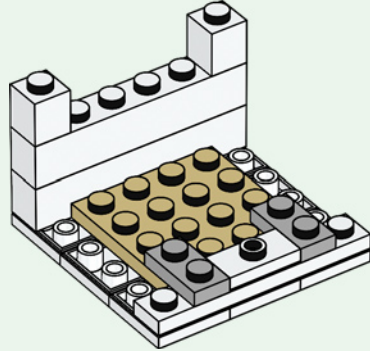

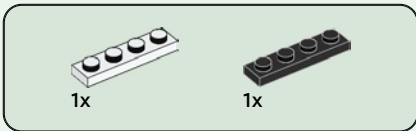

9

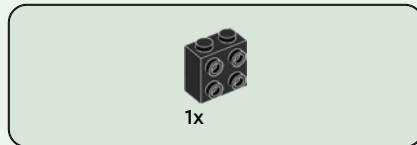
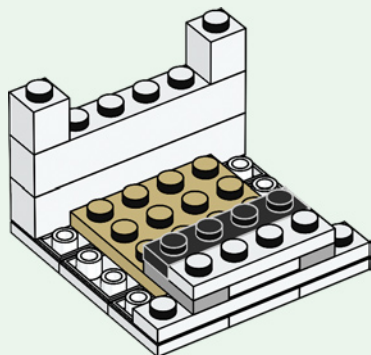

10

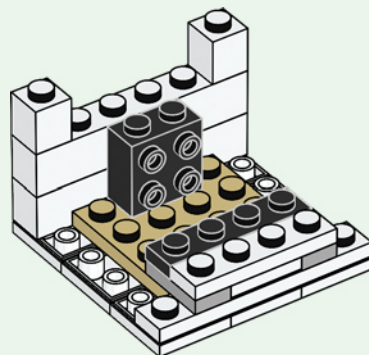



4x

11

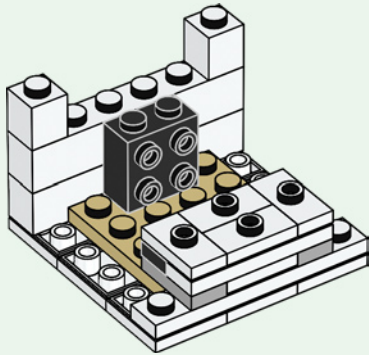

1x



2x

12

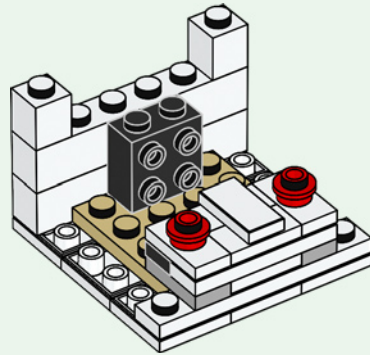

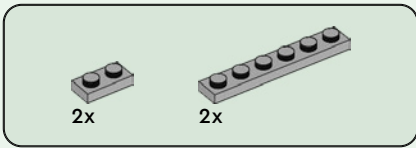

13

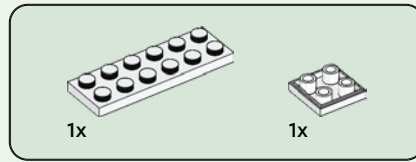
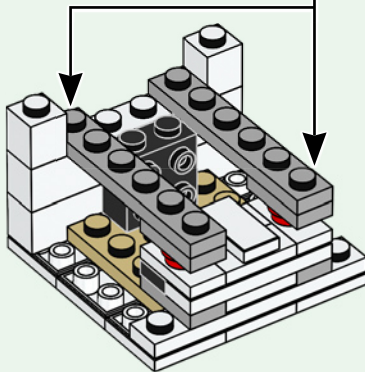
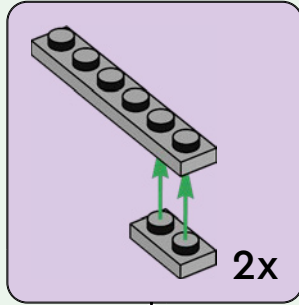

14

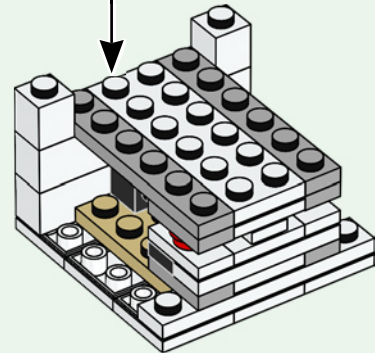
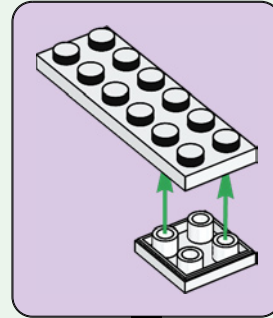



2x

15

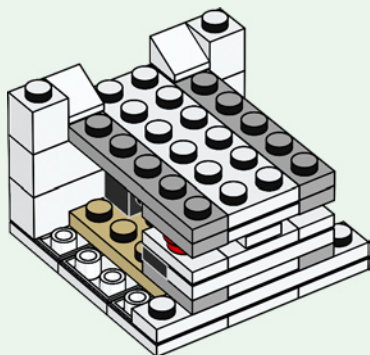

2x

16

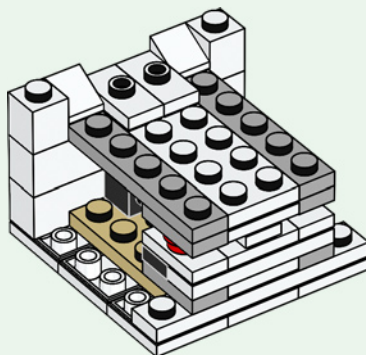



1x

17

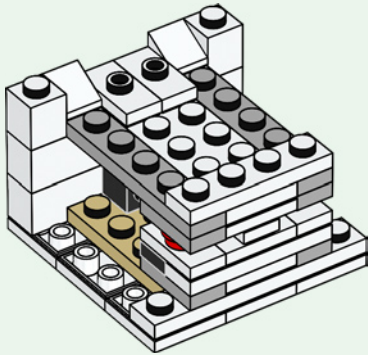

2x

18

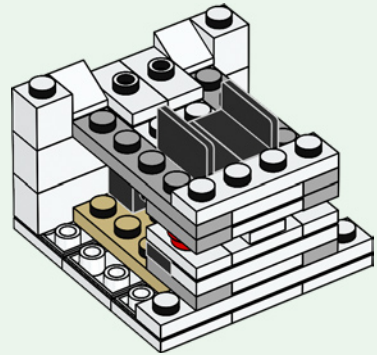



2x

19

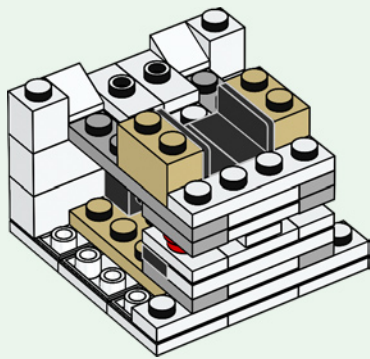

4x



2x

20

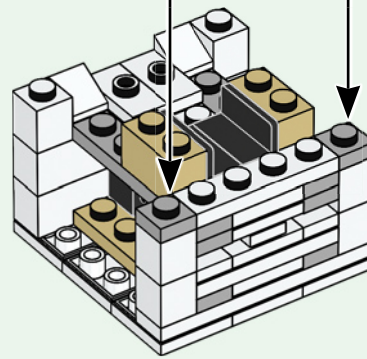
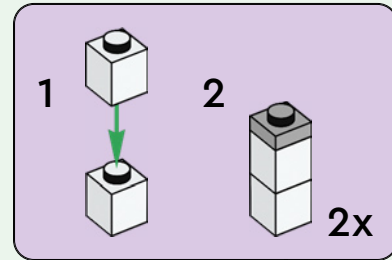



1x

21

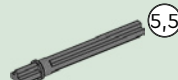
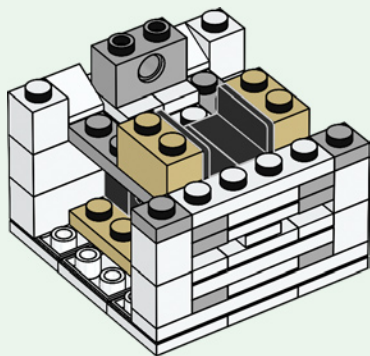

1x



1x

22

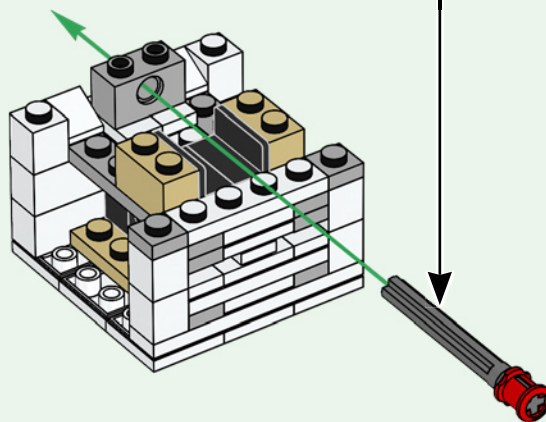
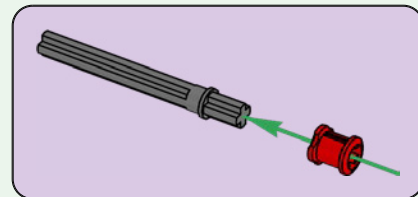

5.5

1:1

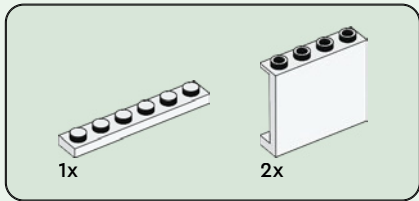

23

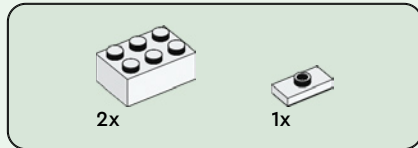
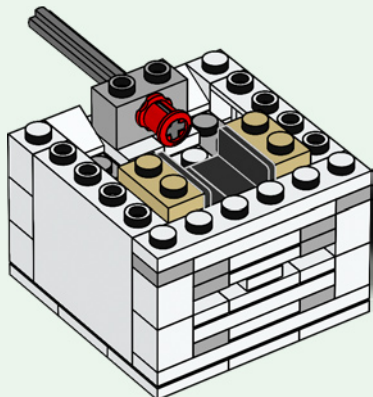

24

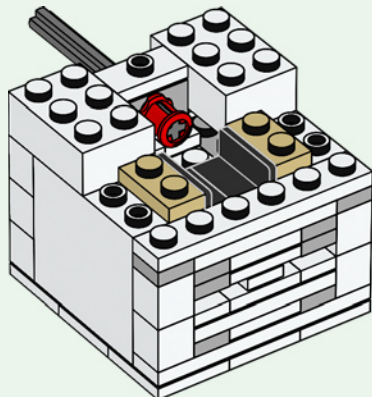

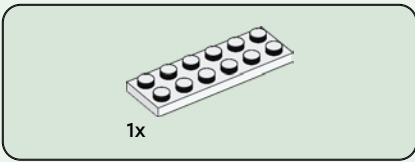

25

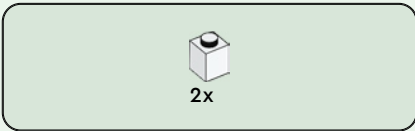
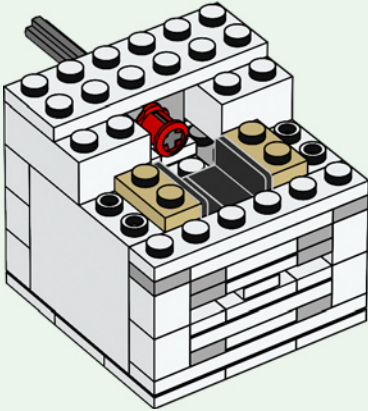

26

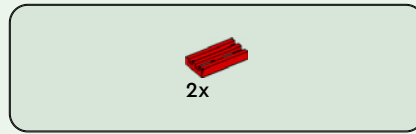
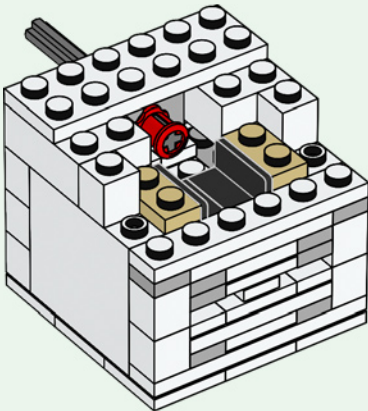

27

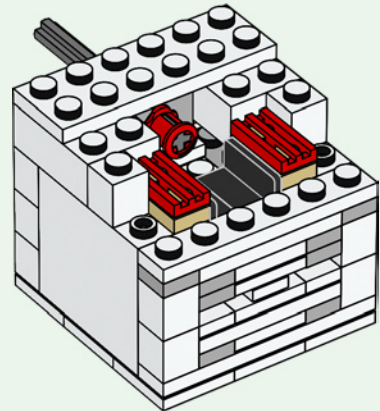



1x

28

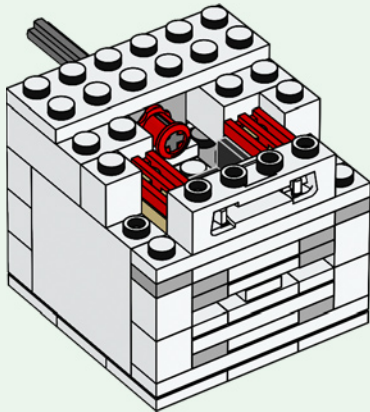

4x



2x

29

1



2



3

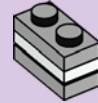

2x

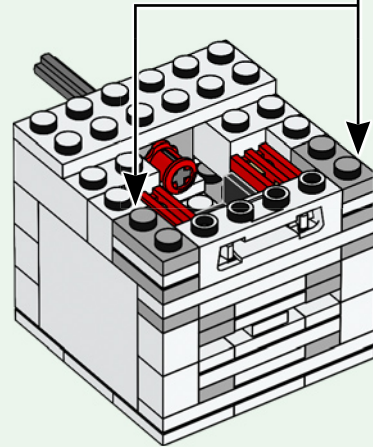

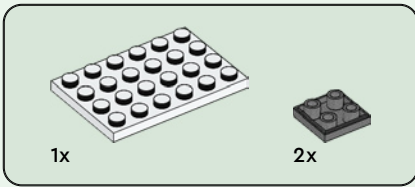

30

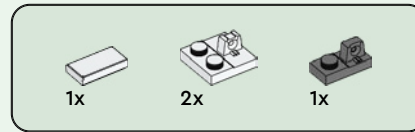
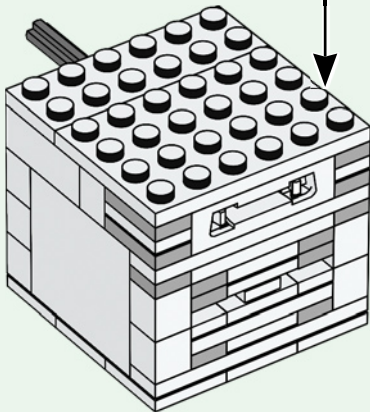
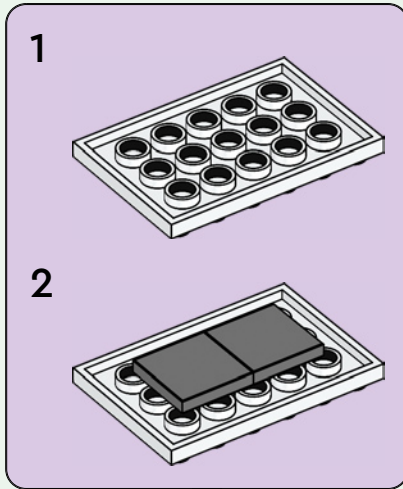

31

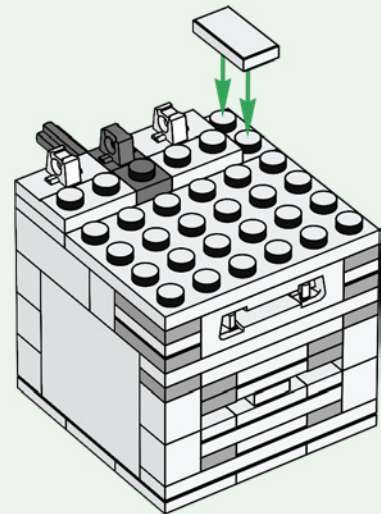

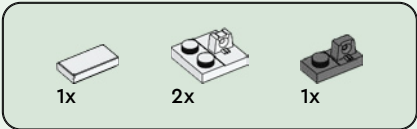

32

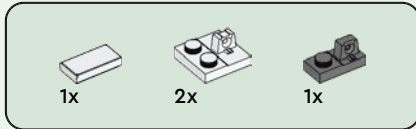
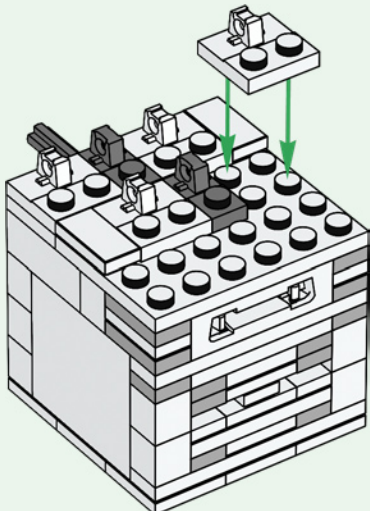

33

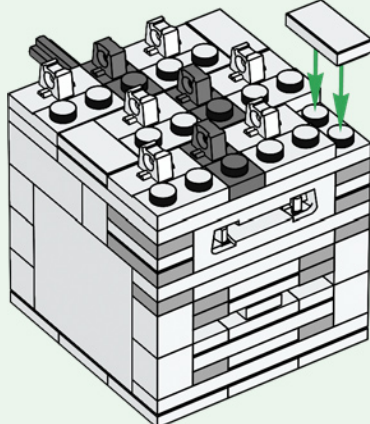

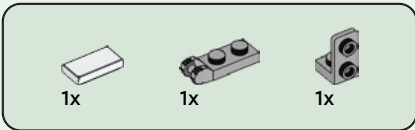

34

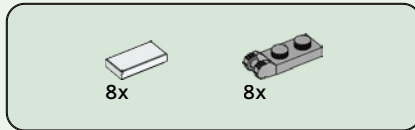
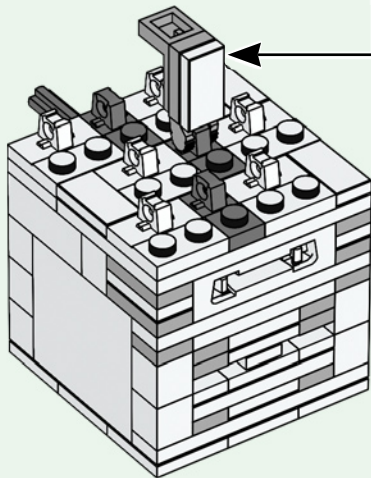
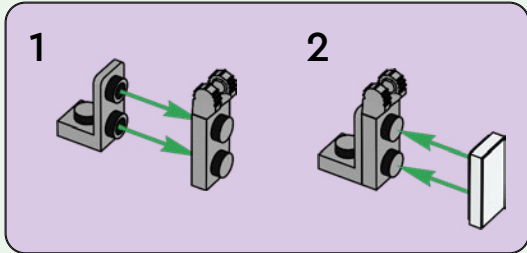

35

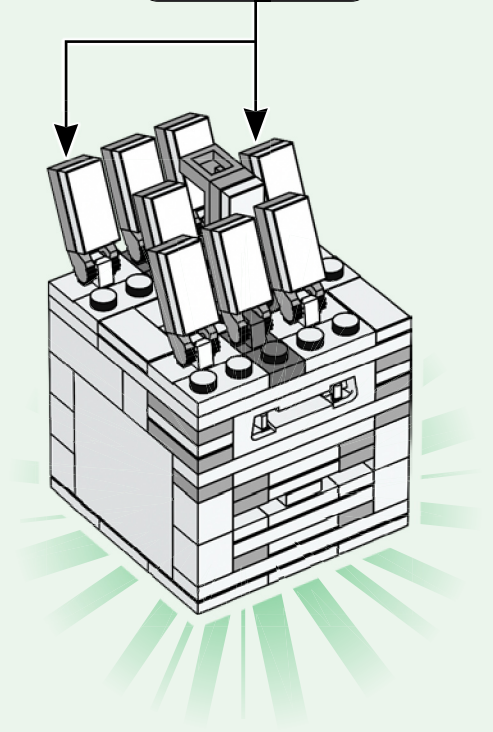
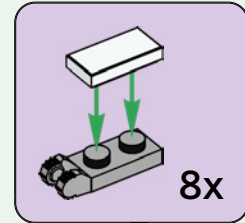



2x

36

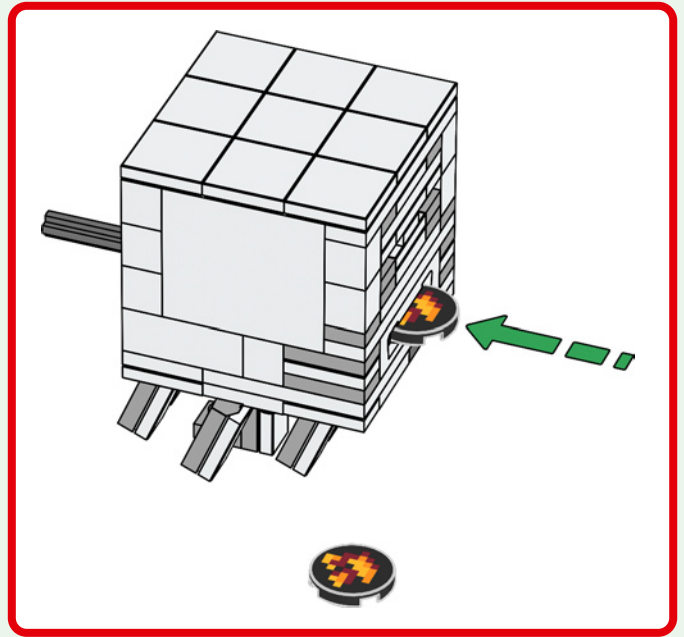
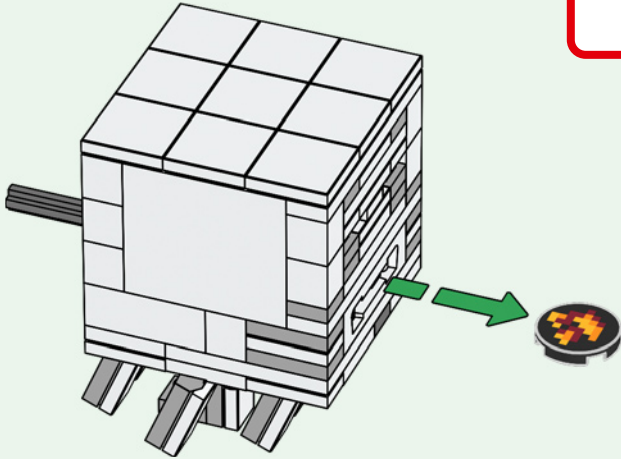

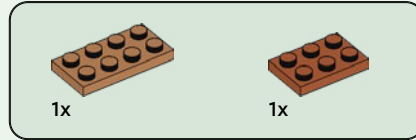
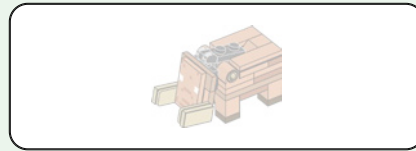

37

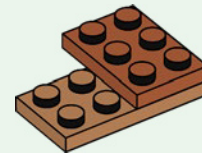



1x

38

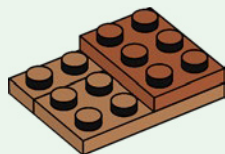

2x

39

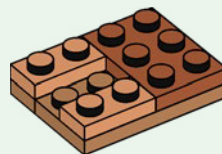

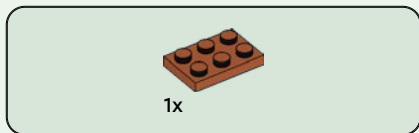

40

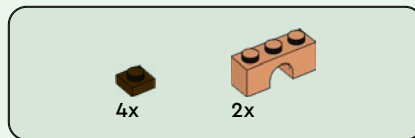
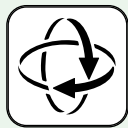
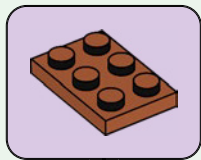

41

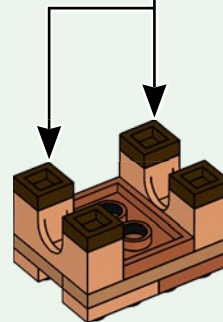
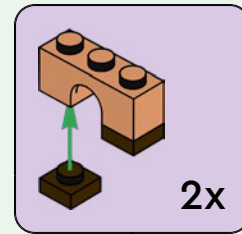



2x



1x

42

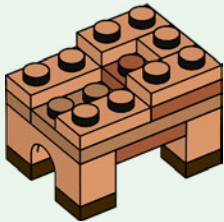

1x

43

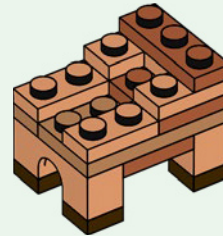



1x

44

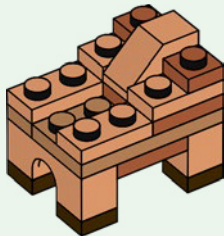

1x



1x



1x



2x

45

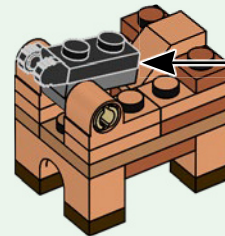
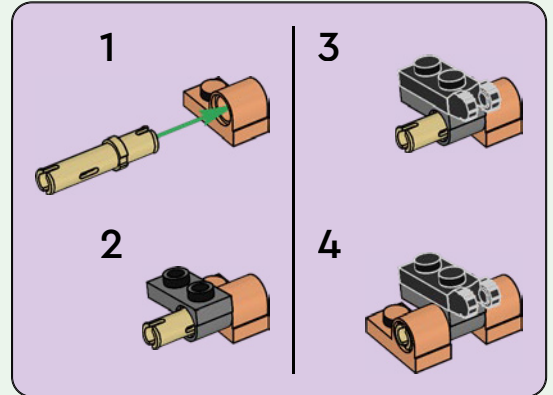



2x

46

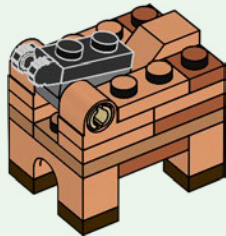

2x

47

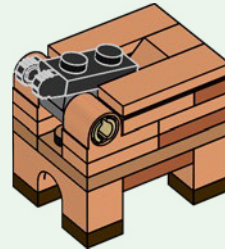



1x

48



1x

49



1x

50



1x



1x

51





52

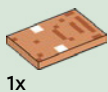
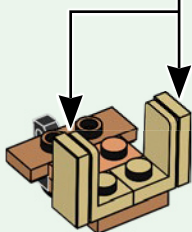
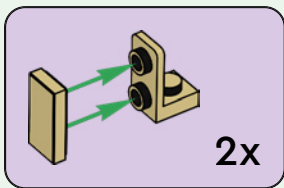

53



54

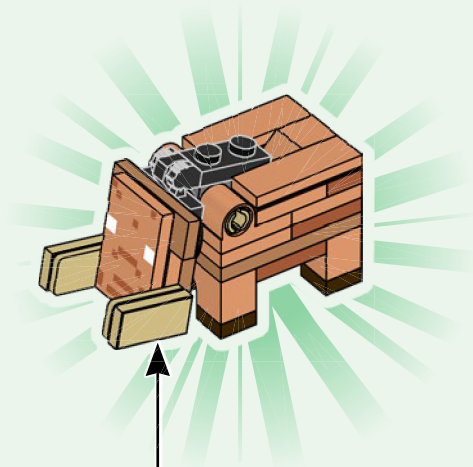

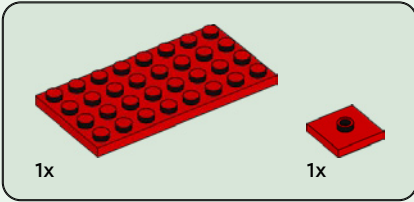
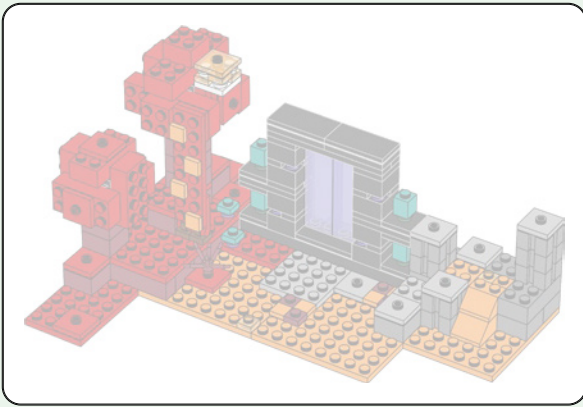

55

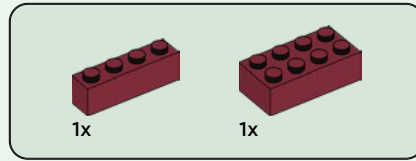
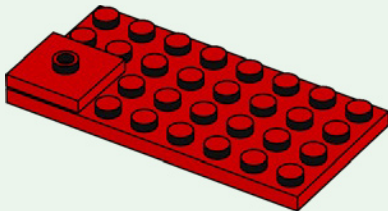

56

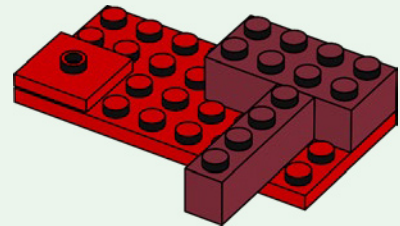

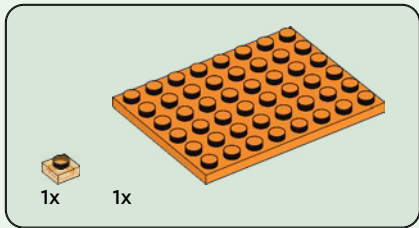

57

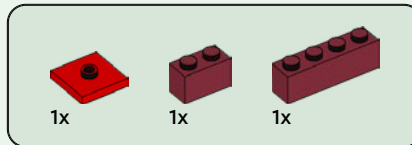
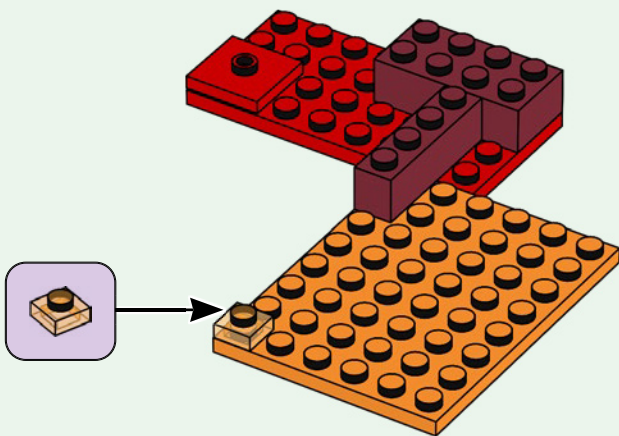

58

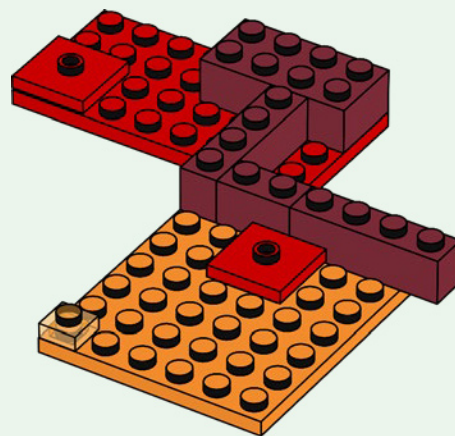

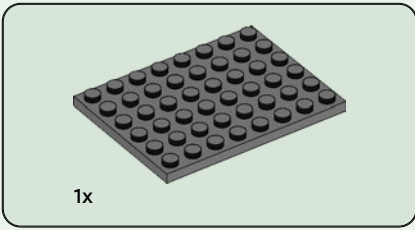

59

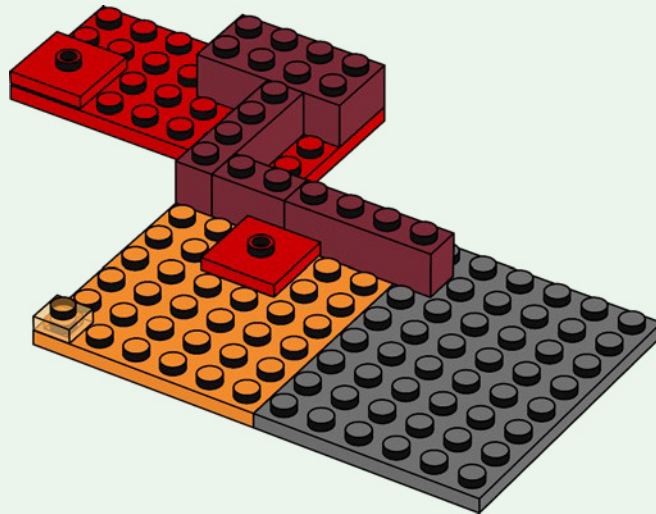

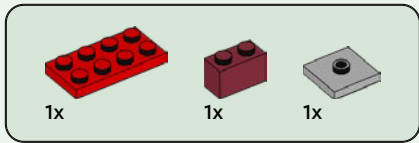

60

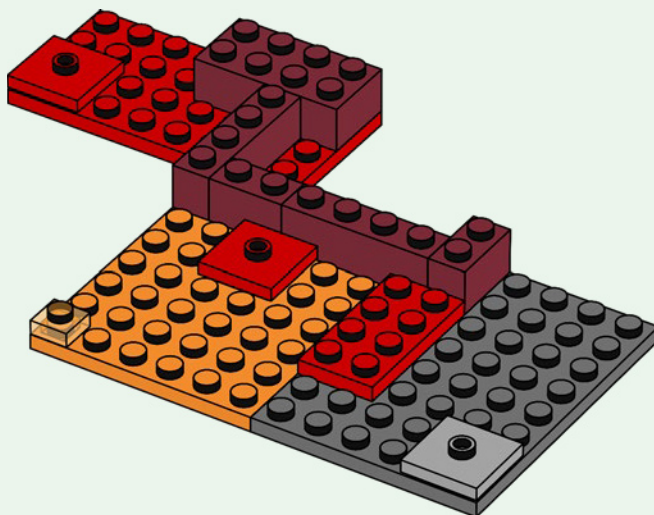

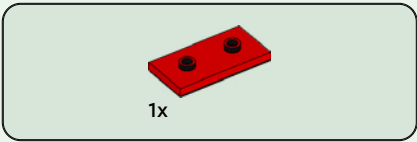

61

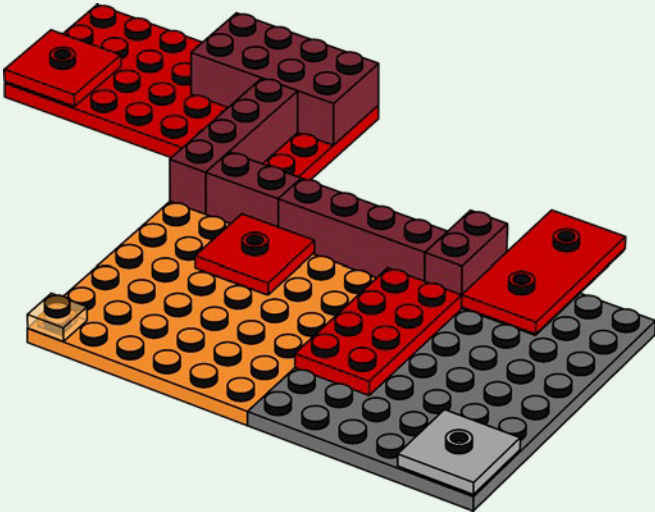



1x

62

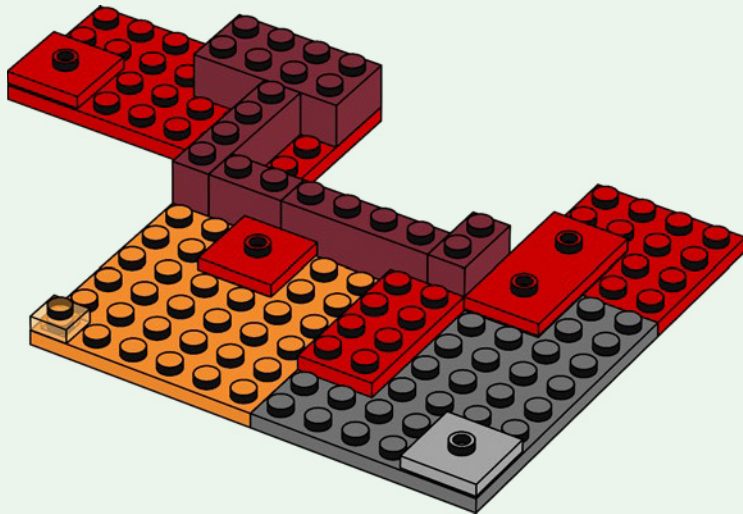

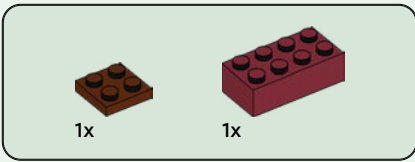

63

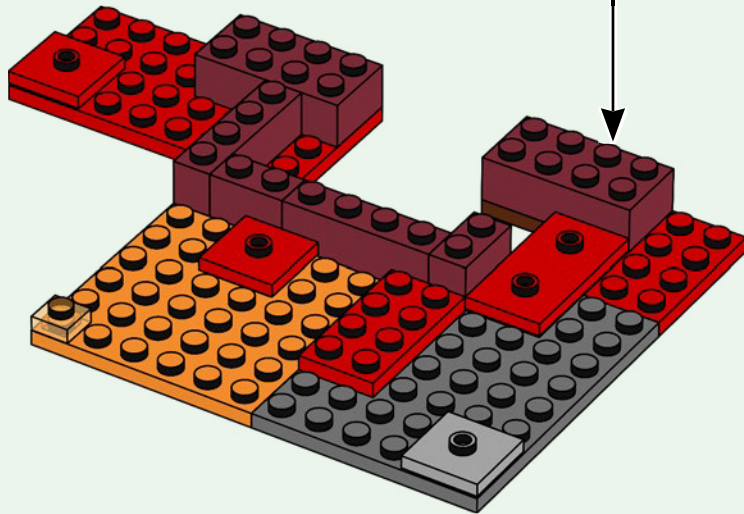
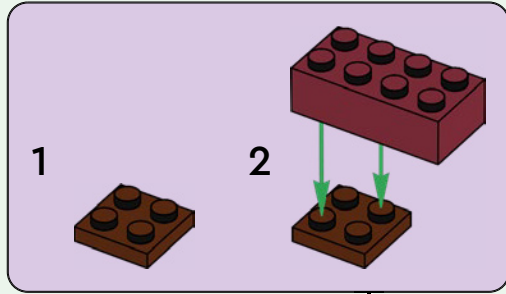

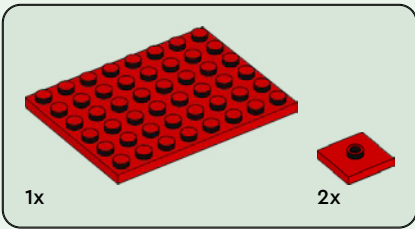

65

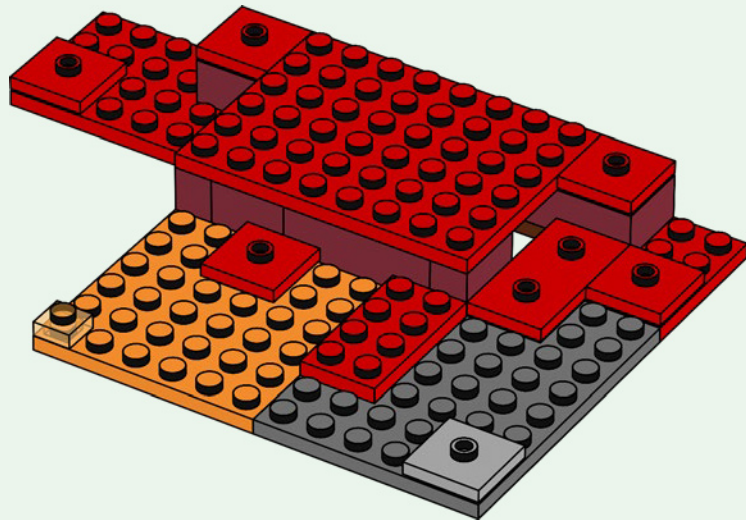

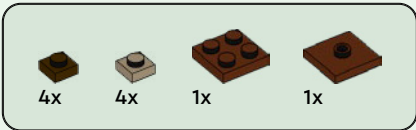

66

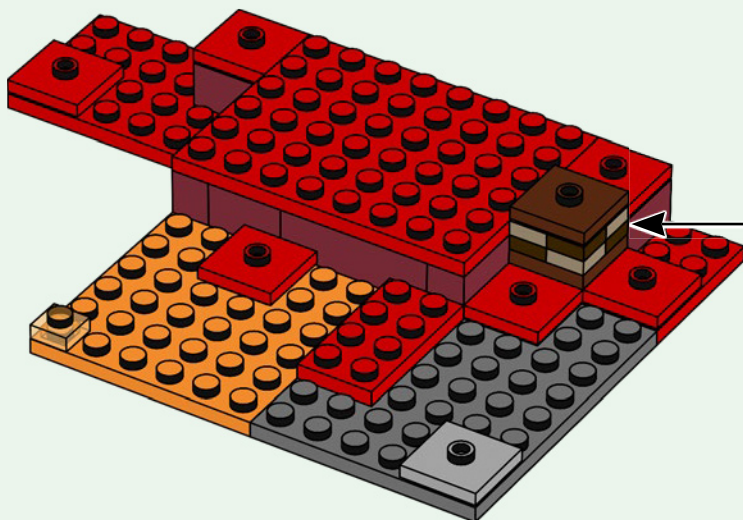
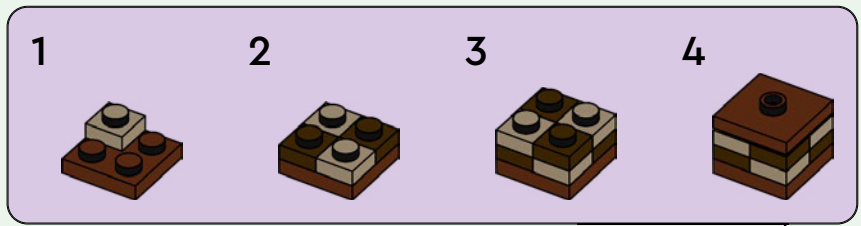

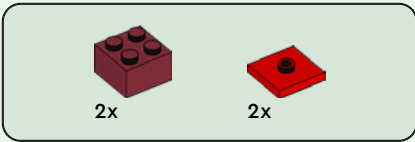

67

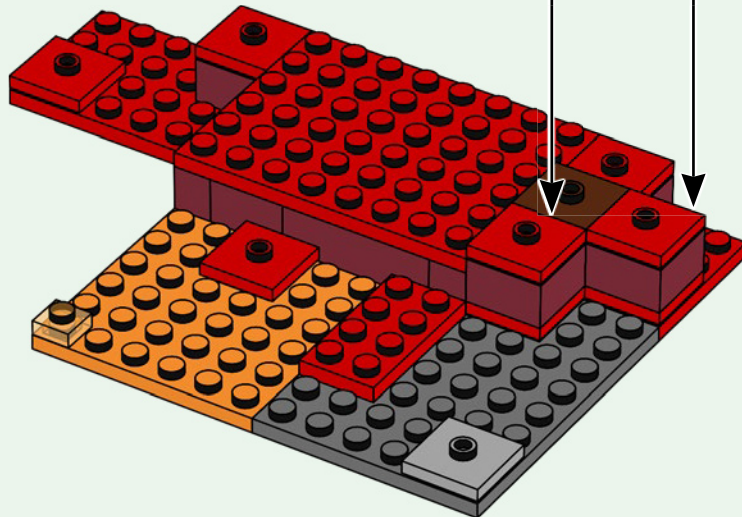
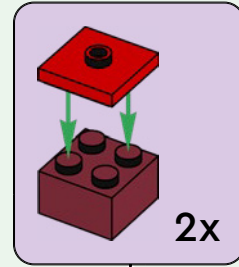

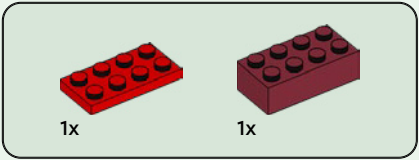

68

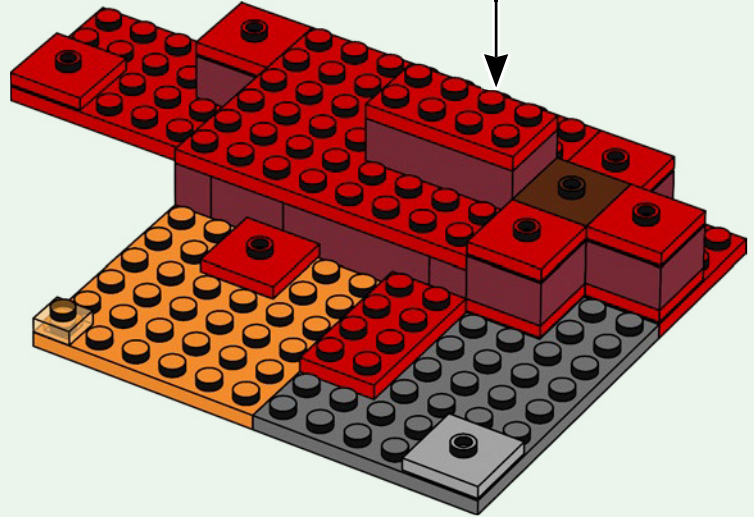
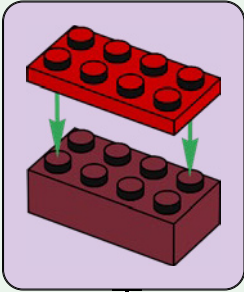

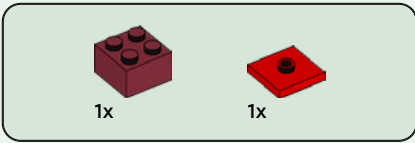

69

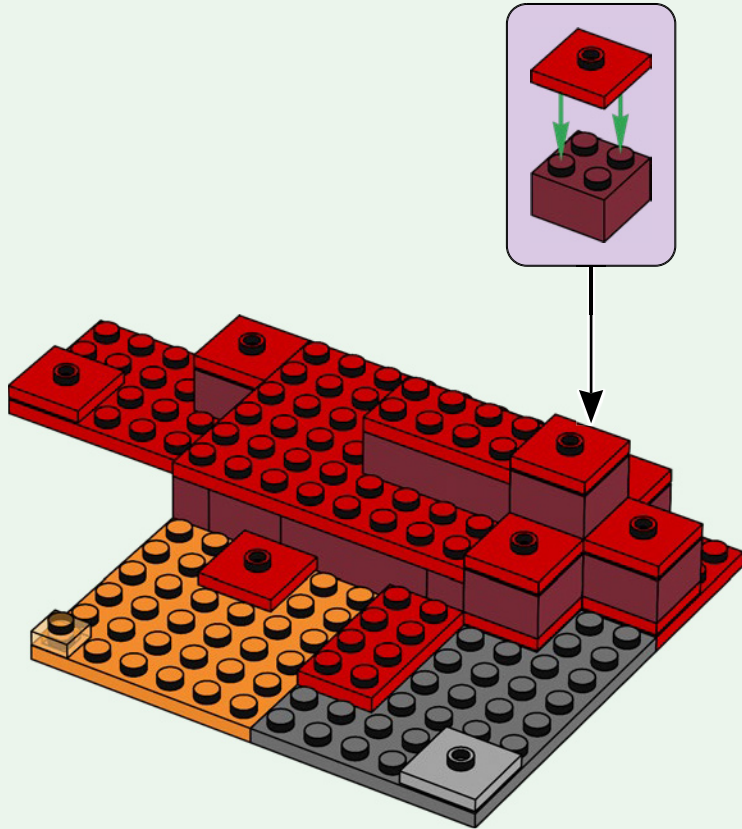

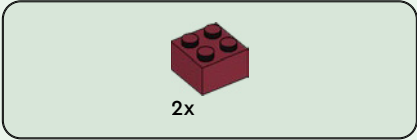
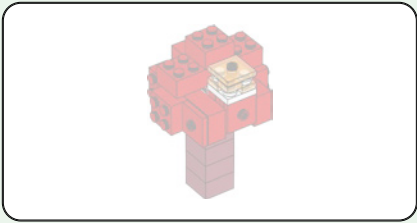

70

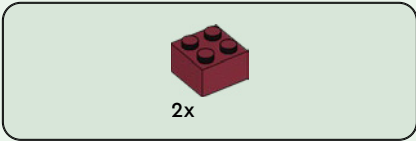
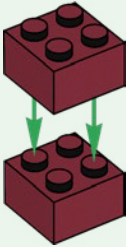

71

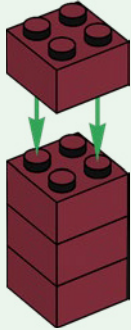

72

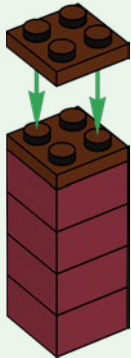



2x

73

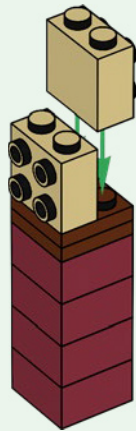

2x

74



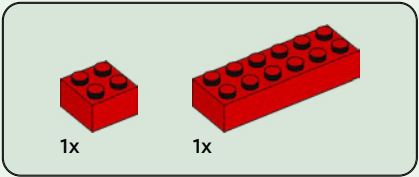

75

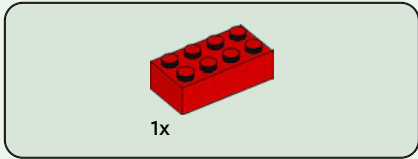
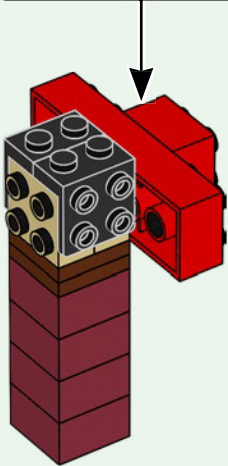
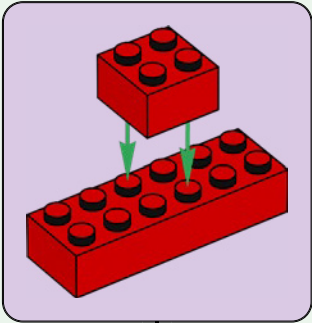

76

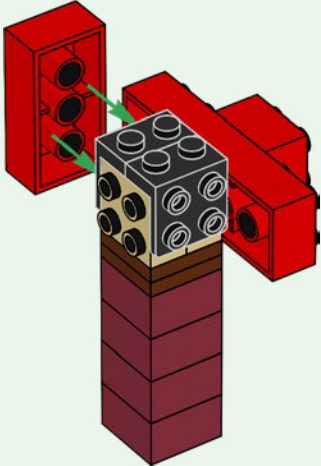

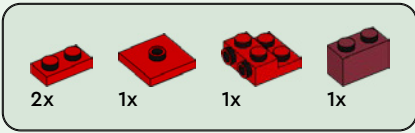

77

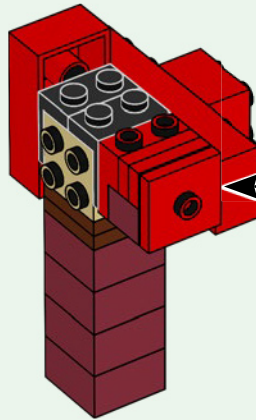
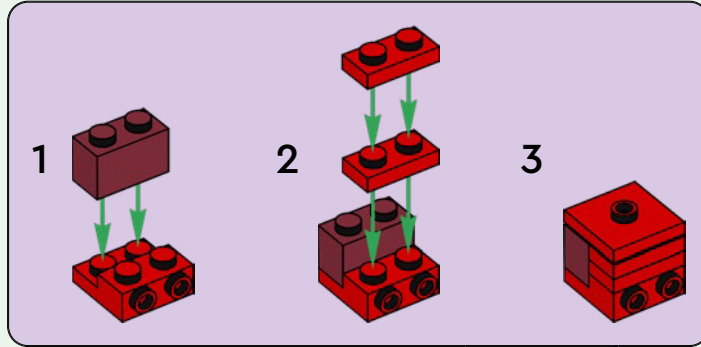

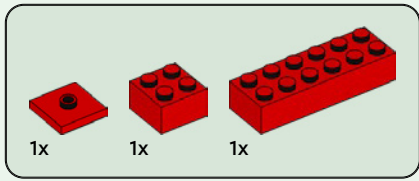

78

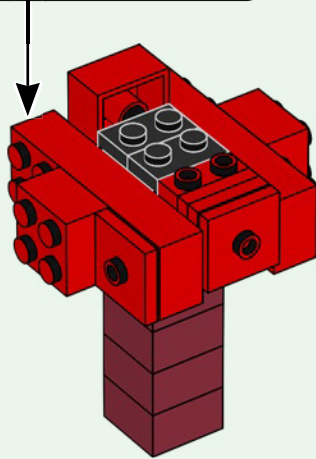
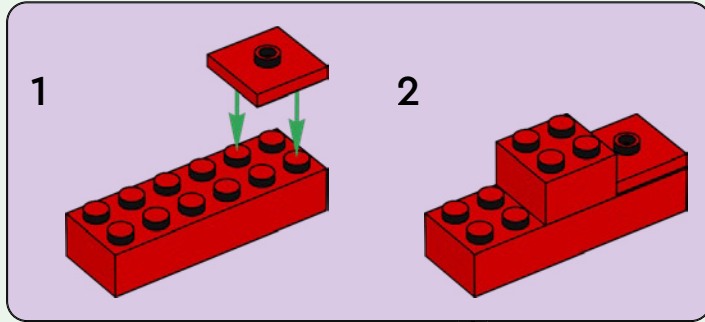

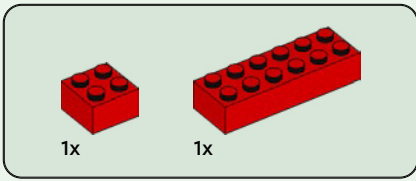

79

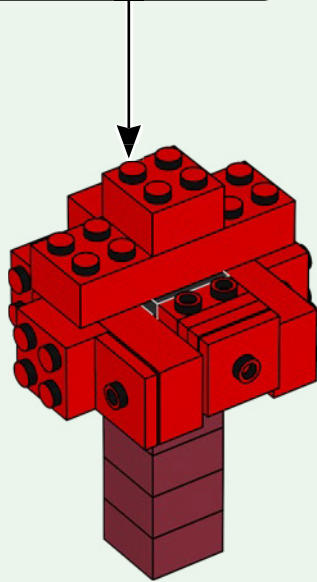
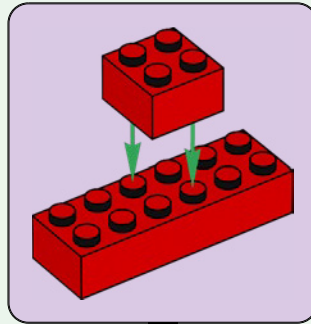

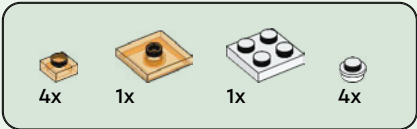

80

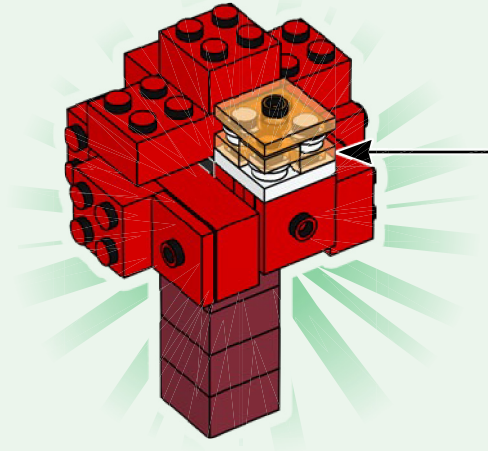
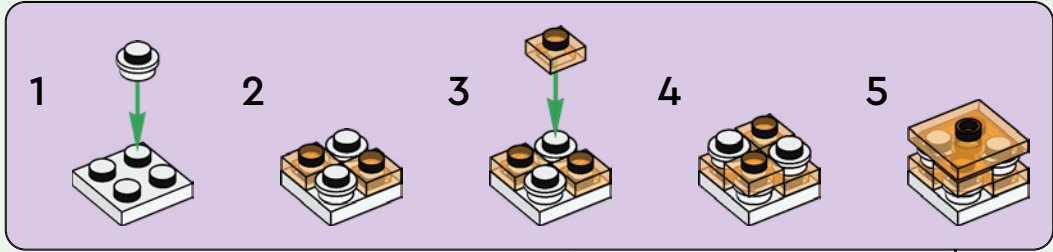

81

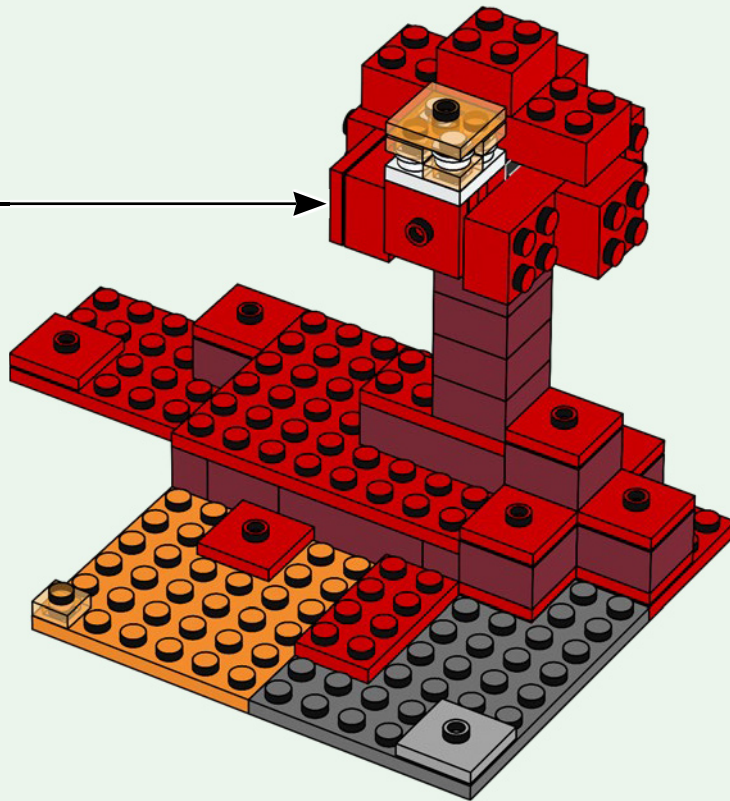

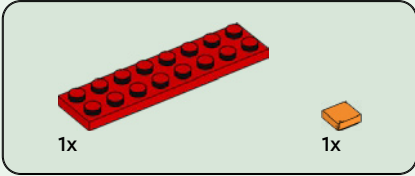
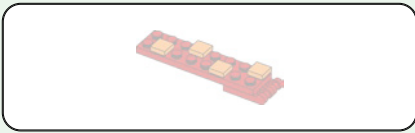

83

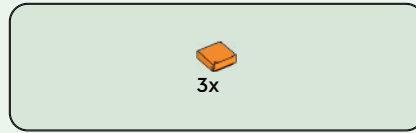
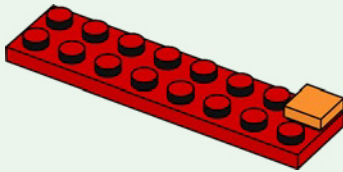

84

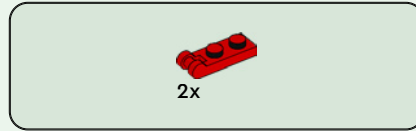
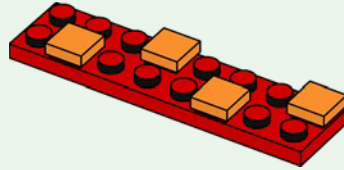

85

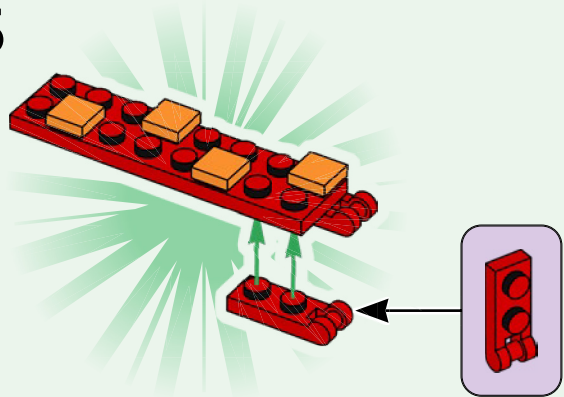

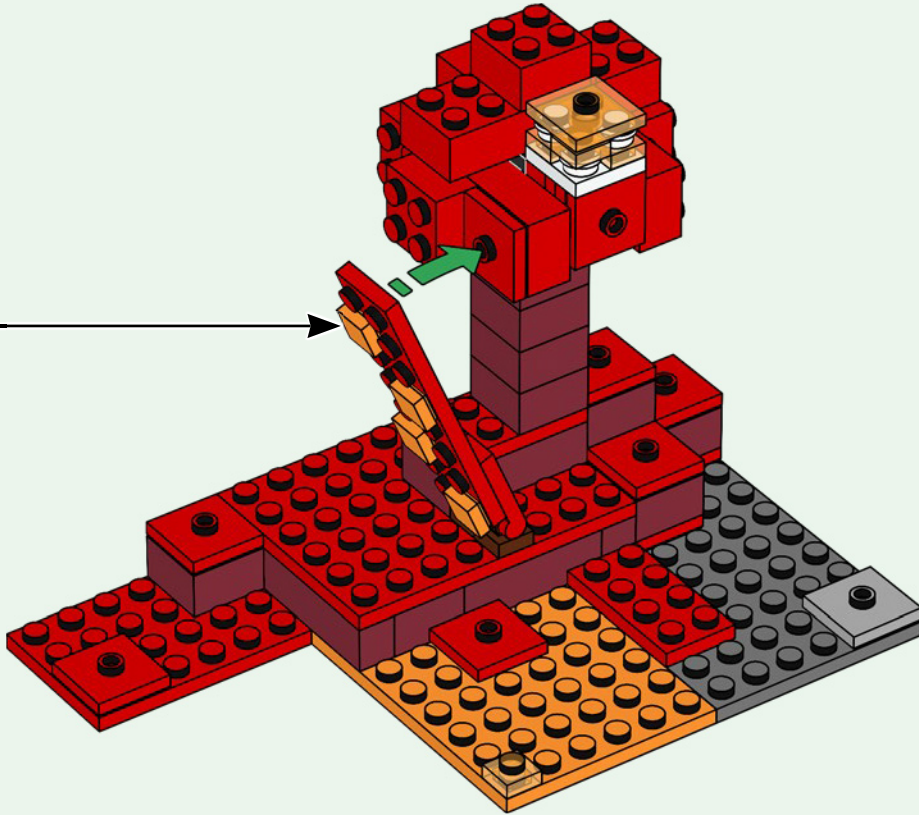



2x



2x

87

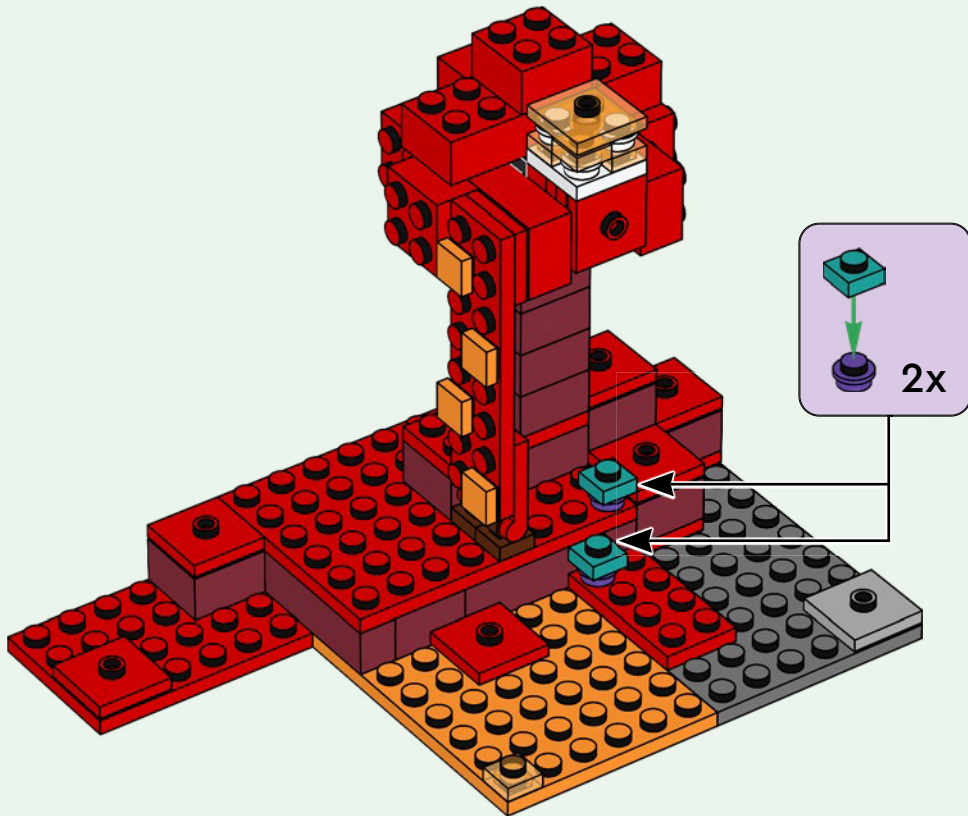



1x

88

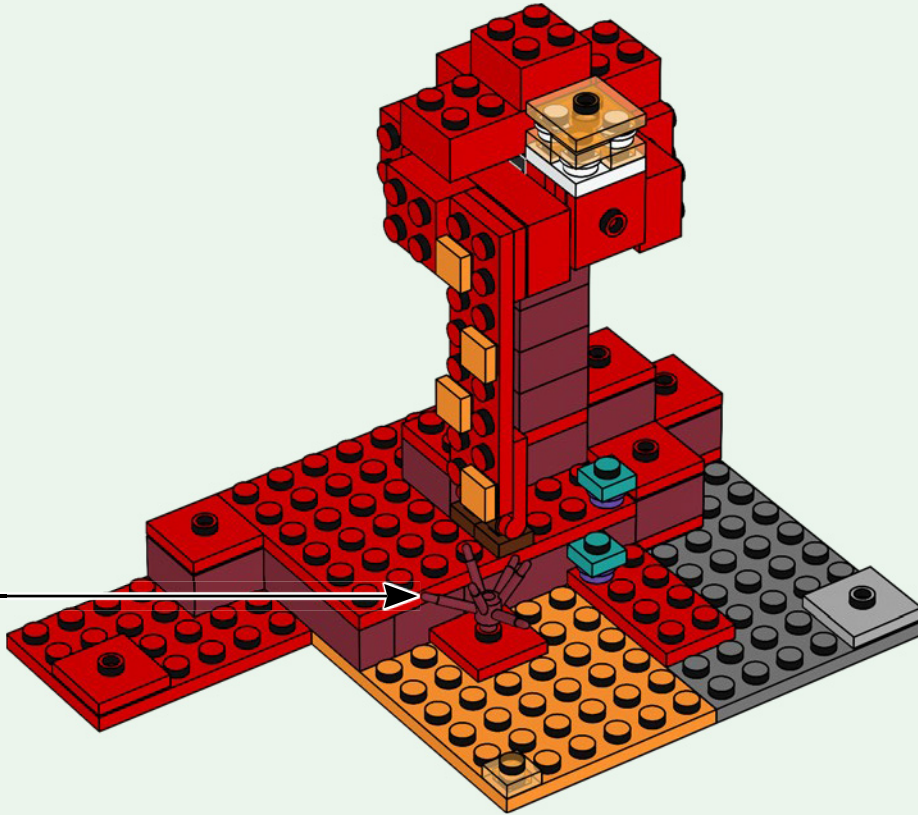
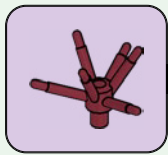

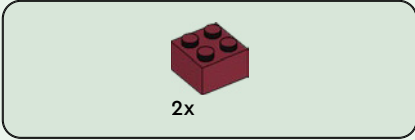
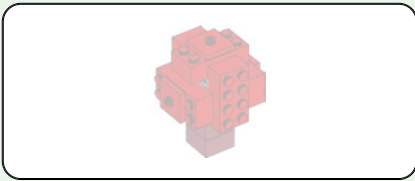

89

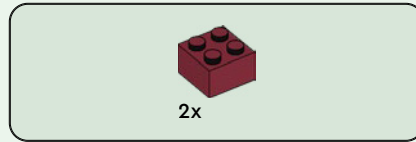
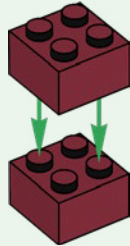

90

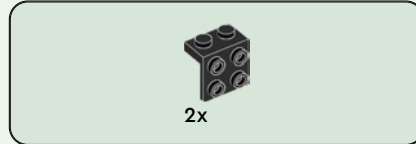
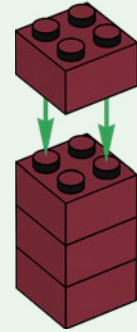

91

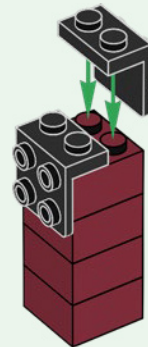



2x

92

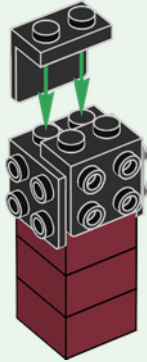

1x



1x

93

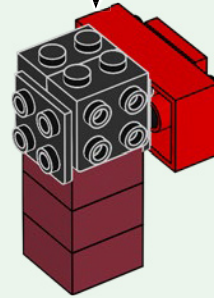
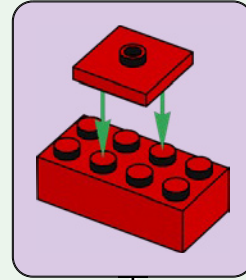

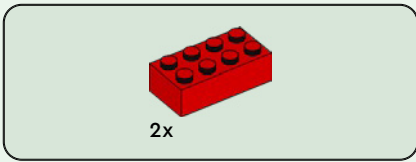

94

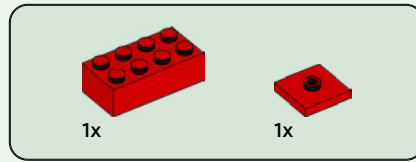
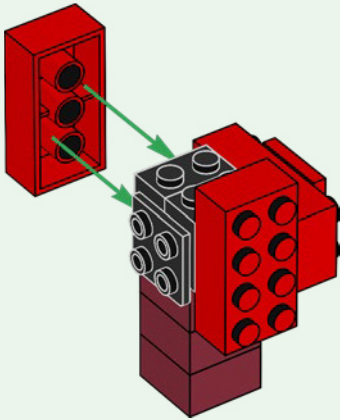

95

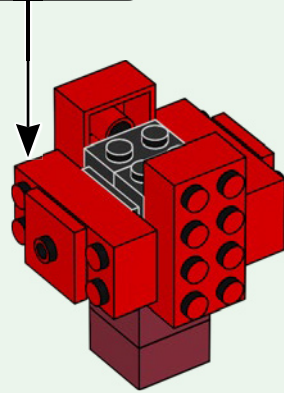
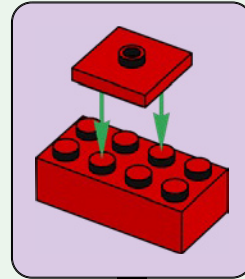

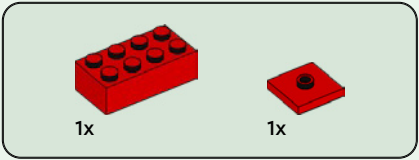

96

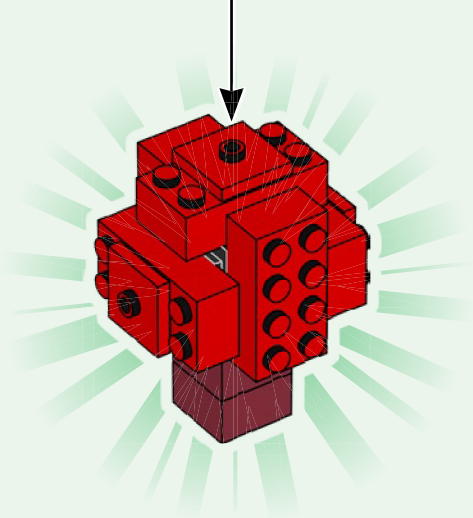
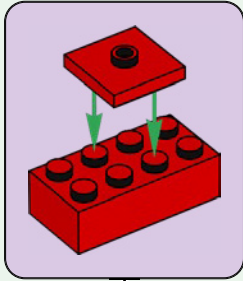





2x

98

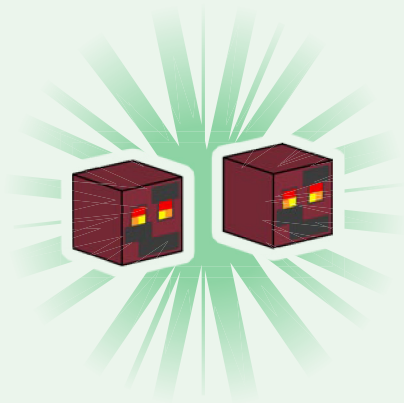



1x

100

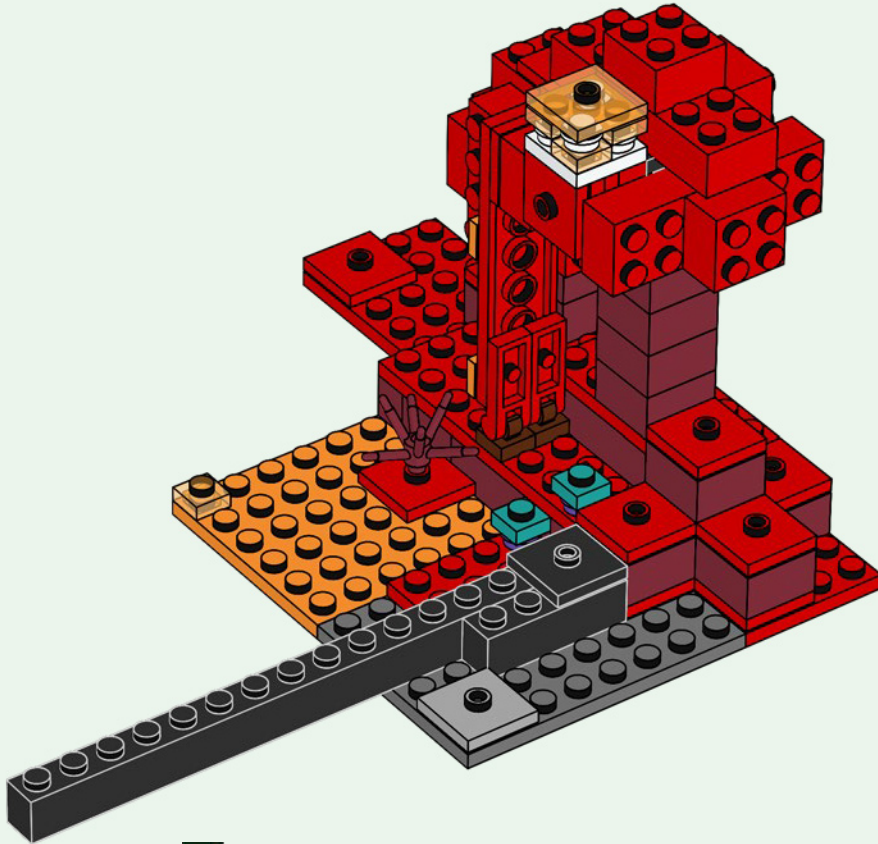

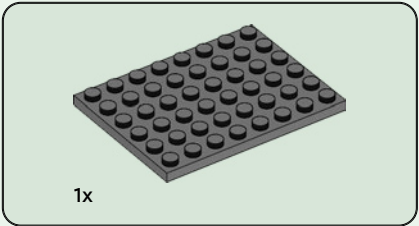

101

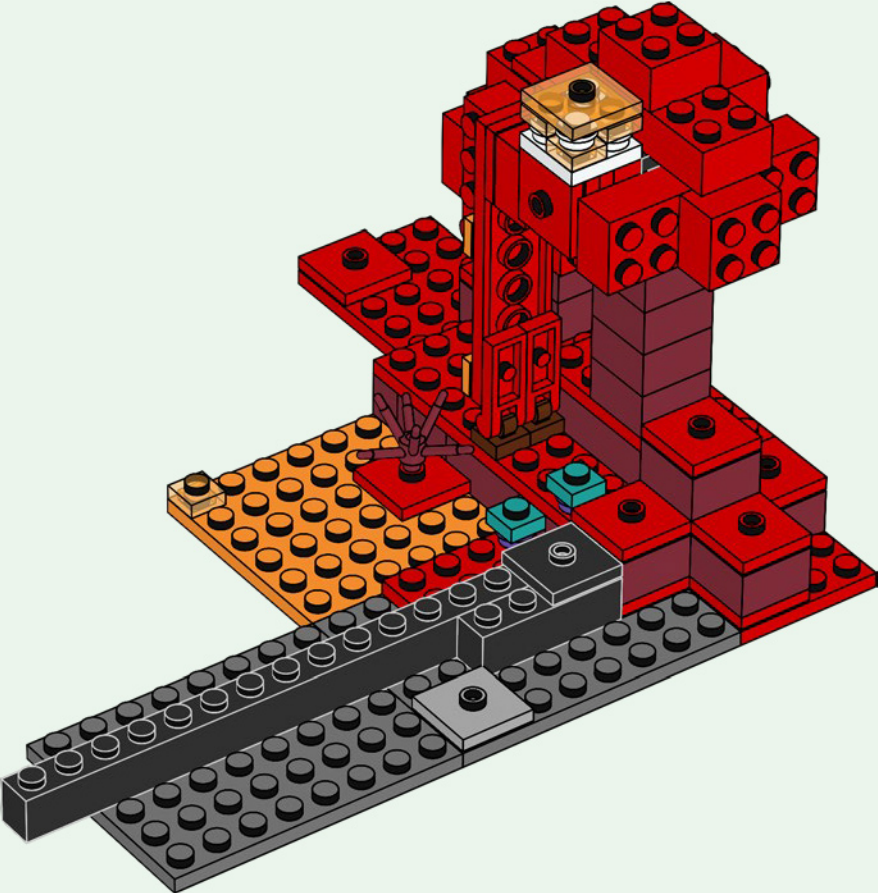

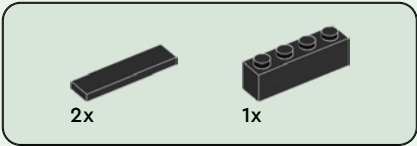

102

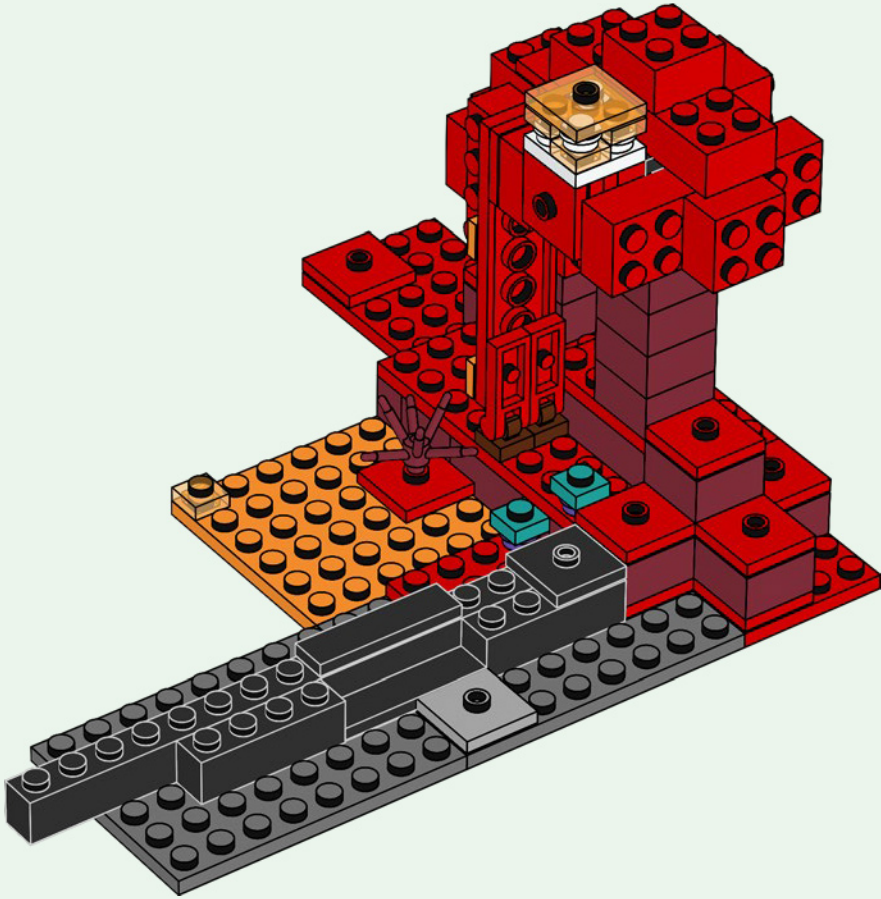

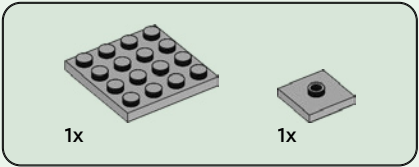

103

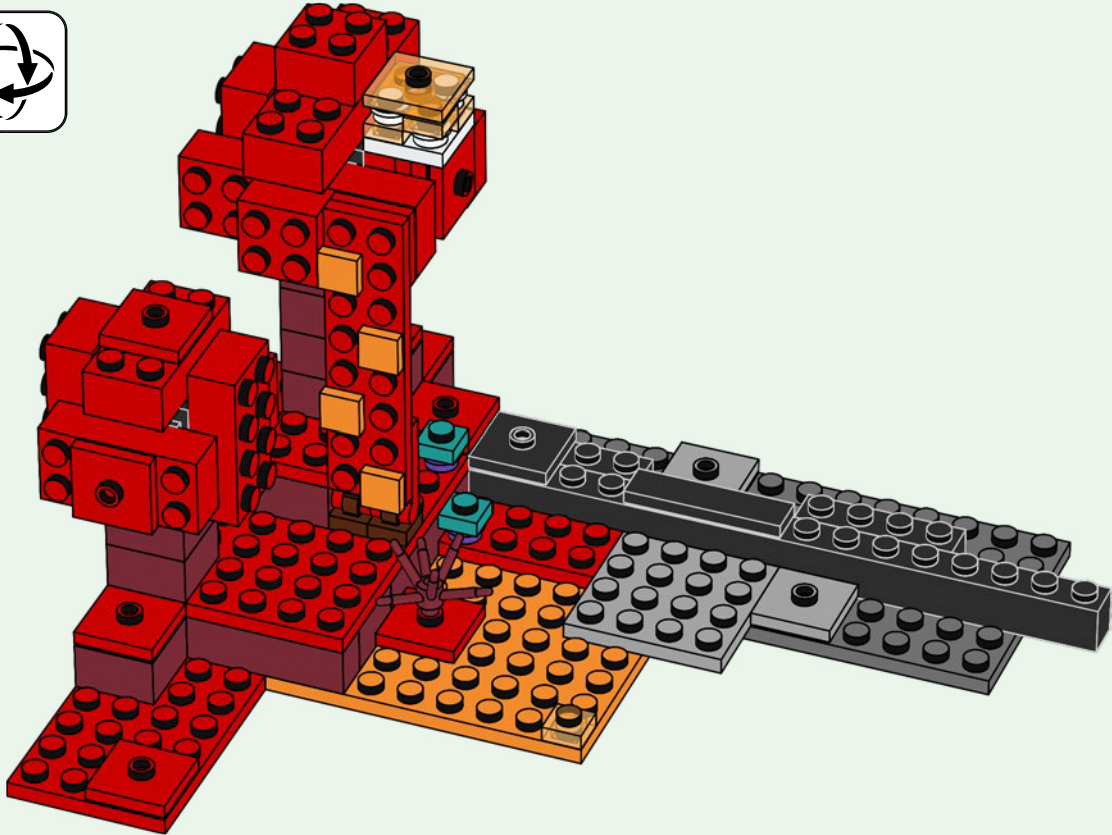



2x



2x

104

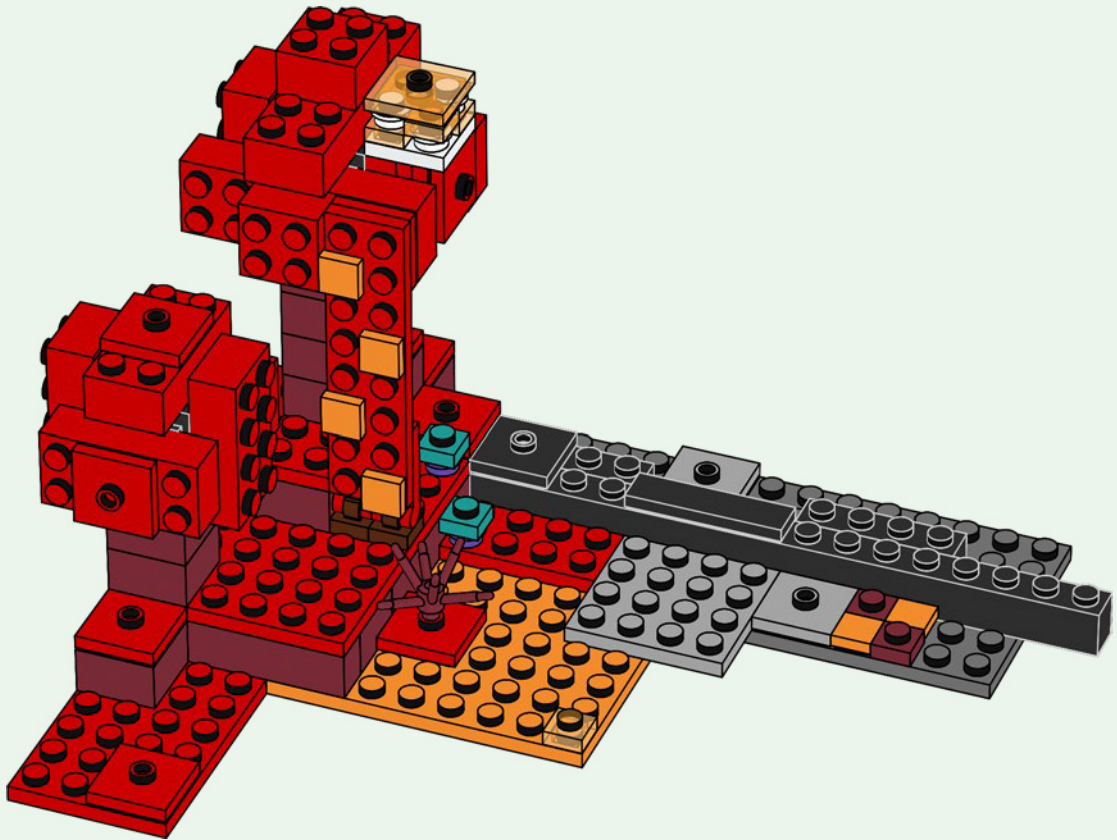

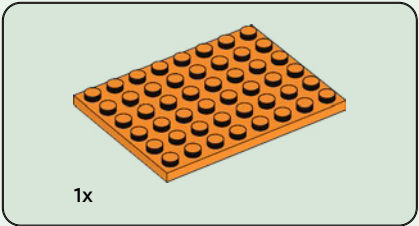

105

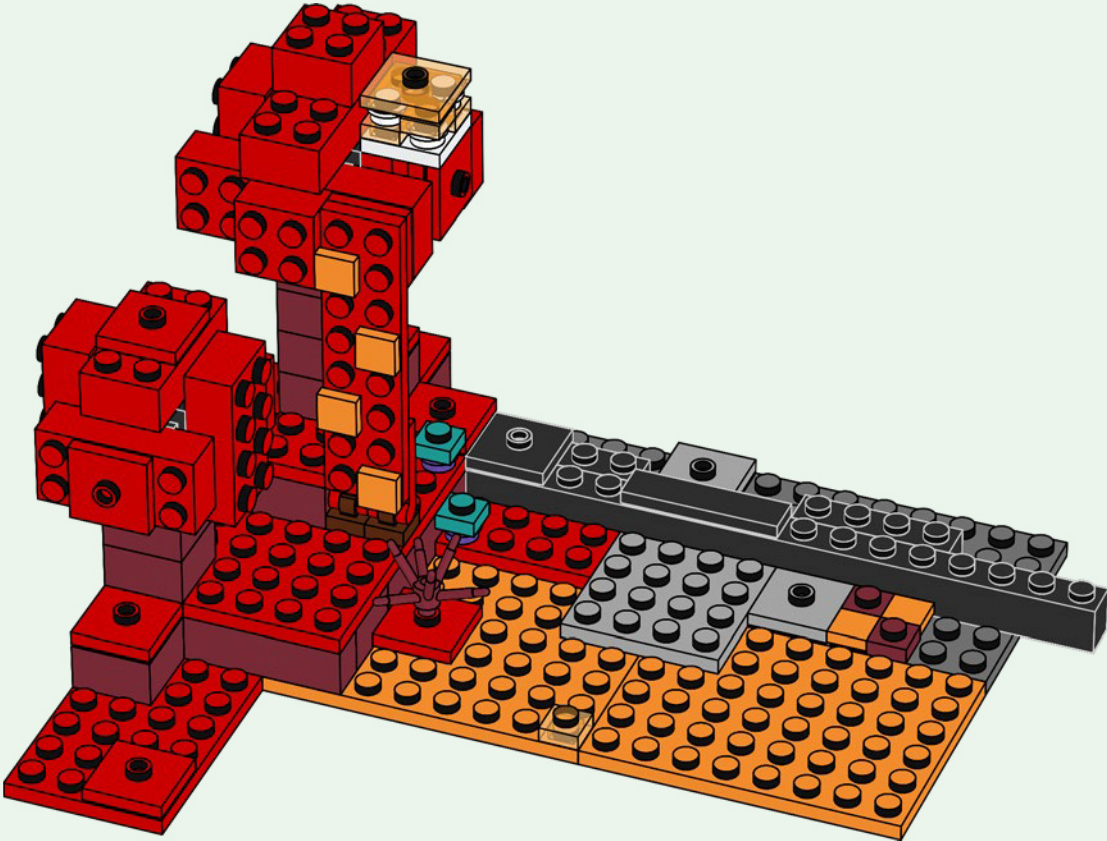



2x



2x

106

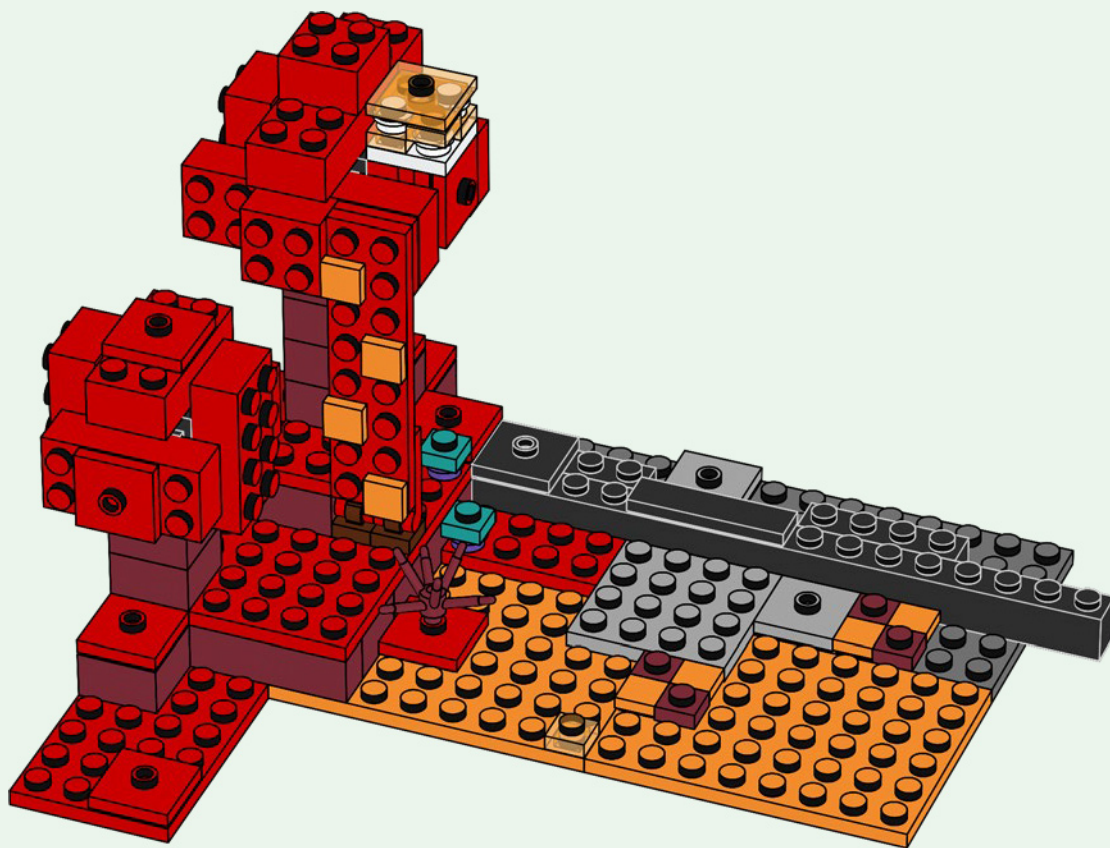



1x

107

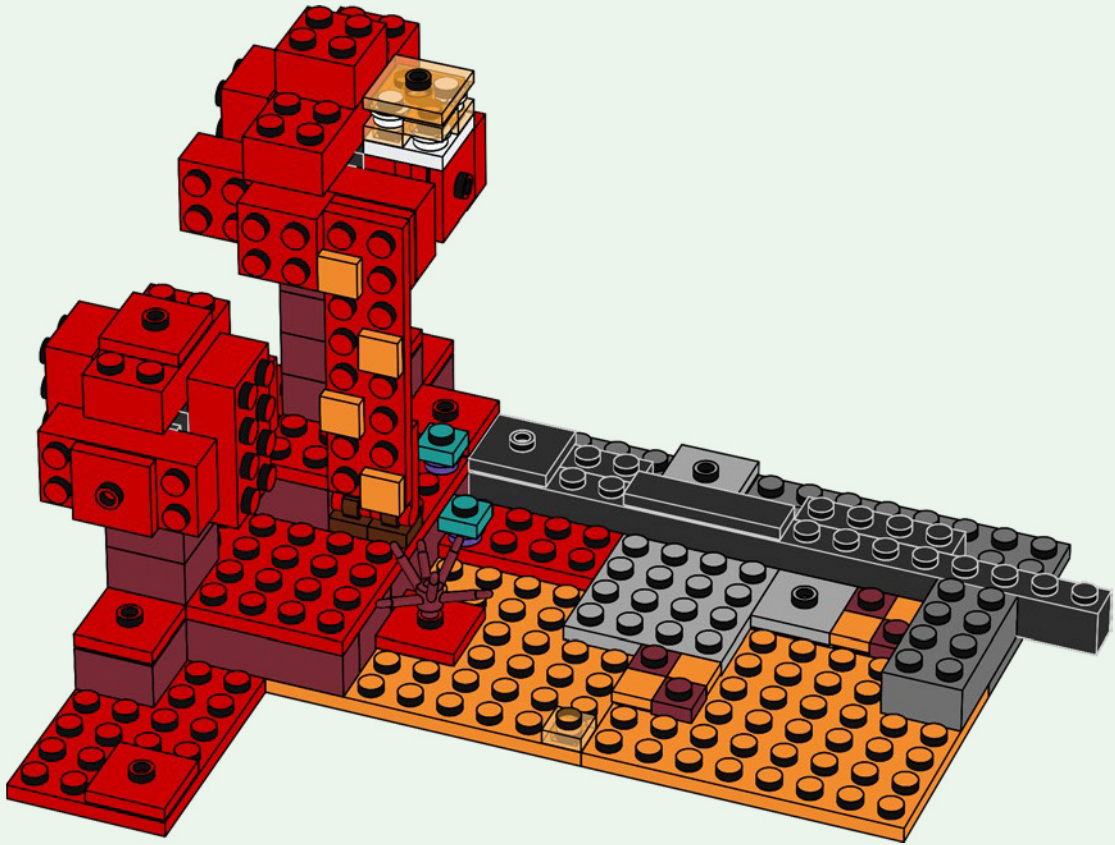

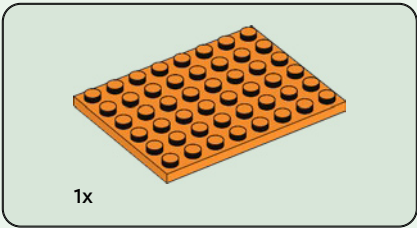

108

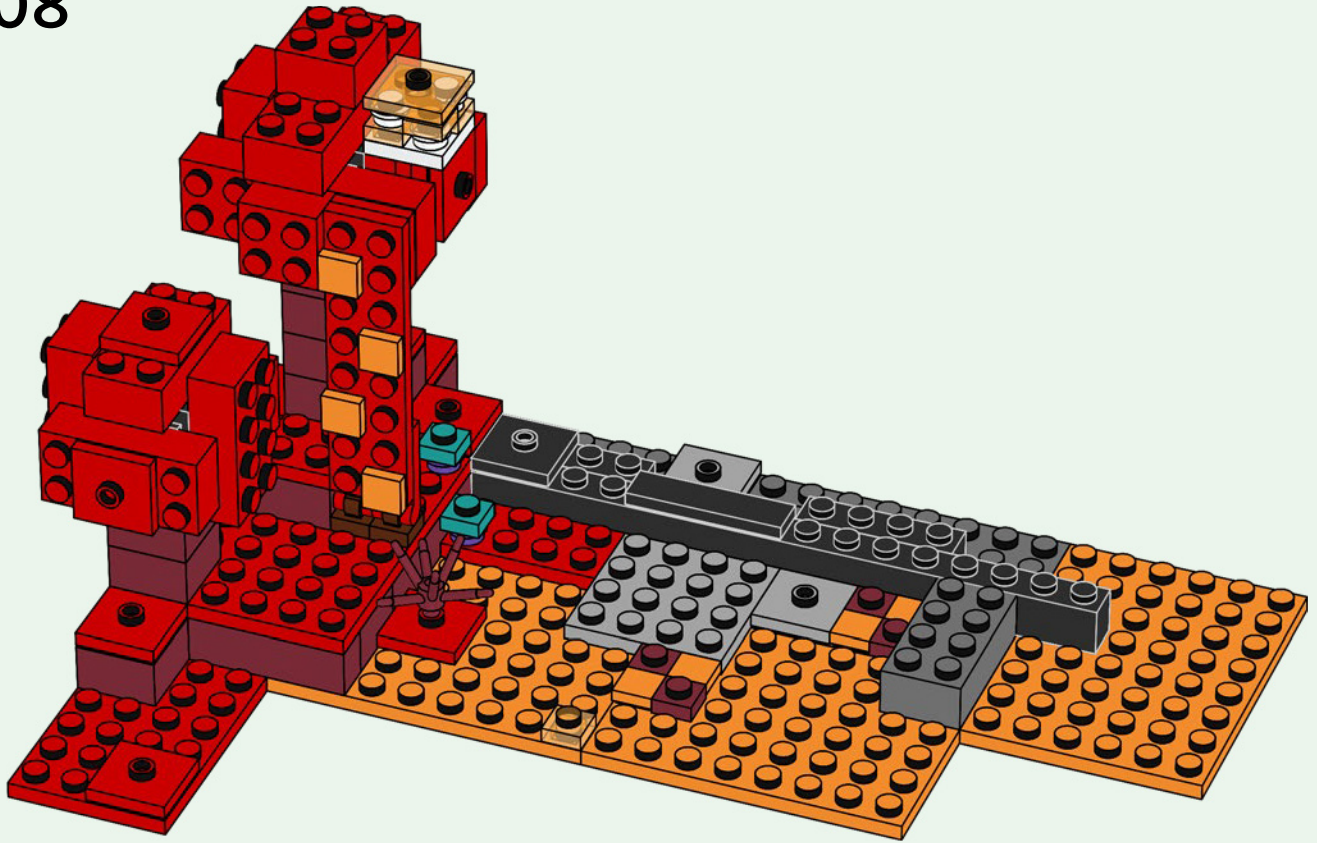

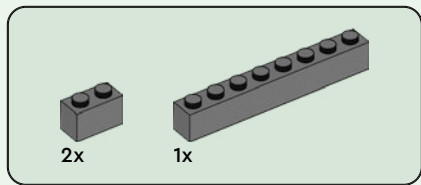

109

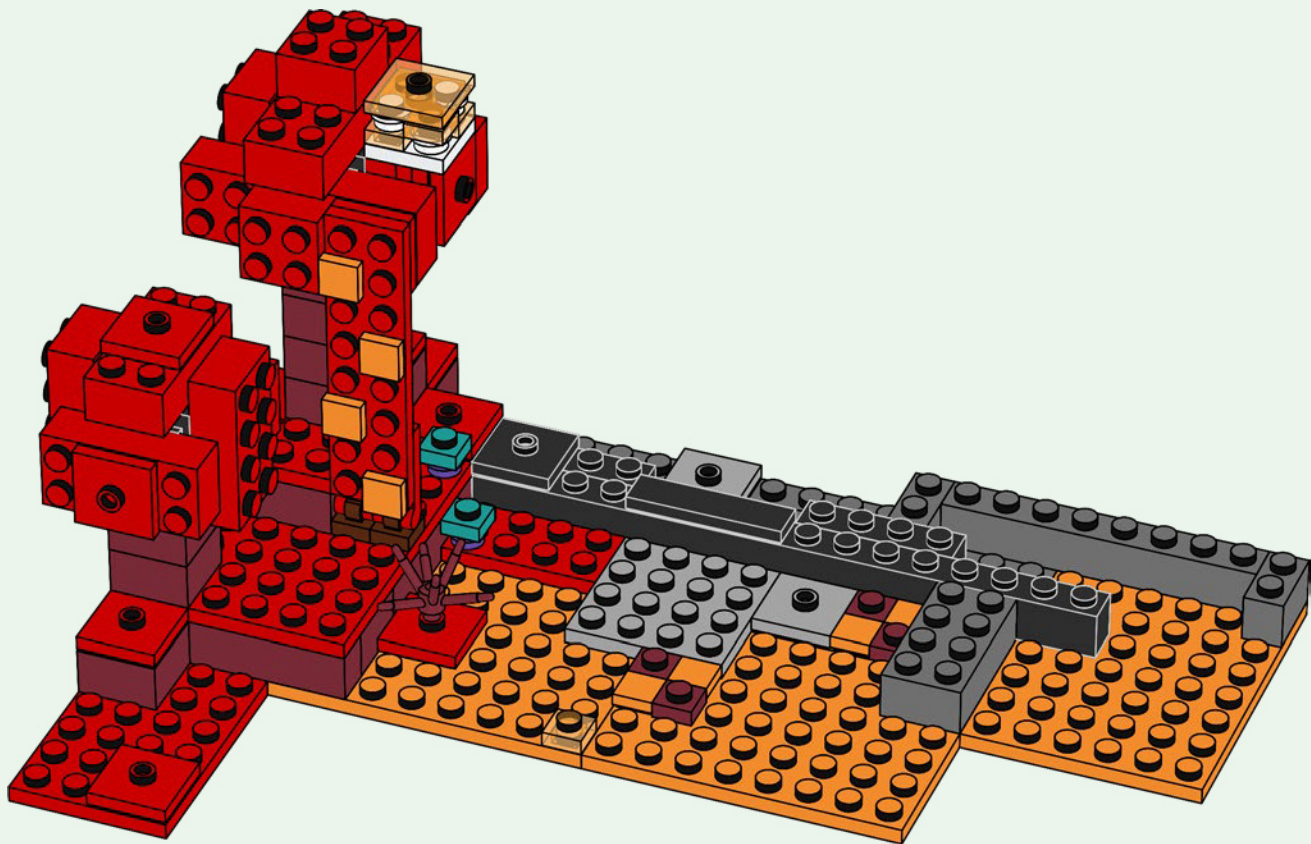

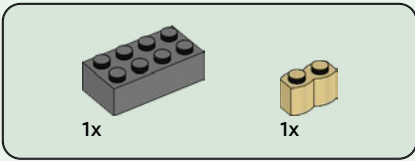

110

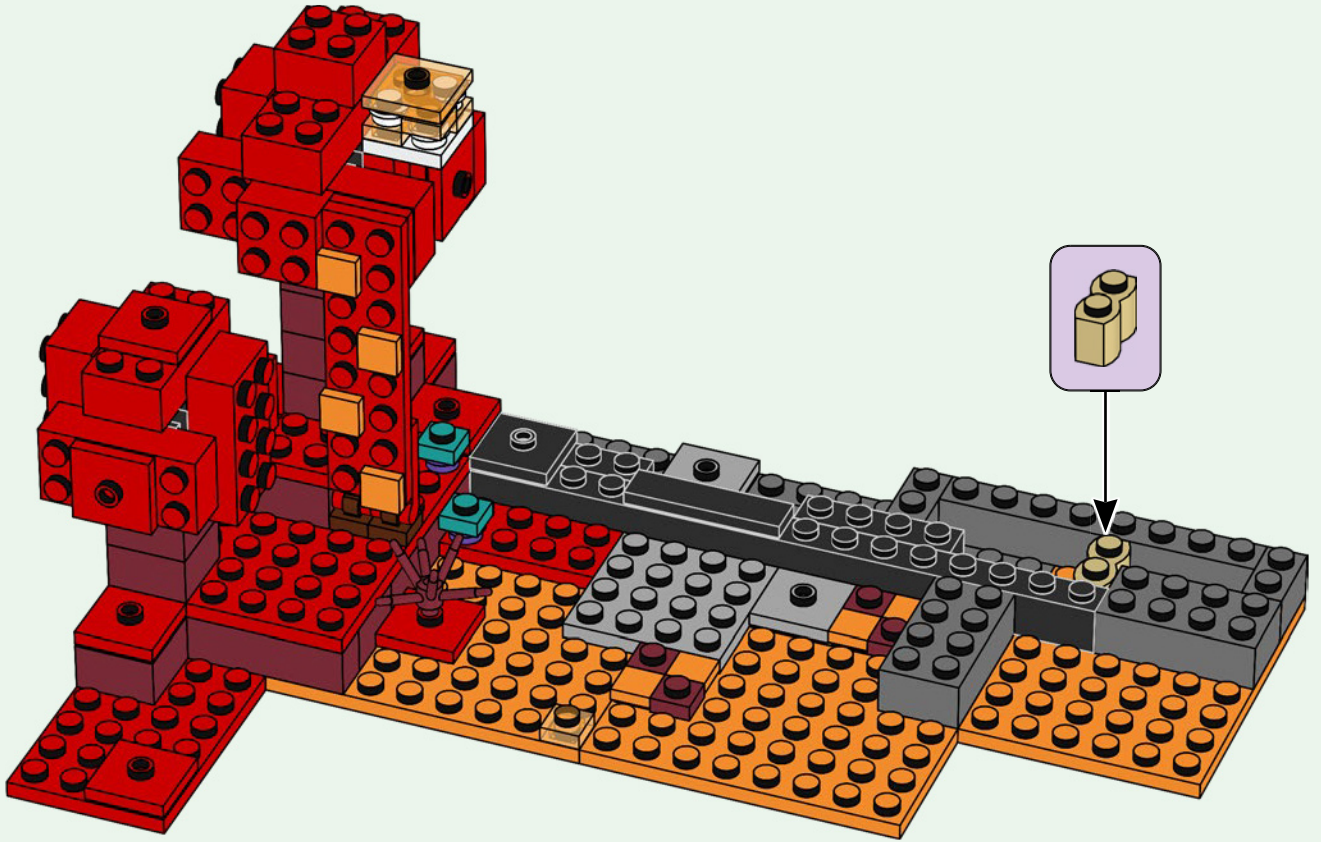

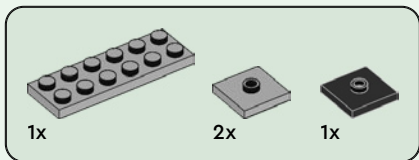

111

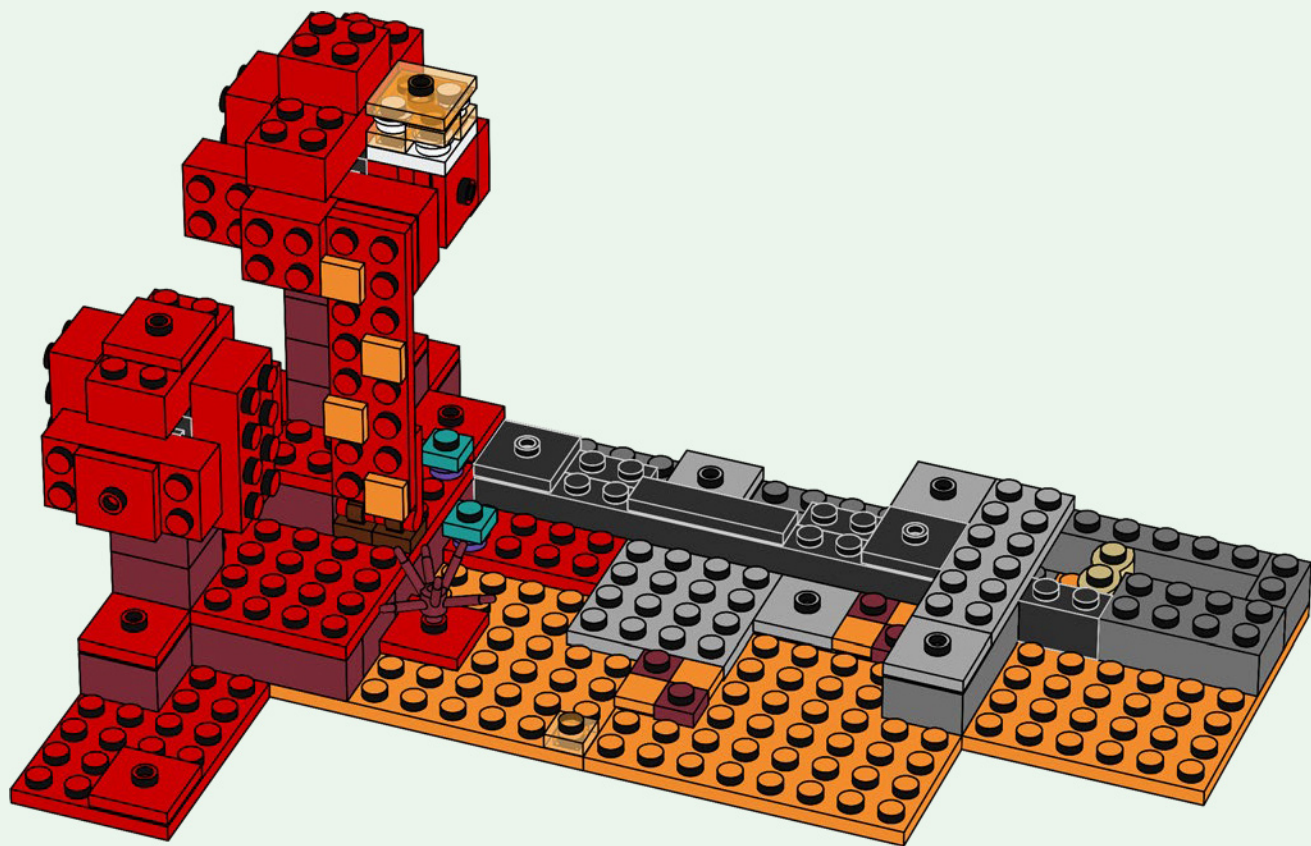

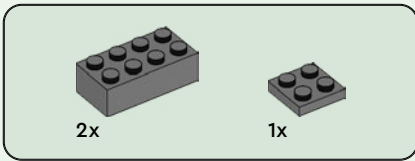

112

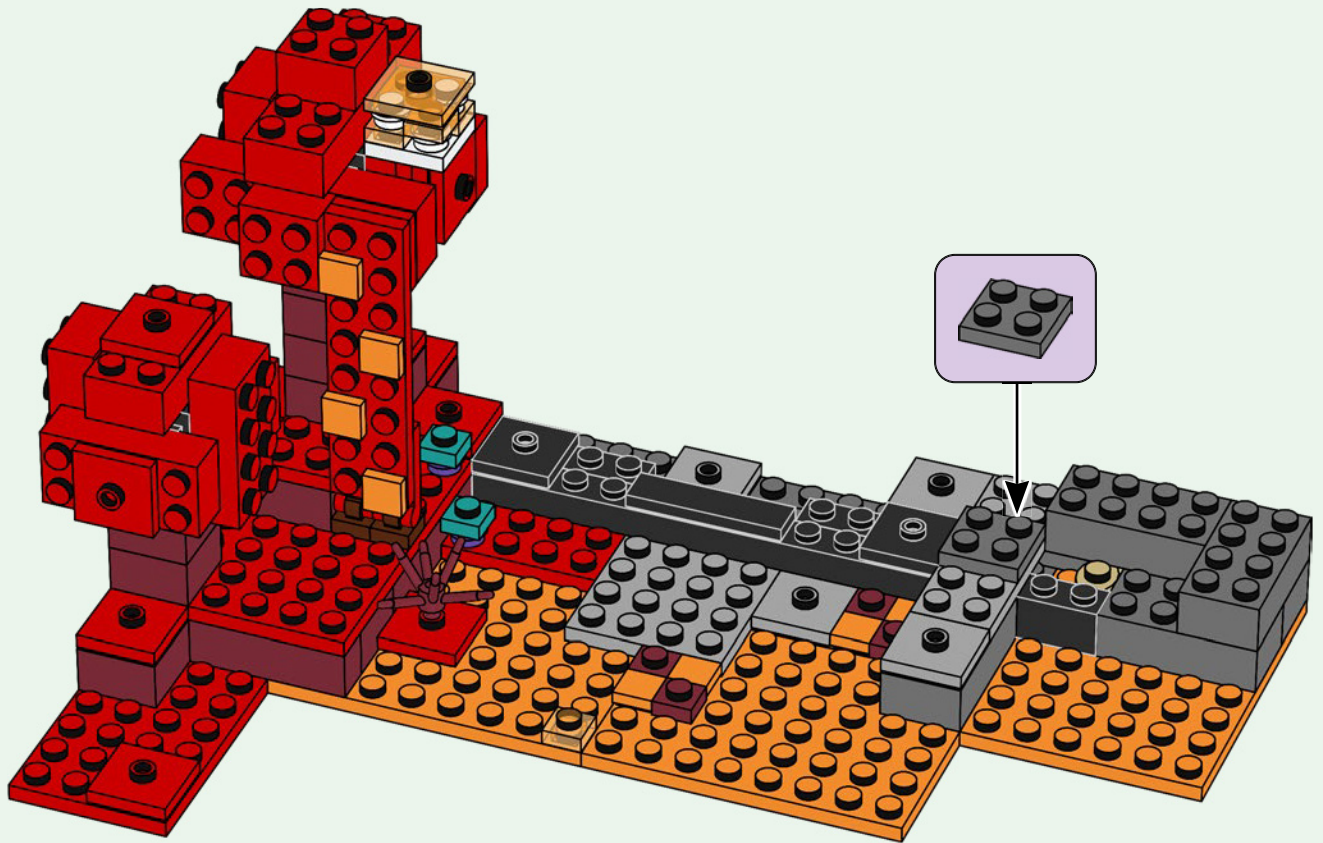



1x

113

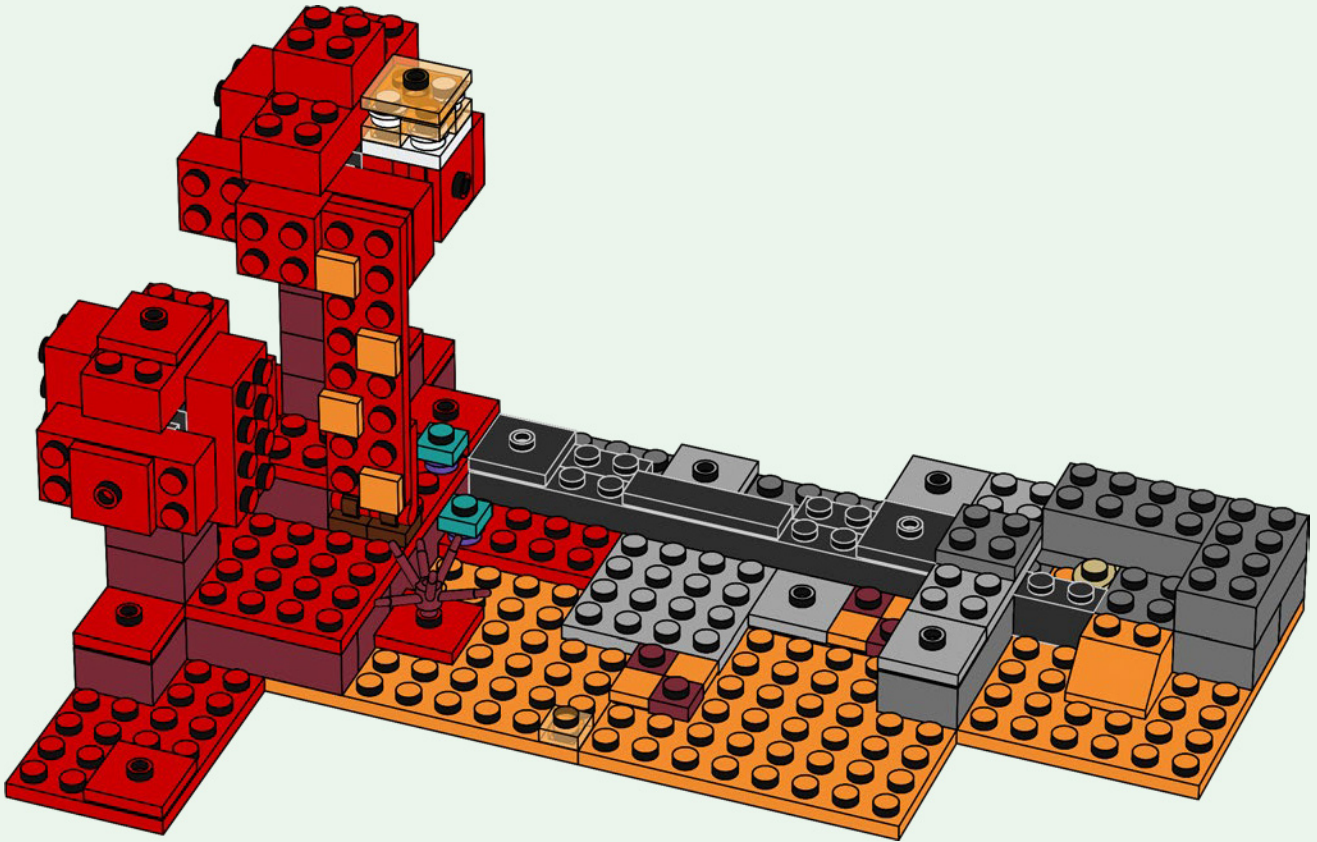

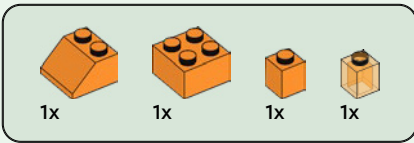

114

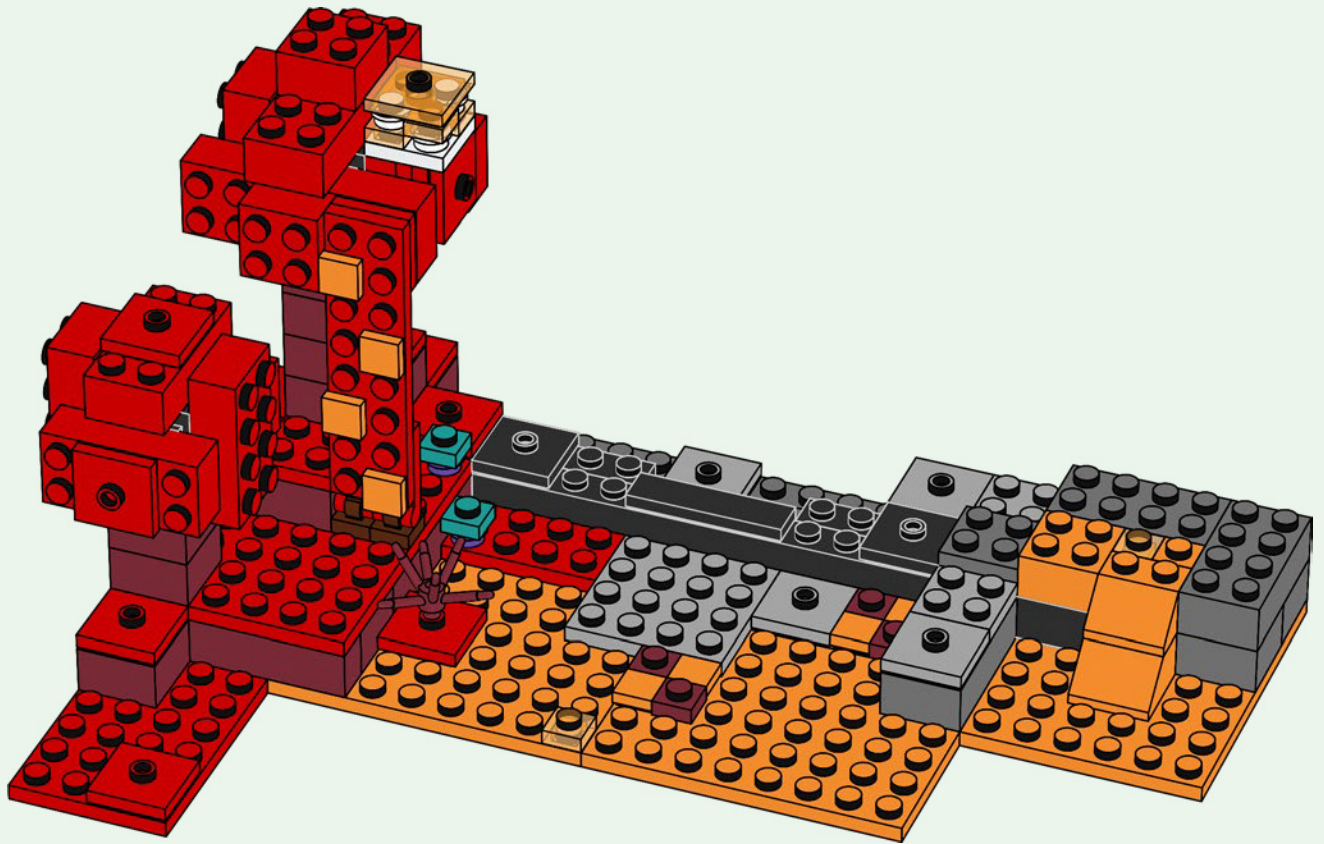



1x

115

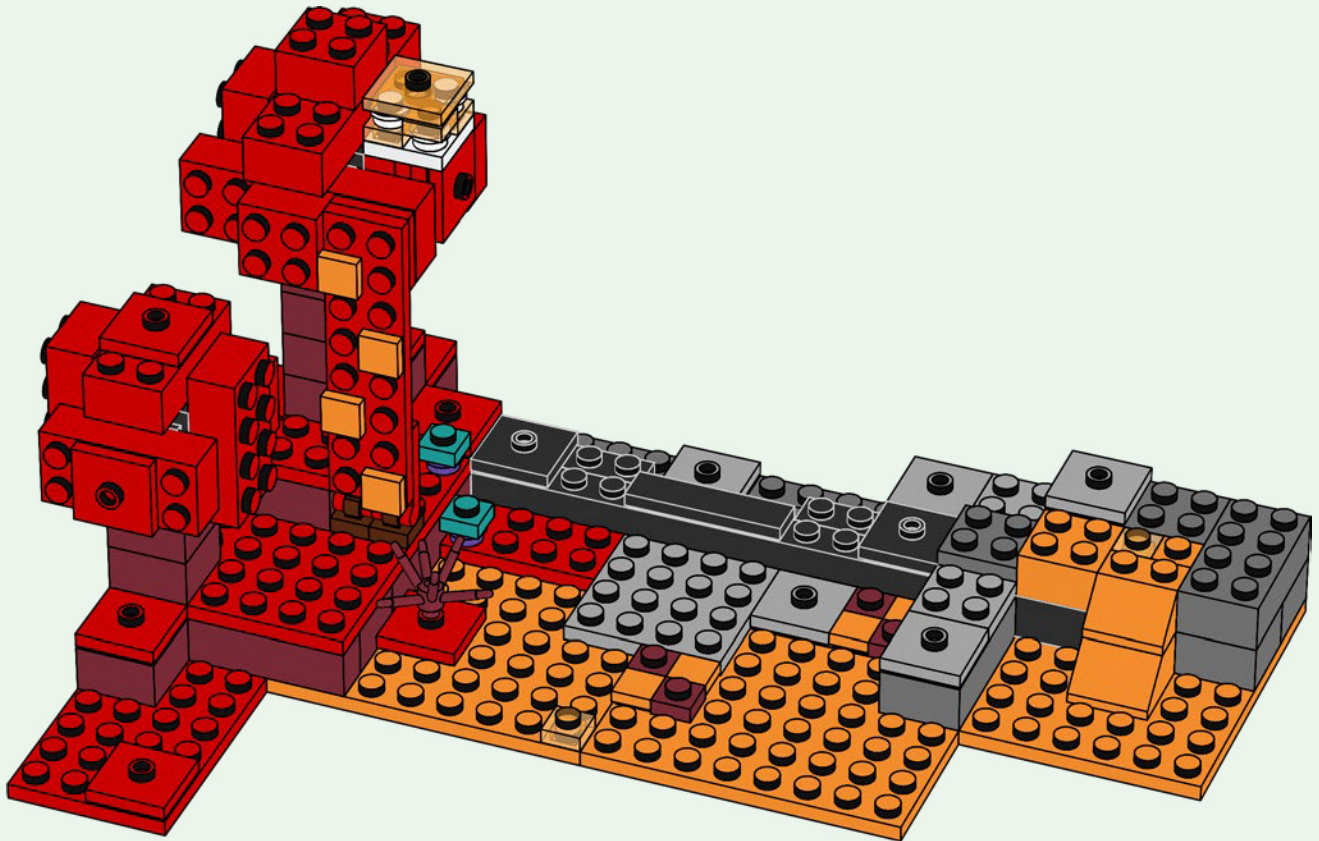

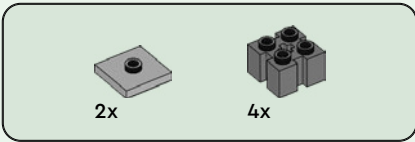

116

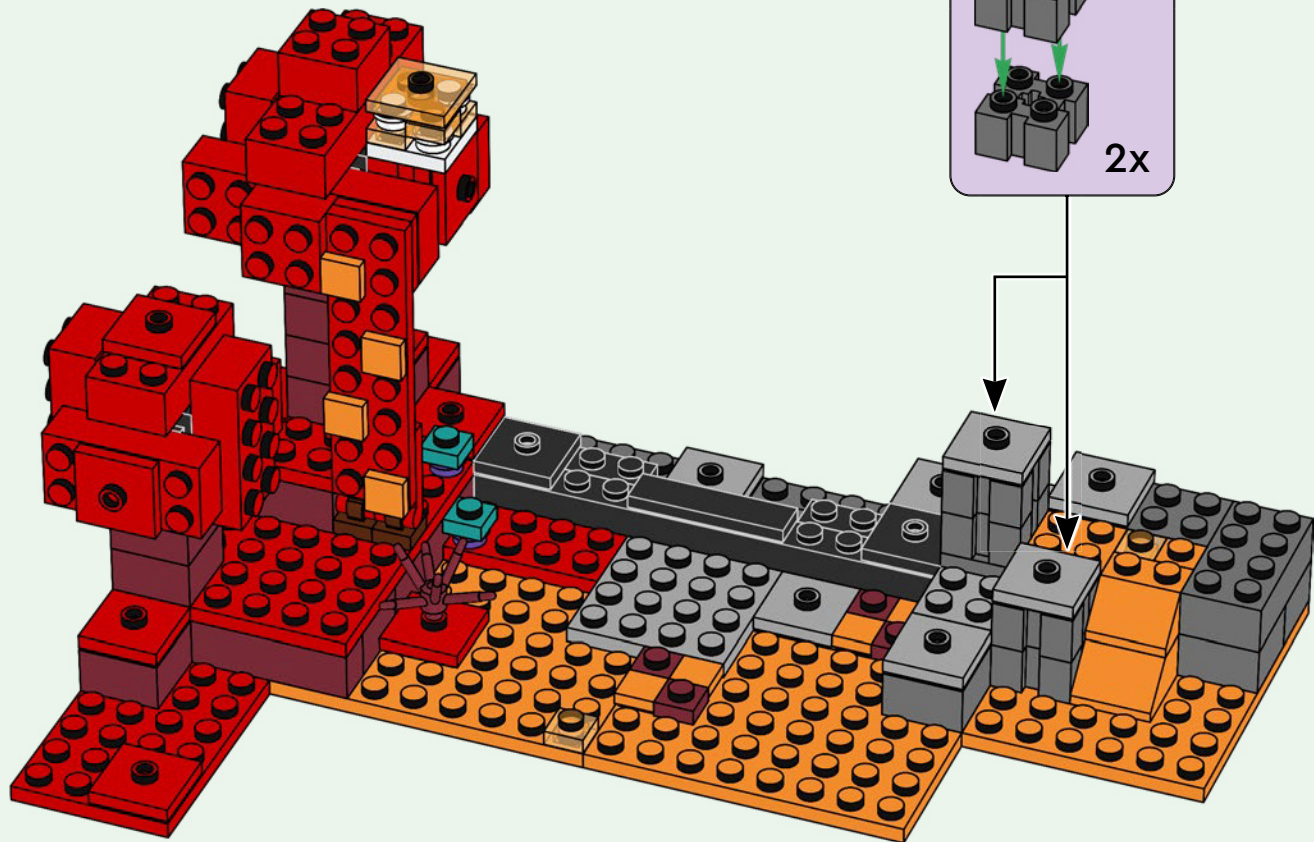

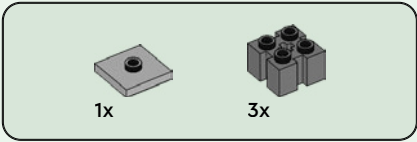

117

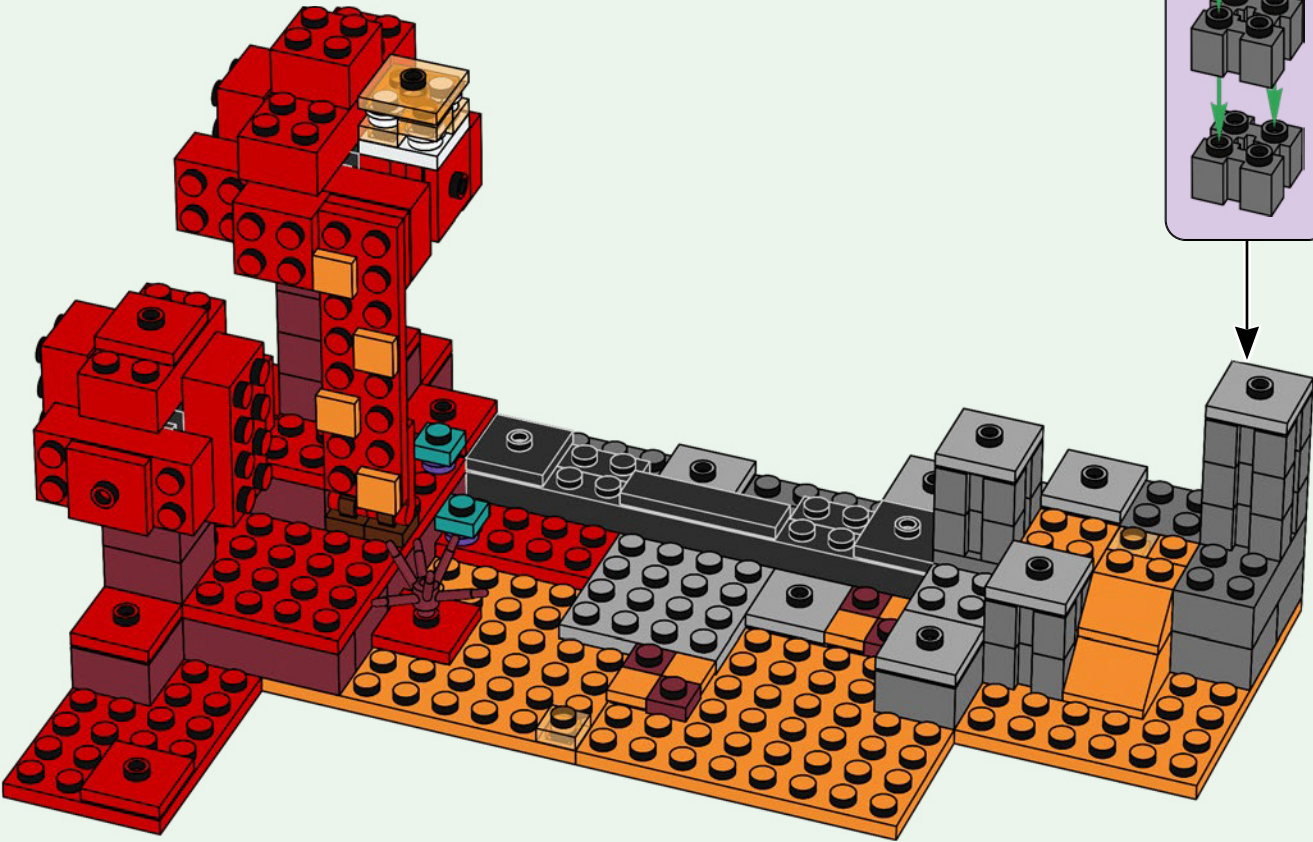



2x



4x

118

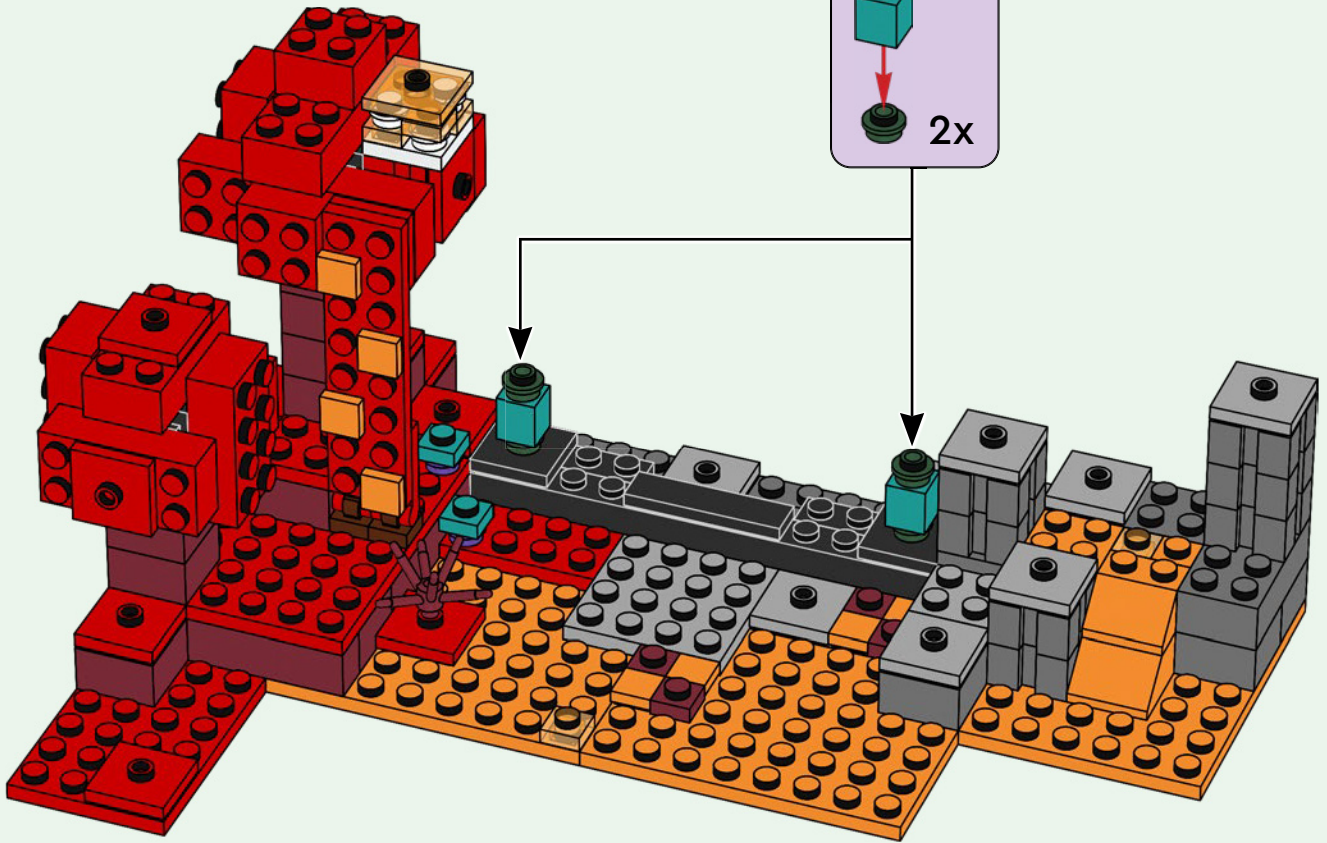
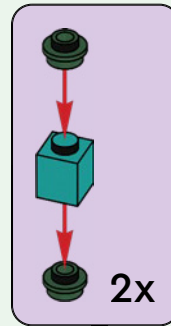

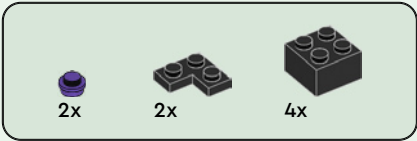

119

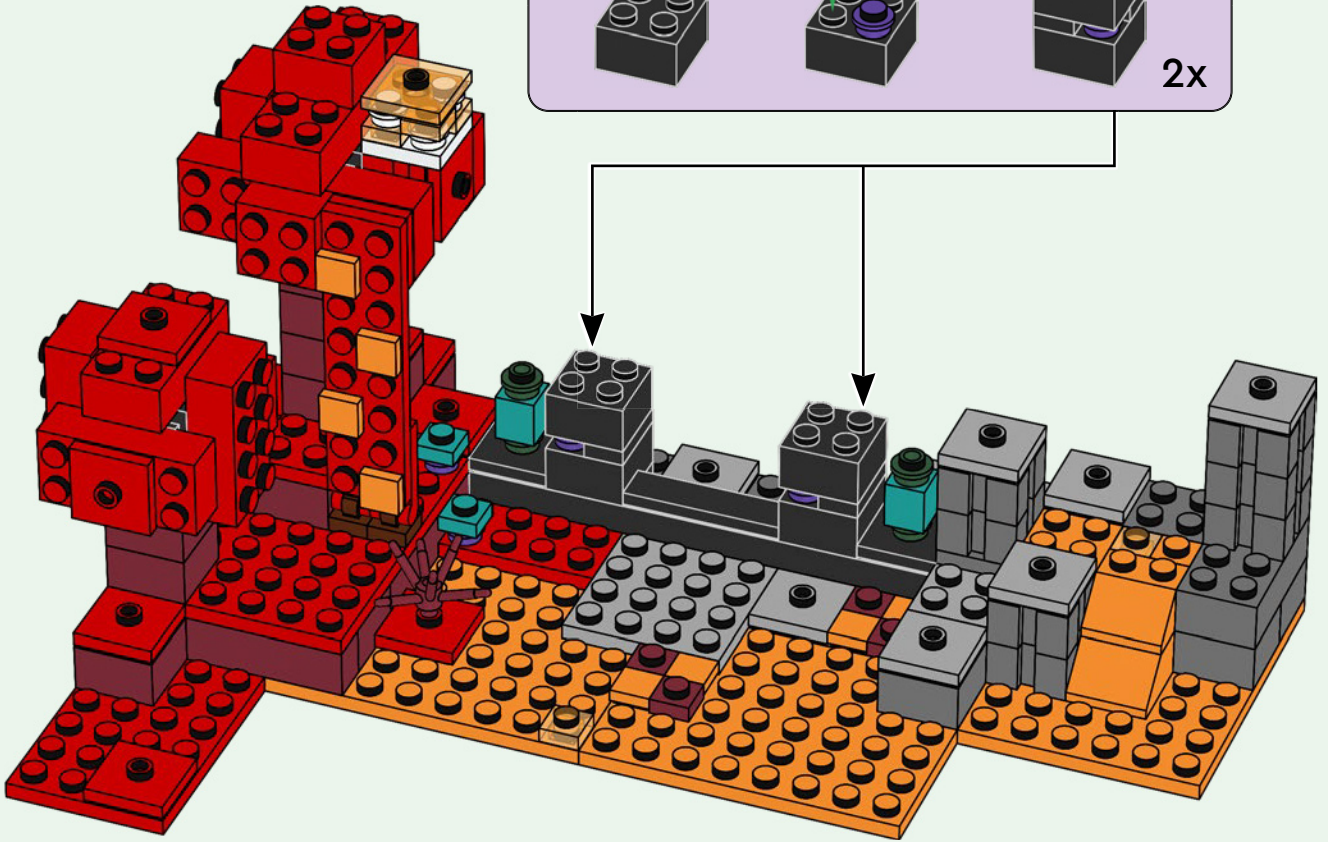
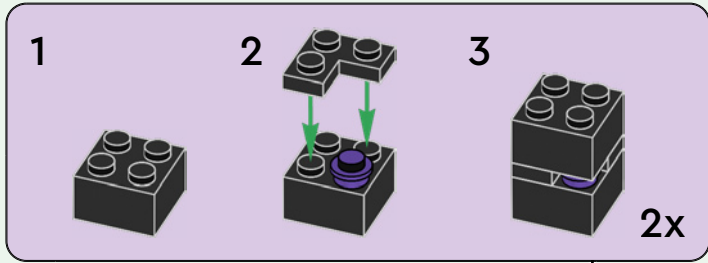



2x

120

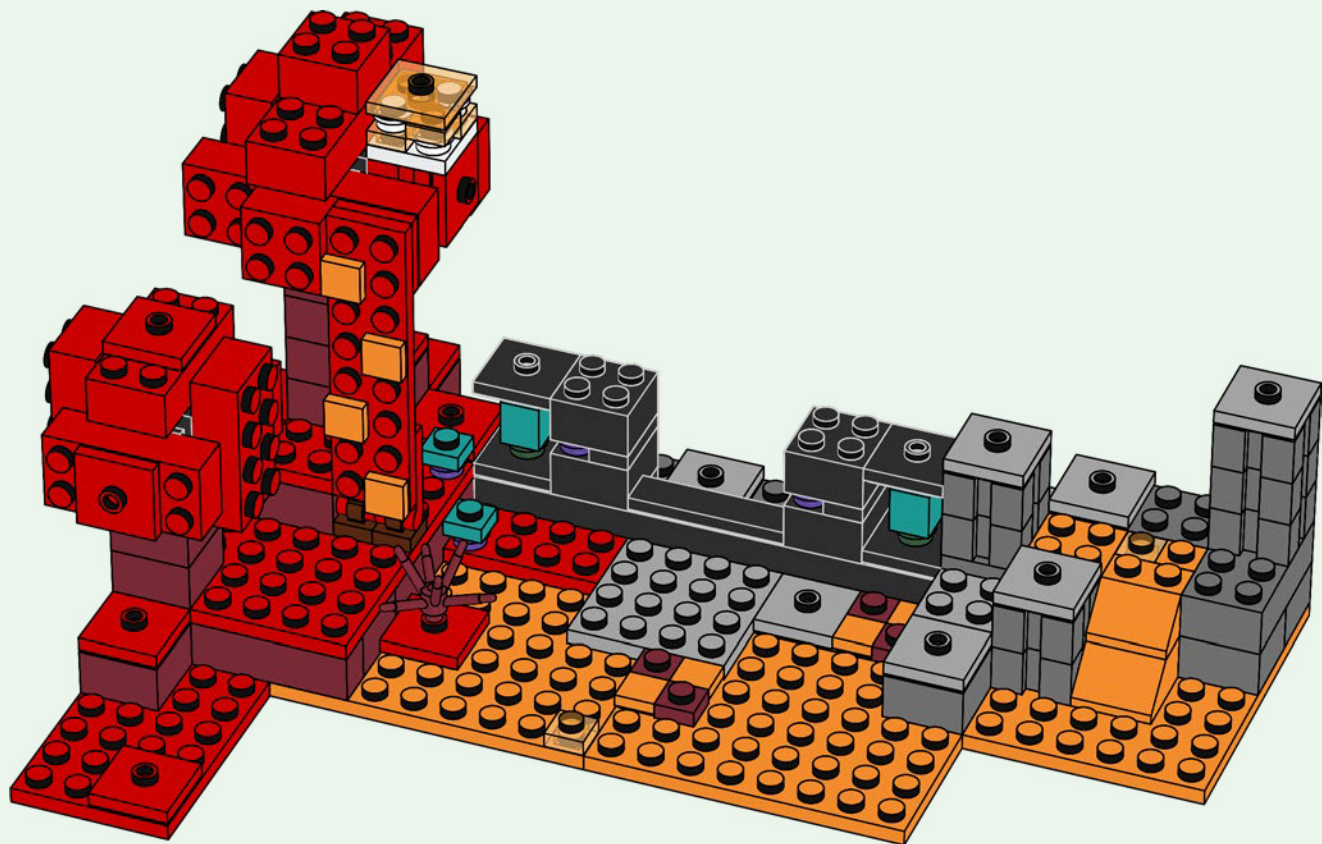



2x

121

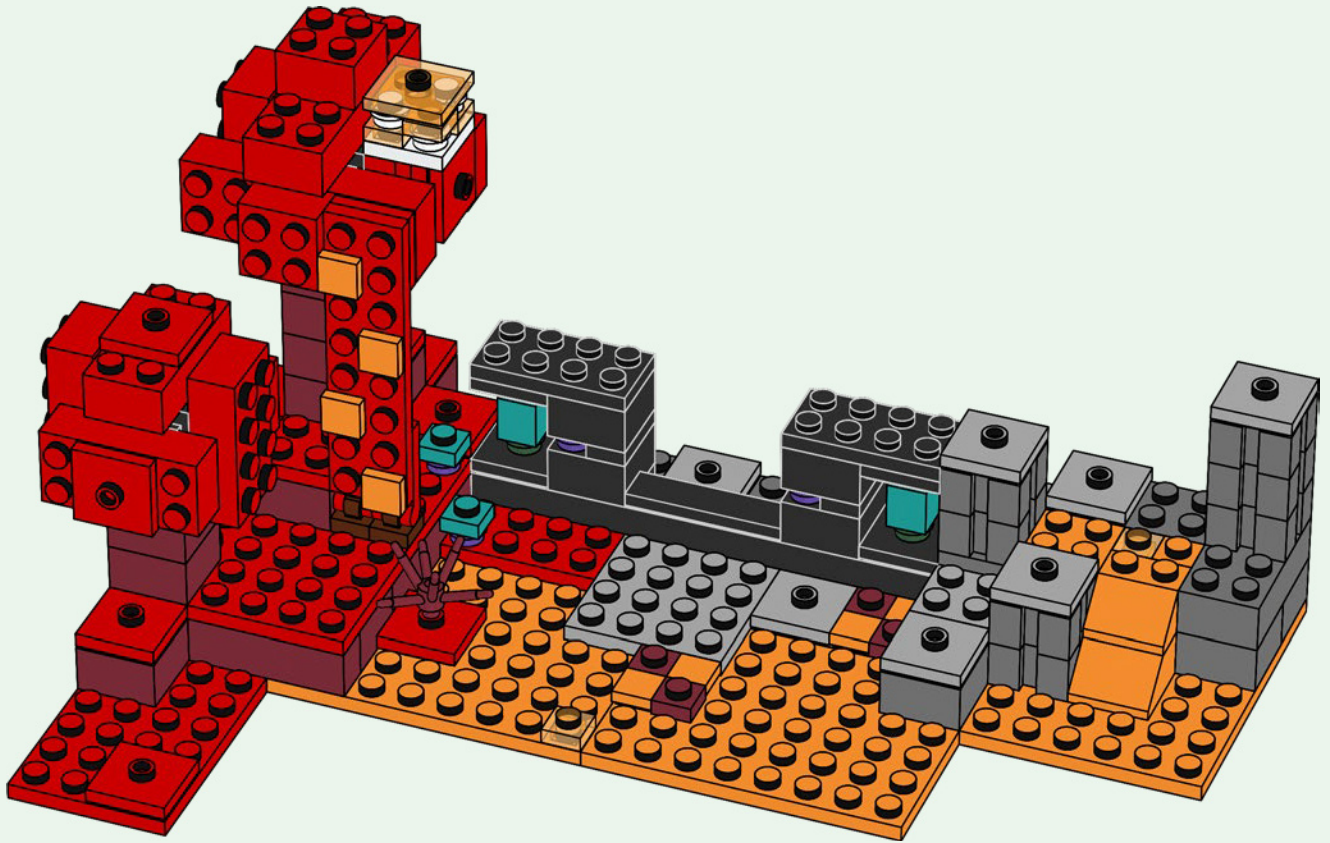

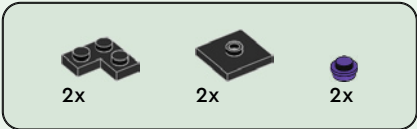

122

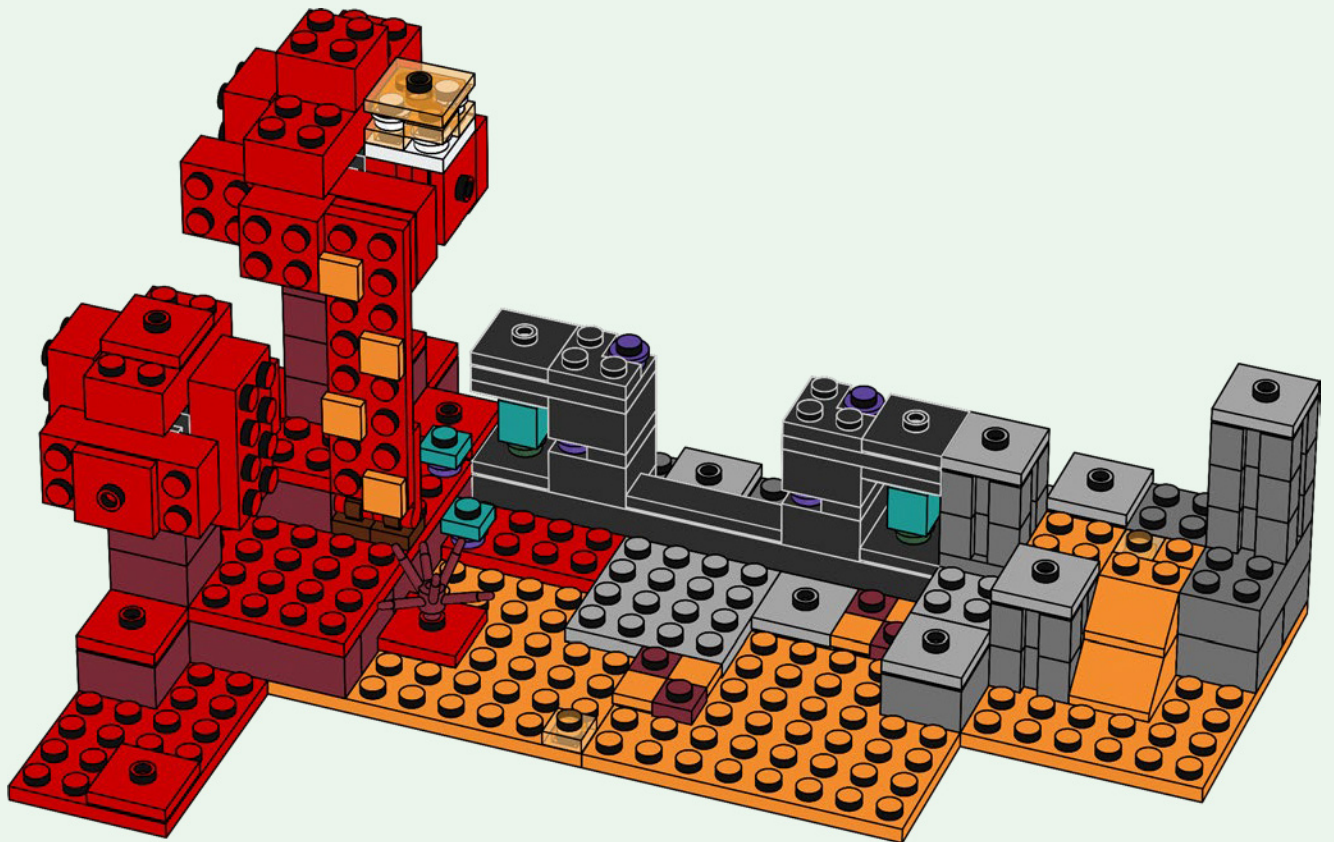



2x



2x

123



2x

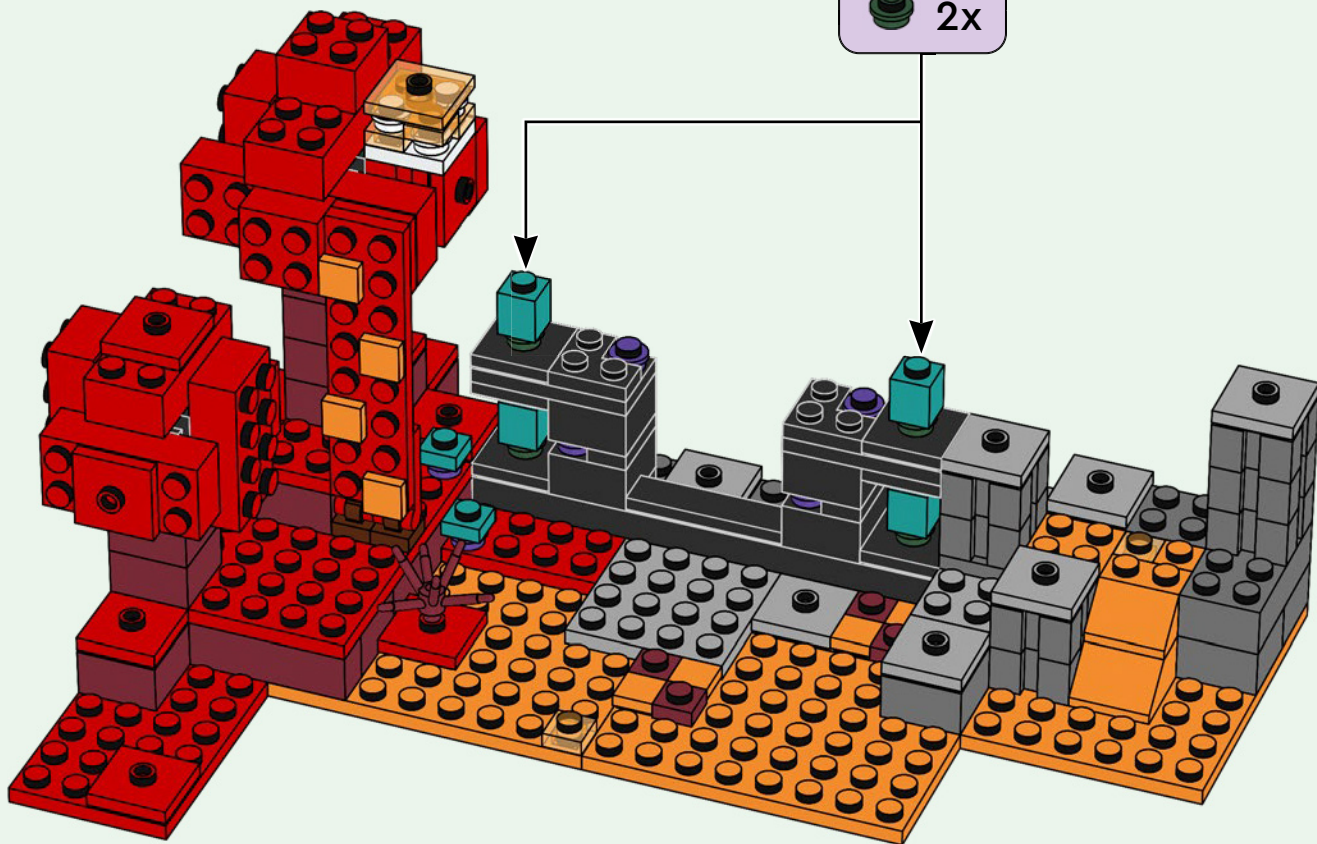

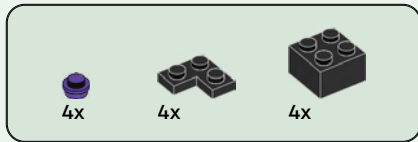

124

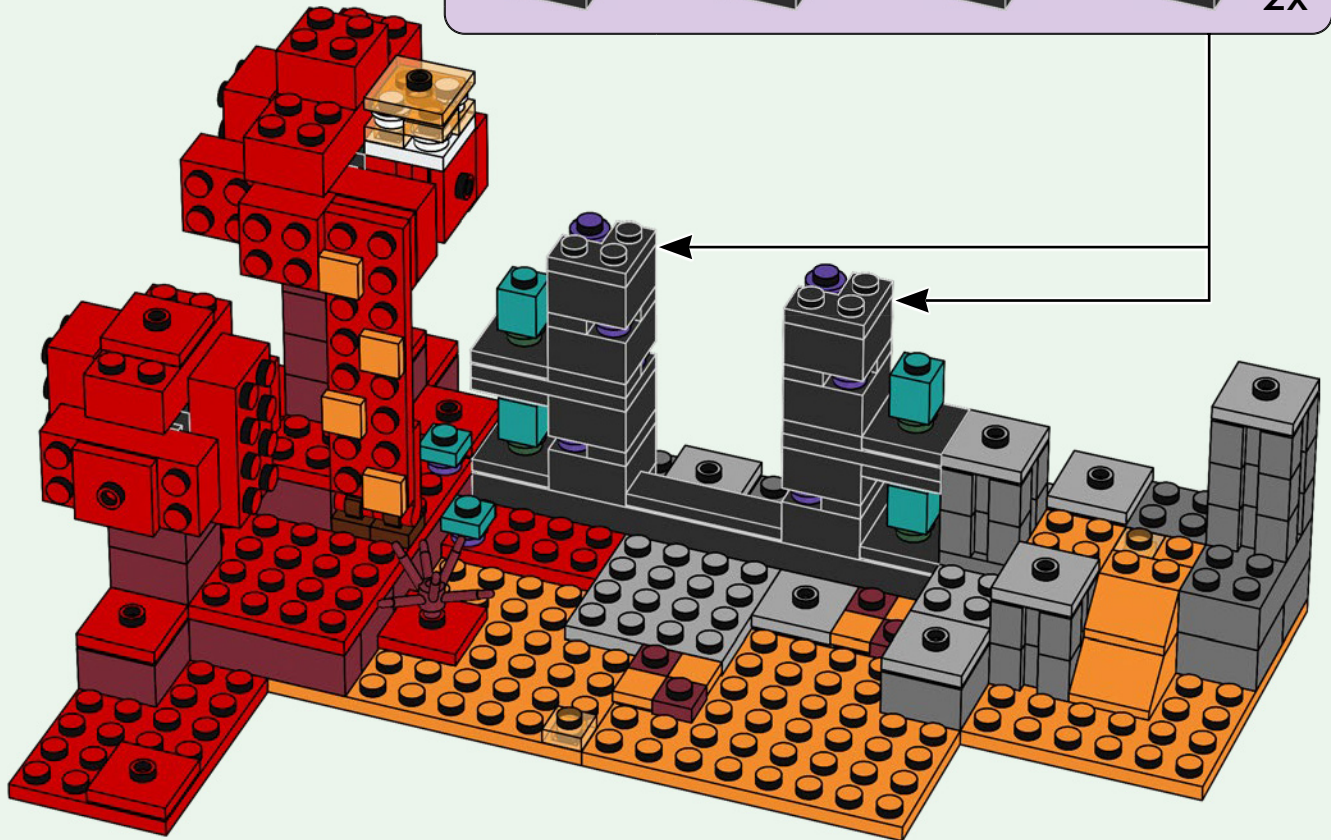
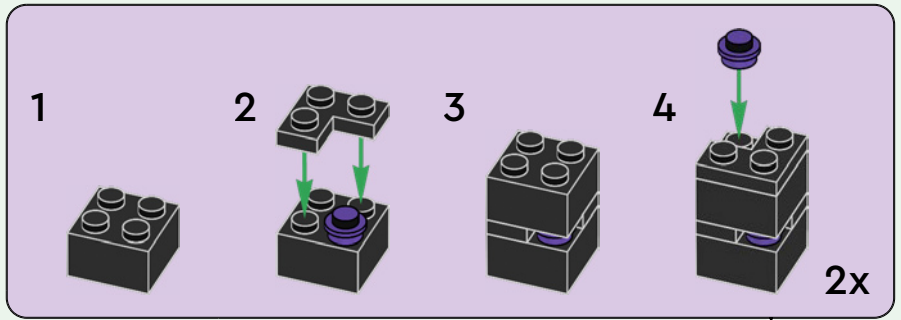

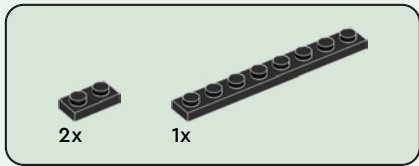

125

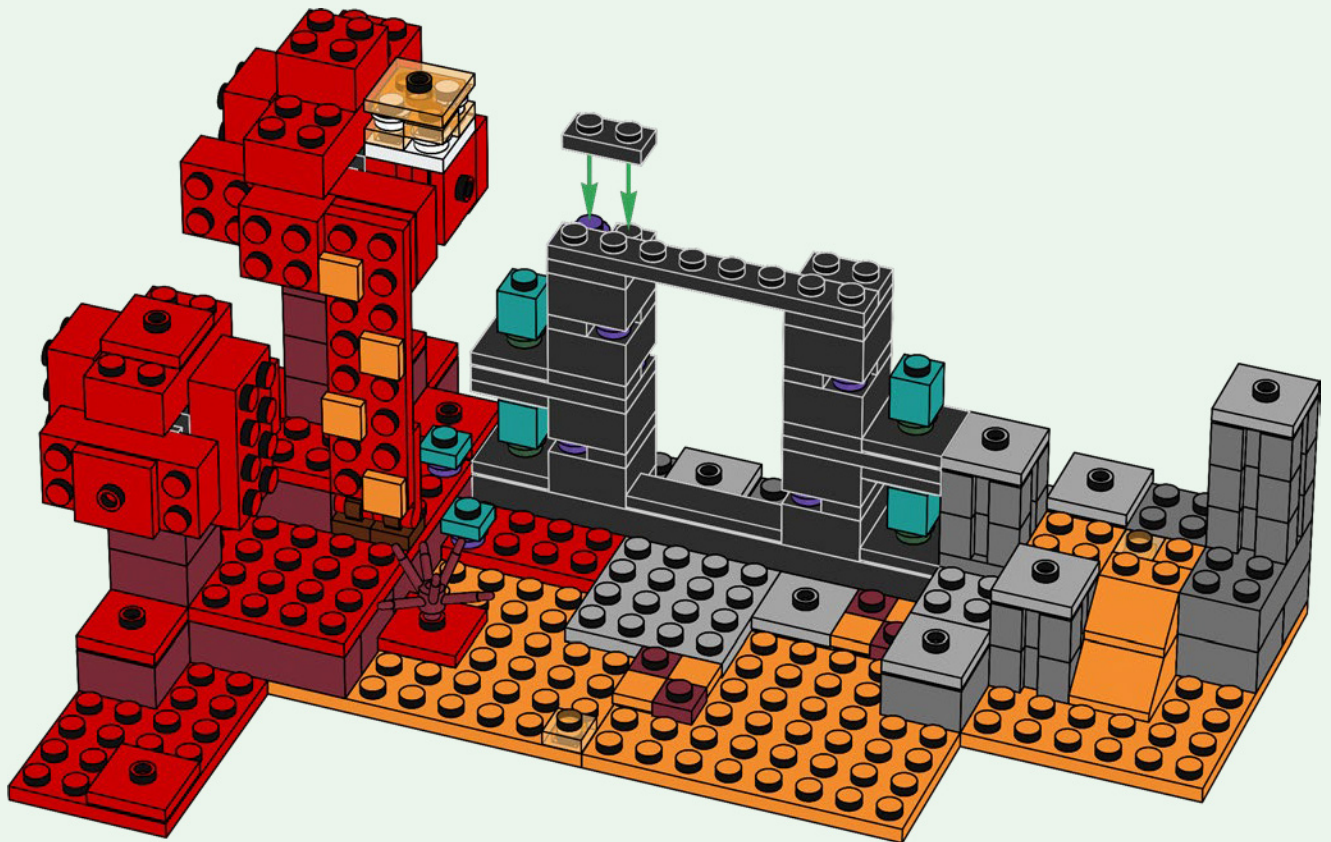



2x

126

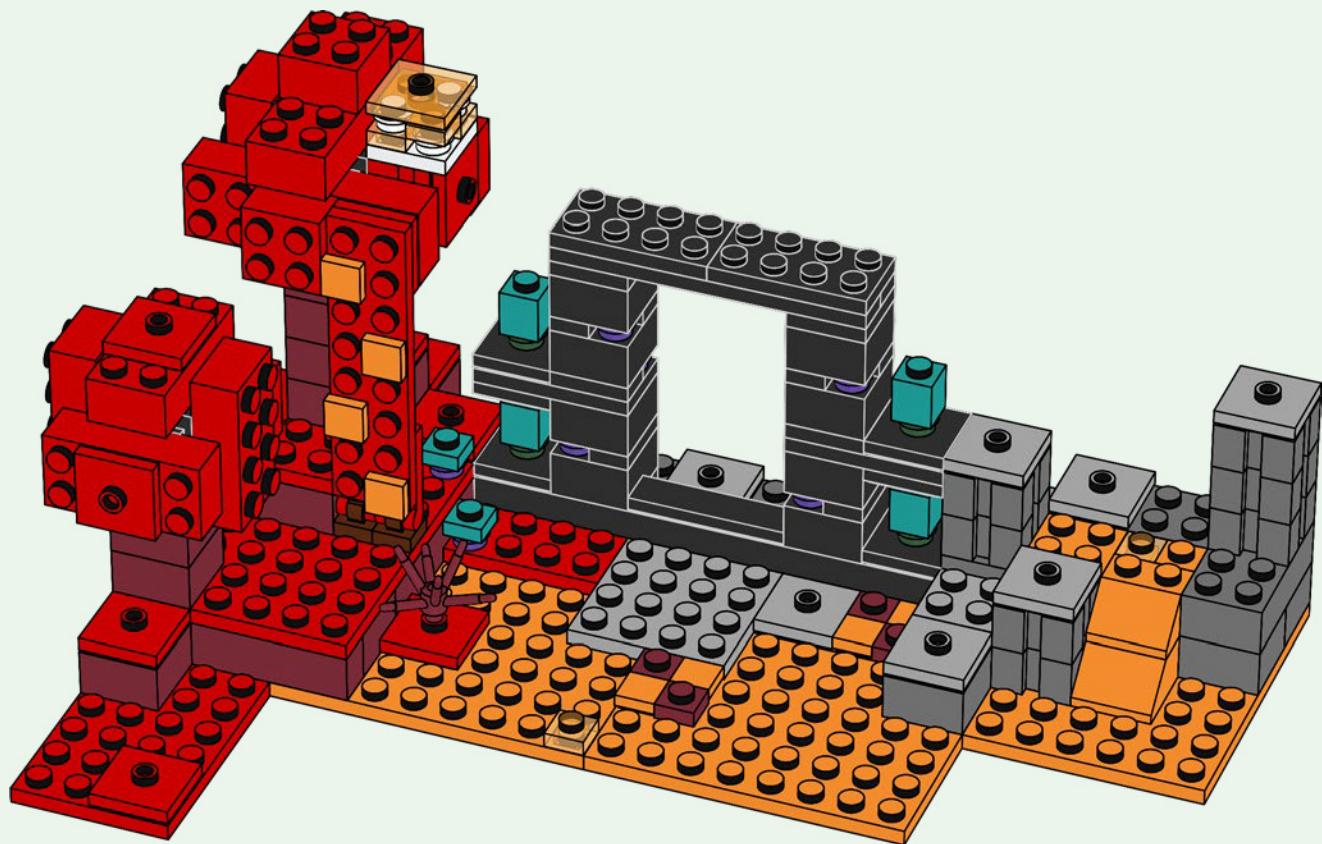



2x

127

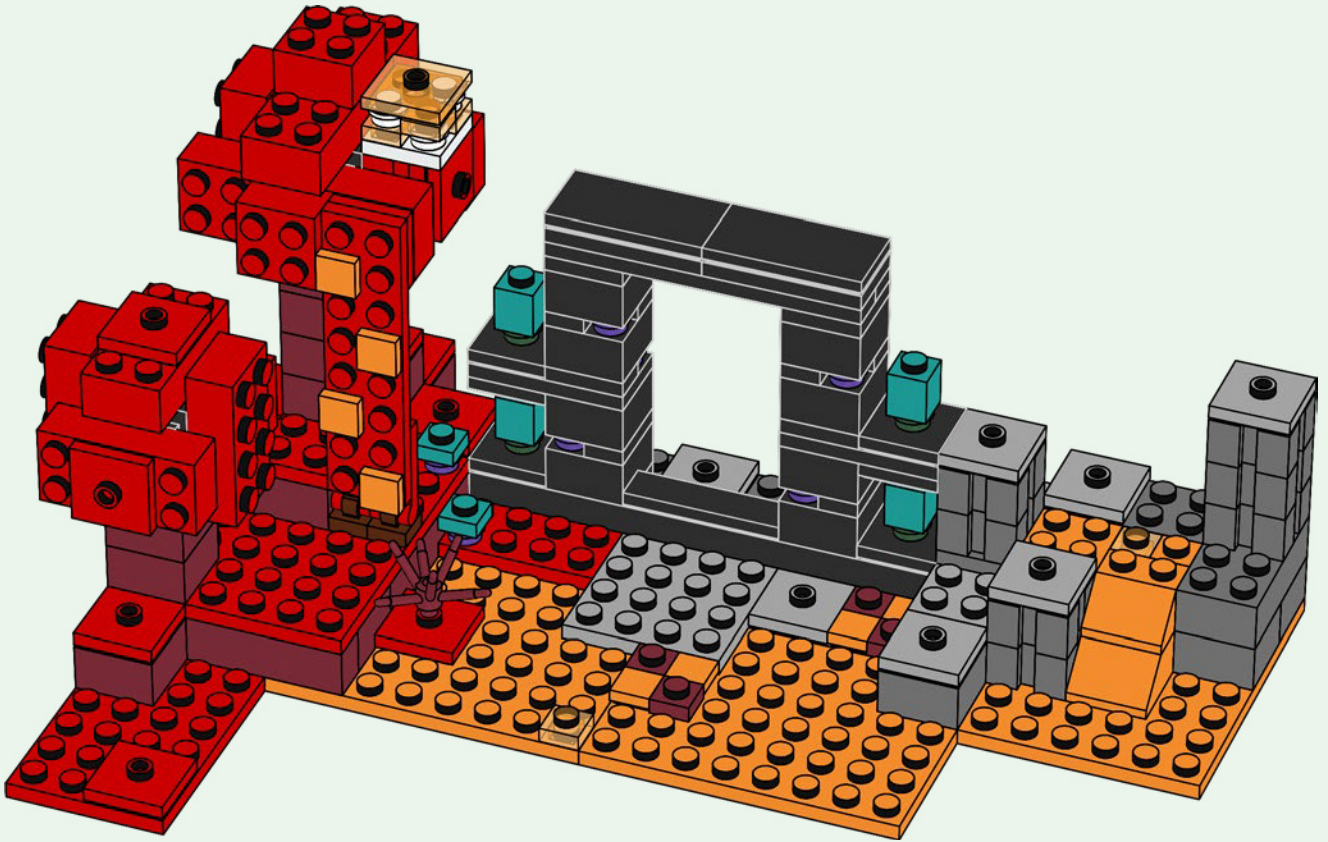

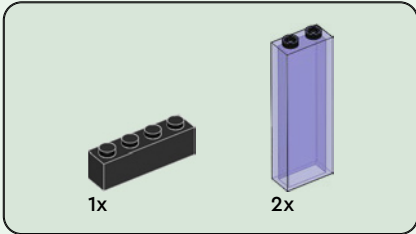

128

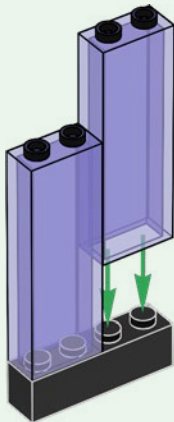

129

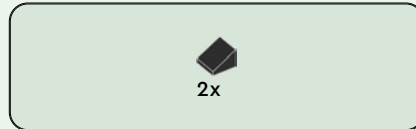
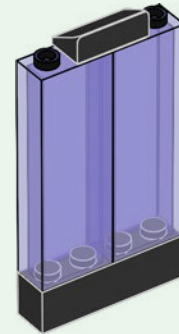

130



131

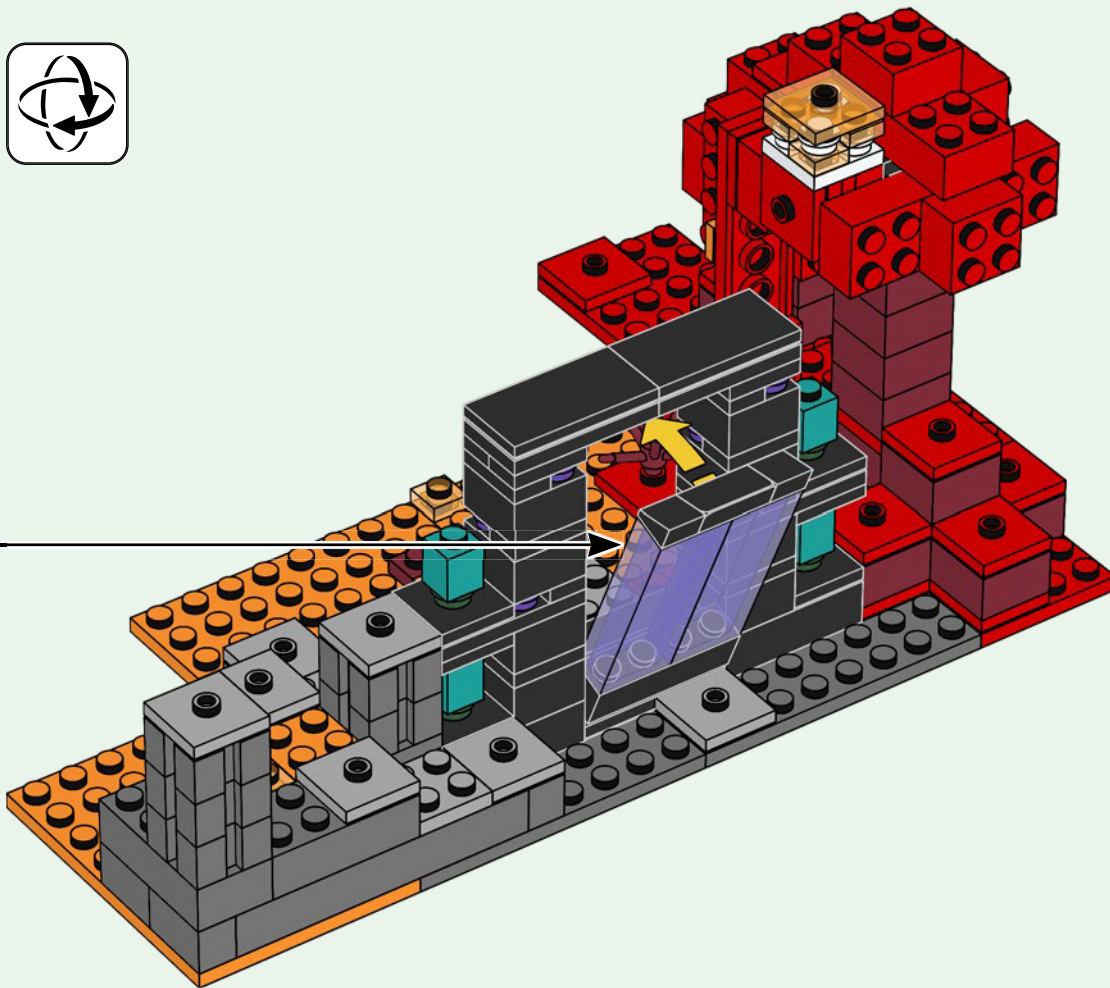

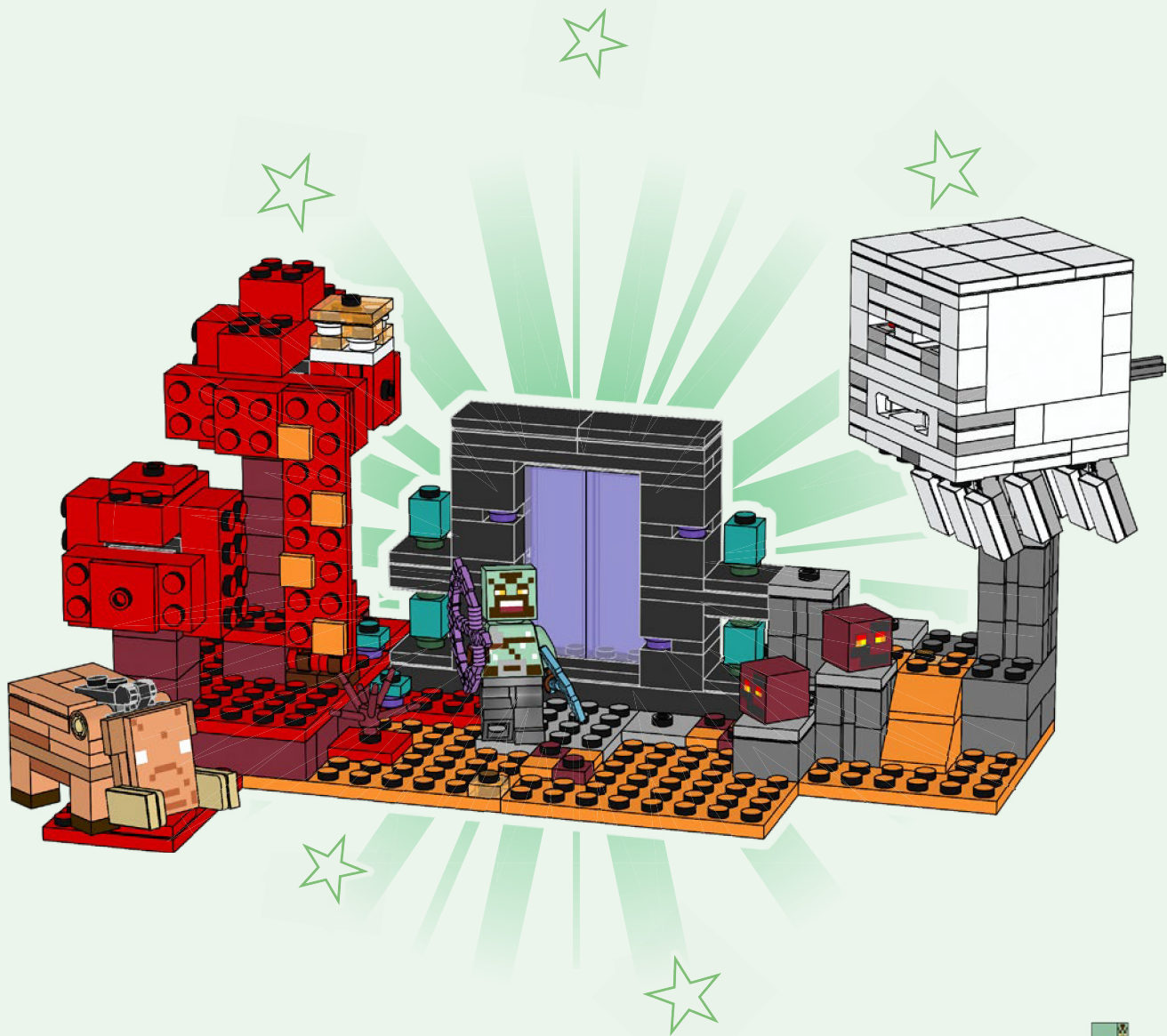



MINECRAFT

21256



21257



21251



21255



21252



21253



21254



MINECRAFT

Combine sets to expand your play!
Combiner les ensembles pour encore plus de jeu !
¡Combina sets para jugar mucho más!

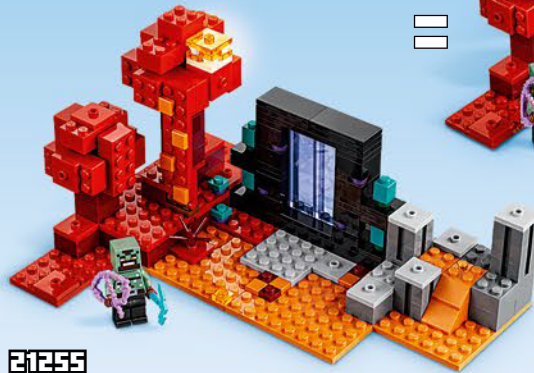
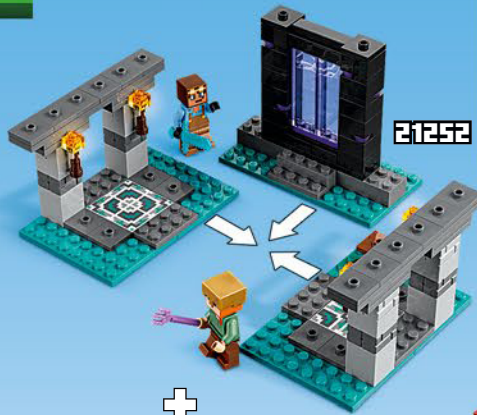



21253



21254

































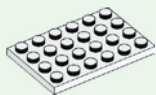













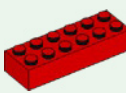



















Rebuild
the
world™





Rebuild
the
world™



 4x 614101	 2x 300901	 1x 6330584	 1x 6469446	 2x 4504382	 8x 300326
 8x 300501	 2x 366601	 7x 6330401	 6x 300121	 1x 4548180	 8x 242026
 2x 4504369	 2x 379501	 2x 6469437	 1x 6393344	 2x 6468479	 1x 6267045
 13x 306901	 1x 303201	 1x 6328177	 2x 302021	 1x 6266244	 3x 301026
 10x 6051511	 2x 6357613	 2x 6469438	 1x 4243814	 2x 302326	 2x 243126
 1x 302201	 1x 4218749	 2x 6330405	 3x 4181138	 2x 6146220	 1x 371026
 10x 6013866	 2x 4114026	 1x 6468477	 1x 303421	 6x 6117973	 4x 302026
 6x 6265740	 2x 6214334	 2x 6223427	 1x 303521	 6x 4565323	 2x 4560182
 2x 371001	 2x 4109995	 1x 6271820	 1x 303621	 1x 346026	
 2x 300201	 1x 6321305	 2x 302321			
 1x 6469439	 1x 4243824	 2x 241221			
 2x 4558208		 13x 6126048			
		 2x 4515365			
		 3x 300321			



1x
6186007



2x
6359717



4x
6213776



2x
6213778



8x
4558595



1x
4173805



2x
4118828



1x
4153825



3x
6424454



1x
6396058



2x
4211088



3x
6265693



7x
6236949



1x
4211094



2x
6013082



4x
4211085



1x
4508553



1x
4211099



2x
4210794



6x
6230571



4x
4549436



1x
6353064



1x
6468475



1x
6470807



4x
4539114



1x
6394946



2x
6468478



3x
4539102



11x
4539104



2x
6052777



3x
6117418



2x
6348057



4x
4216695



1x
4565394



2x
4211399



1x
6345639



8x
4211398



1x
4211440



8x
6126082



9x
6267048



1x
4243797



2x
4211438



1x
4211452



8x
6194729



2x
6350502



1x
6240550



5x
6252040



1x
6394956



1x
6167567



10x
4566522



1x
6056383



1x
6292145



1x
6167700



1x
6093494



1x
6197015



1x
6093629



 LEGO.com/service

YOU COULD **WIN**



Scan this QR code or go to **LEGO.COM/PRODUCTFEEDBACK** and give us your short feedback about this LEGO® set for a chance to win a cool LEGO prize.

Terms and Conditions apply*

EN: YOU COULD WIN. Terms and Conditions apply* **DE: Du könntest GEWINNEN.** Es gelten die Teilnahmebedingungen* **FR: Tu pourrais GAGNER.** Des conditions s'appliquent* **IT: Potresti VINCERE tu.** Termini e condizioni sono applicabili* **ES: Puedes GANAR.** Aplican términos y condiciones* **PT: Poderá GANHAR.** Aplicam-se termos e condições* **ZH: 轻松获奖. 条款和条件适用*** **PL: Szansa na WYGRANĄ.** Obowiązują warunki korzystania* **CS: Máte šanci VYHRÁT.** Platí všeobecné smluvní podmínky* **SK: Máte šancu VYHRAŤ.** Platia všeobecné zmluvné podmienky* **HU: TE IS NYERHETSZ.** Felhasználási feltételek érvényesek* **RO: Ai putea CÂȘTIGA.** Se aplică termeni și condiții* **BG: Можете да СПЕЧЕЛИТЕ.** Има определени правила и условия* **LV: Tu vari LAIMĒT.** Ir spēkā noteikumi un nosacījumi.* **ET: Sul on võimalus VÕITA.** Kehtivad tingimused* **LT: Jūs galite LAIMĖTI.** Taikomos sąlygos*

*[LEGO.com/productfeedback-terms](https://www.lego.com/productfeedback-terms)

LEGO and the LEGO logo are trademarks of the/son des marques de commerce du/son marcas registradas de LEGO Group. ©2024 The LEGO Group.

© 2024 Mojang AB. All Rights Reserved. Minecraft, the Minecraft logo, the Mojang Studios logo and the Creeper logo are trademarks of the Microsoft group of companies.

6495807