



21061



Notre-Dame de Paris

Booklet available in English
Heft in deutscher Sprache erhältlich
Livret disponible en français
Libretto disponibile in italiano
Folleto disponibile en español
如需中文版手册

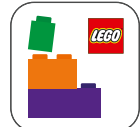

LEGO® Builder

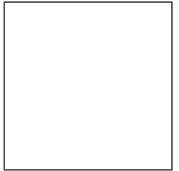



LEGO.com/sustainable-packaging



FR
DONNEZ
OU
RECYCLEZ



ASSOCIATION

OU



MAGASIN

OU



DÉCHÈTERIE

Adresses sur quefairedemesdechets.fr



BUILDER



Apple and the Apple logo are trademarks of Apple Inc., registered in the U.S. and other countries and regions. App Store is a service mark of Apple Inc. Google Play and the Google Play logo are trademarks of Google LLC. Tencent and the Tencent logo are trademarks of Tencent Inc.

LEGO.com/devicecheck



LEGO® Builder



NOTRE-DAME DE PARIS

☞ "It's hard to imagine Paris without the majestic Notre-Dame Cathedral. Over the centuries, the spectacular landmark has weathered the elements, revolution and devastating destruction, and remains one of the most popular tourist attractions in Paris. When you see it in all its seemingly gravity-defying splendour, you may wonder how architects, masons and builders created such a monument, starting nearly 900 years ago, with construction going on for centuries. Inspired and awed by the ingenious techniques employed by these craftsmen, we set out to 'translate' this magnificent construction and its intricate details into a LEGO® model."

"These instructions will guide you through the building process, with each brick carefully placed to correspond with a specific architectural element in the original cathedral. With every bag you complete, you will see a model of a specific point in time in the construction of the cathedral, from 1163 to today."

Rok Žgalin Kobe, Senior LEGO® Designer



1163-1182

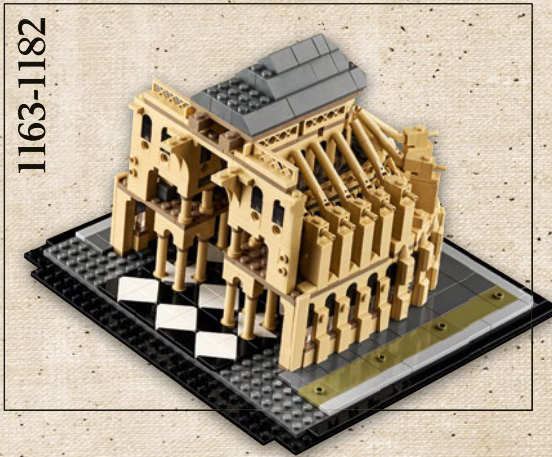

1163-1182: The east side of the cathedral was completed first and served as a functioning church while construction continued on the rest of the cathedral.

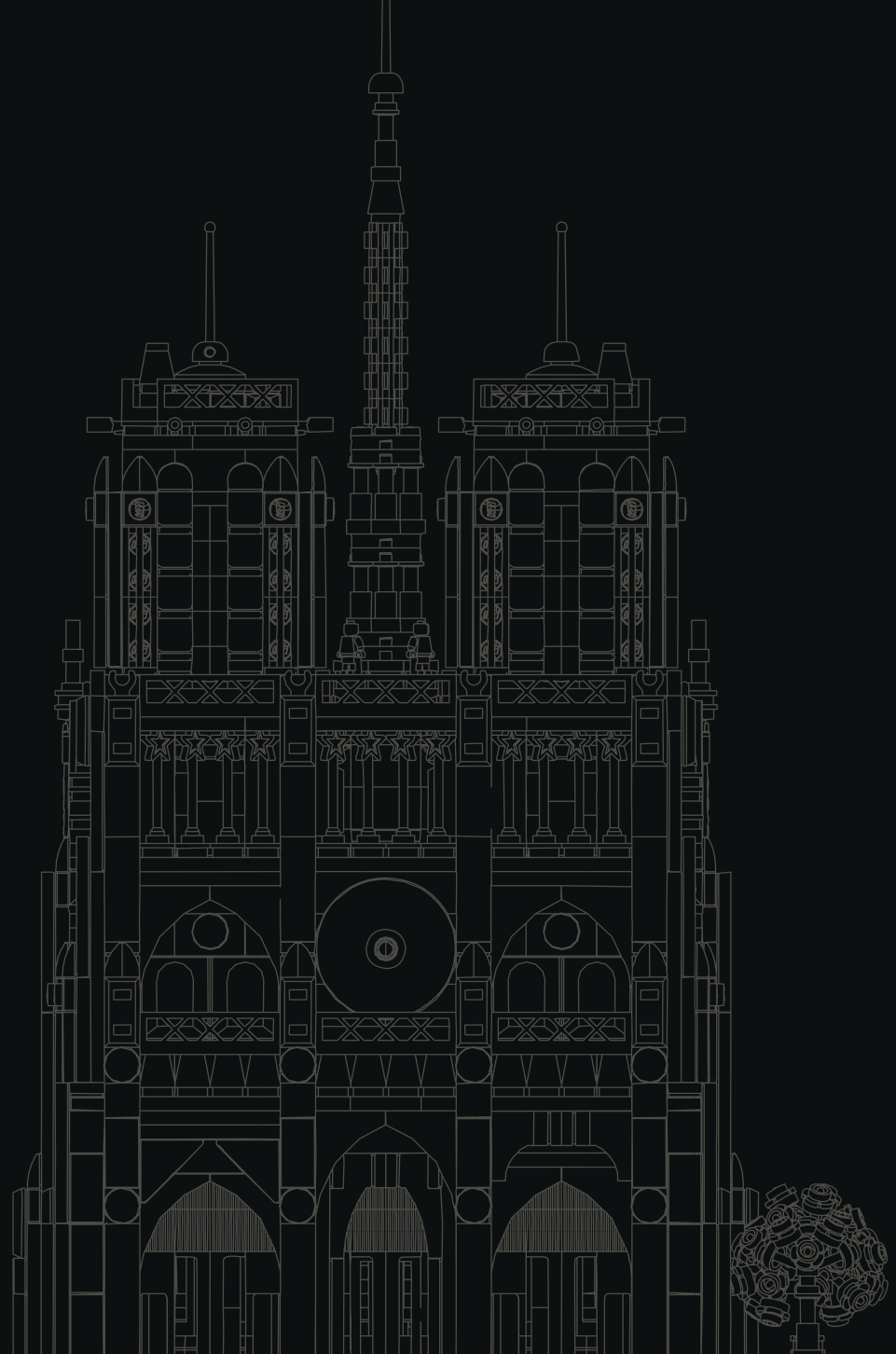

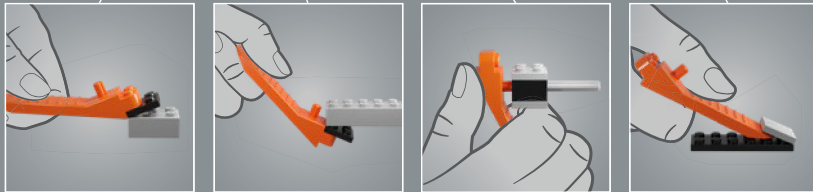
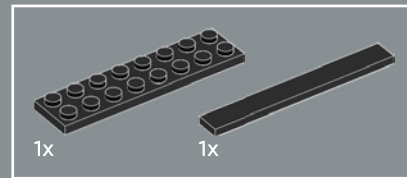
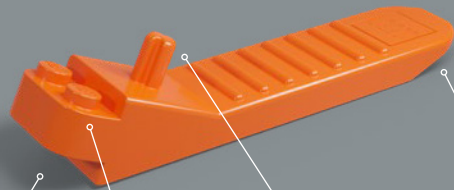

1

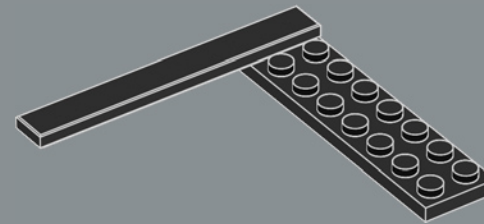

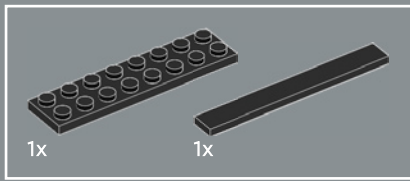

2

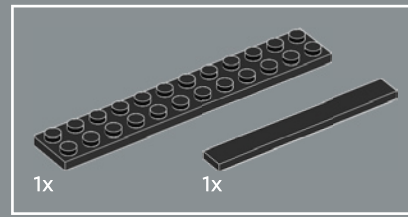
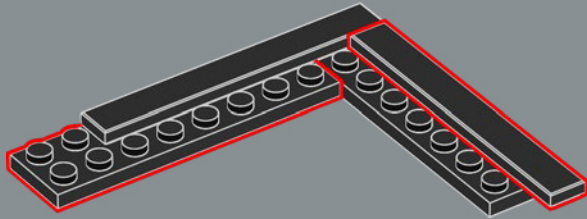

3

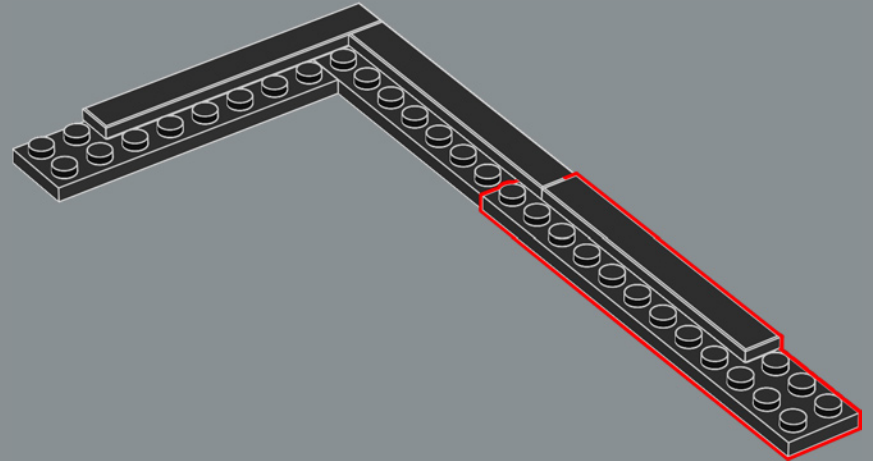

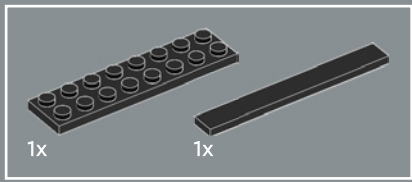

4

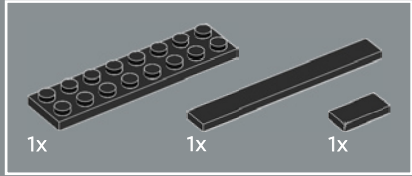
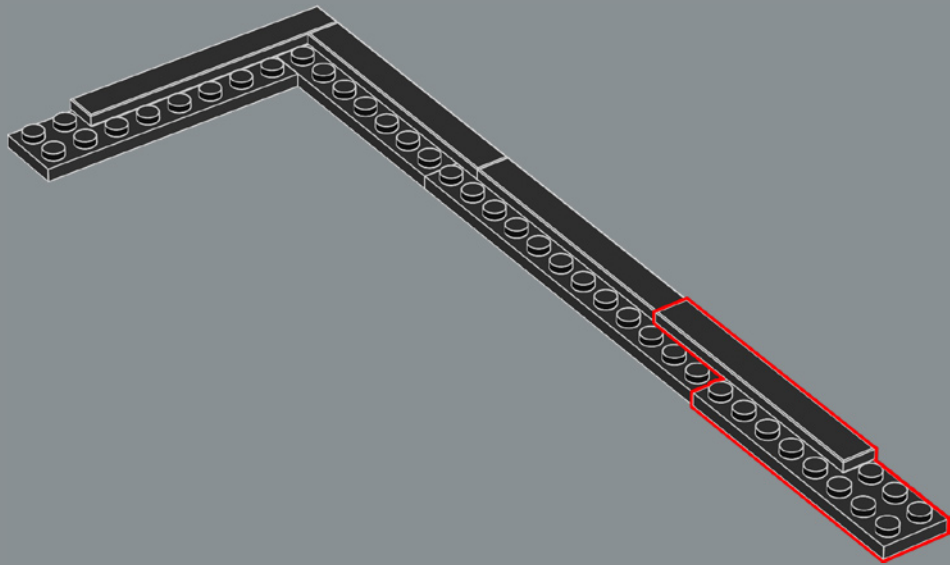

5

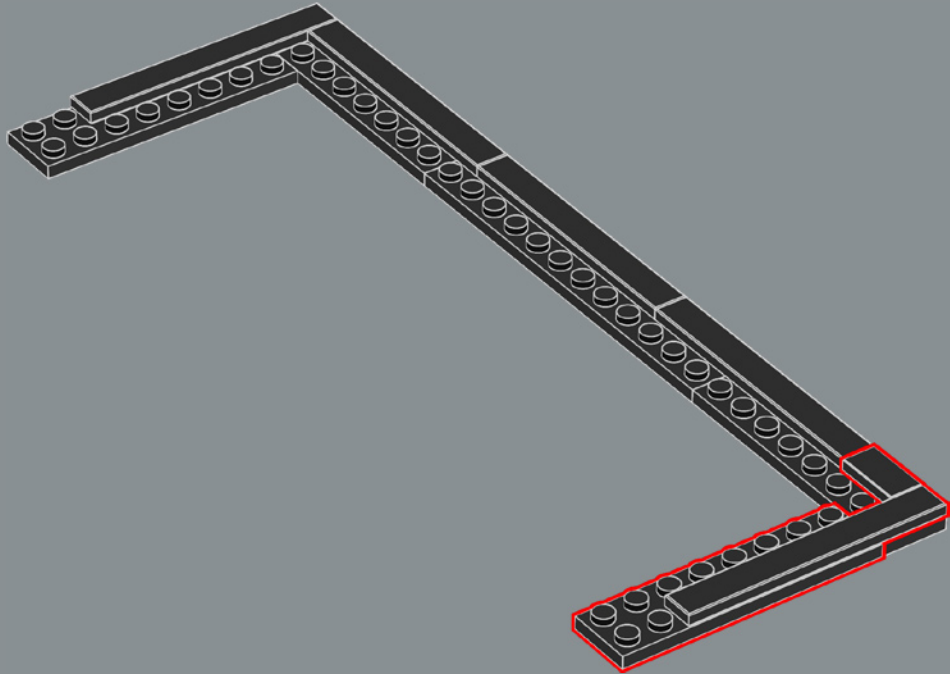

8

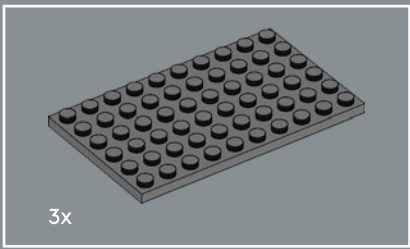

6

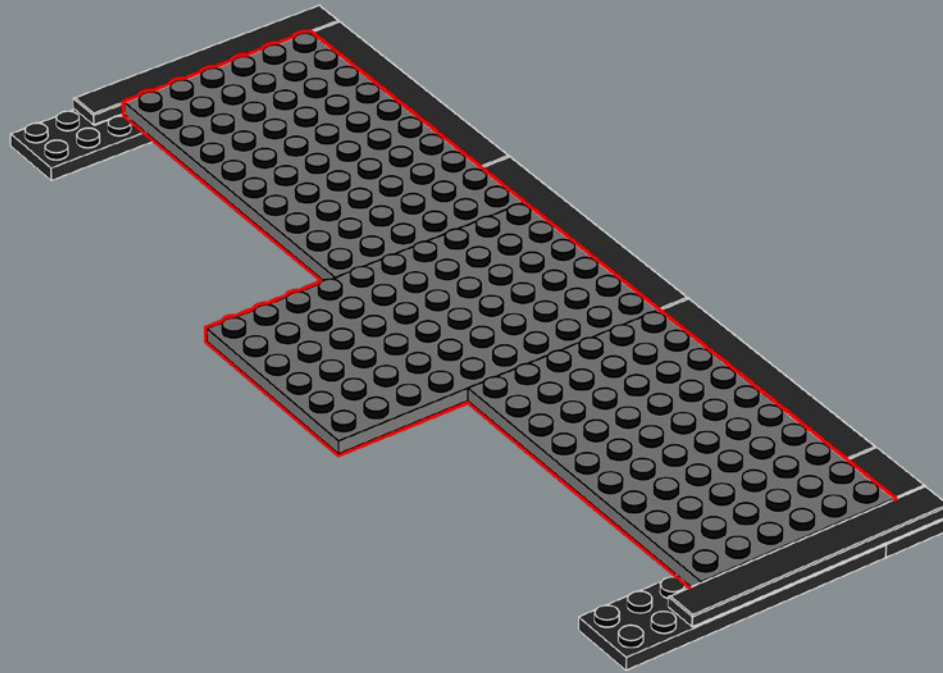

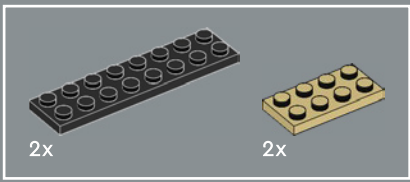

7

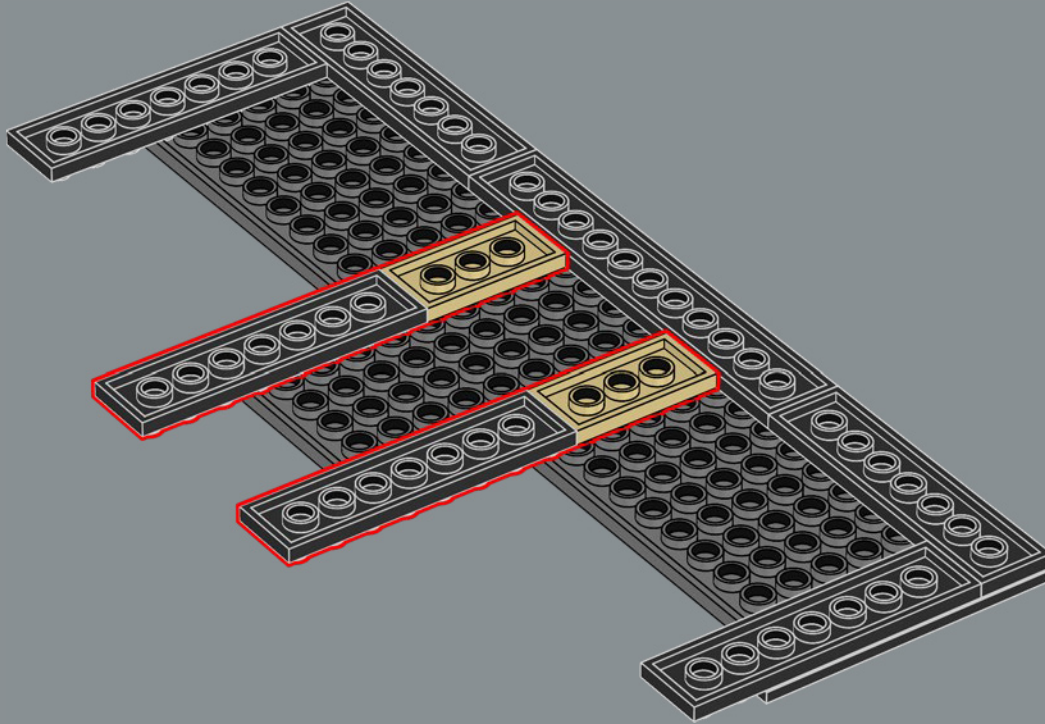

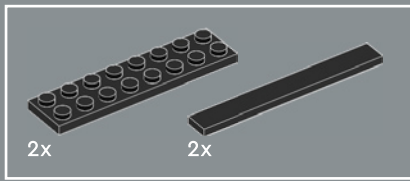

8

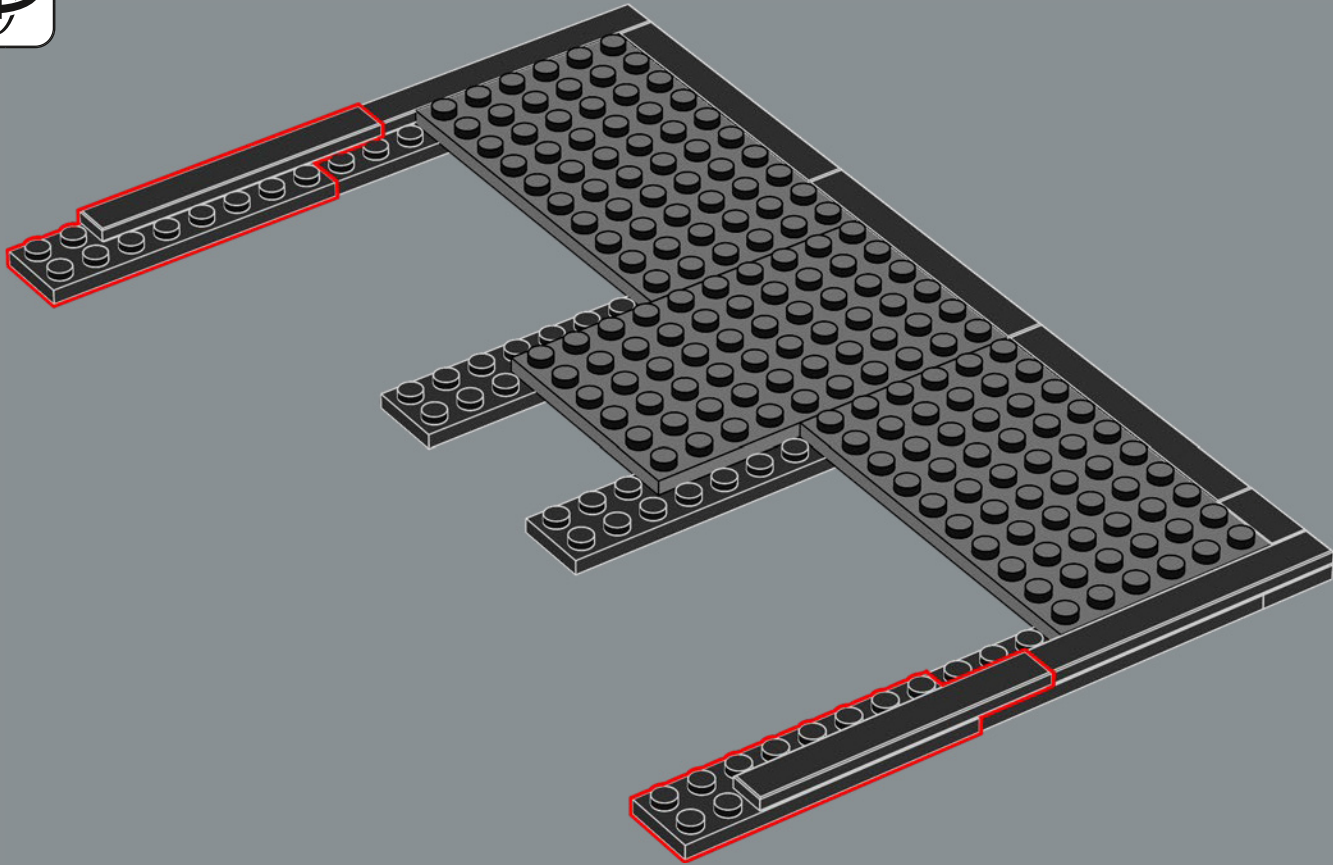

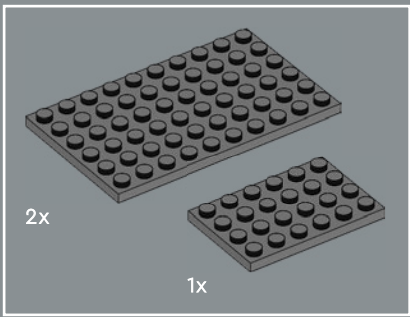

9

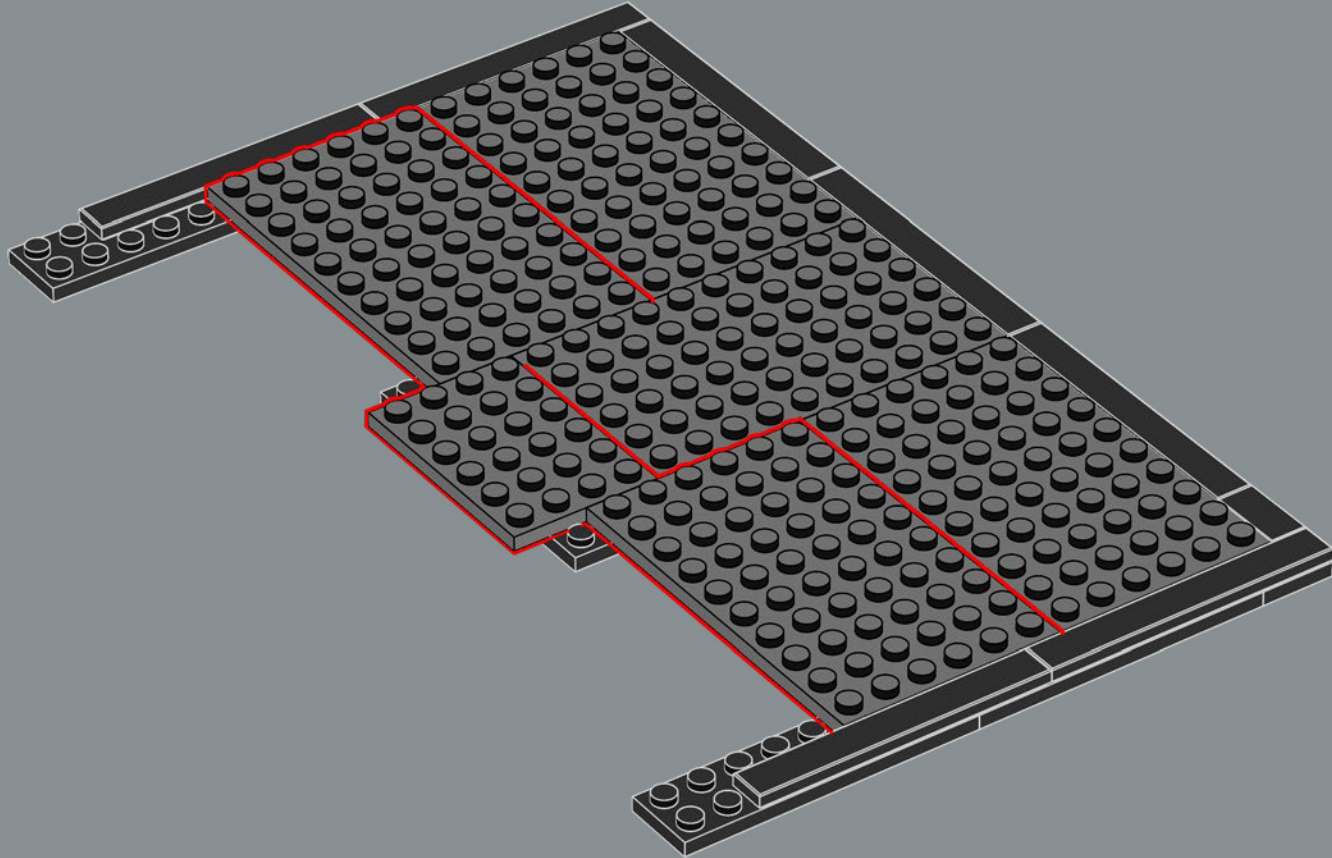

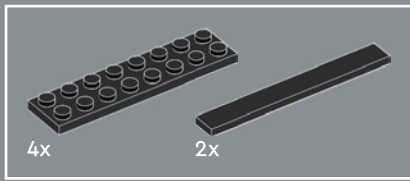

10

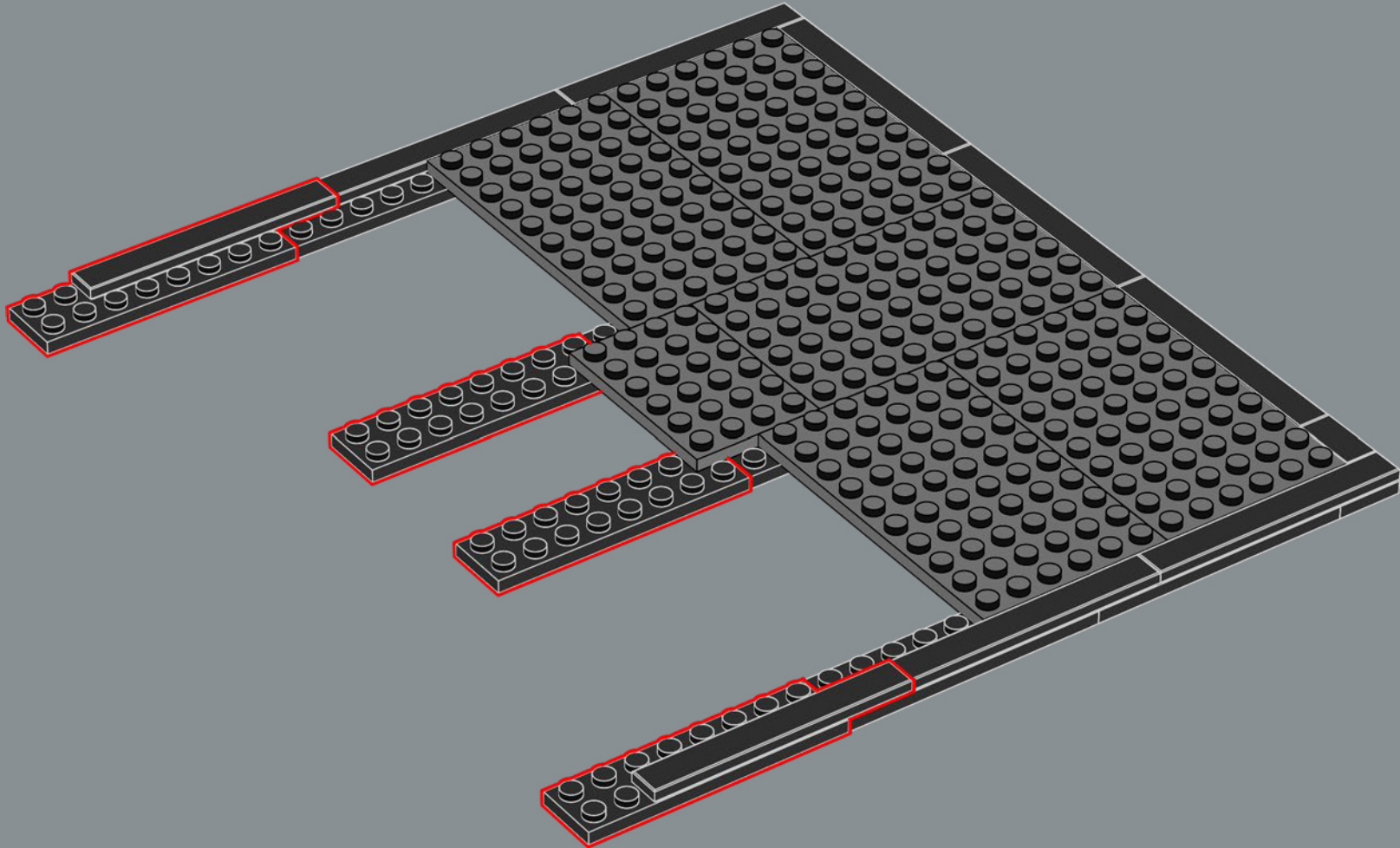

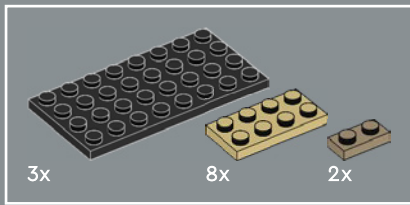

12

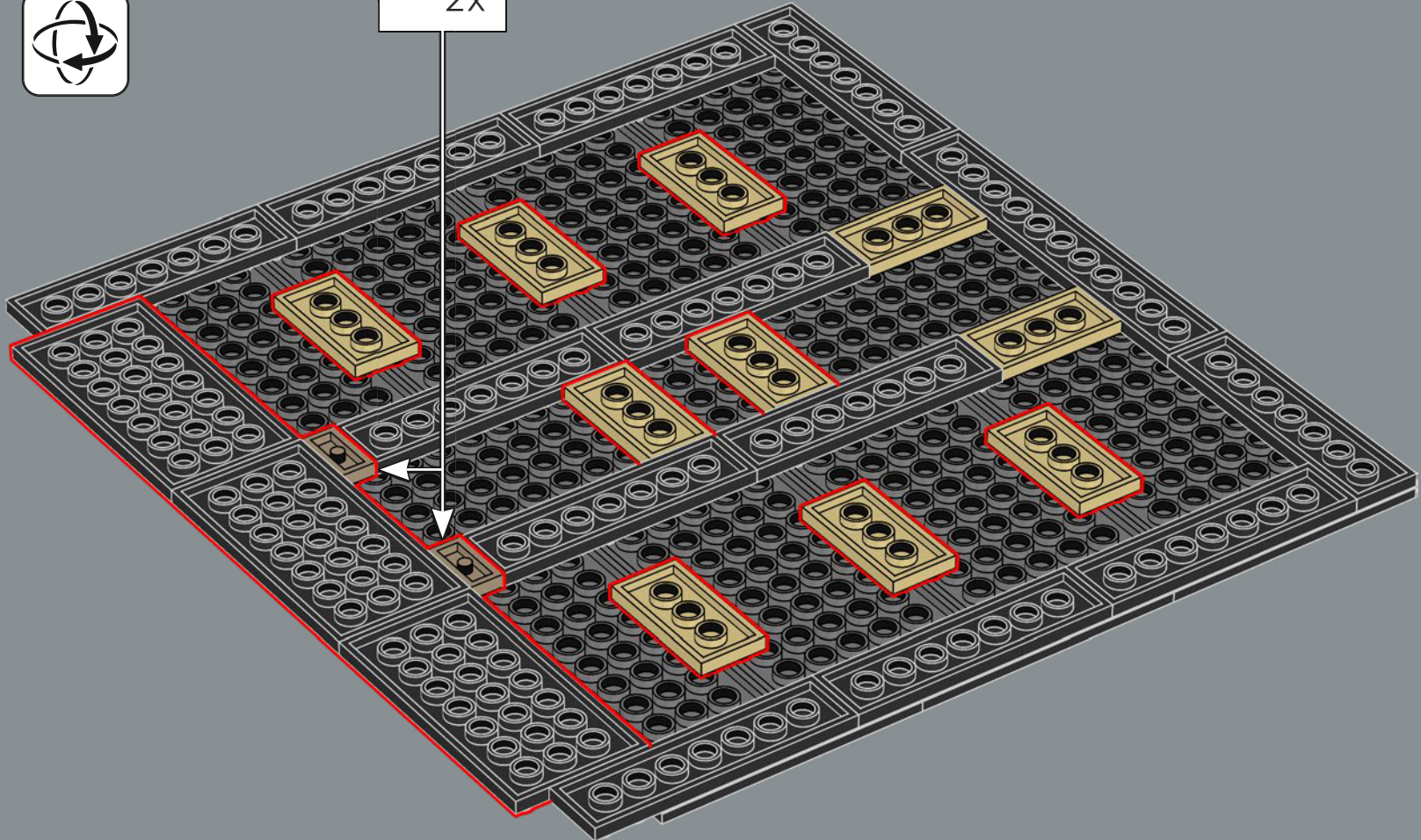
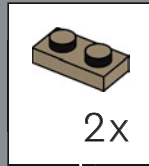

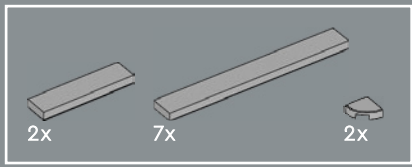

13

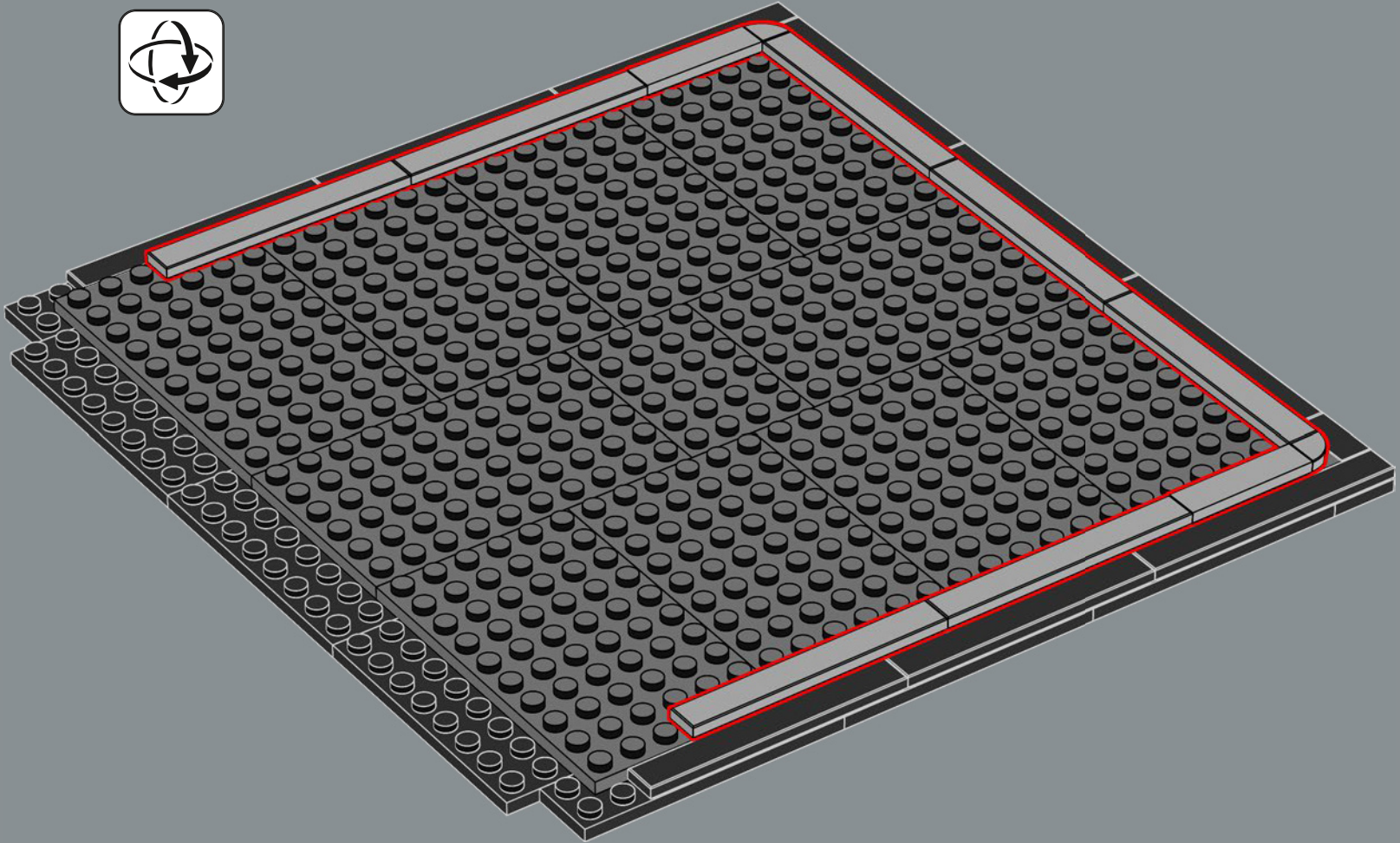

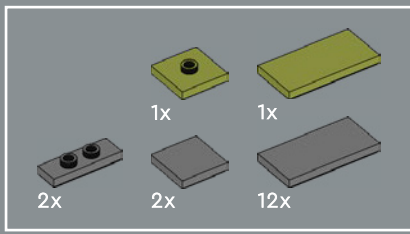

14

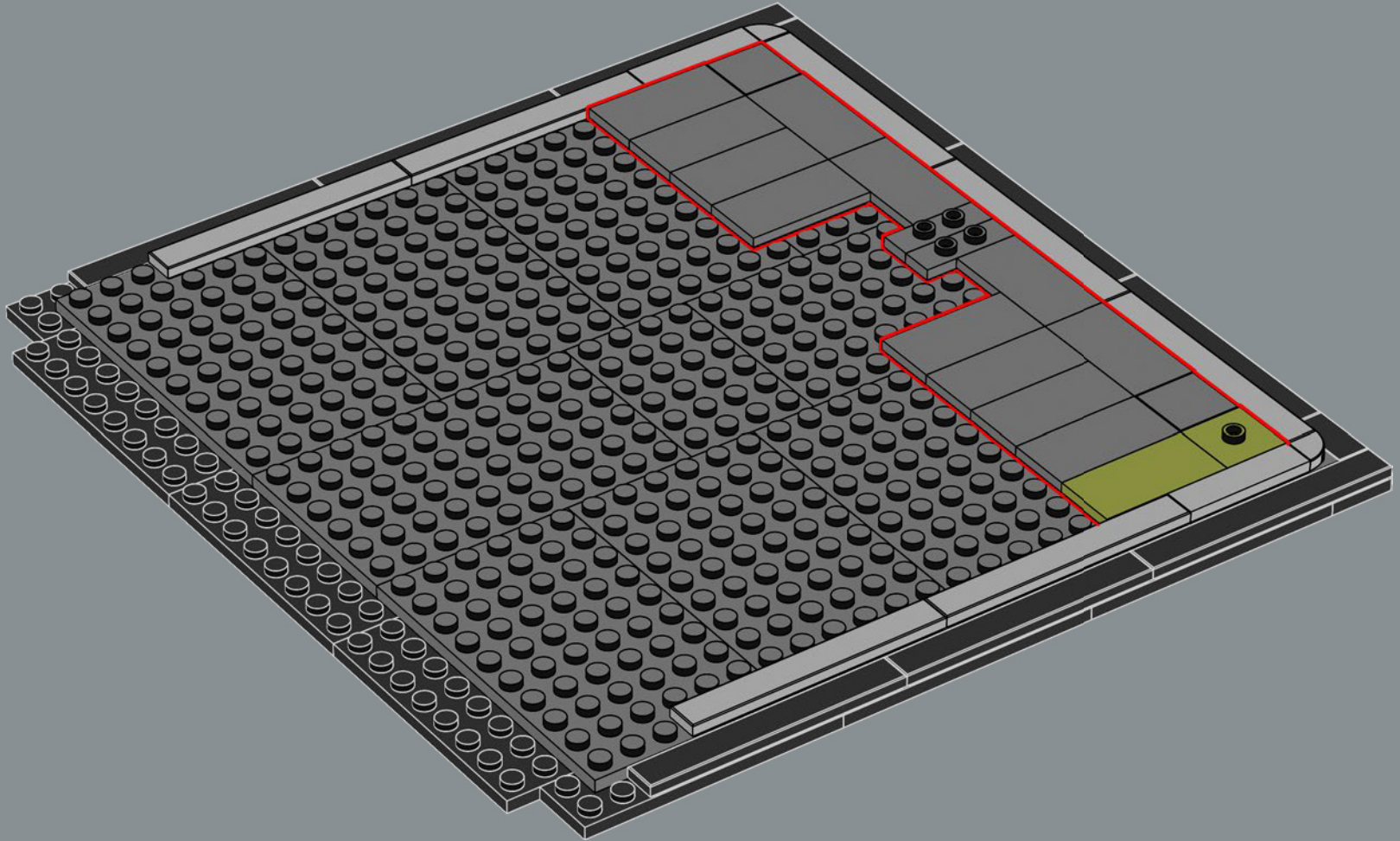

1163 - The plans for the Notre-Dame Cathedral are ready. Construction begins and Pope Alexander III oversees the first stone being set in place.

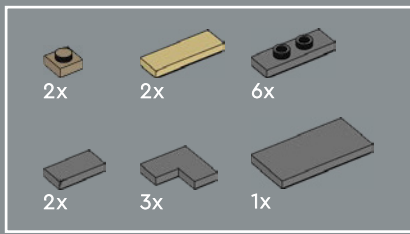

15

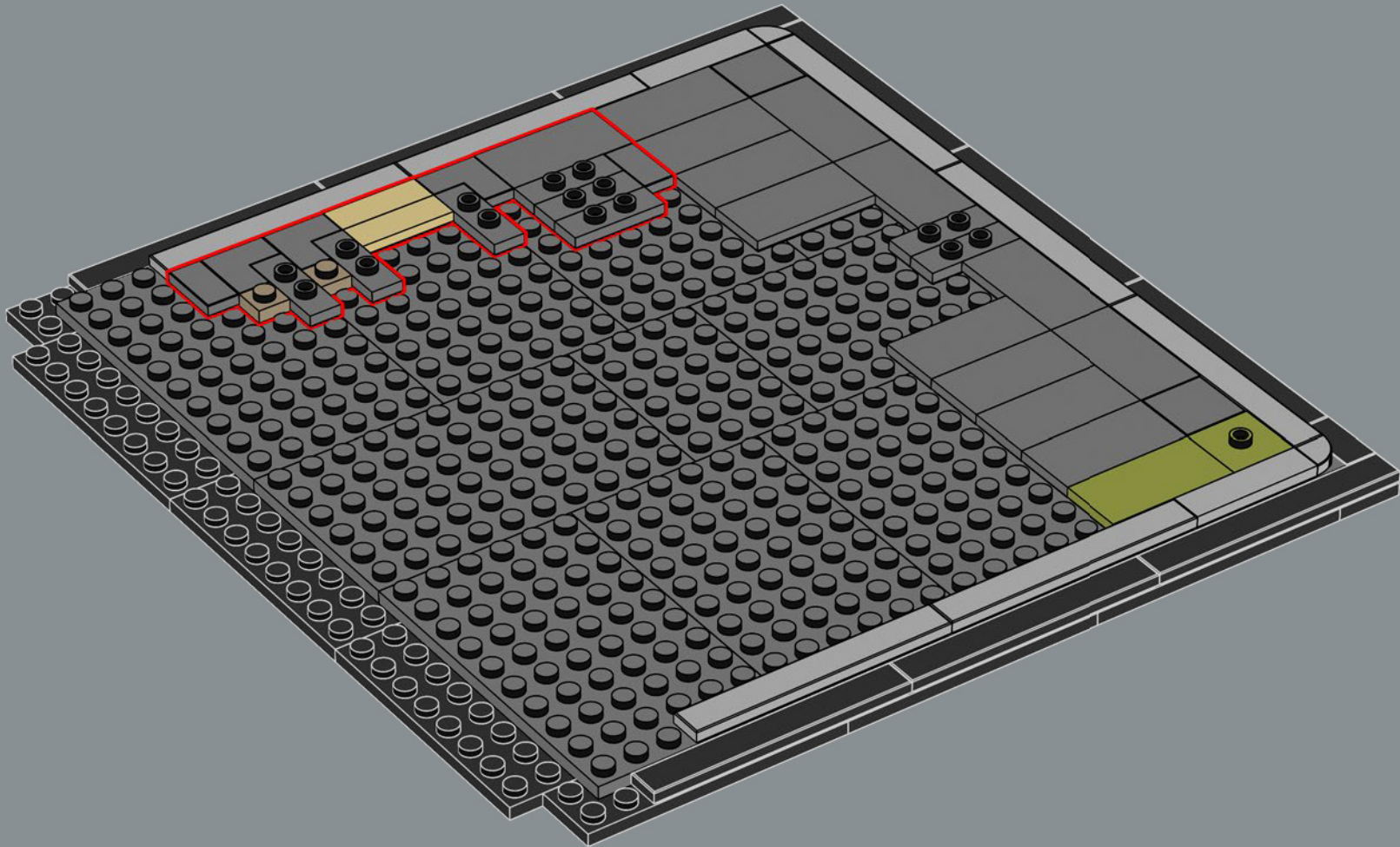

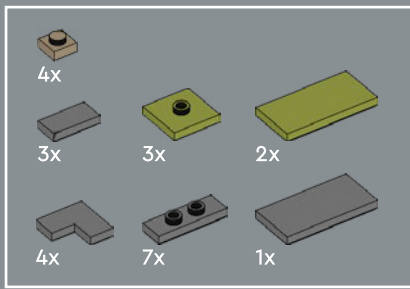

16

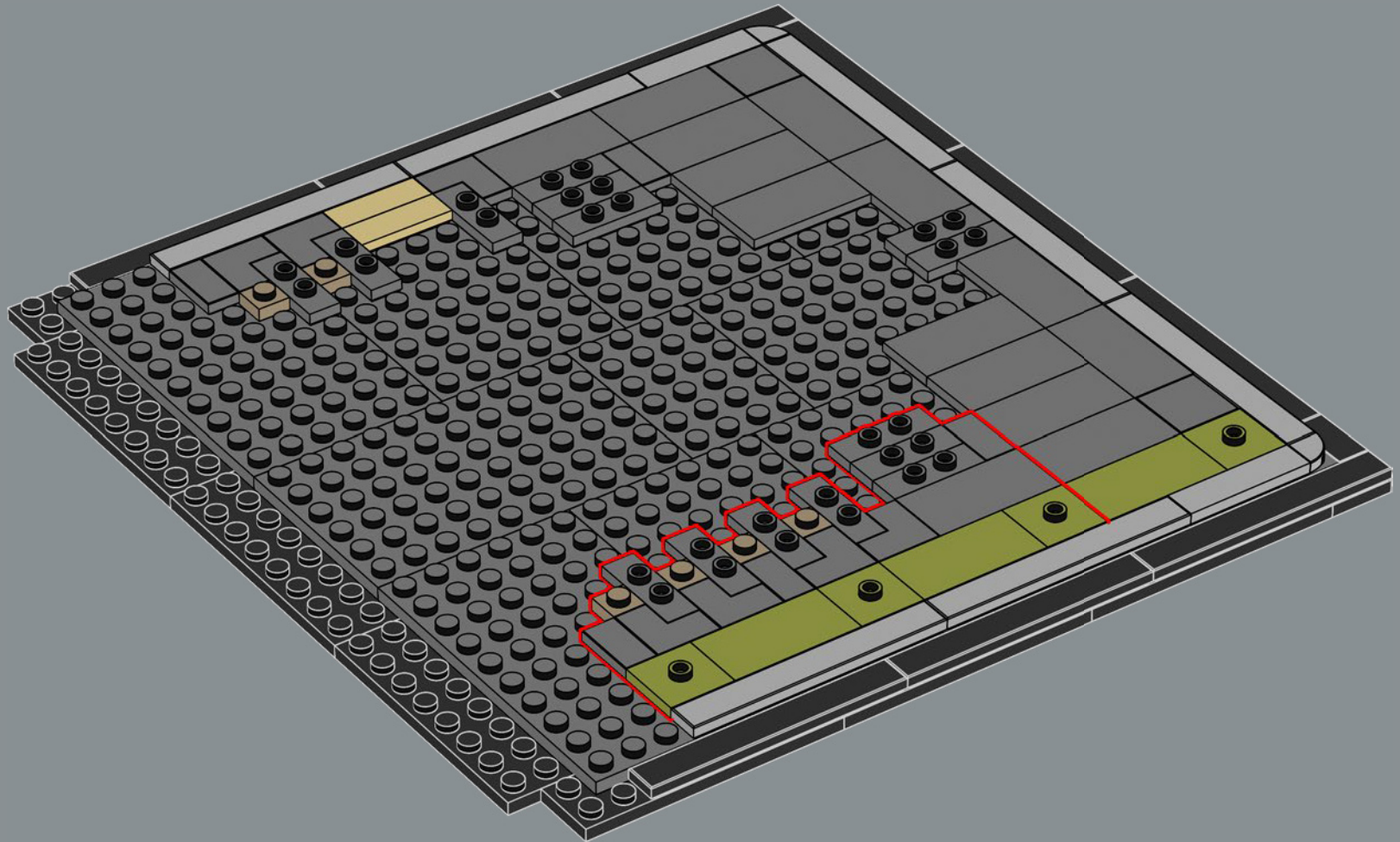



18

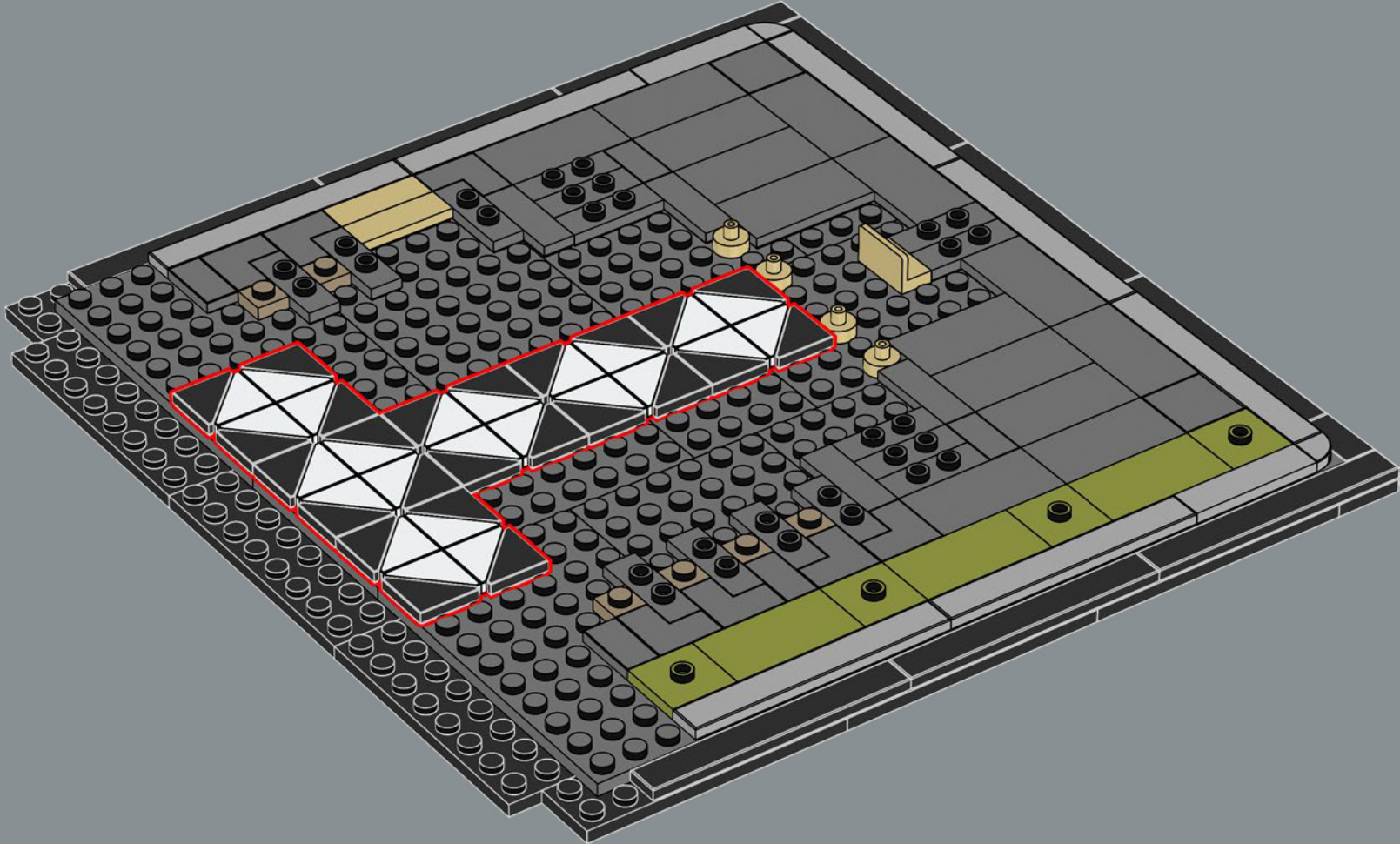



20x

19

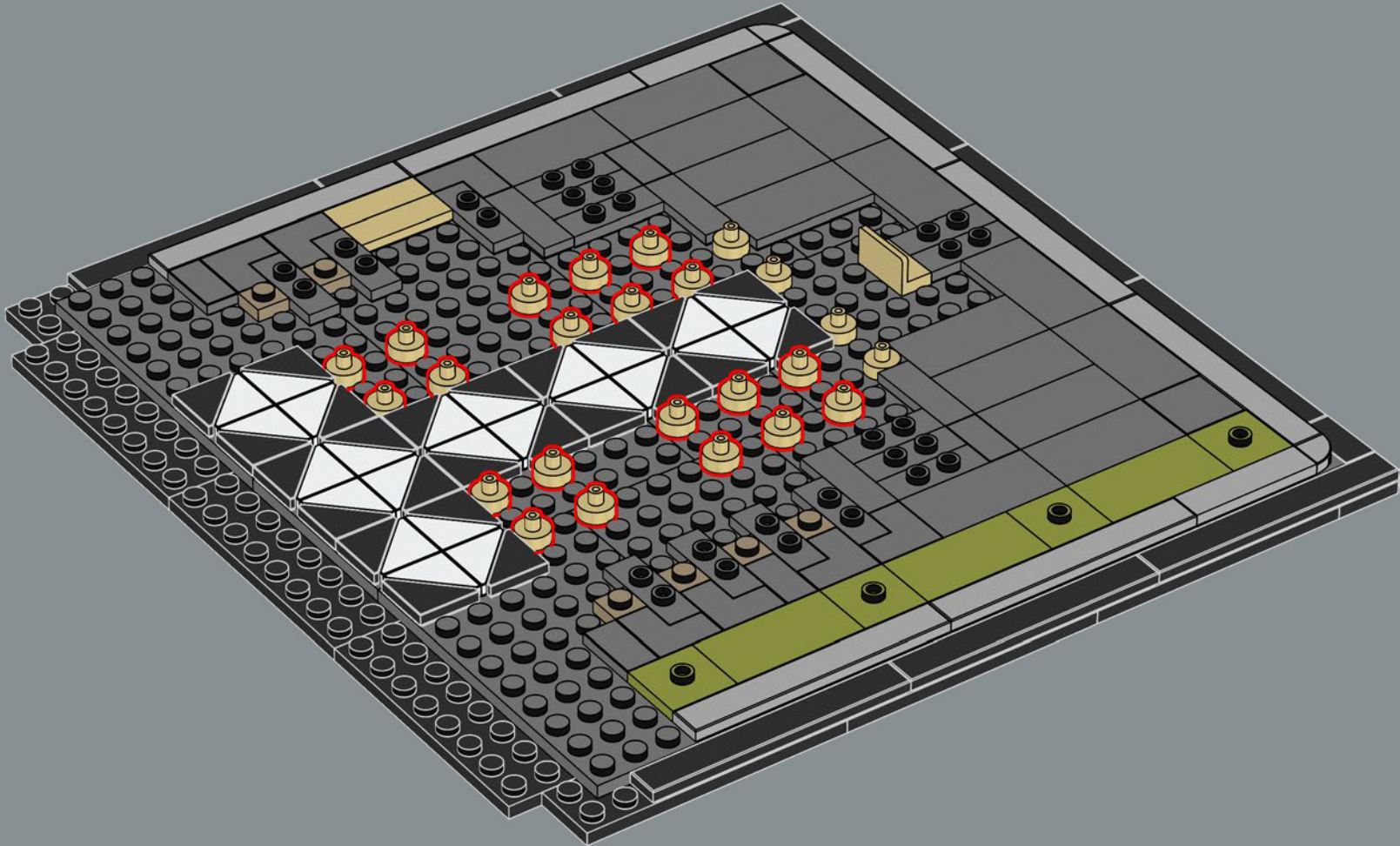

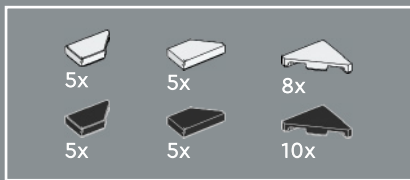

20

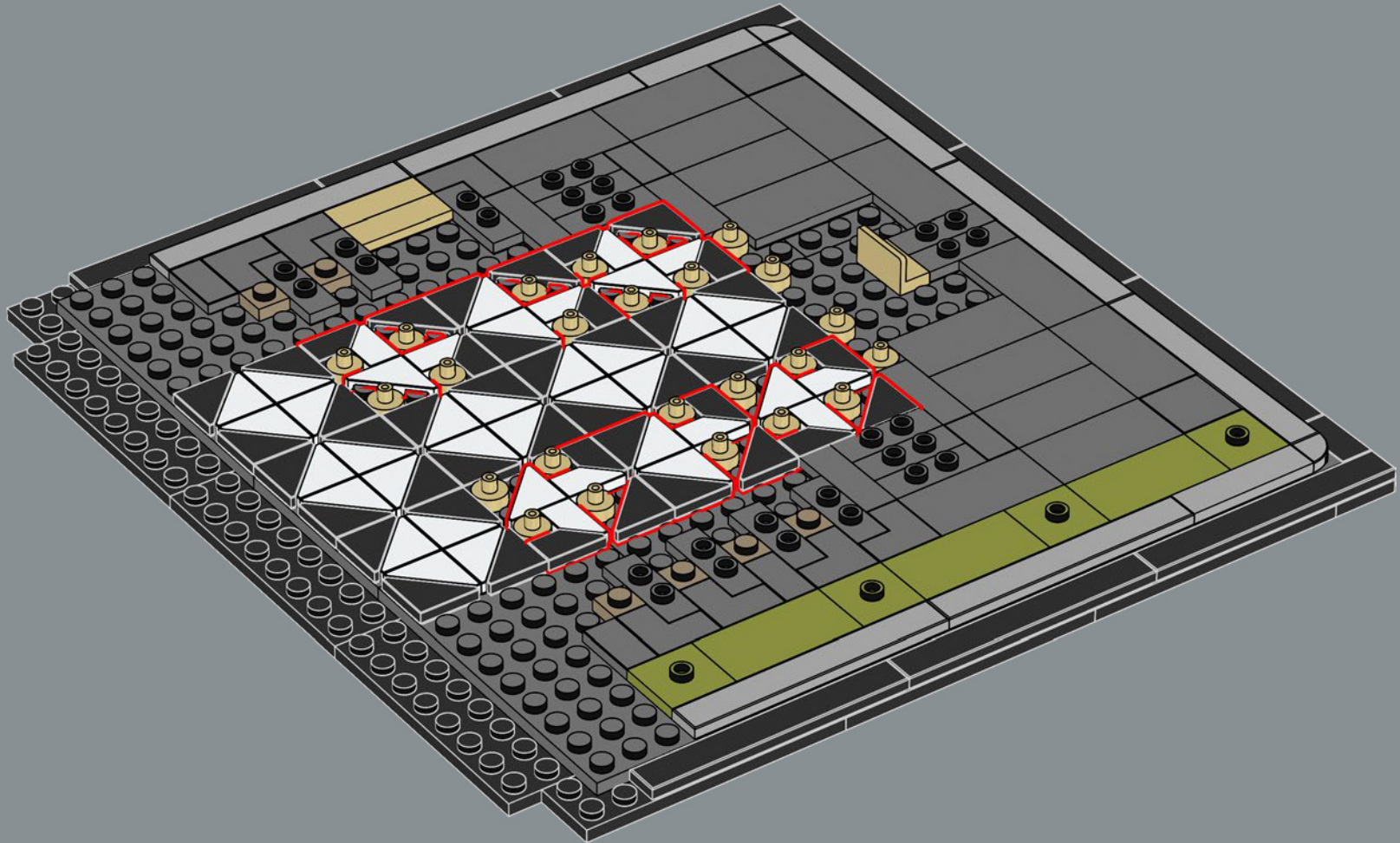

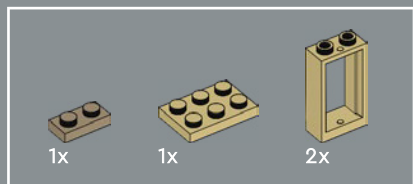

21

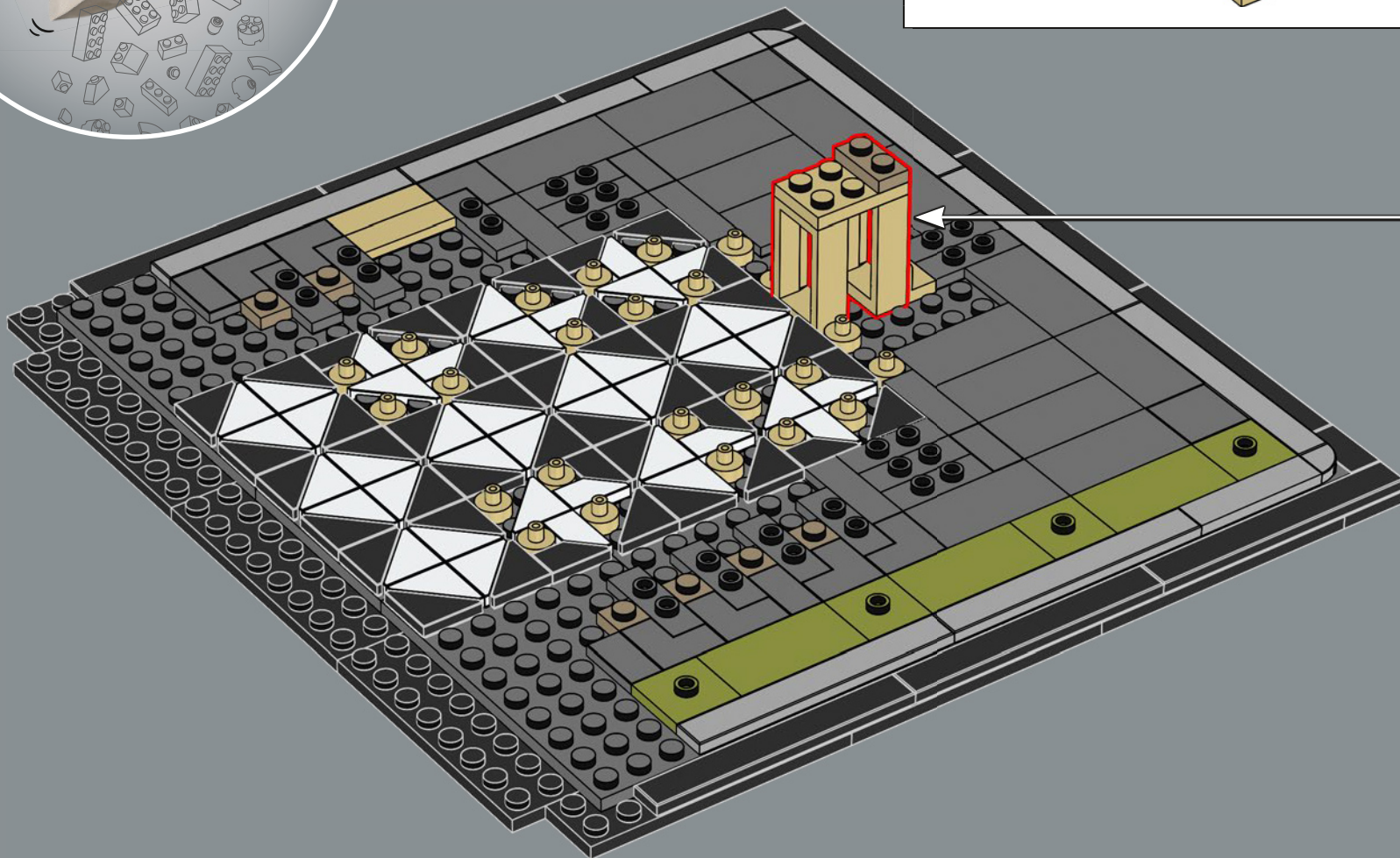
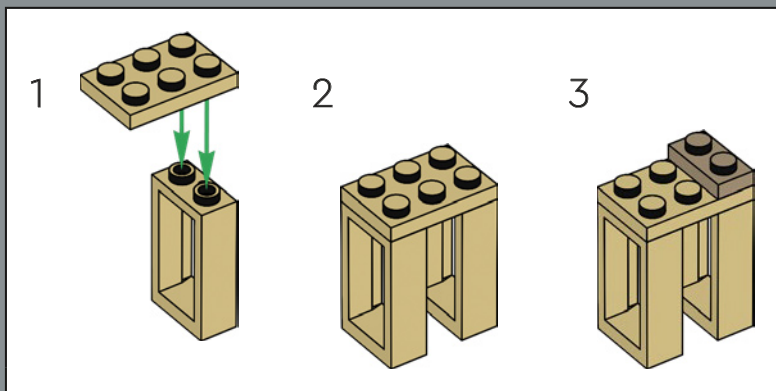

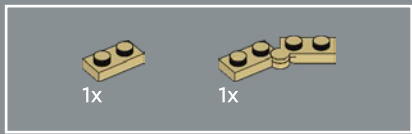

23

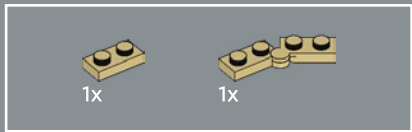
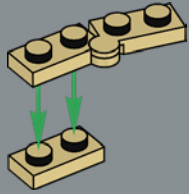

24

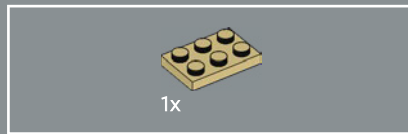
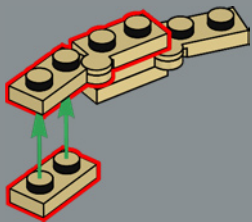

25

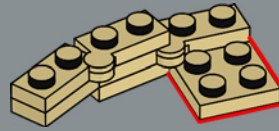

26

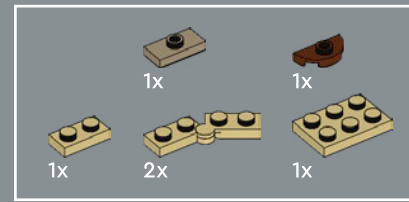
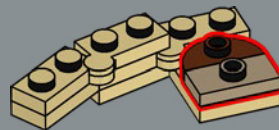

27

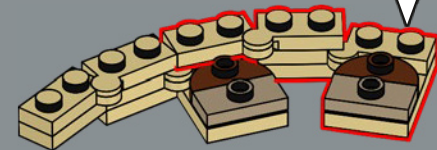
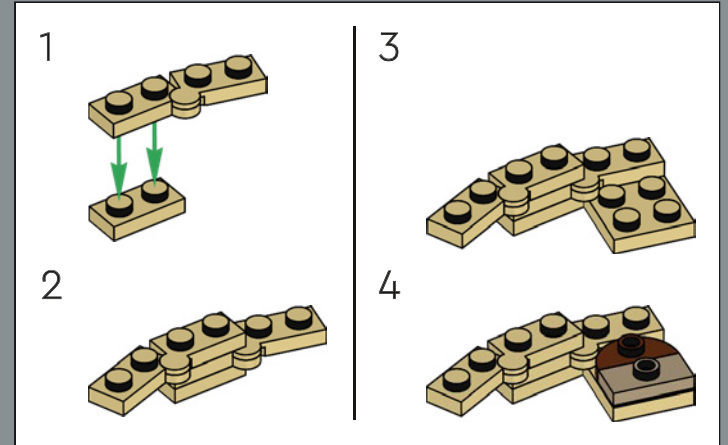

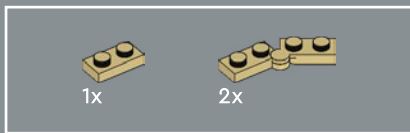

28

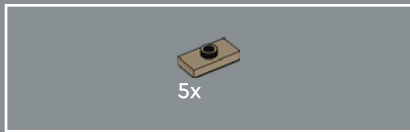
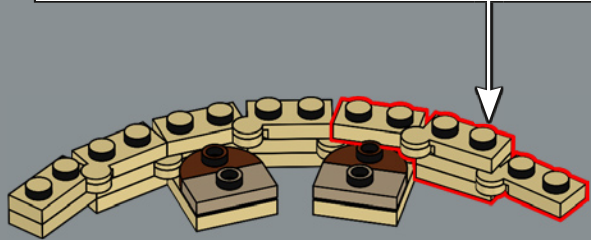
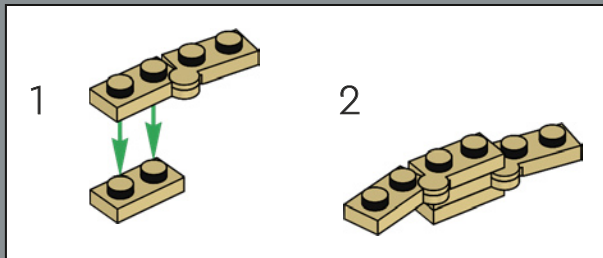

29

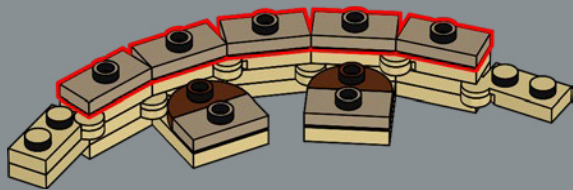

30

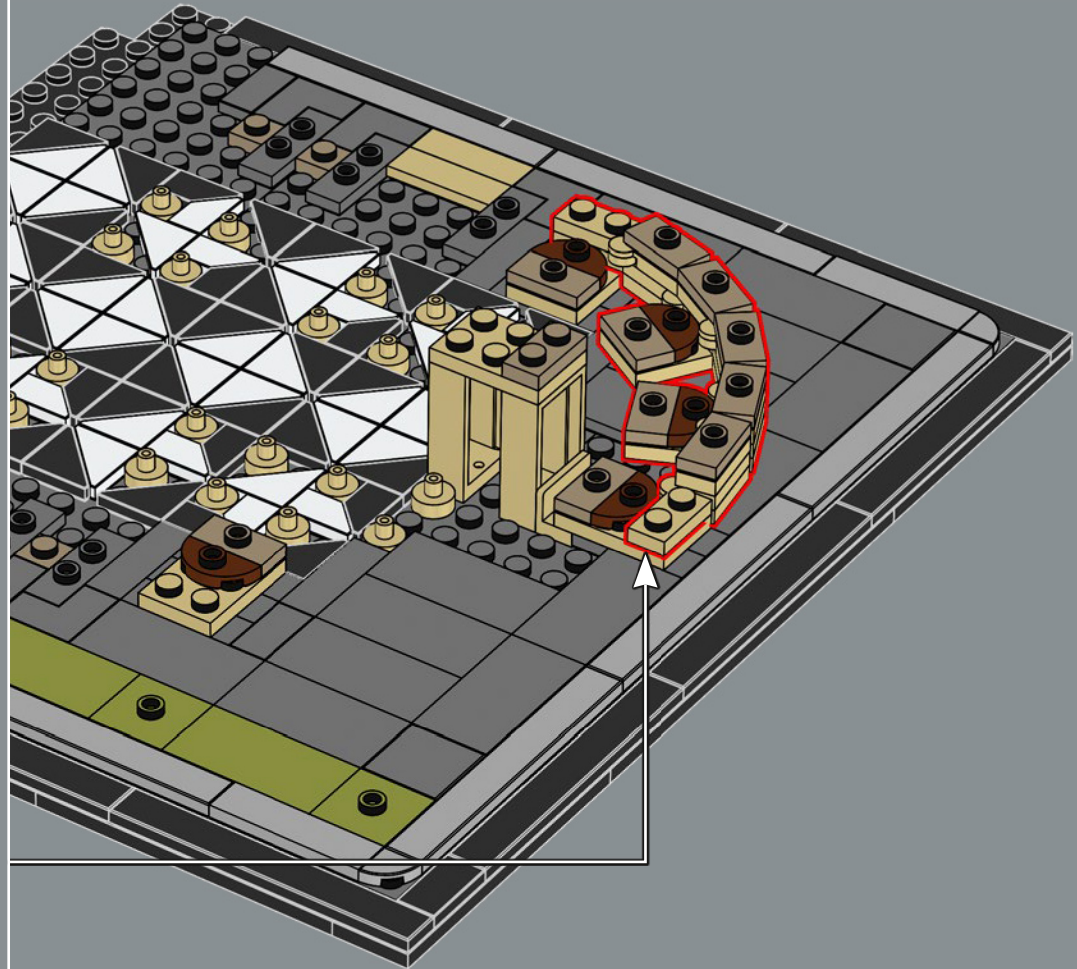

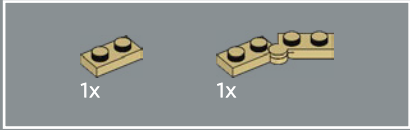
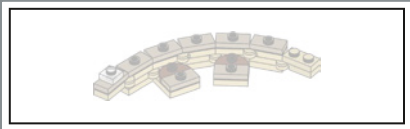

31

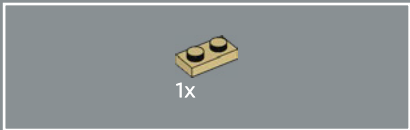
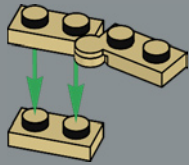

32

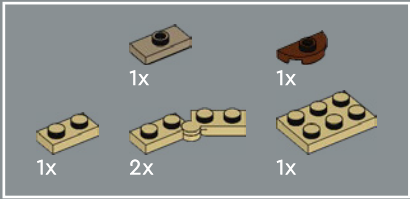

33

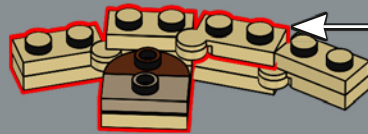
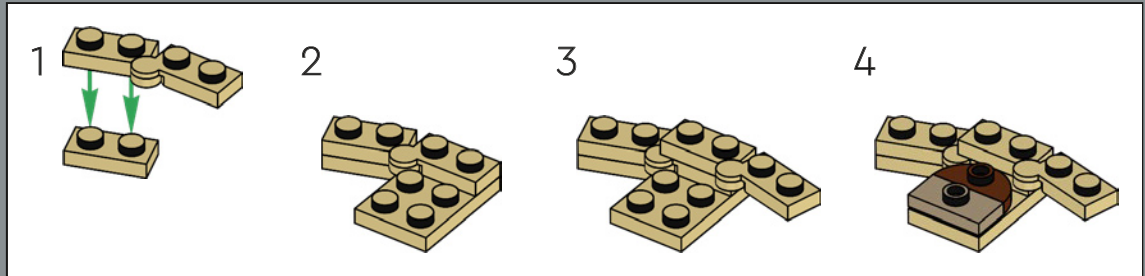

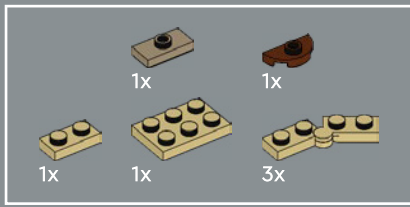

34

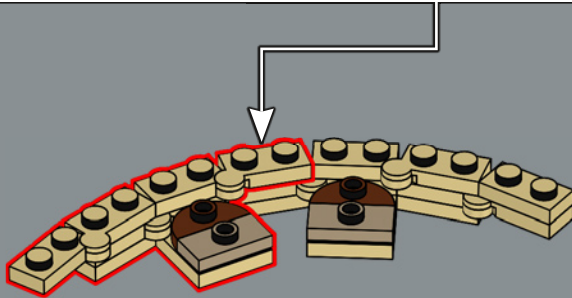
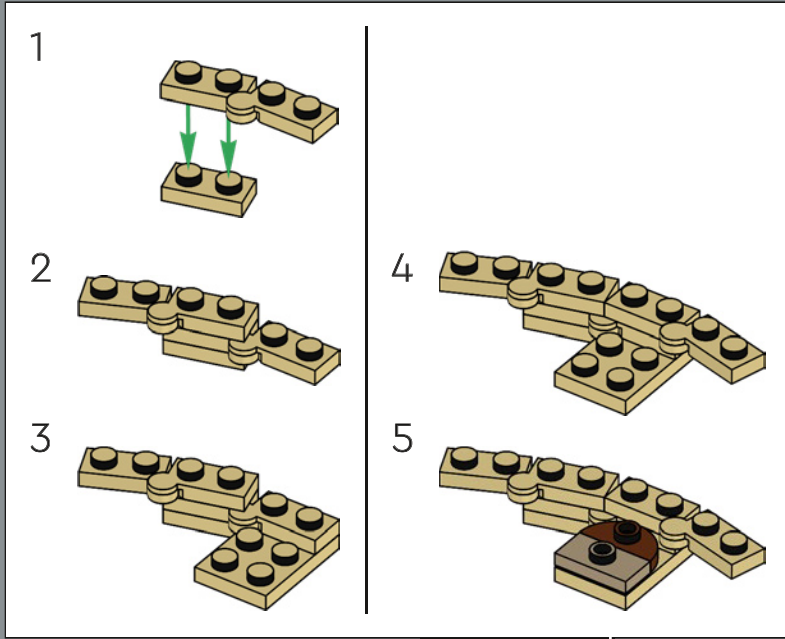

35

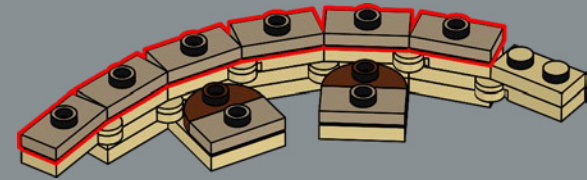

36

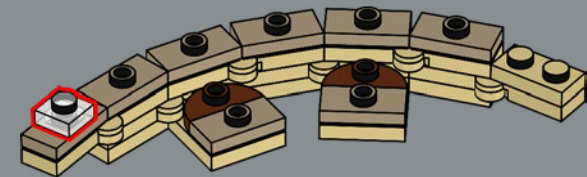

1163 - Elements of the floor plan are determined by a series of circles created with the help of ropes of different lengths attached to a stake at the centre of the cathedral.

37

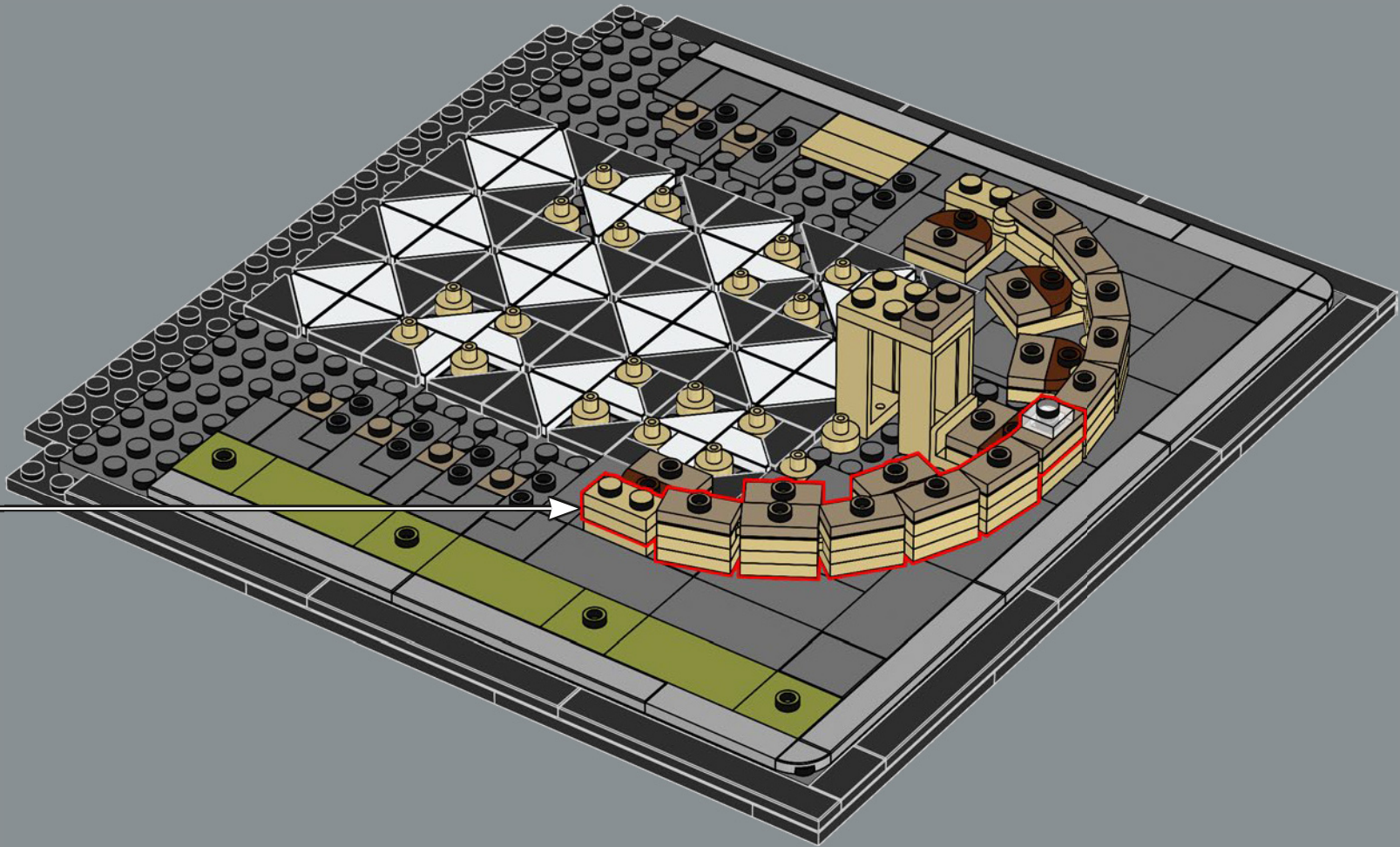

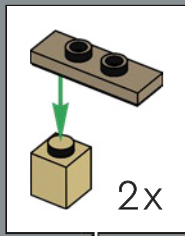
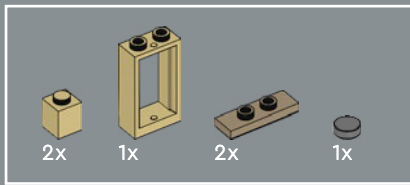

38

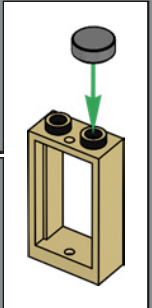
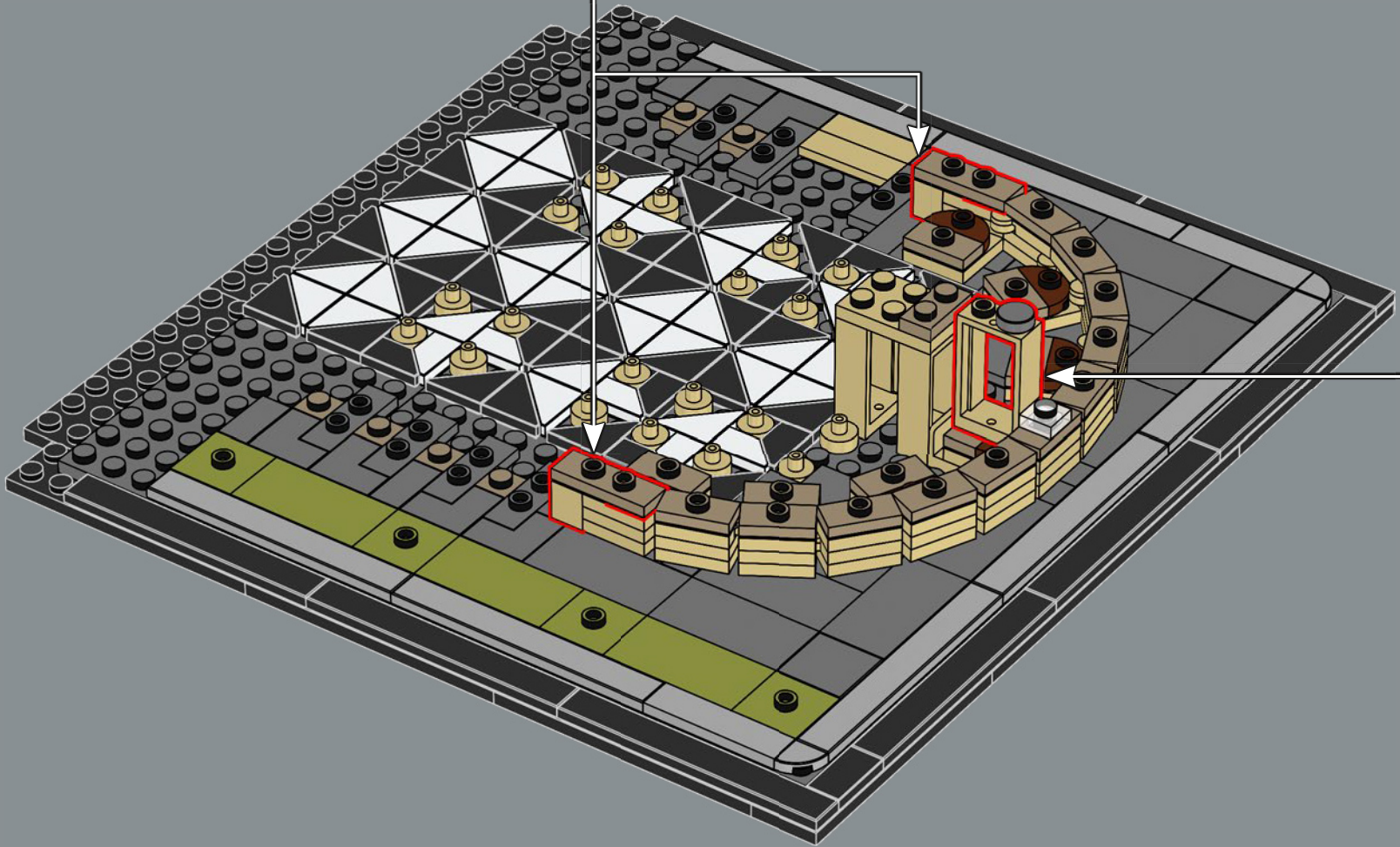

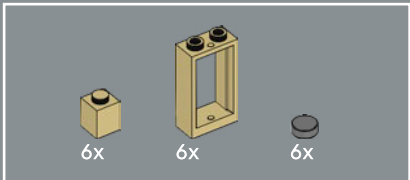

39

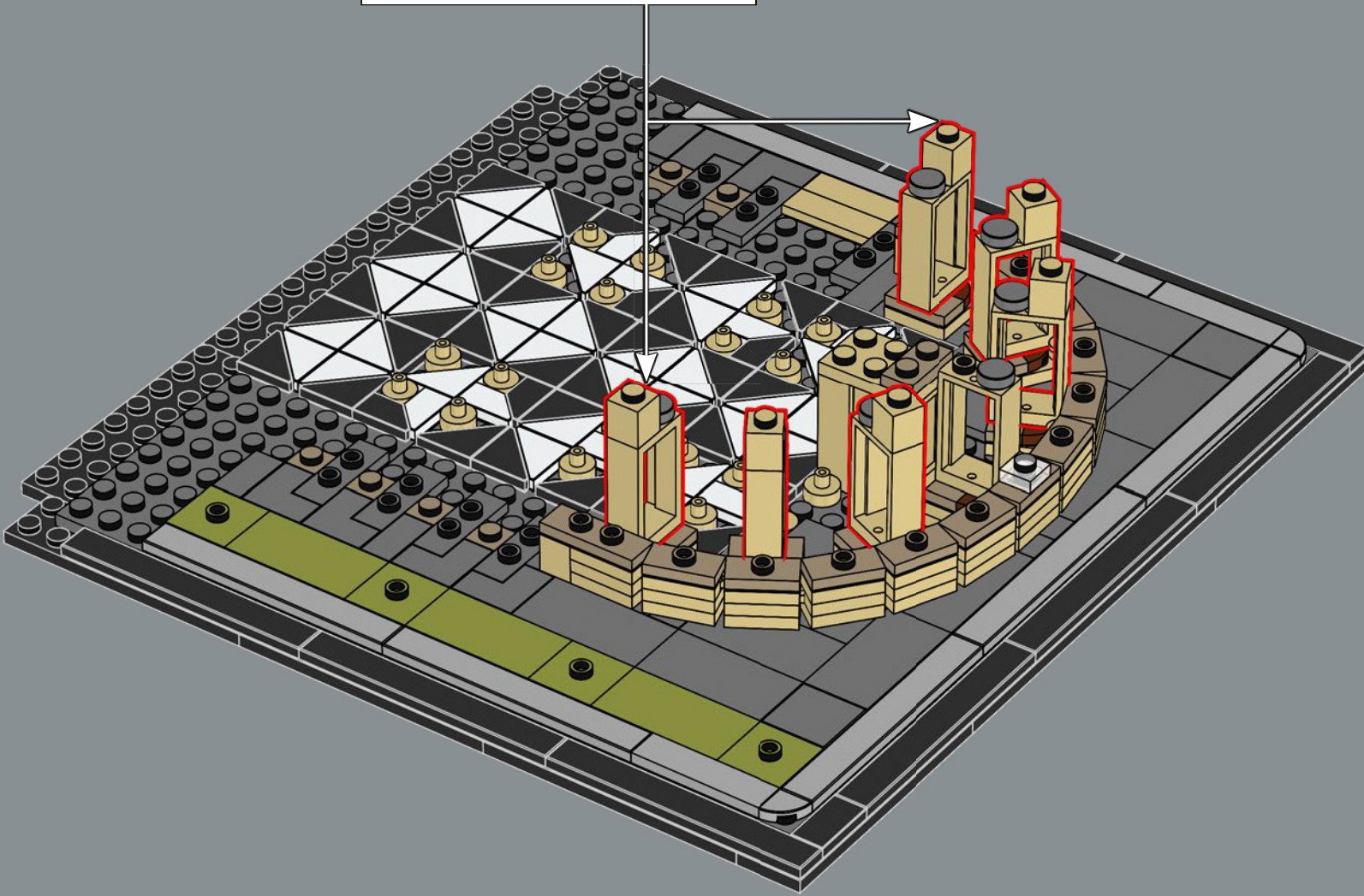
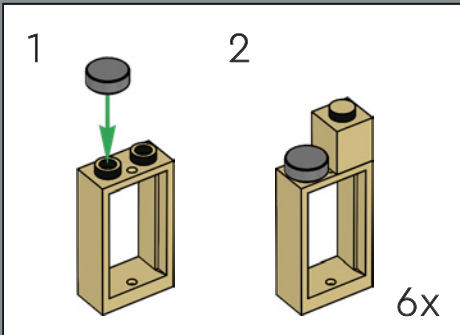



40

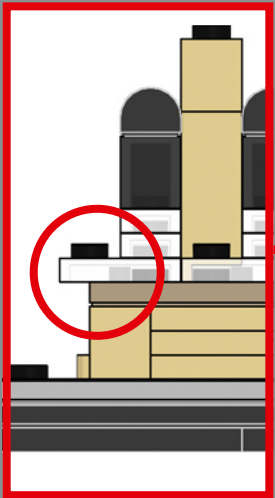
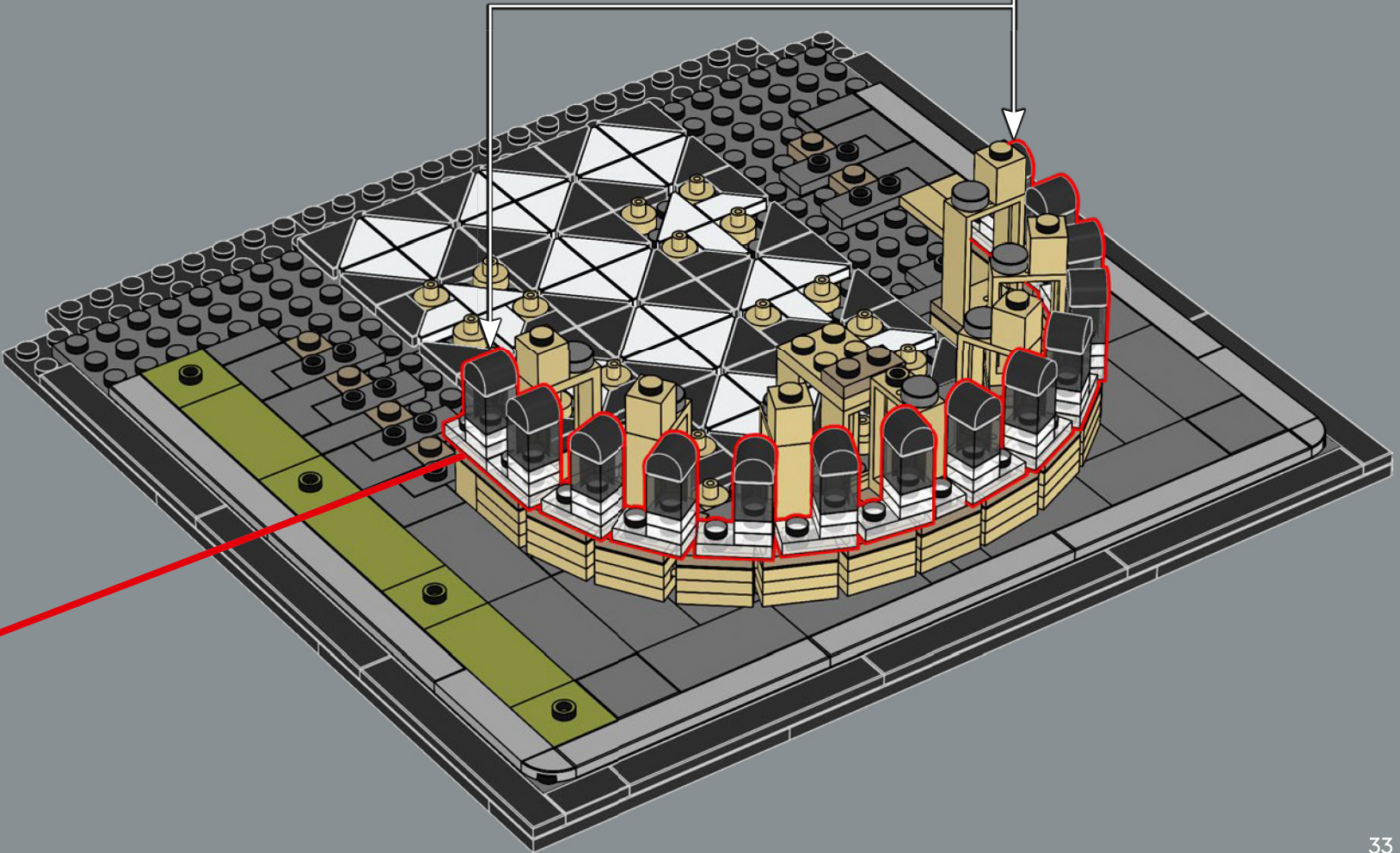
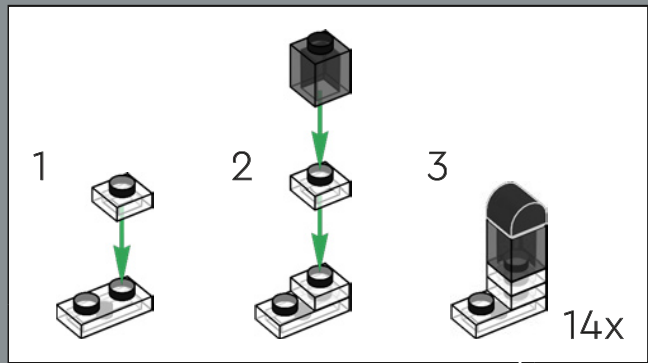

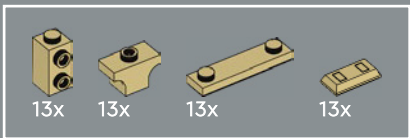

41

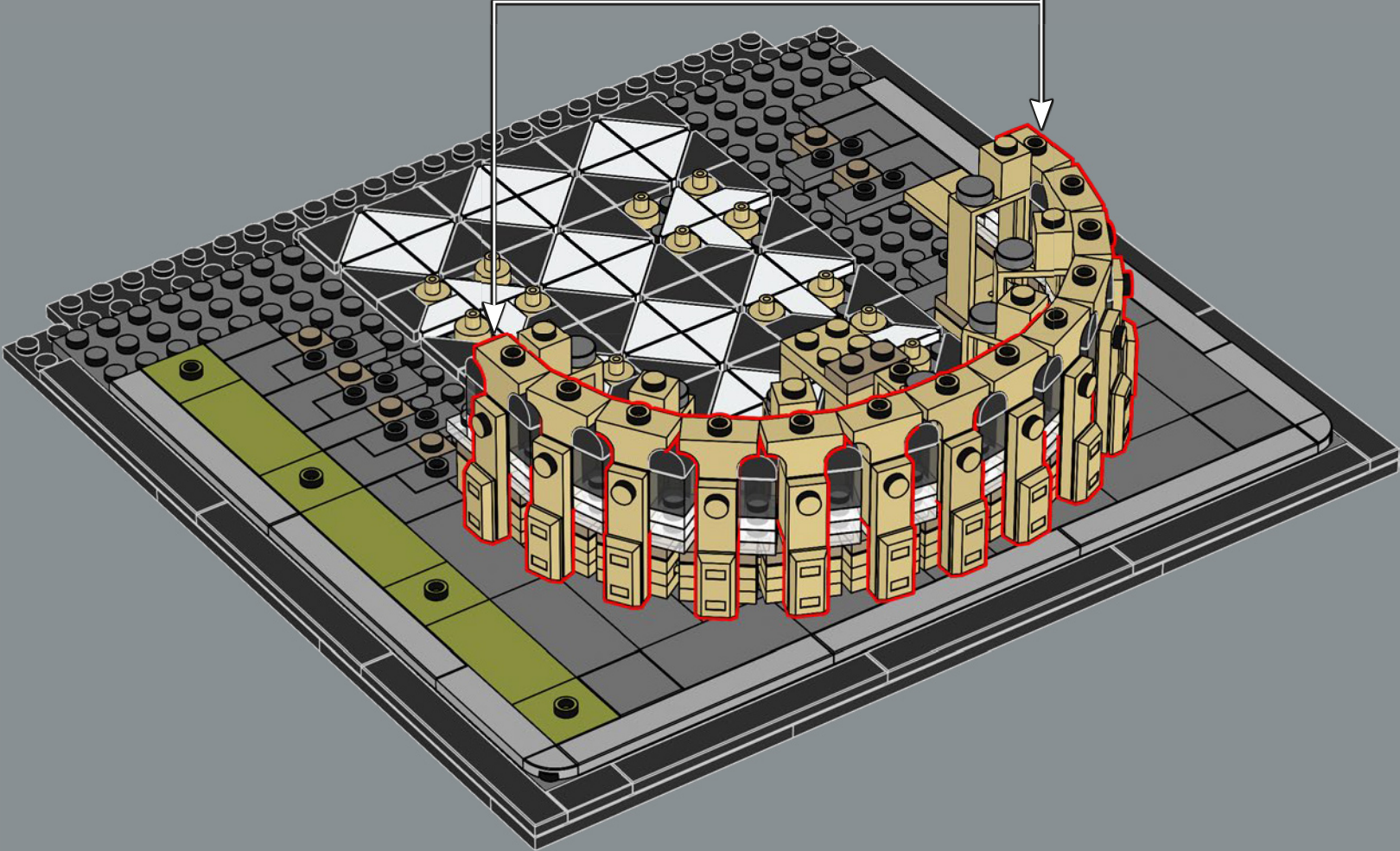
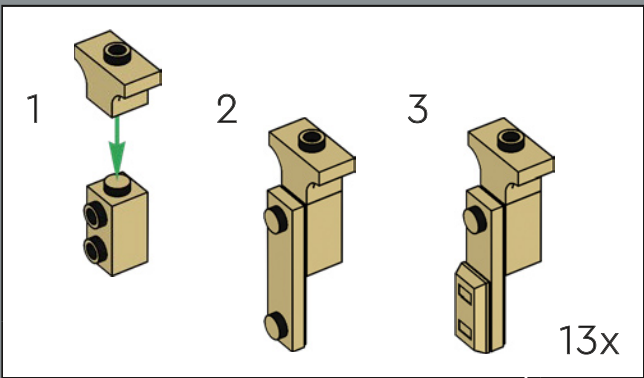

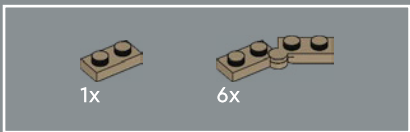

42

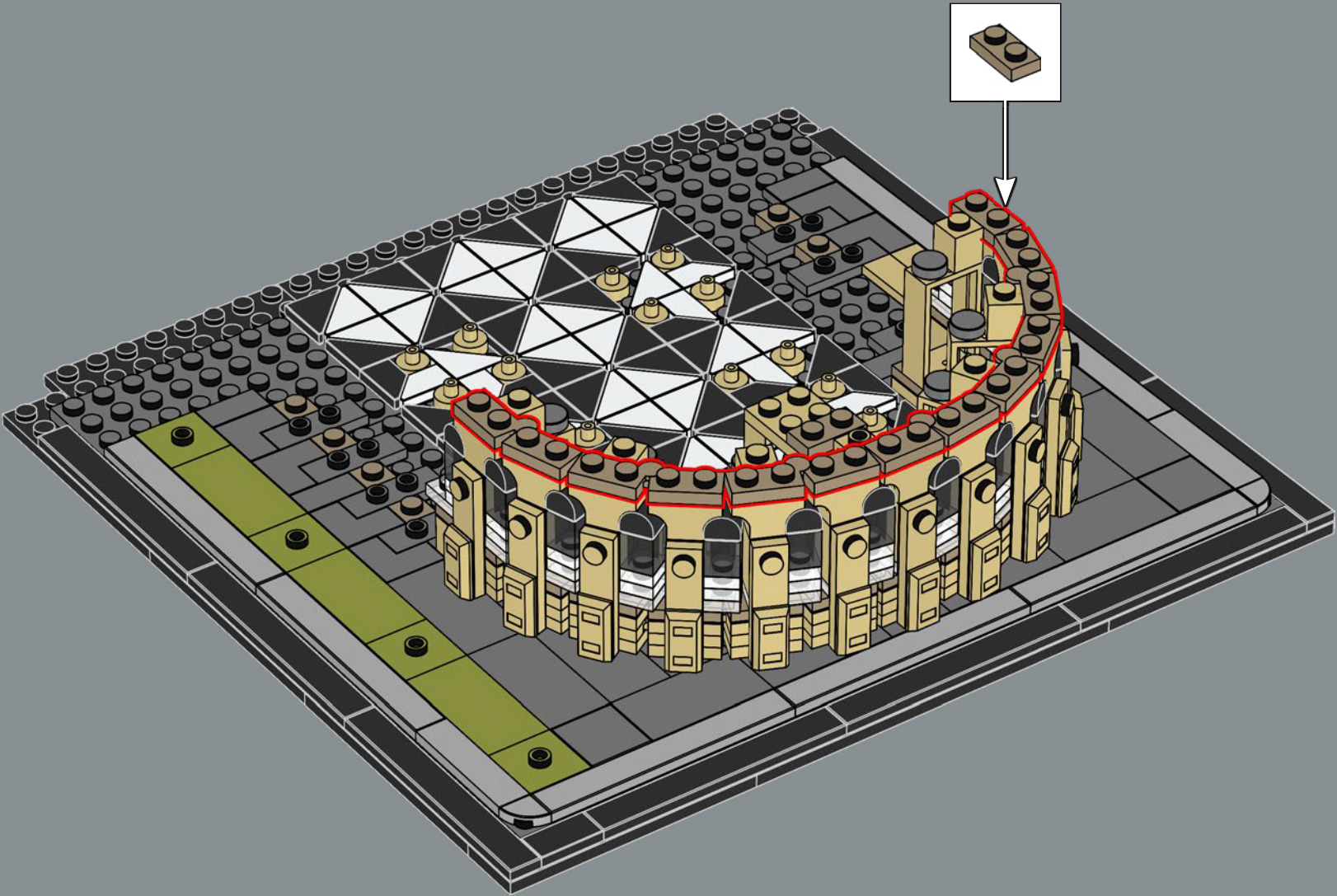

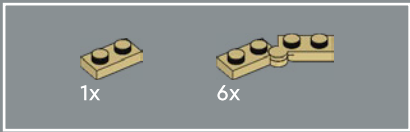

43

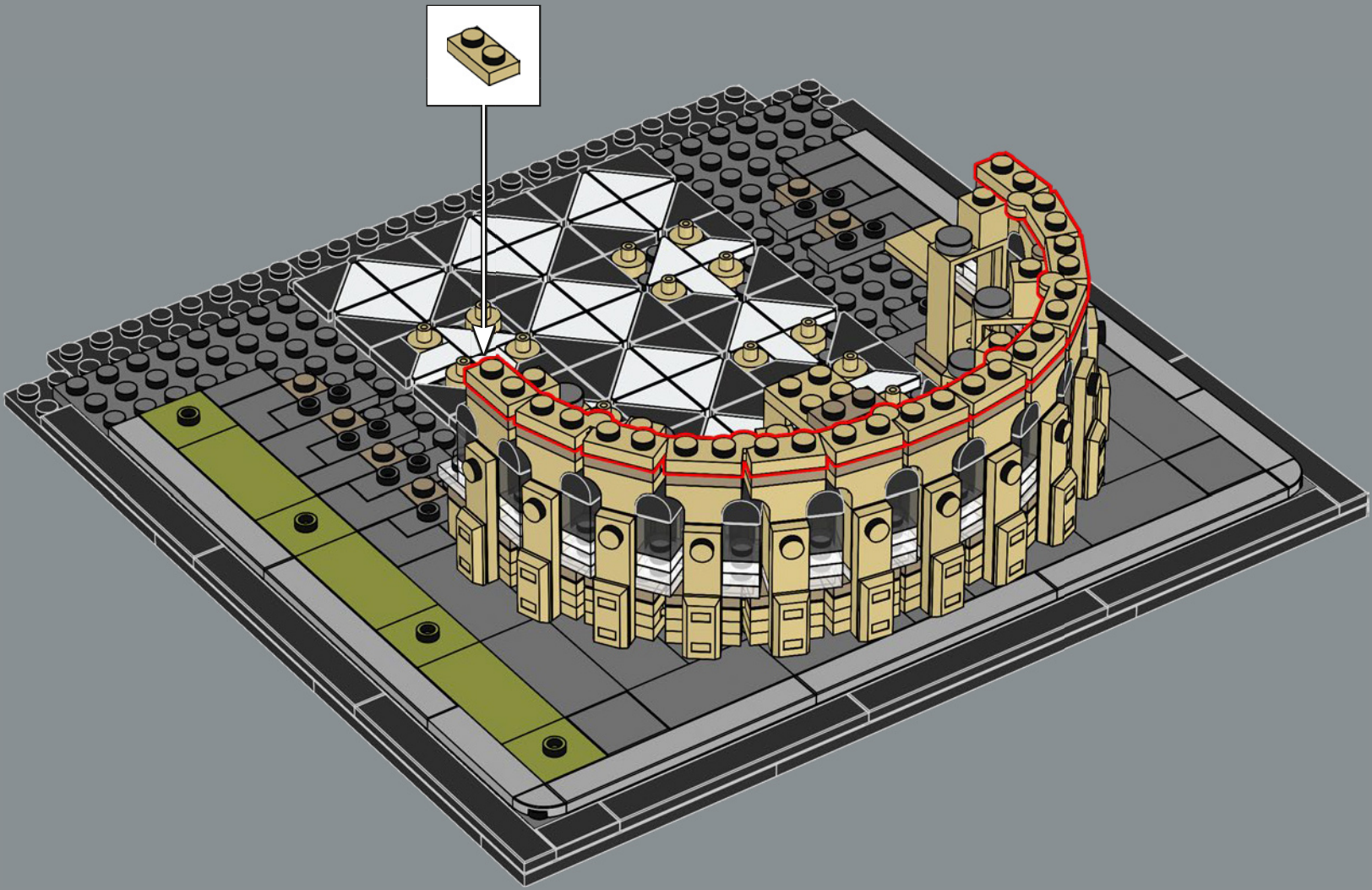

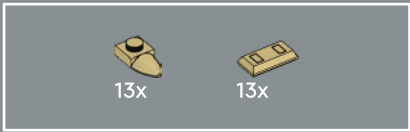

44

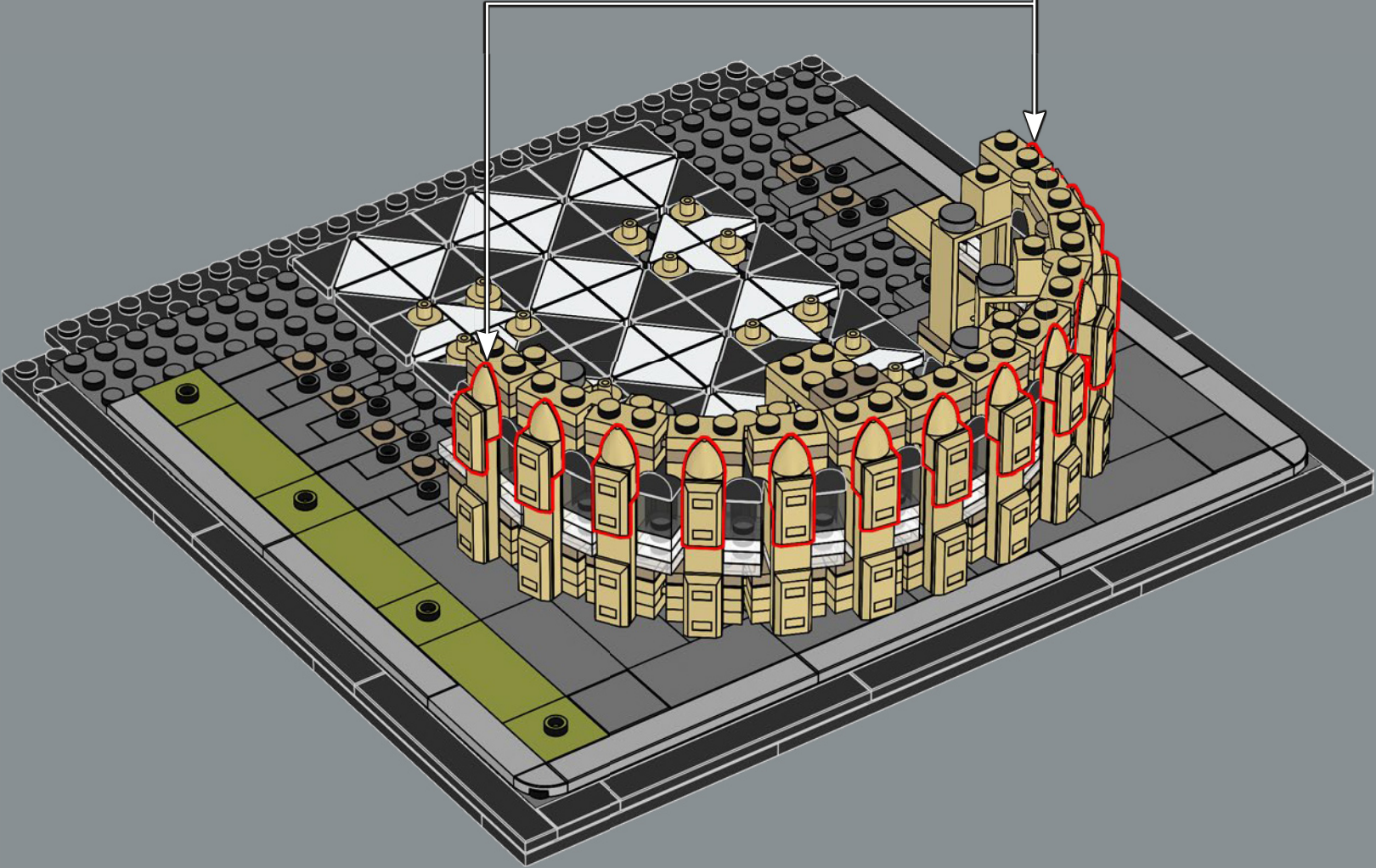
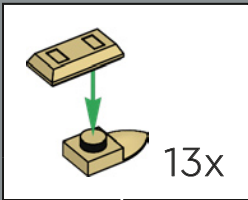

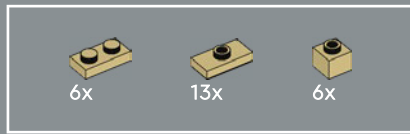

45

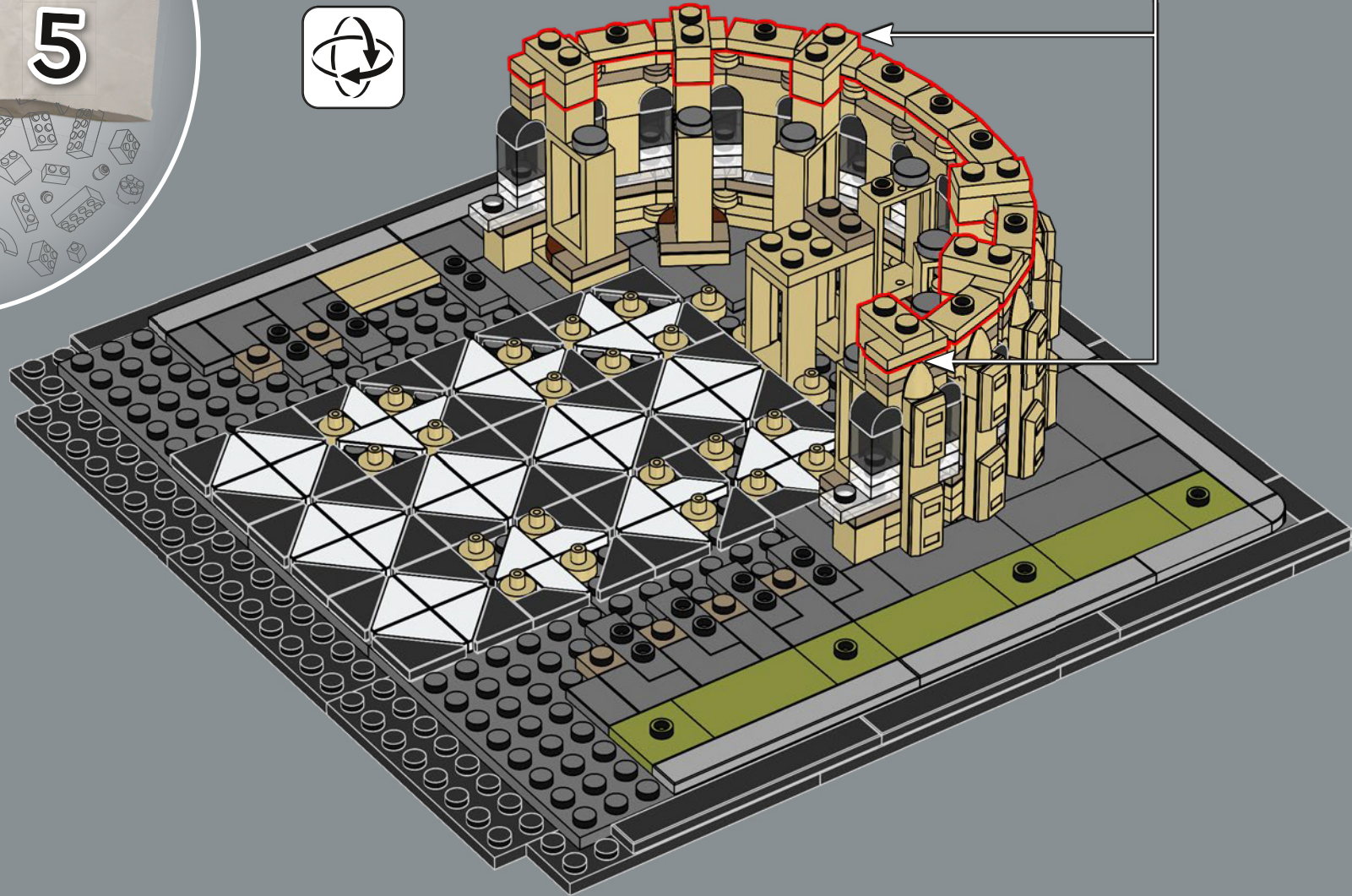
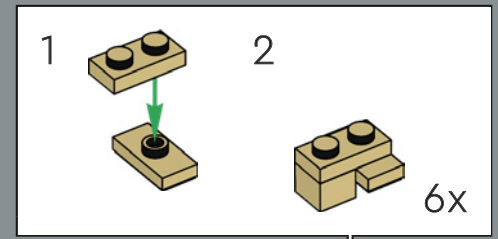

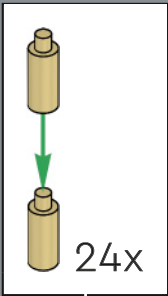

46

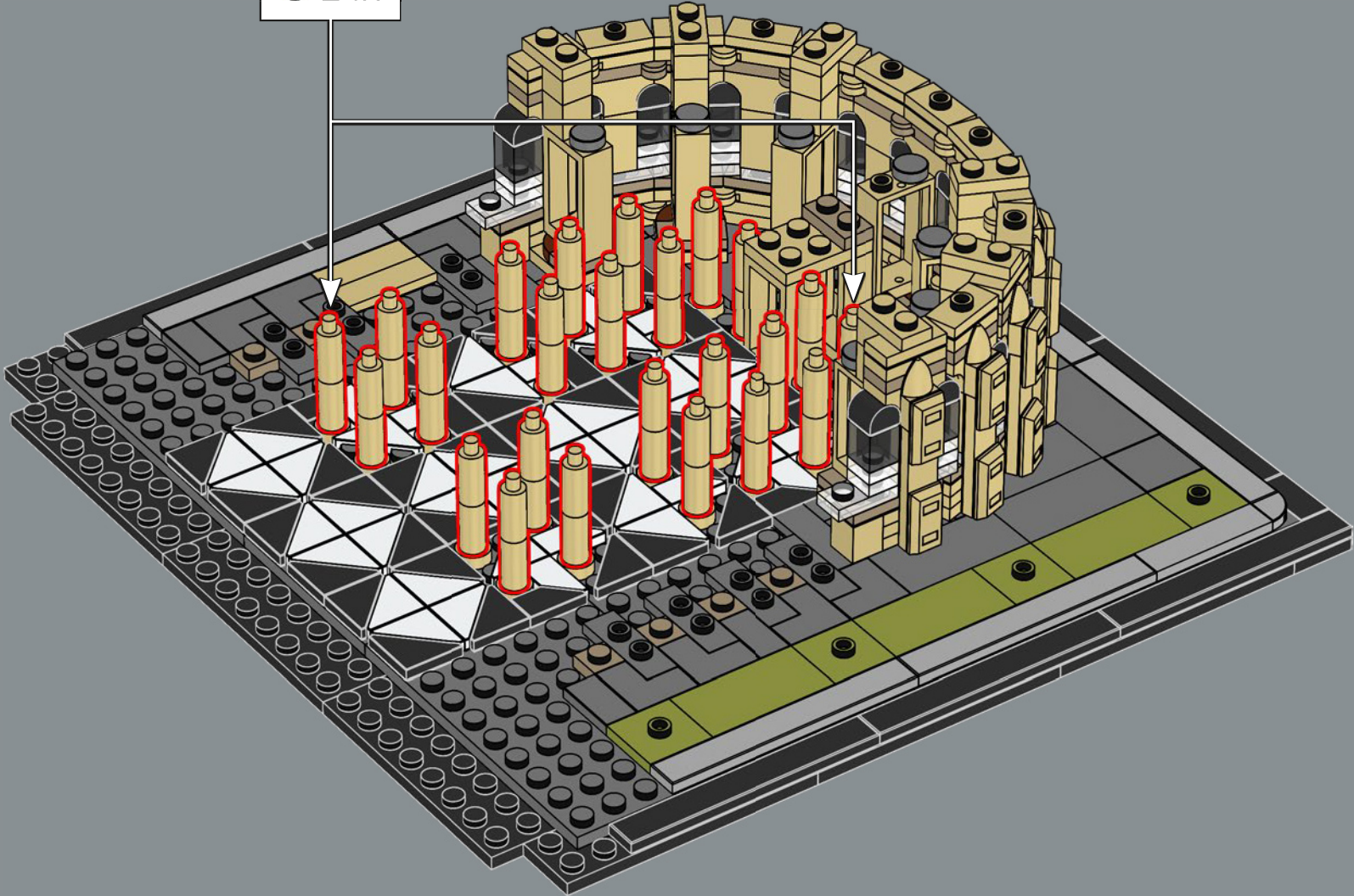

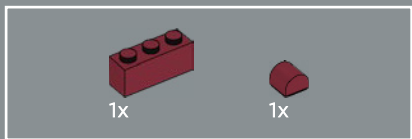

47

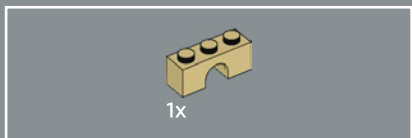
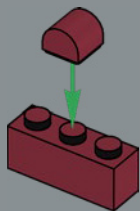

48

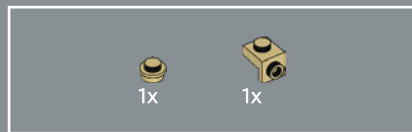
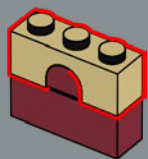

49

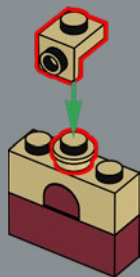

50

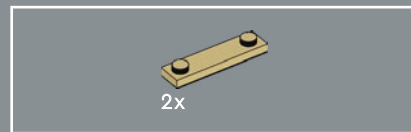
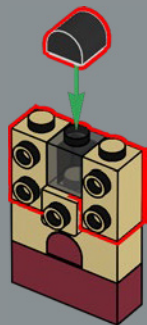

51

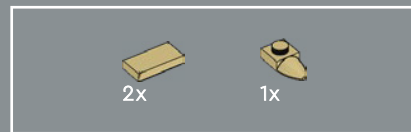
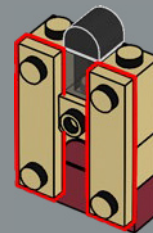

52

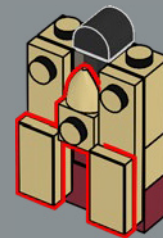

An elegant portal that offers direct access to the choir takes its name from the colour of the portal's door panes – The Porte Rouge. It was renovated around 1270.

53

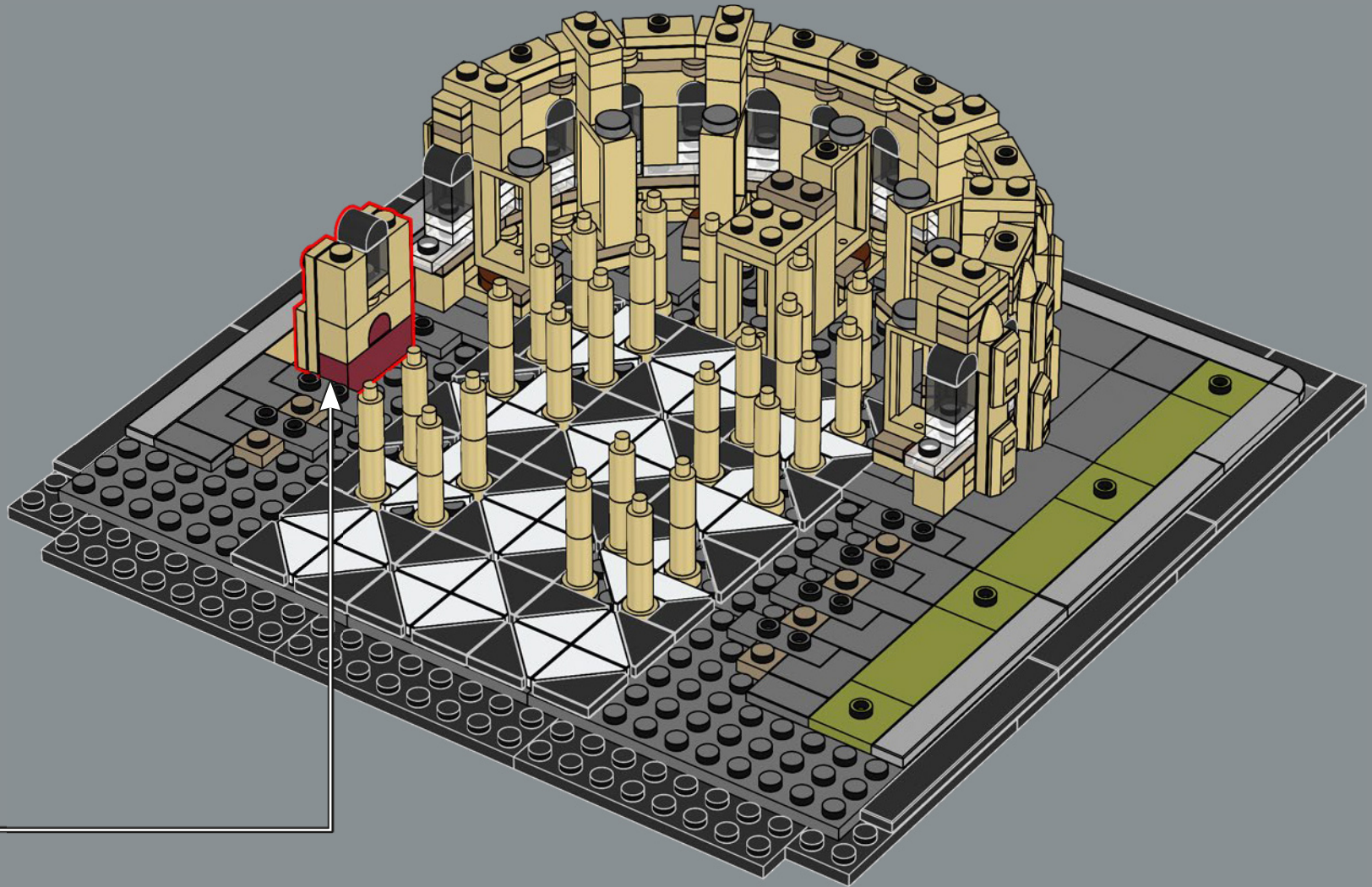

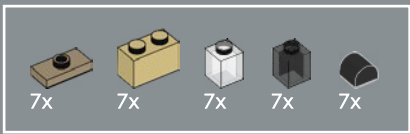

54

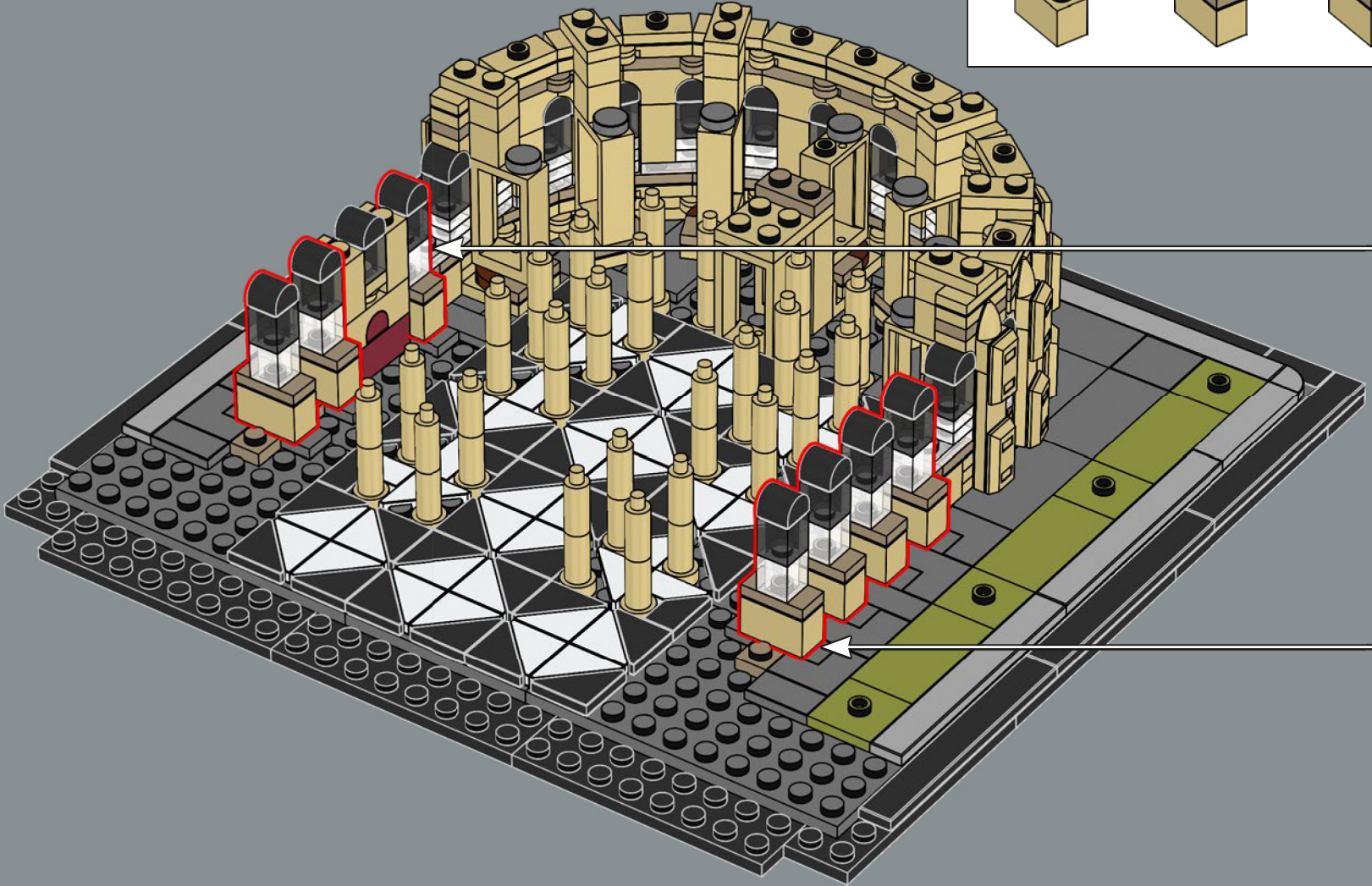
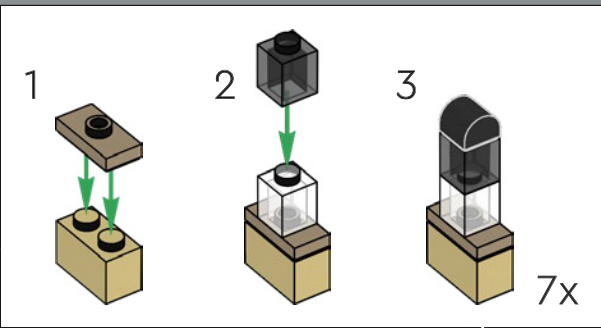

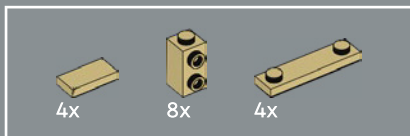

55

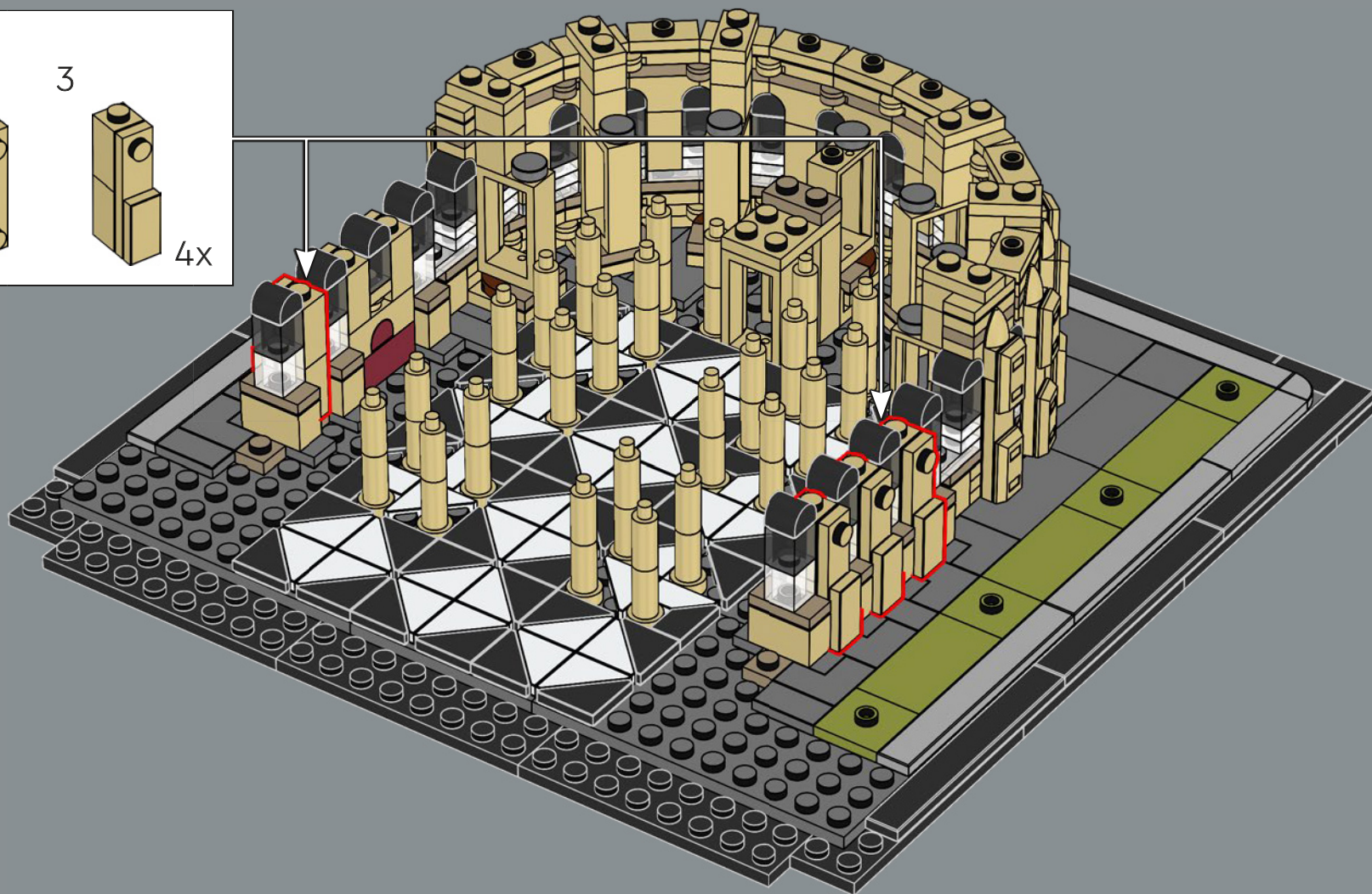
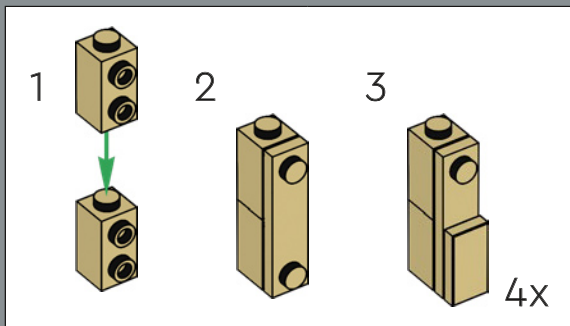

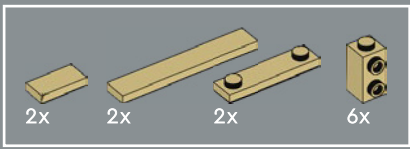

56

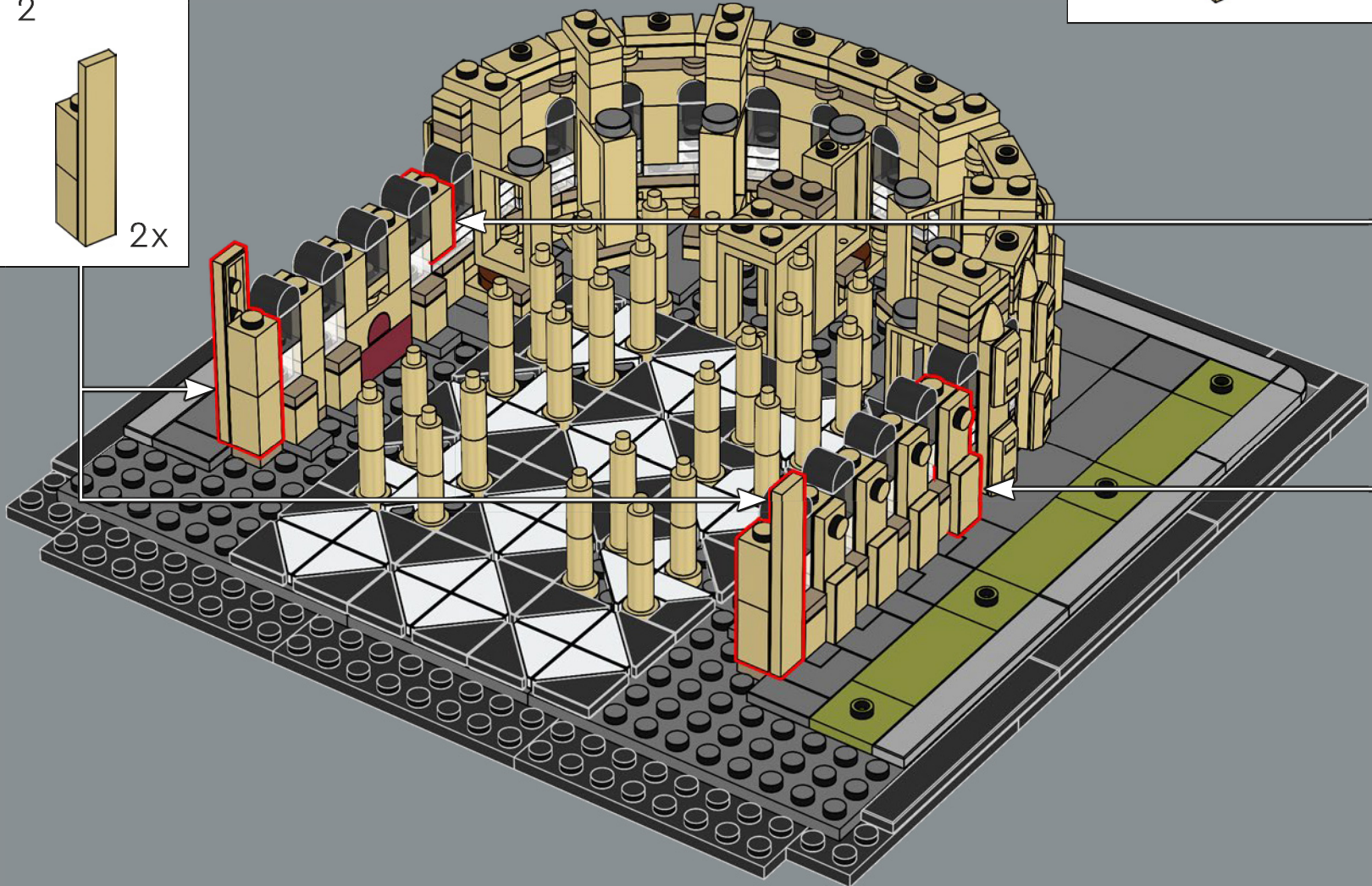
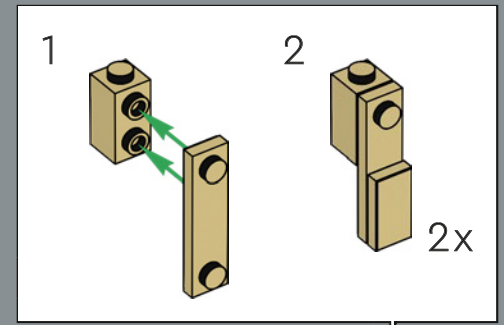
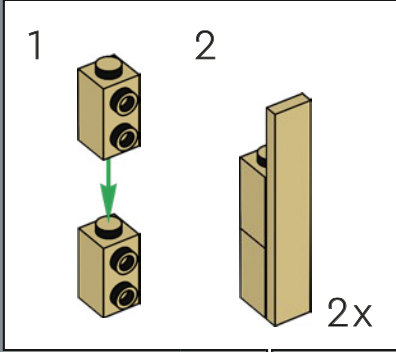

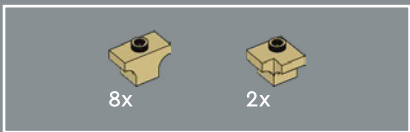

57

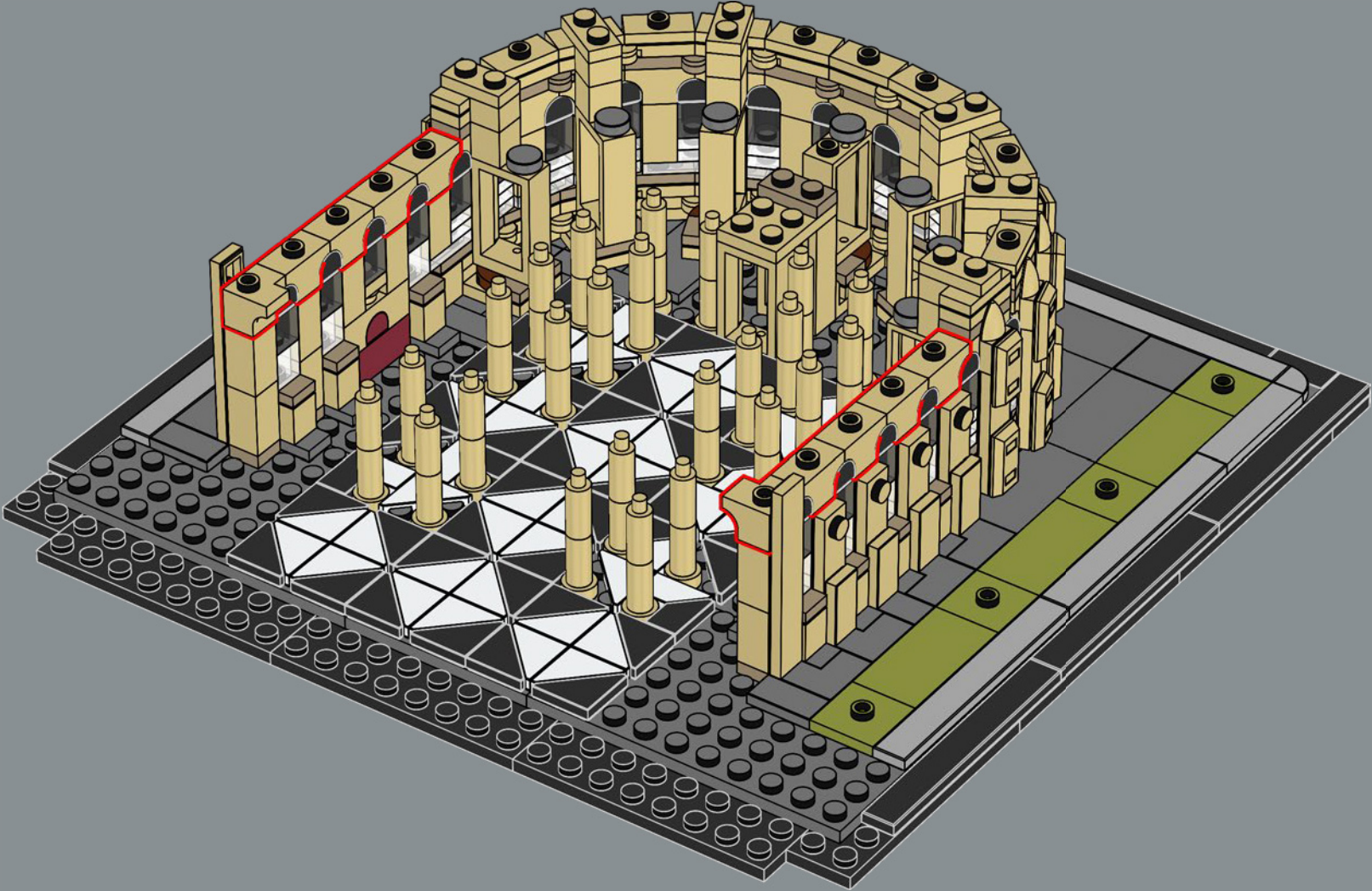

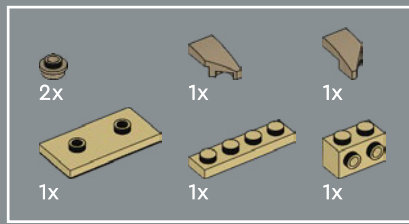

58

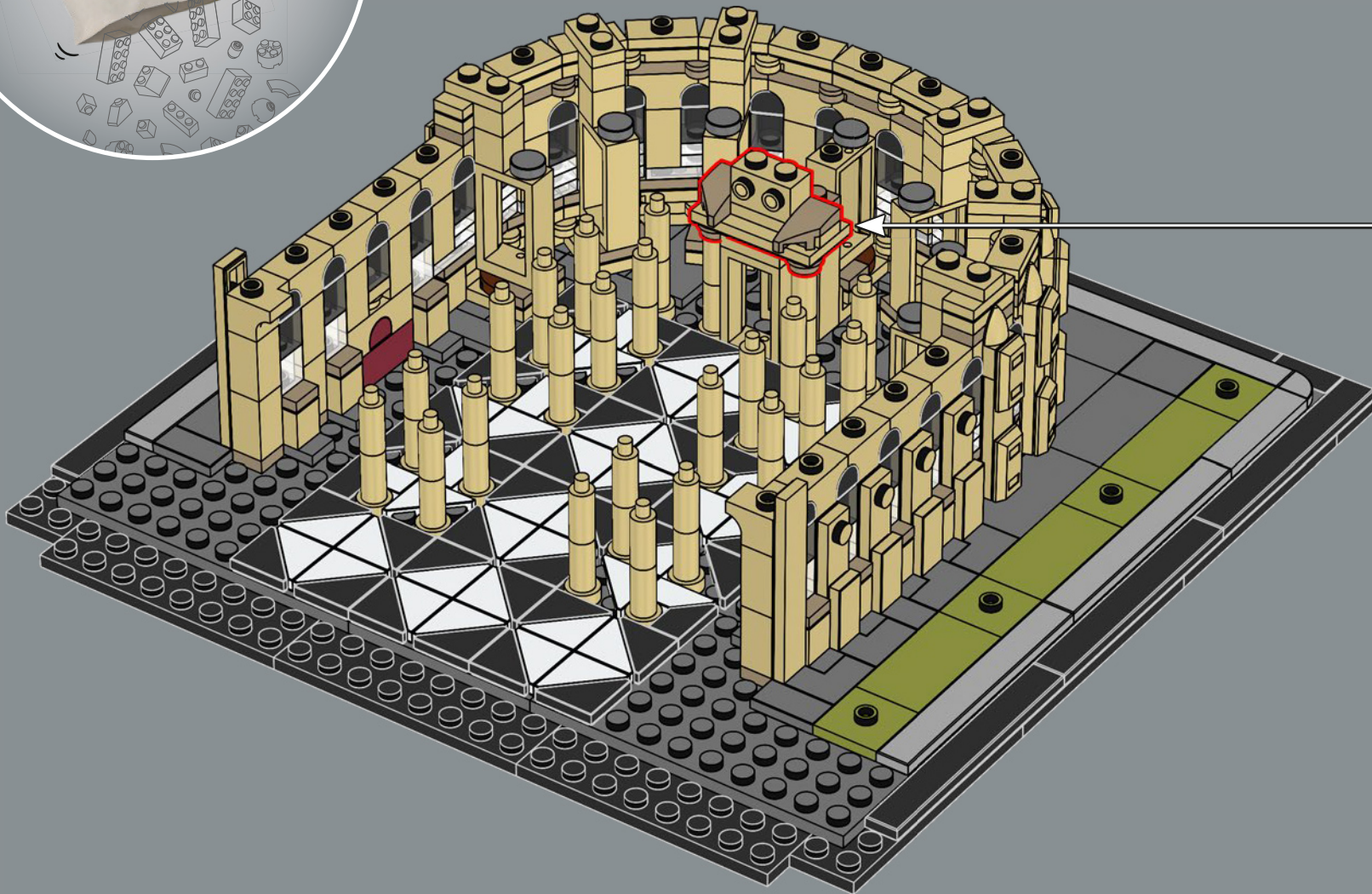
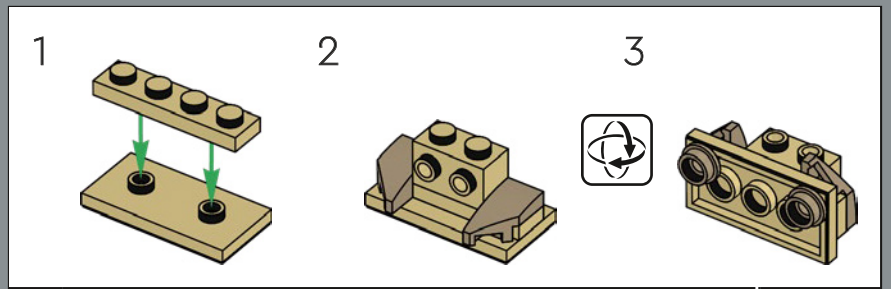

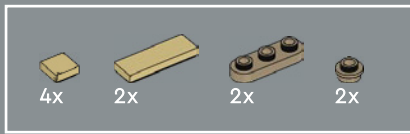

59

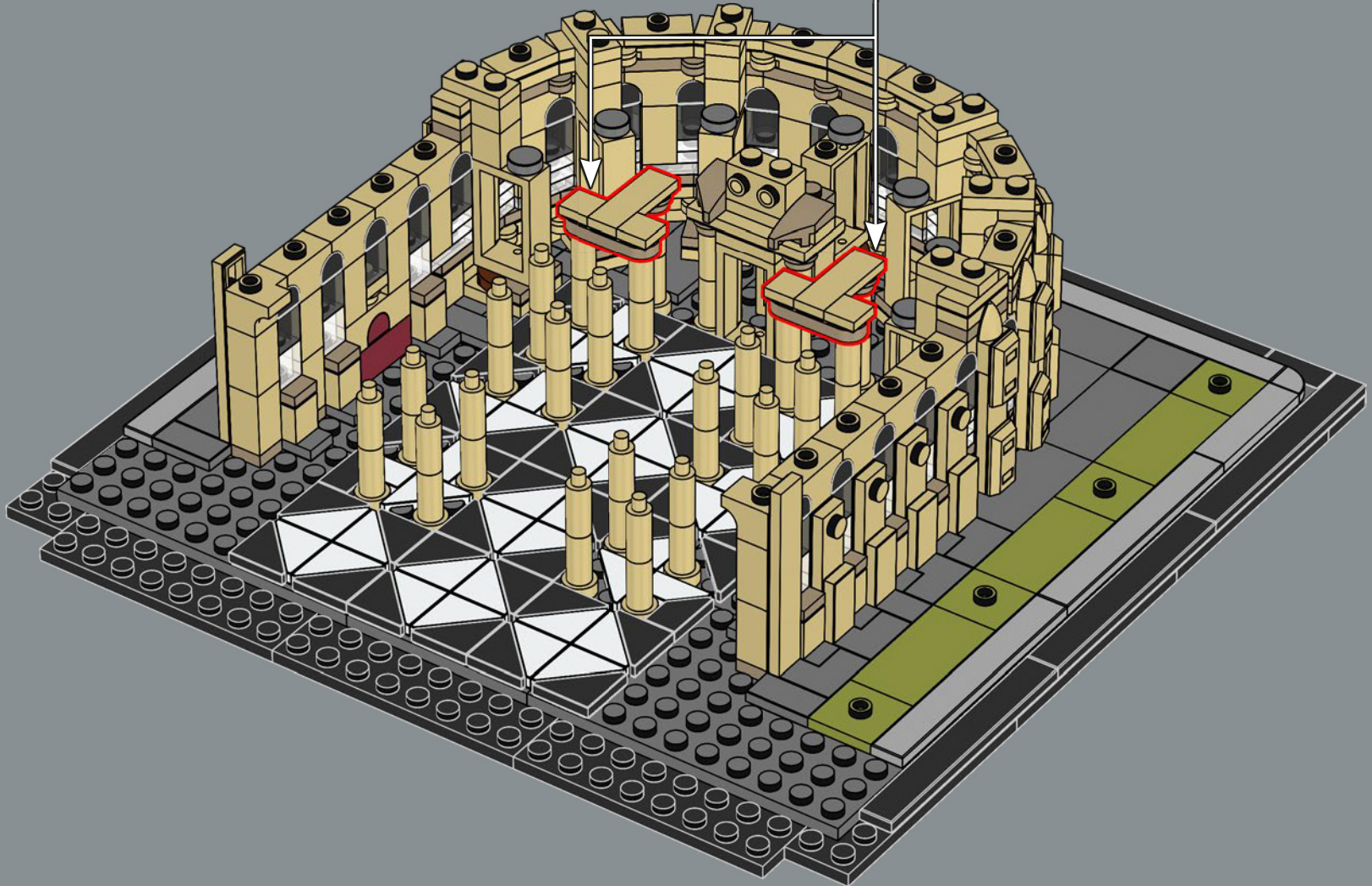
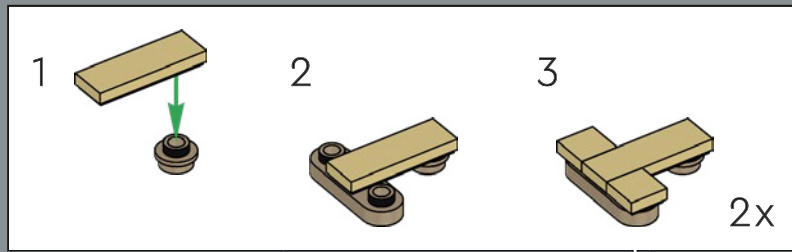

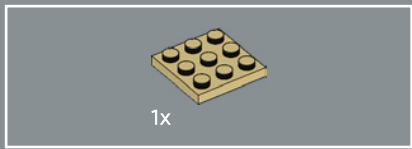

60

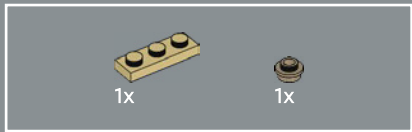

61

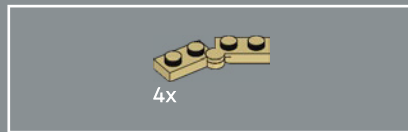
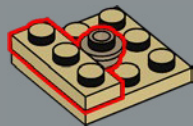

62

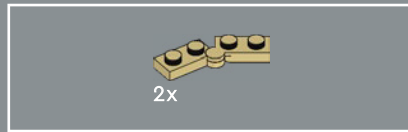
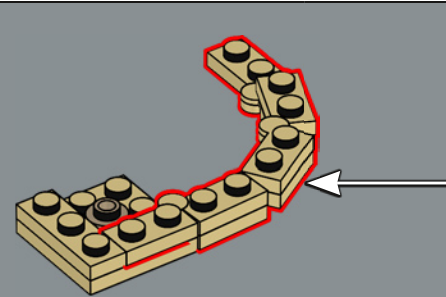
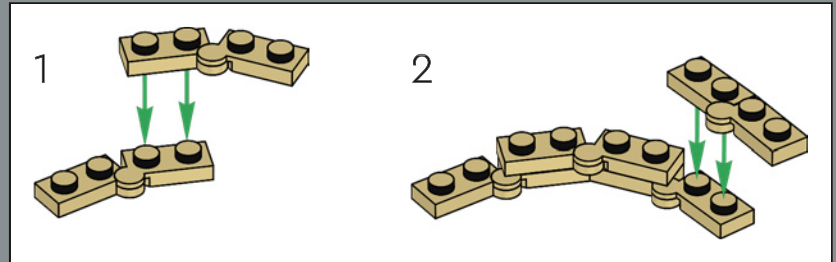

63

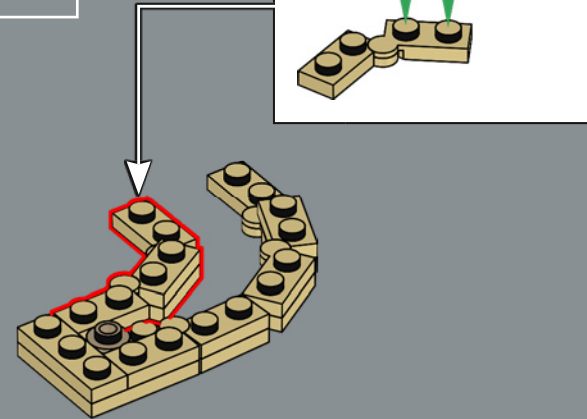

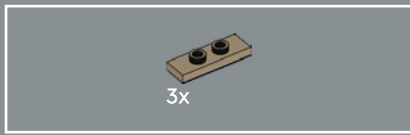

64

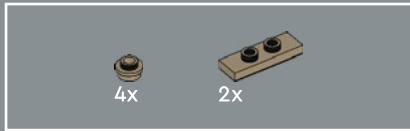
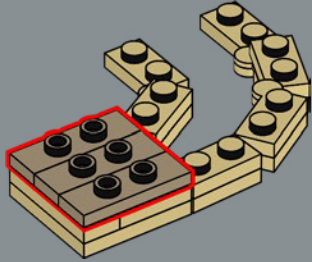

65

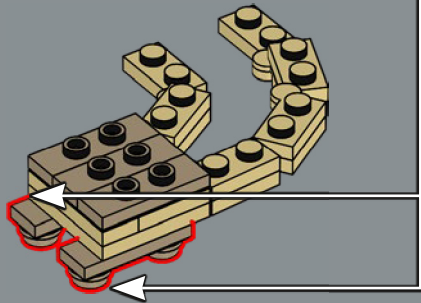
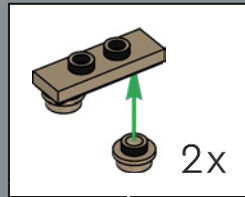

66

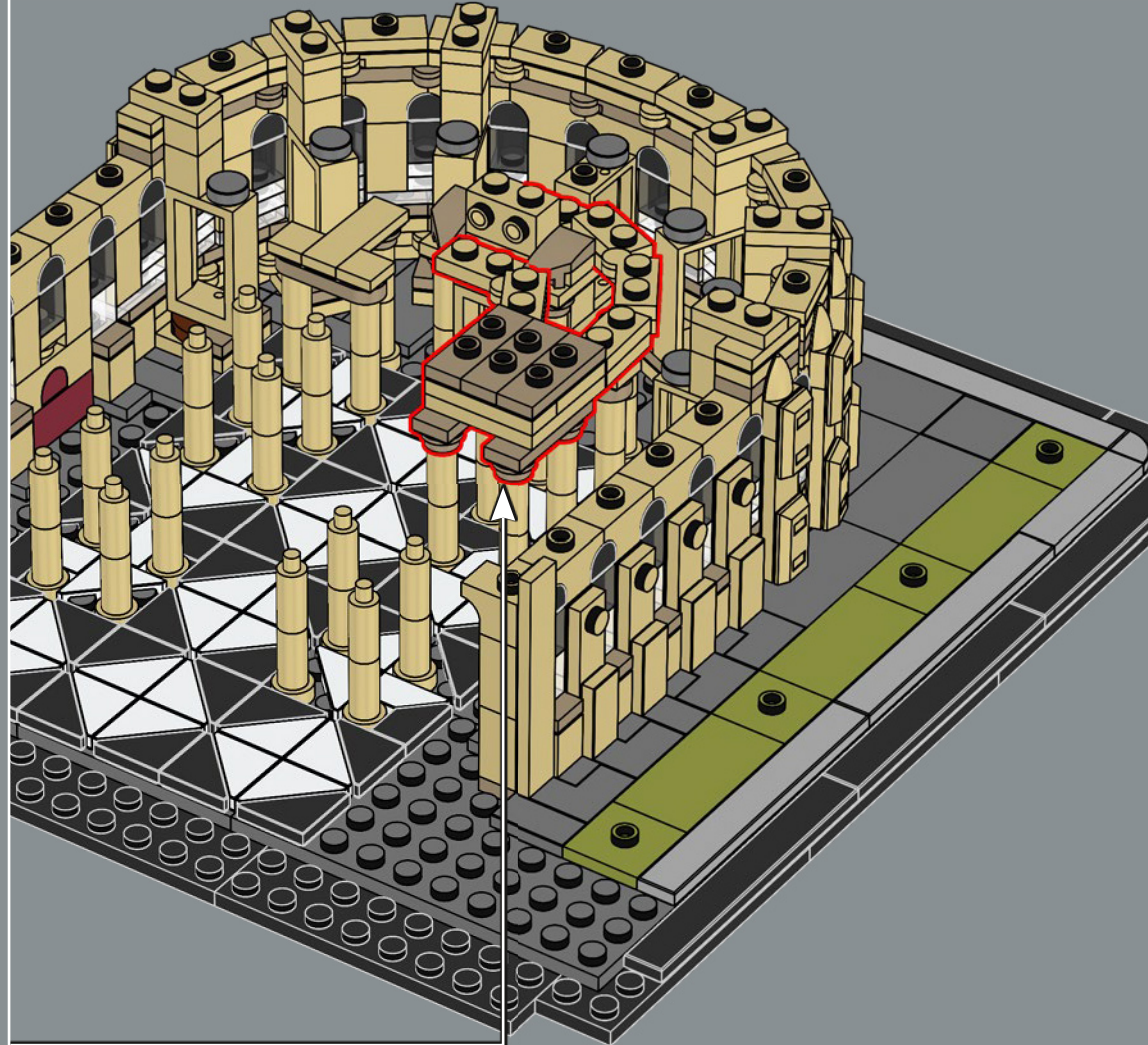

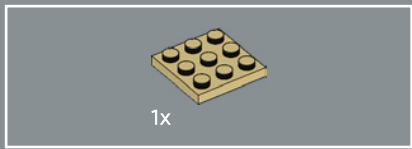

67

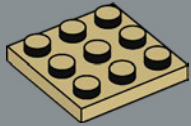

68

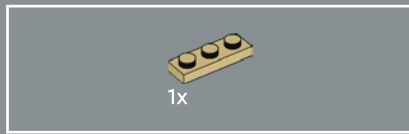
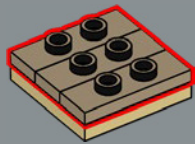

69

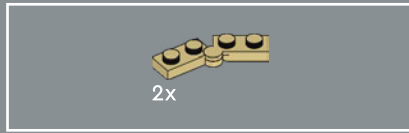
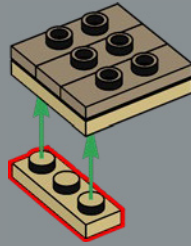

70

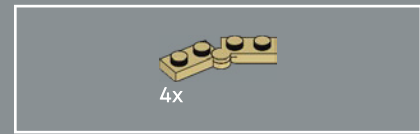
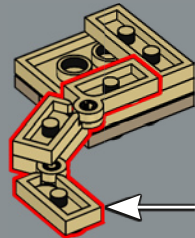
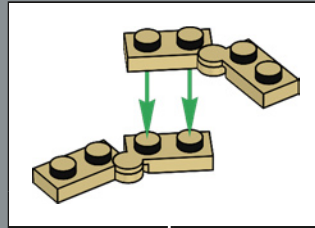

71

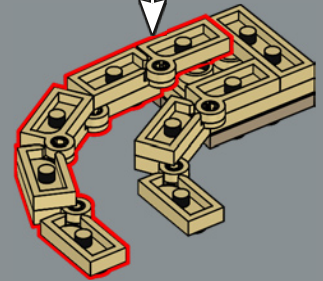
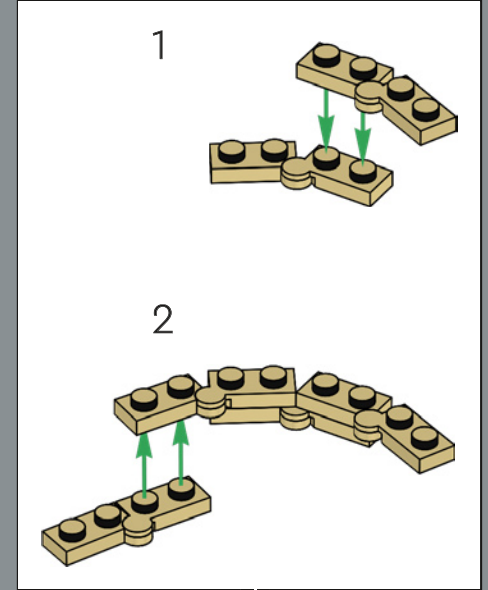

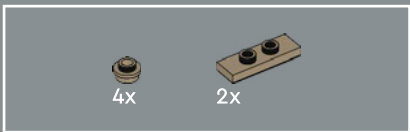

72

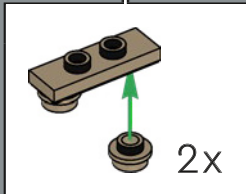
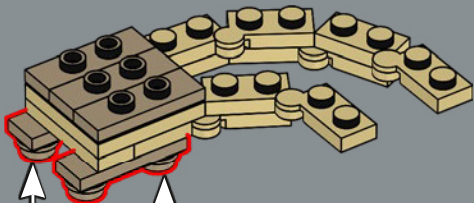

73

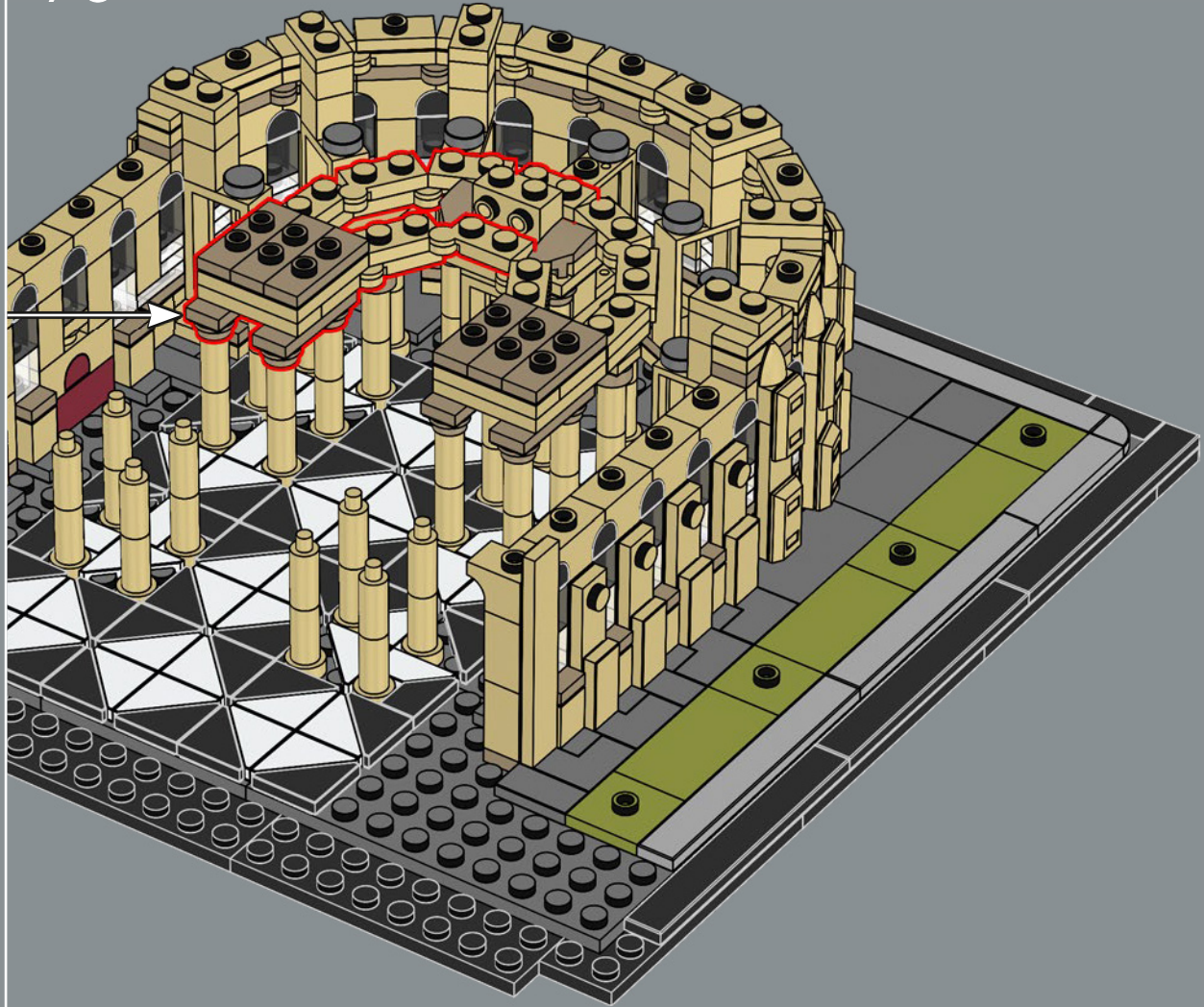

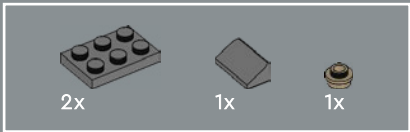

74

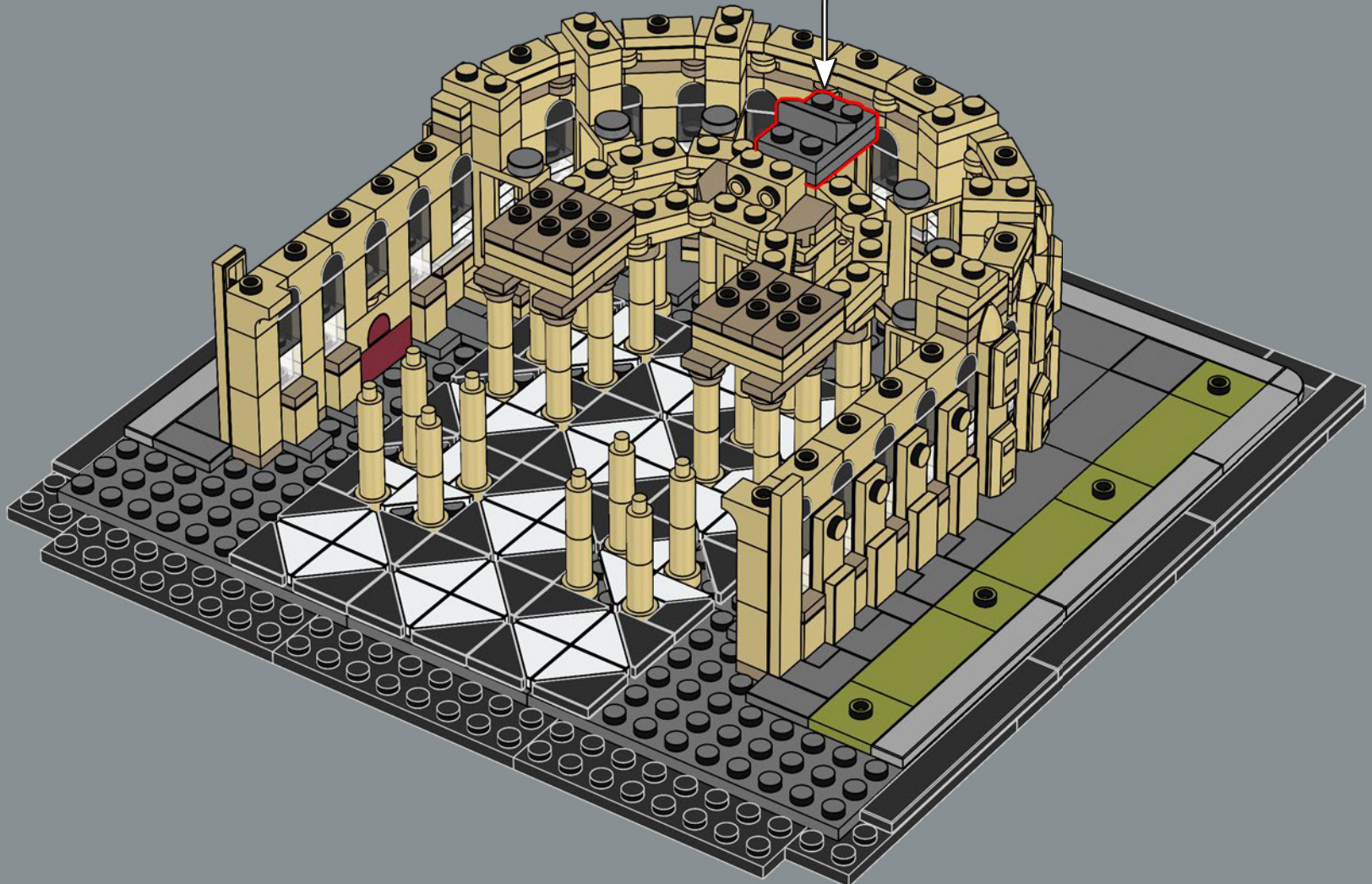
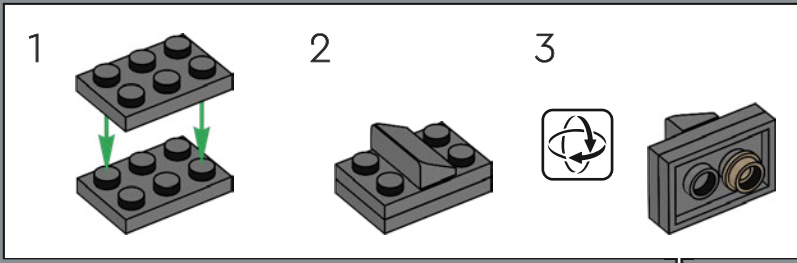

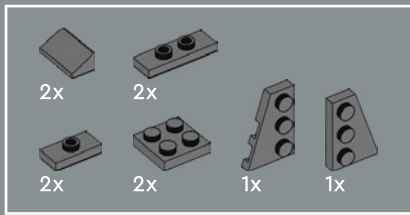

75

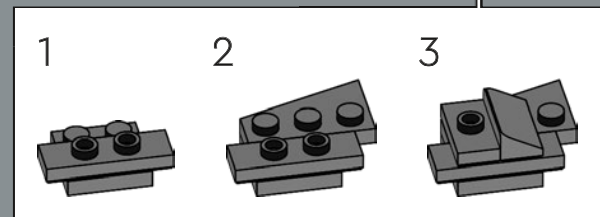
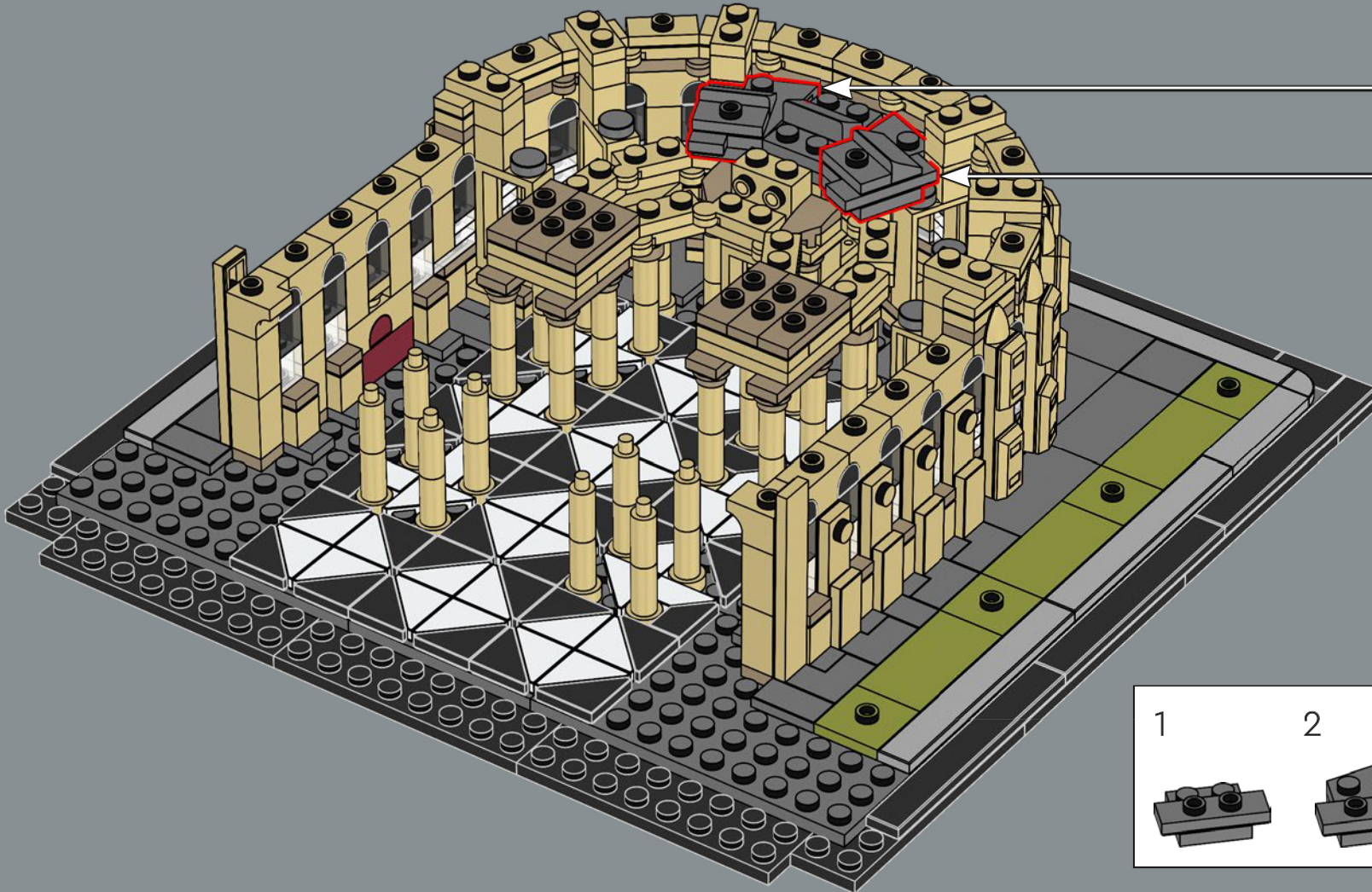
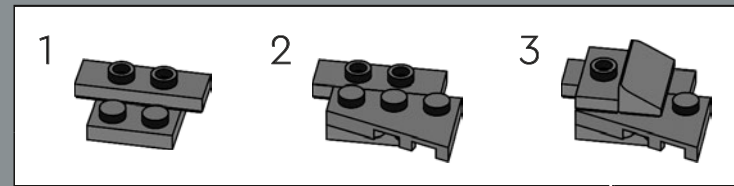

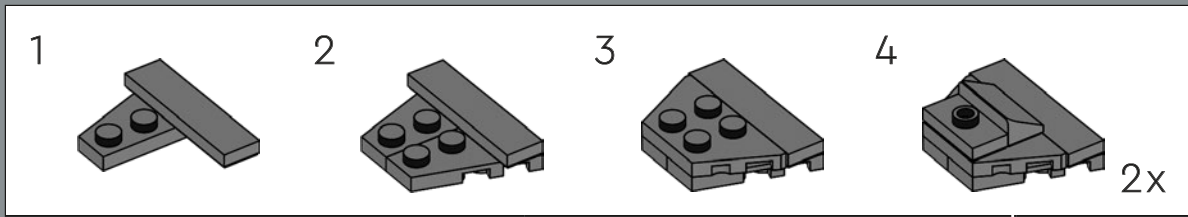
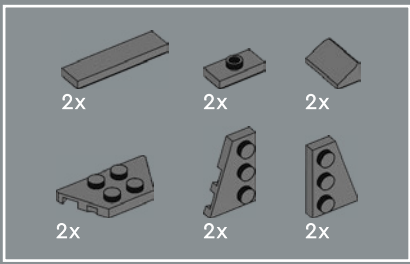

76

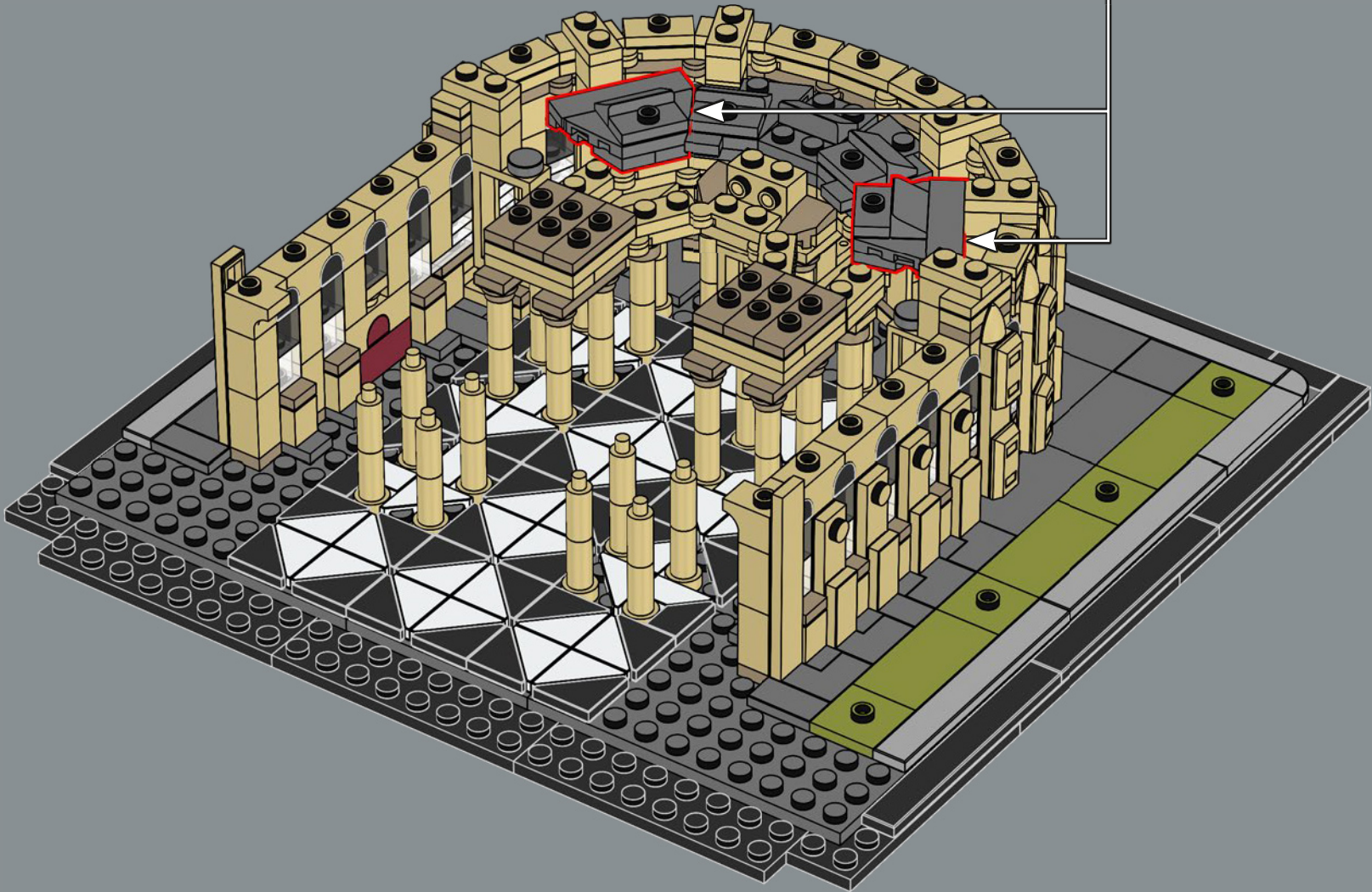

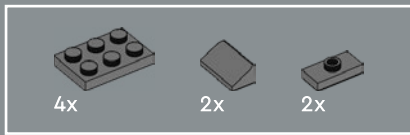

77

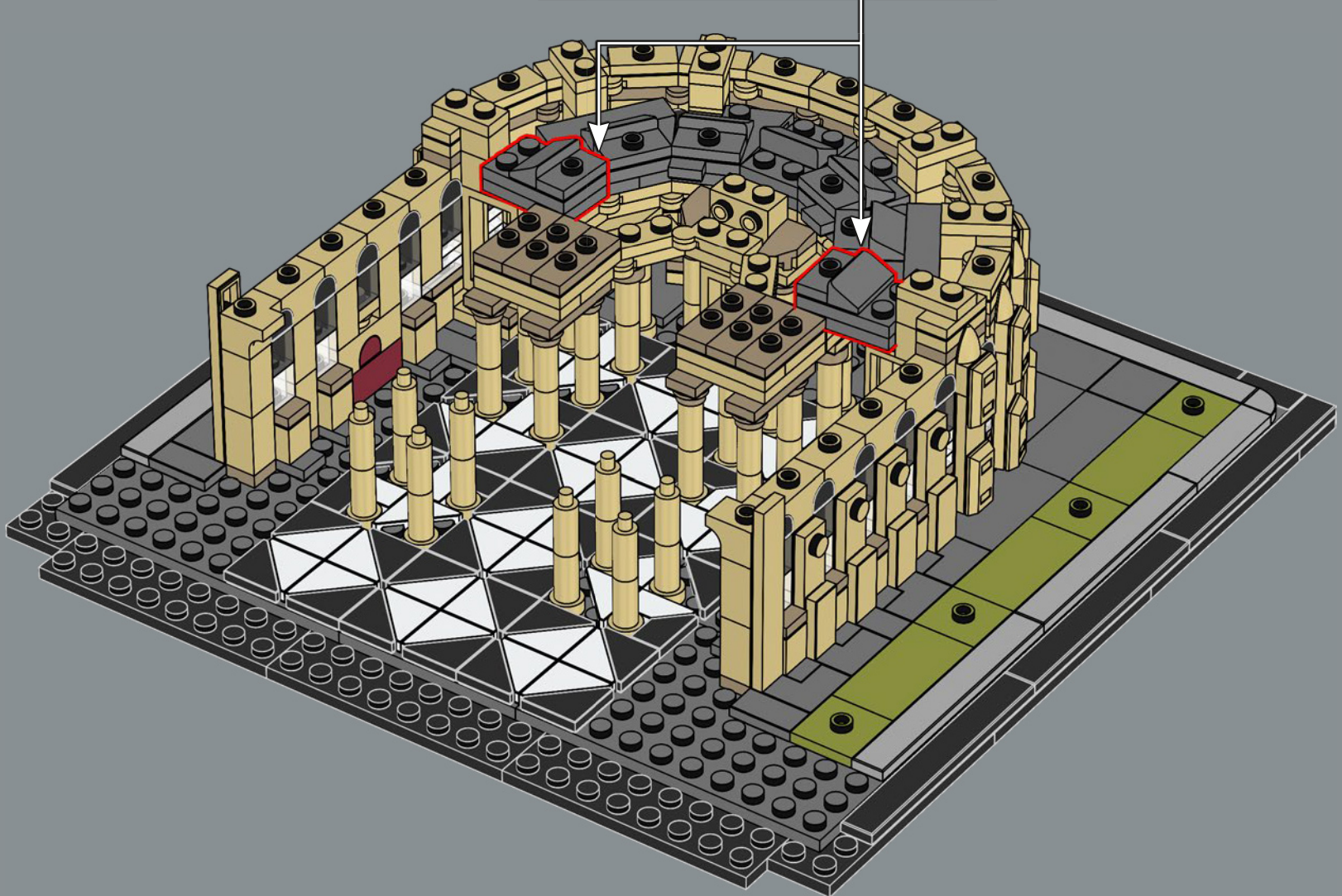
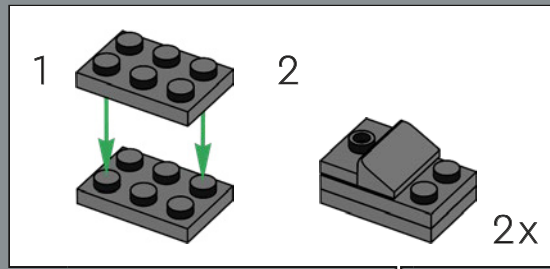



78

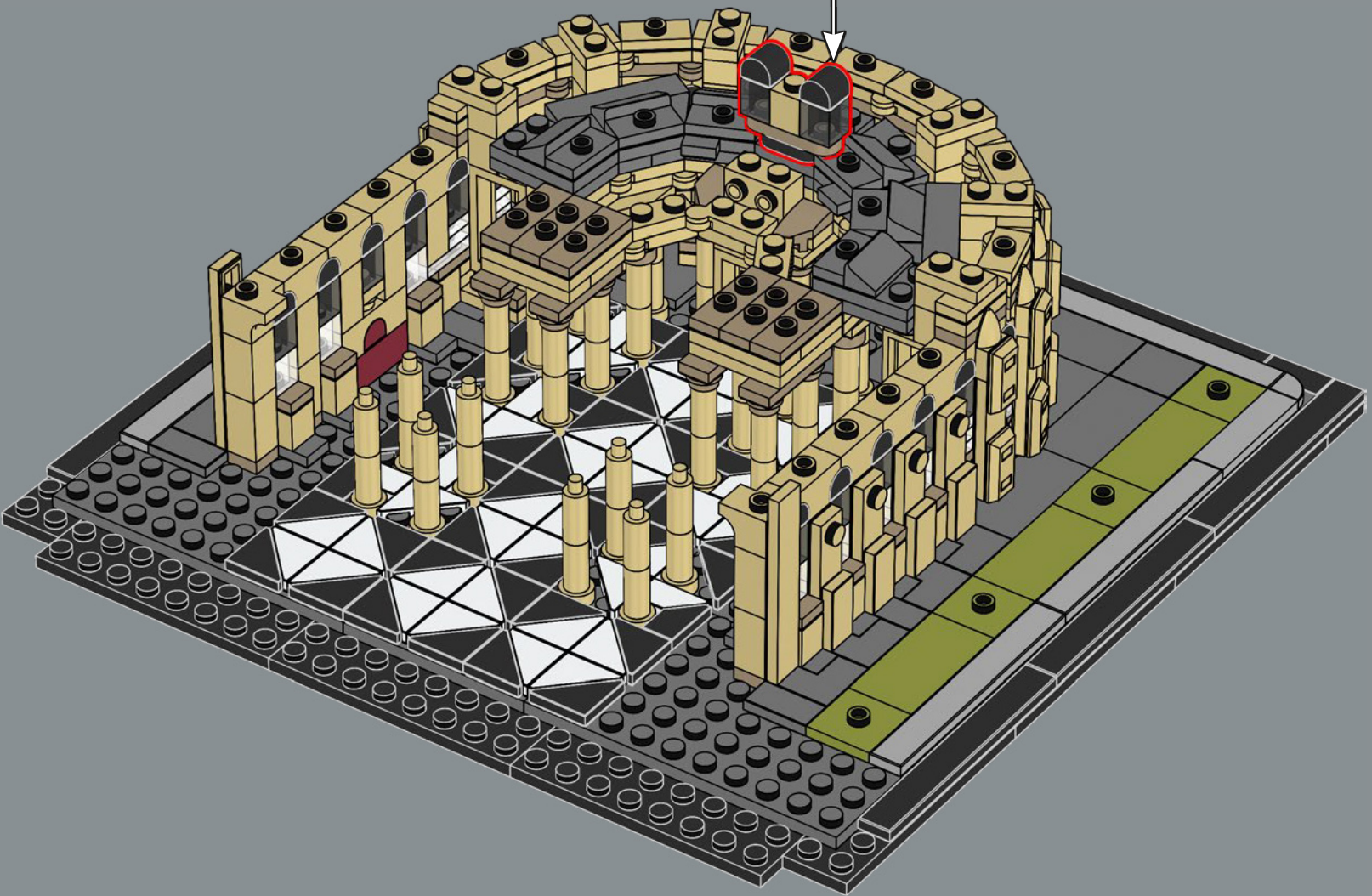
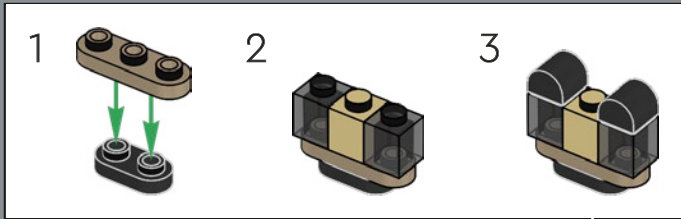



79

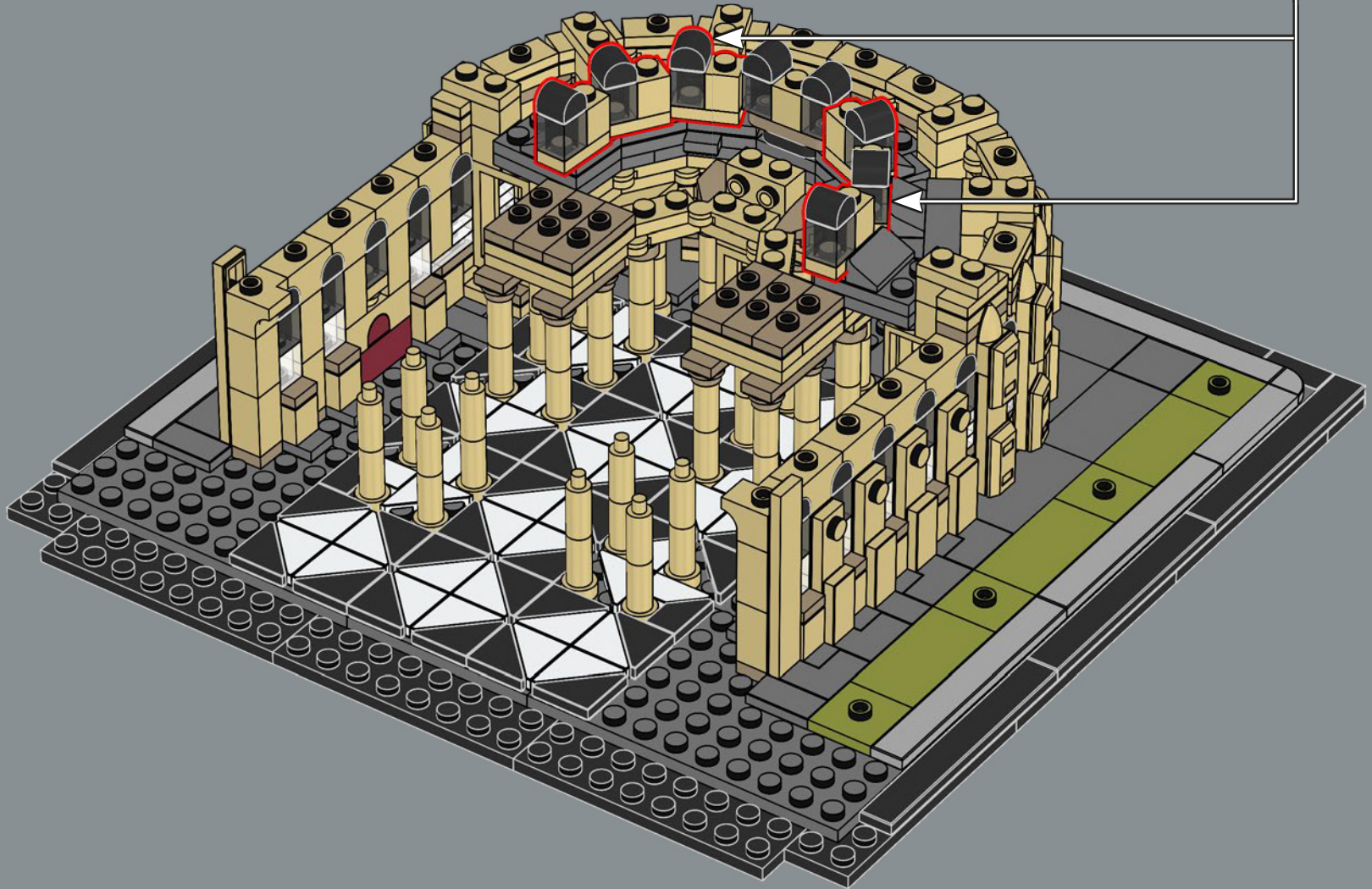
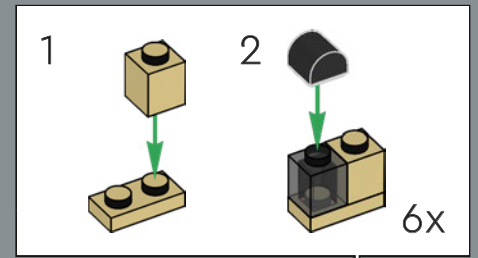



7x

80

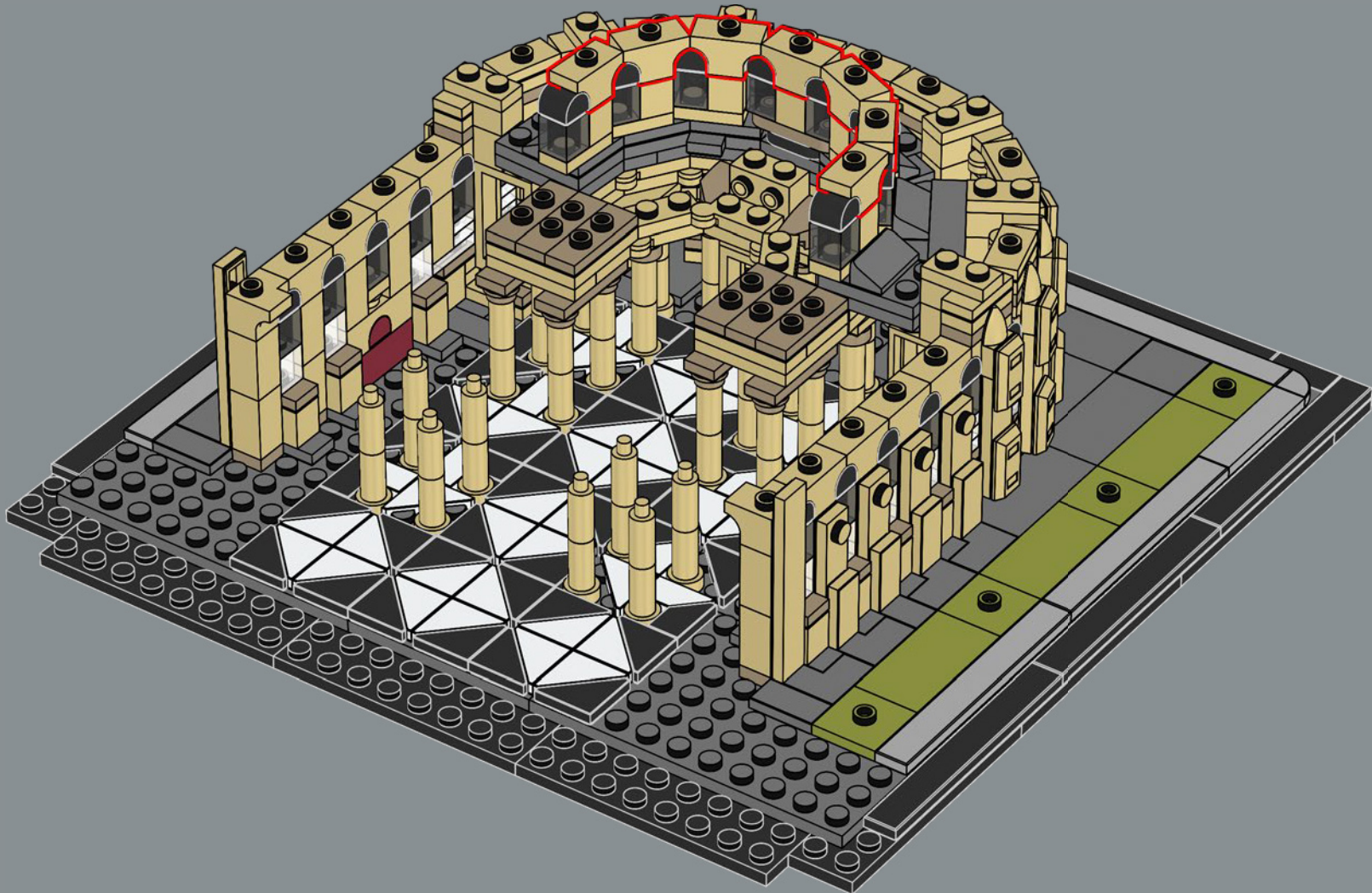

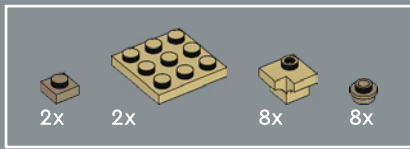

81

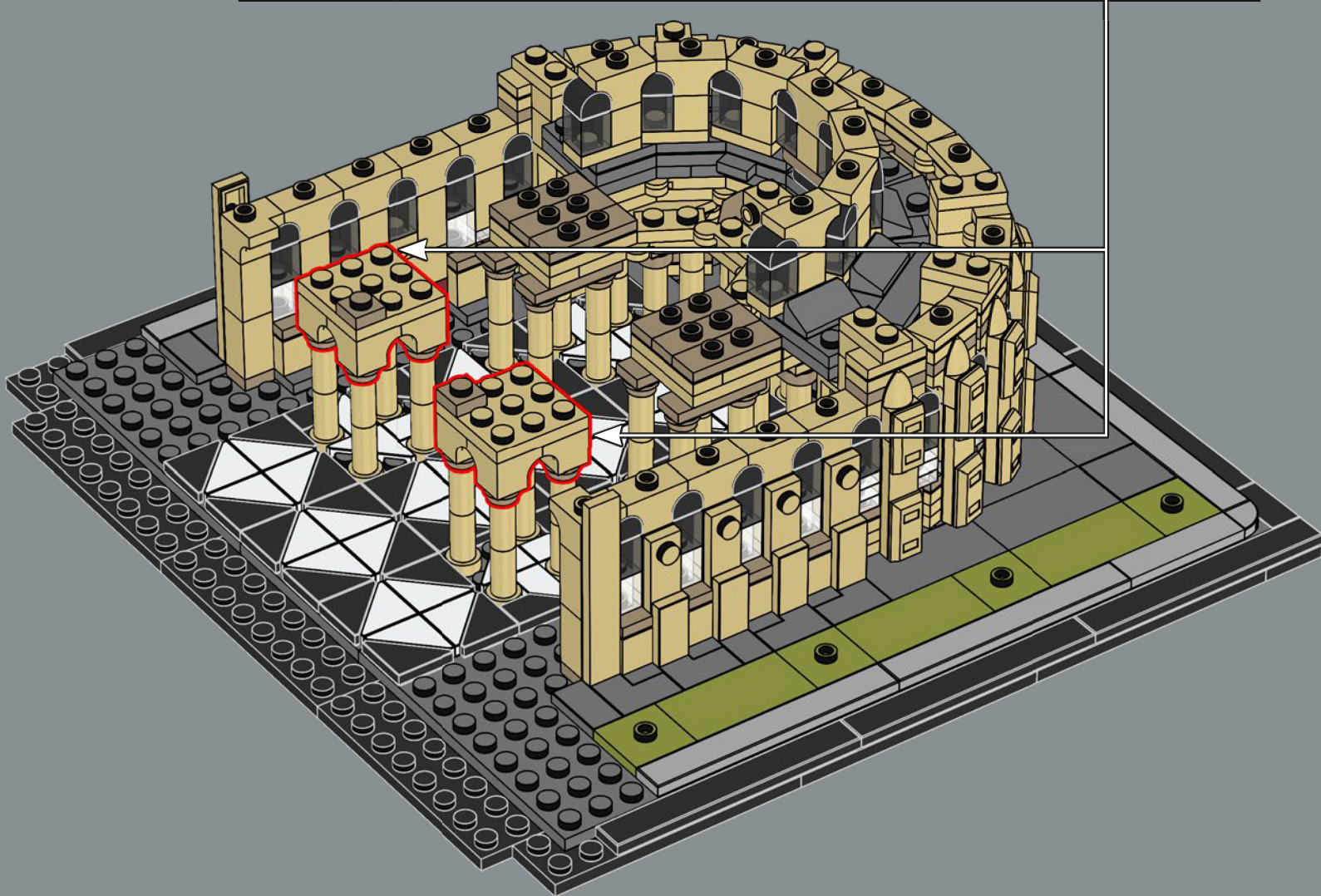
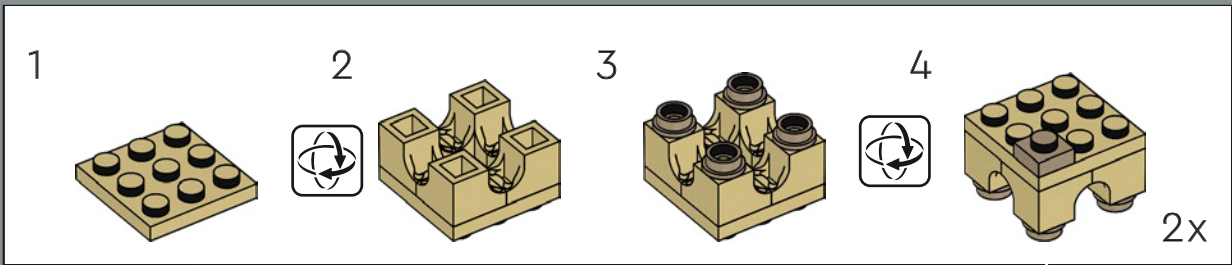

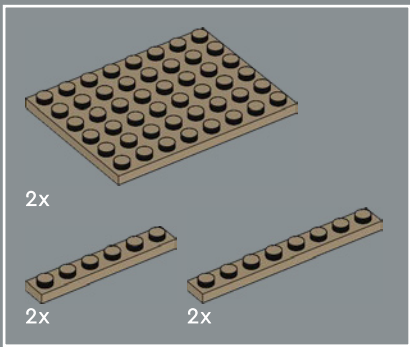

82

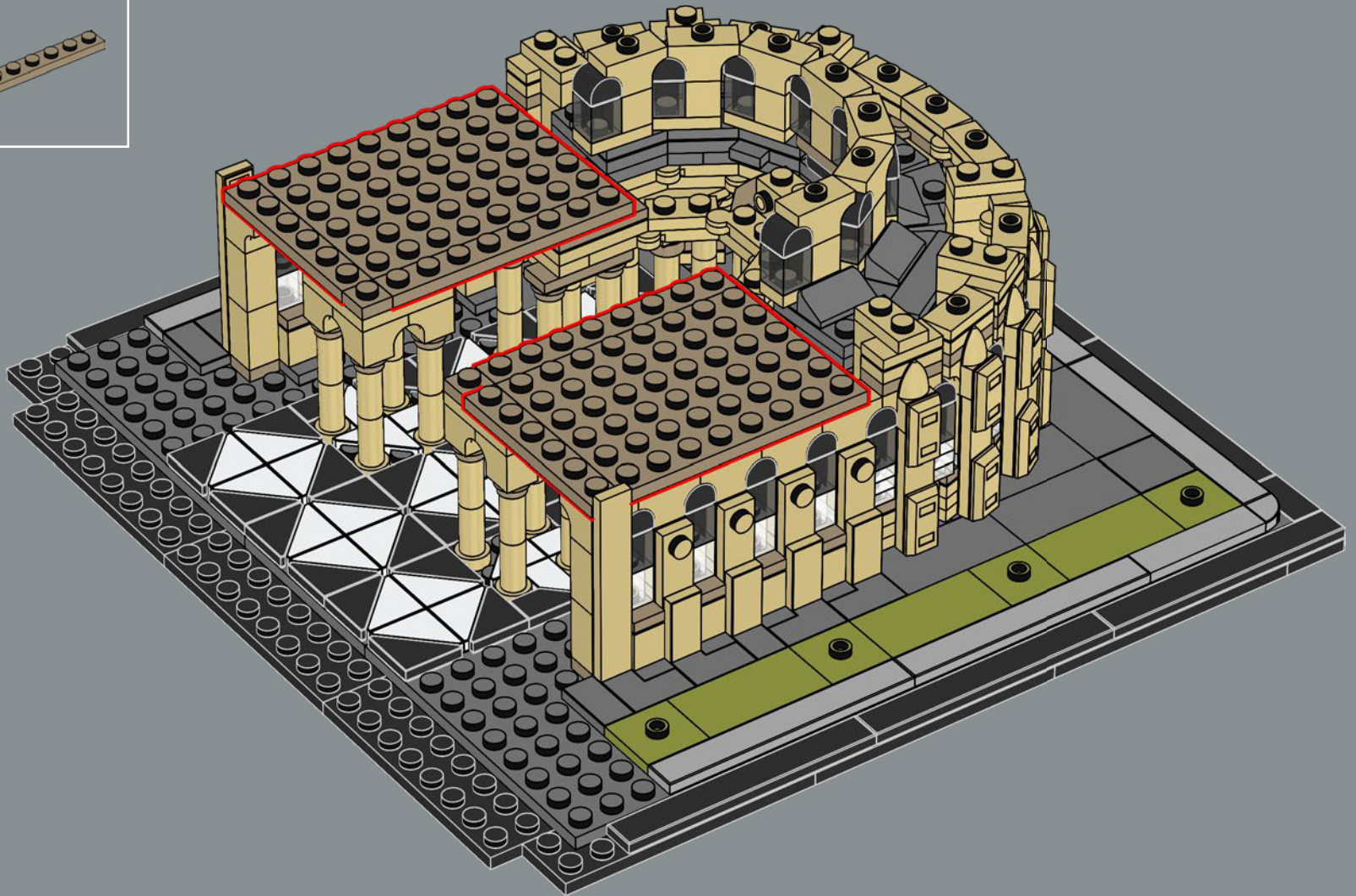



83

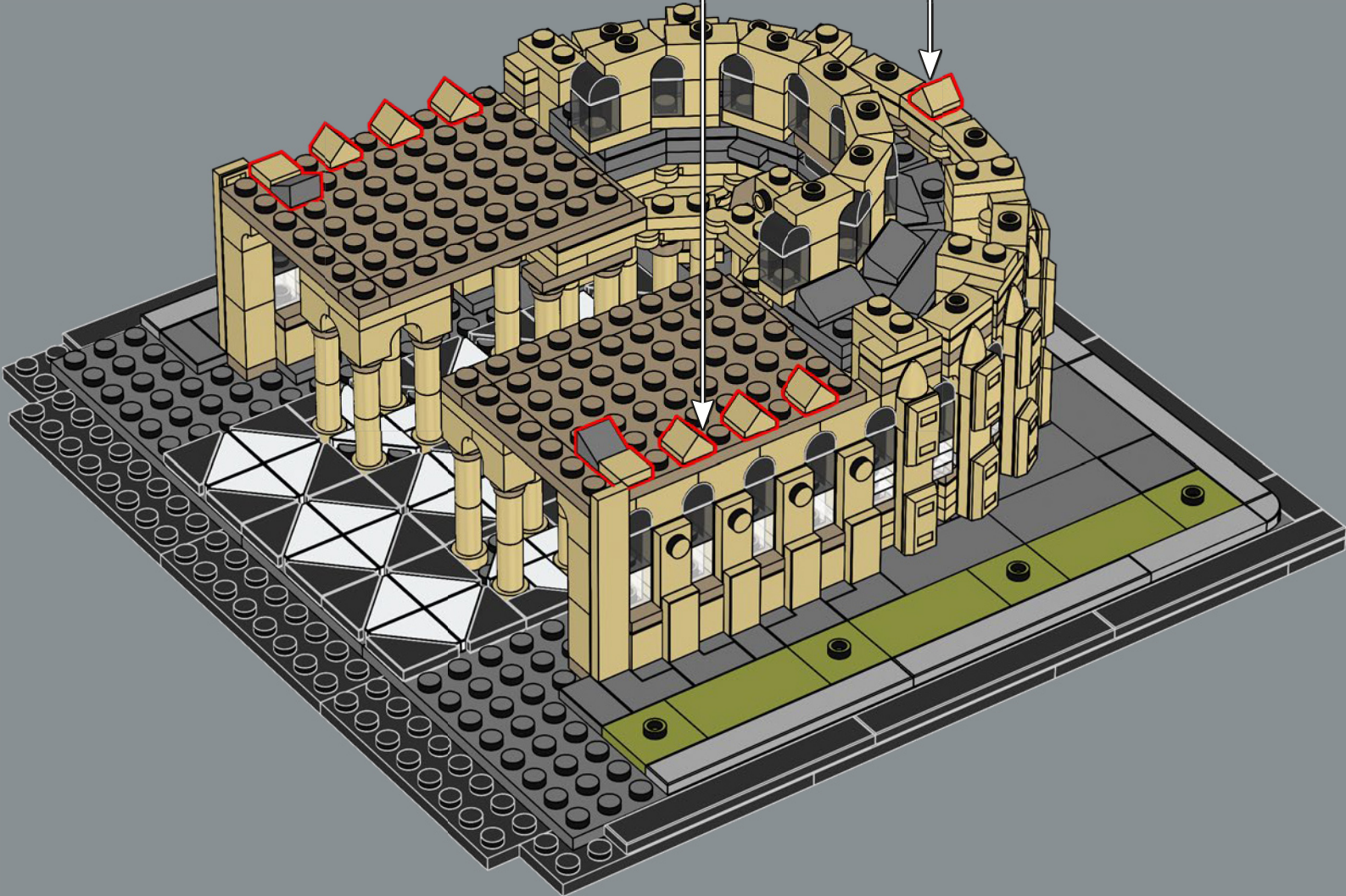

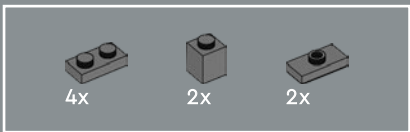

85

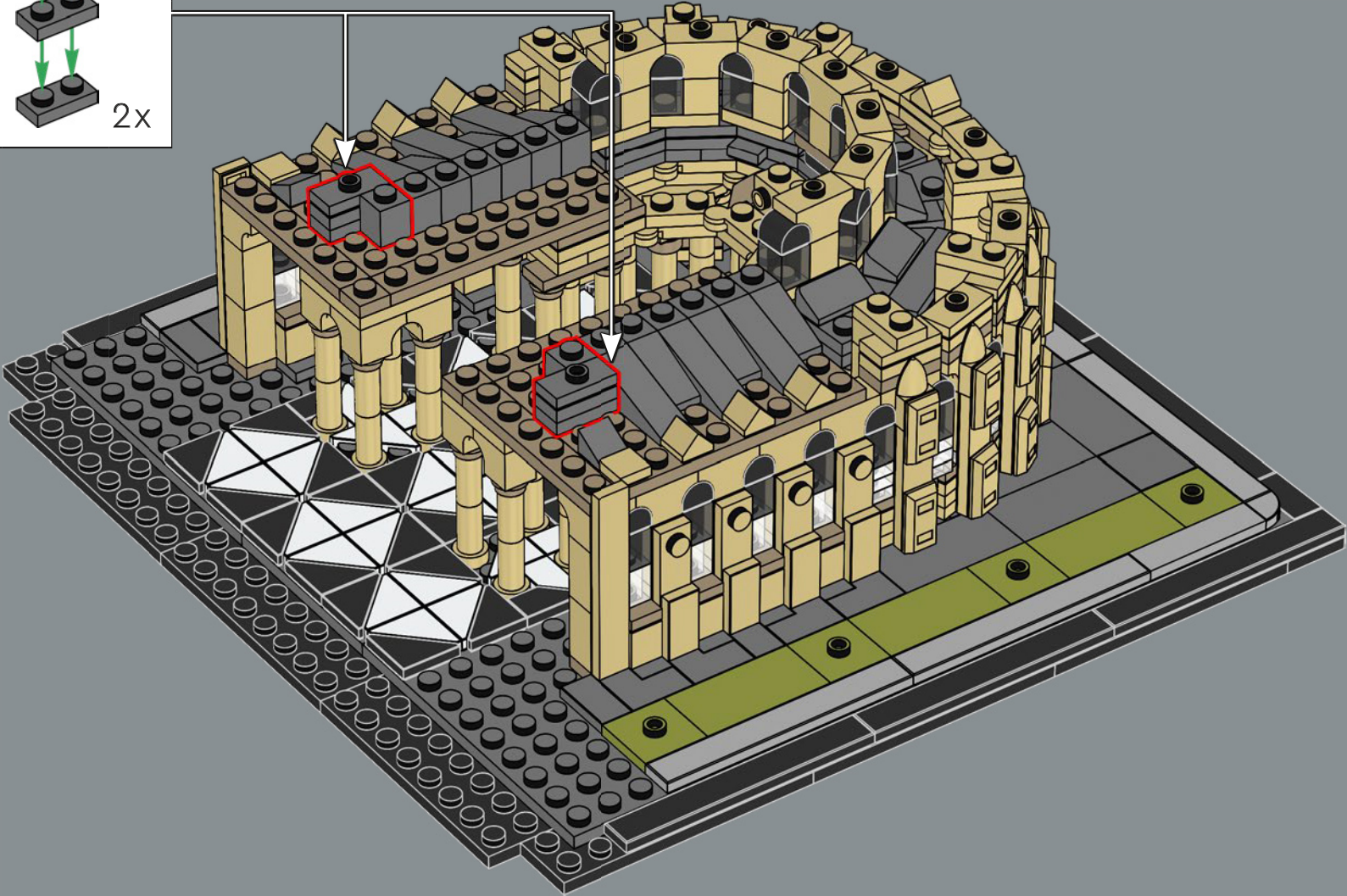
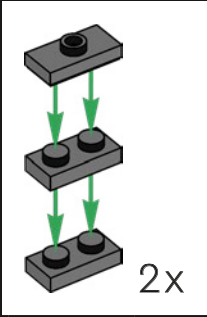



12x

86

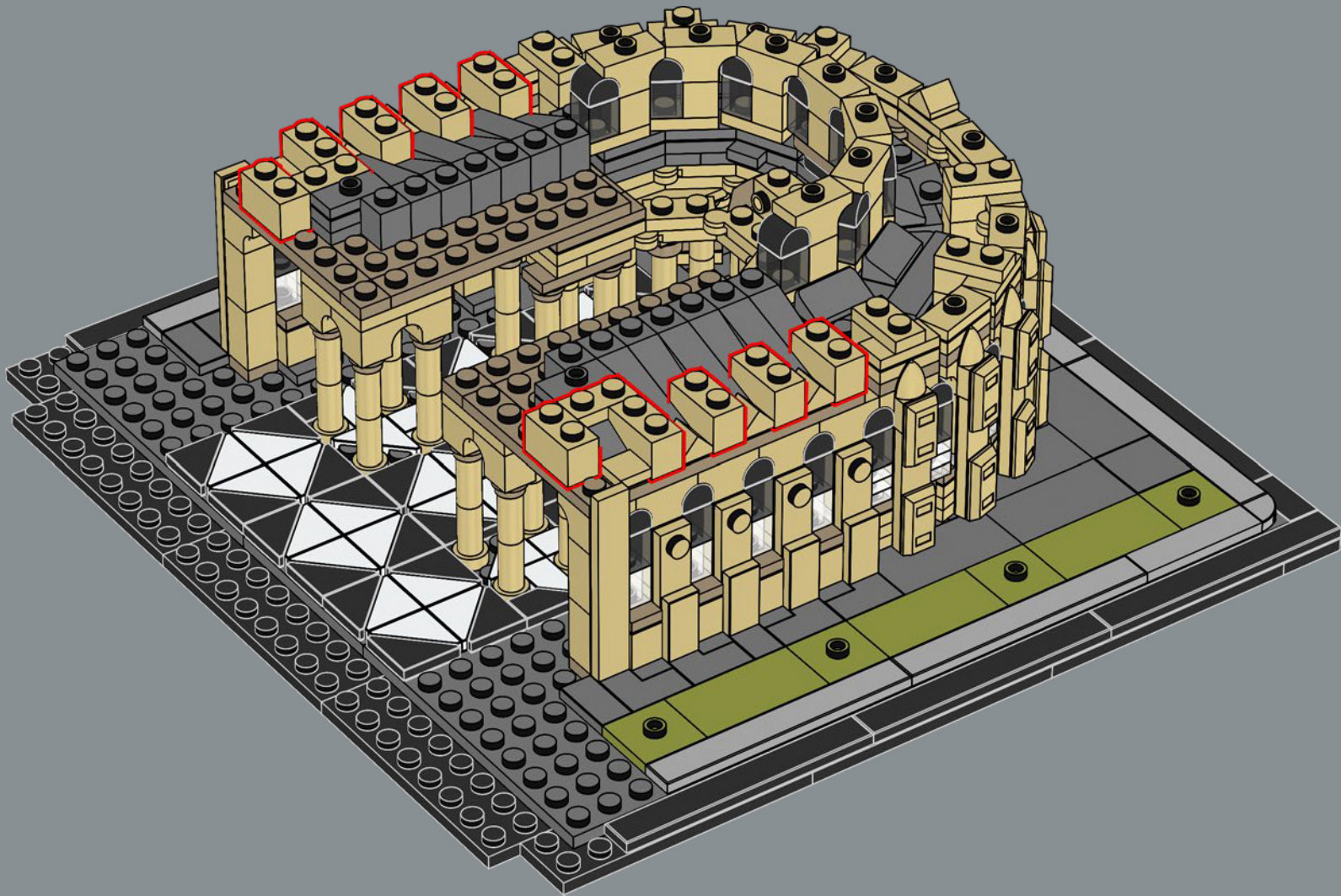



87

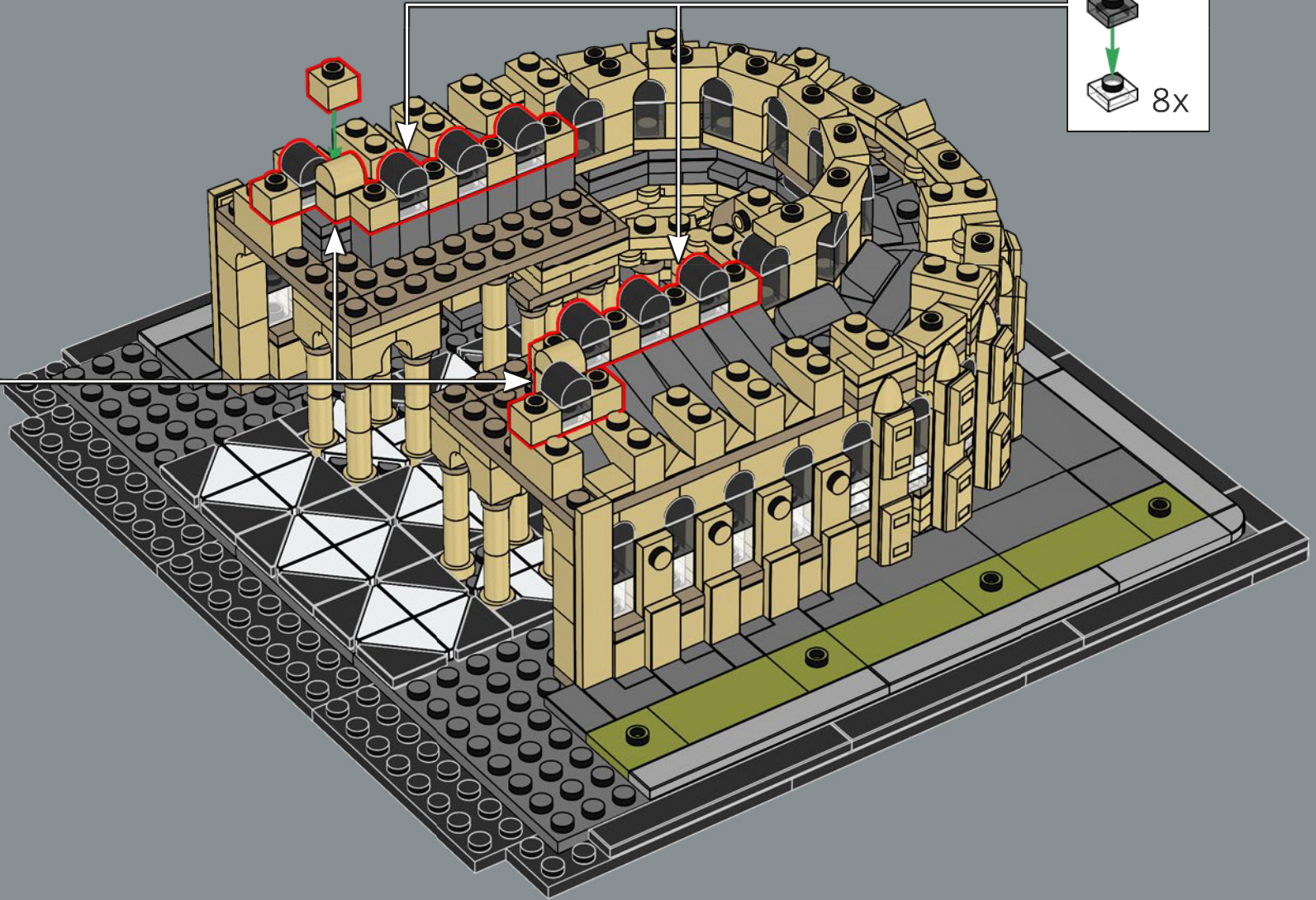
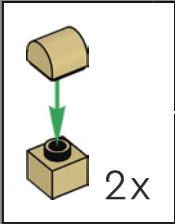
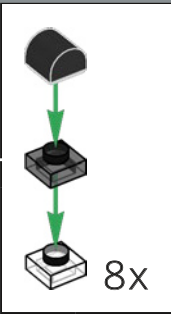

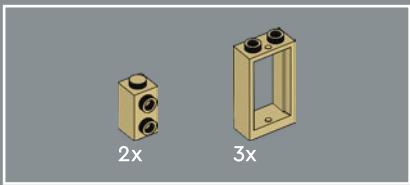

88

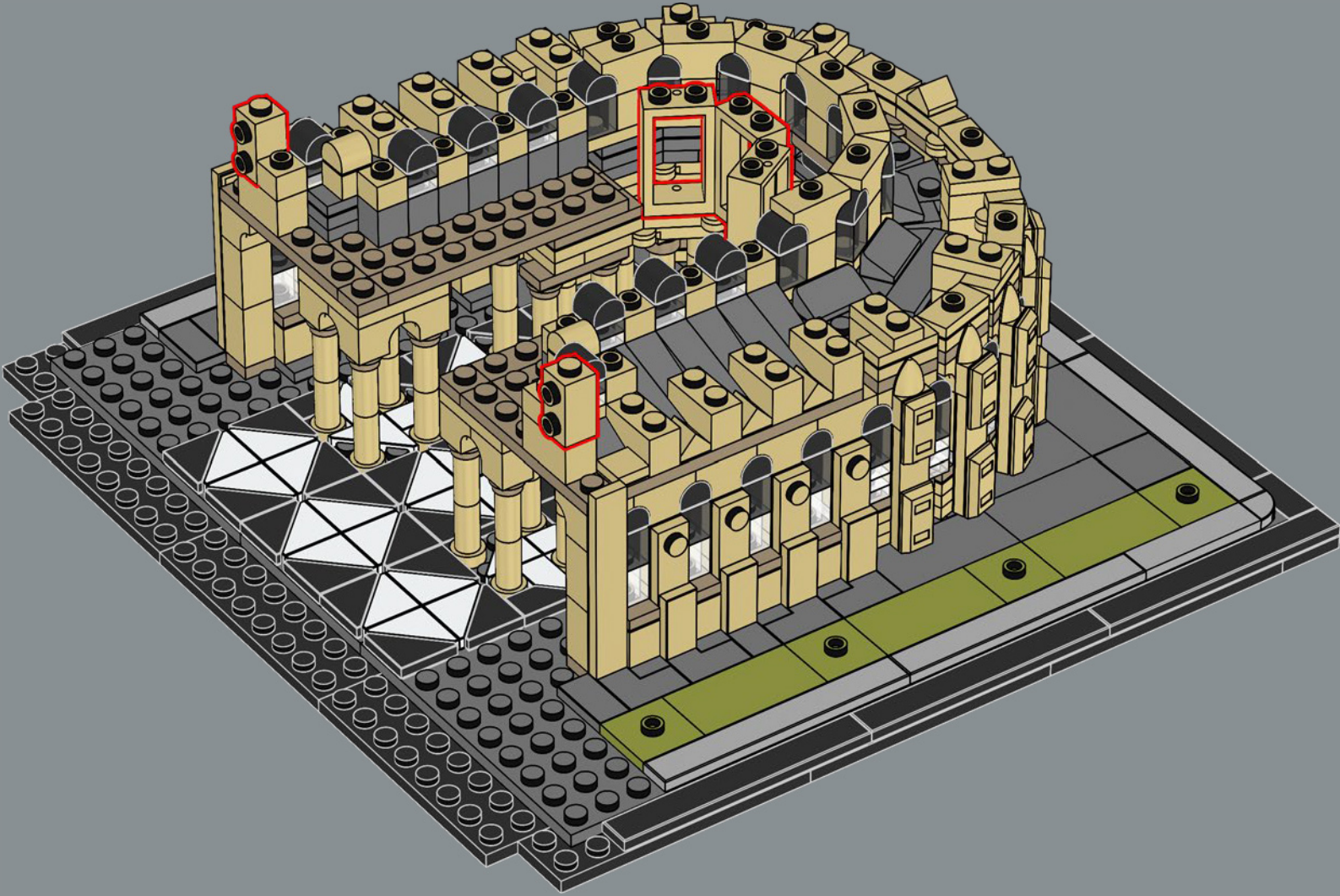

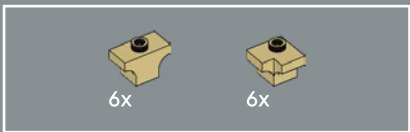

89

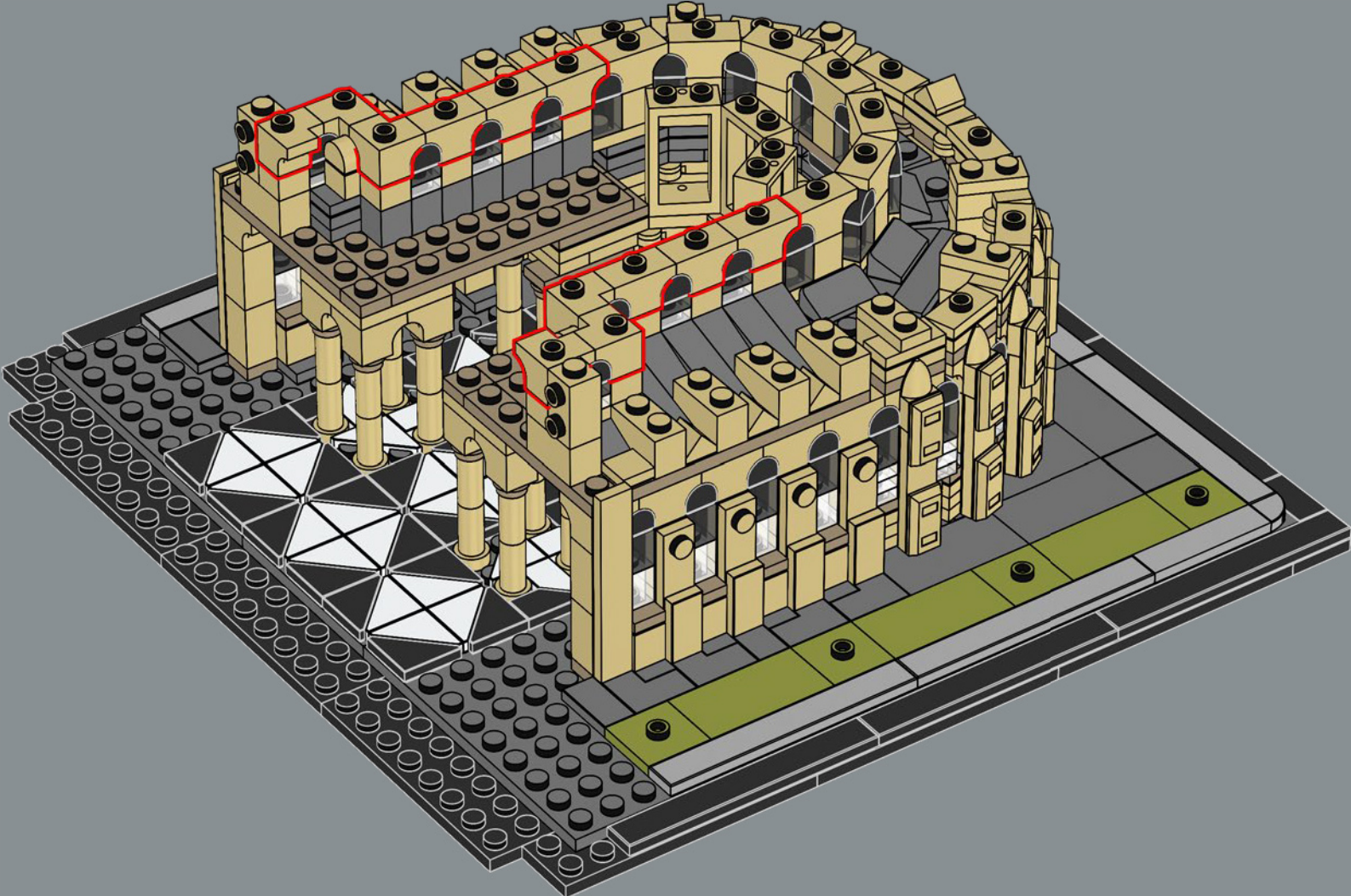

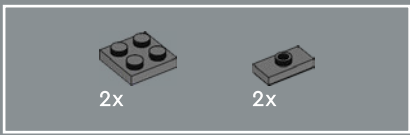

90

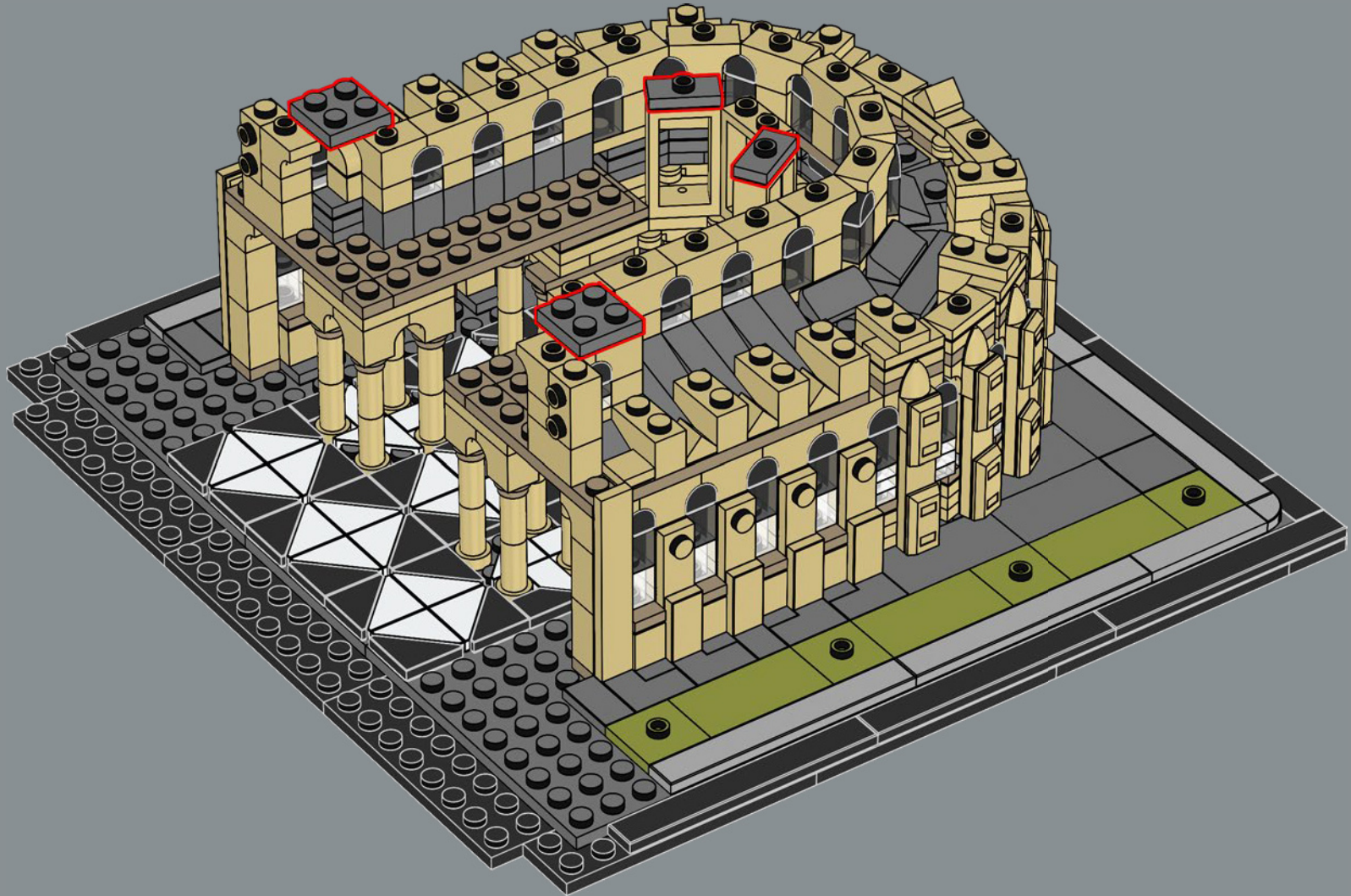



91

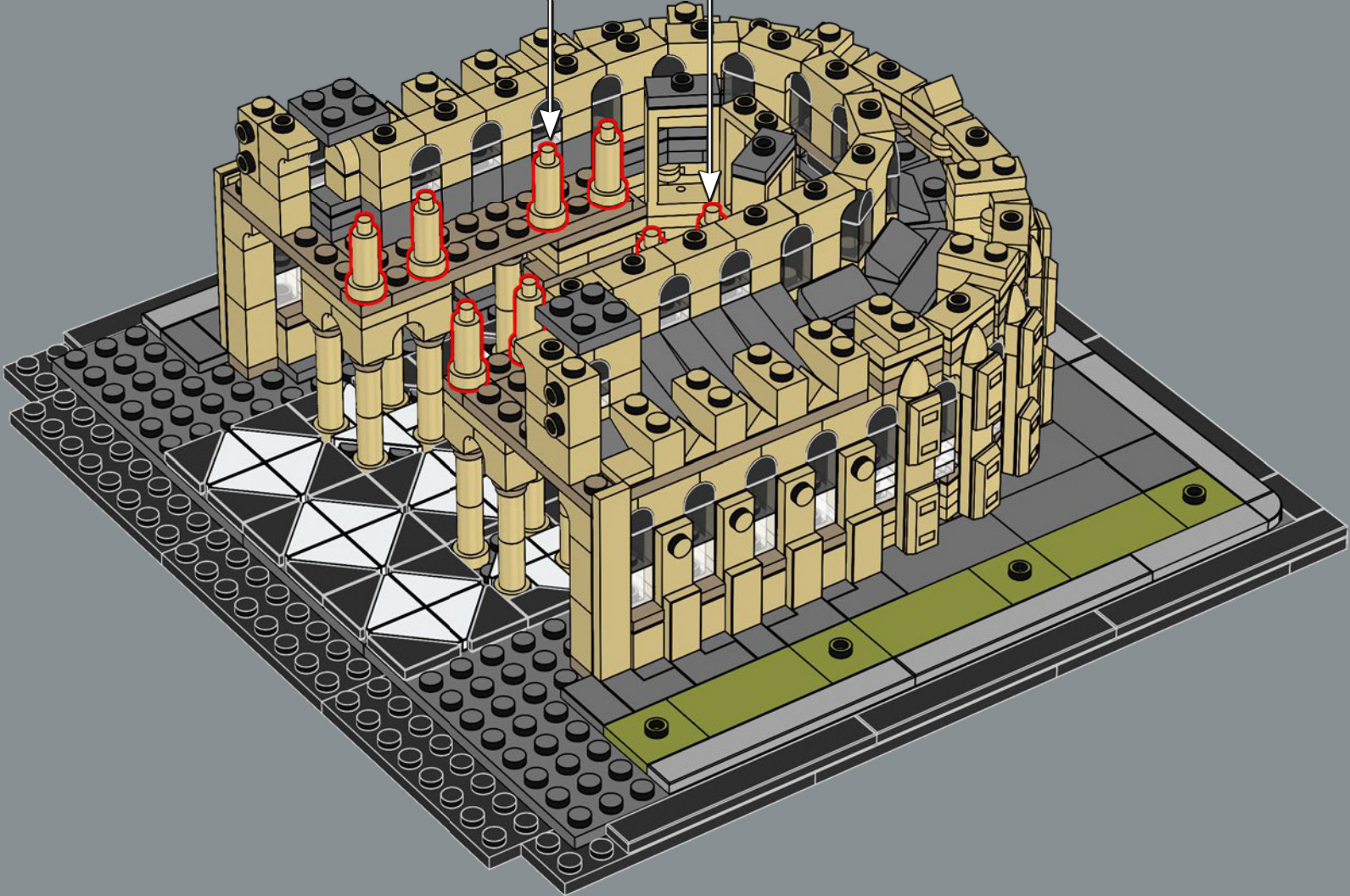
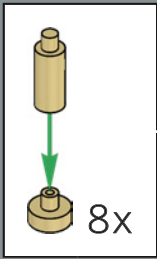

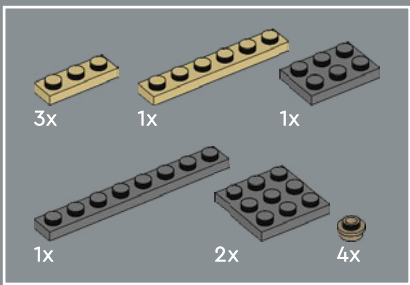

92

1

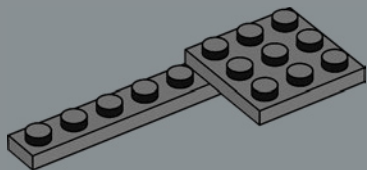

2

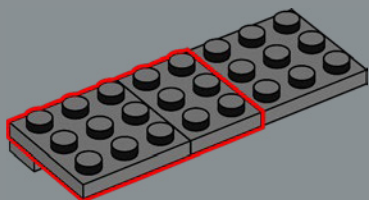

3

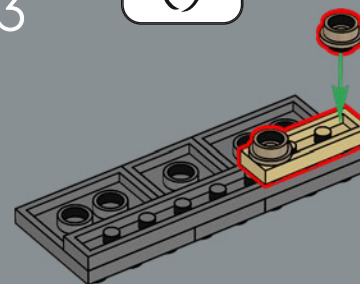

1

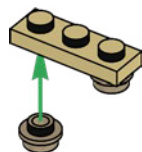

2

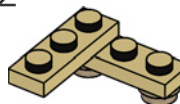

3

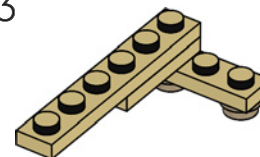

4

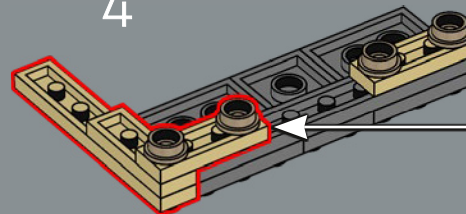

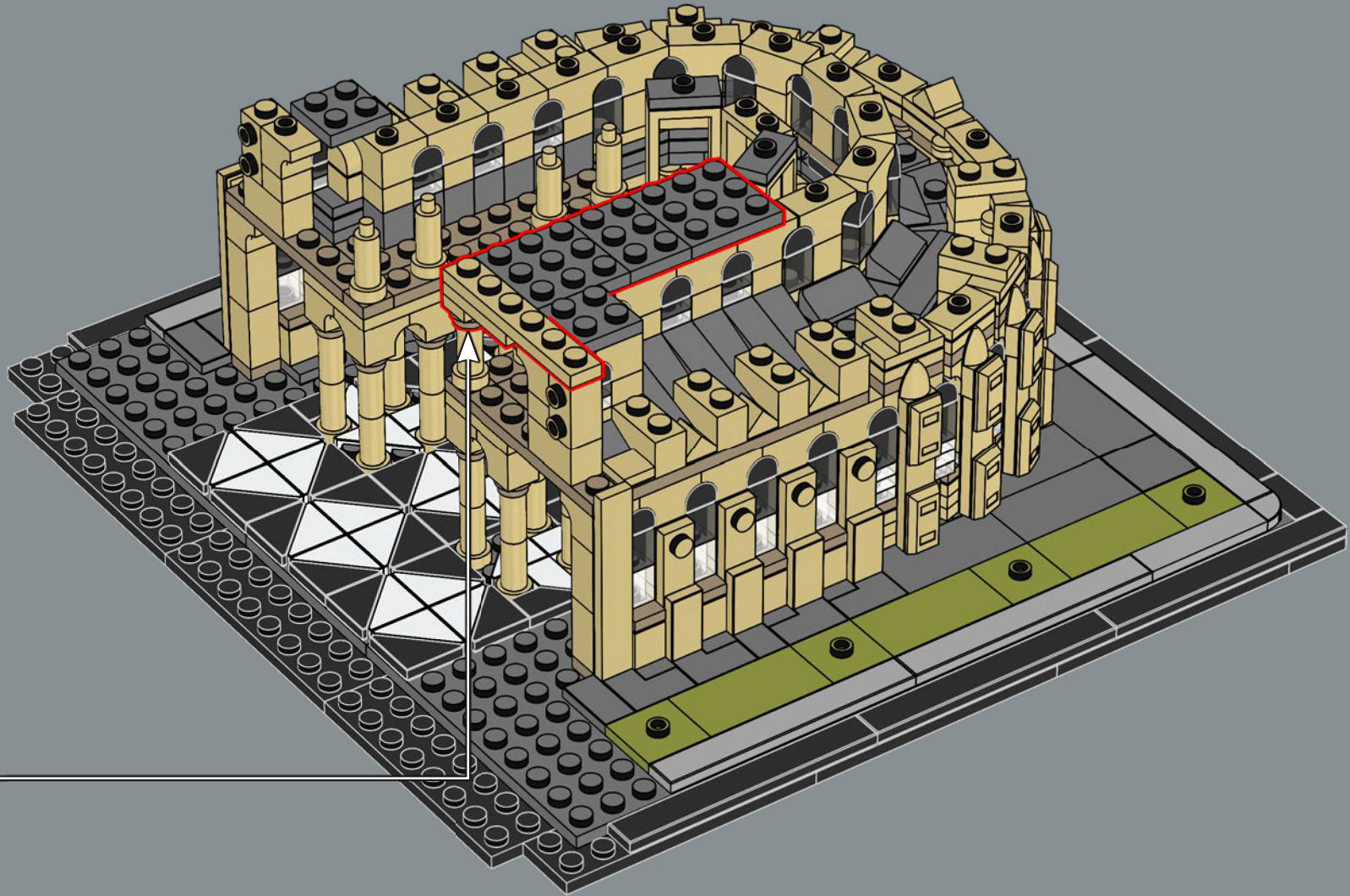

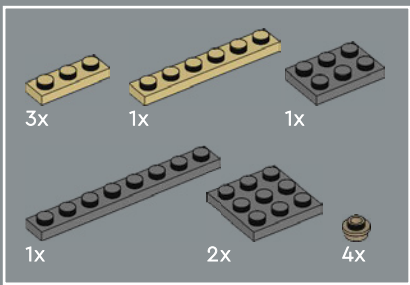

93

1

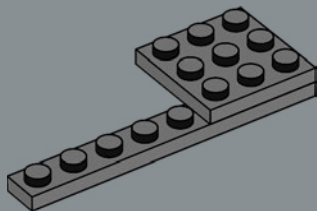

2

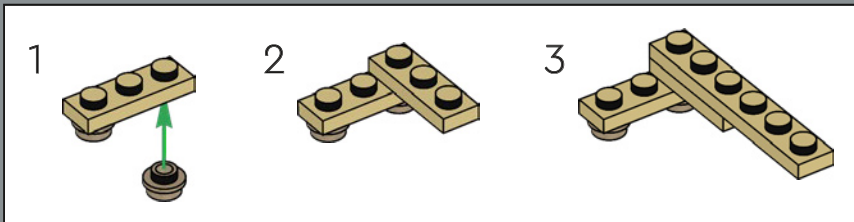
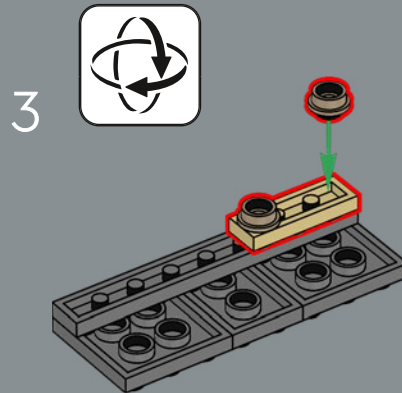
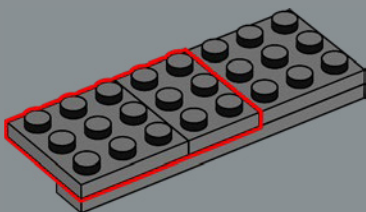

4

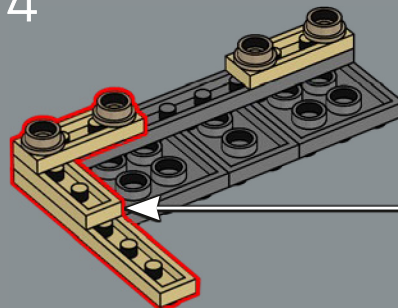

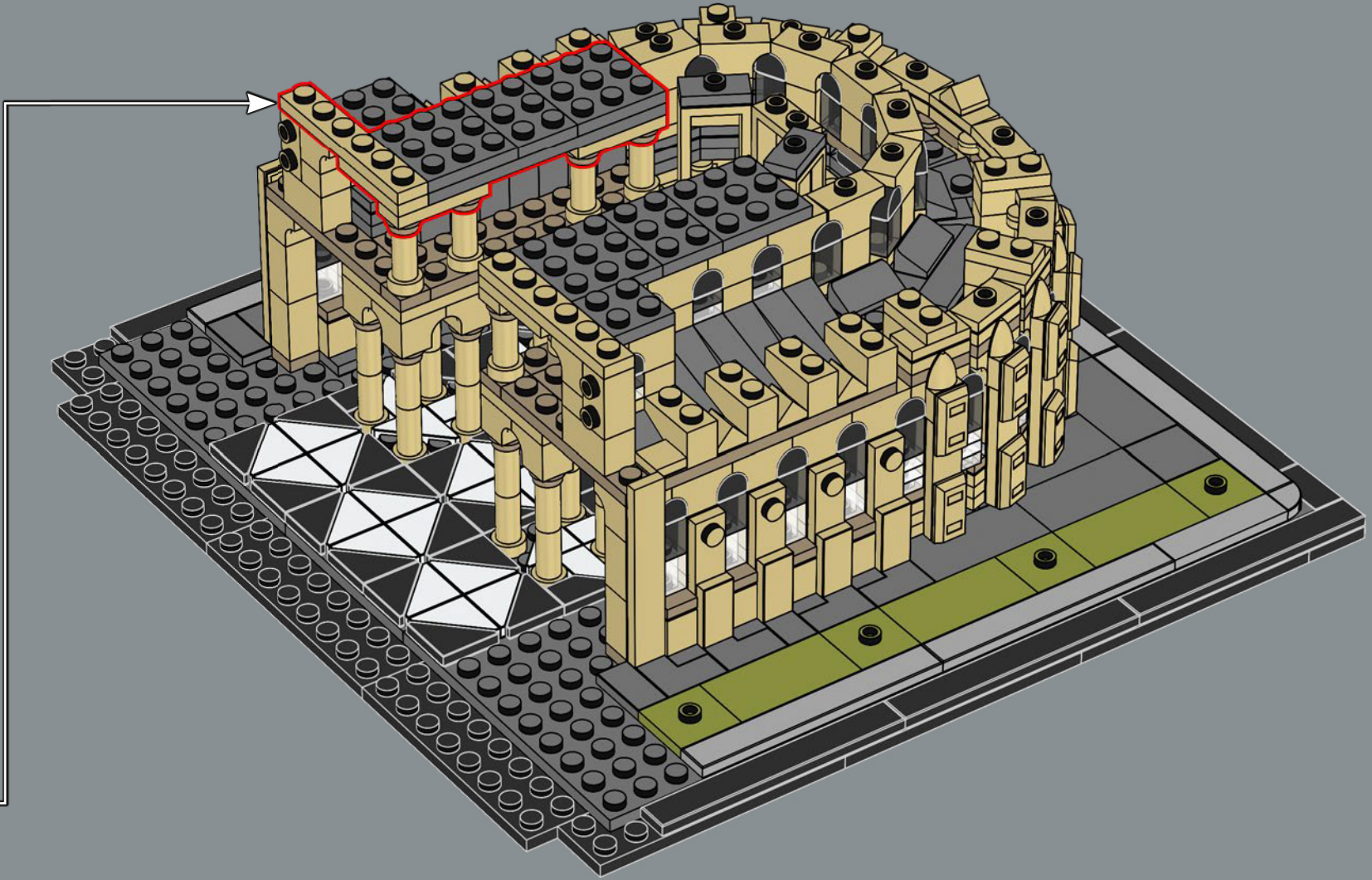



6x

94

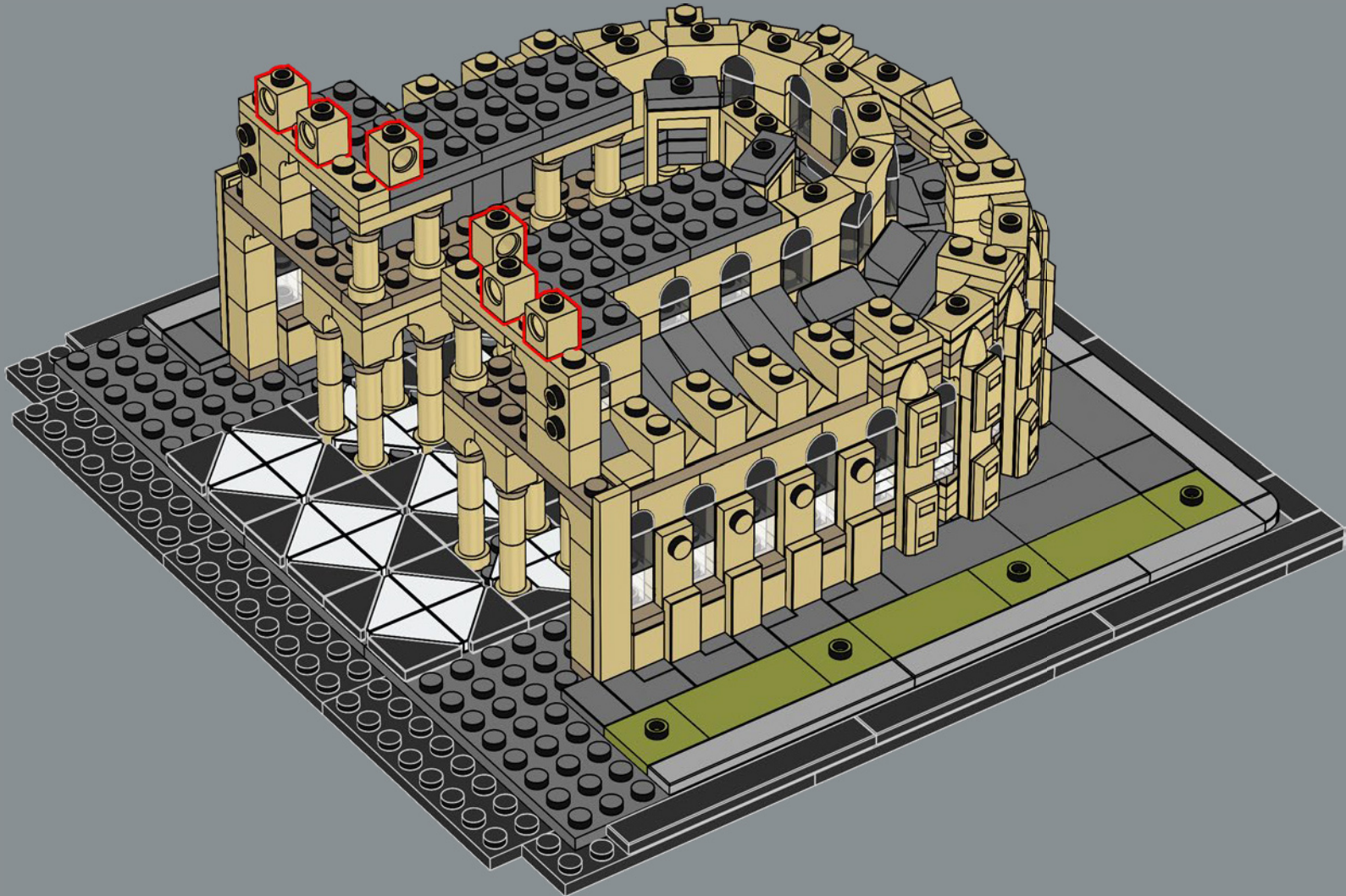

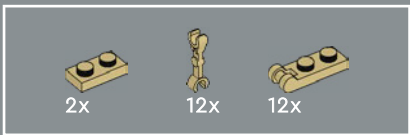

95

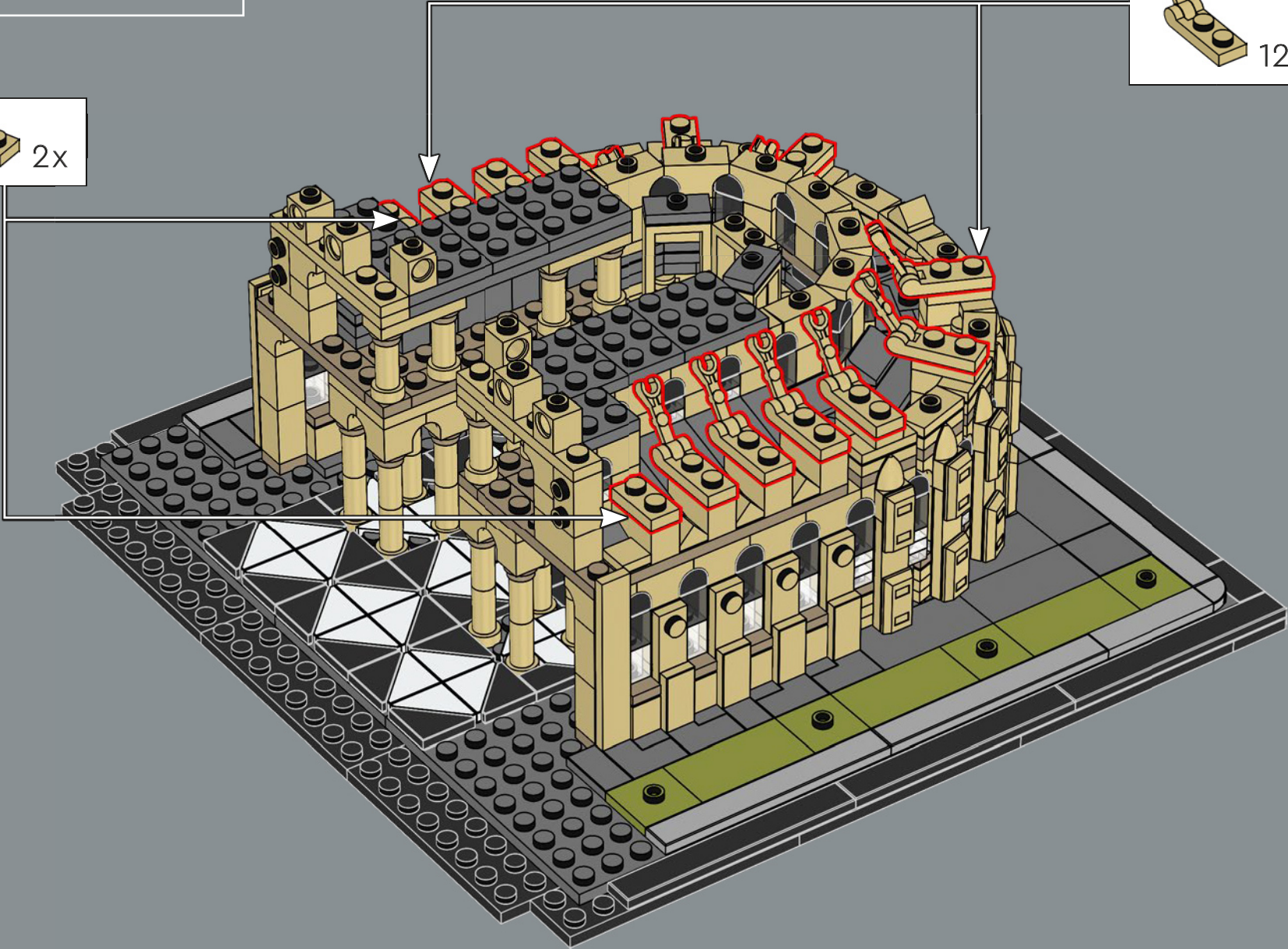
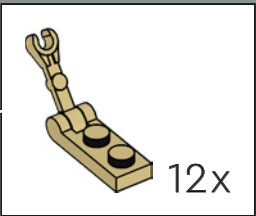
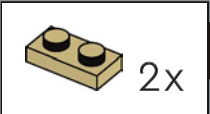

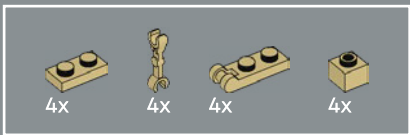

96

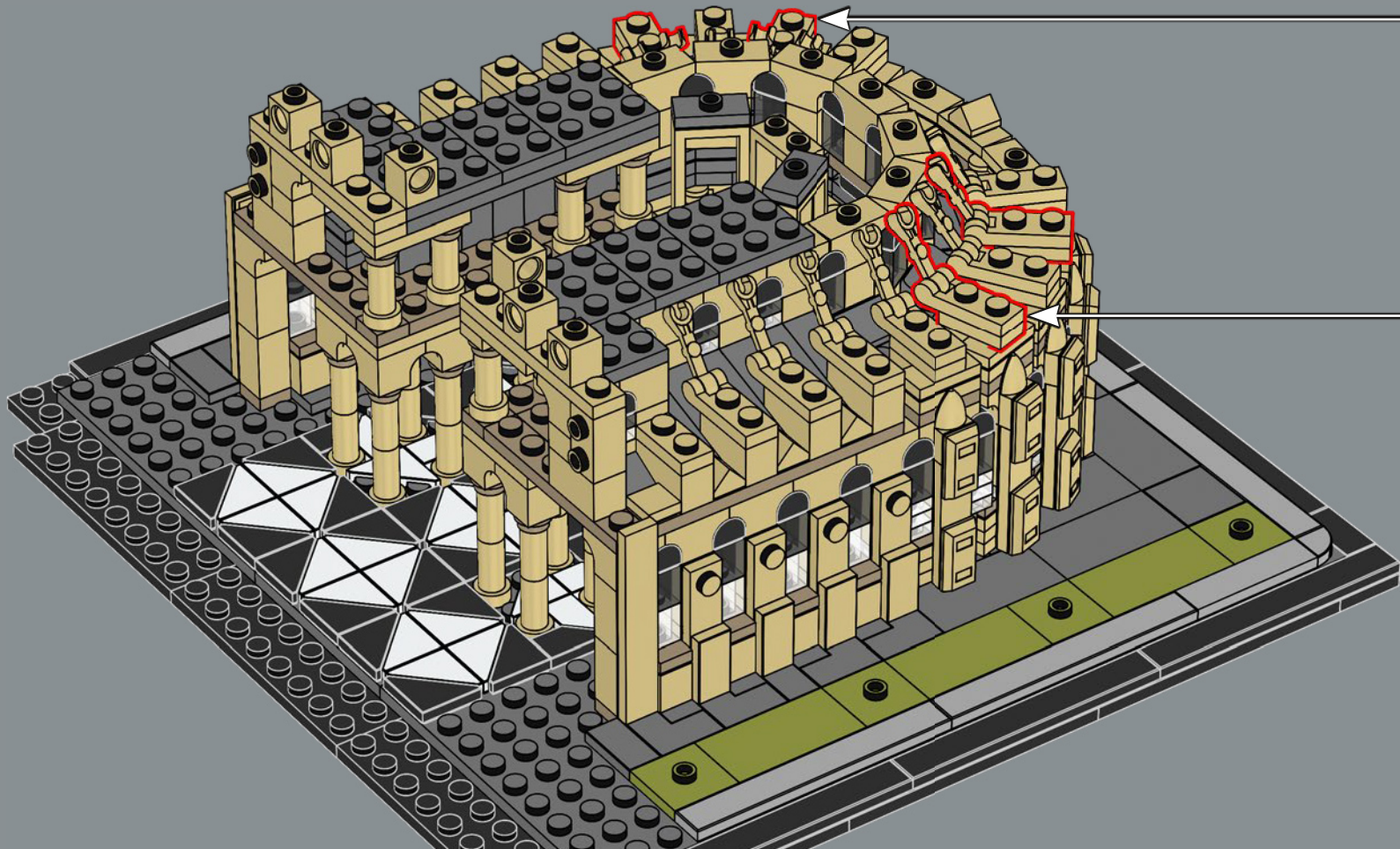
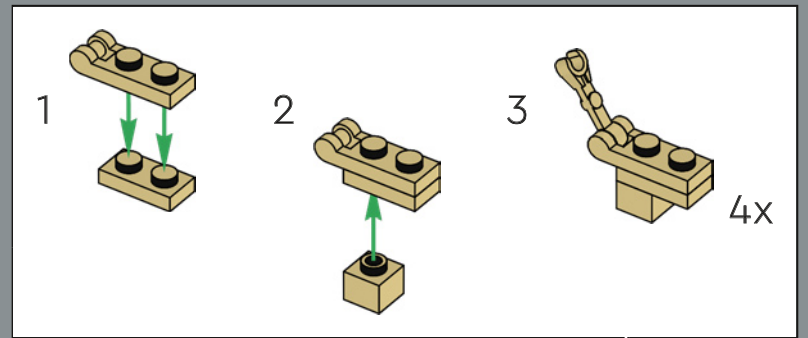

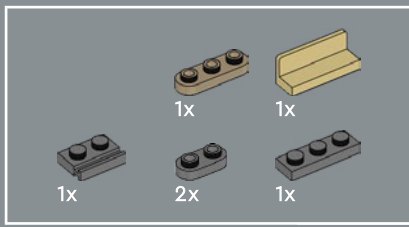

97

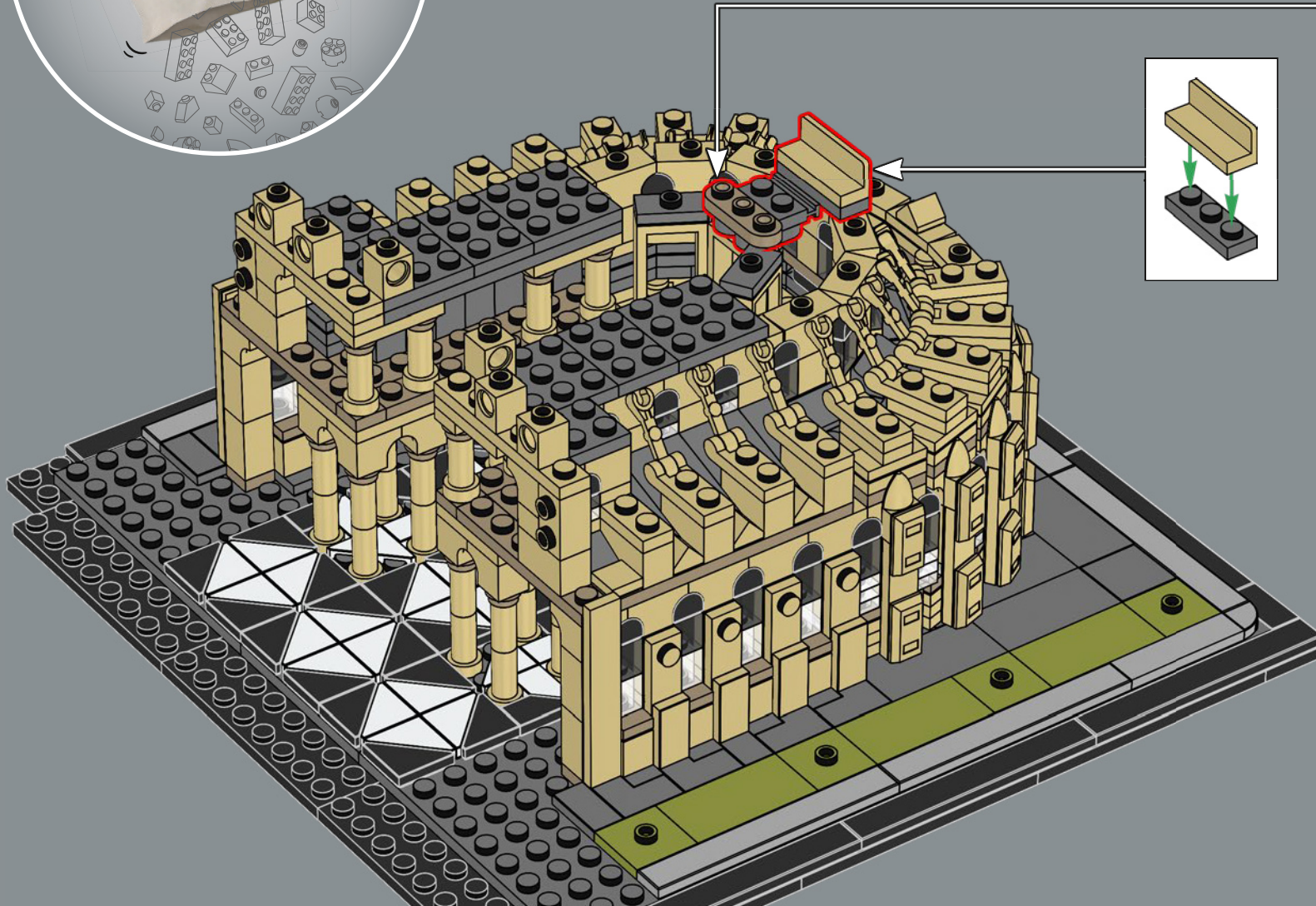
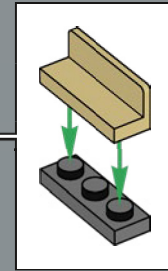
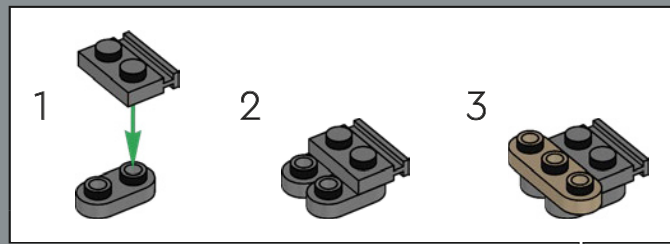



98

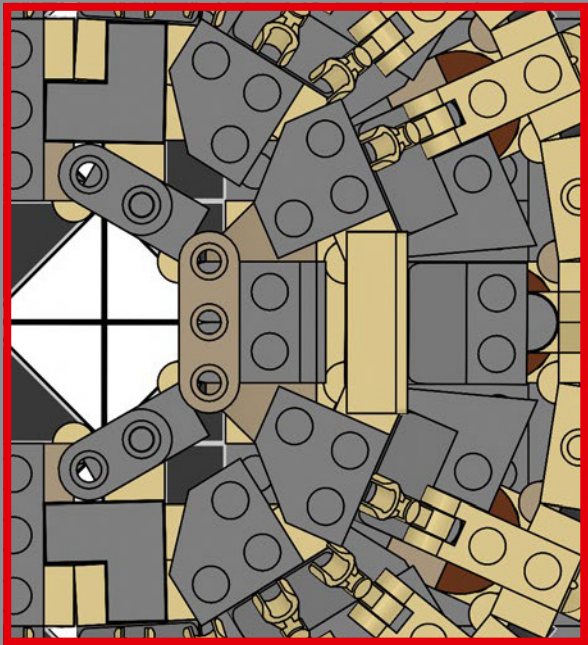
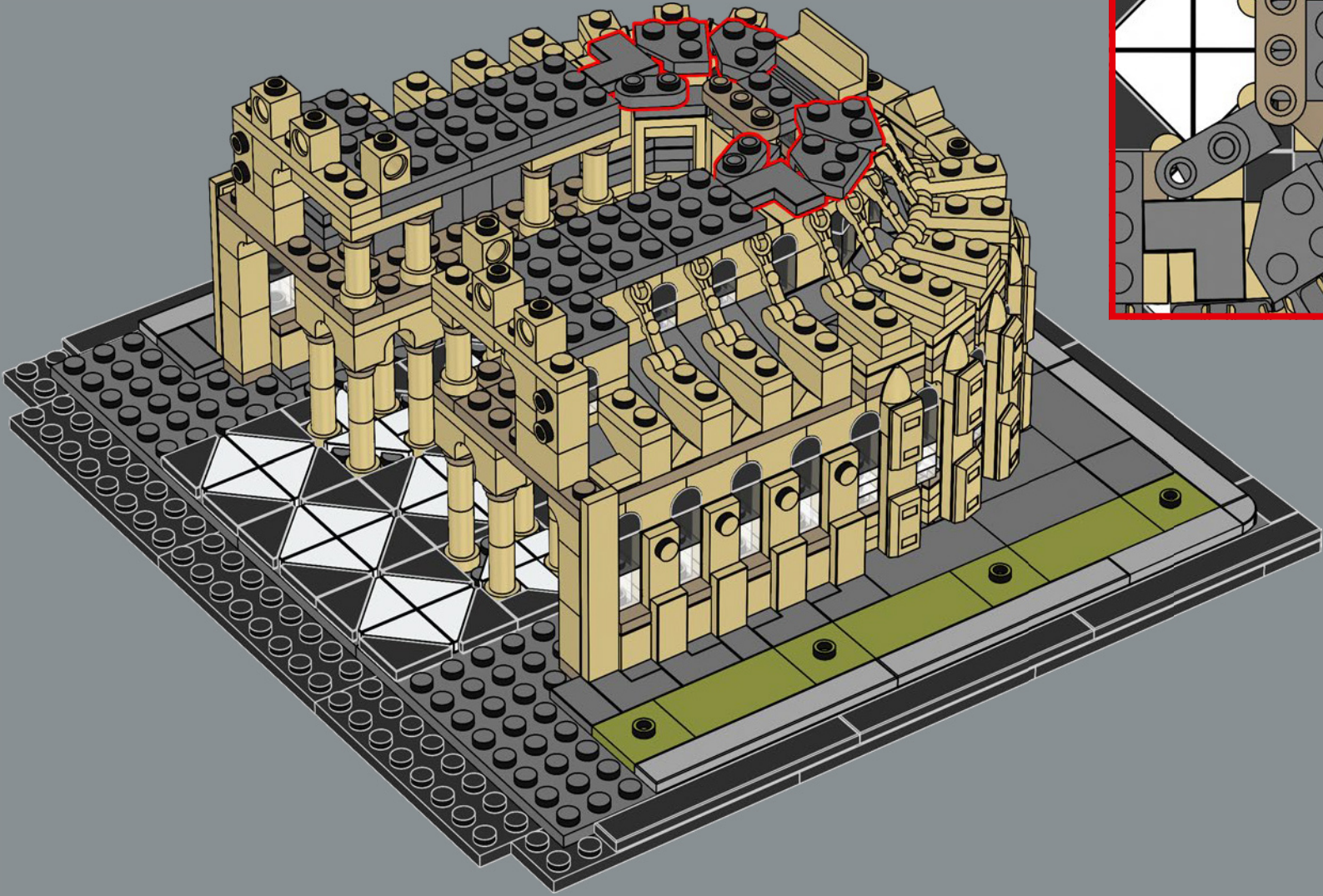



99

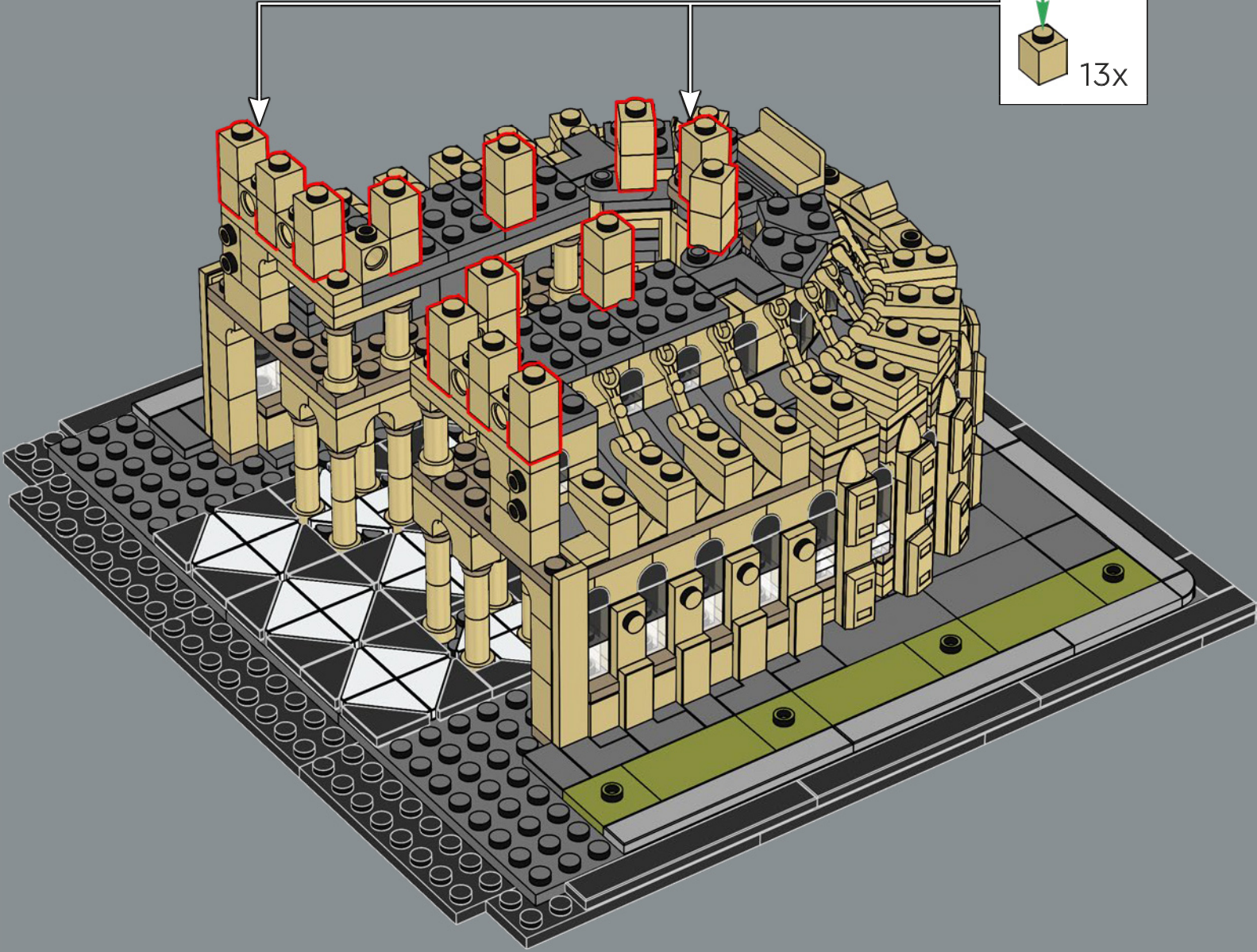
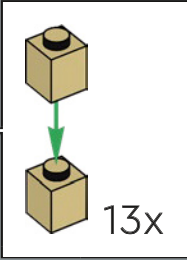

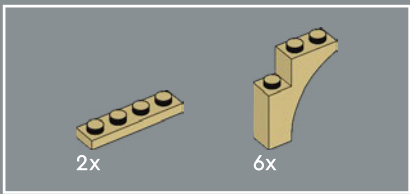

100

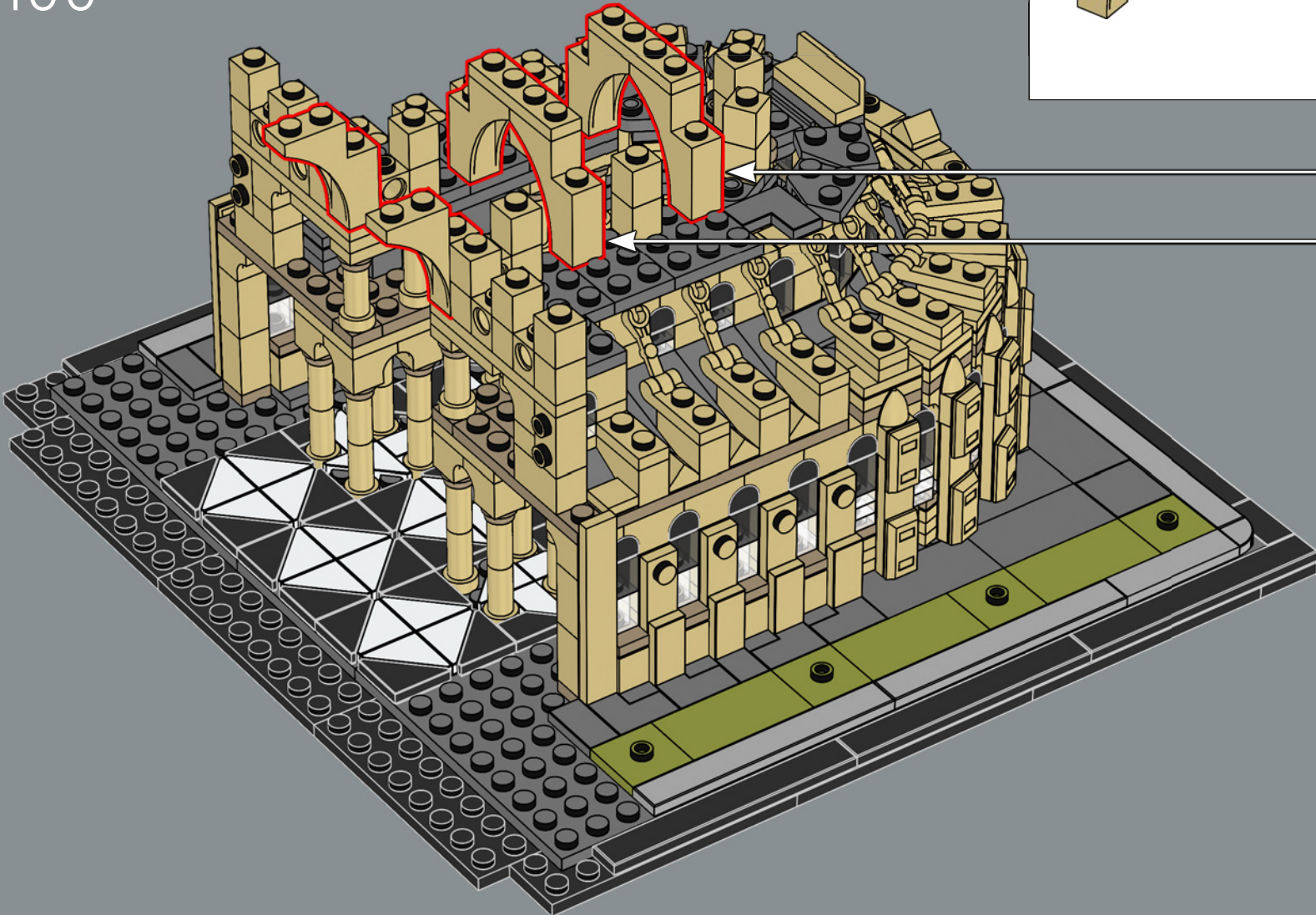
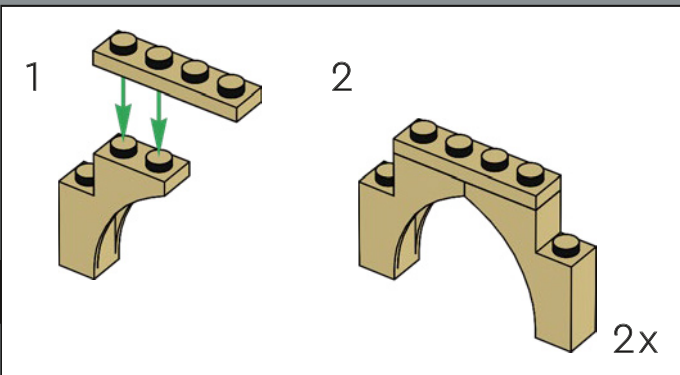

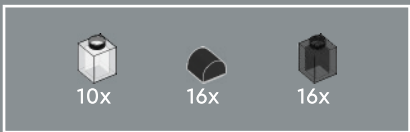

101

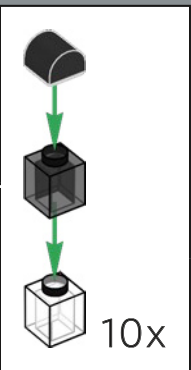
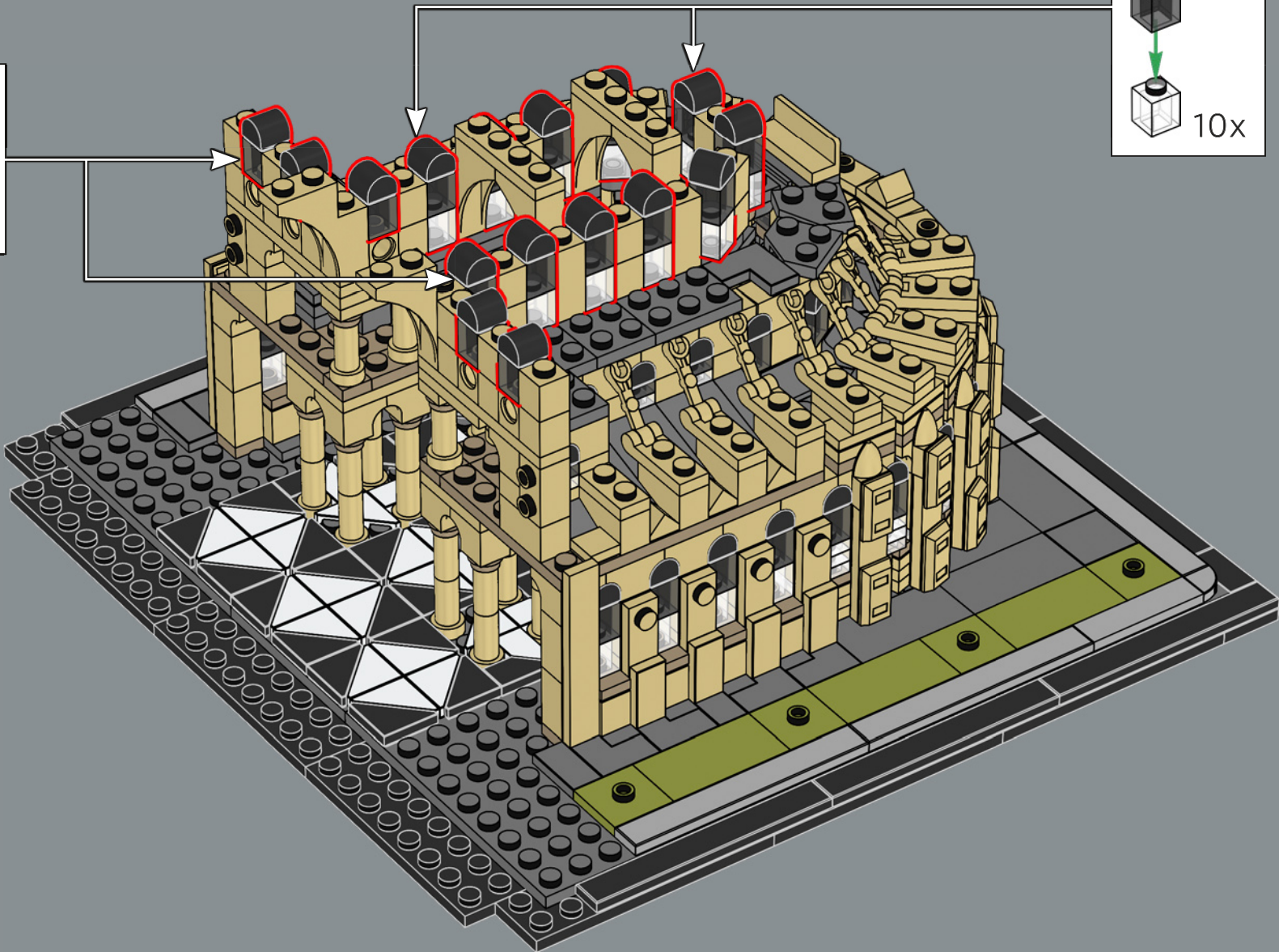
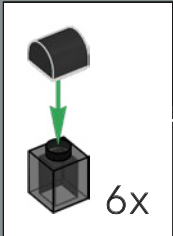

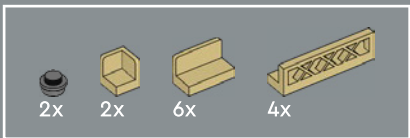

102

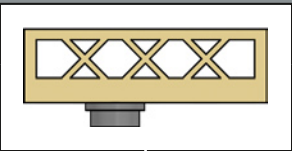
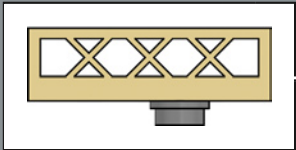
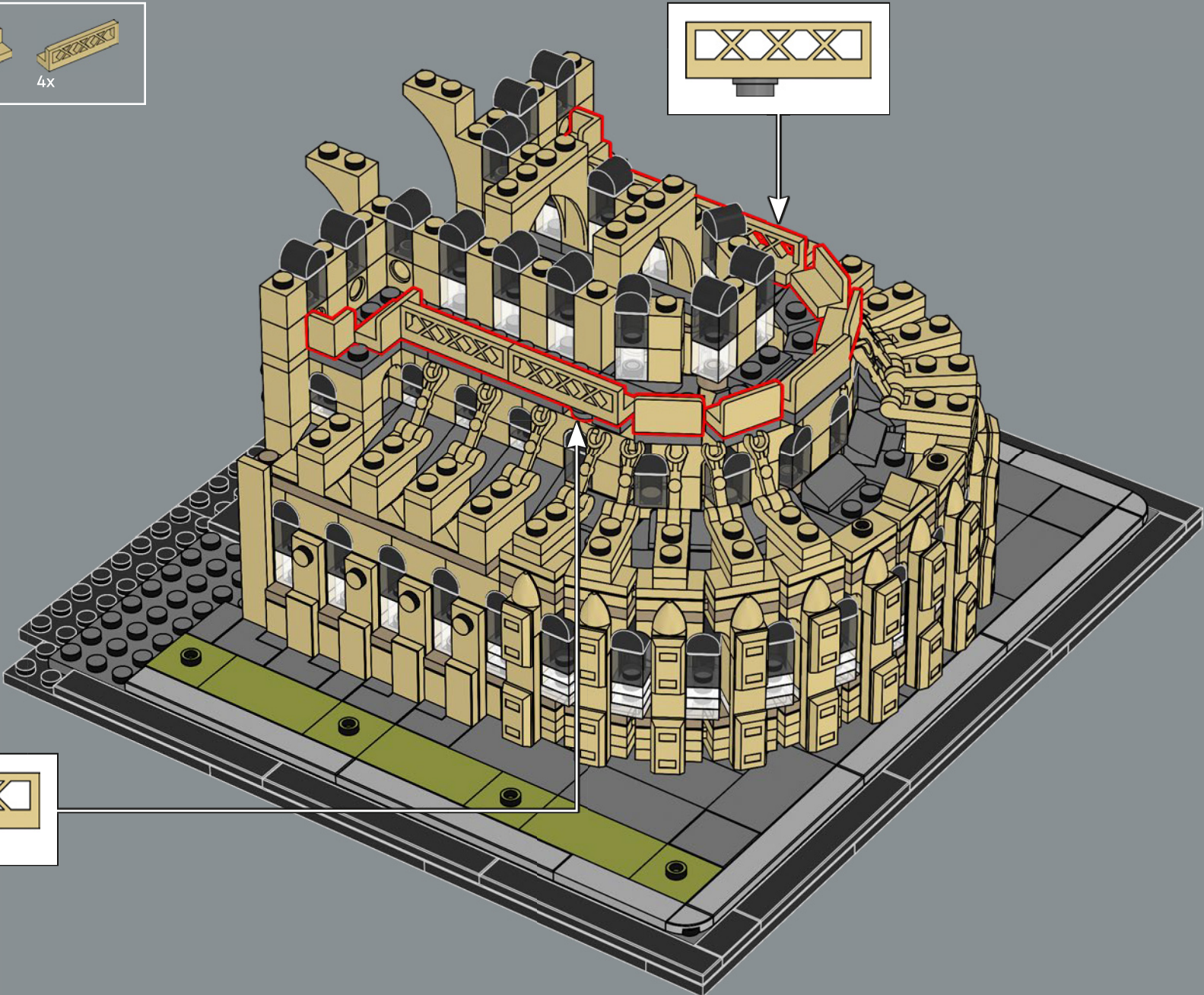

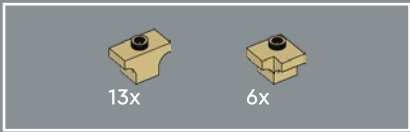

103

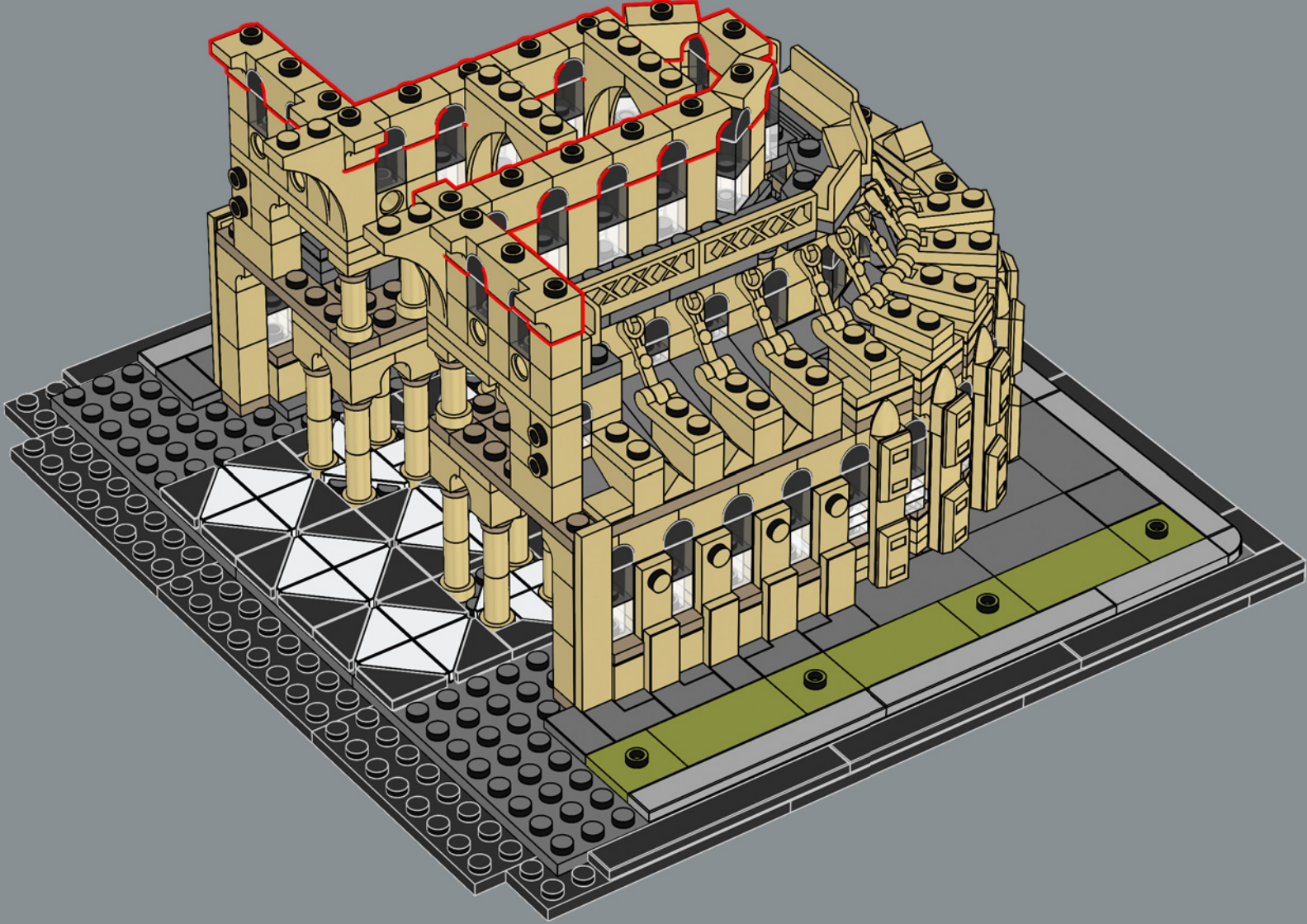

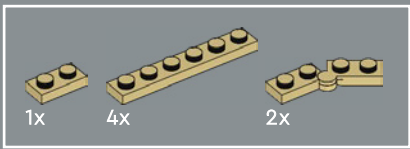

104

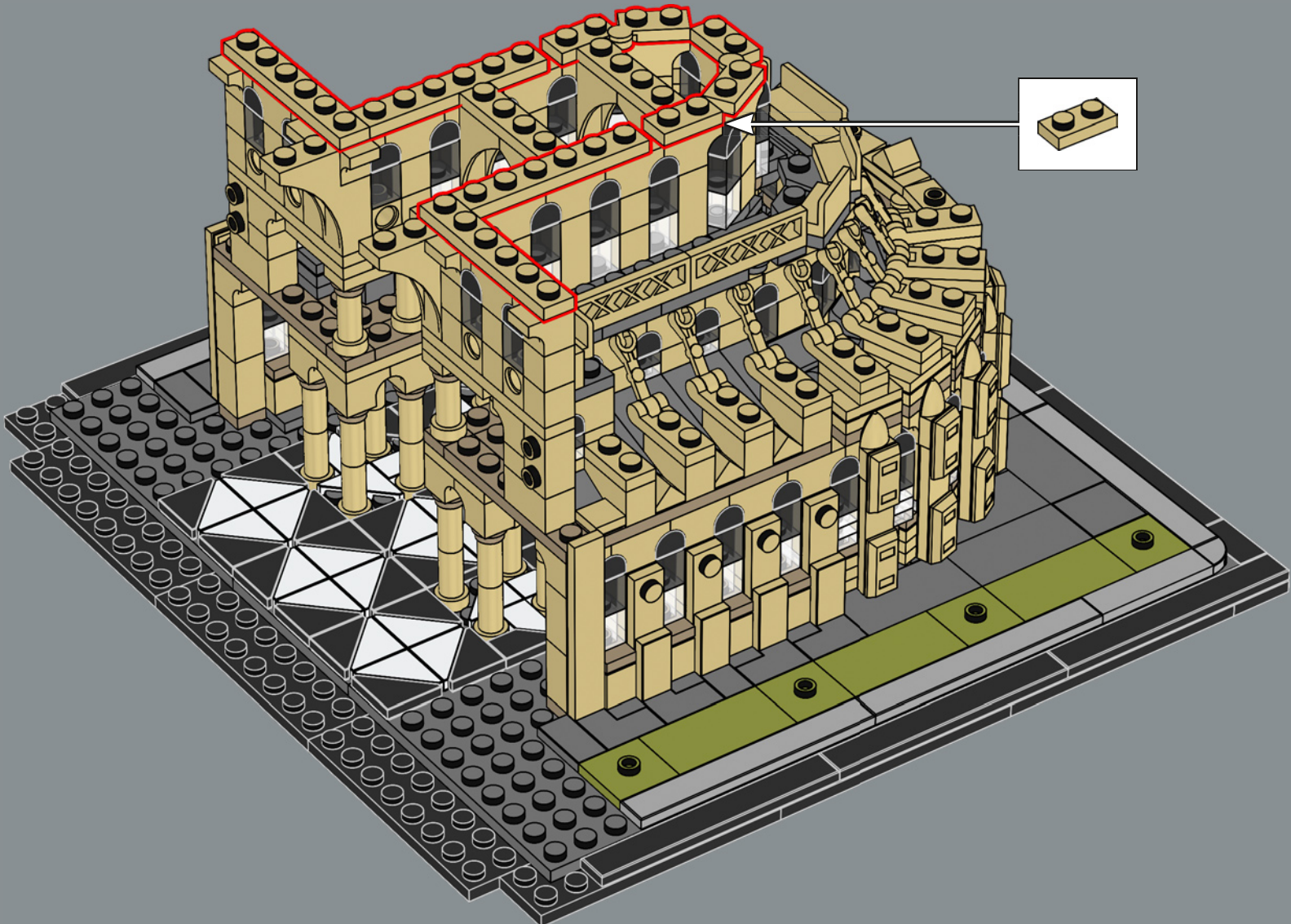

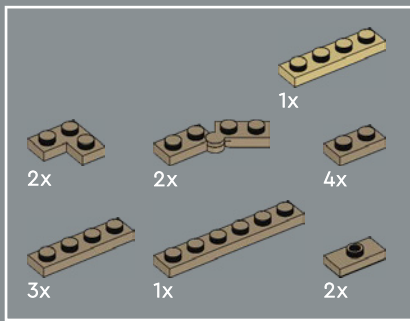

105

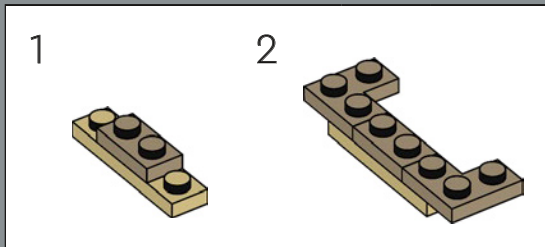
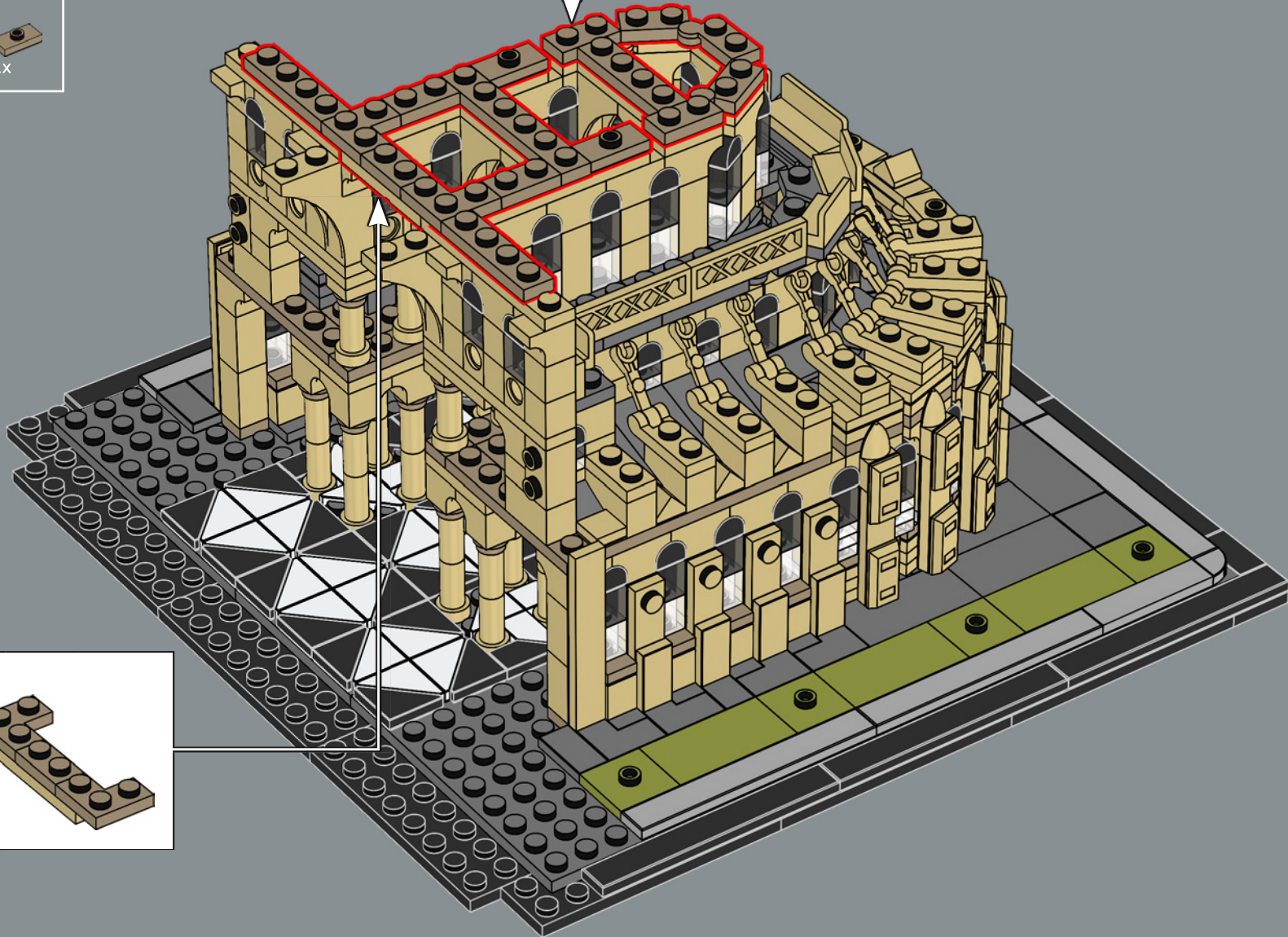
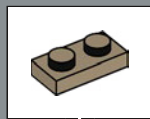

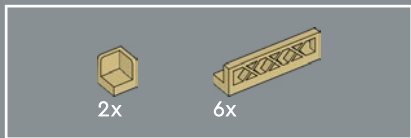

106

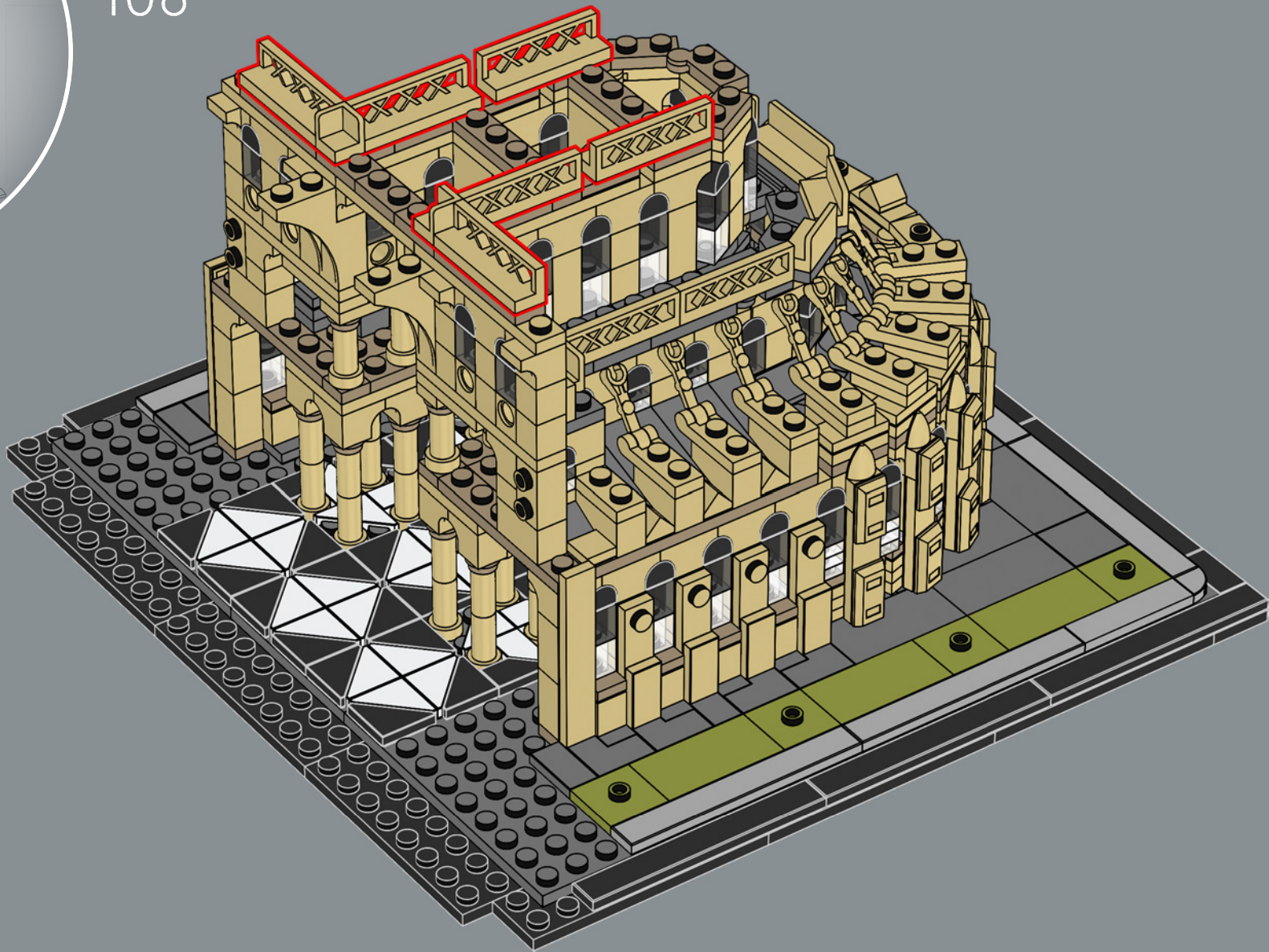

6x 10x

4x

6x

107

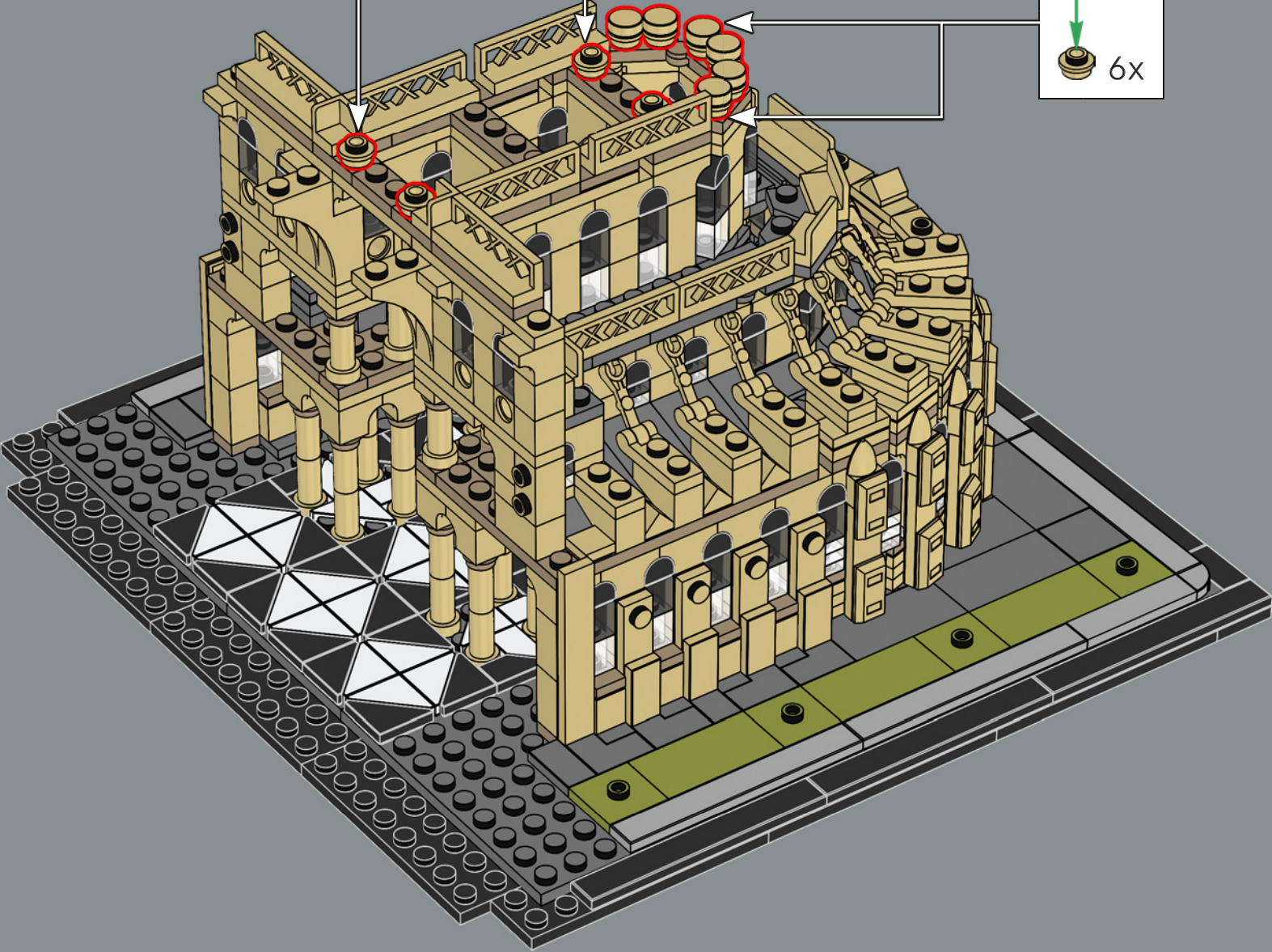

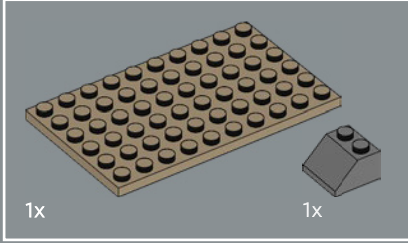
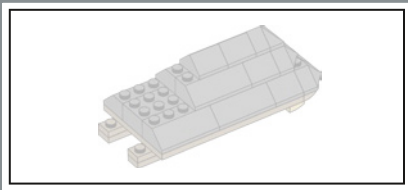

108

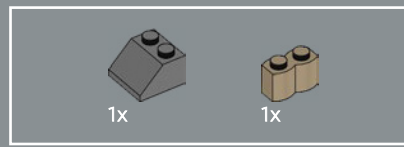
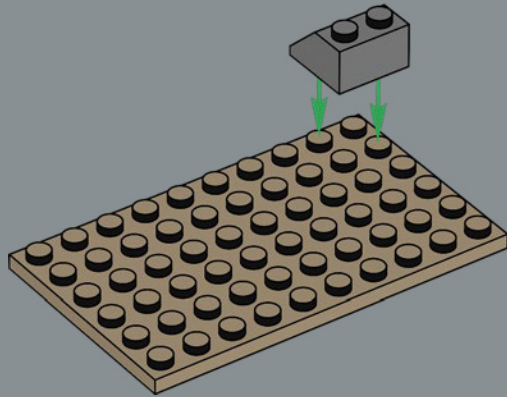

109

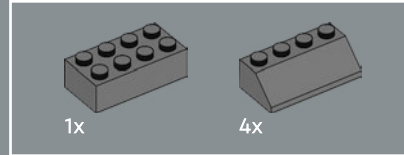
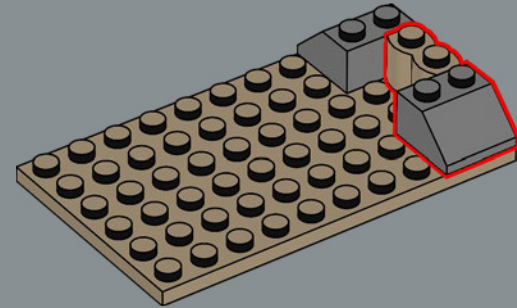

110

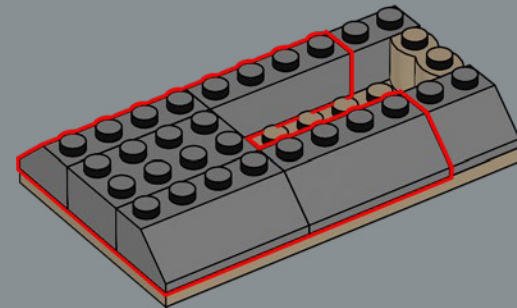

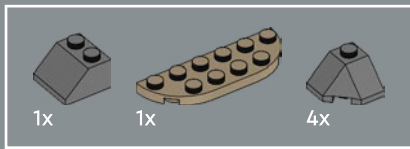

111

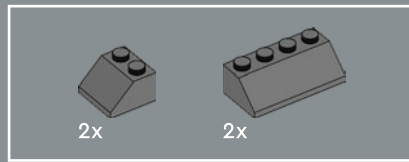
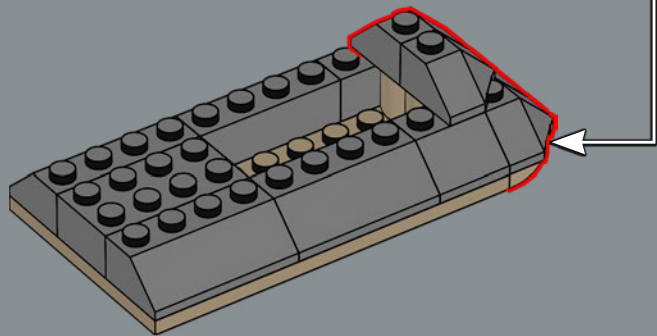

112

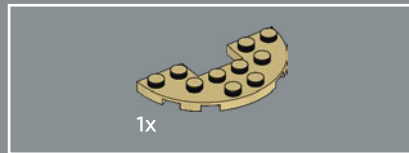
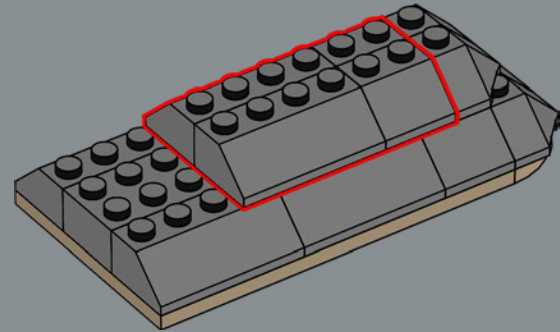

113

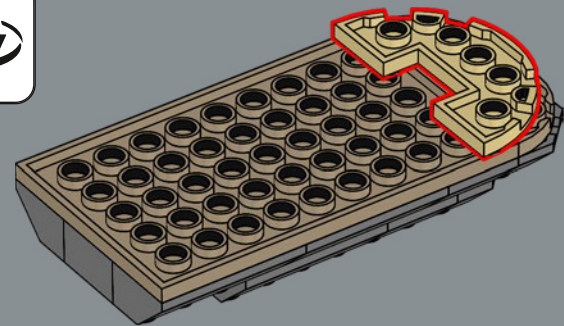

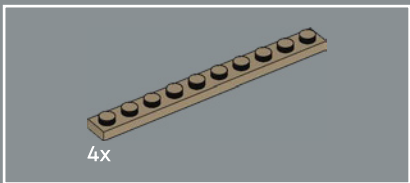

114

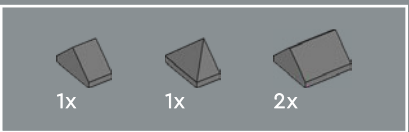
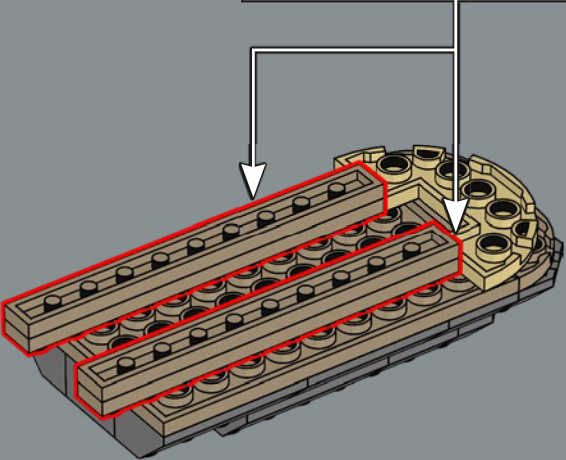
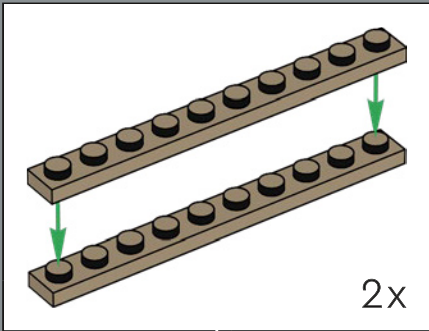

115

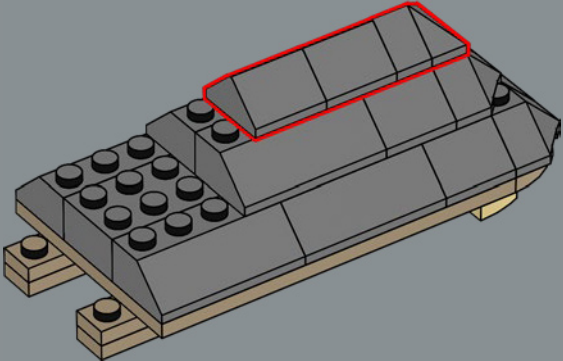

1177 - The choir and chevet are nearly complete, except for the high vaults. The roof and wooden framework are constructed prior to the vaults to offer protection from wear and tear.

116

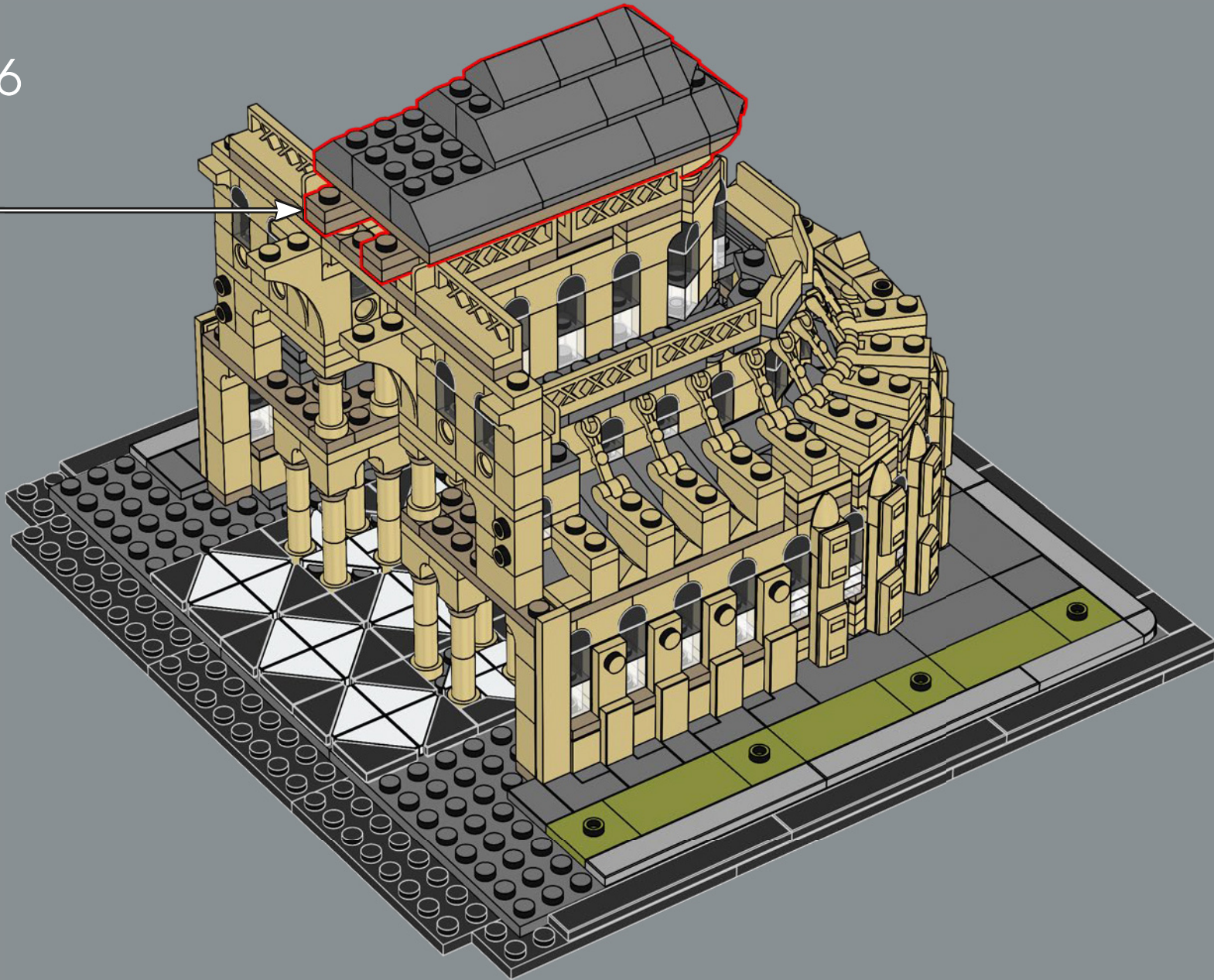

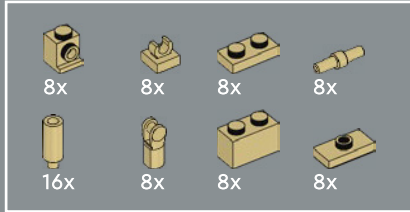
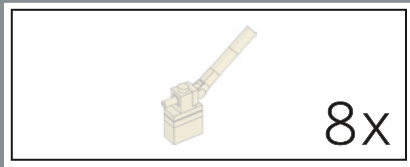

117

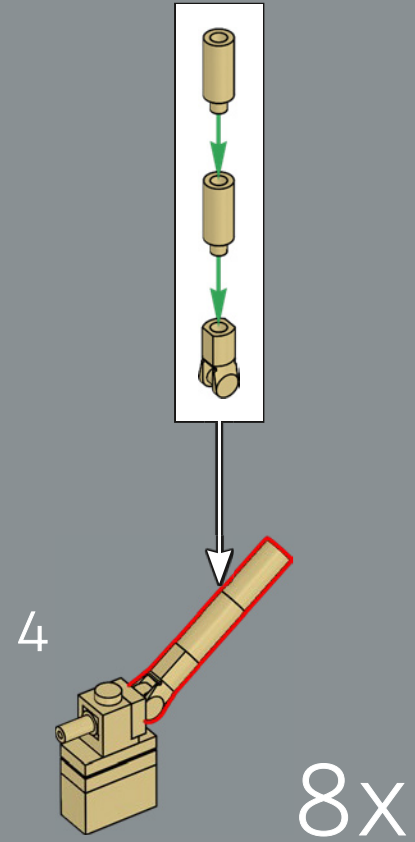
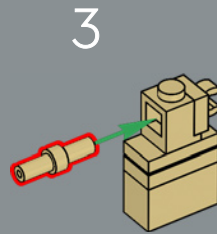
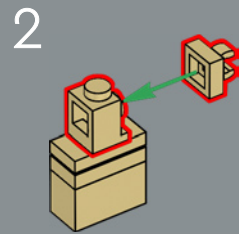
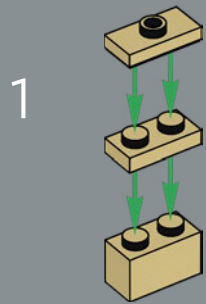

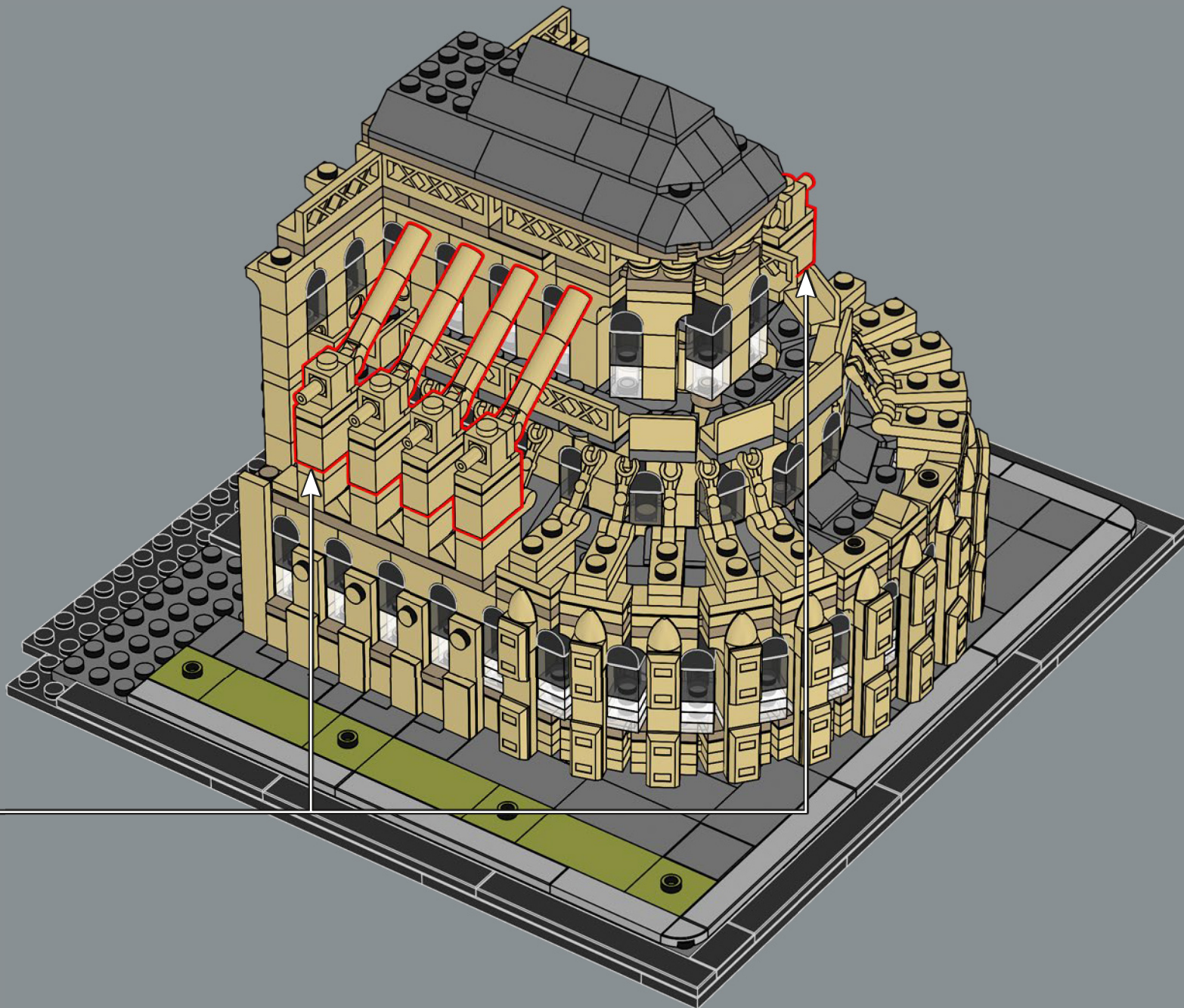

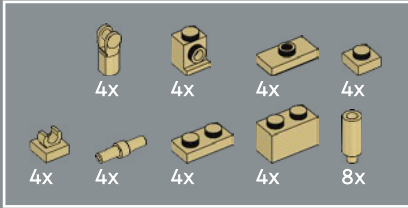
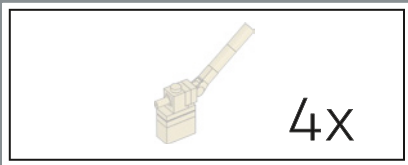

118

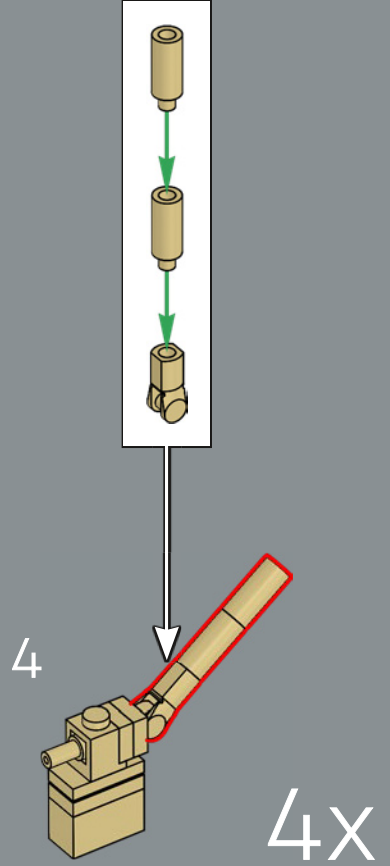
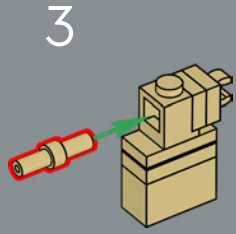
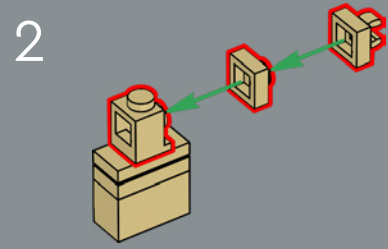
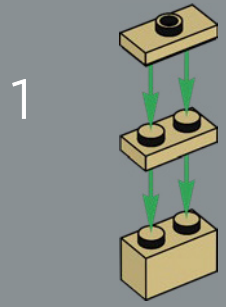

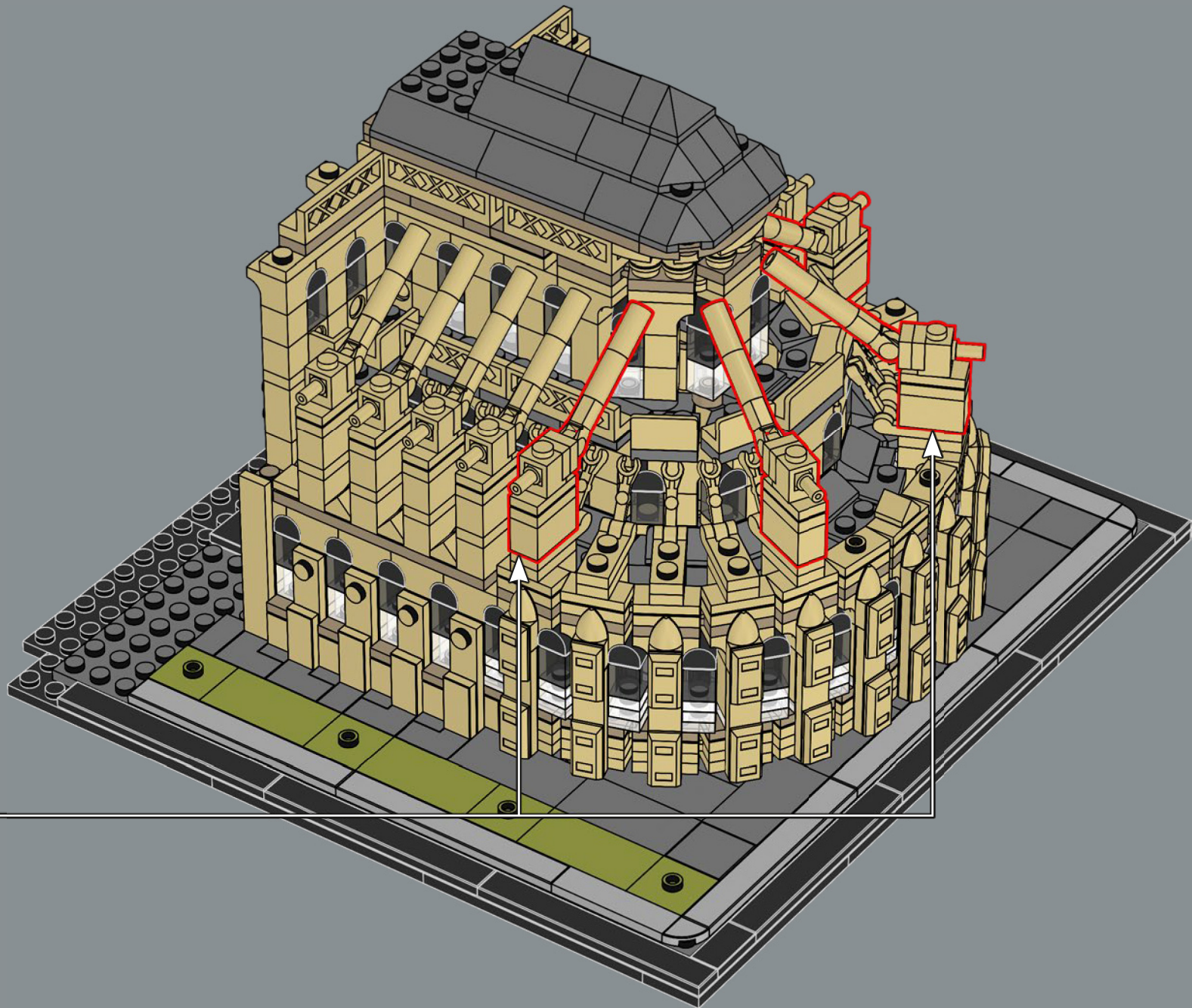

The Notre-Dame Cathedral is the first to fully integrate the flying buttresses that are hallmarks of Gothic architecture.

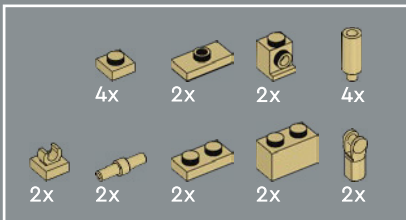
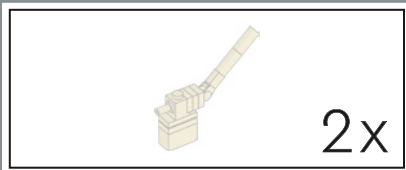

119

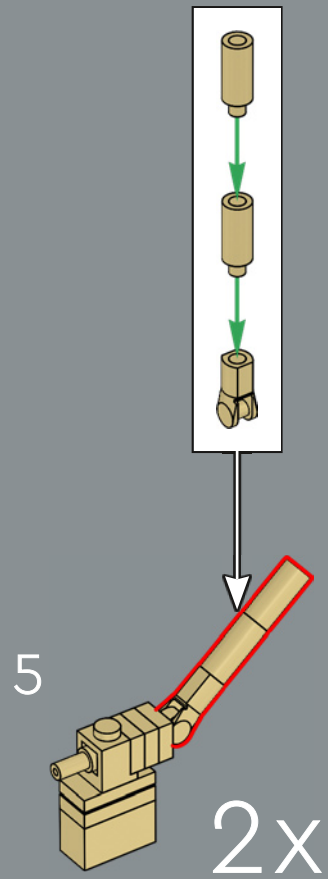
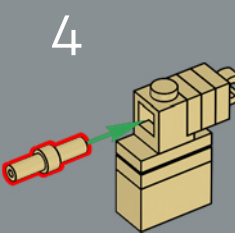
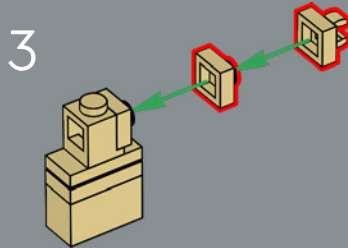
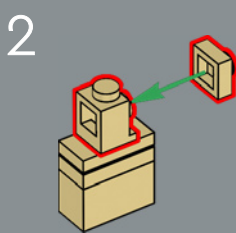
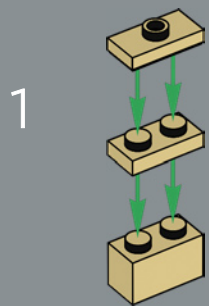

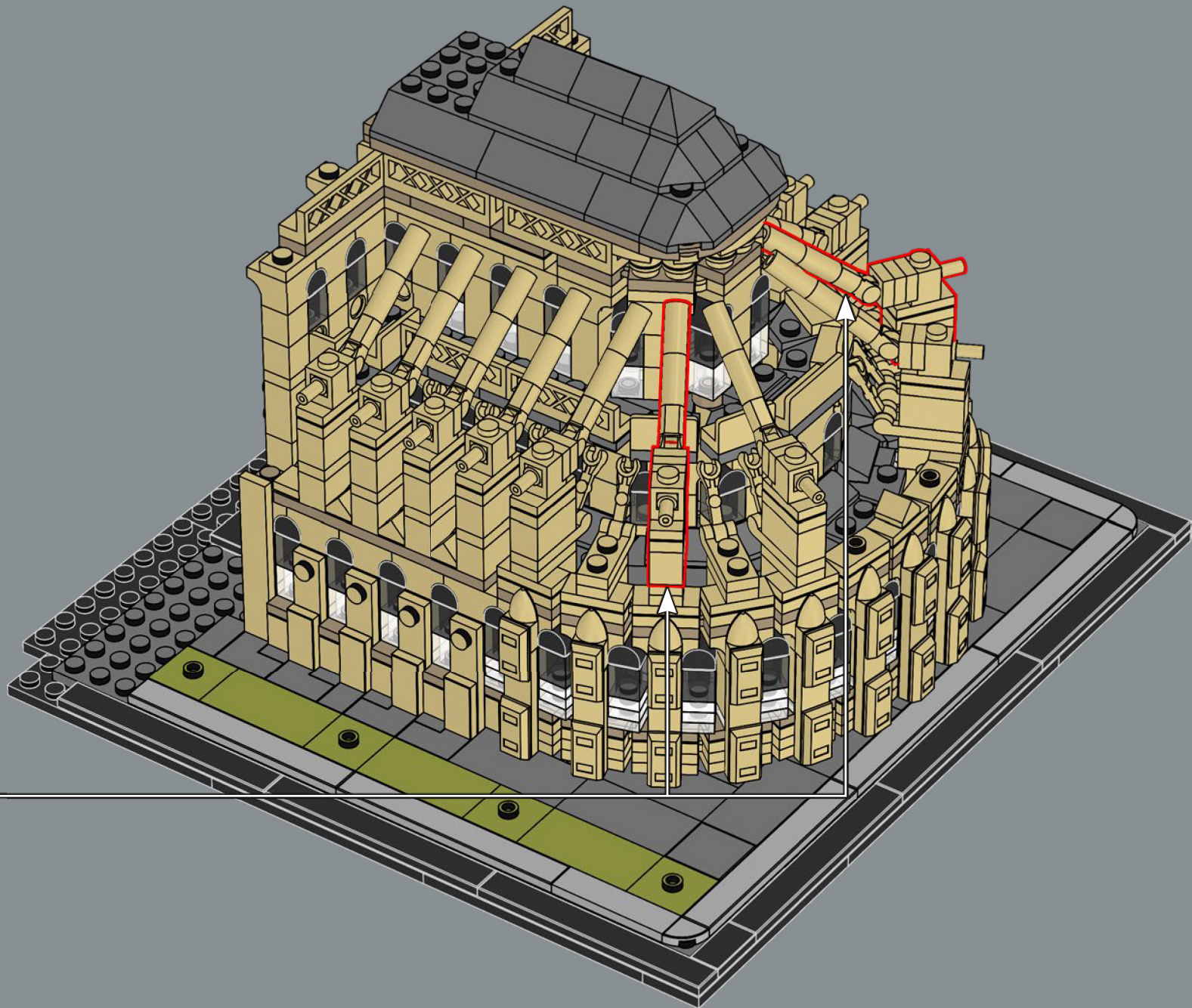

A LEGO® LANDMARK TAKES SHAPE

1182-1200

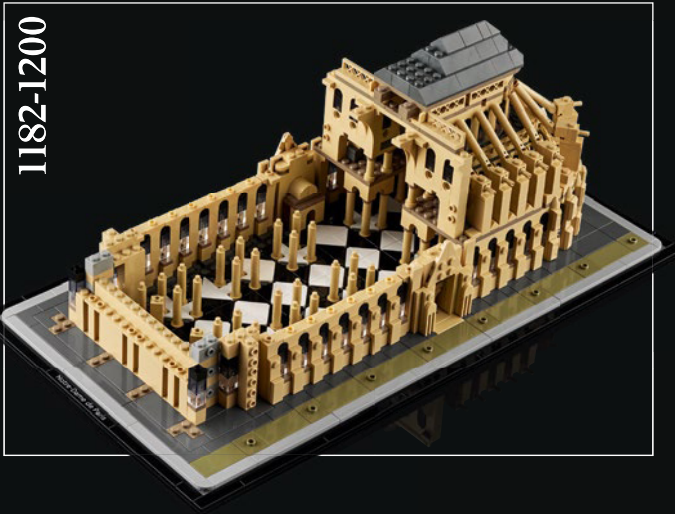

*Construction work continues in the transept and
in the bays on the south side of the nave.*

✚ At 128 m (419.9 ft.) long, 48 m (157.4 ft.) wide and 69 m (226.3 ft.) tall, the Notre-Dame Cathedral was built on the site of an existing cathedral on Île de la Cité in the Seine. While the first completed eastern section functioned as an interim church, construction work continued on the transept and in the first bays on the south side of the nave. From the original Romanesque architectural style, the construction gradually incorporated contemporary architectural styles, evolving into the Gothic style it represents today. This model stays faithful to the construction of both the structure within and the external architectural details – with certain features scaled down – to recreate the awe-inspiring view that has met visitors through the centuries.

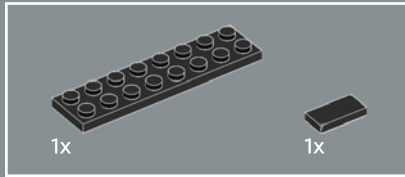
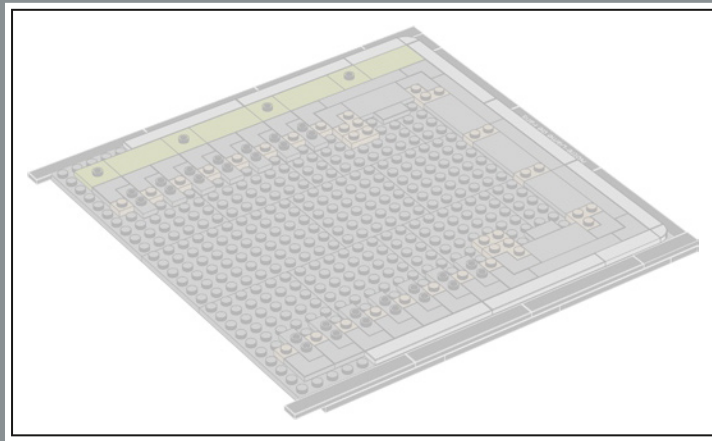

120

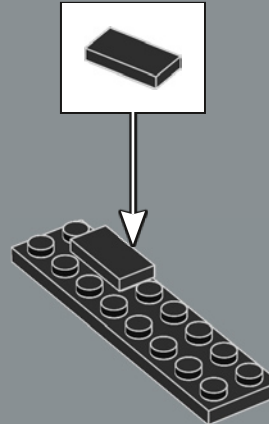

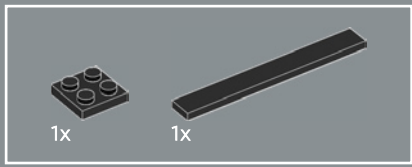

121

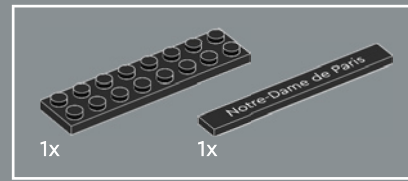
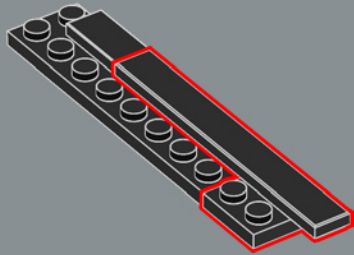

122

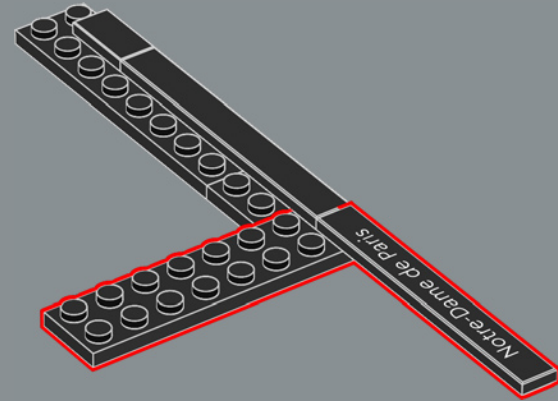

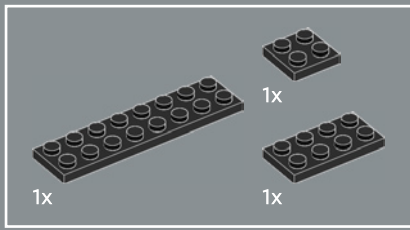

123

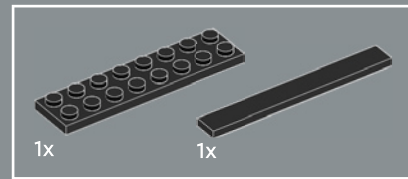
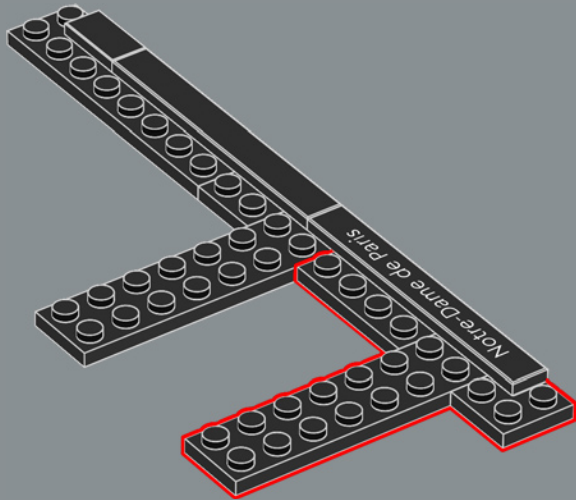

124

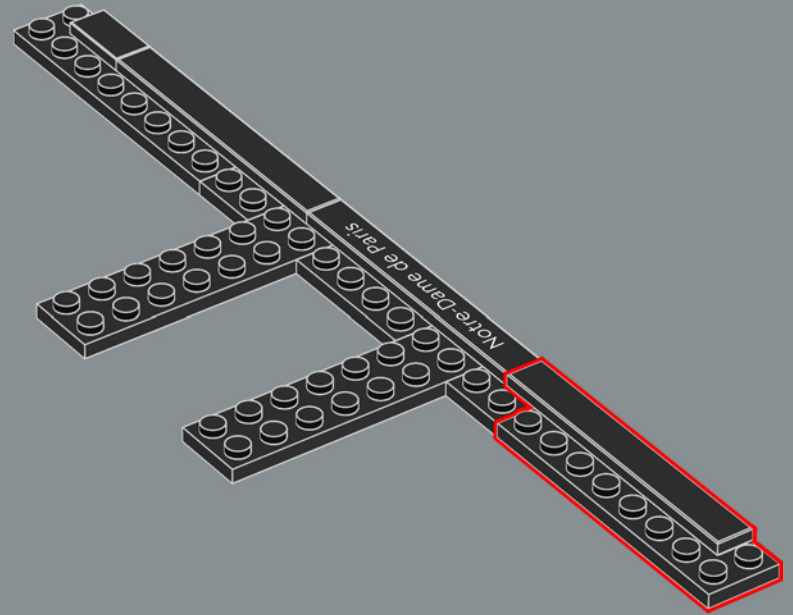

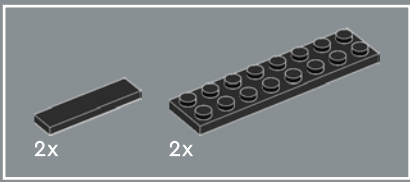

125

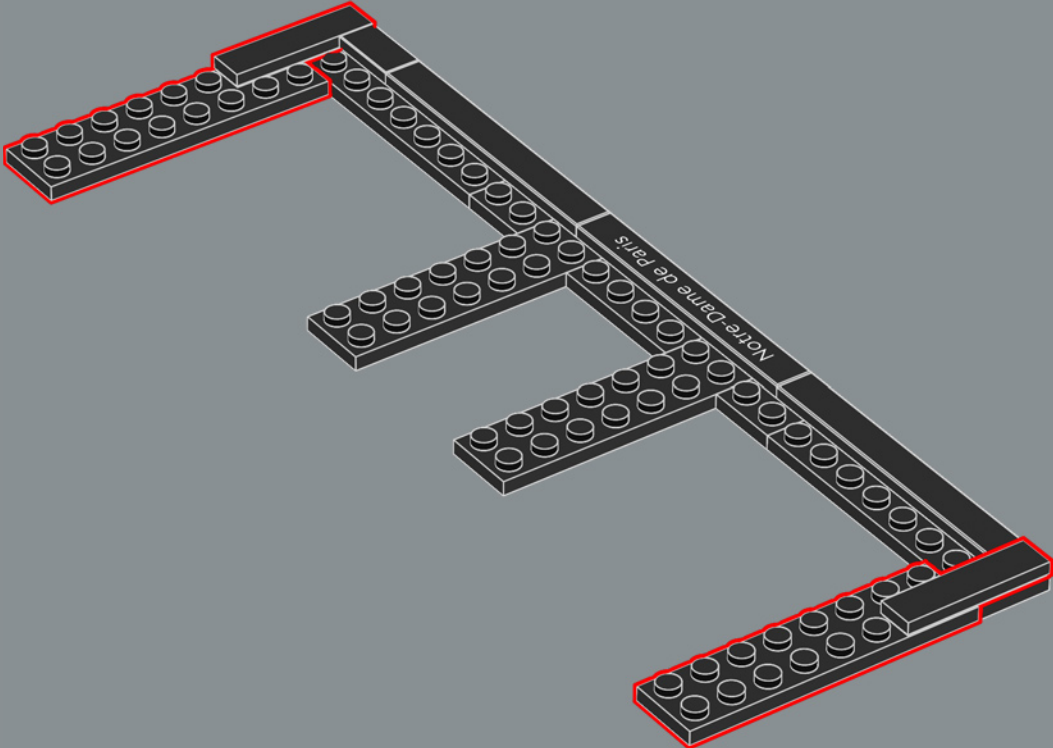

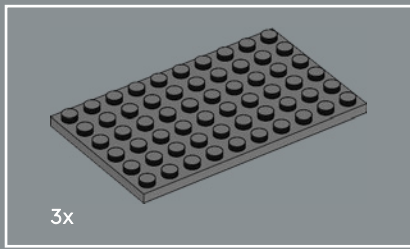

126

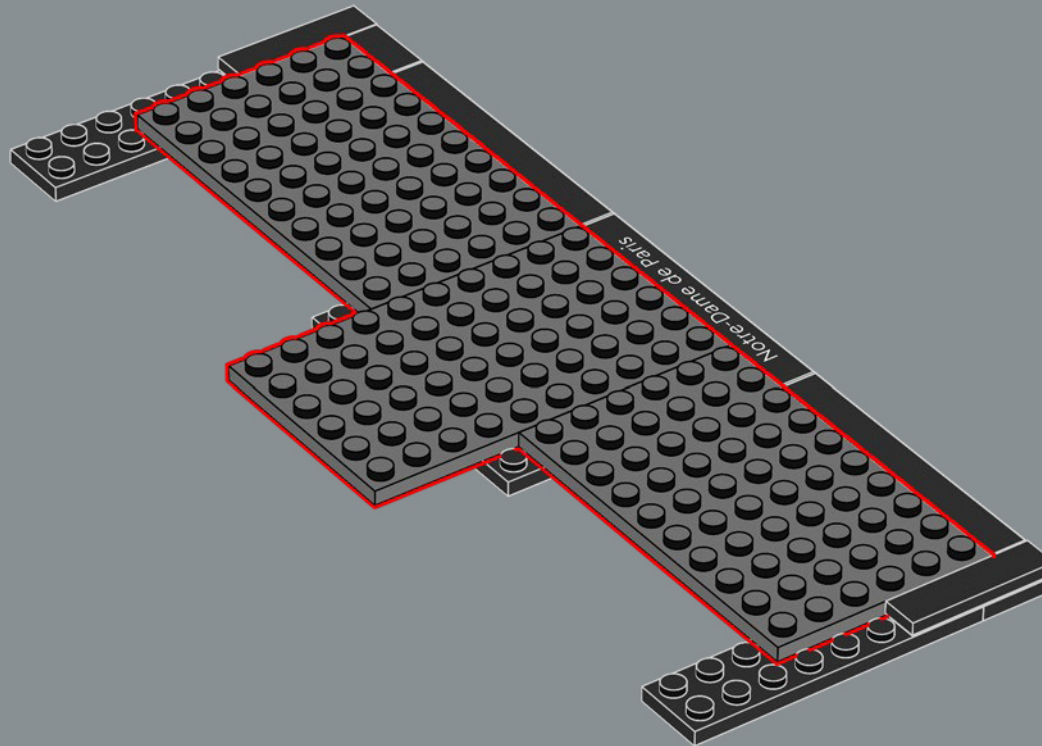

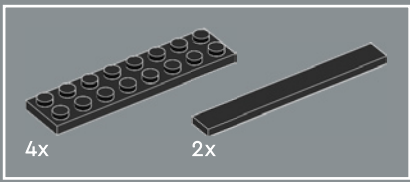

127

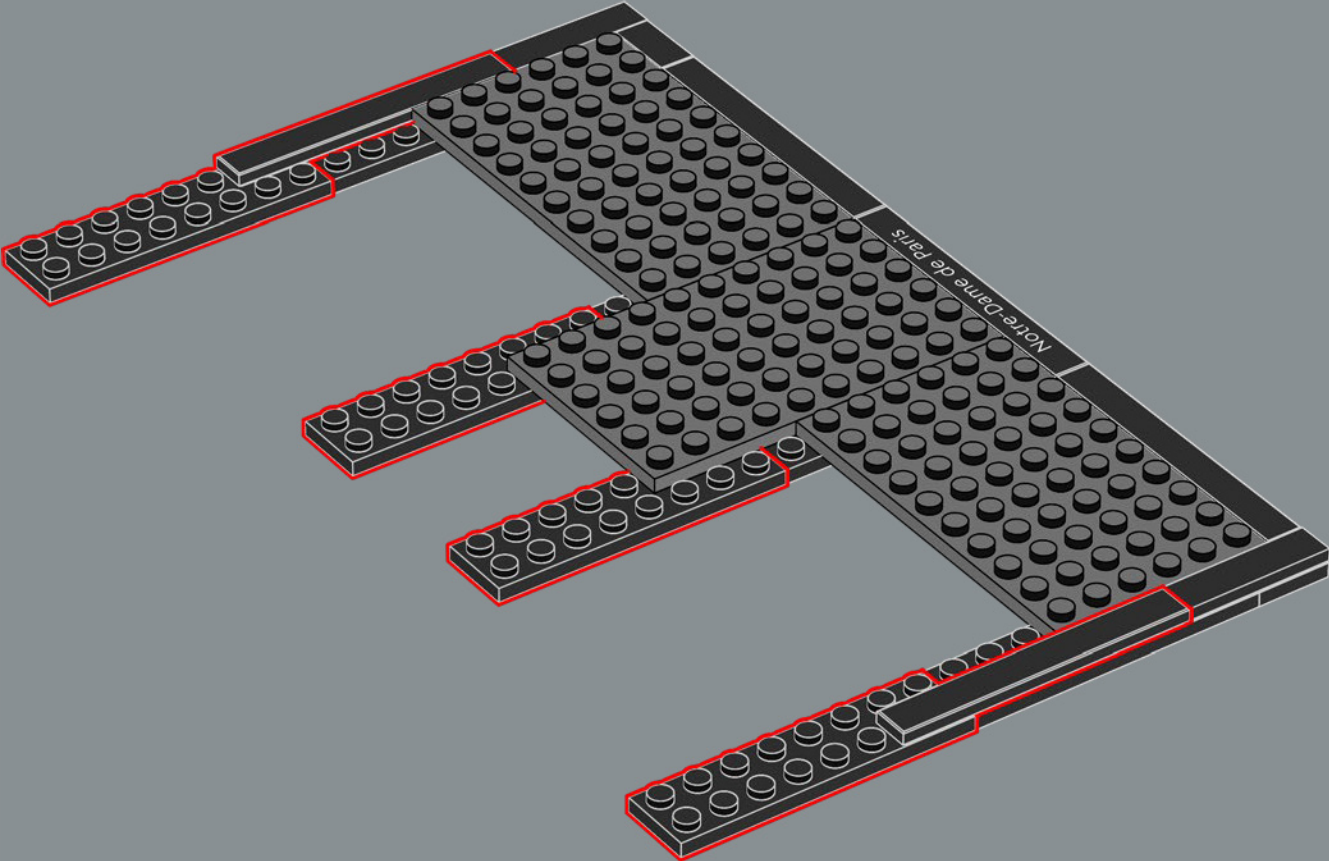

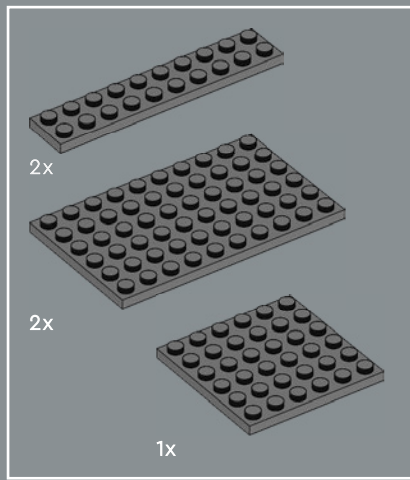

128

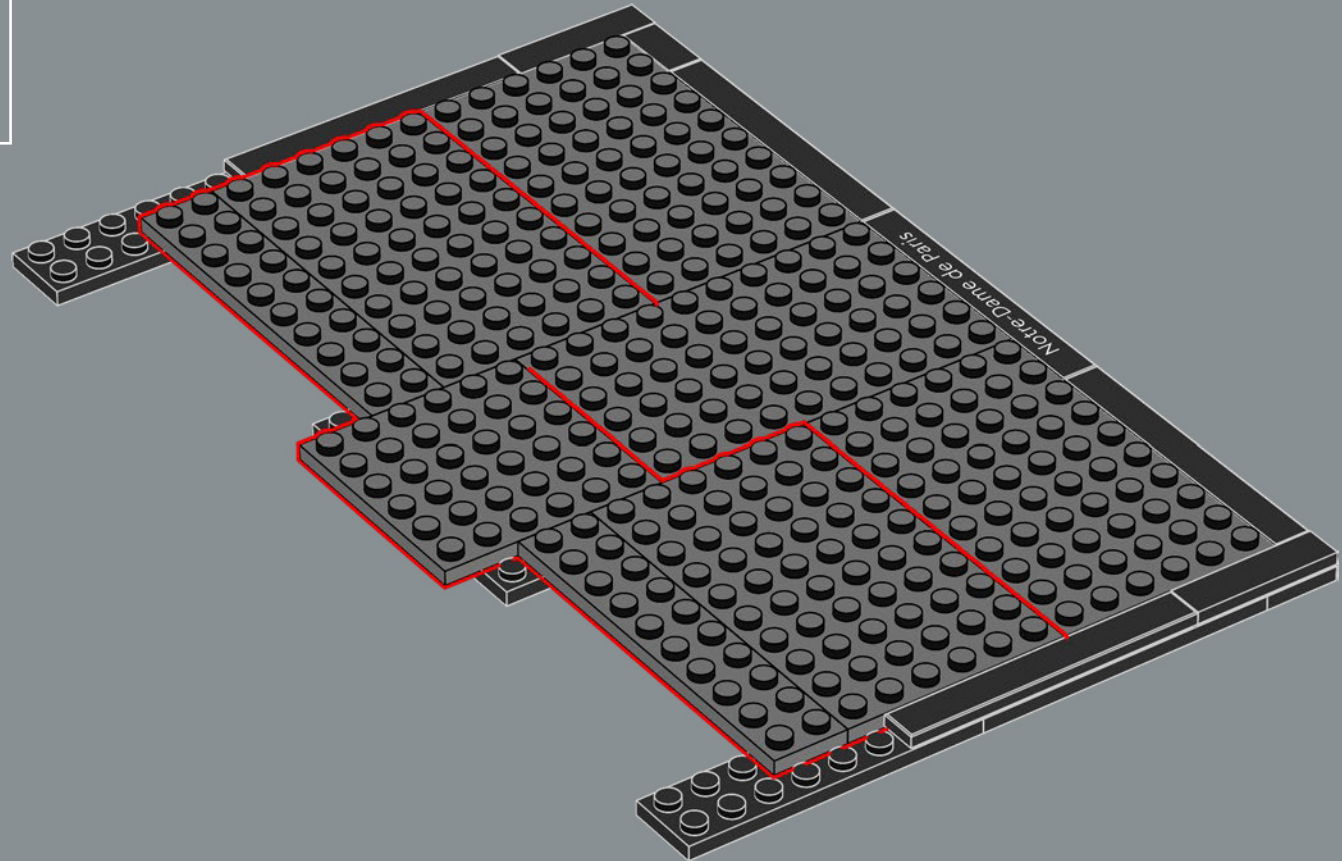

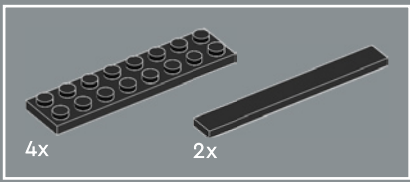

129

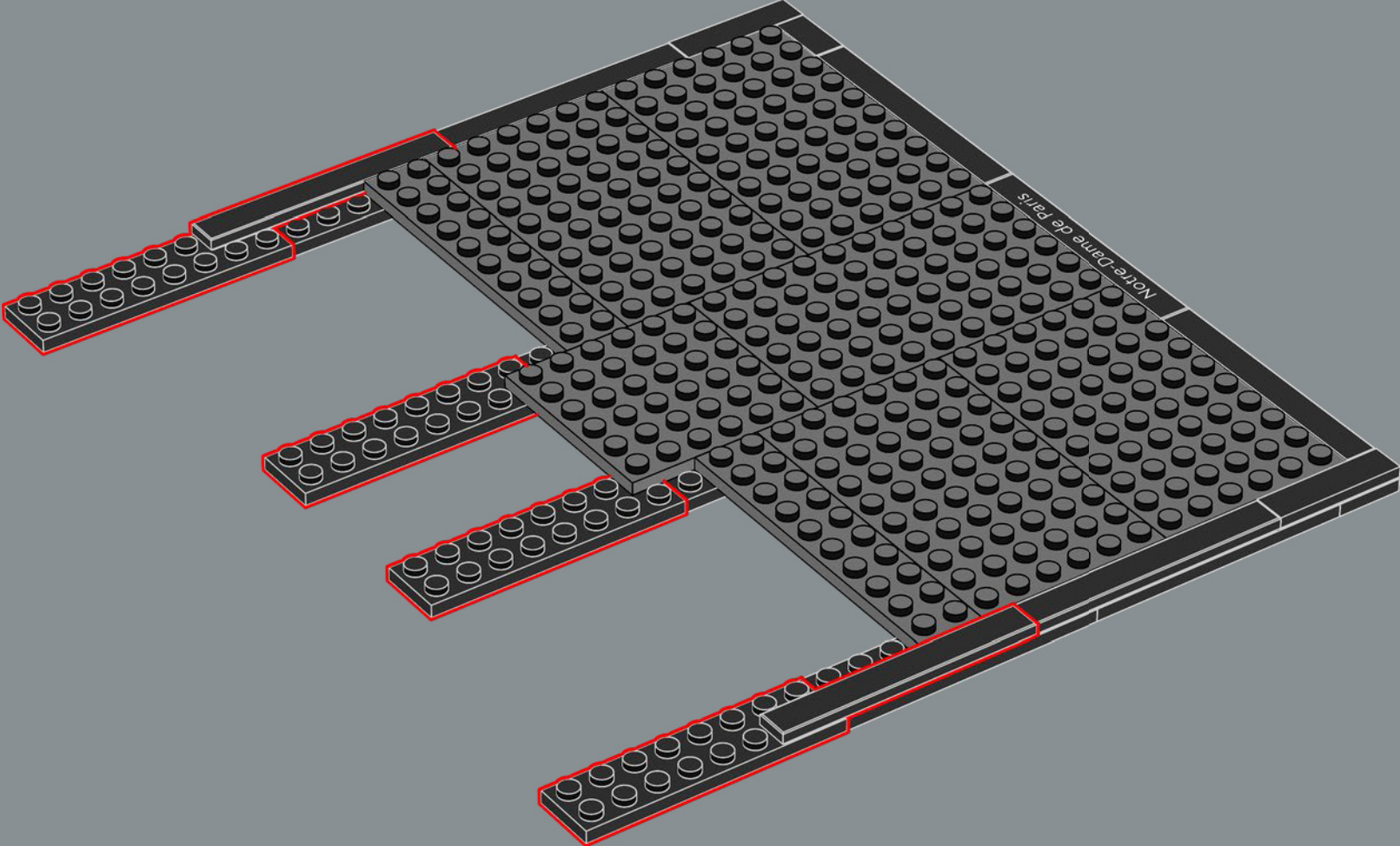

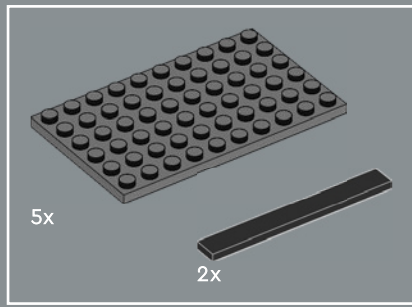

130

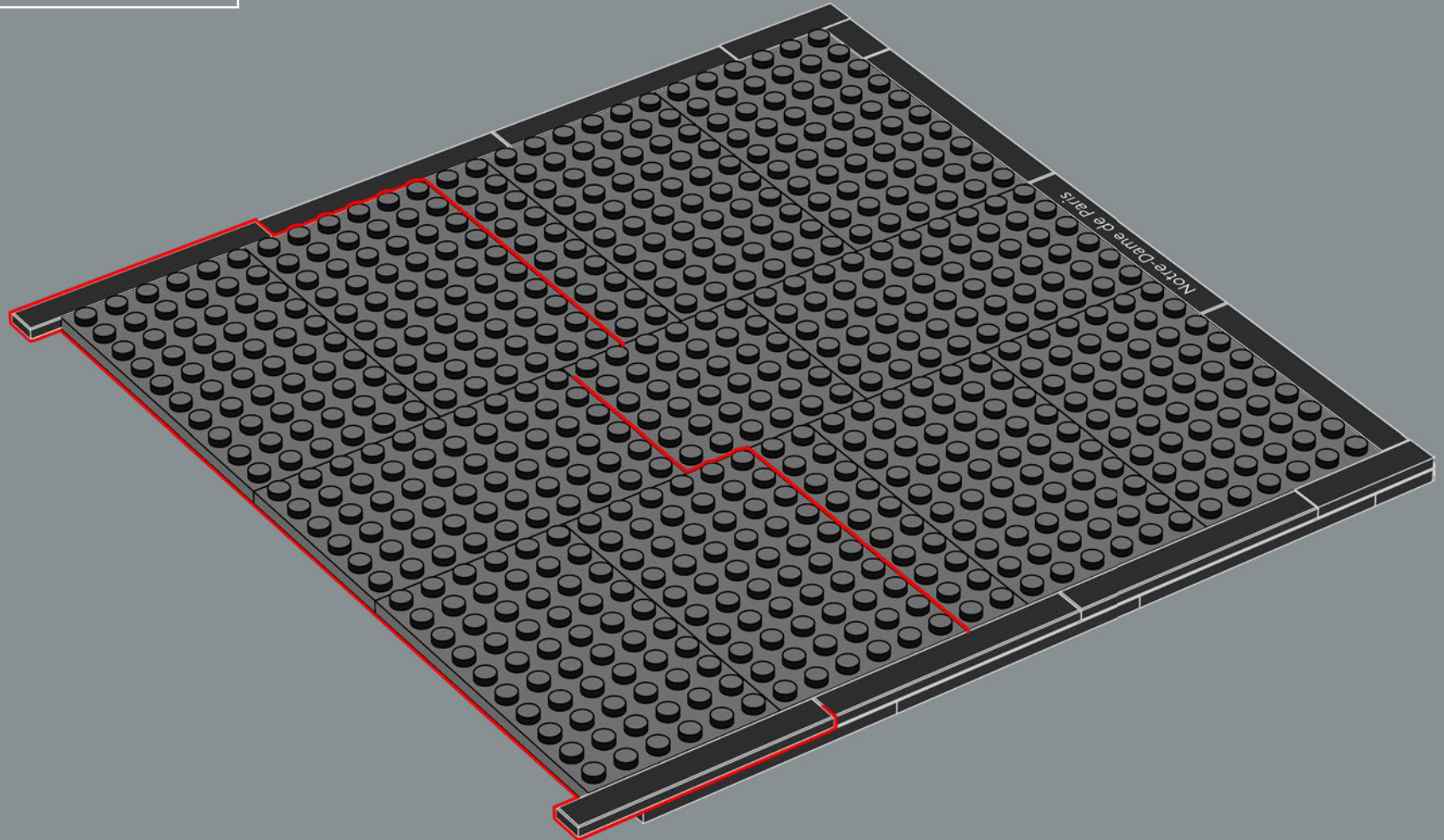

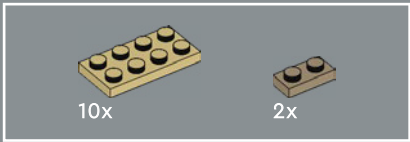

131

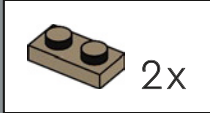
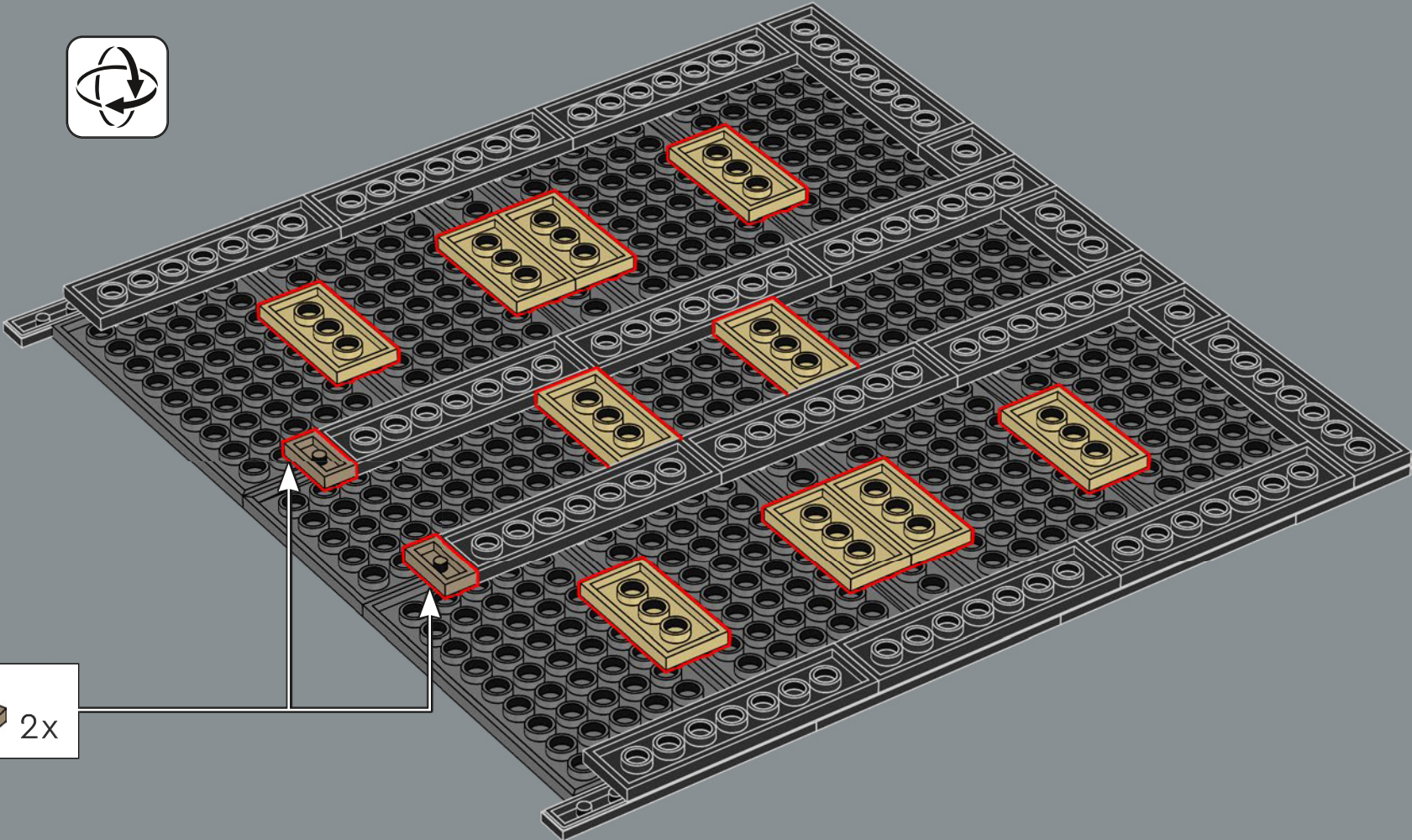

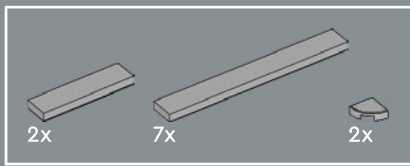

132

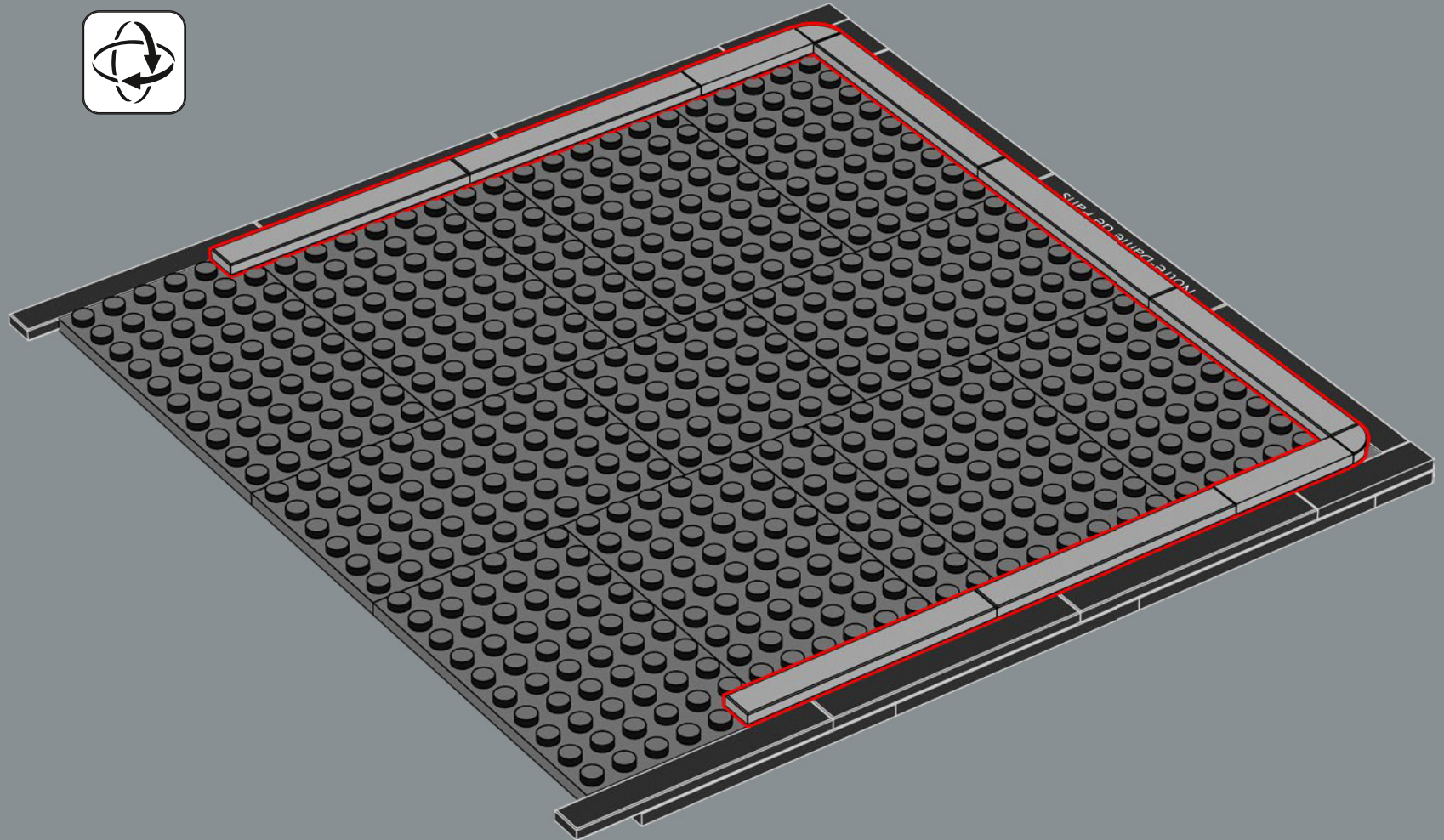

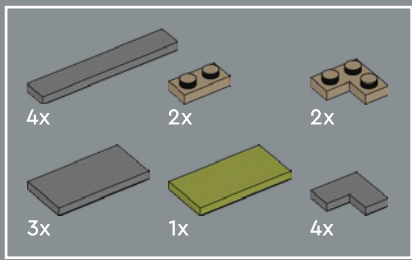

133

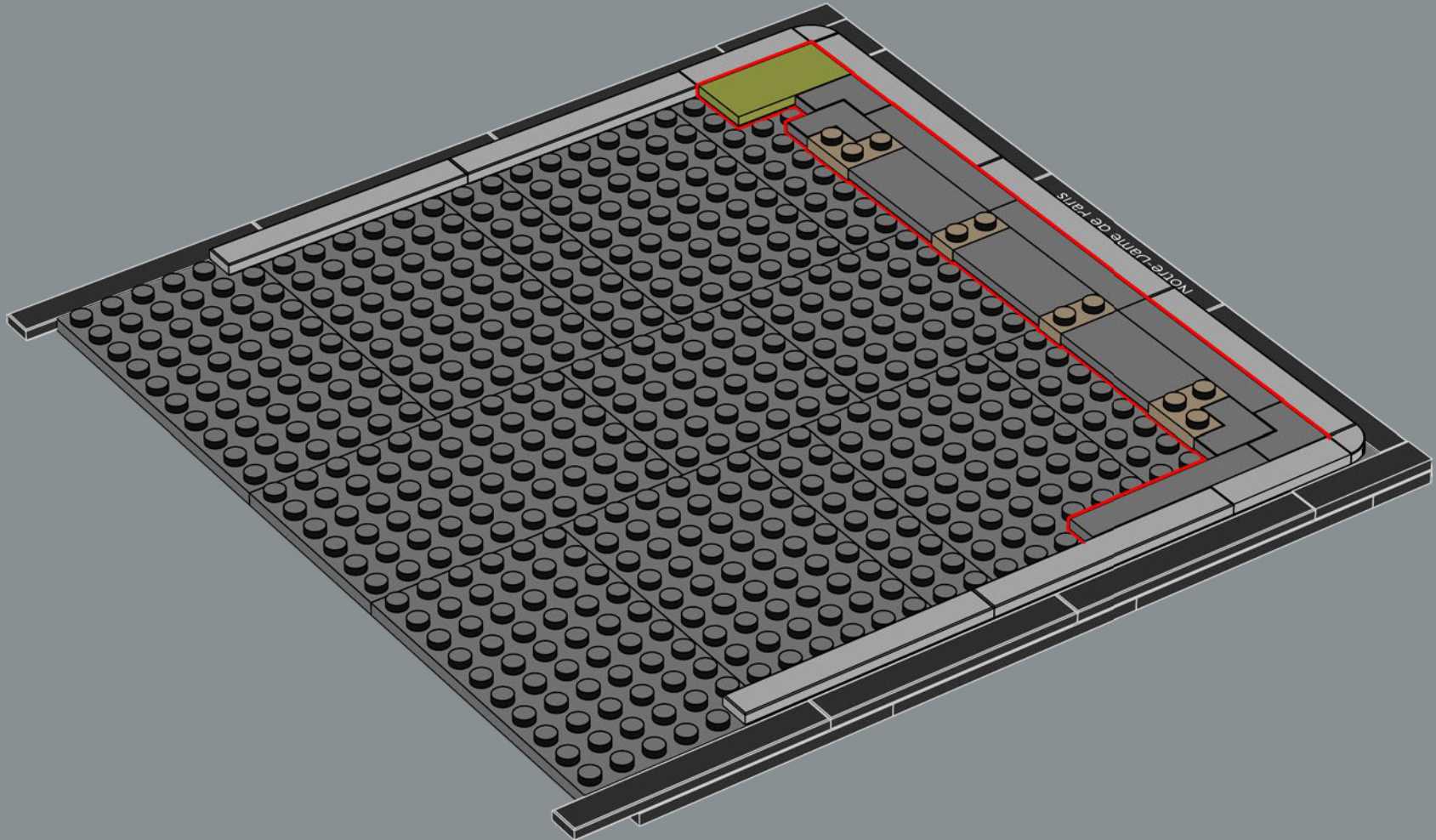

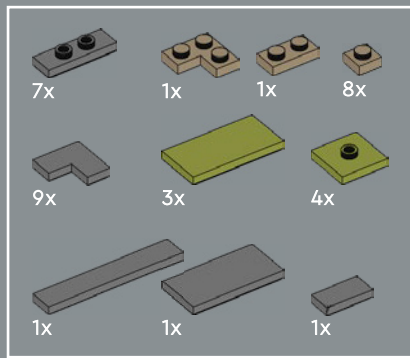

134

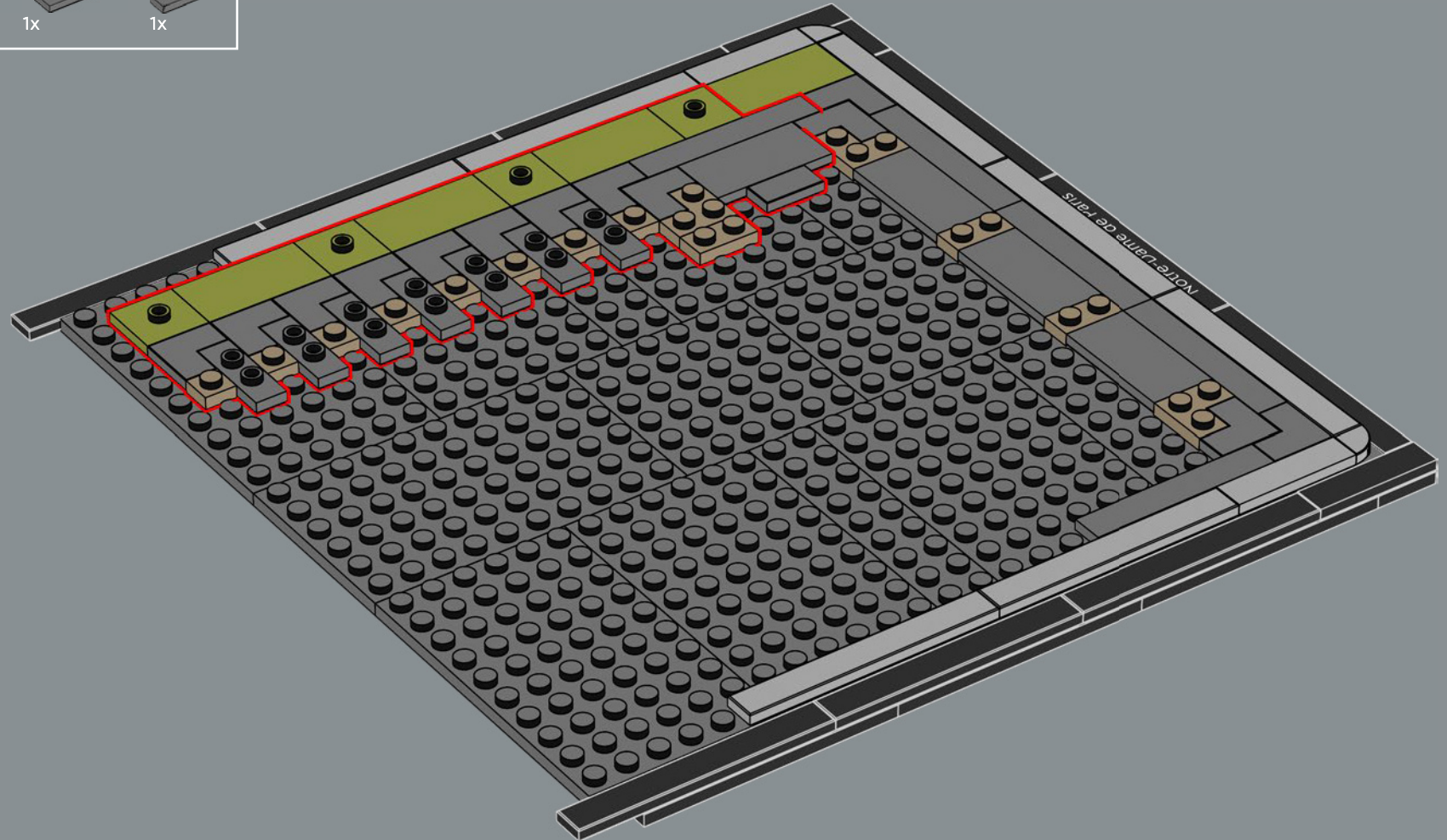

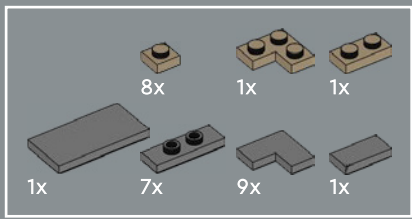

135

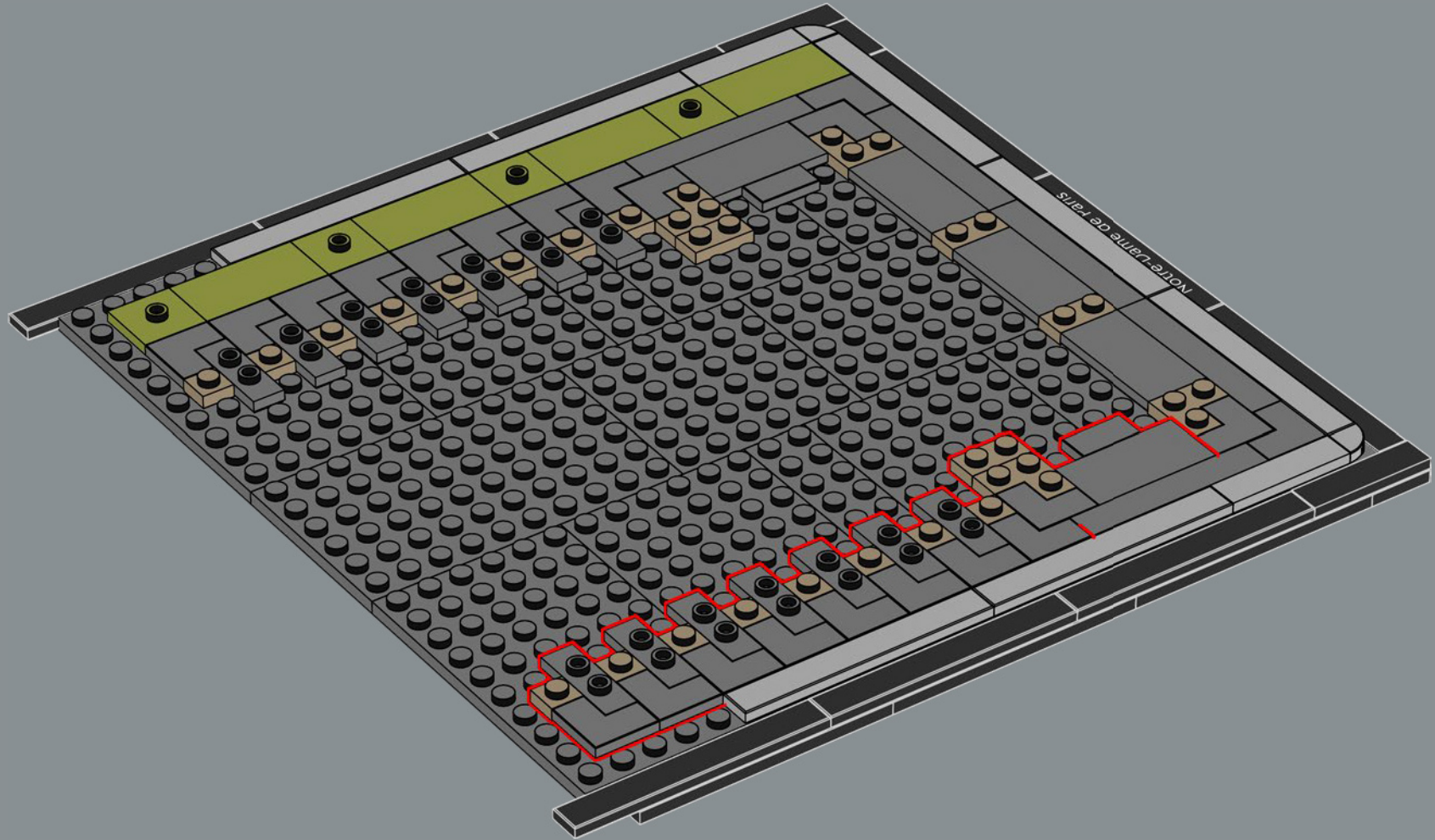

136

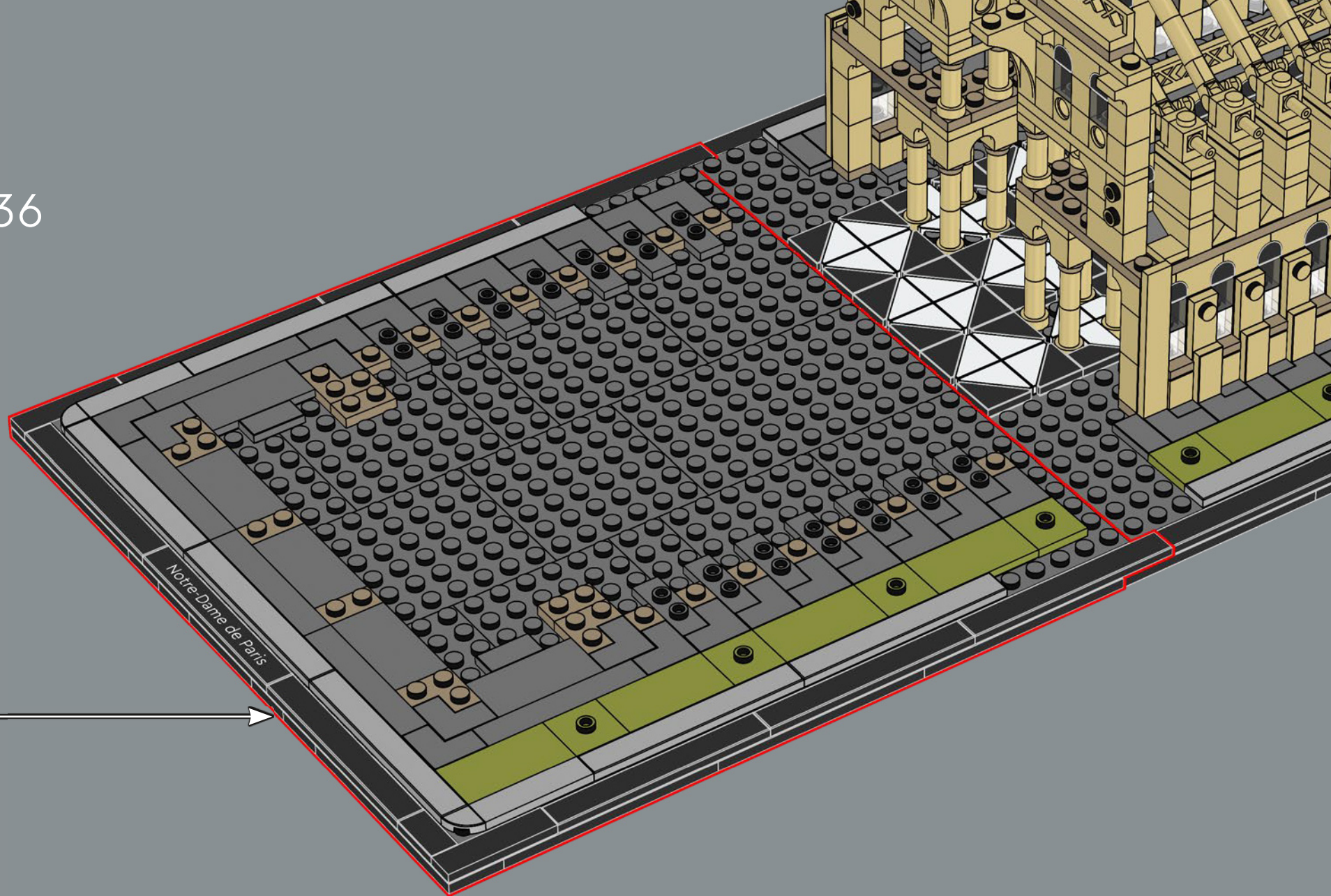

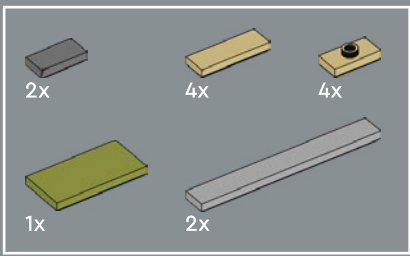

137

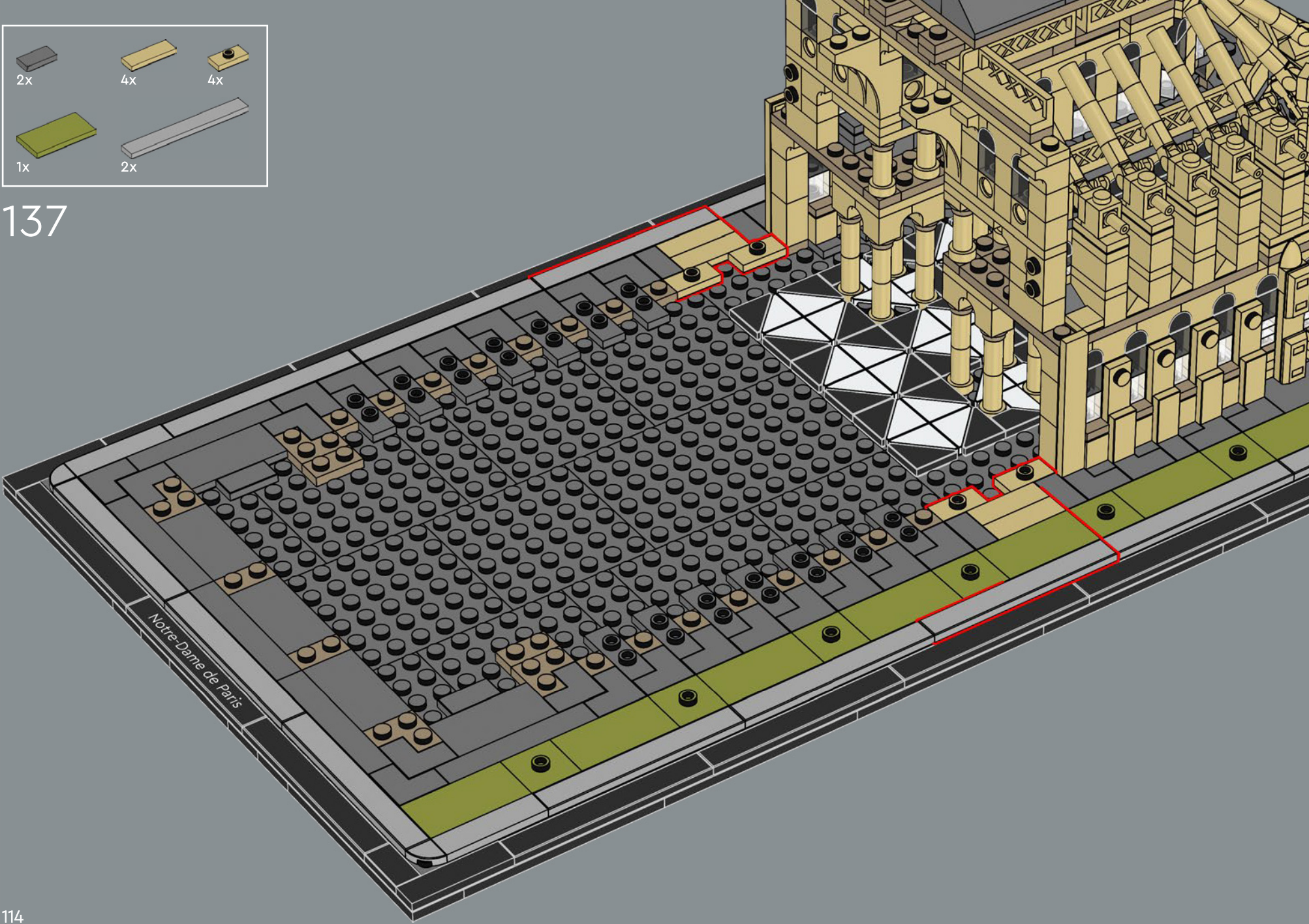

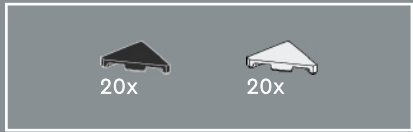

138

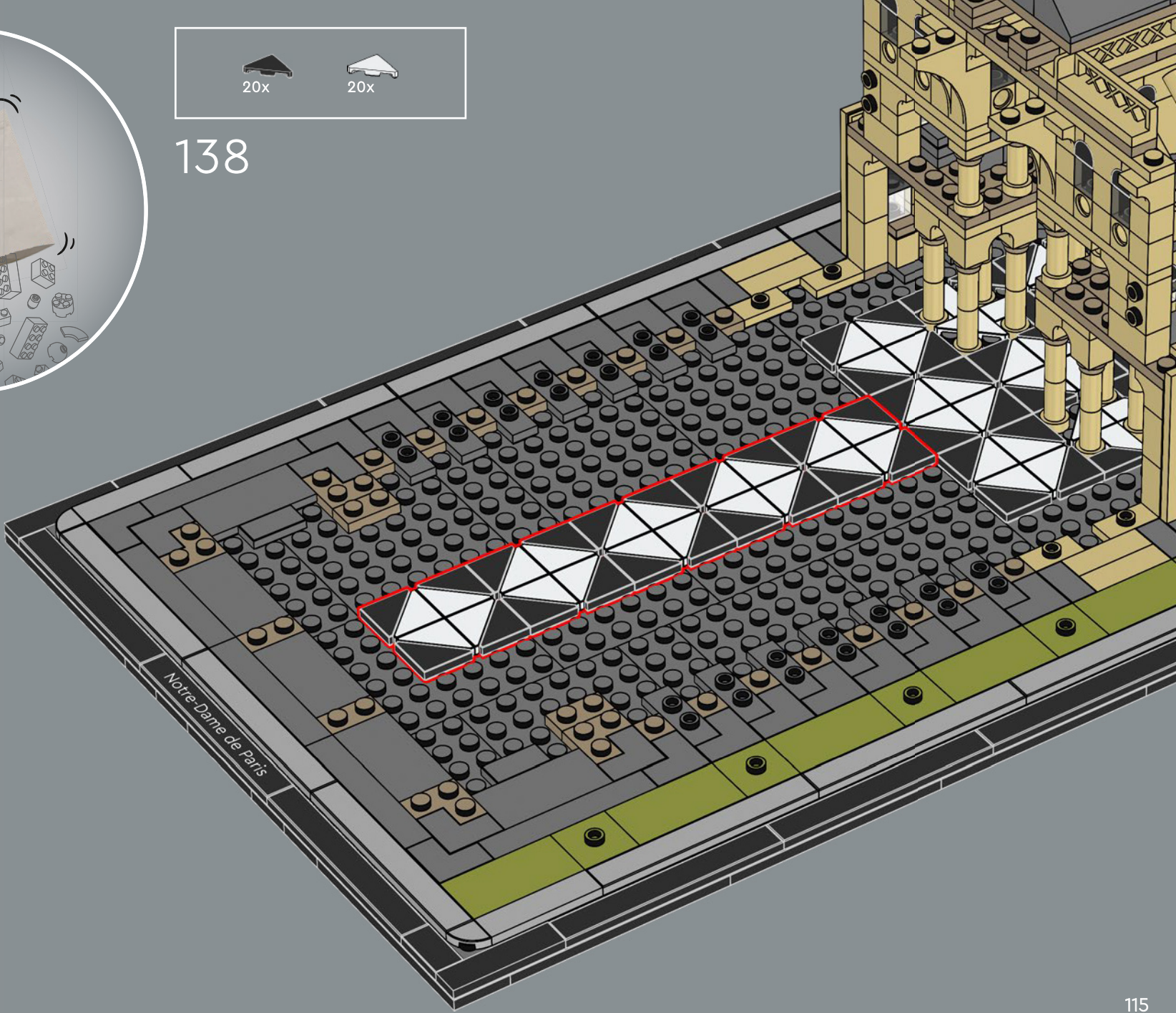

2x 30x

139

30x

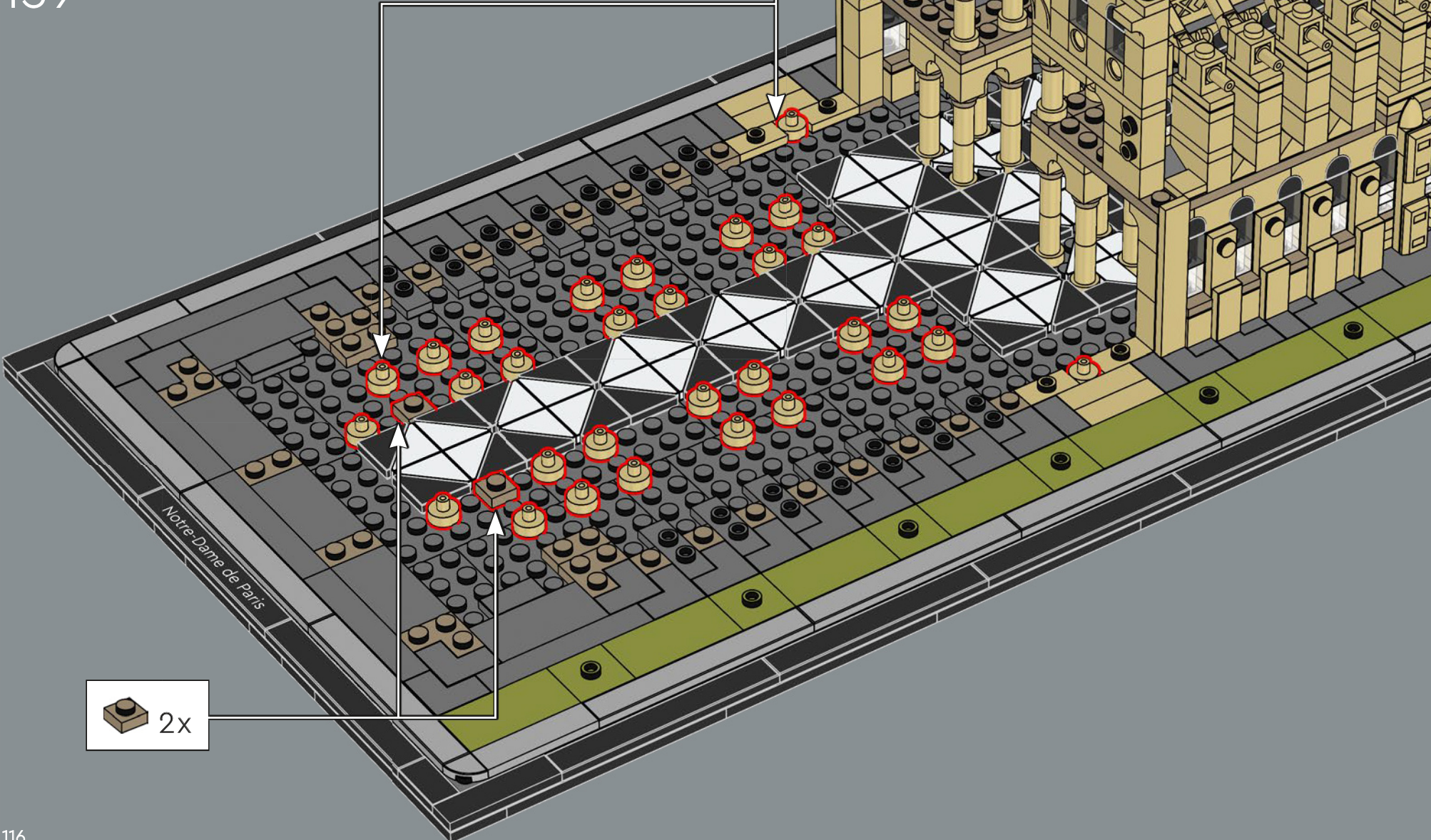

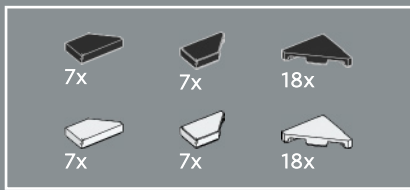

140

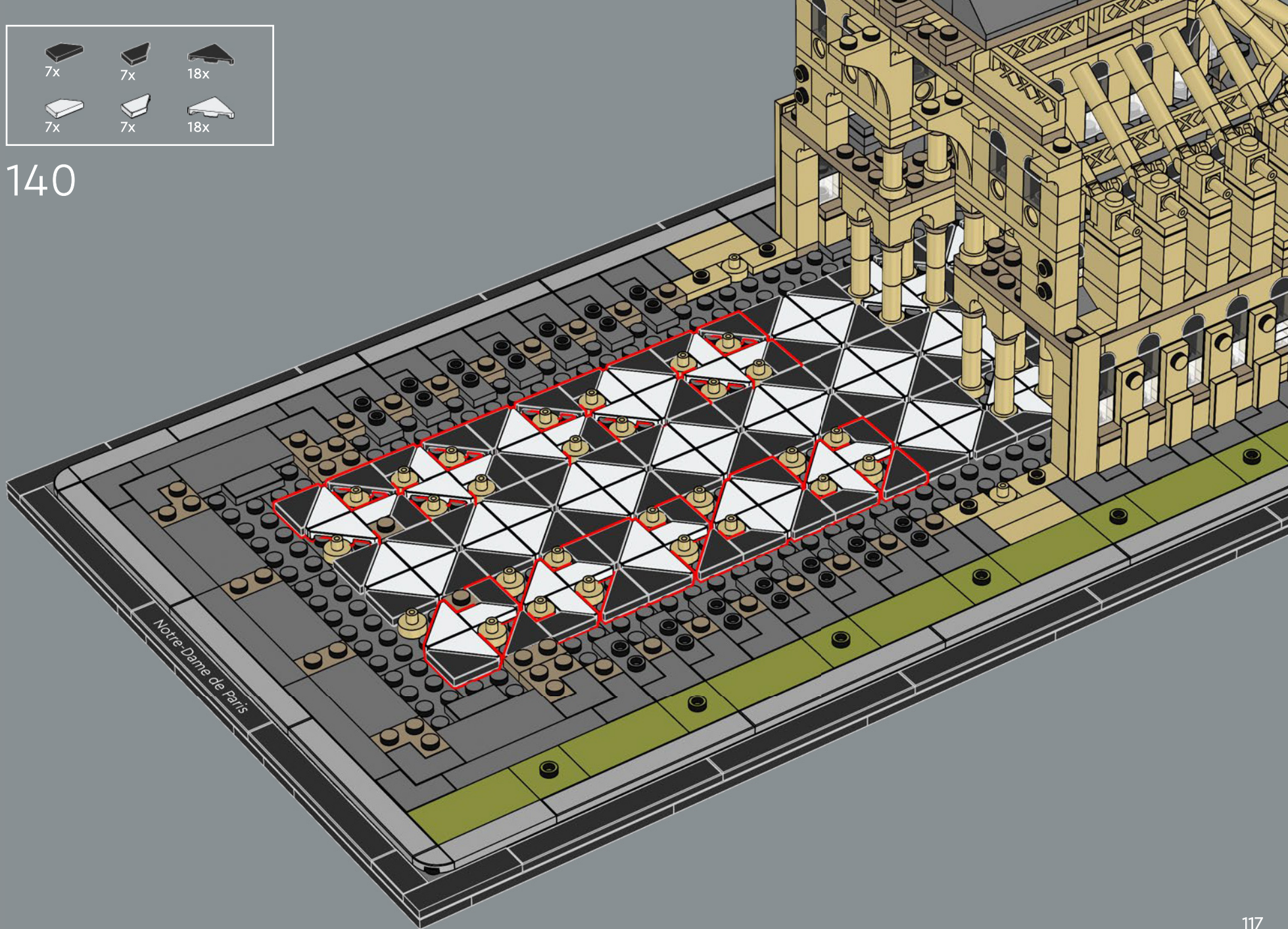



141

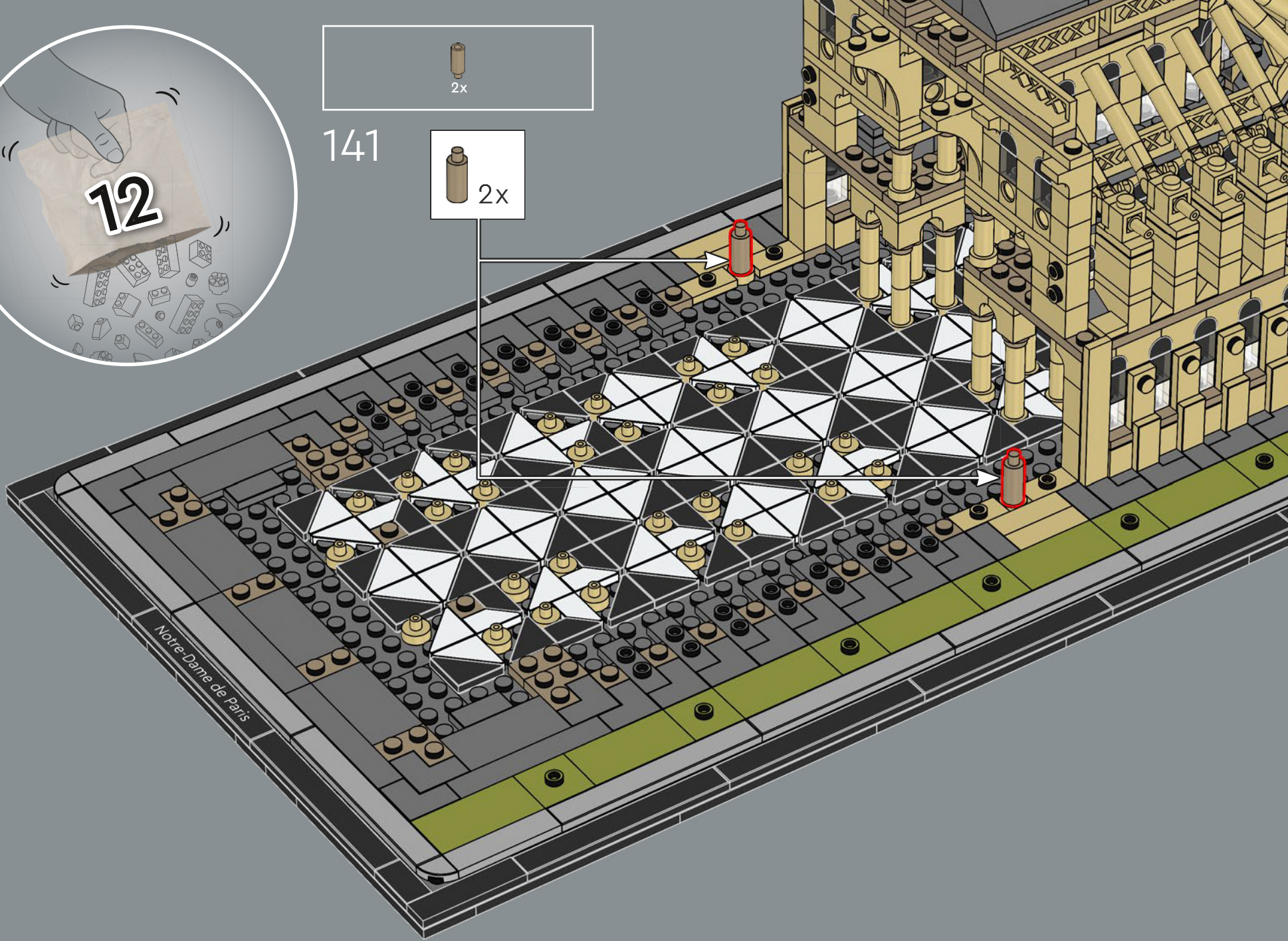
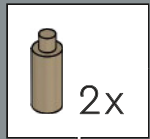

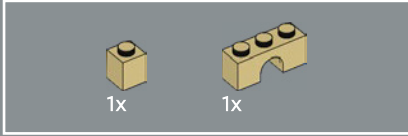
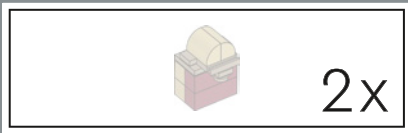

142

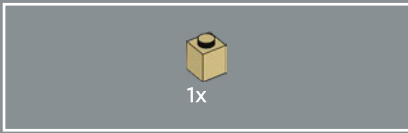
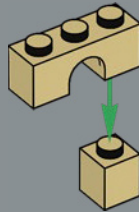

143

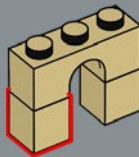

144

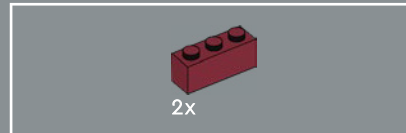
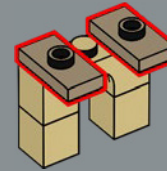

145

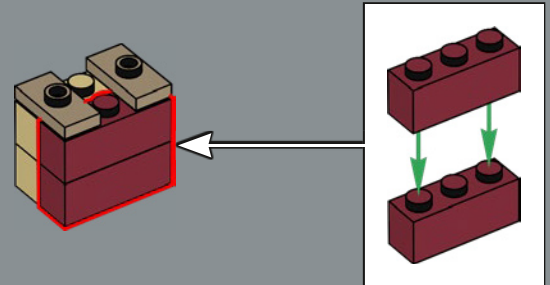

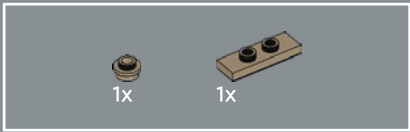

146

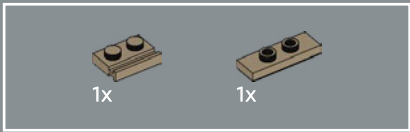
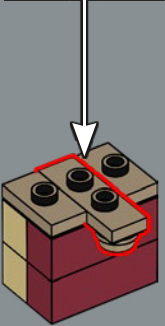
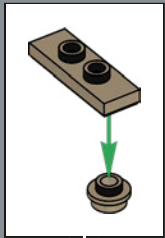

147

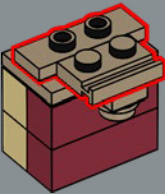

148

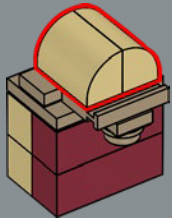

2x

149

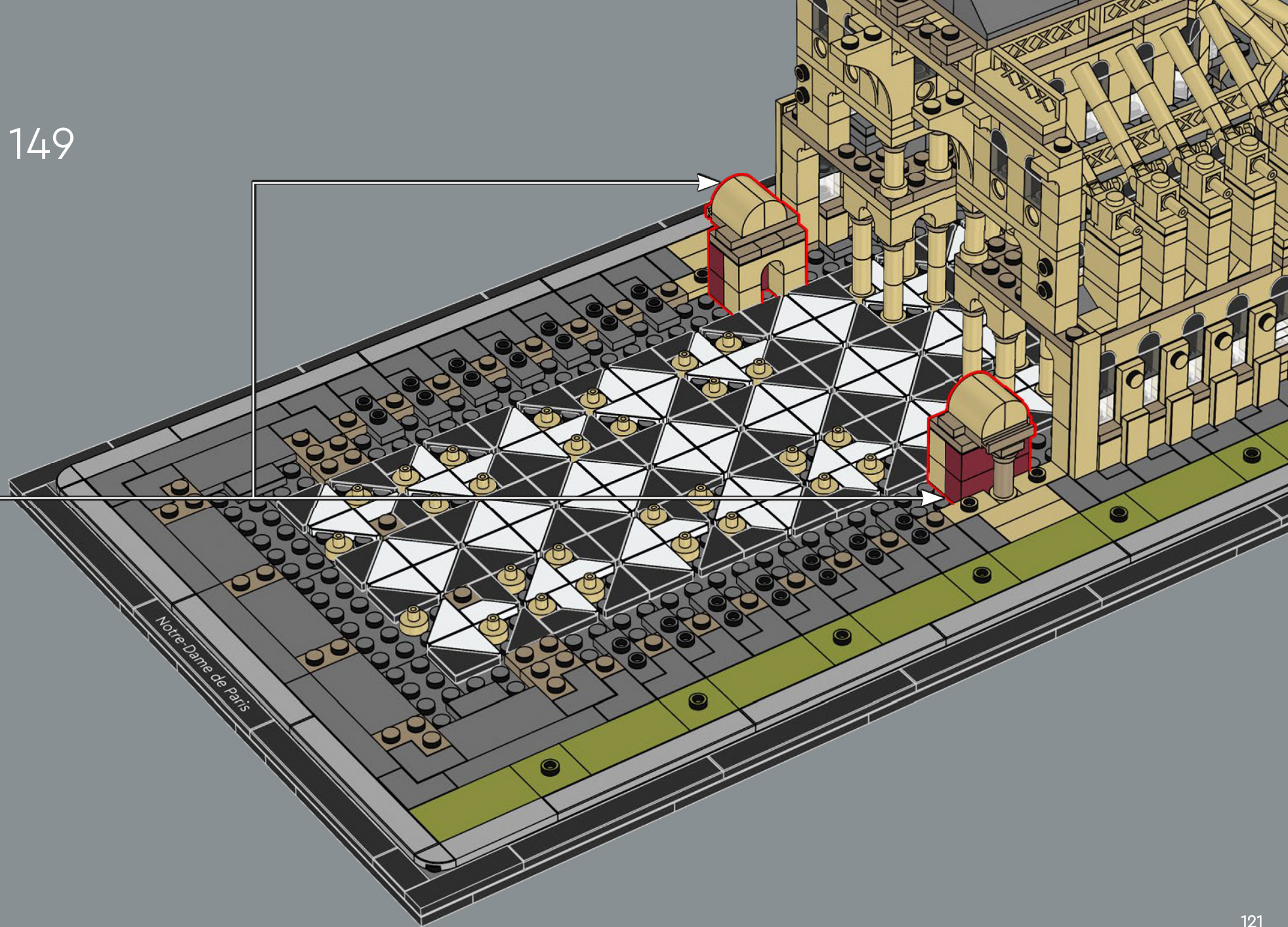

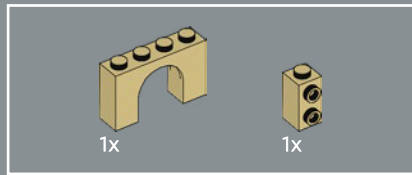
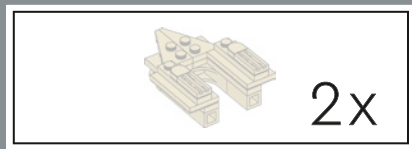

150

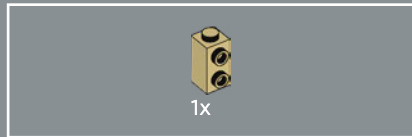
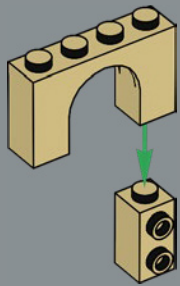

151

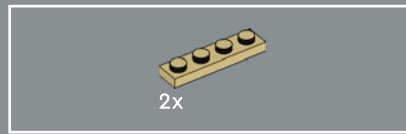
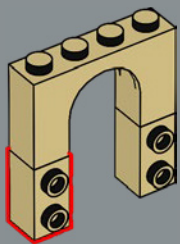

152

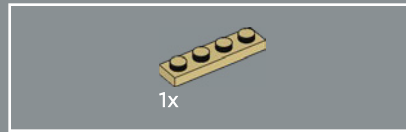
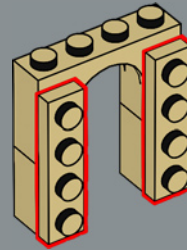

153

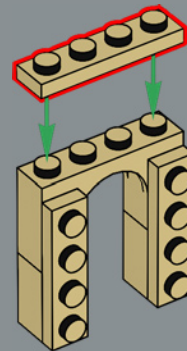

154

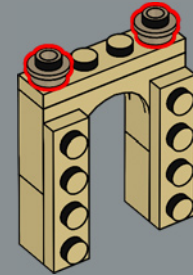

155

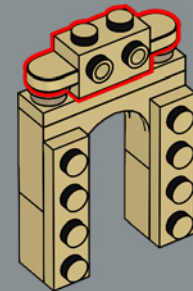

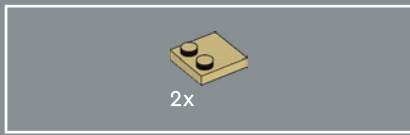

156

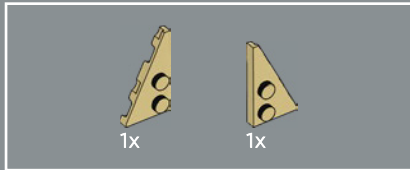
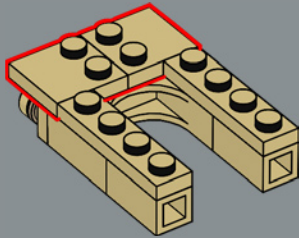

157

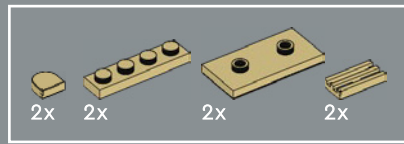
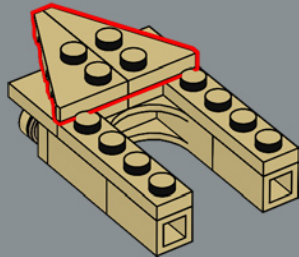

158

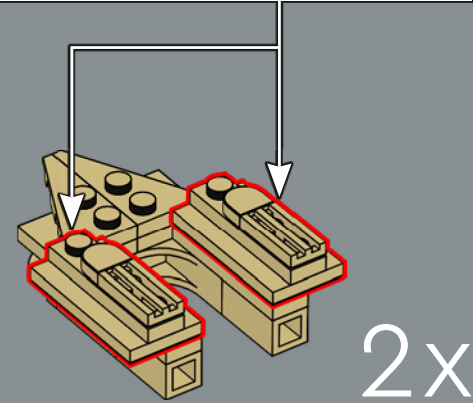
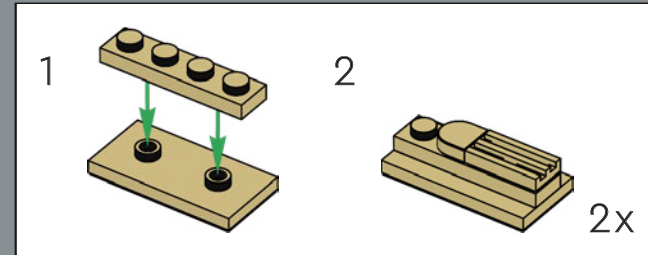

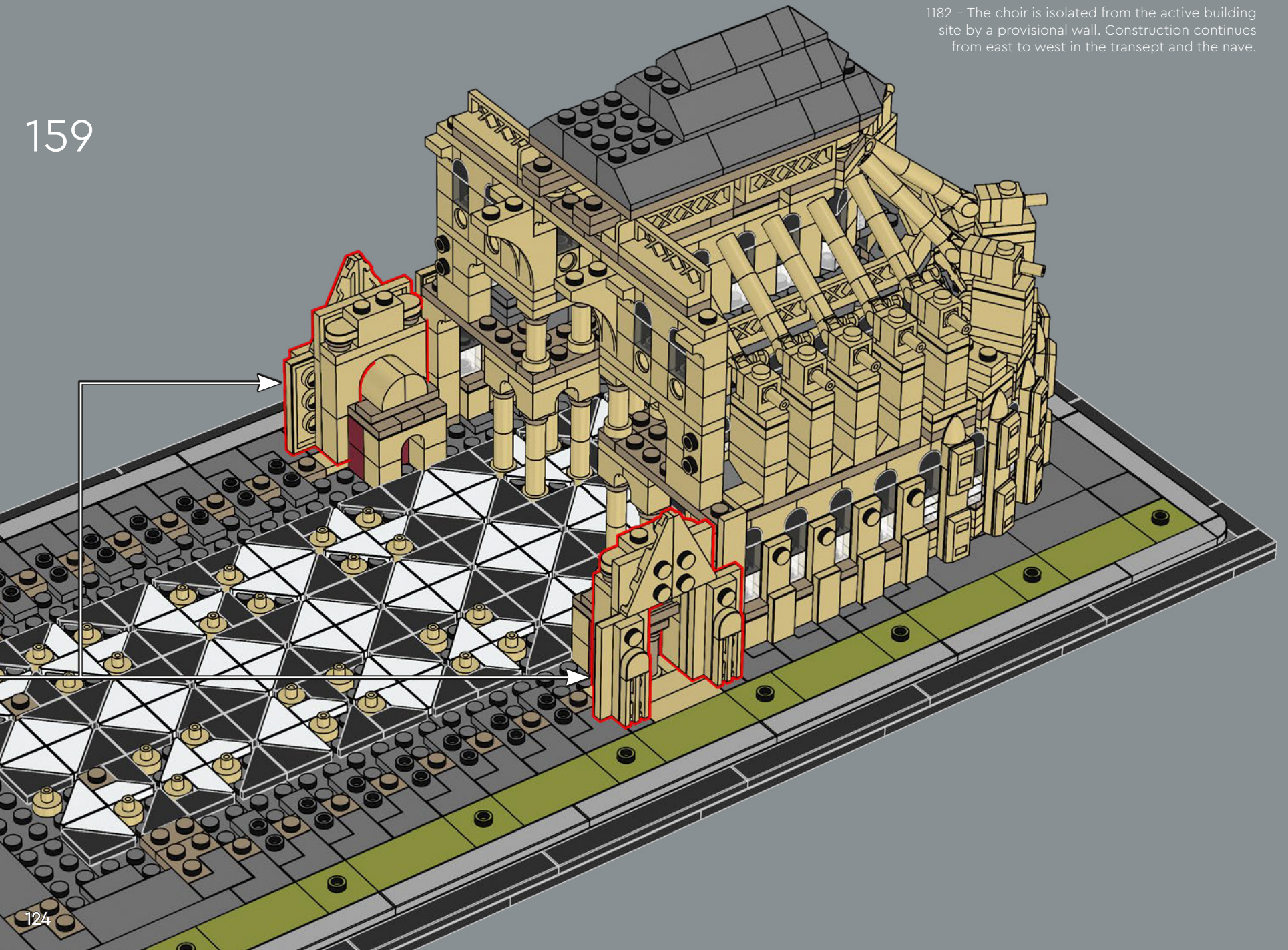

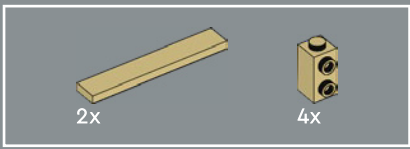

160

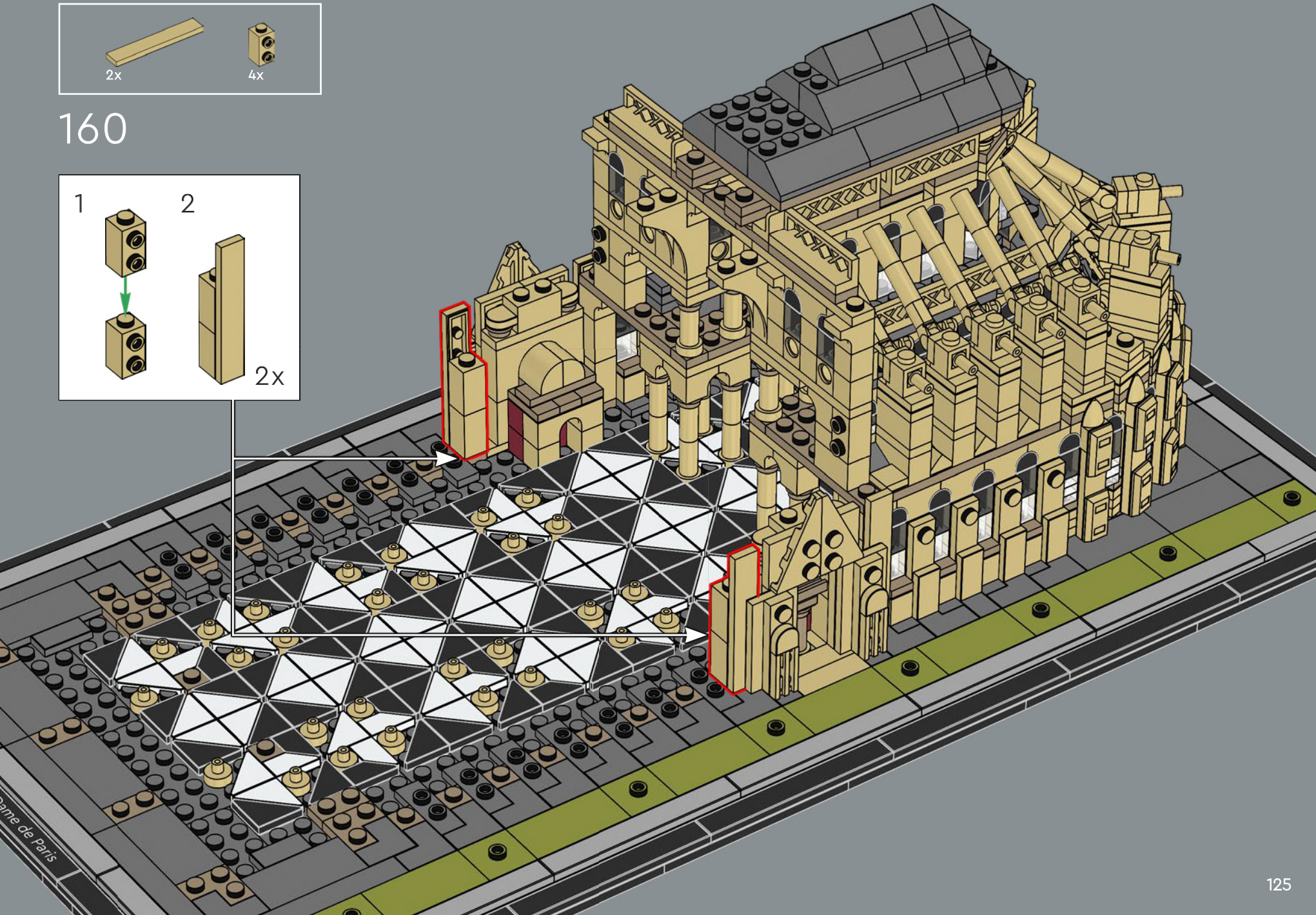
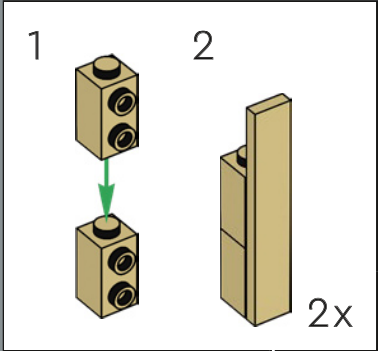

Paris de Paris

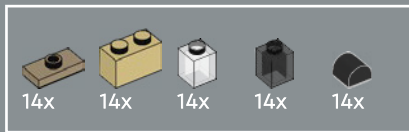

161

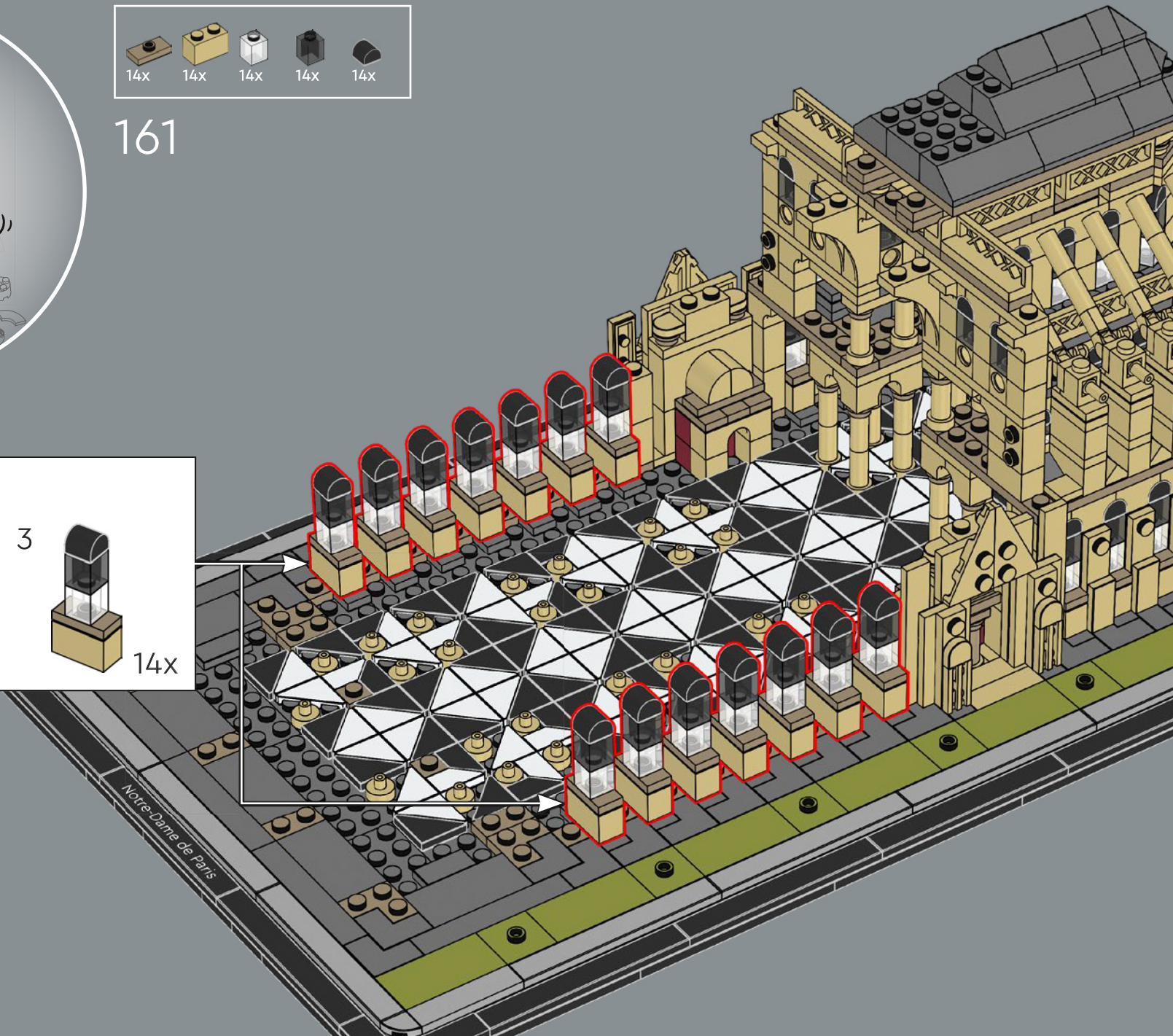
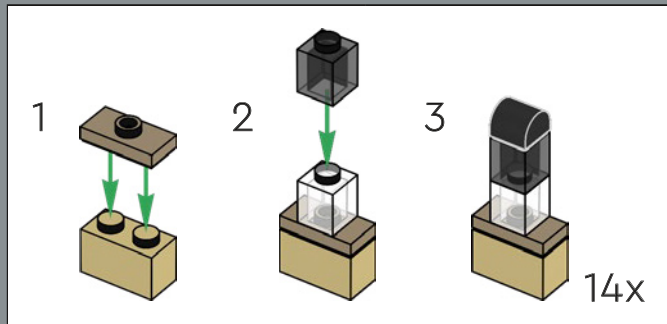

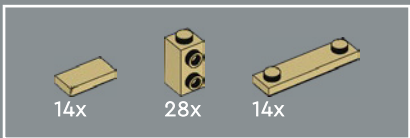

162

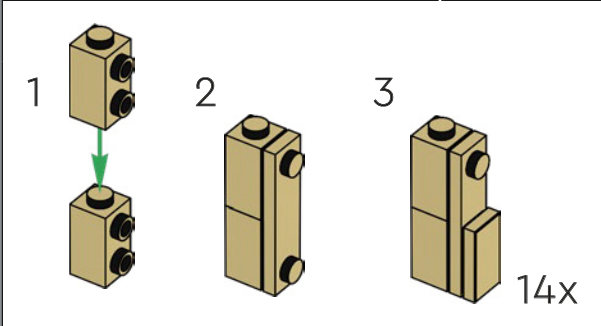
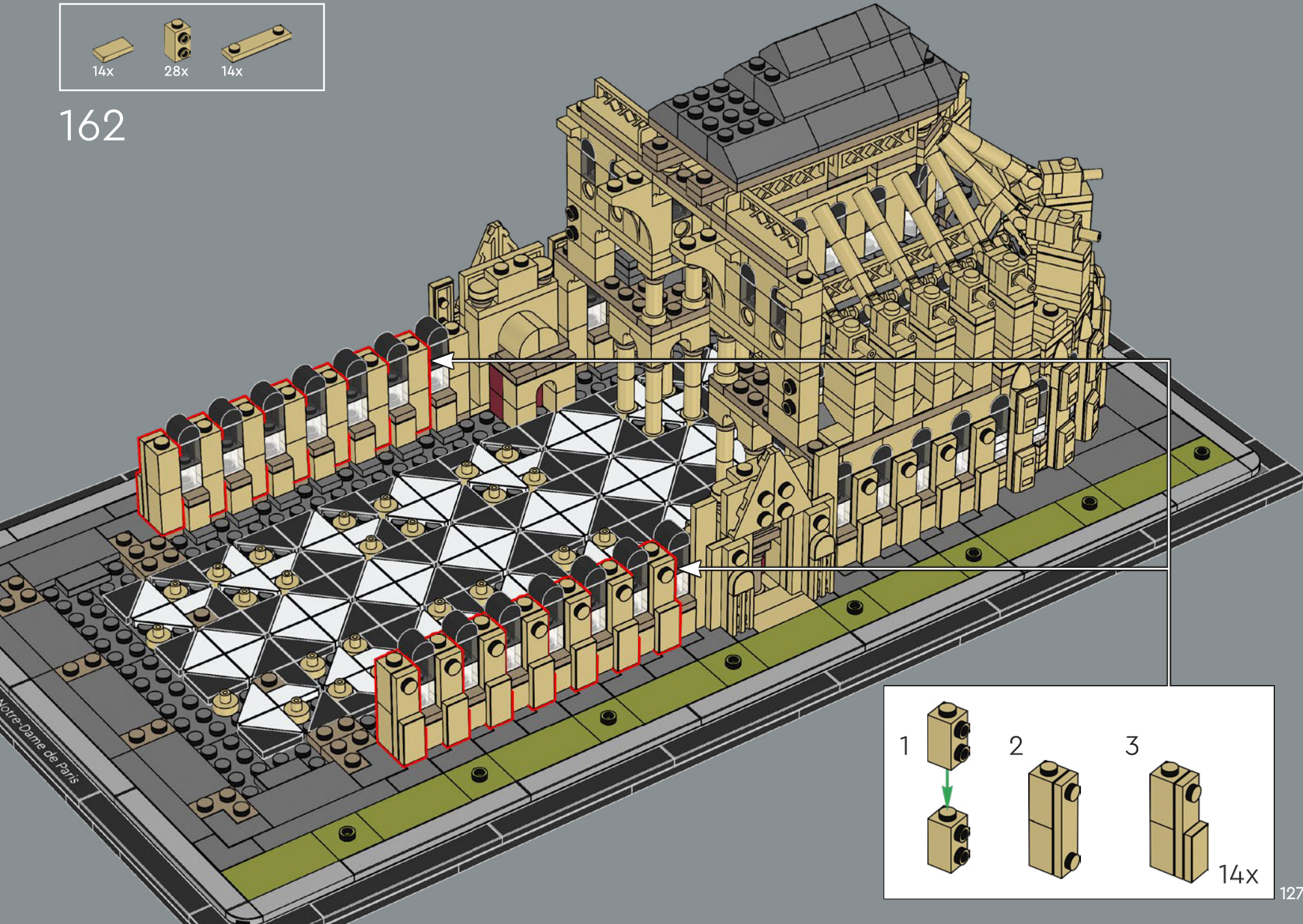



12x



4x

163





164

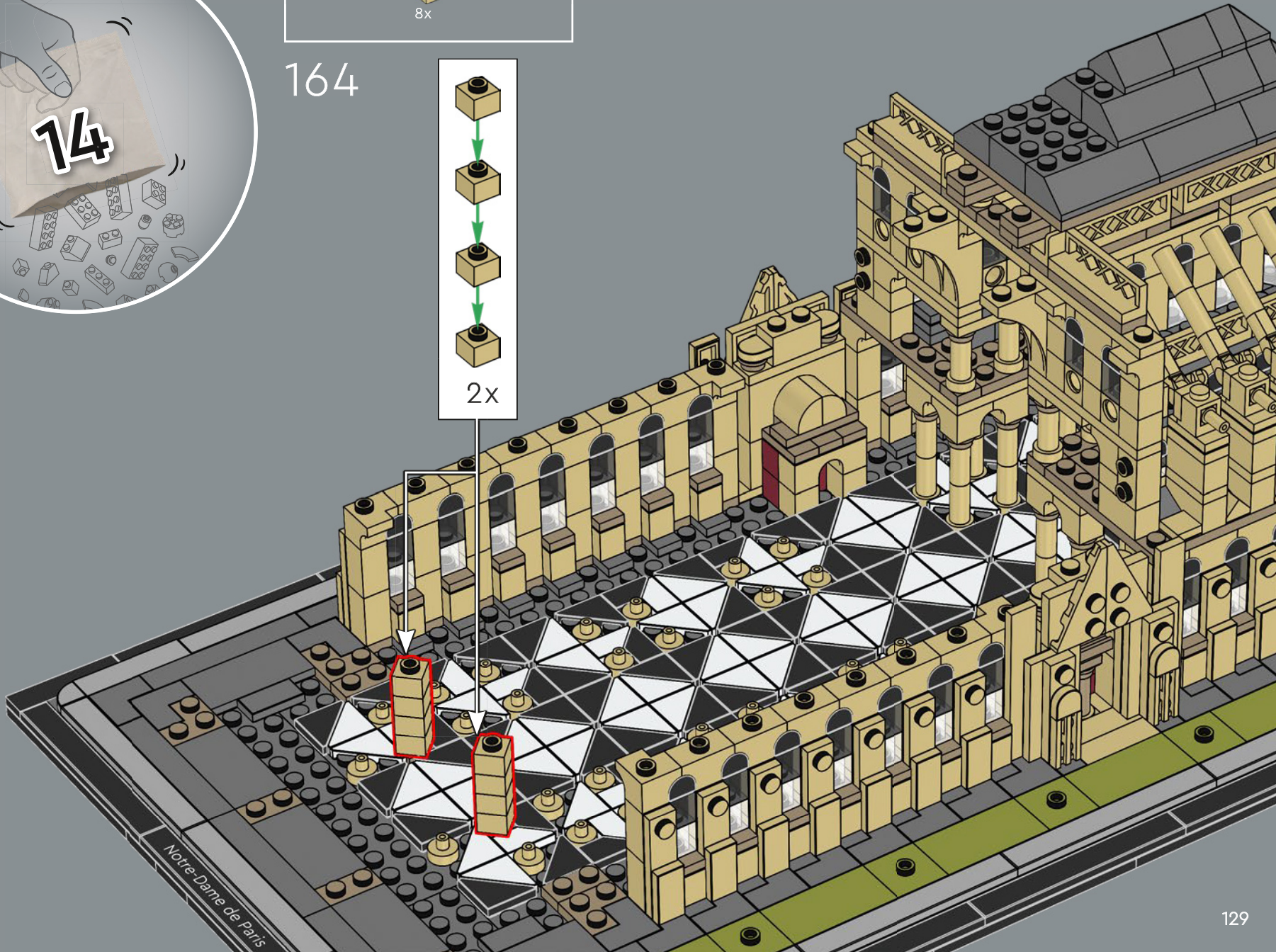
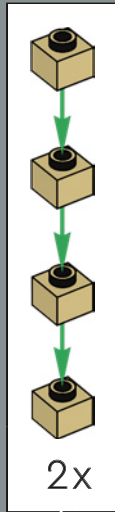



56x

165



28x

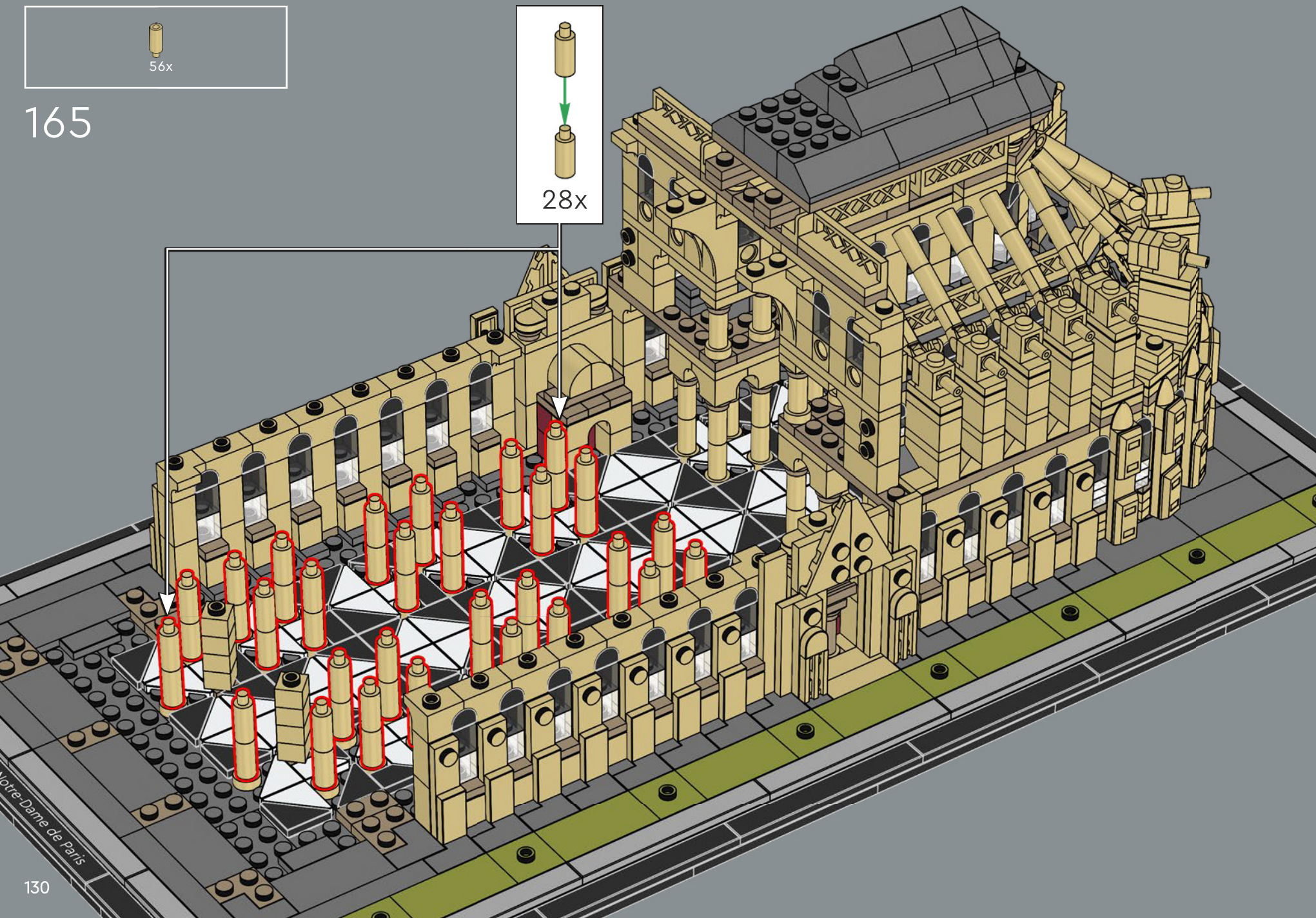

Notre-Dame de Paris

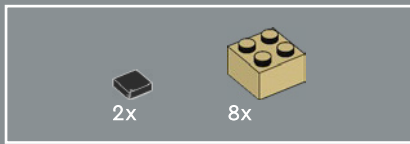

166

1208 – Work continues in the nave, and the foundations of the great west towers are laid.

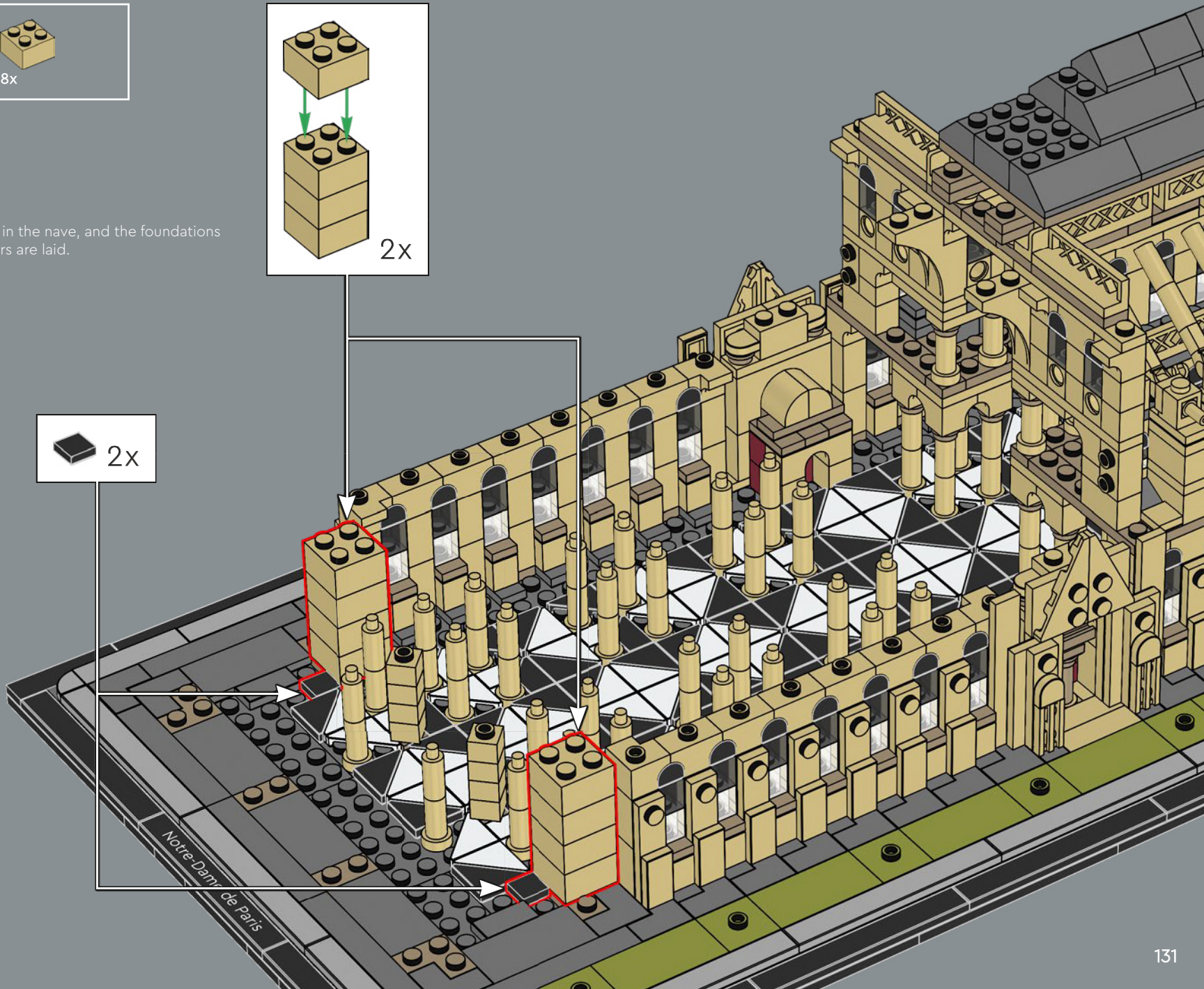
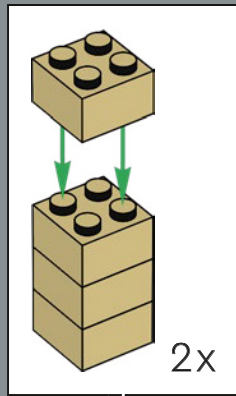

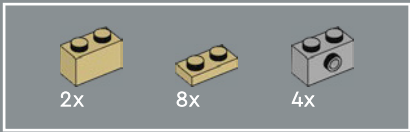

167

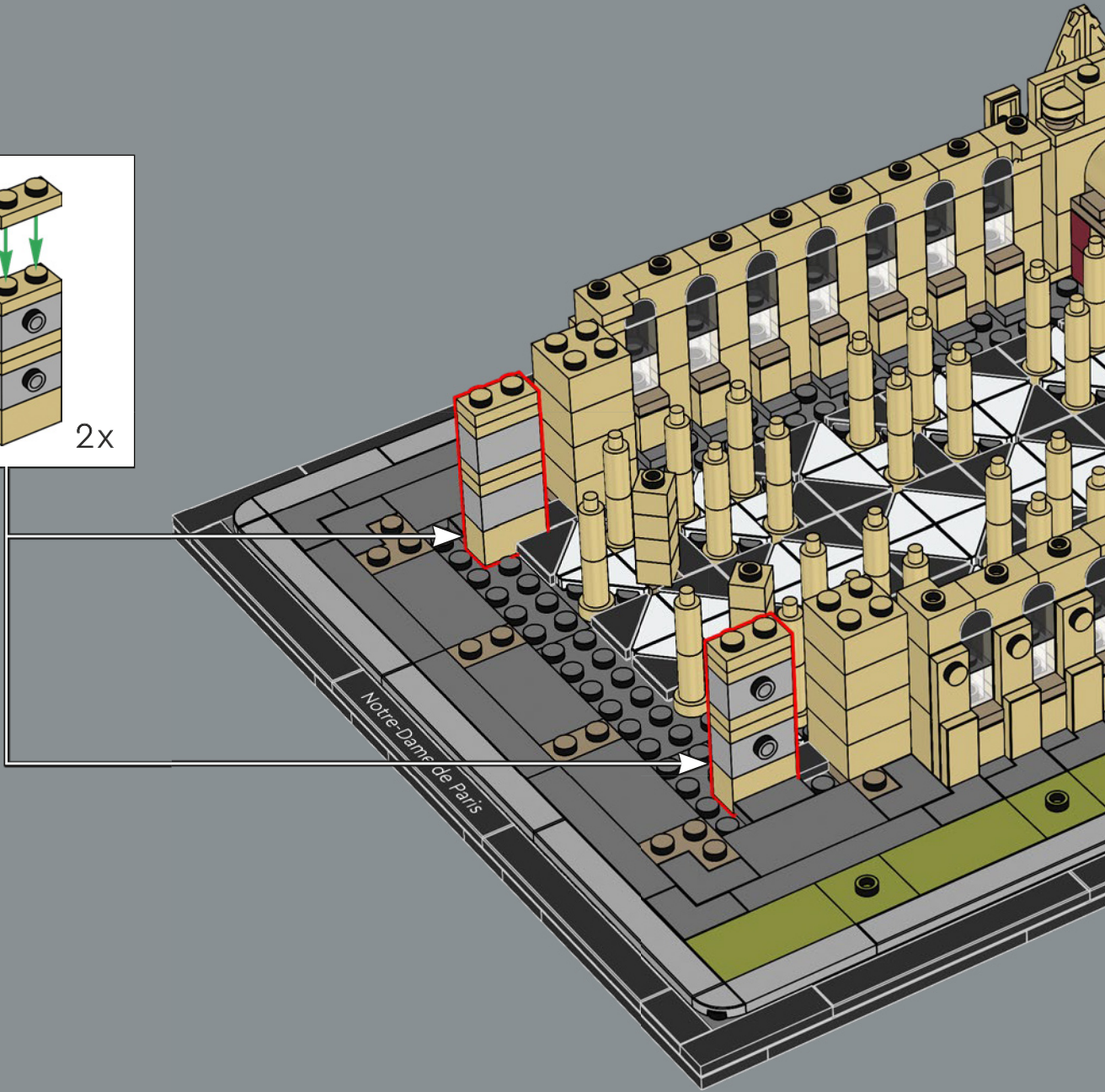
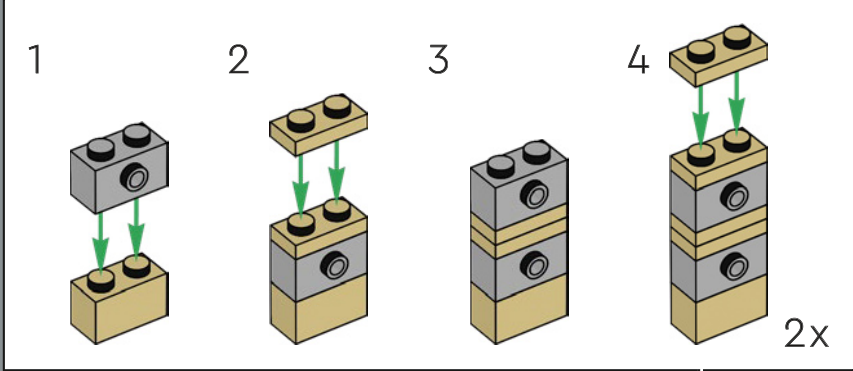

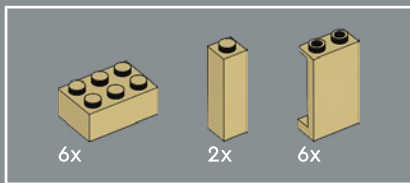

168

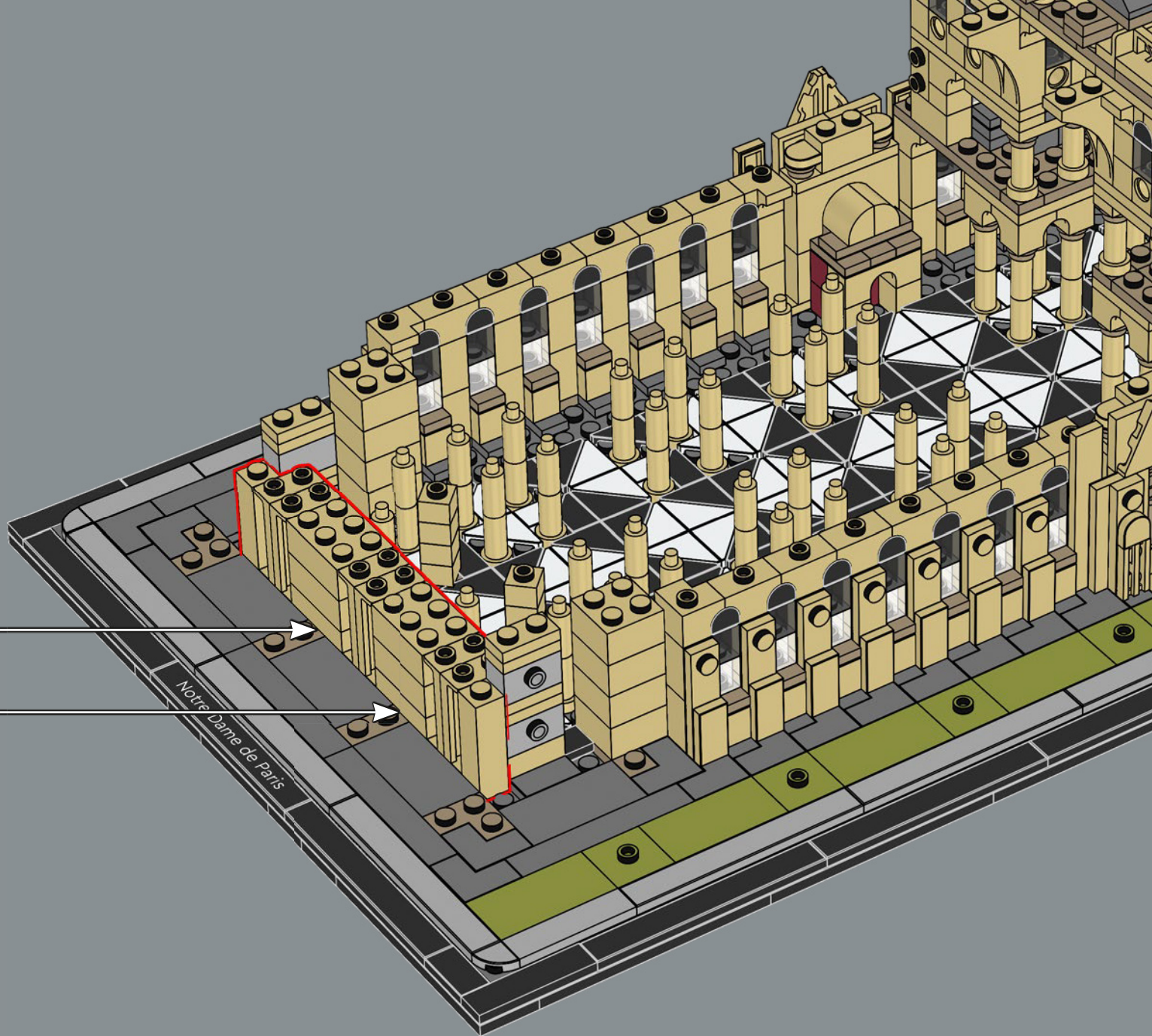
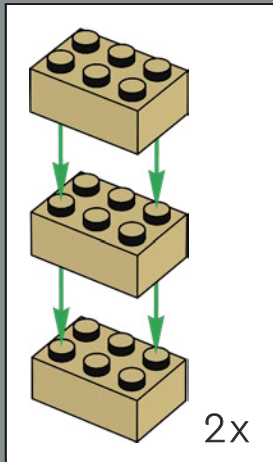

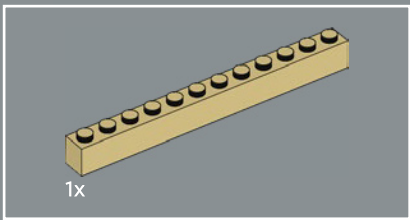

169

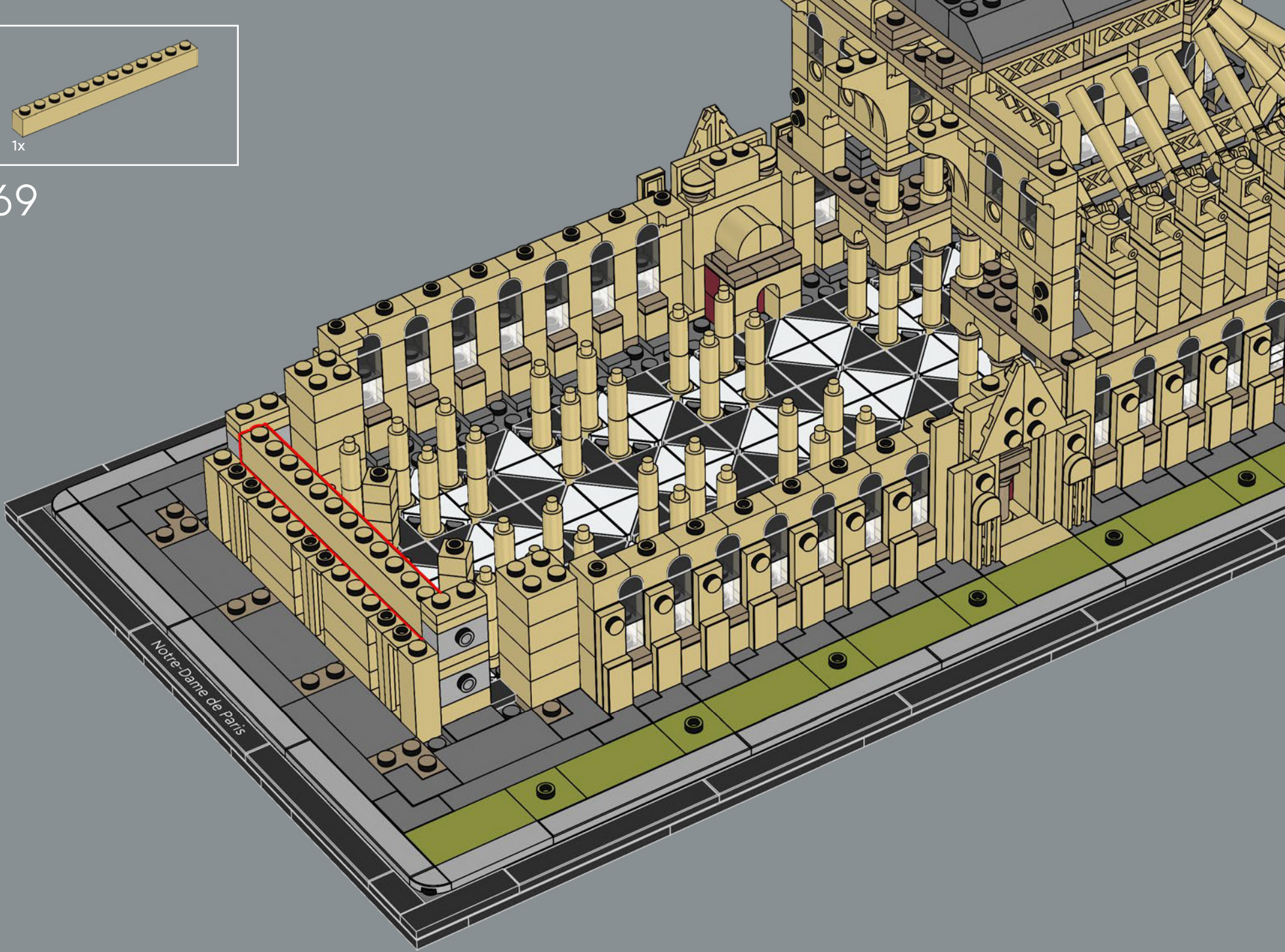

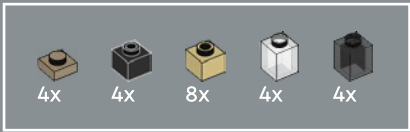

170

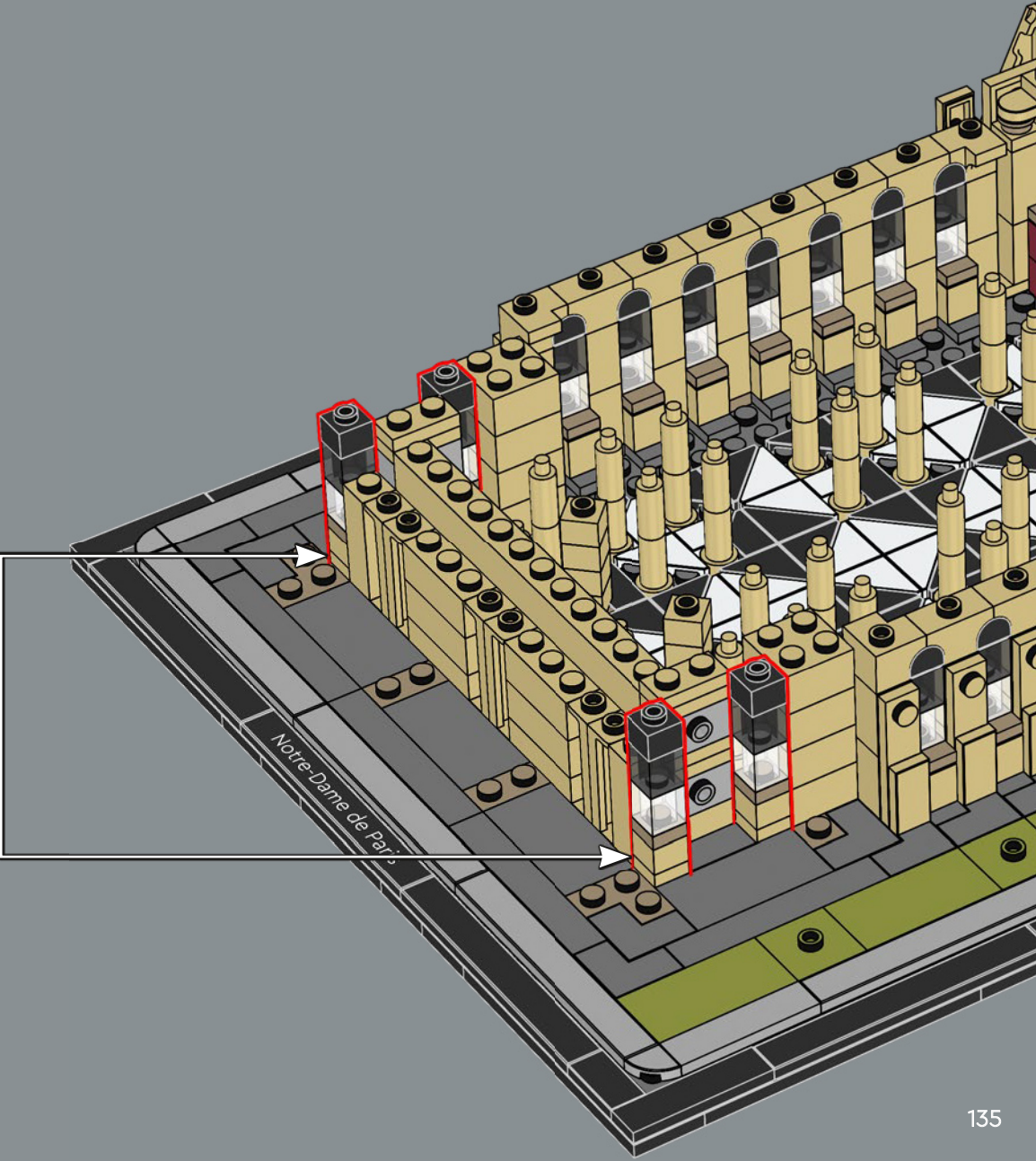
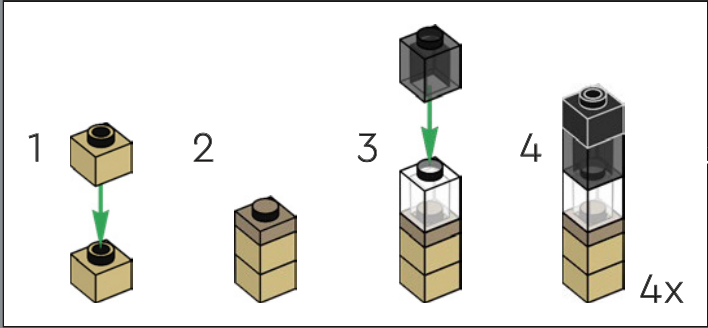

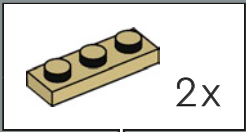
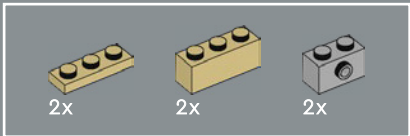

171

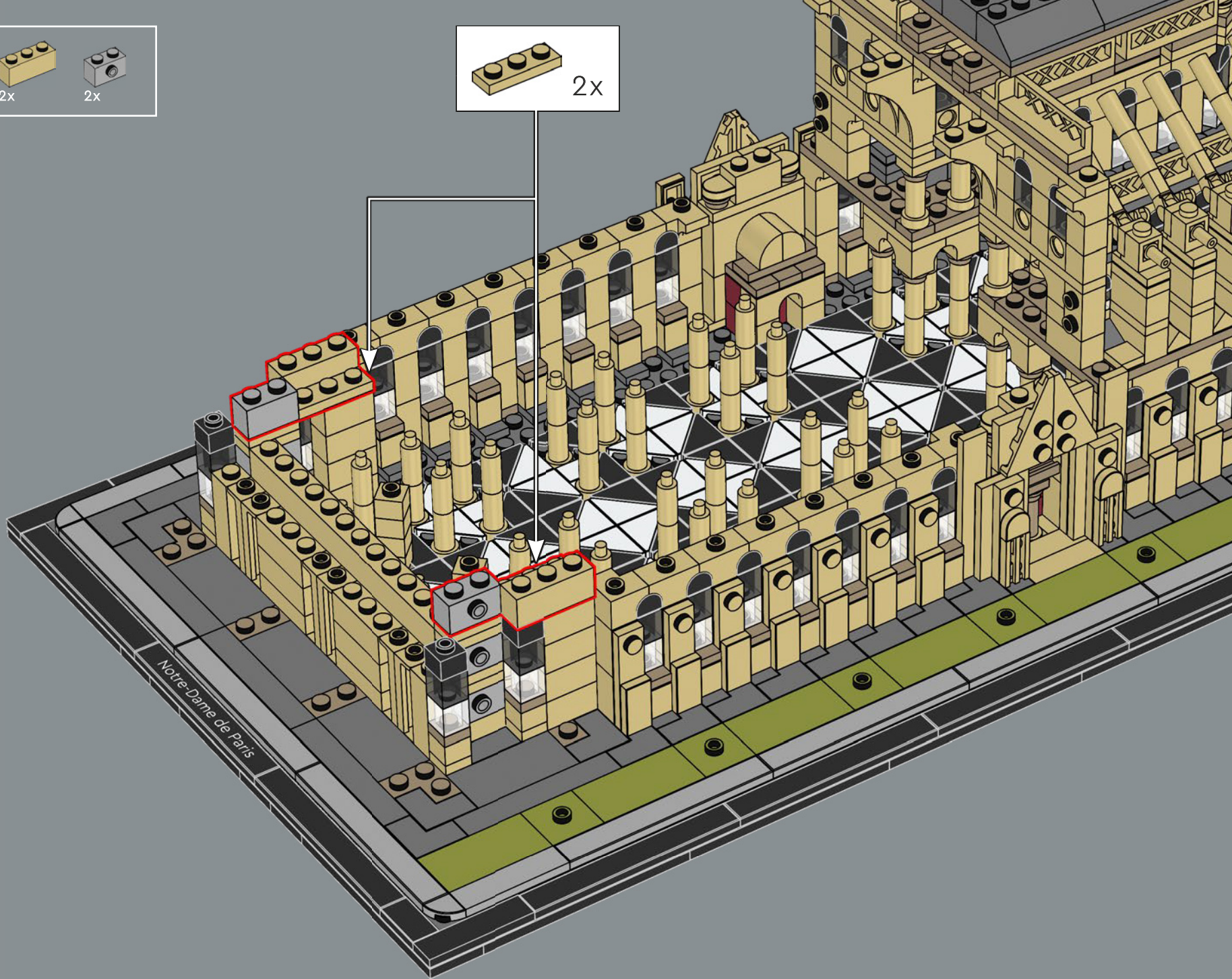

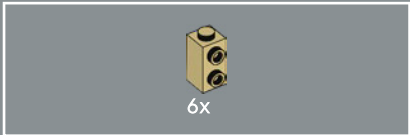

172

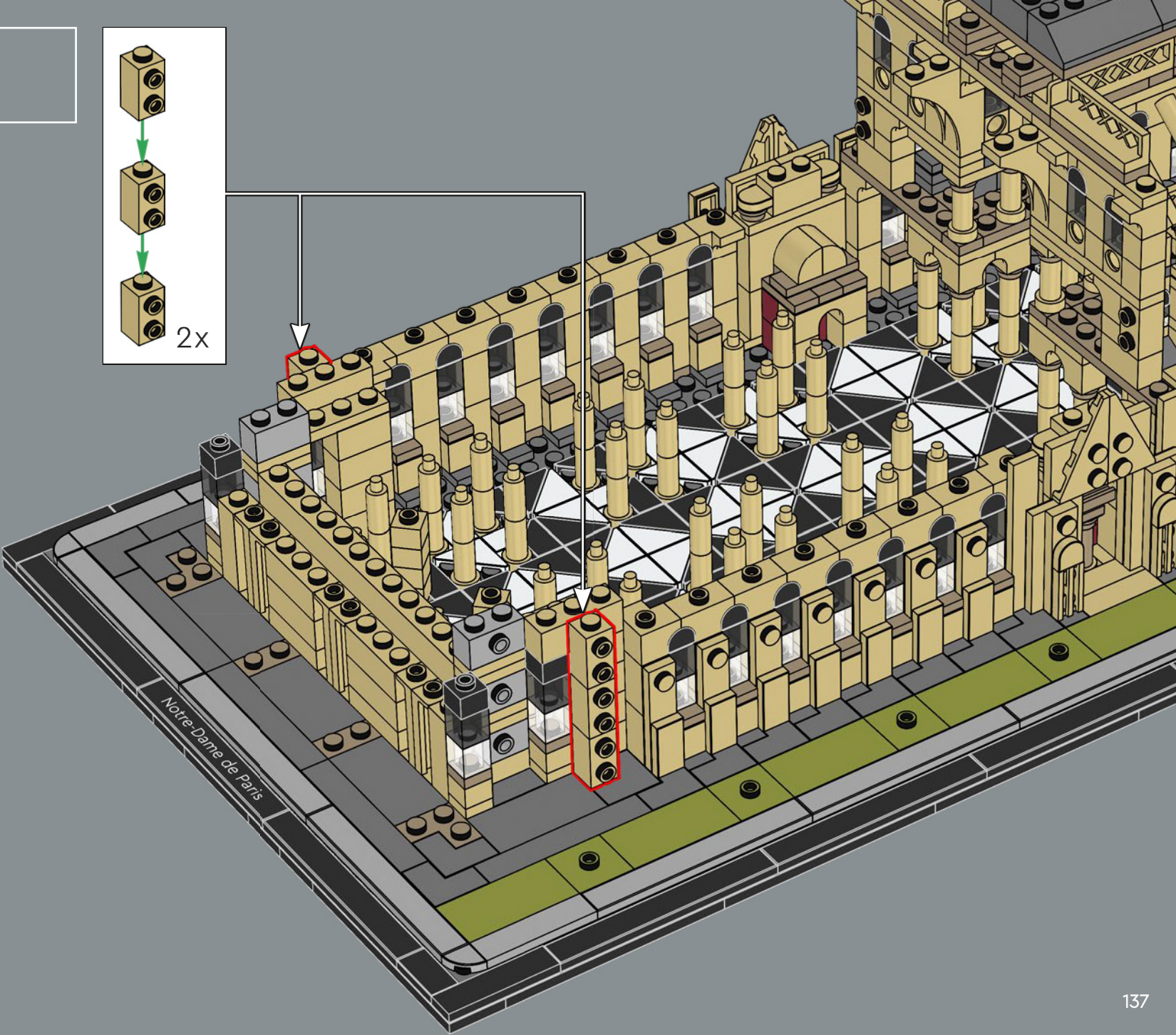
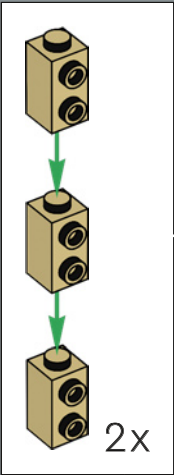

BUILDING TECHNIQUES AND FEATURES

✂ In 1208, construction of the transept was complete, with large, unique rose windows on the facades, all in different sizes and designs. The original north rose window has a diameter of 13.5 m (44.2 ft.), a record at that time. Every architectural feature in the cathedral serves a purpose, both decorative and practical. The three LEGO® rose window elements are an abstraction of the originals – they are all the same size and design, and you can use them interchangeably in the model. By 1220, the body of the cathedral is complete except for the upper part of the towers.



By evacuating rainwater, the characteristic gargoyles also serve to protect the cathedral from damage caused by excessive runoff. You can see this feature replicated in your model.

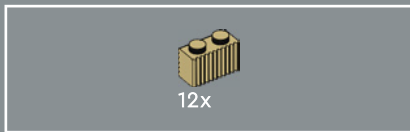

173

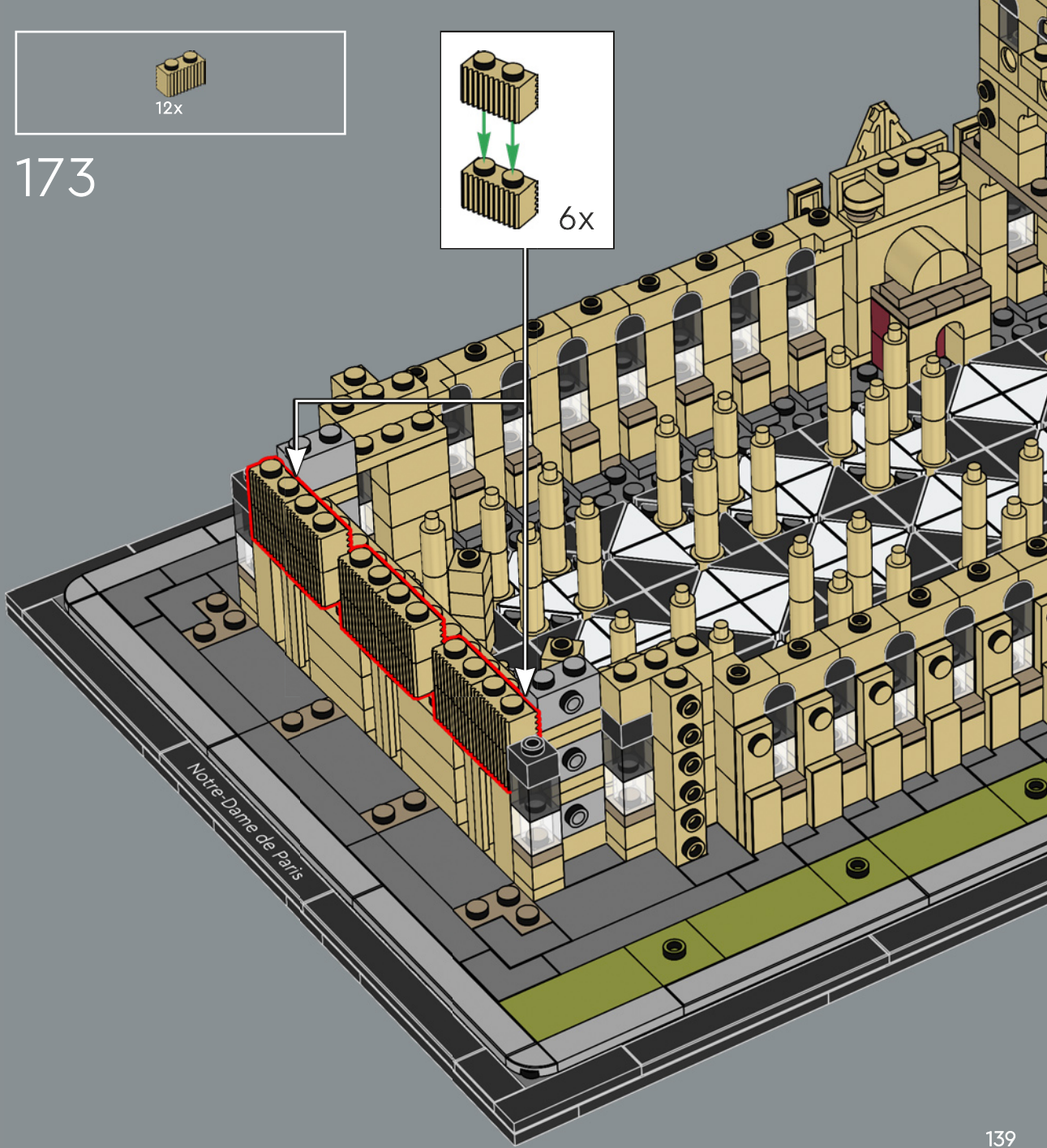
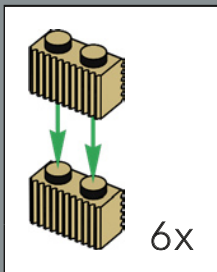

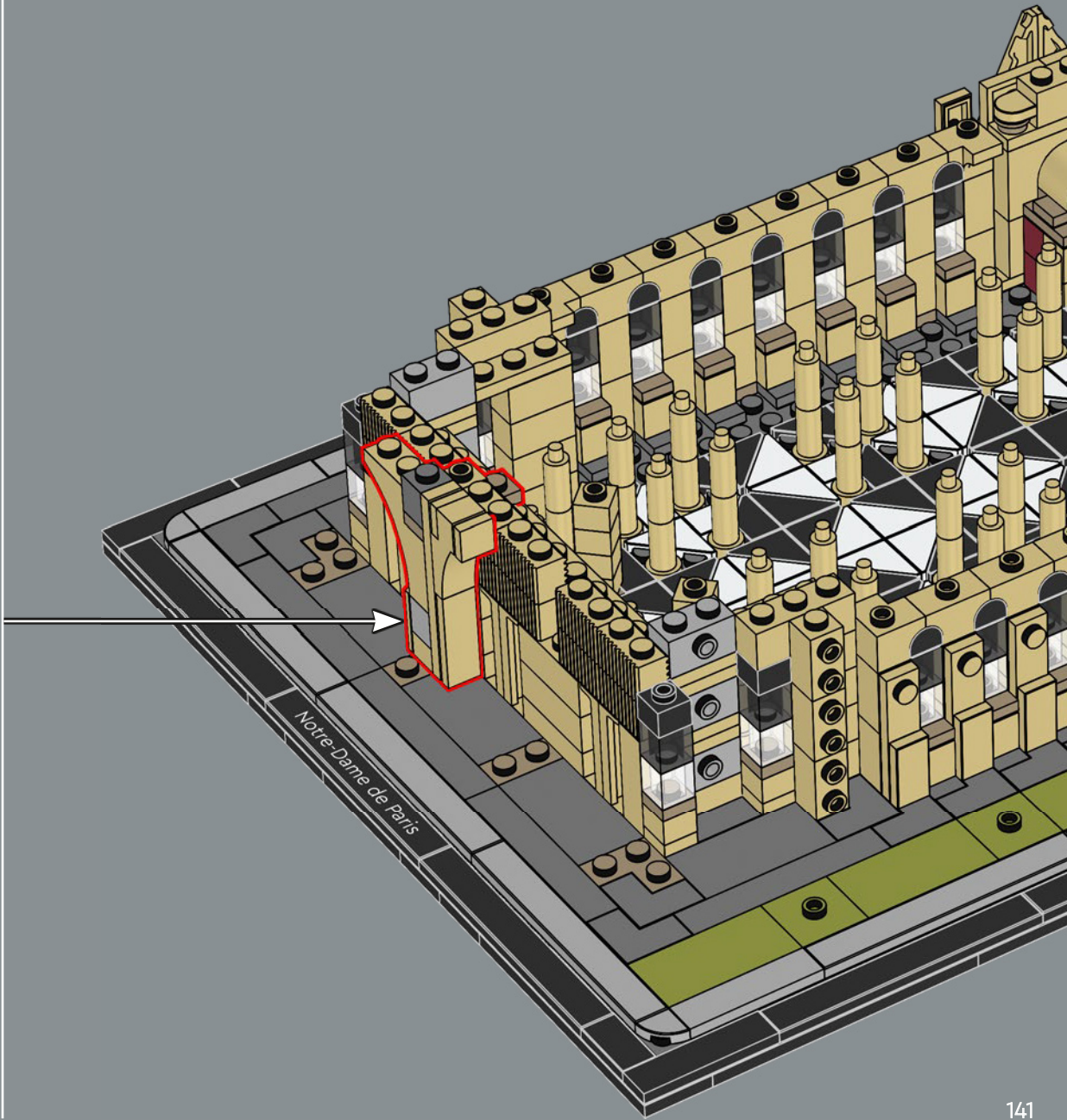
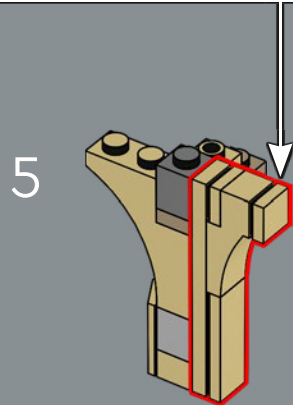
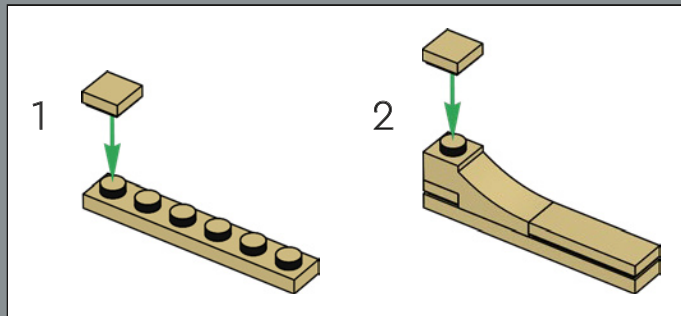

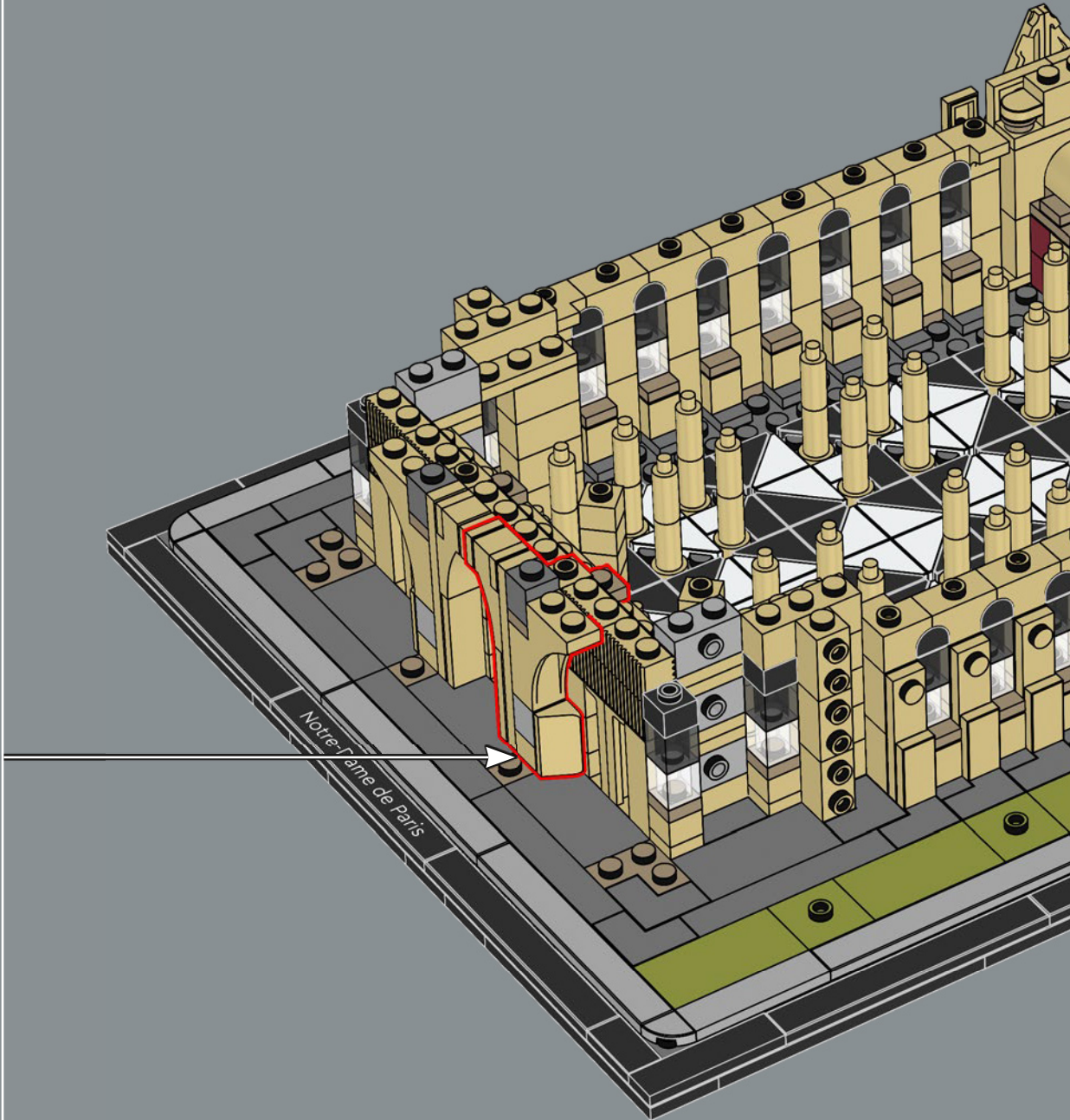
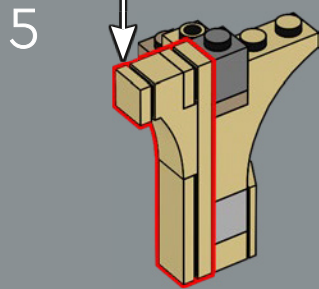
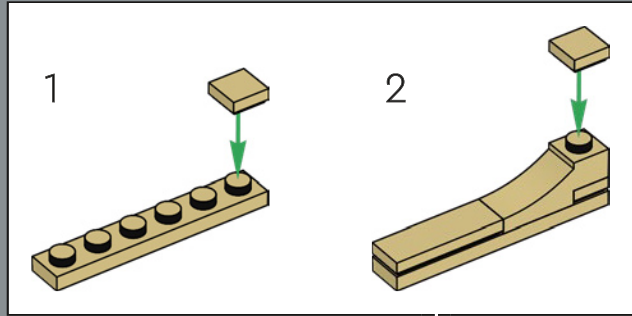

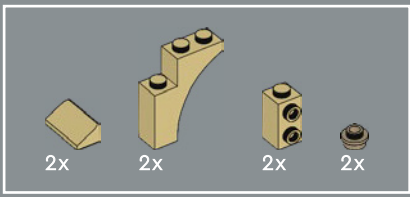

176

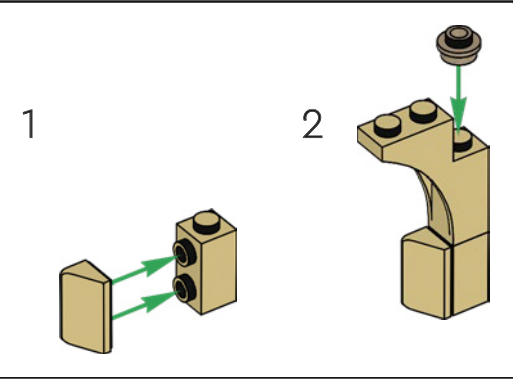
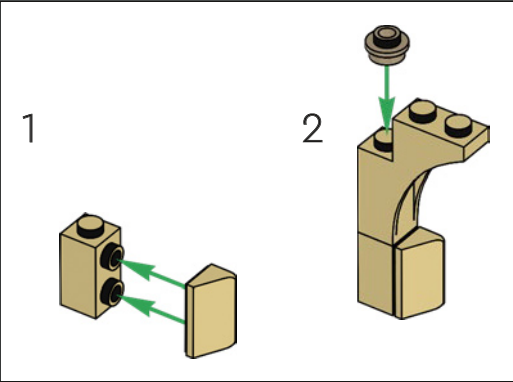

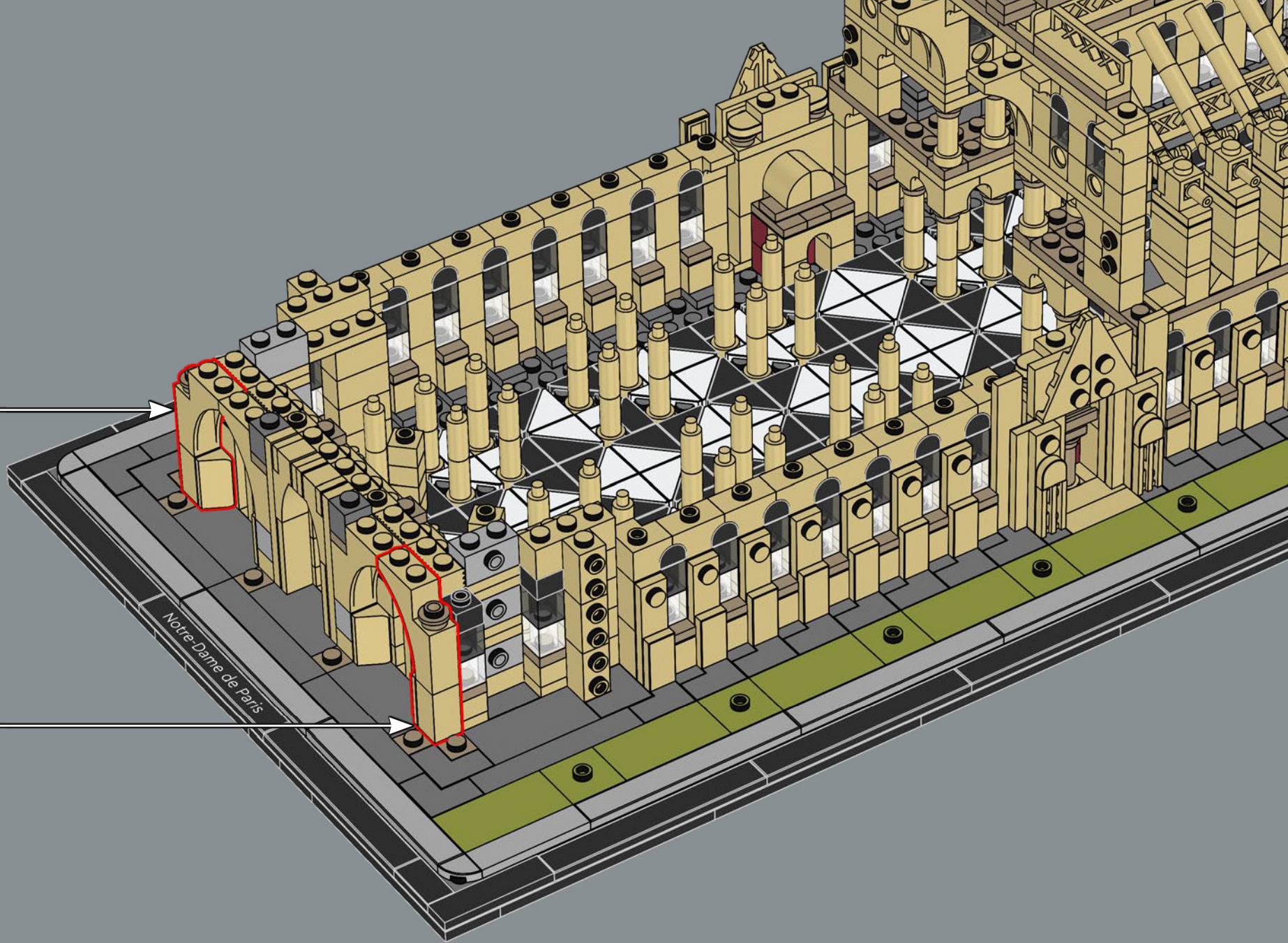

Notre-Dame de Paris

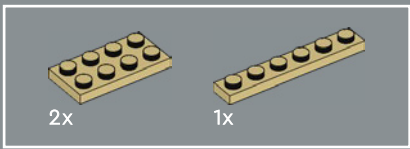

177



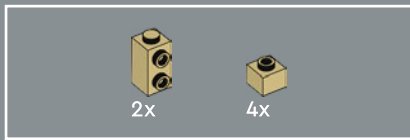

178

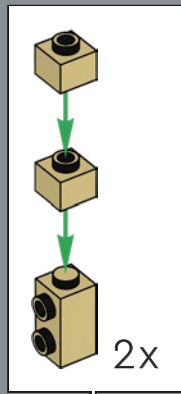

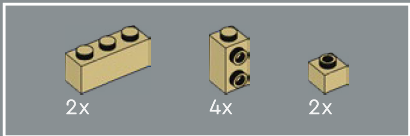

179

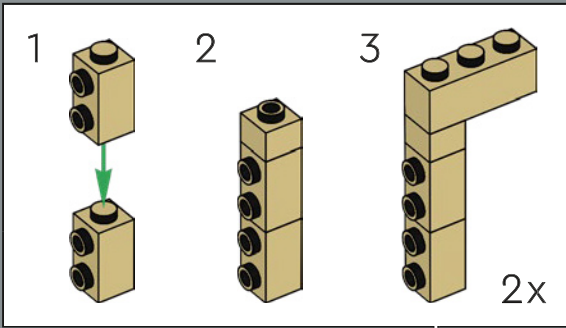

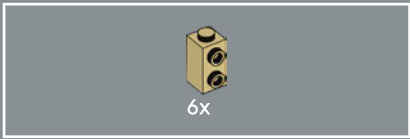

180

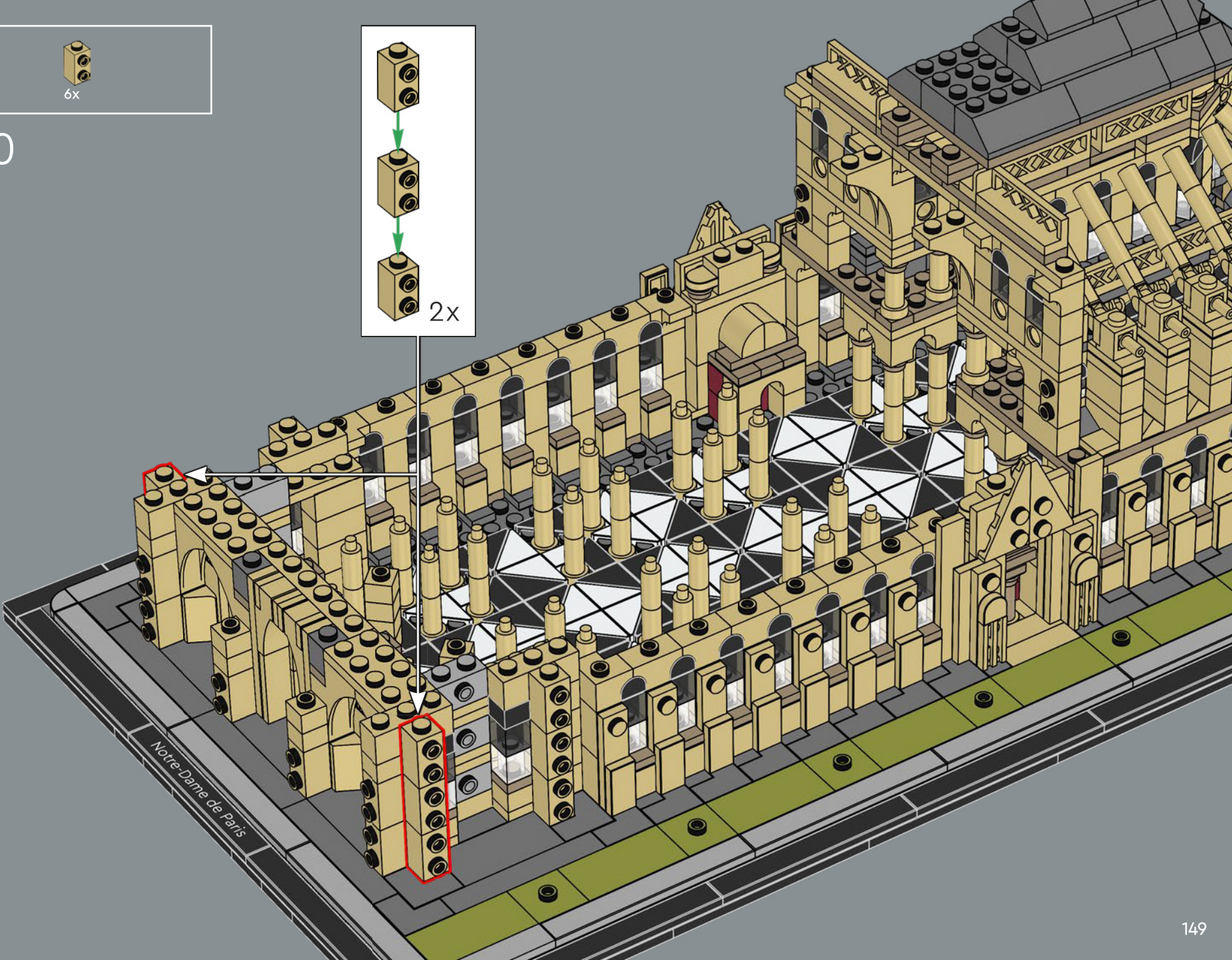
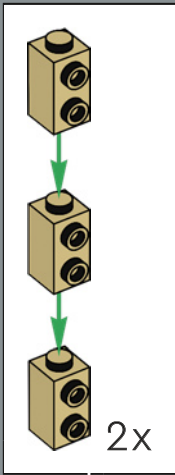

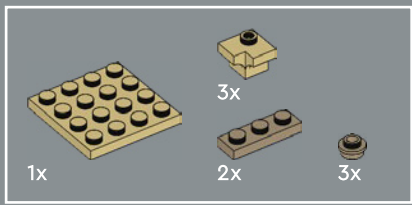

181

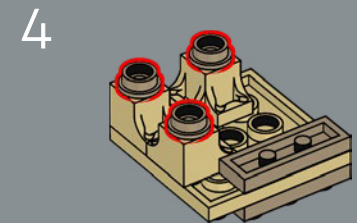
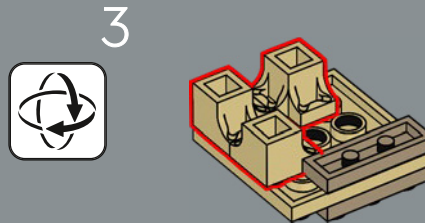
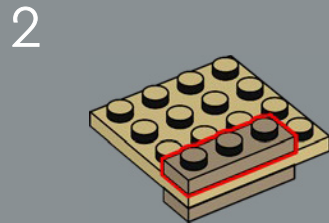
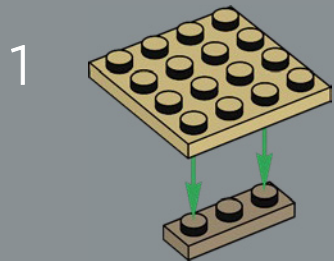

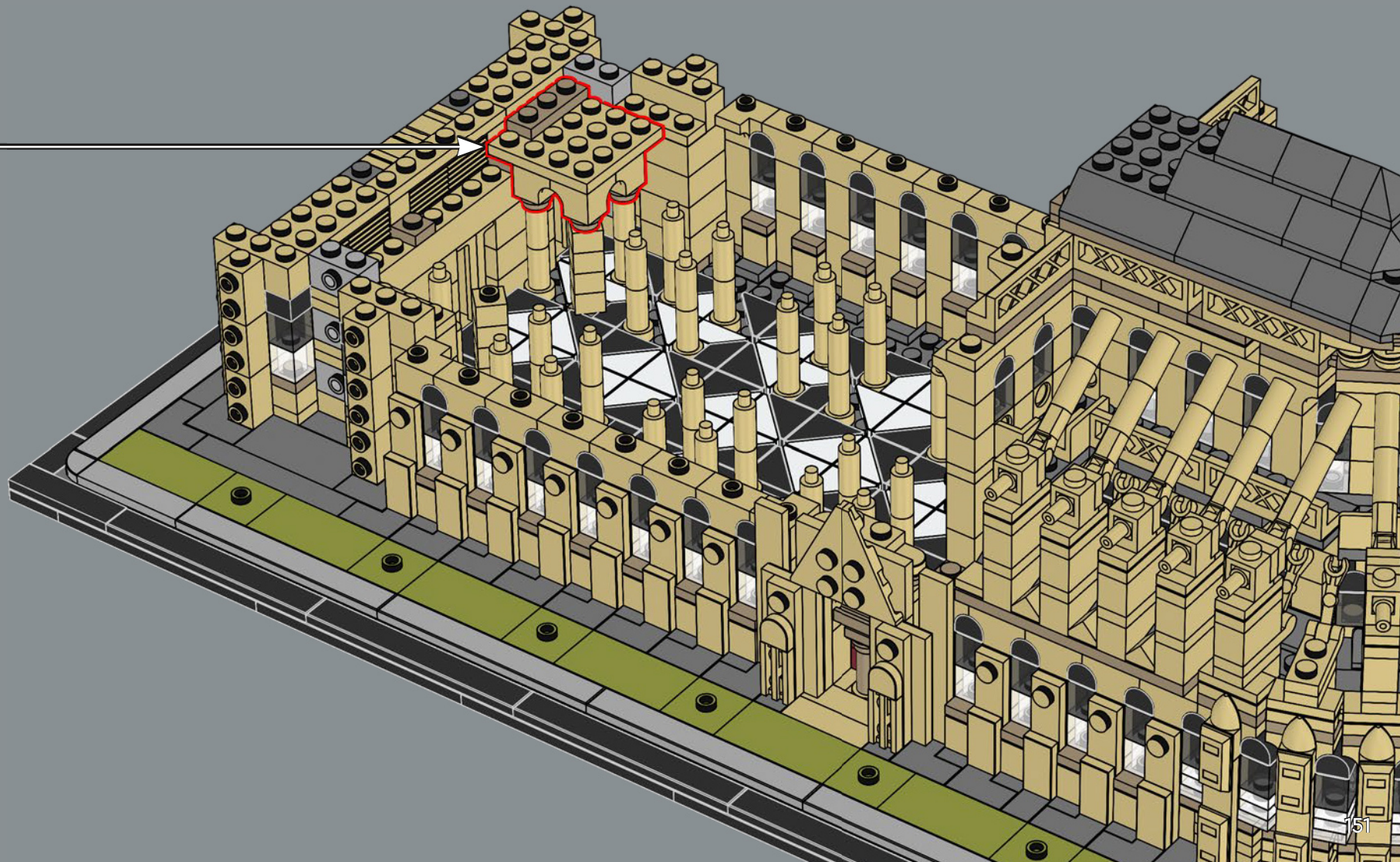

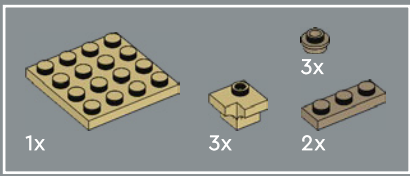

182

1

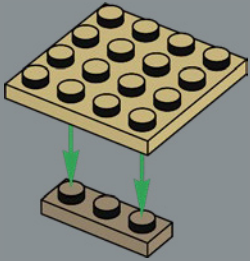

2

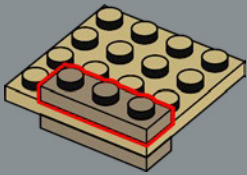

3

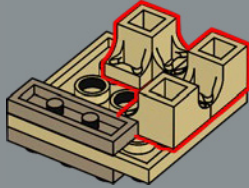

4

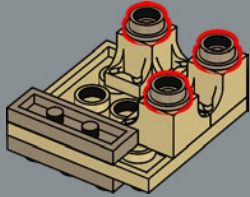



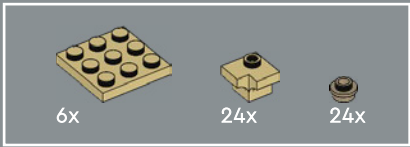

183

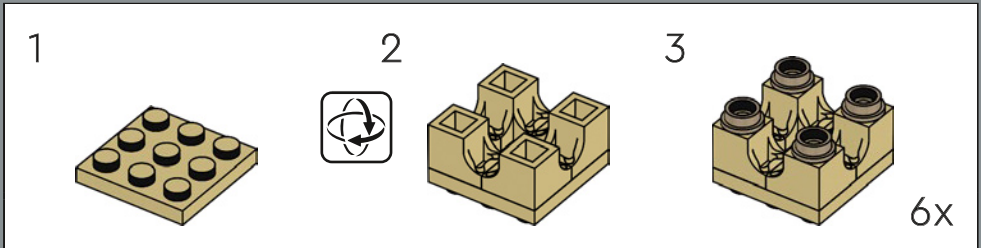

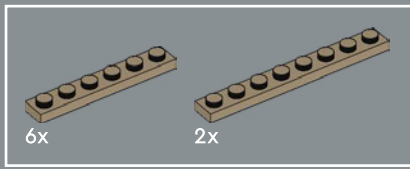

184



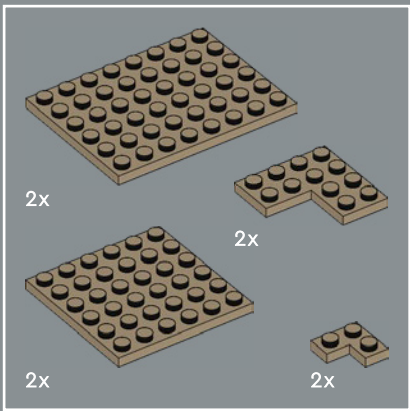

185

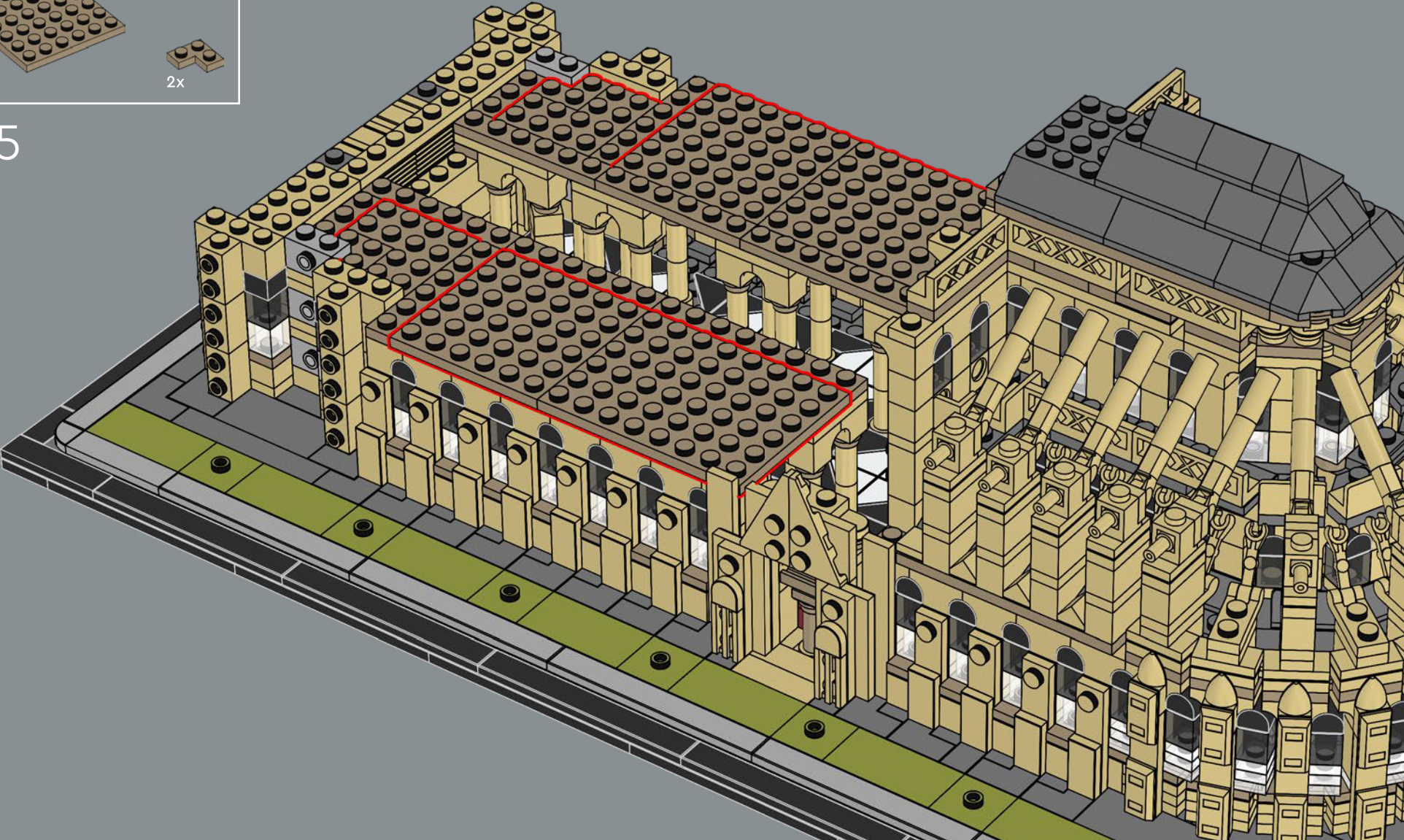

2x 2x 12x

186



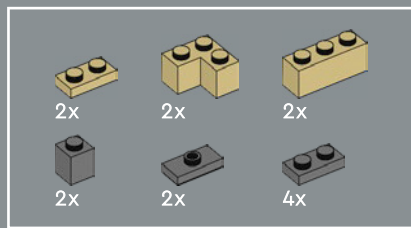

187

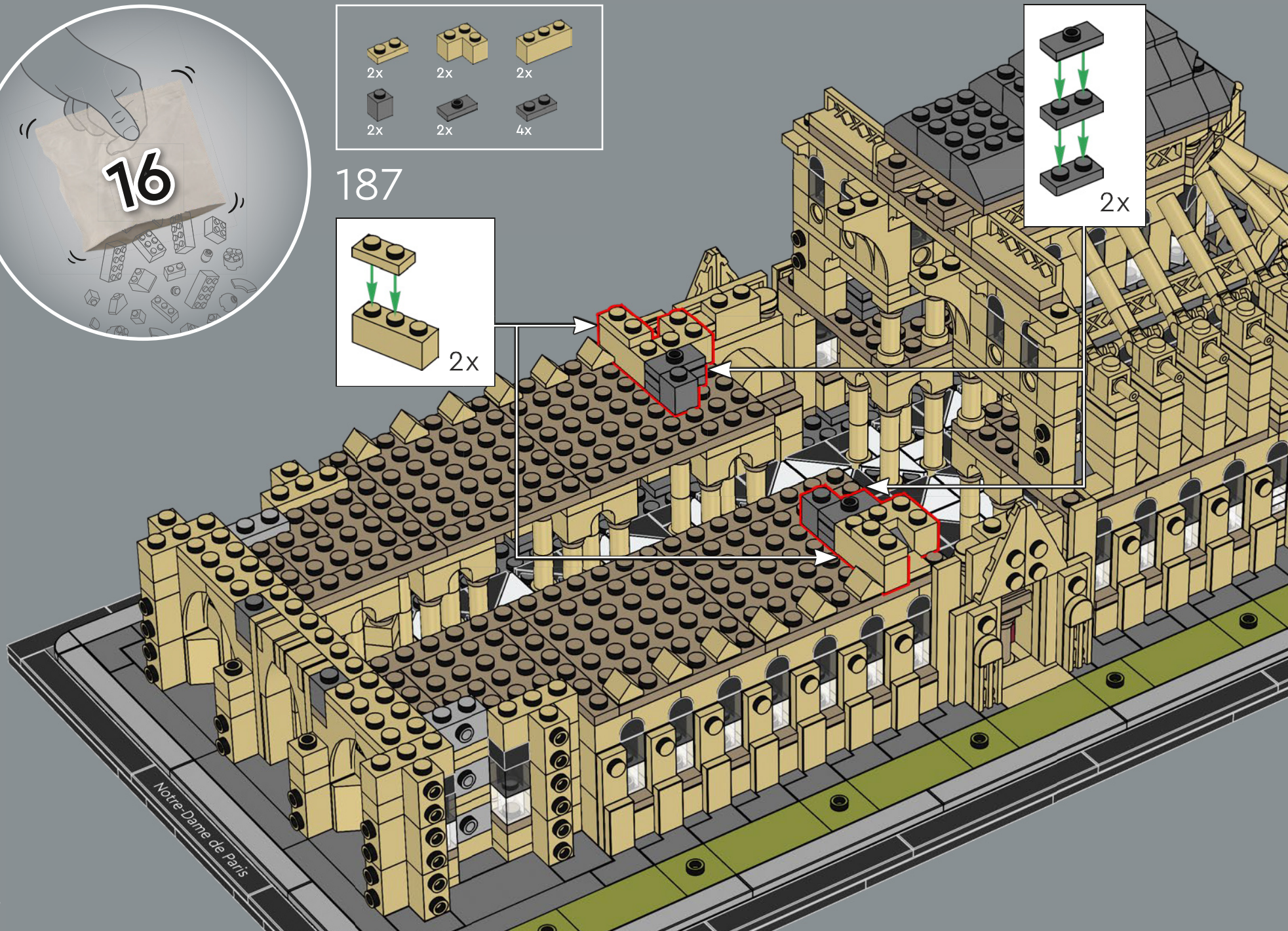
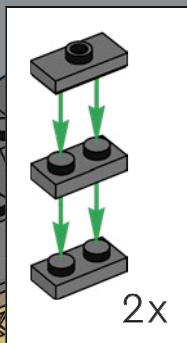
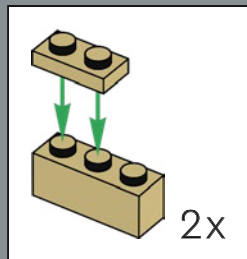

Notre-Dame de Paris

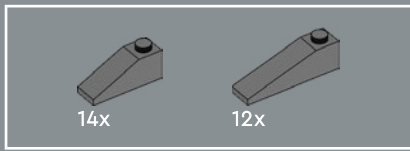

188

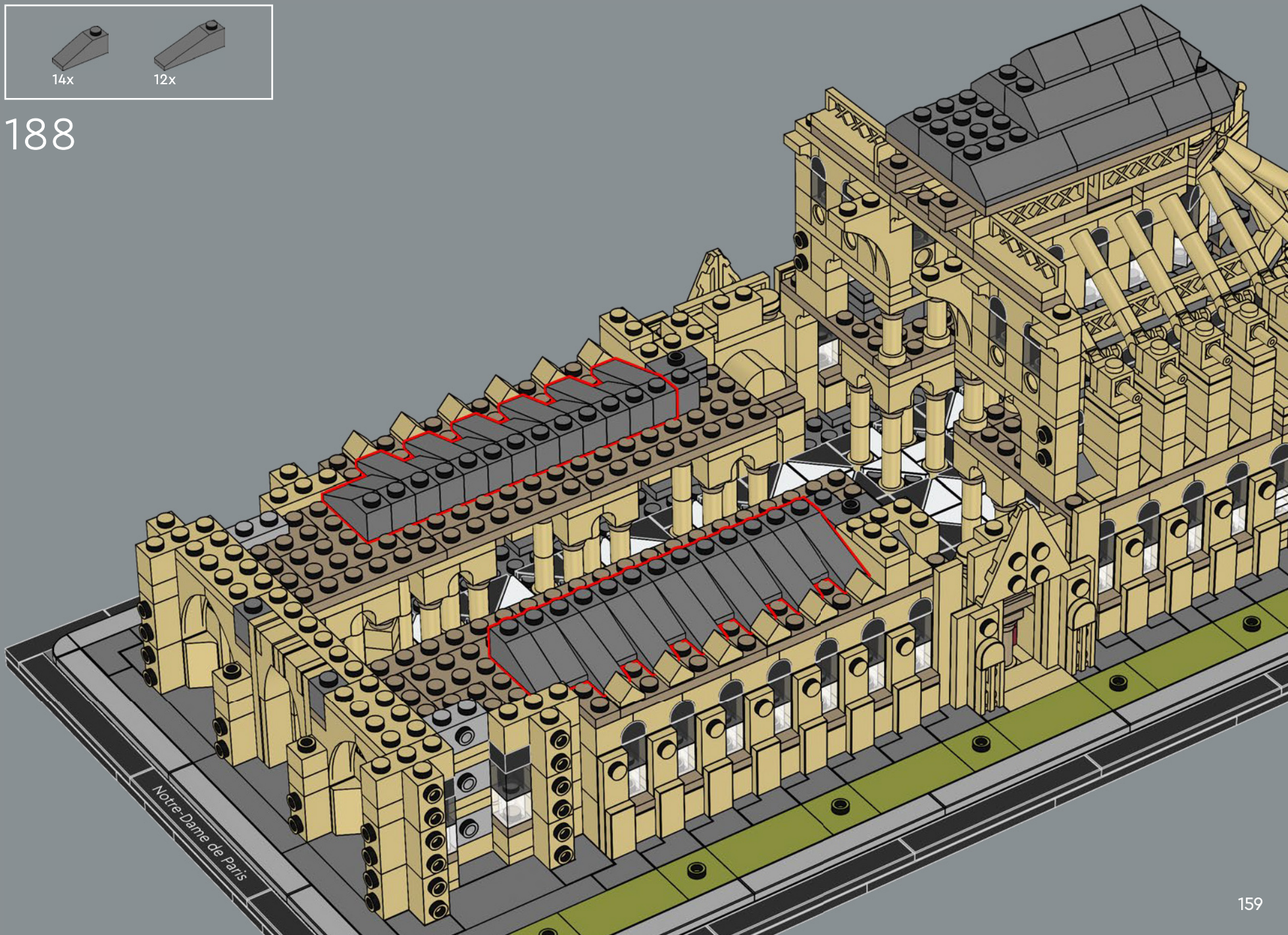

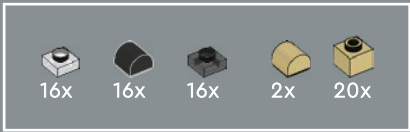

189

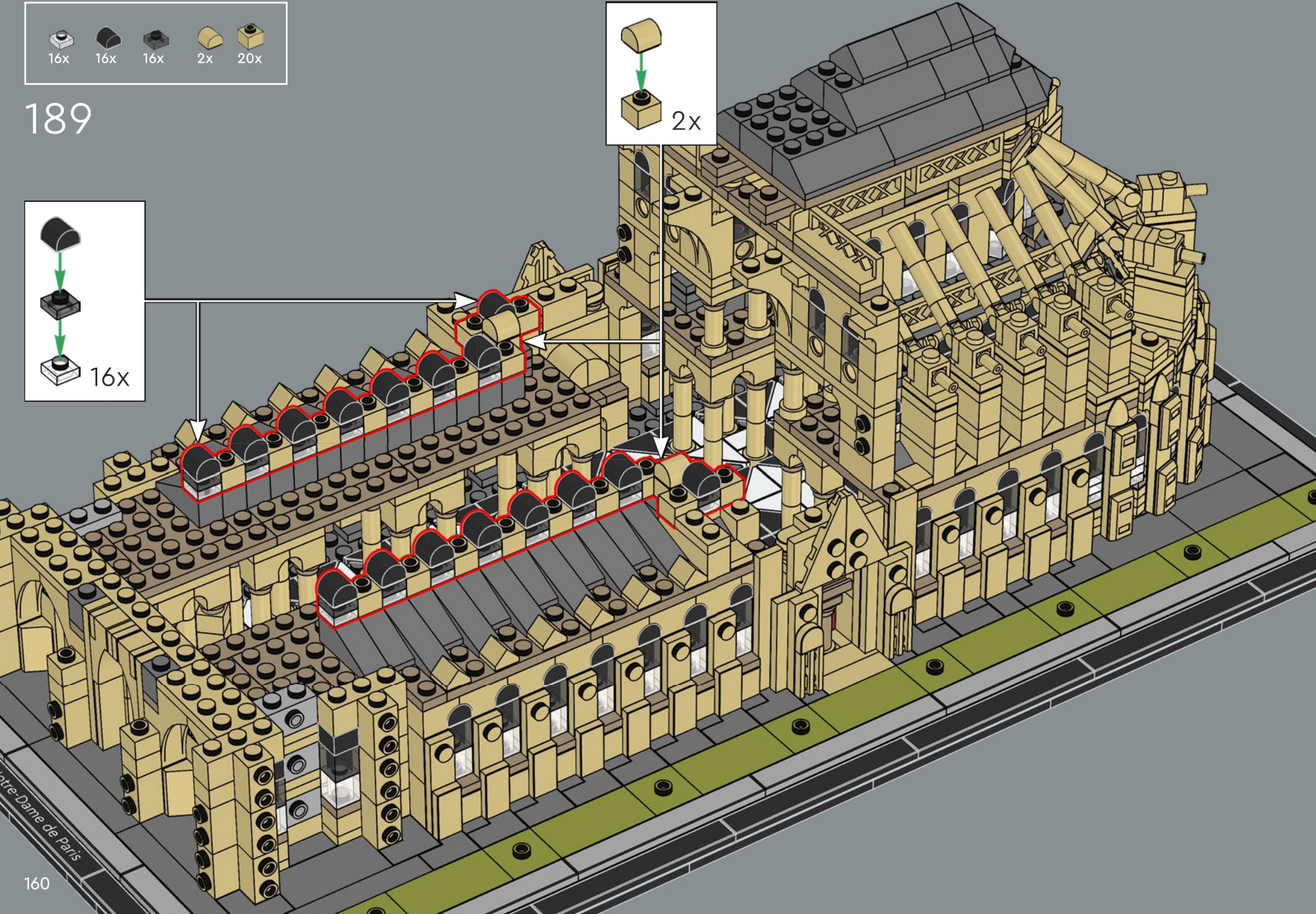
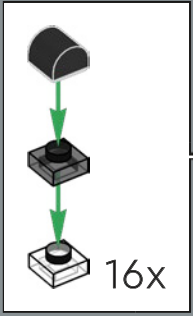
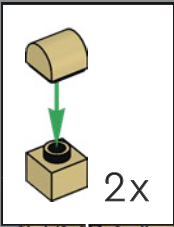

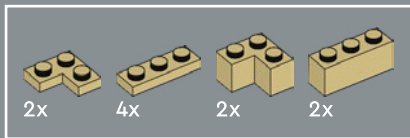

190

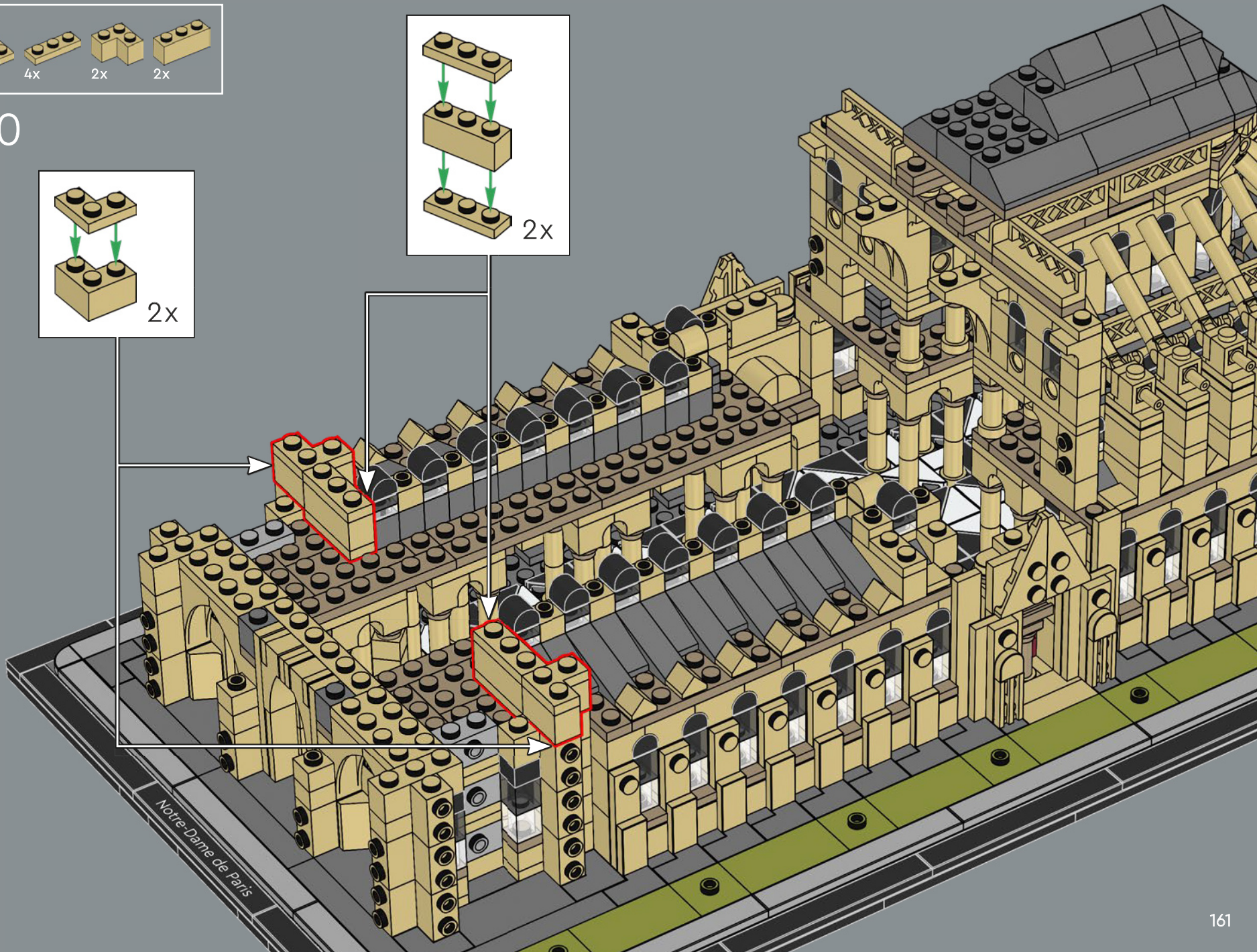
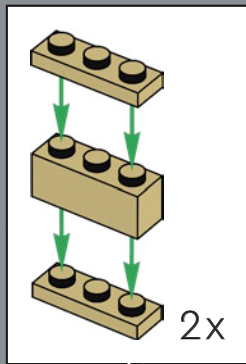
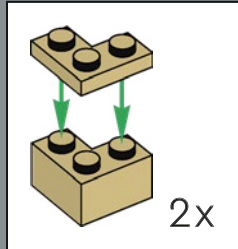



6x

191

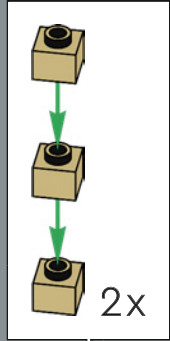

Notre-Dame de Paris

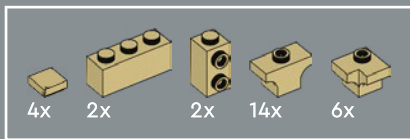

192

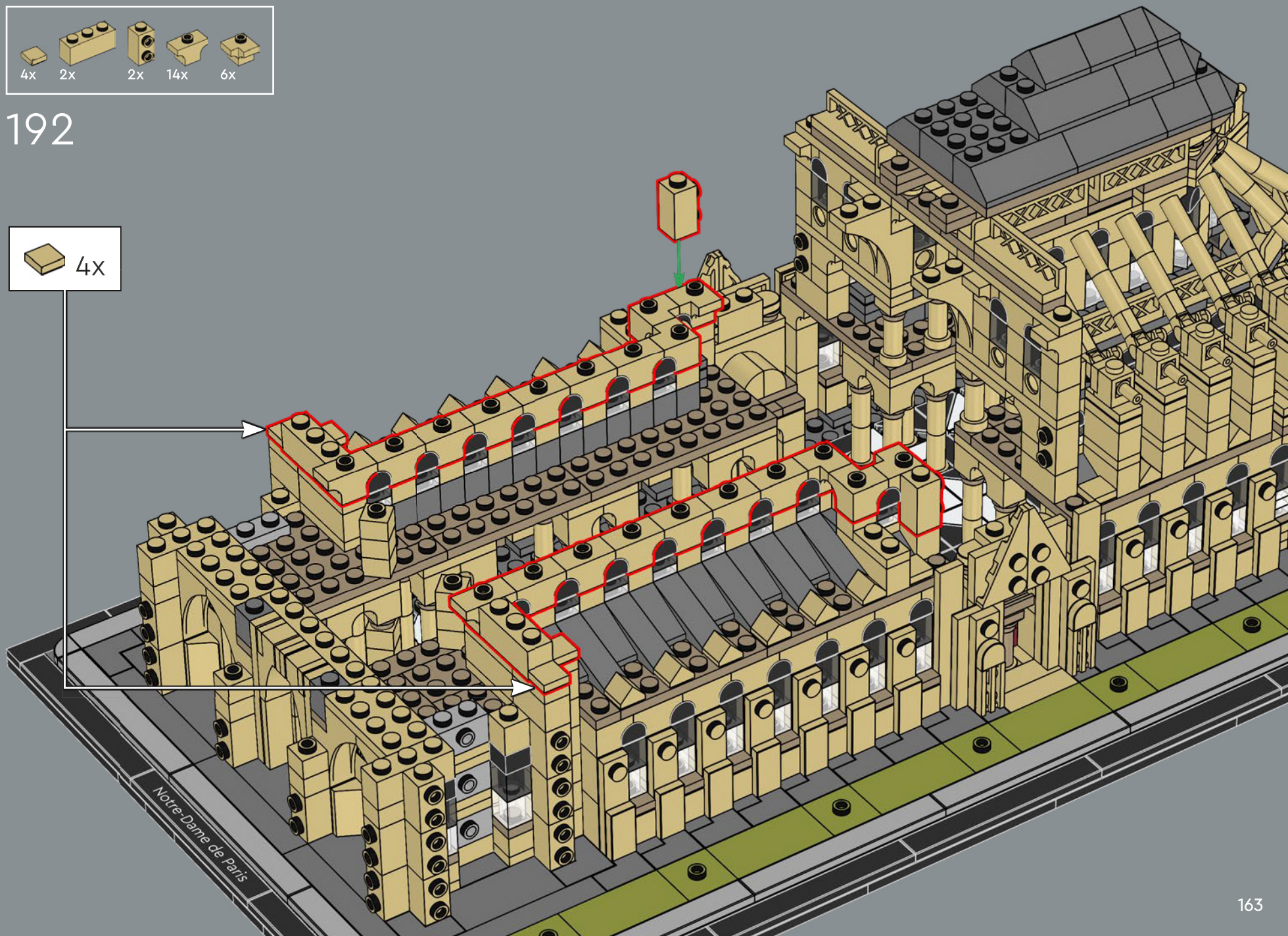

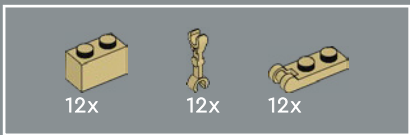

193

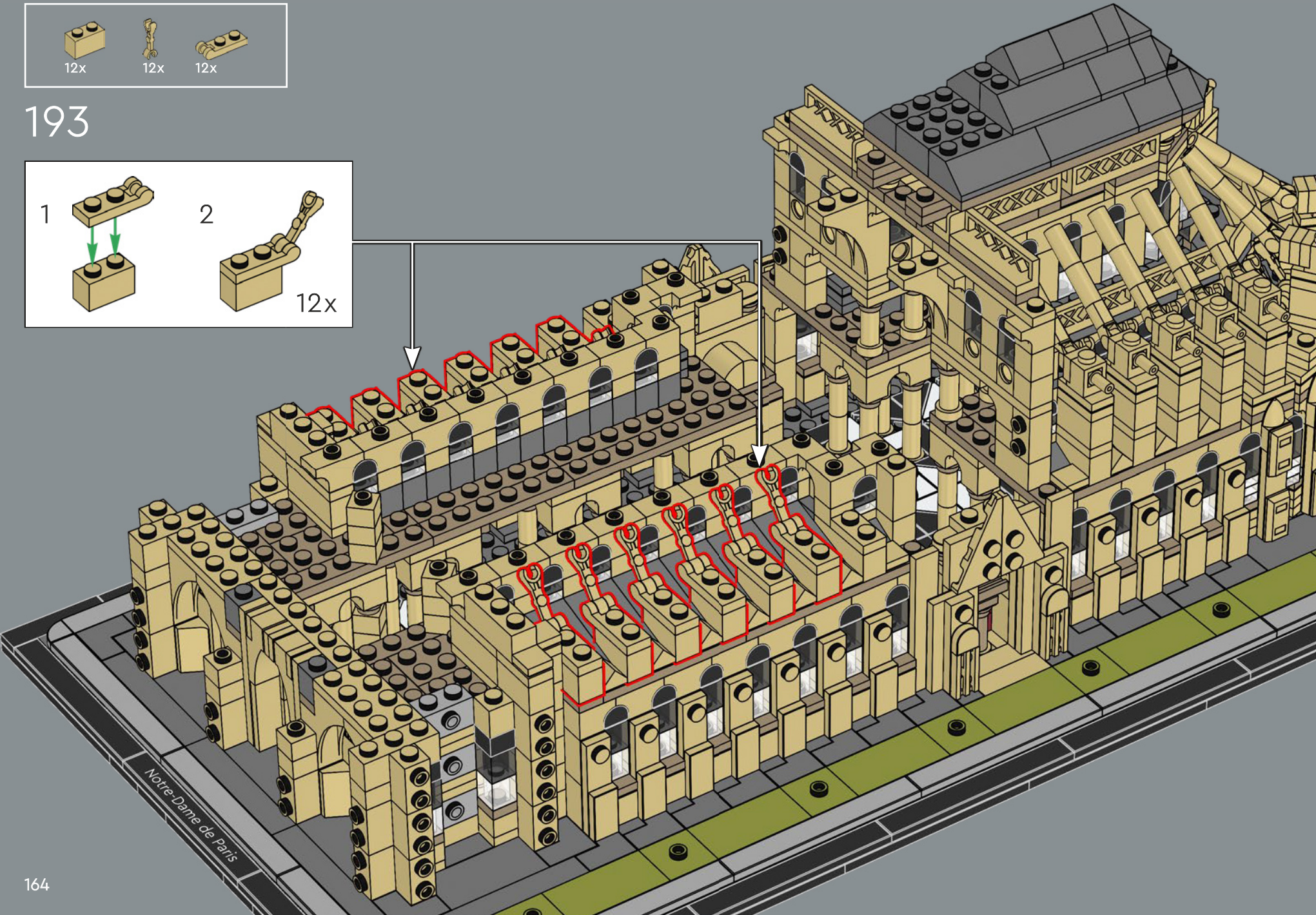
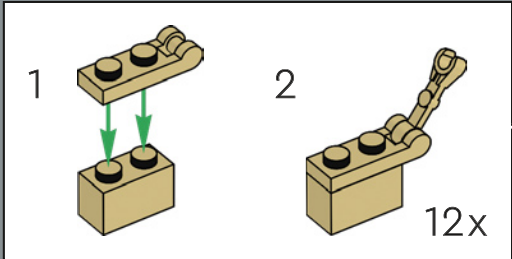



194

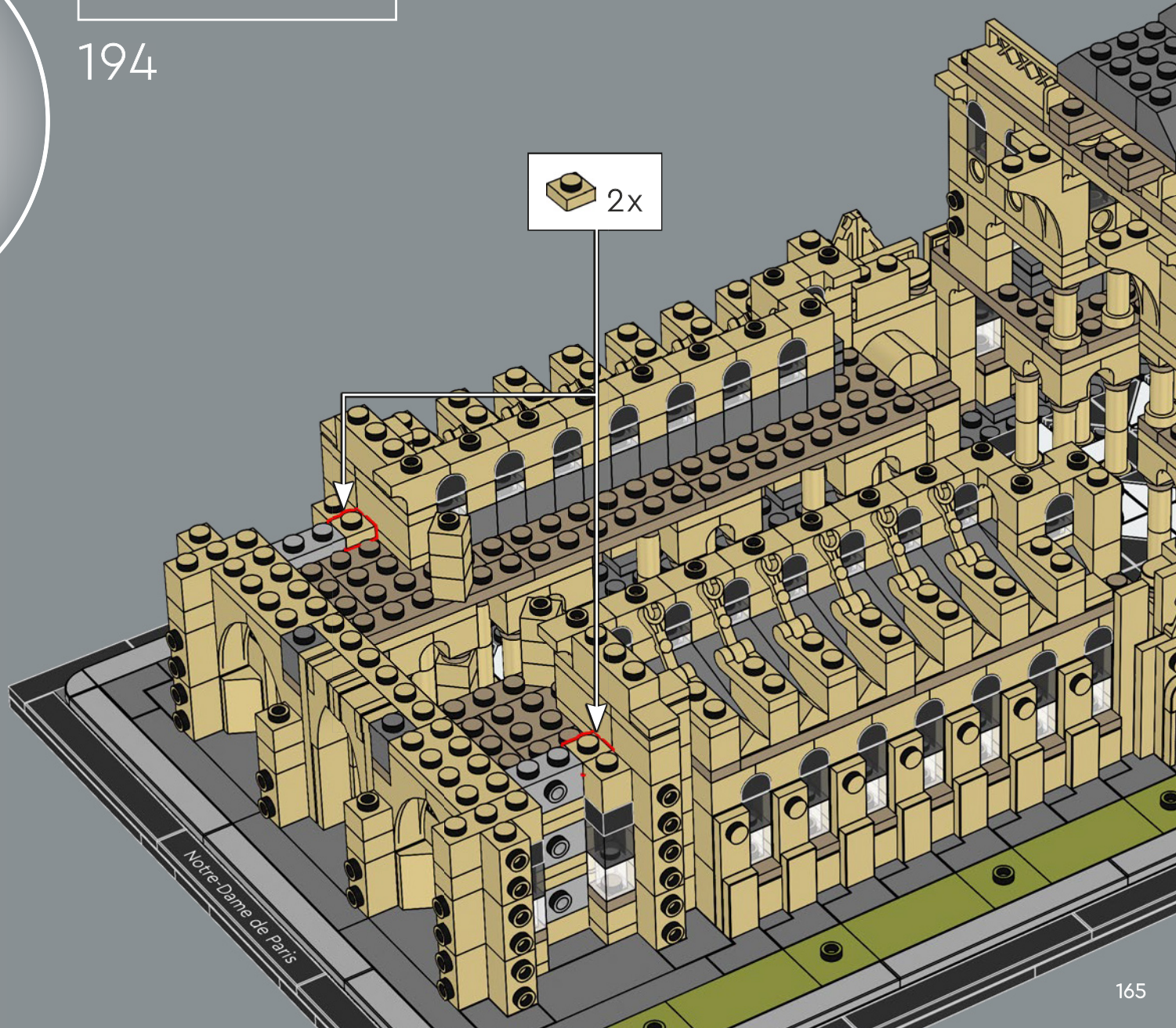

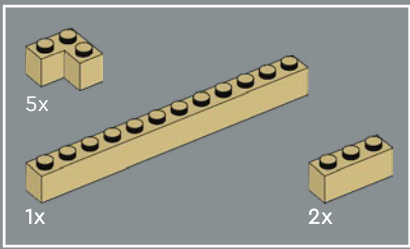

195

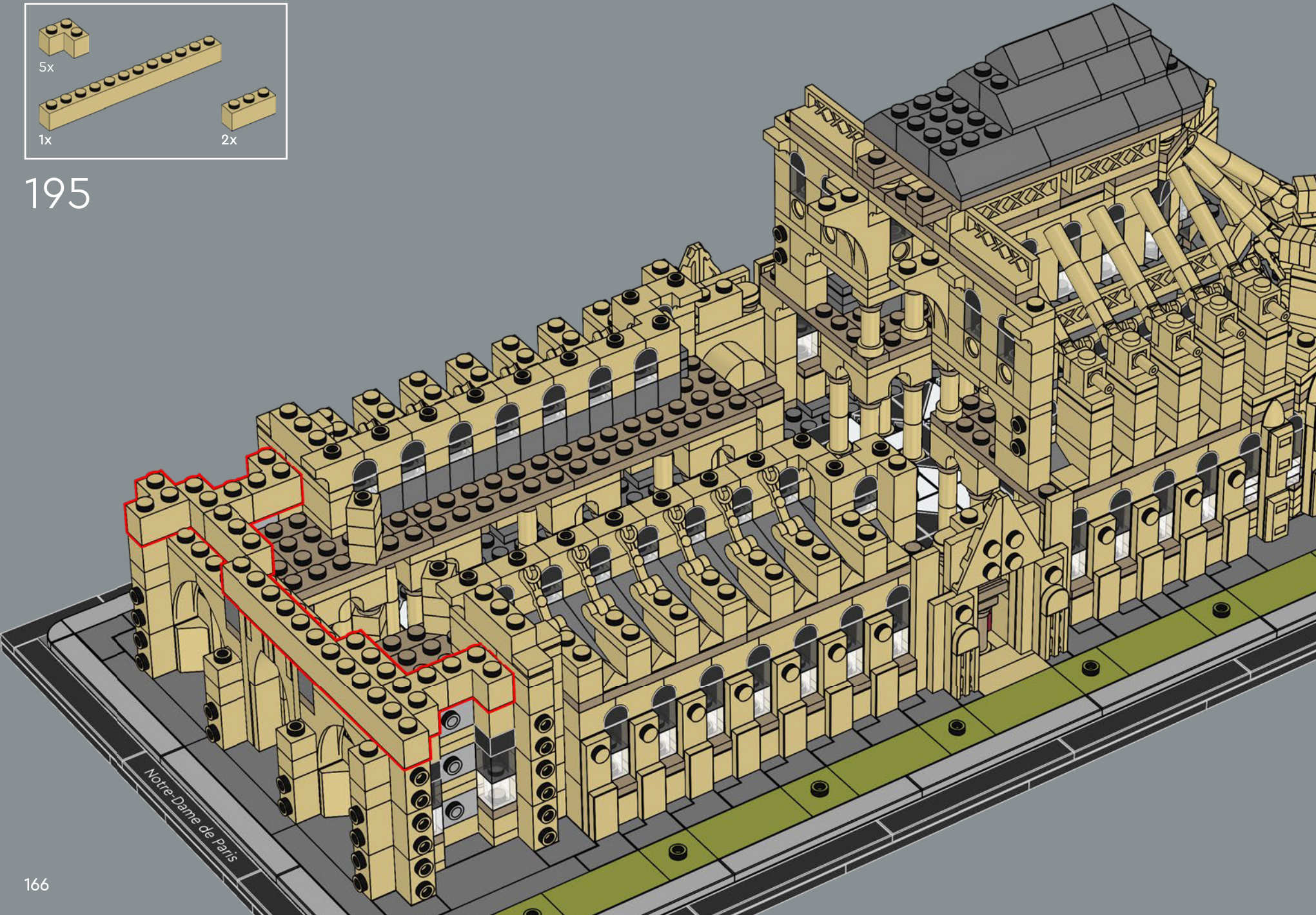

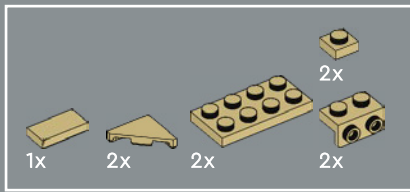

196

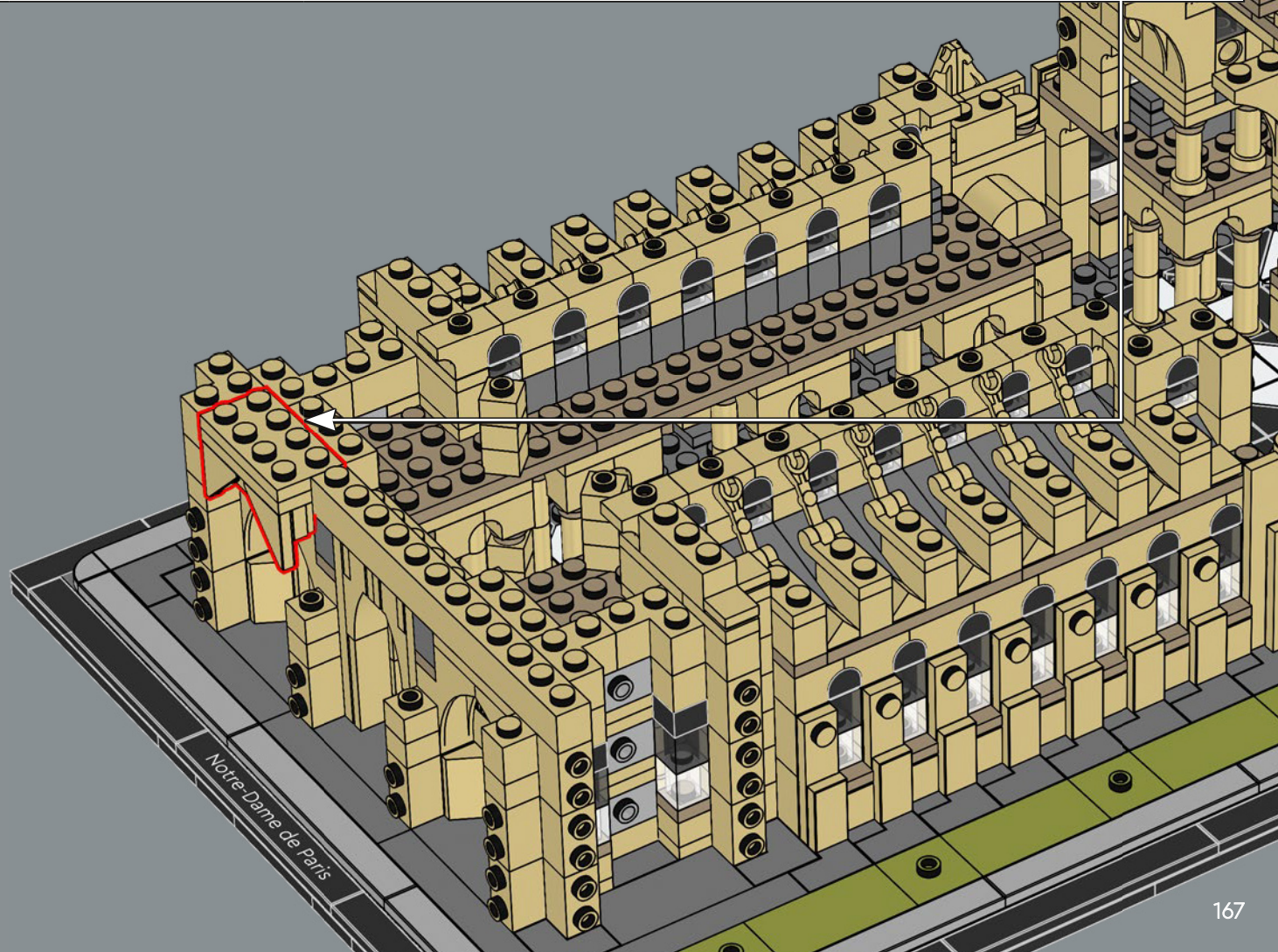
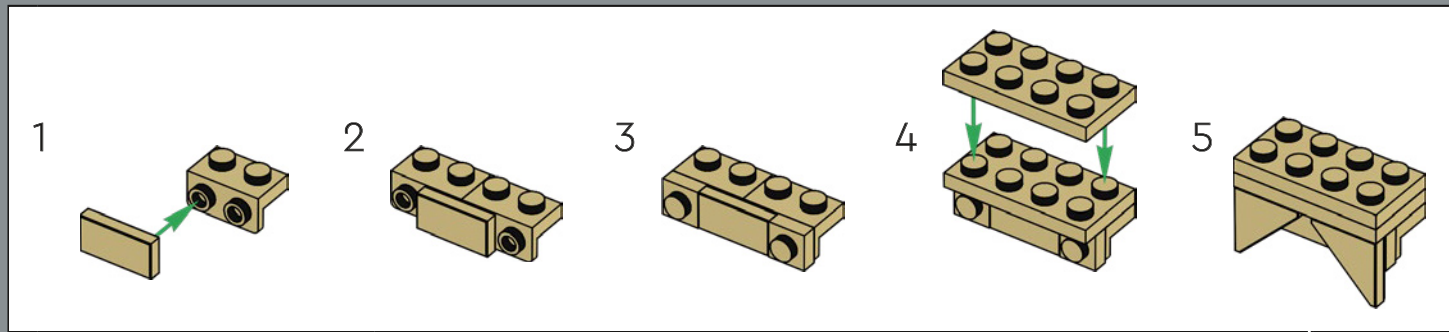

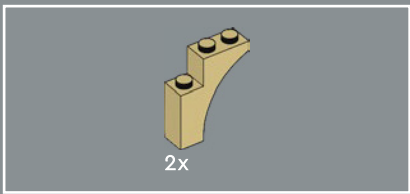

197

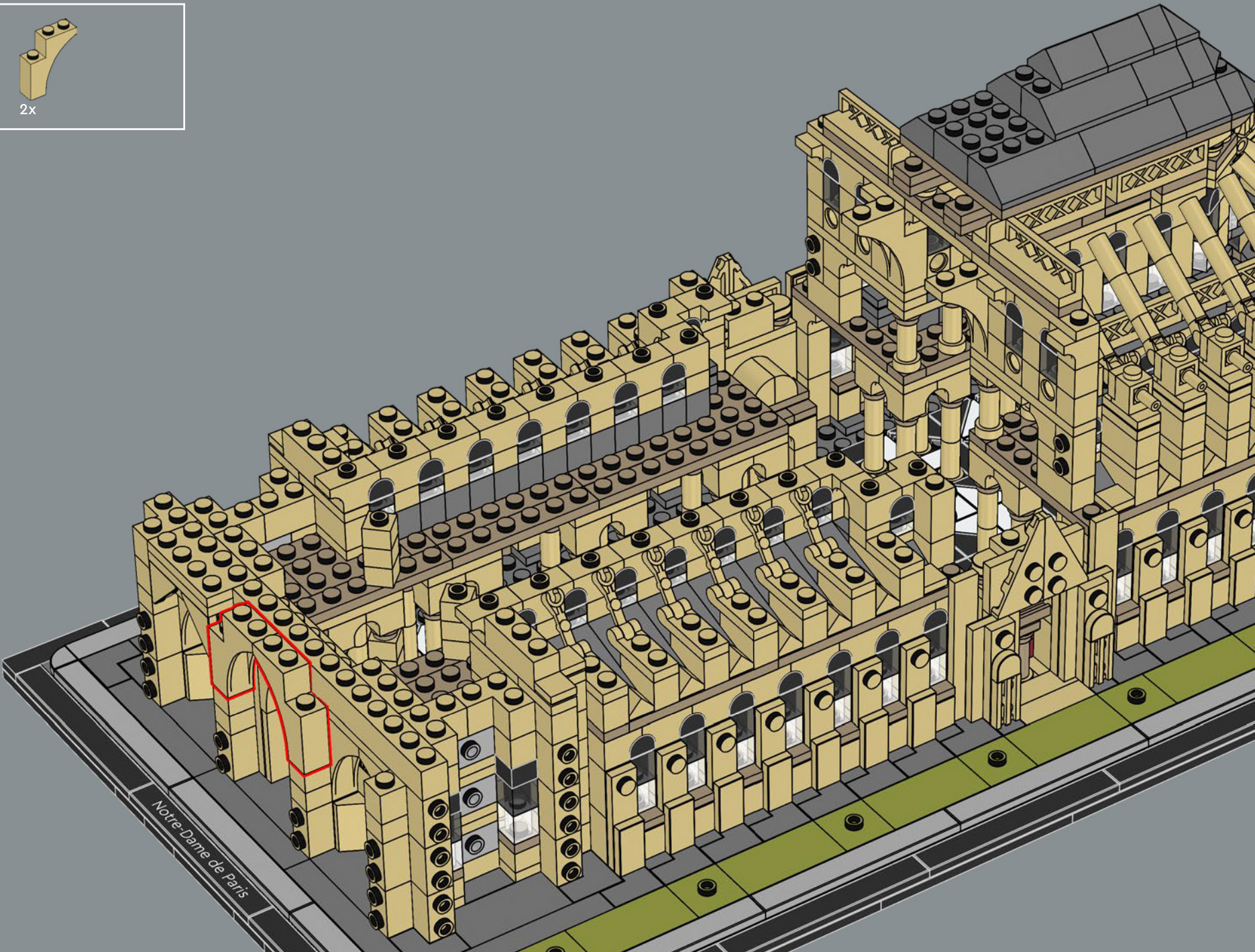

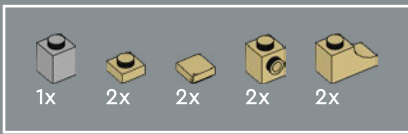

198

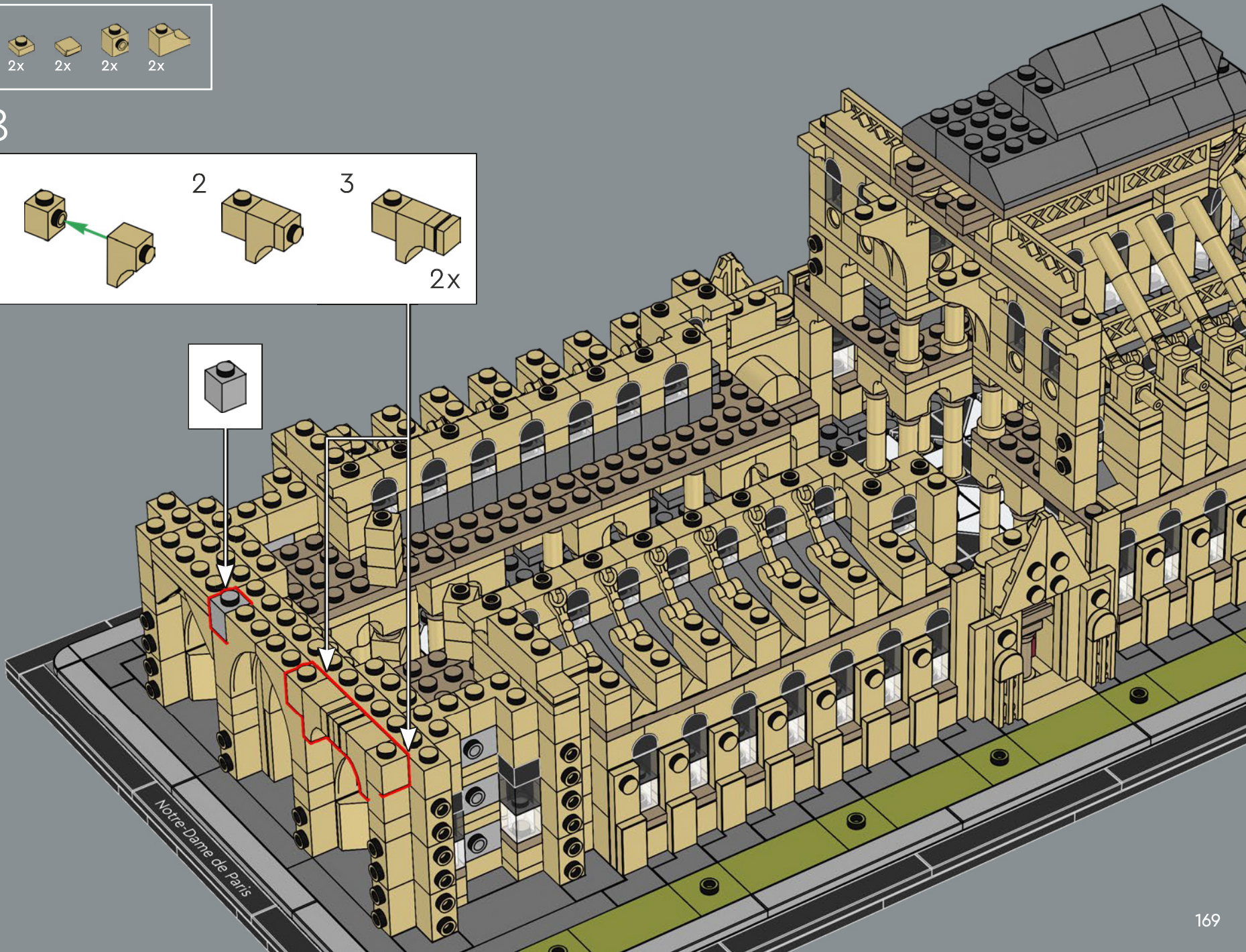
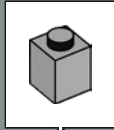
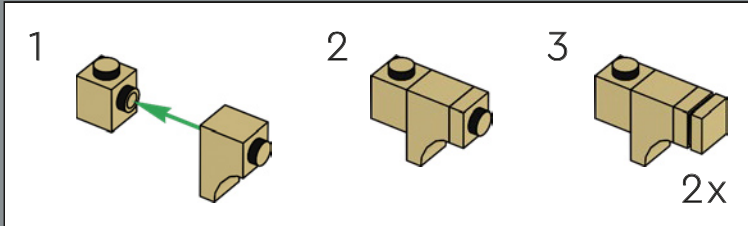

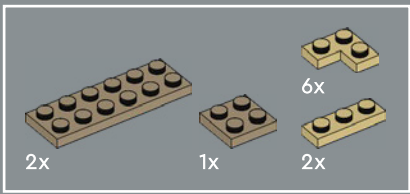

199



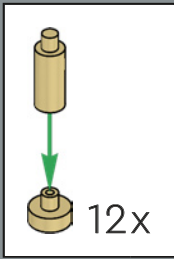

200



Notre-Dame de Paris

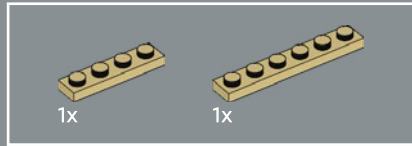
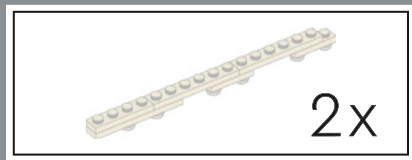

201

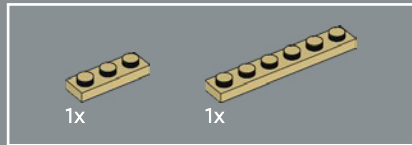
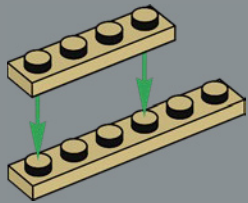

202

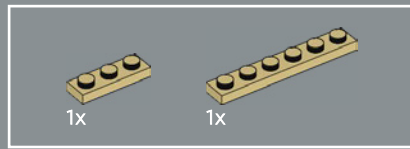
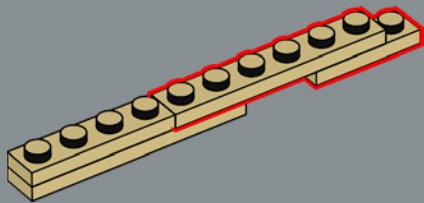

203

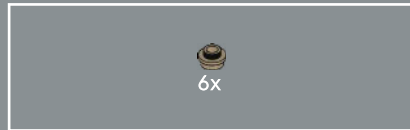
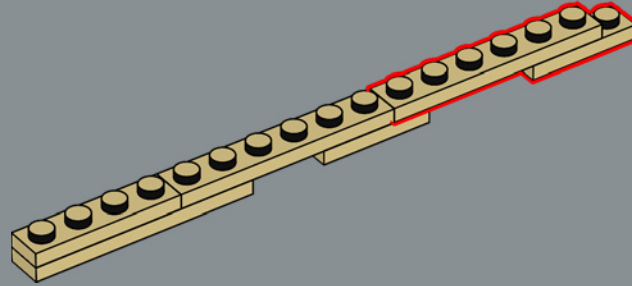

204

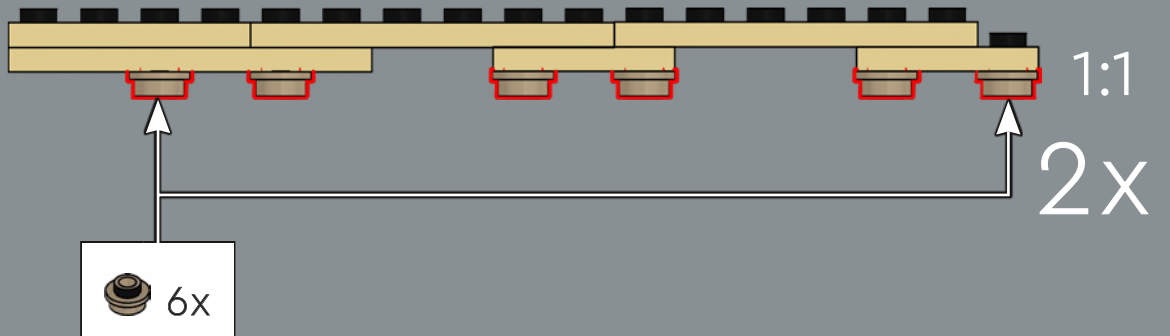

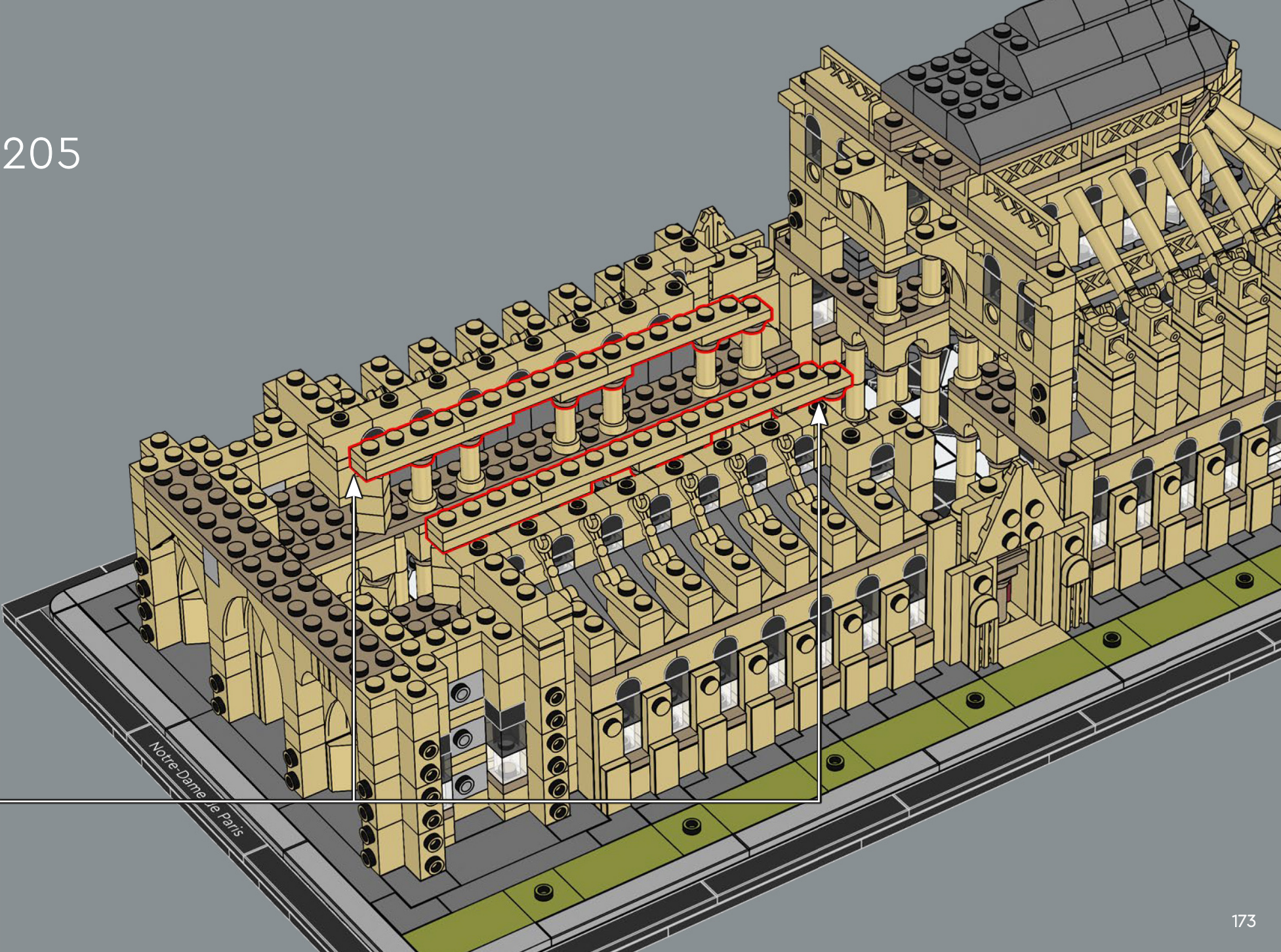

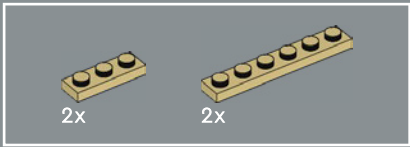

206

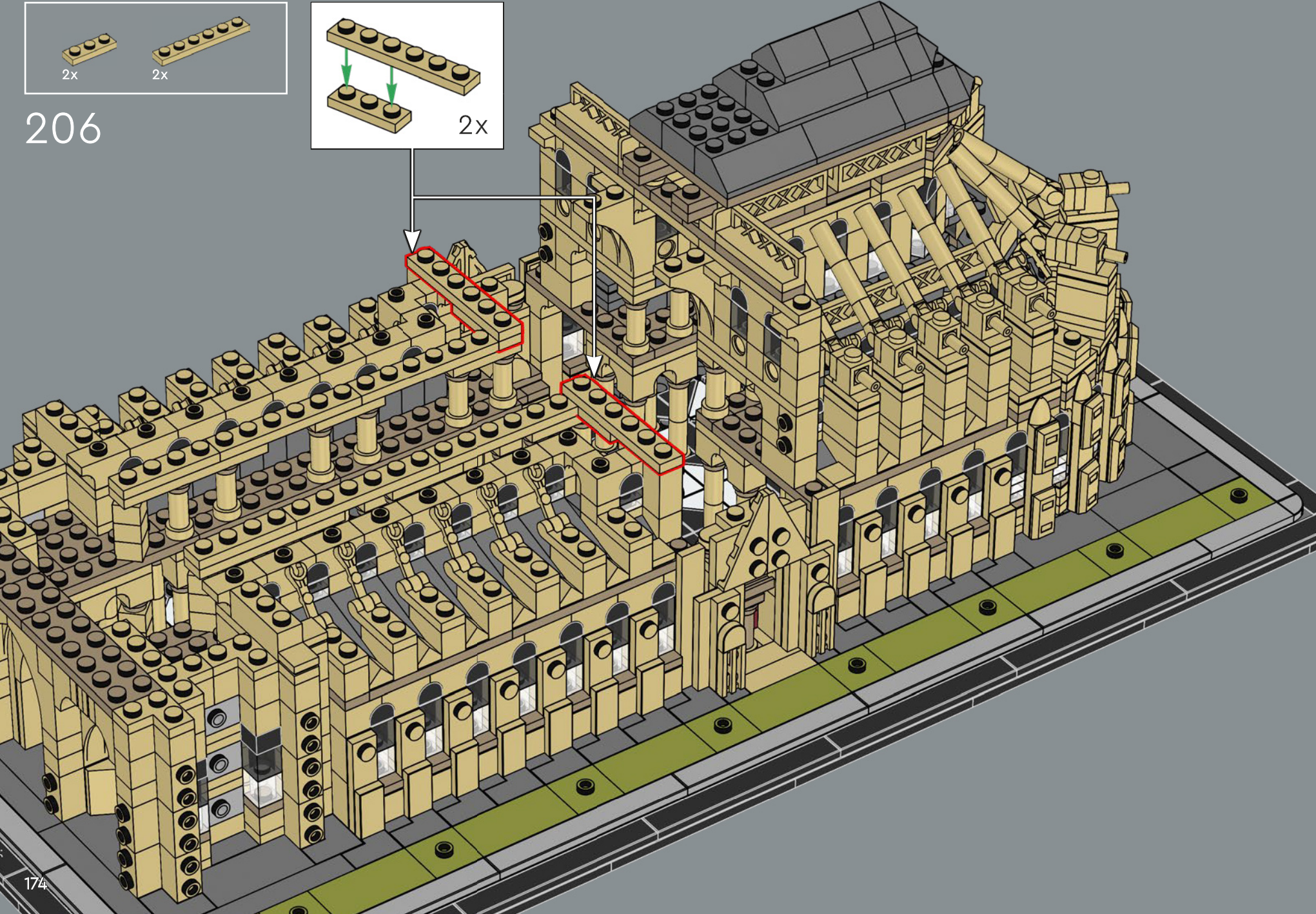
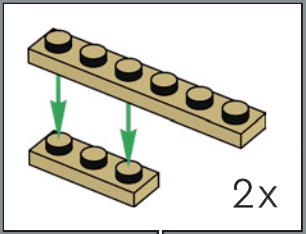

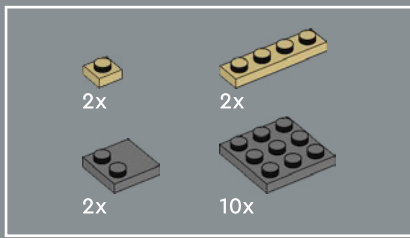

207



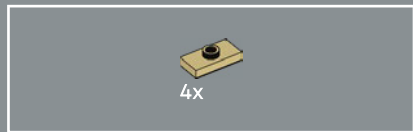

208

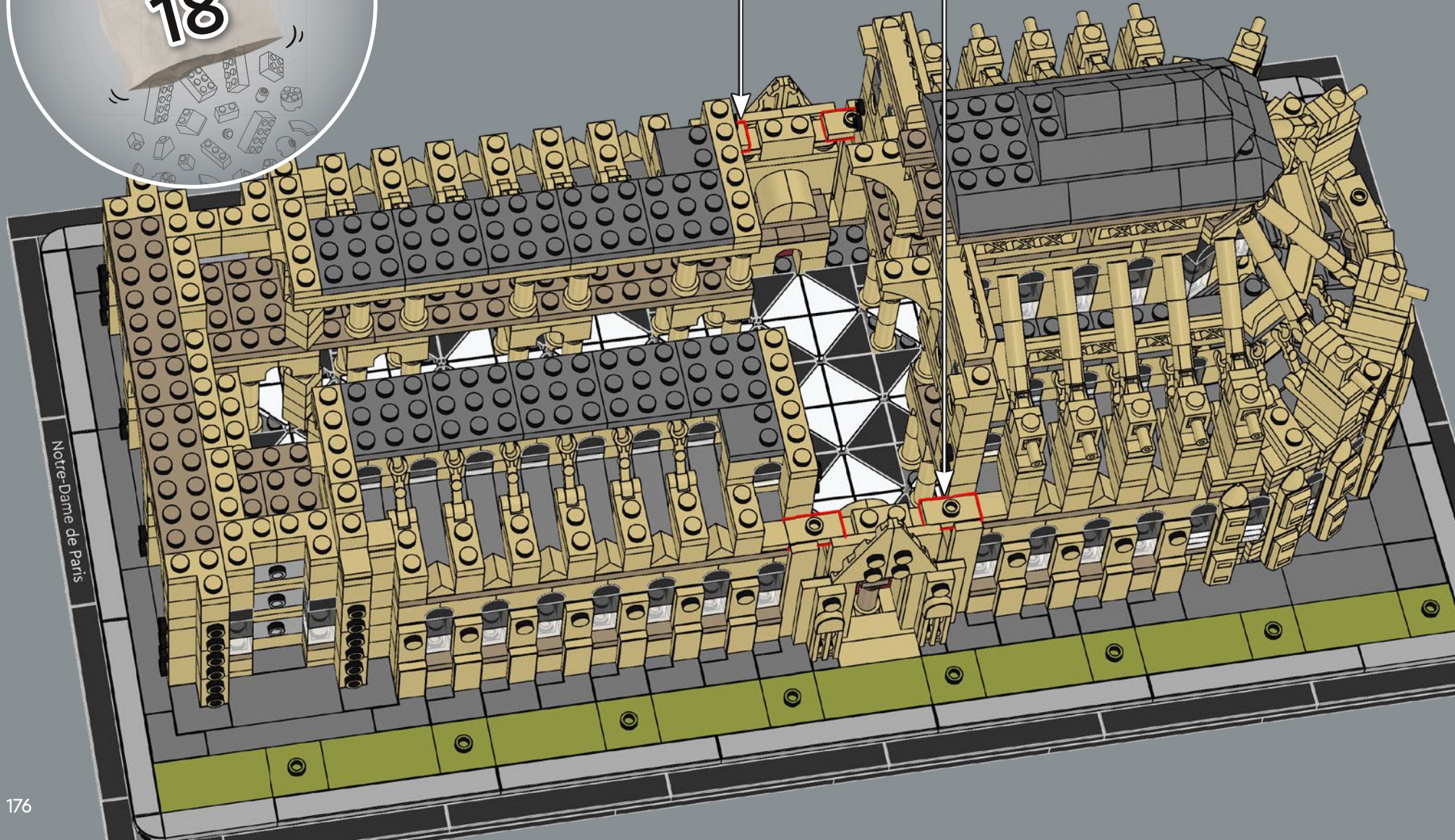

Notre-Dame de Paris

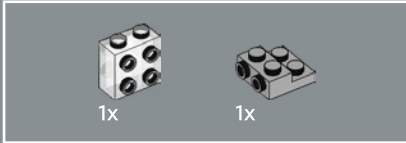
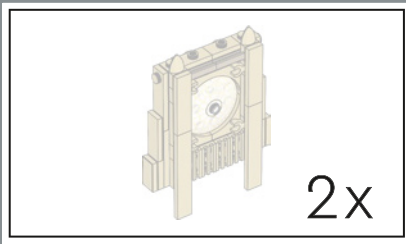

209

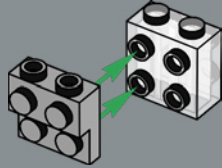

210

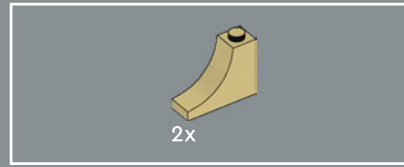
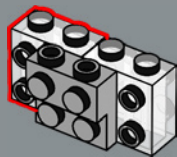

211

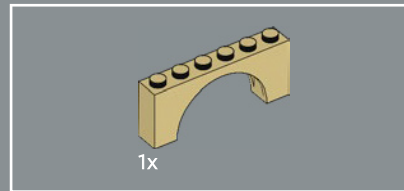
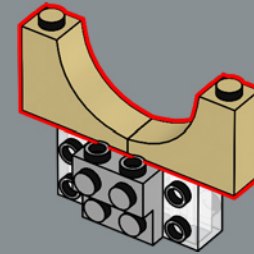

212

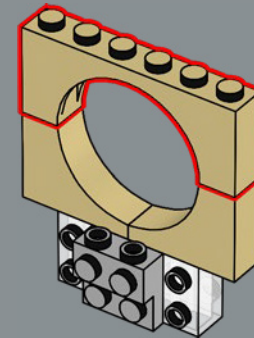

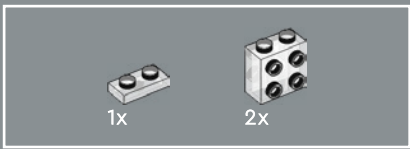

213

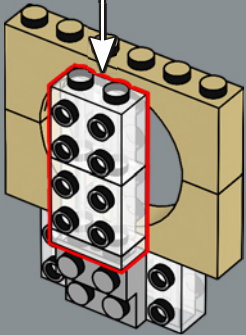
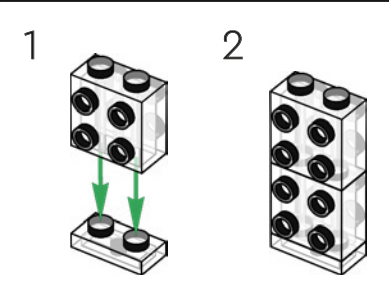

214

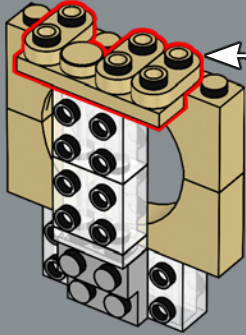
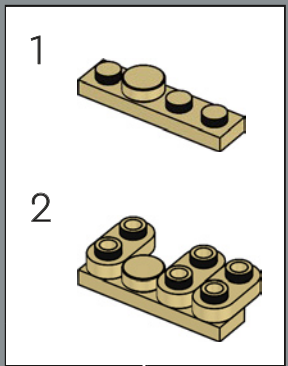

215

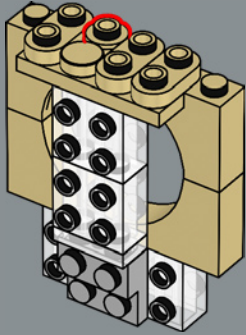



216

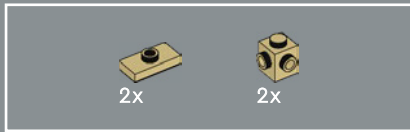
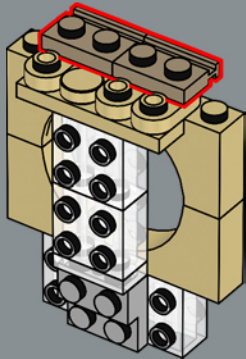

217

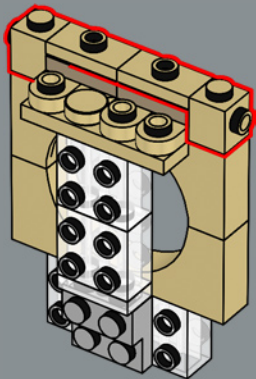

218

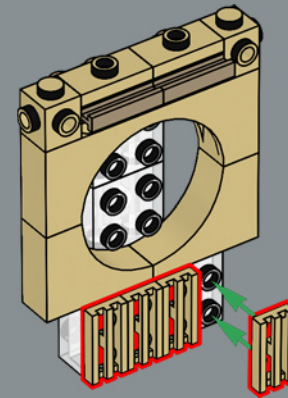

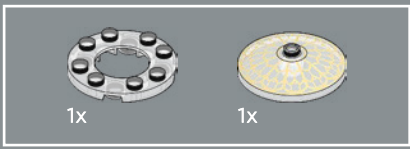

219

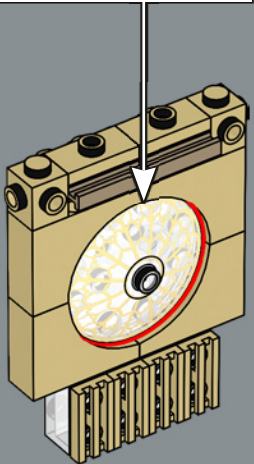
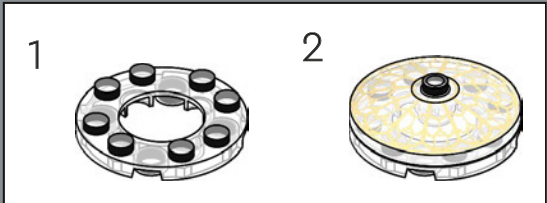

220

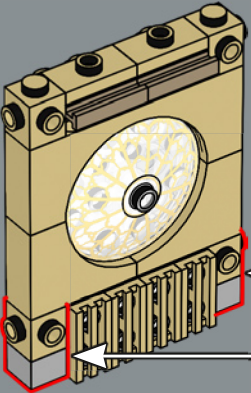
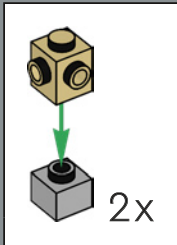

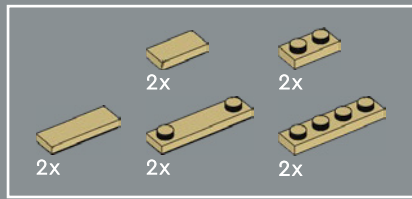

221

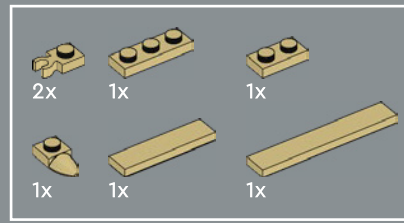
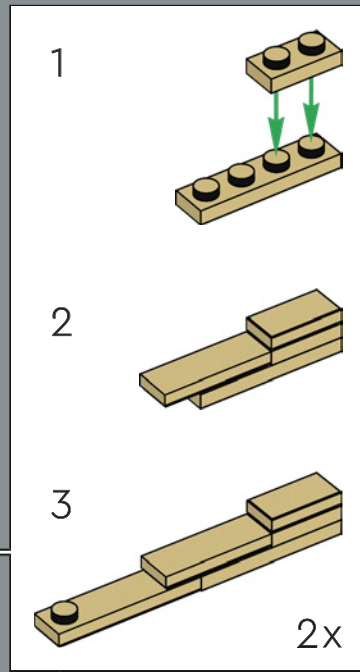
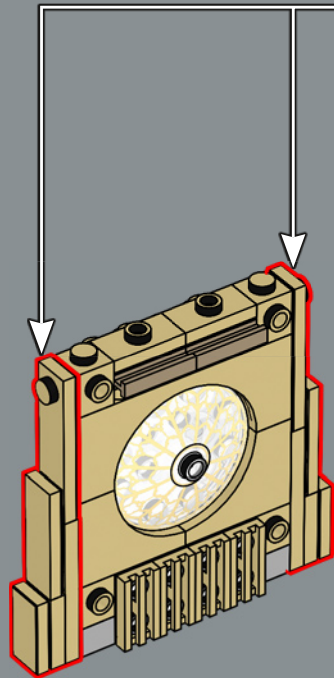

222

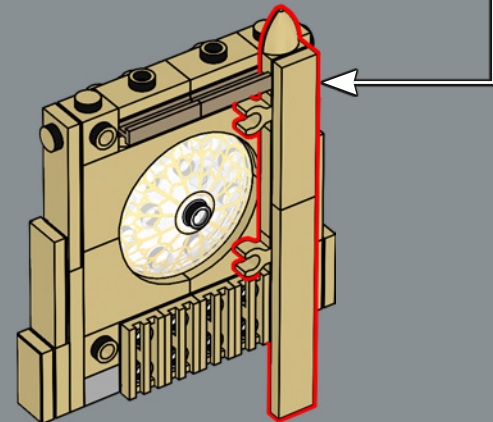
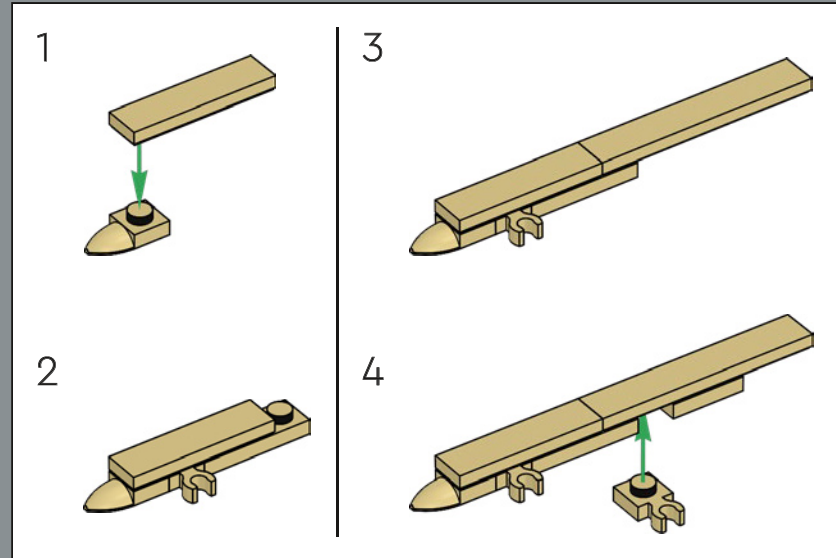

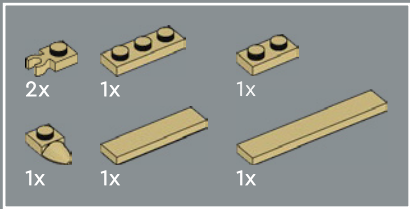

223

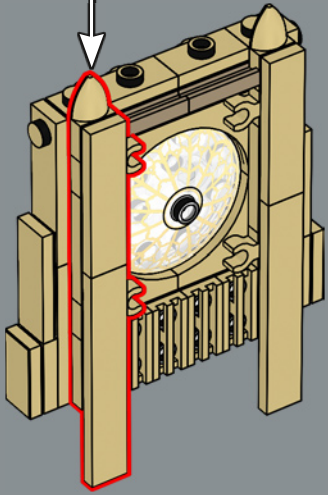
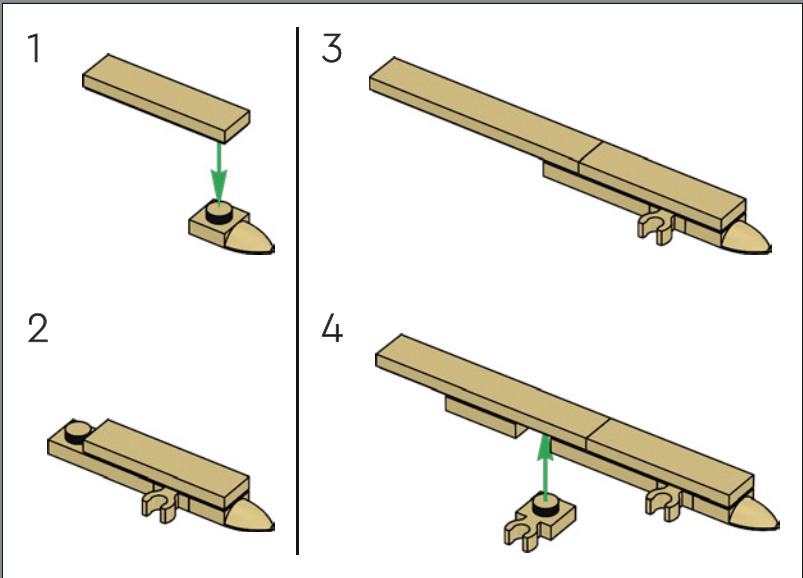

2x

224

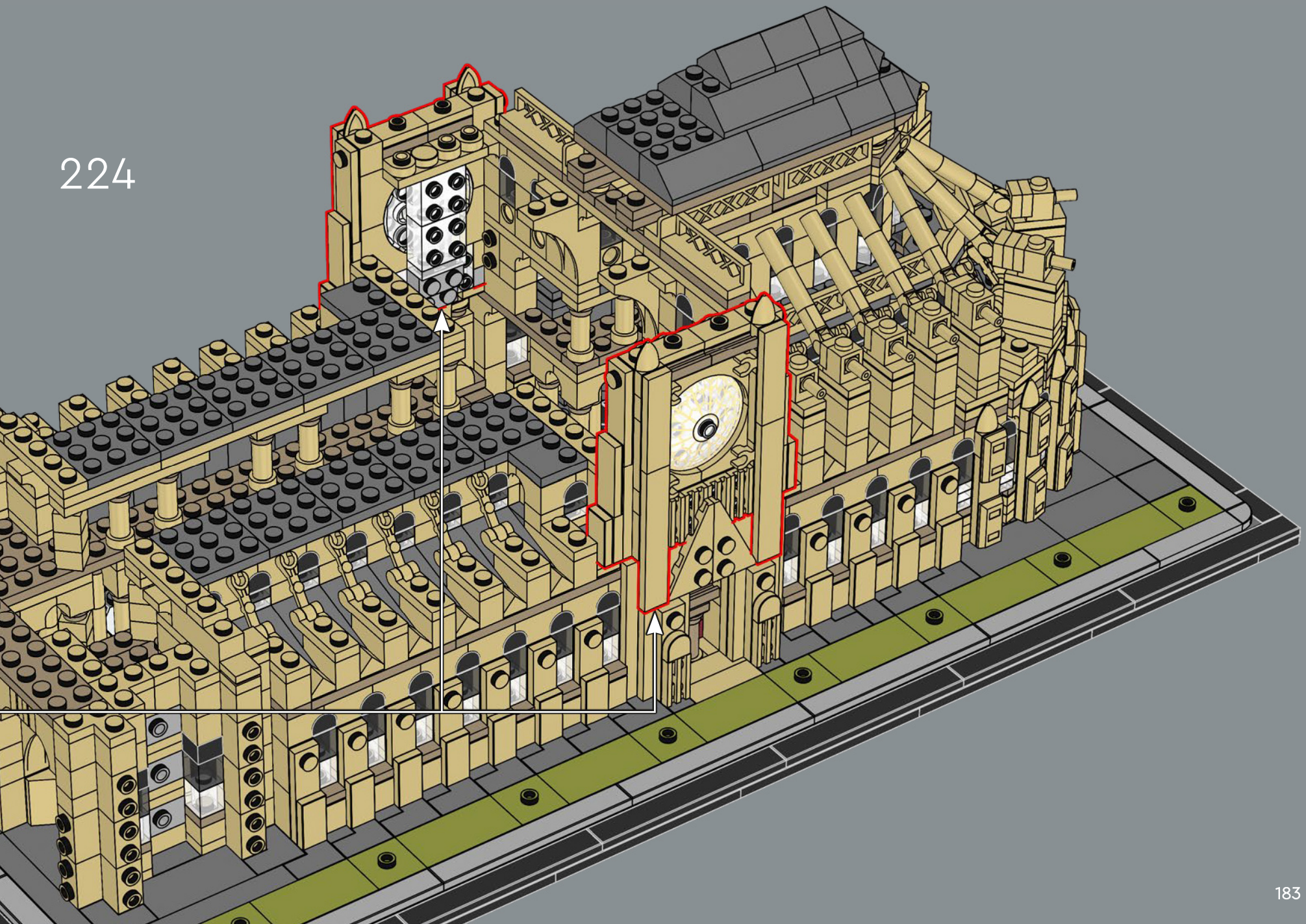

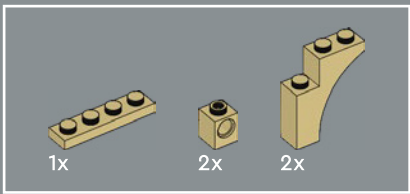

225

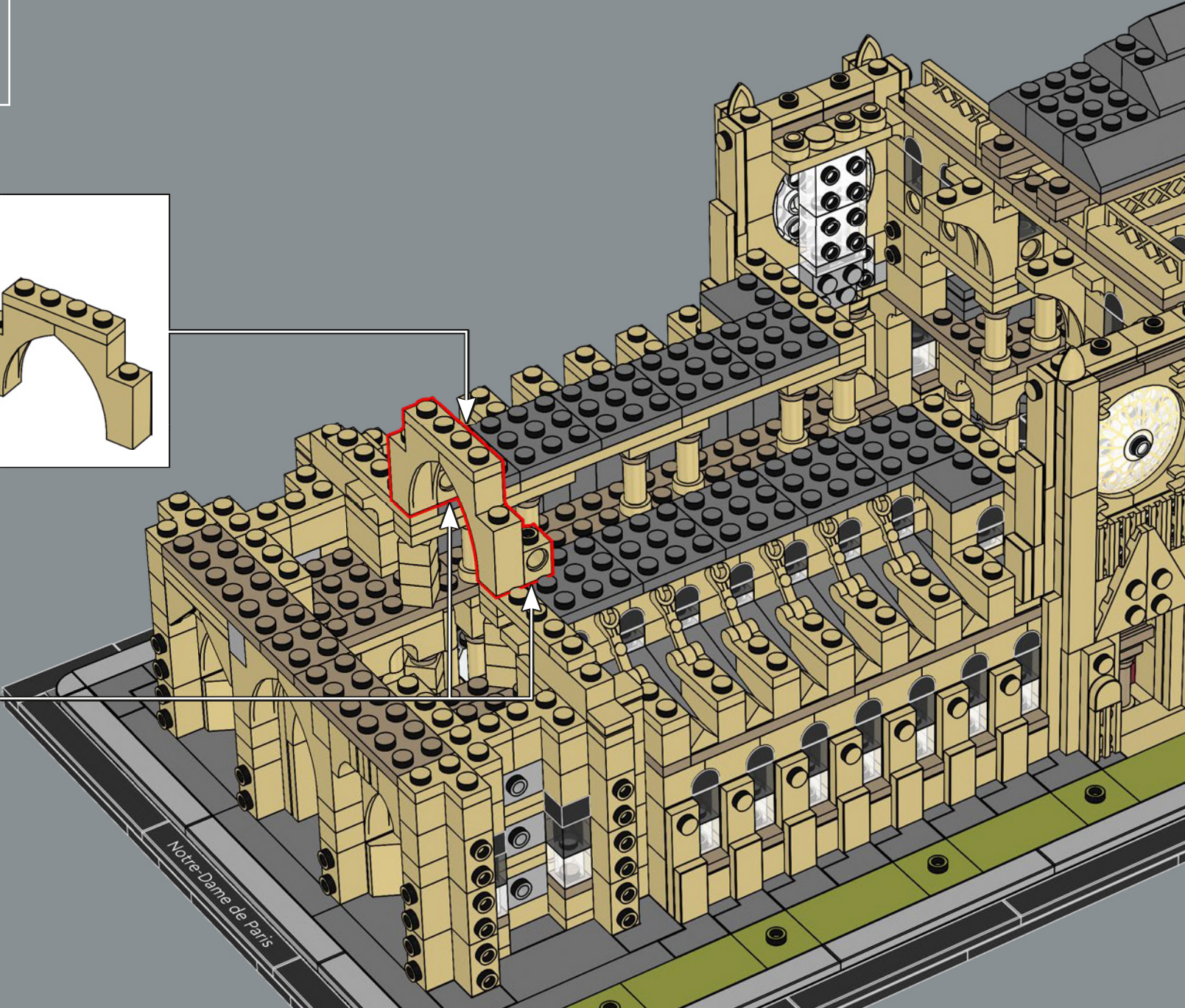
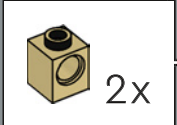
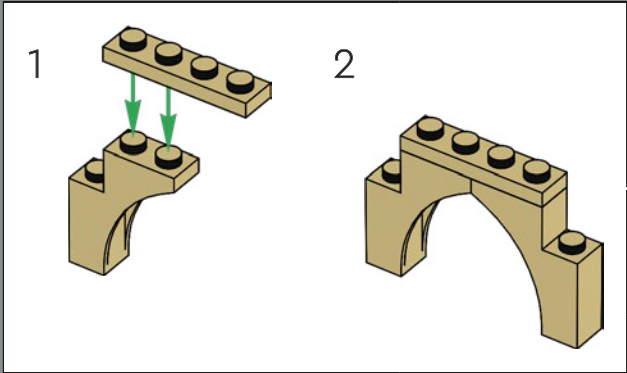

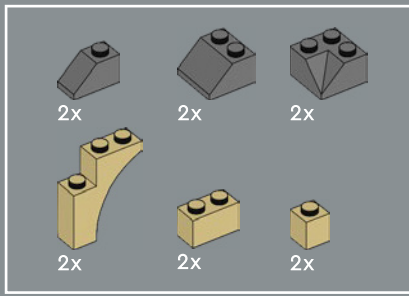

226

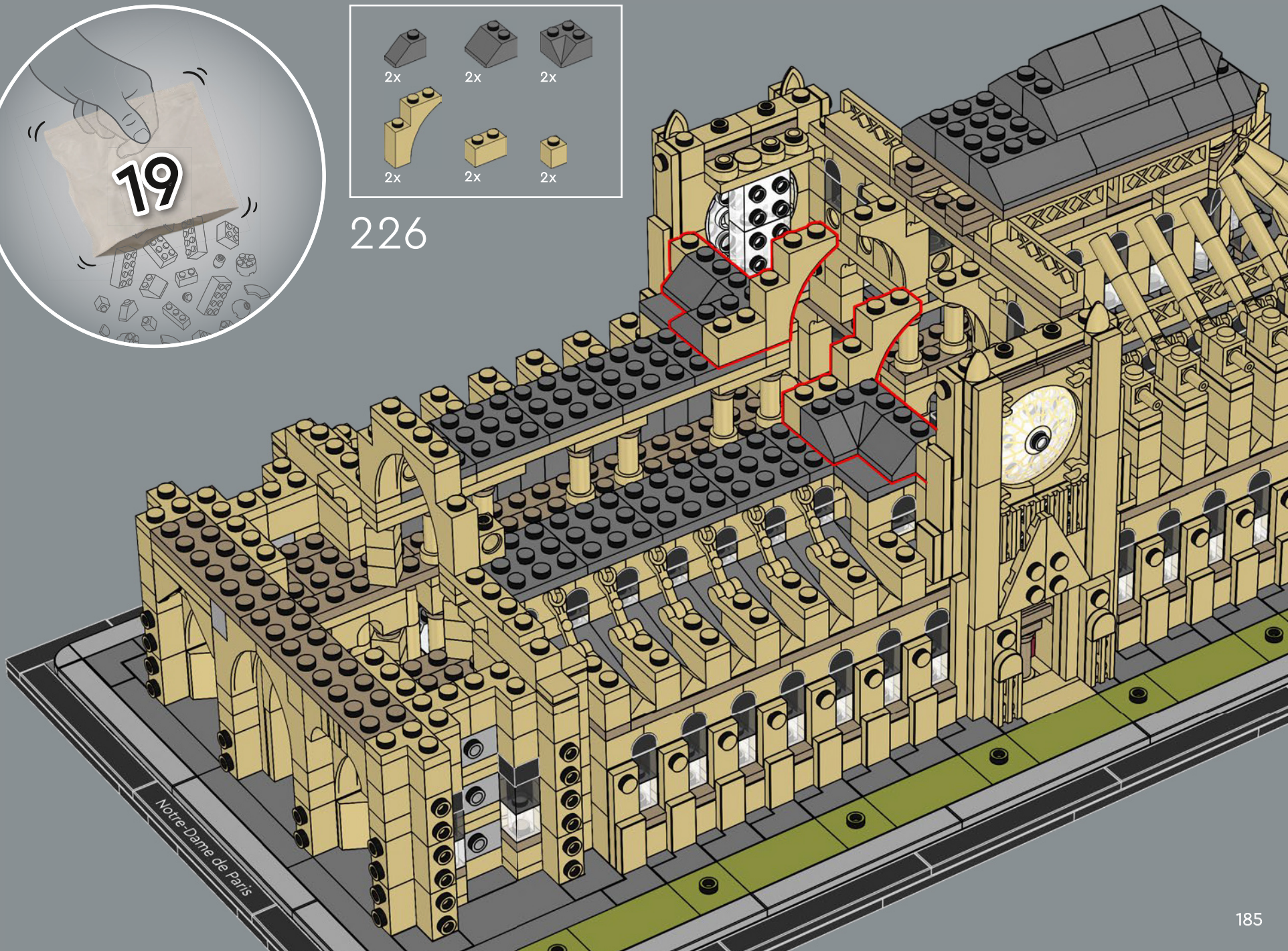

Notre-Dame de Paris



8x

227

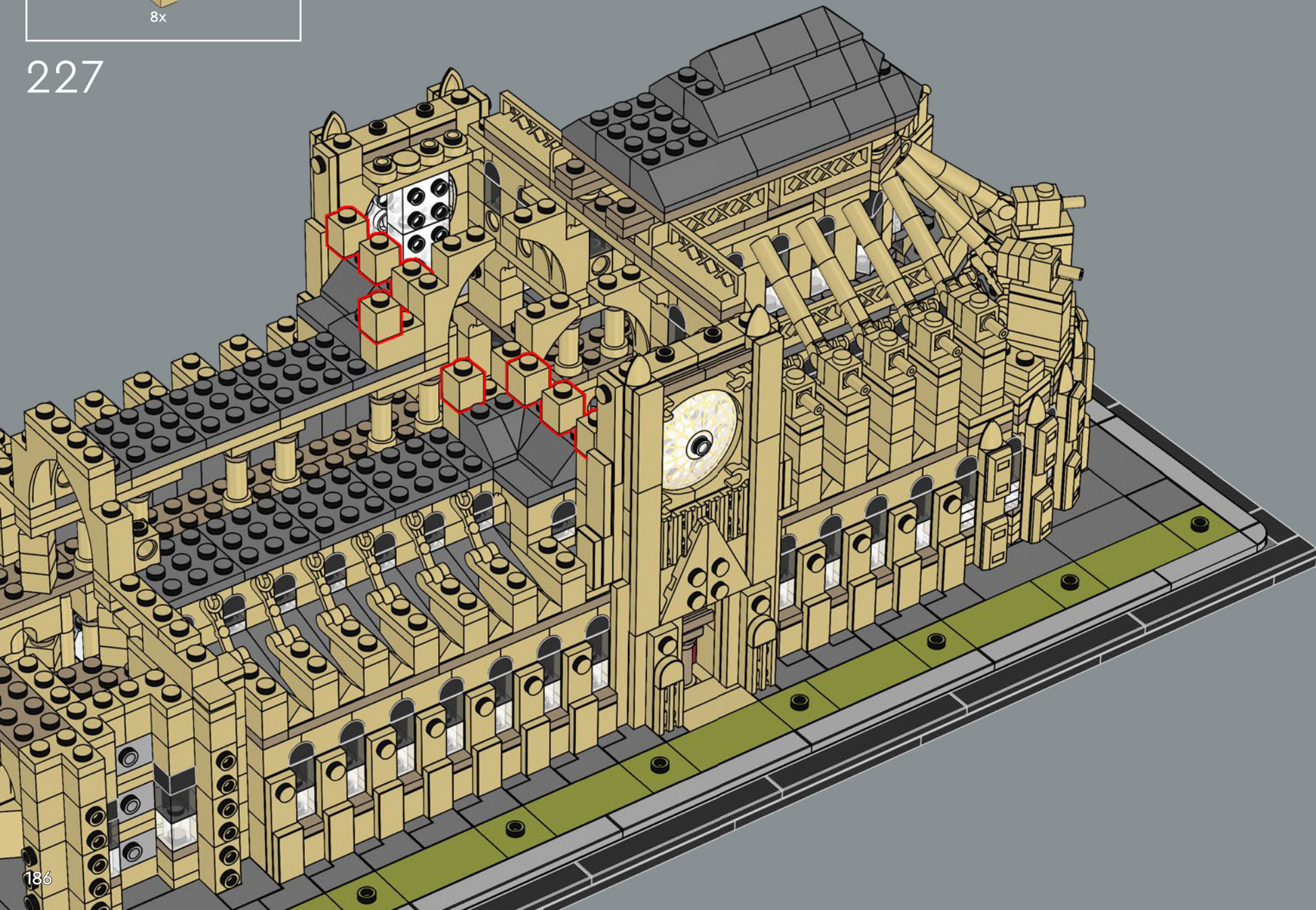

Vaults are divided into six parts by ribs – 'sexpartite vault'. The LEGO® model follows the original by having a transverse rib at every second capital.

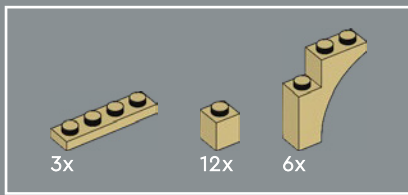

228

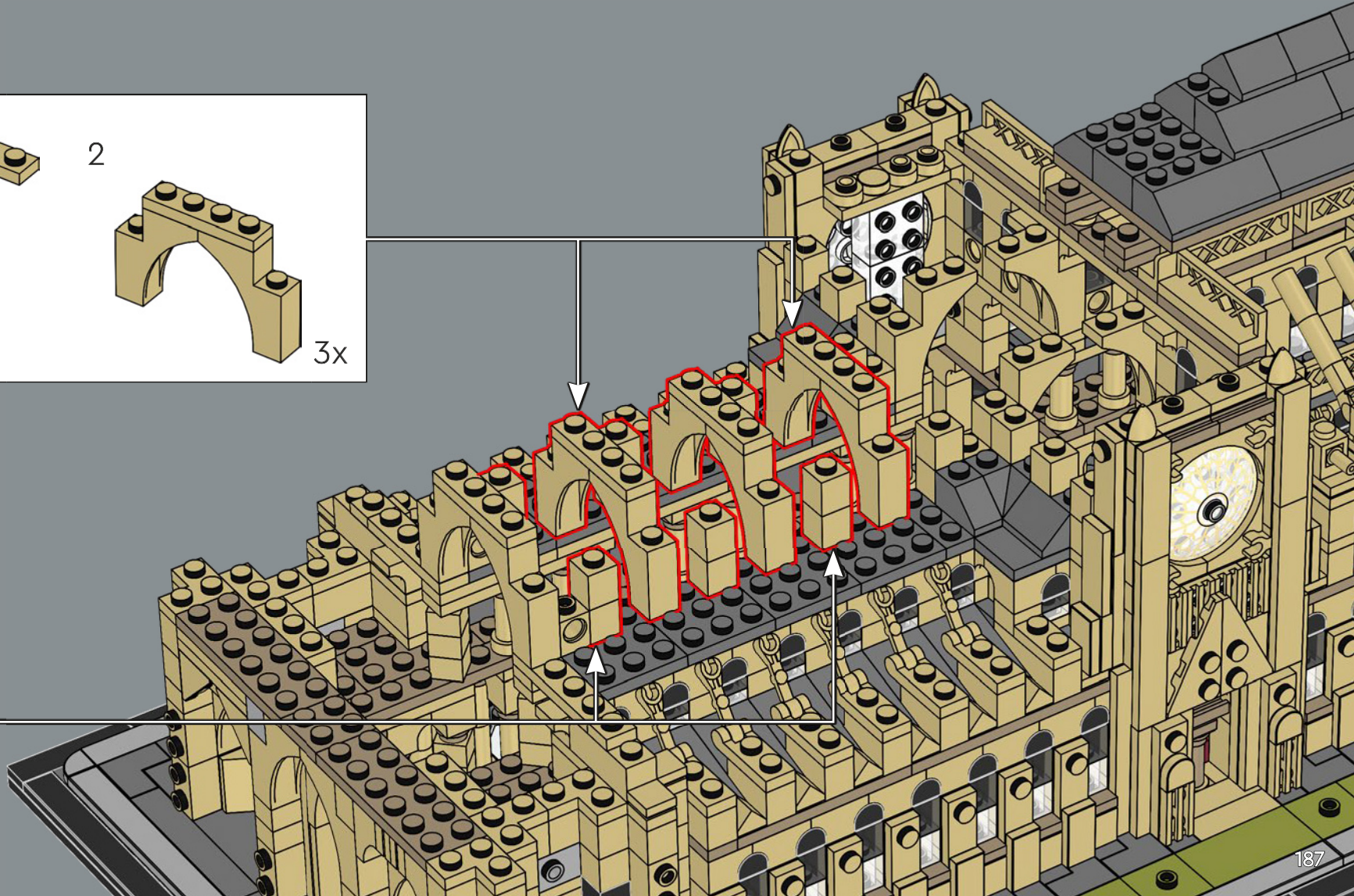
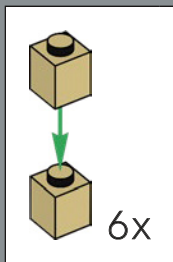
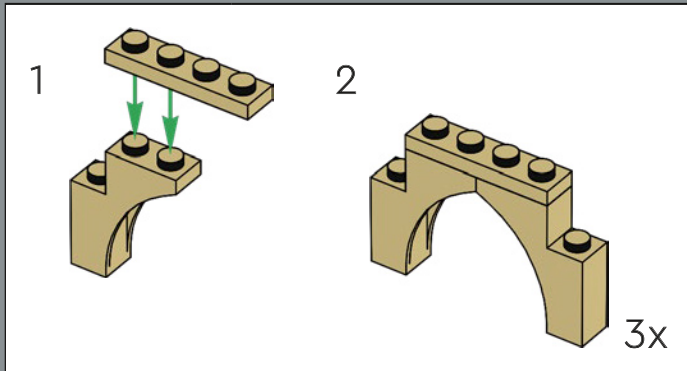



12x



20x



20x

229



8x



12x

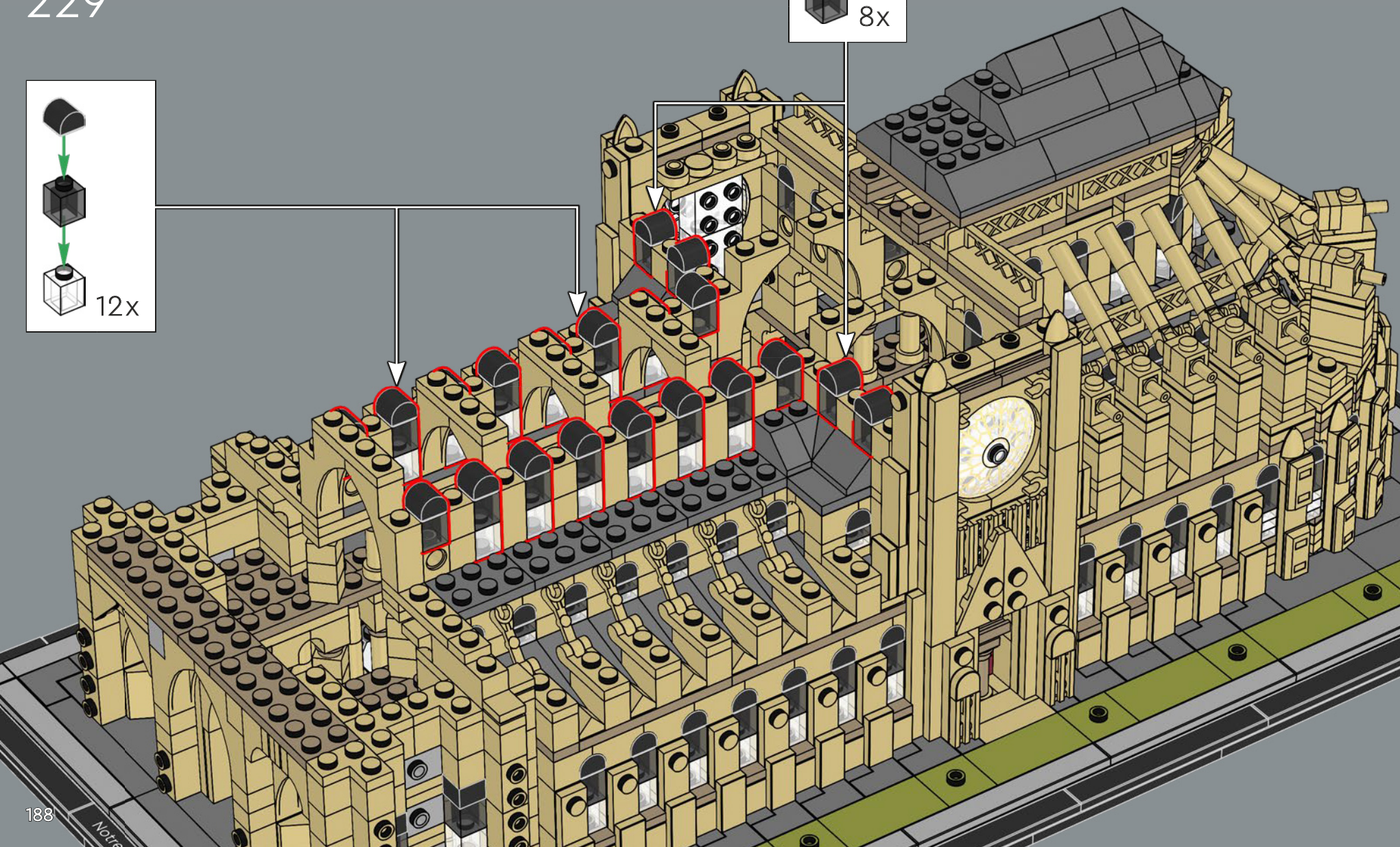

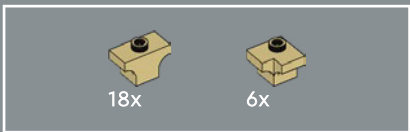

230

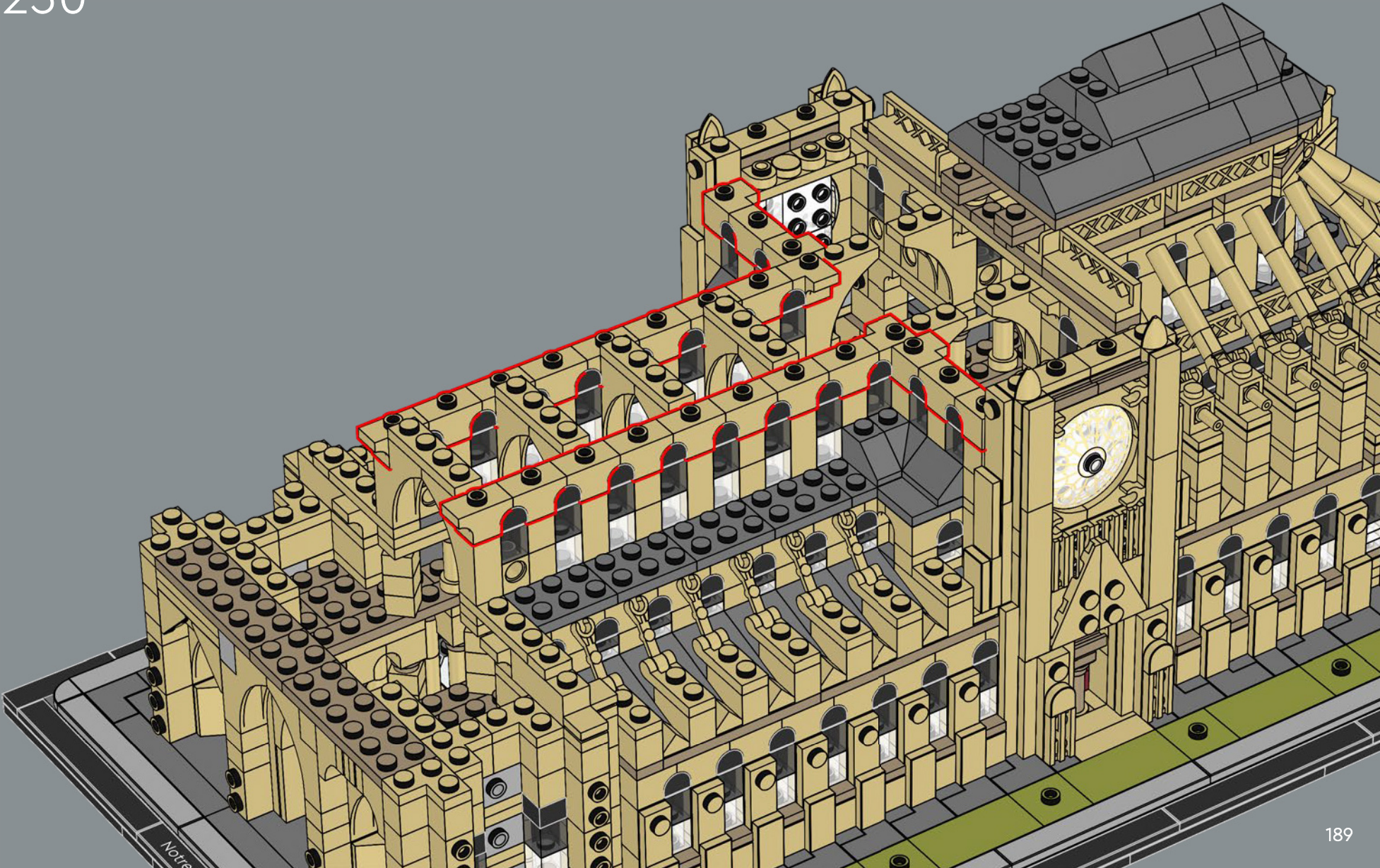

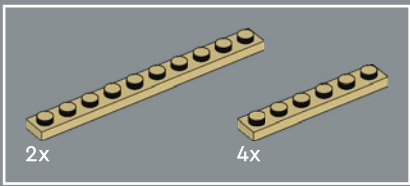

231

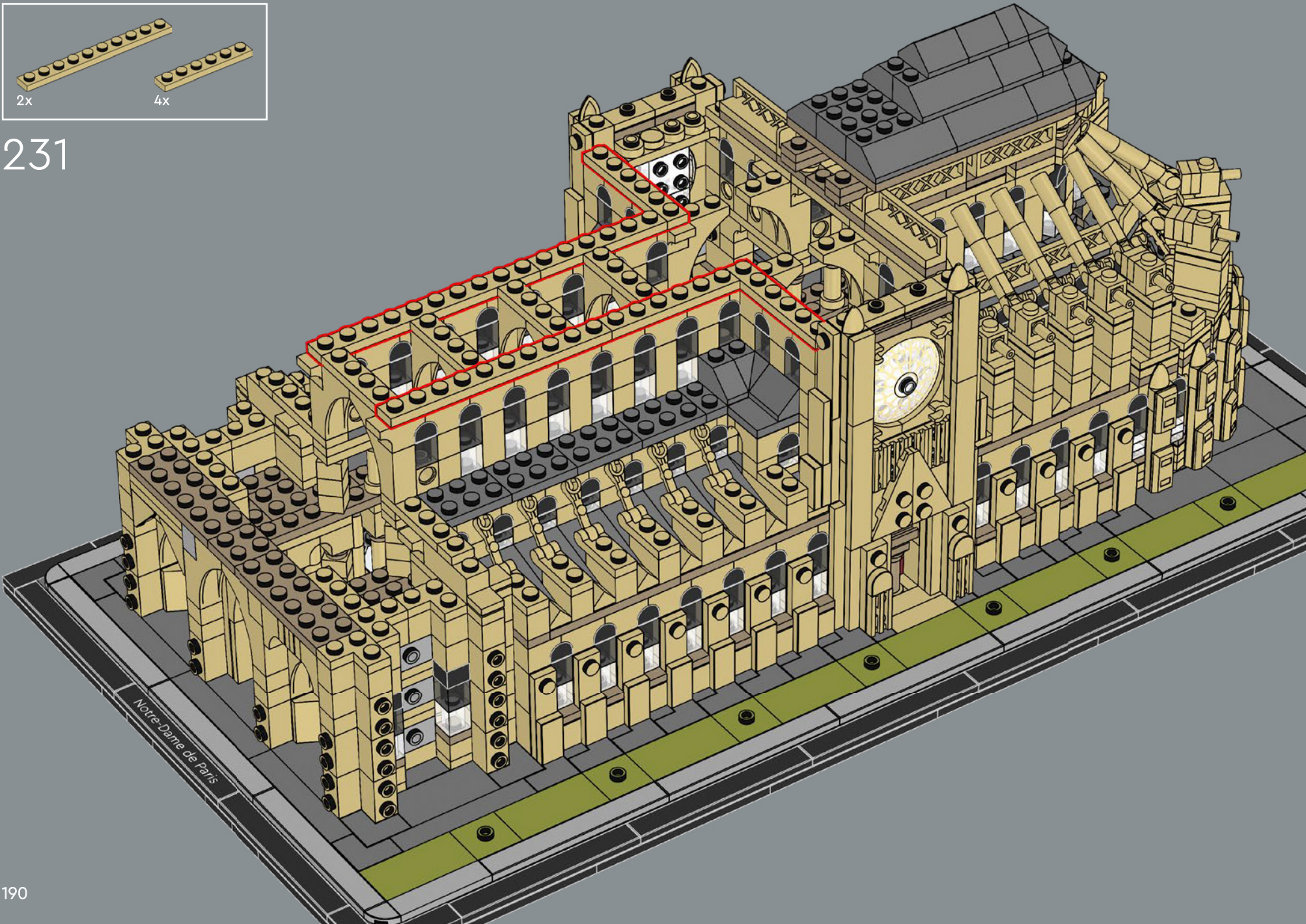

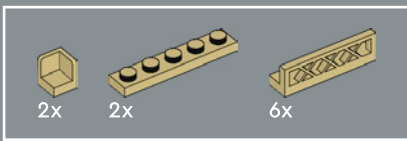

232

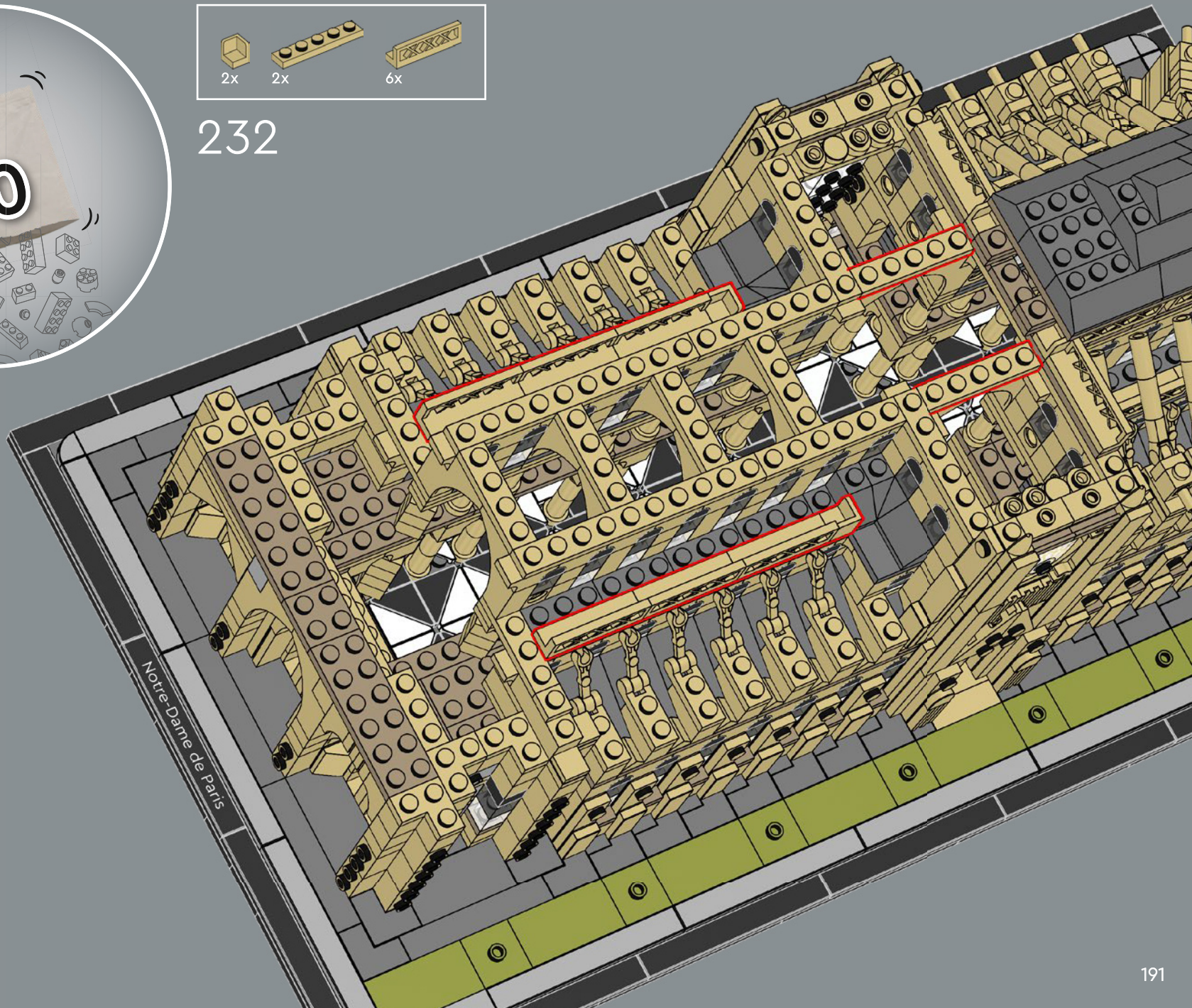

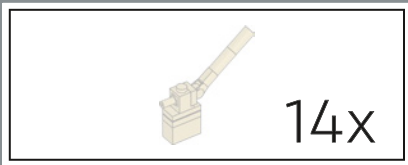

The flying buttresses in this LEGO® model feature holes through the candle elements to mimic the water channels in the real buttresses.

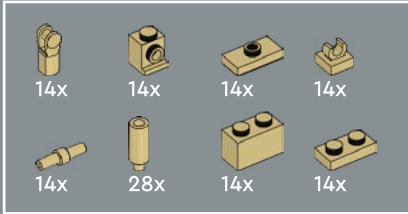

233

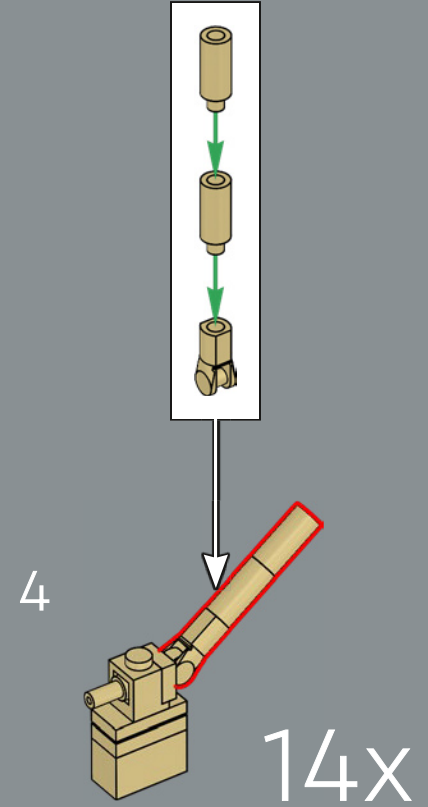
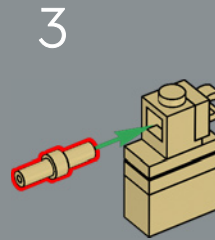
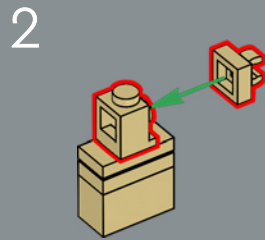
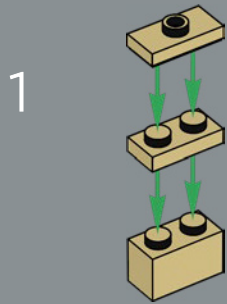

In 1225, nave flyers are fitted with channels that drain rainwater from the roof through the gargoyles.

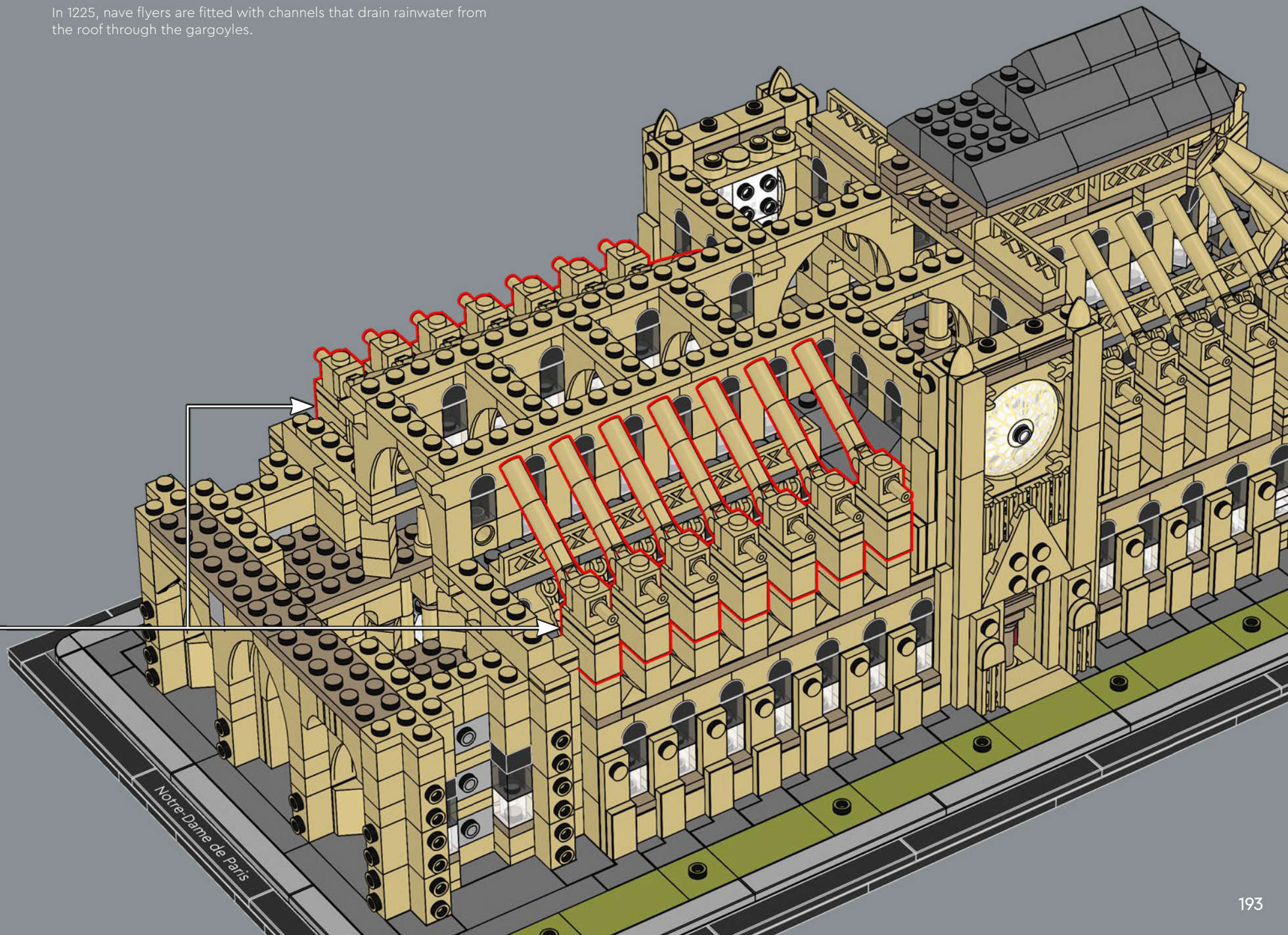

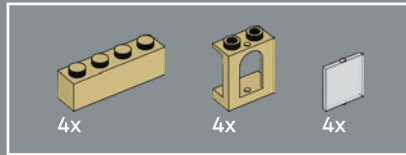
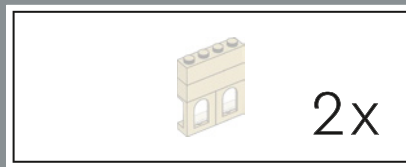

234

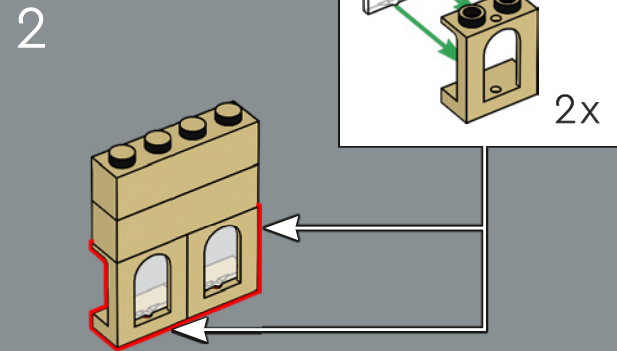
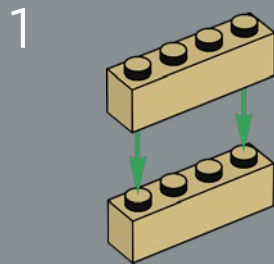

2x

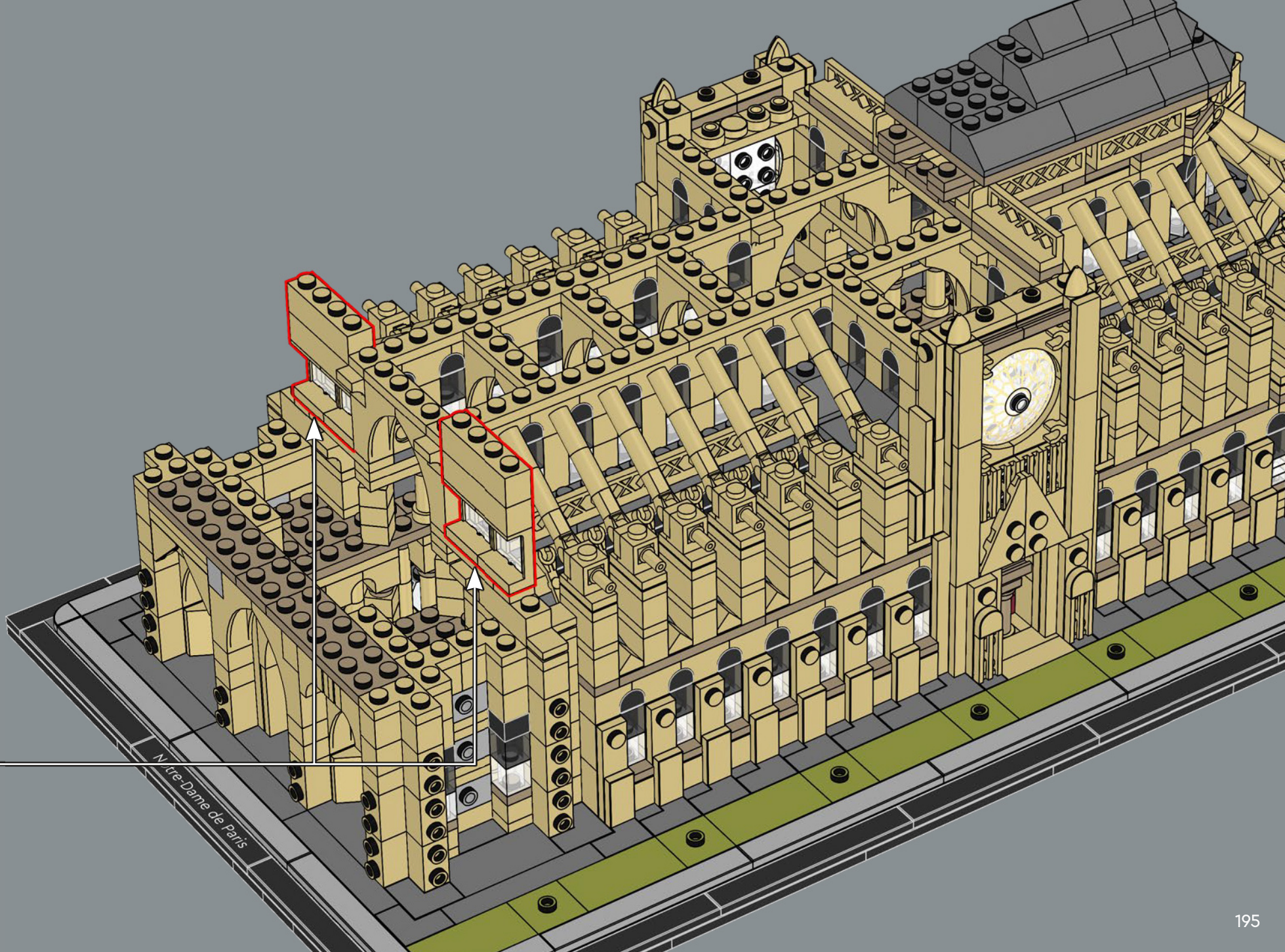

Notre-Dame de Paris

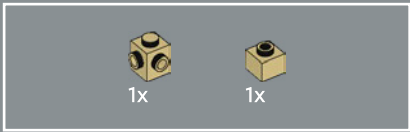

235

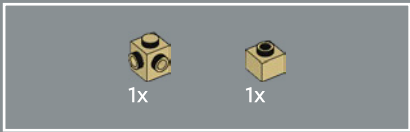
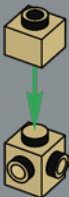

236



237

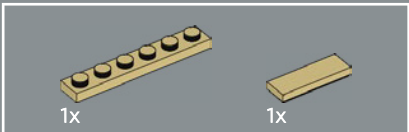

238

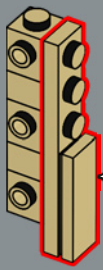
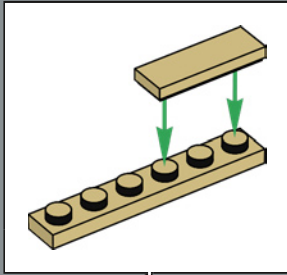

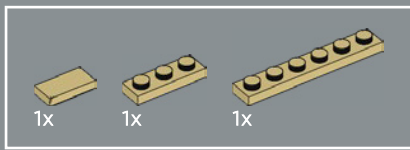

239

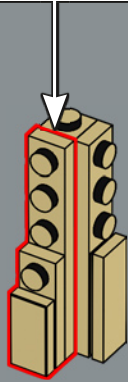
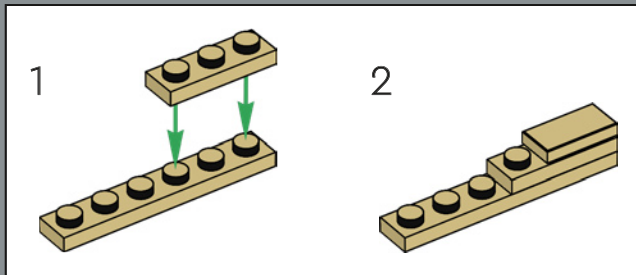

240

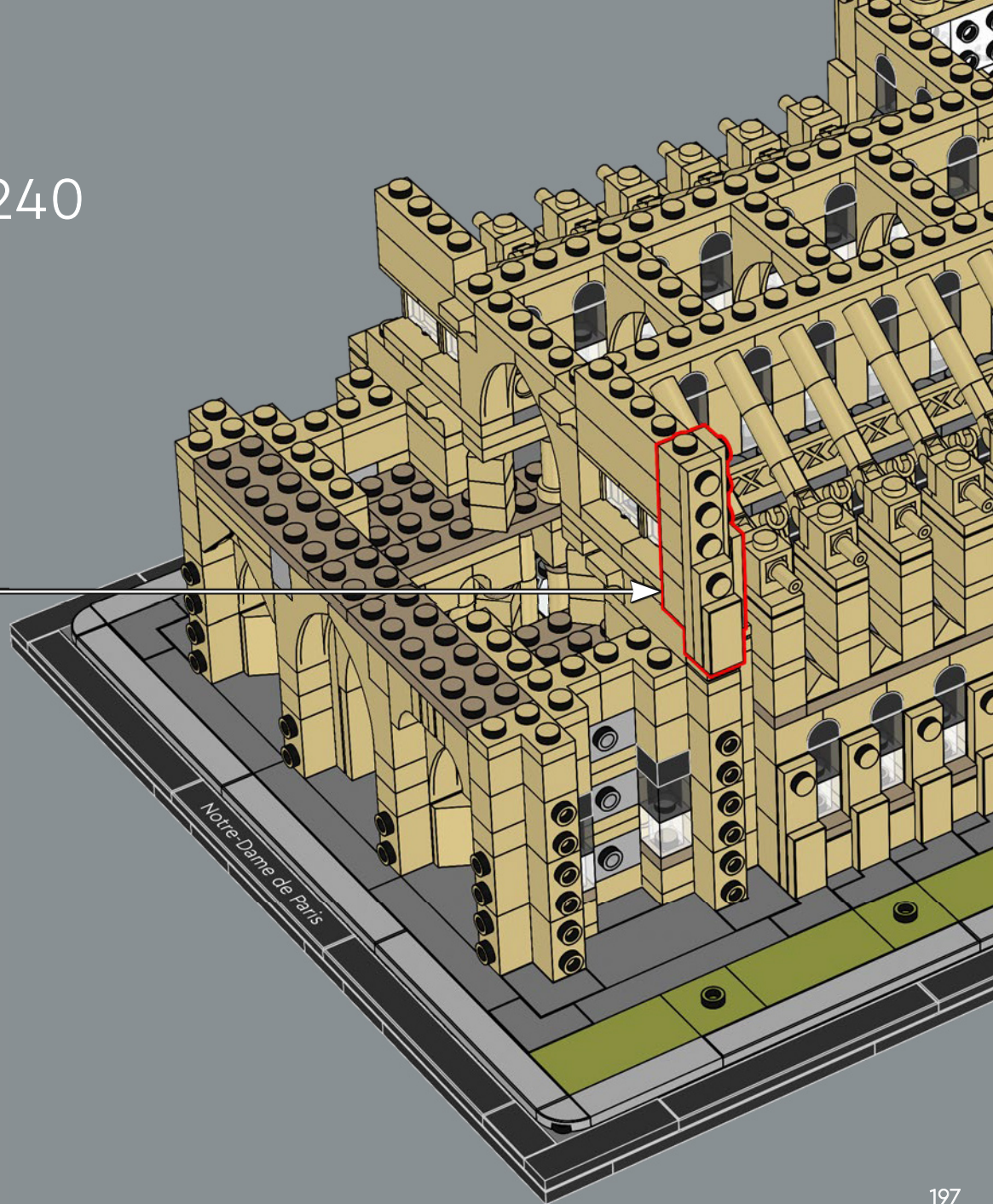

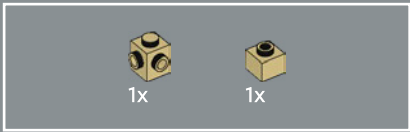

241

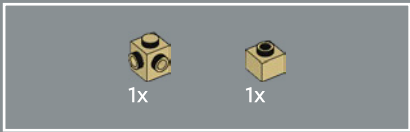
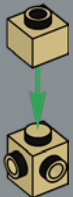

242



243

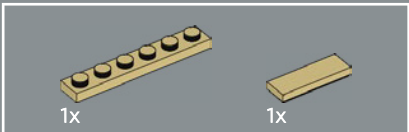

244

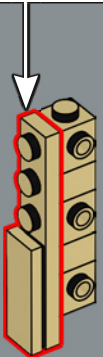
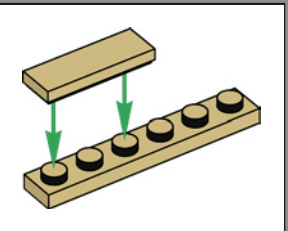

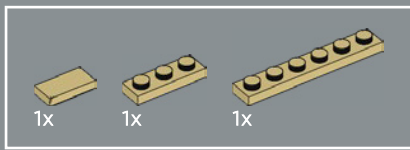

245

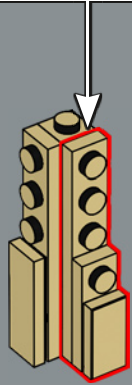
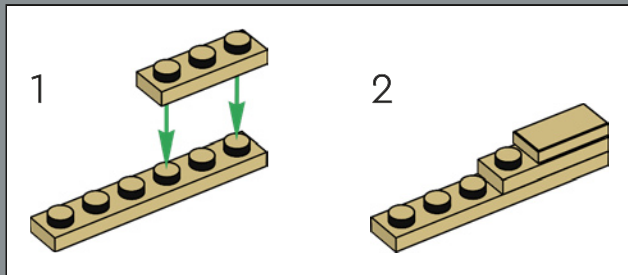

246

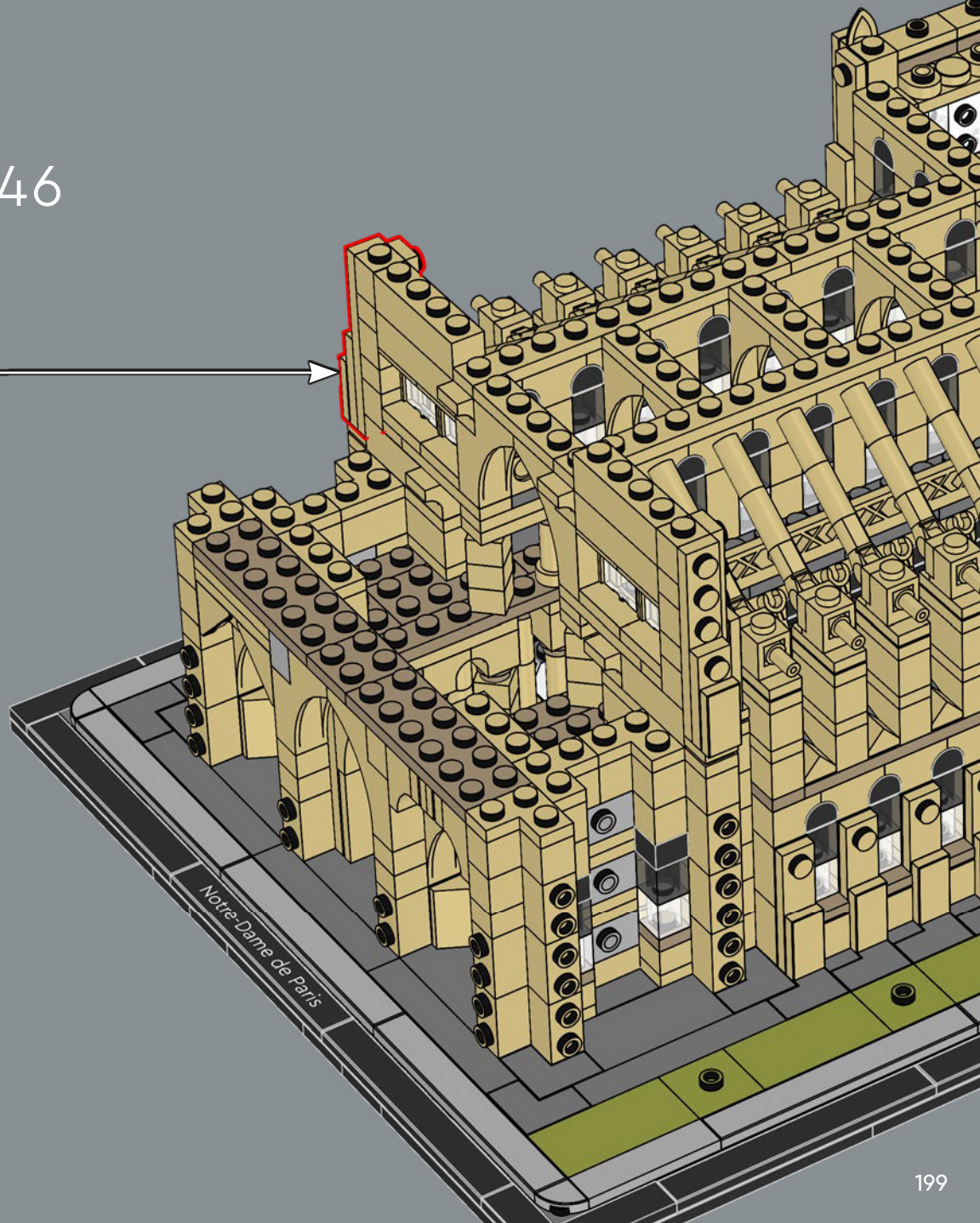



247

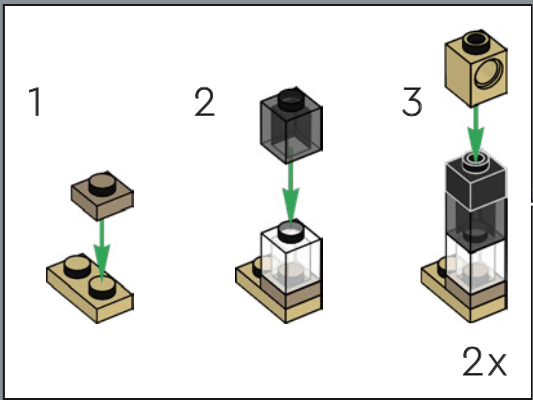

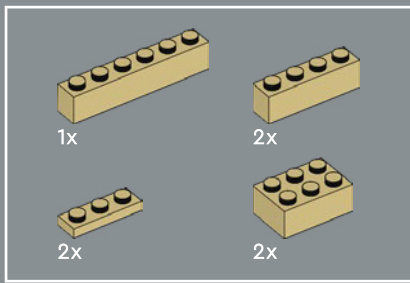

248

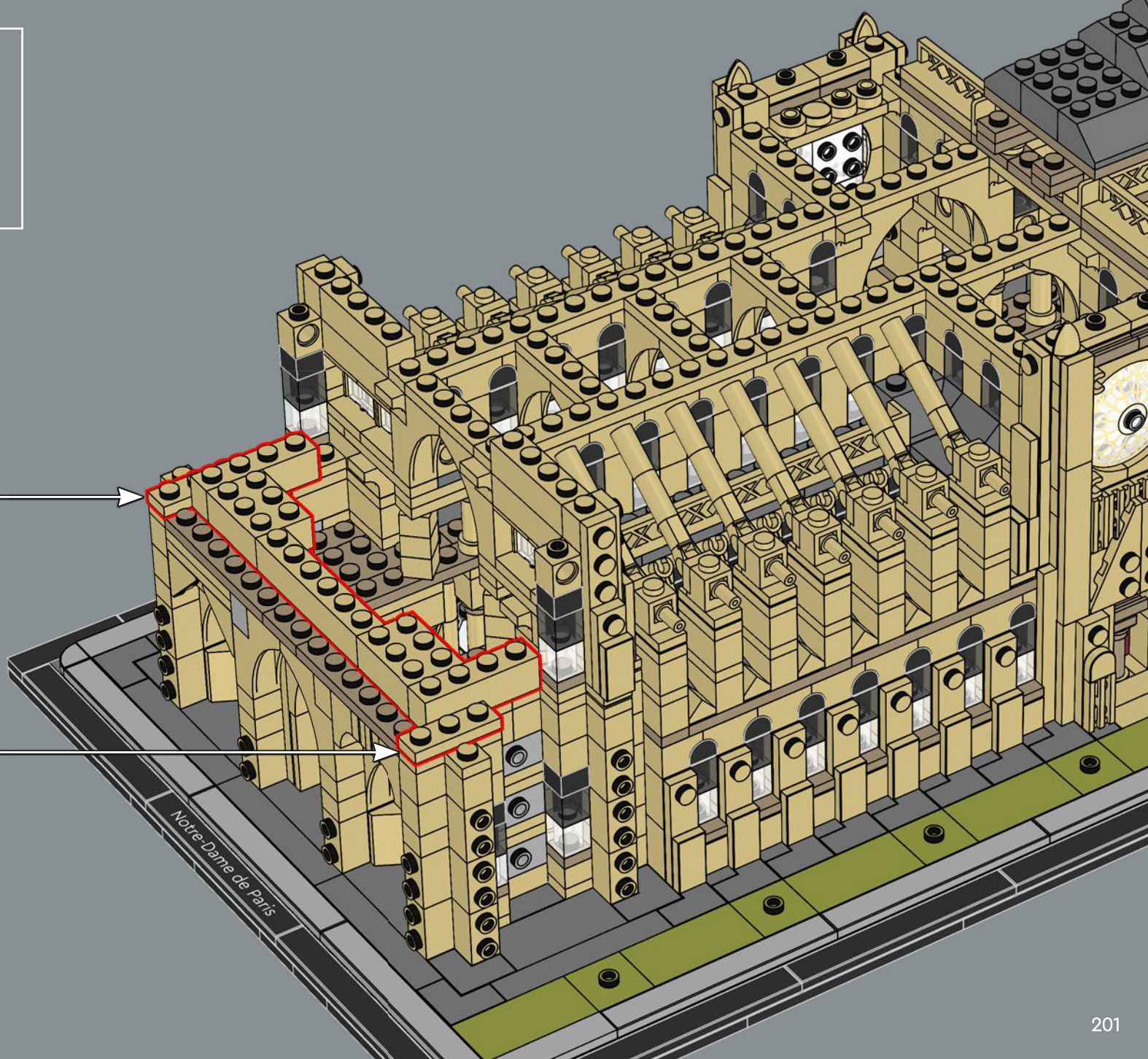
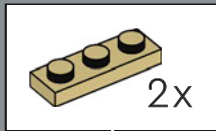

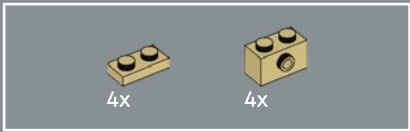

249

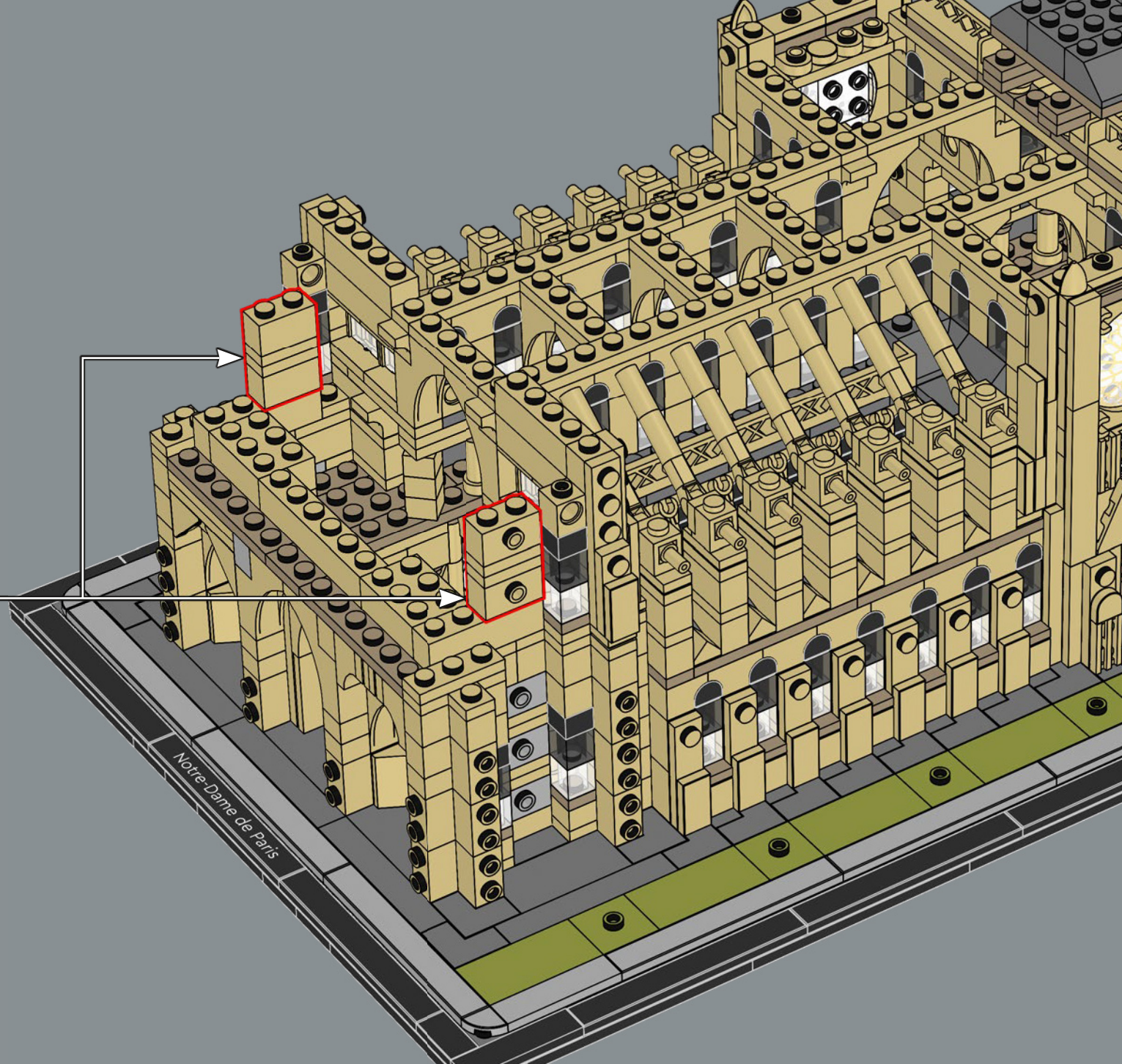
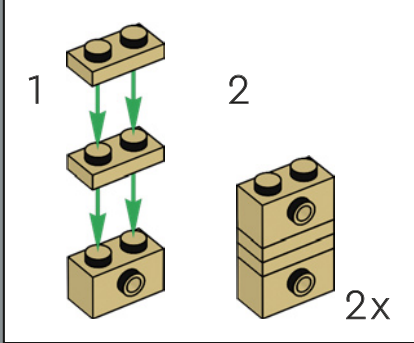

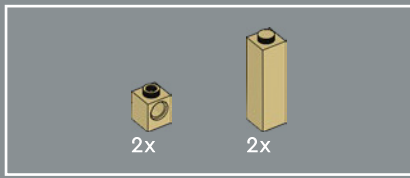

250

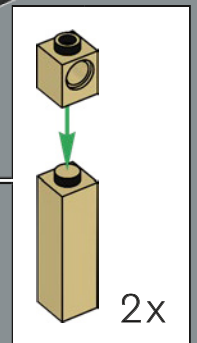
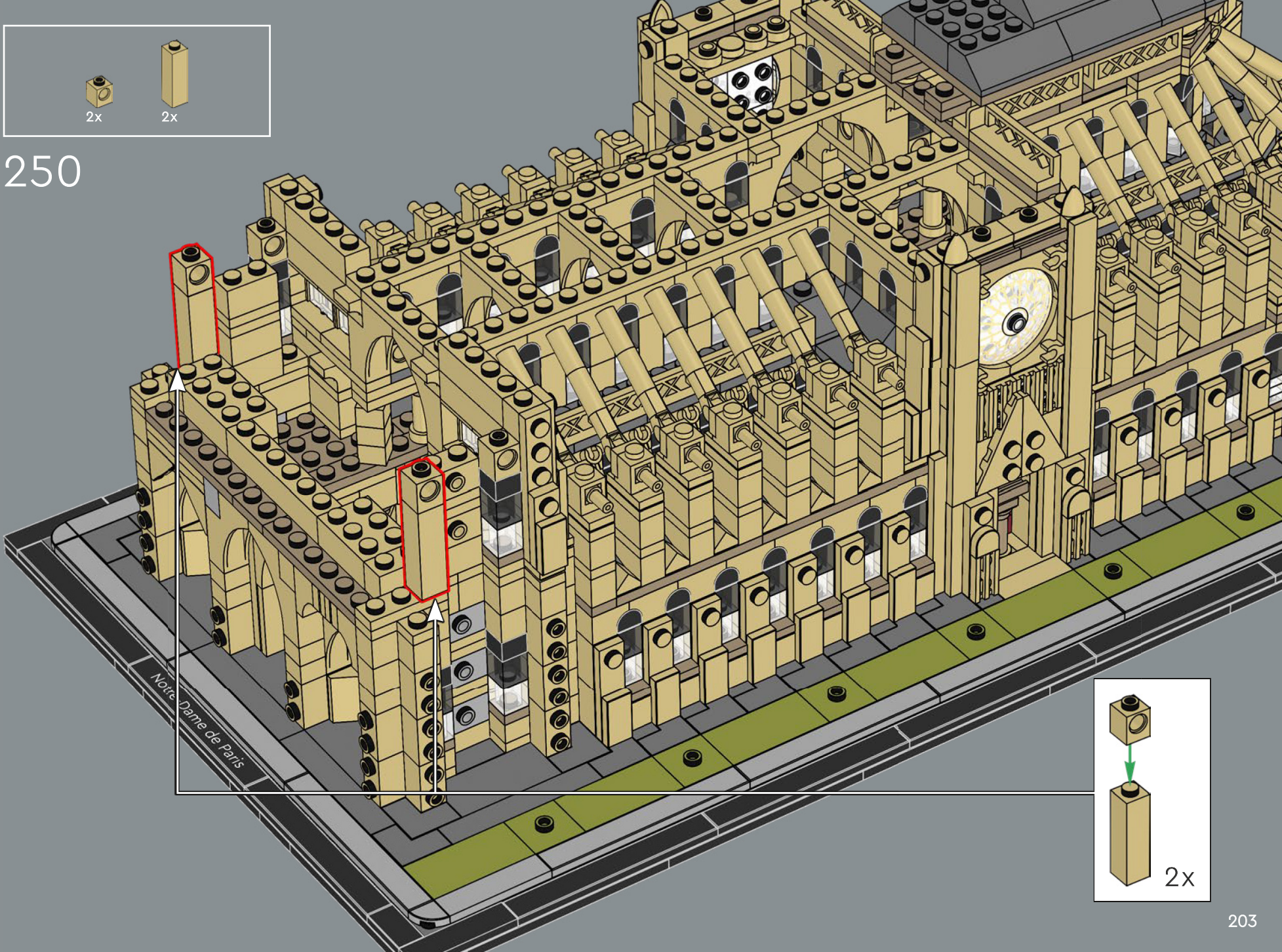

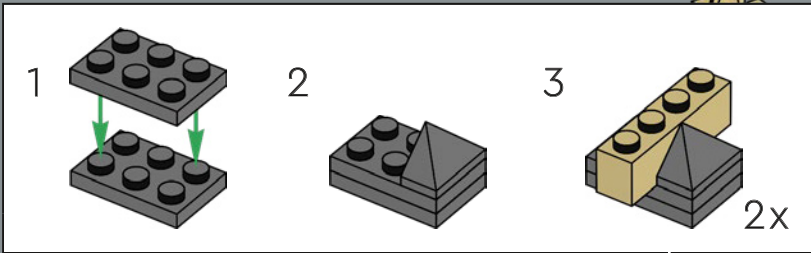
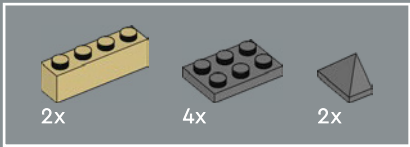

251

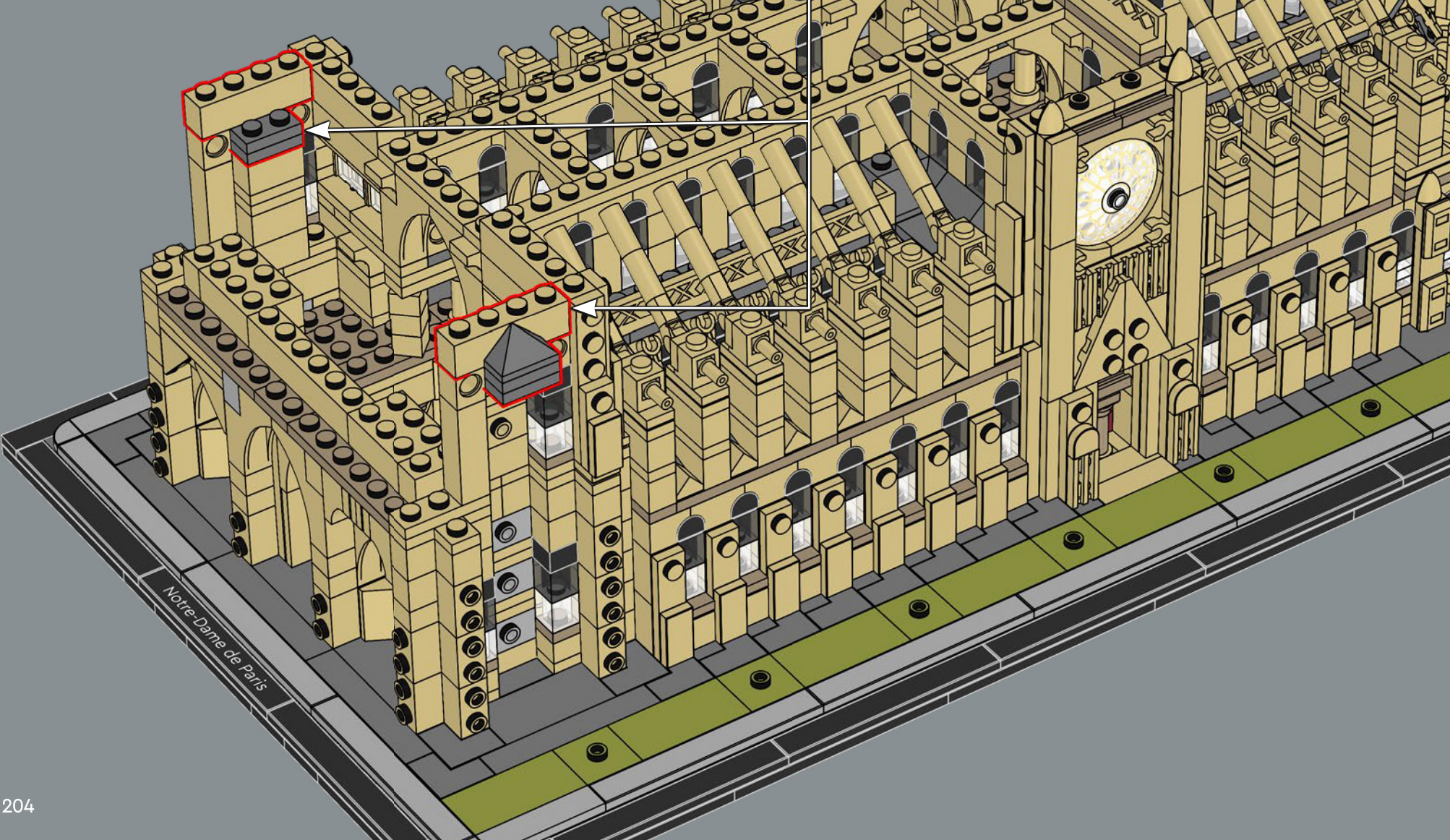

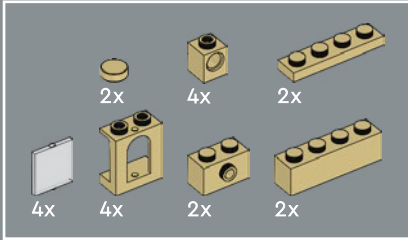
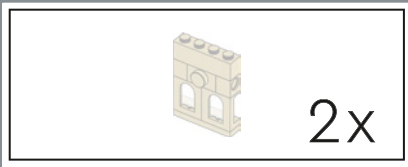

252

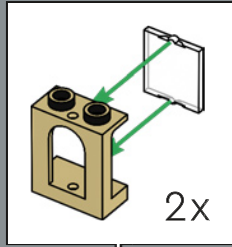

1

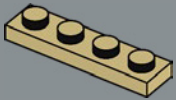

2

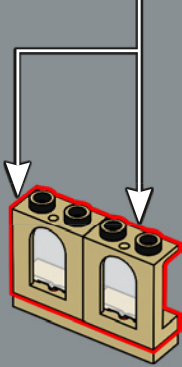

3

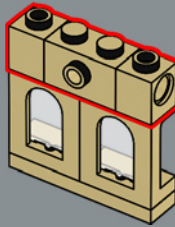

4

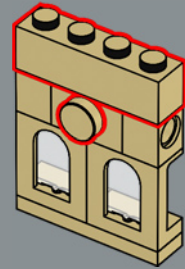

2x

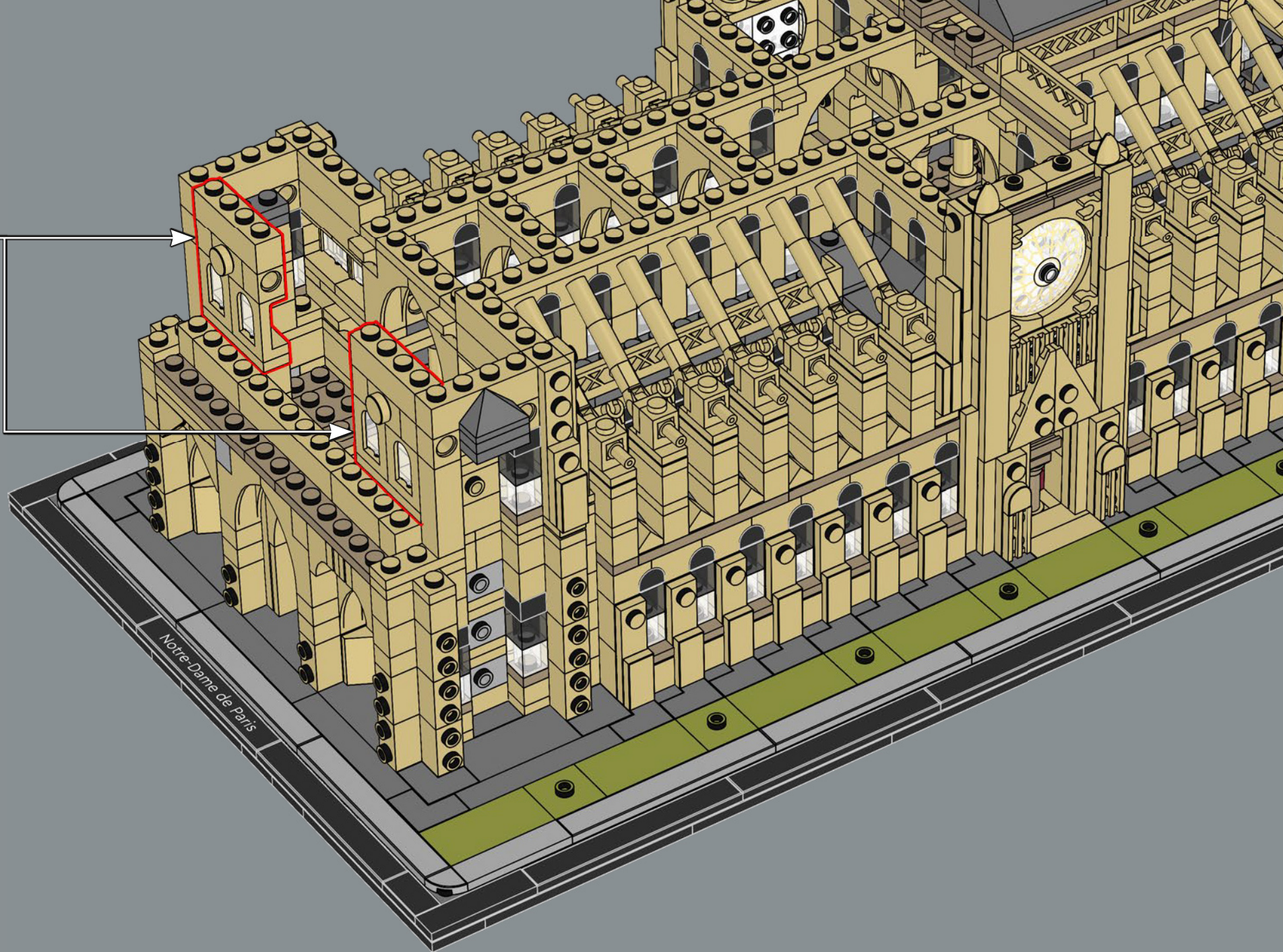

Notre-Dame de Paris

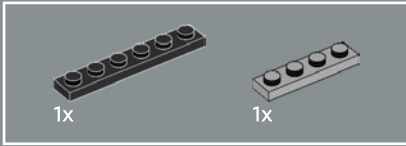
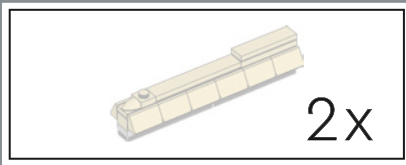

253

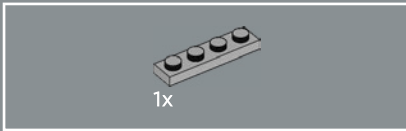
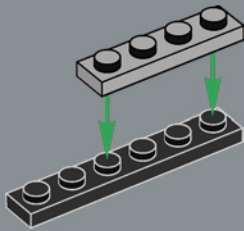

254

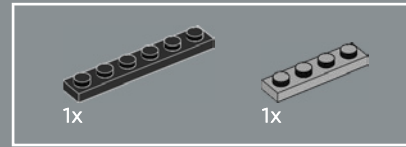
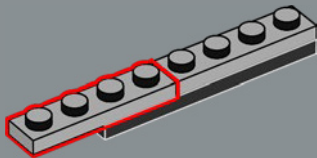

255

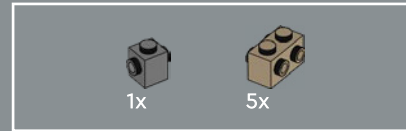
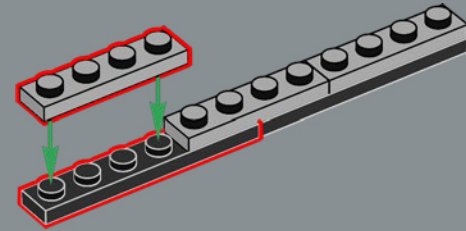

256

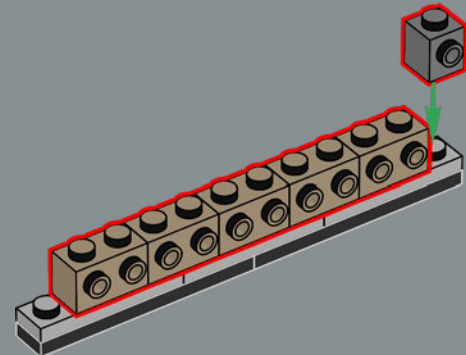

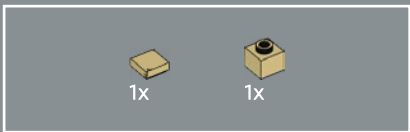

257

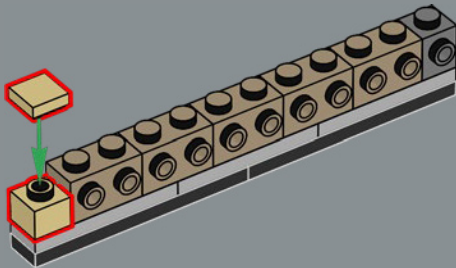

258

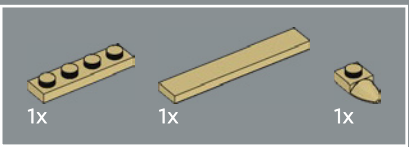
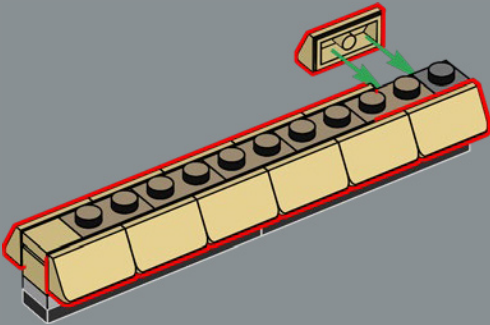

259

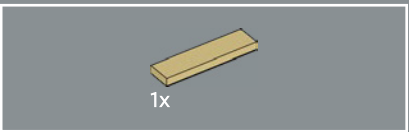
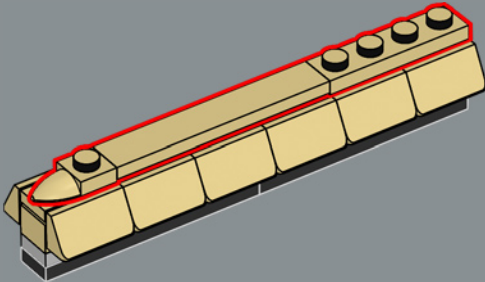

260

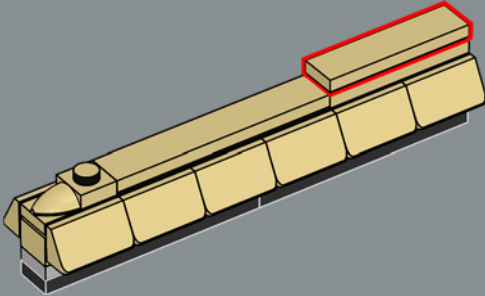

2x

261



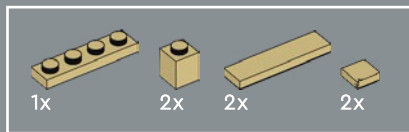

262

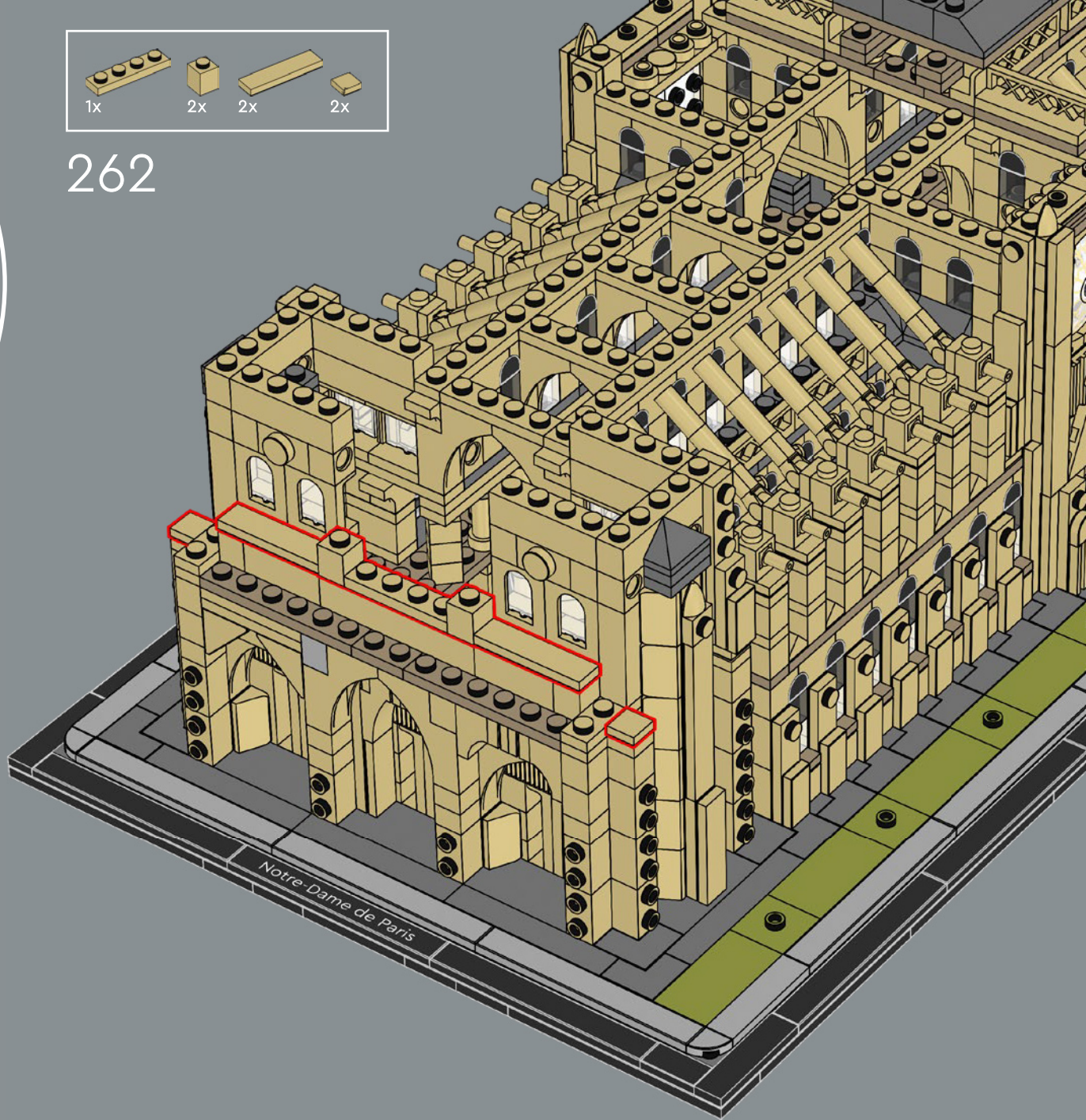



263



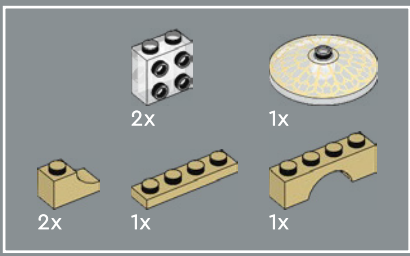

264

1

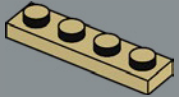

2

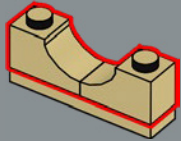

3

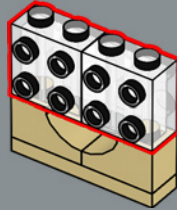

4

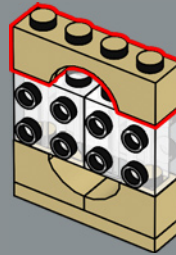

5



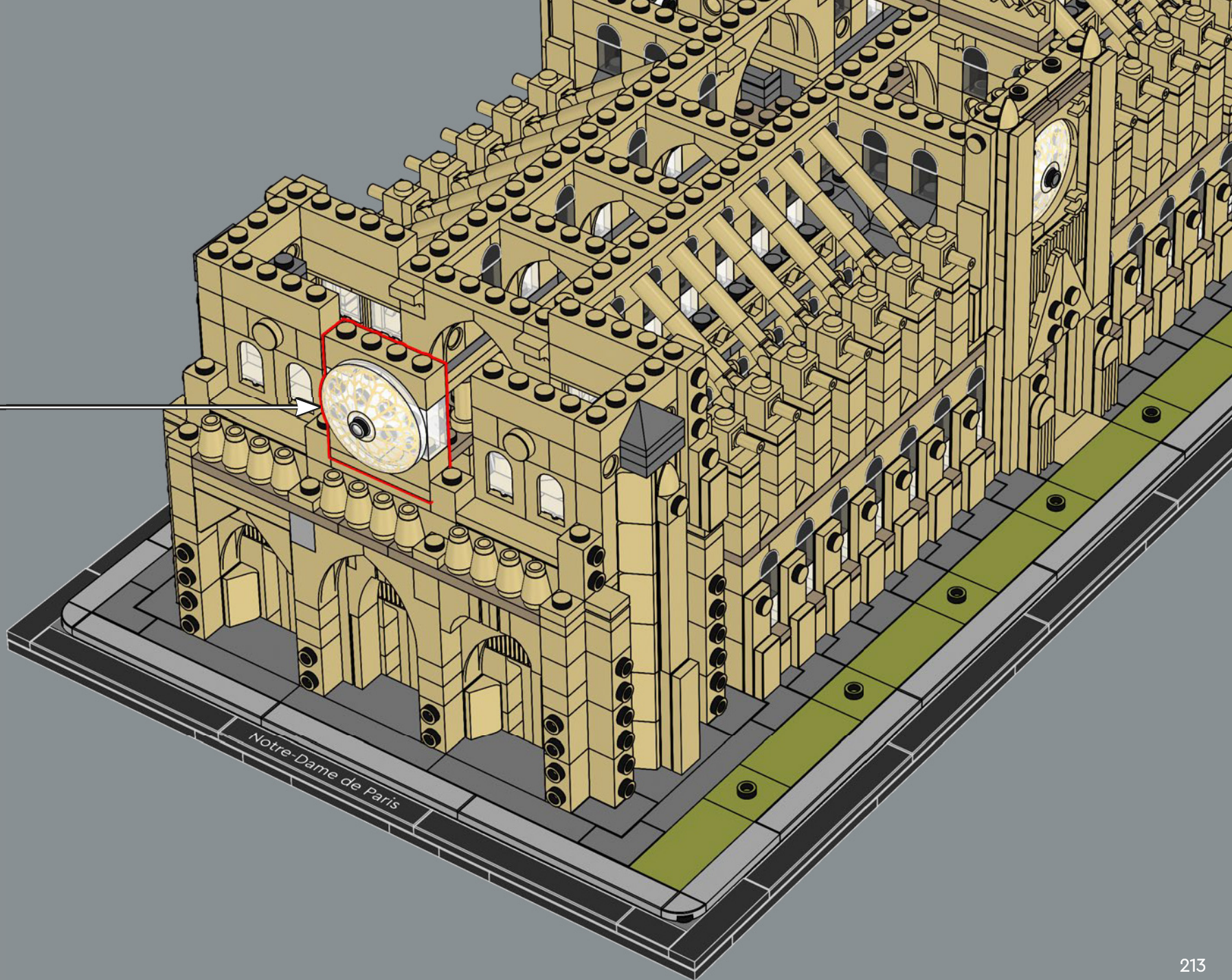

Notre-Dame de Paris

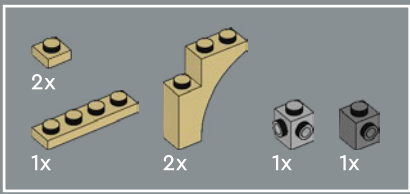

265

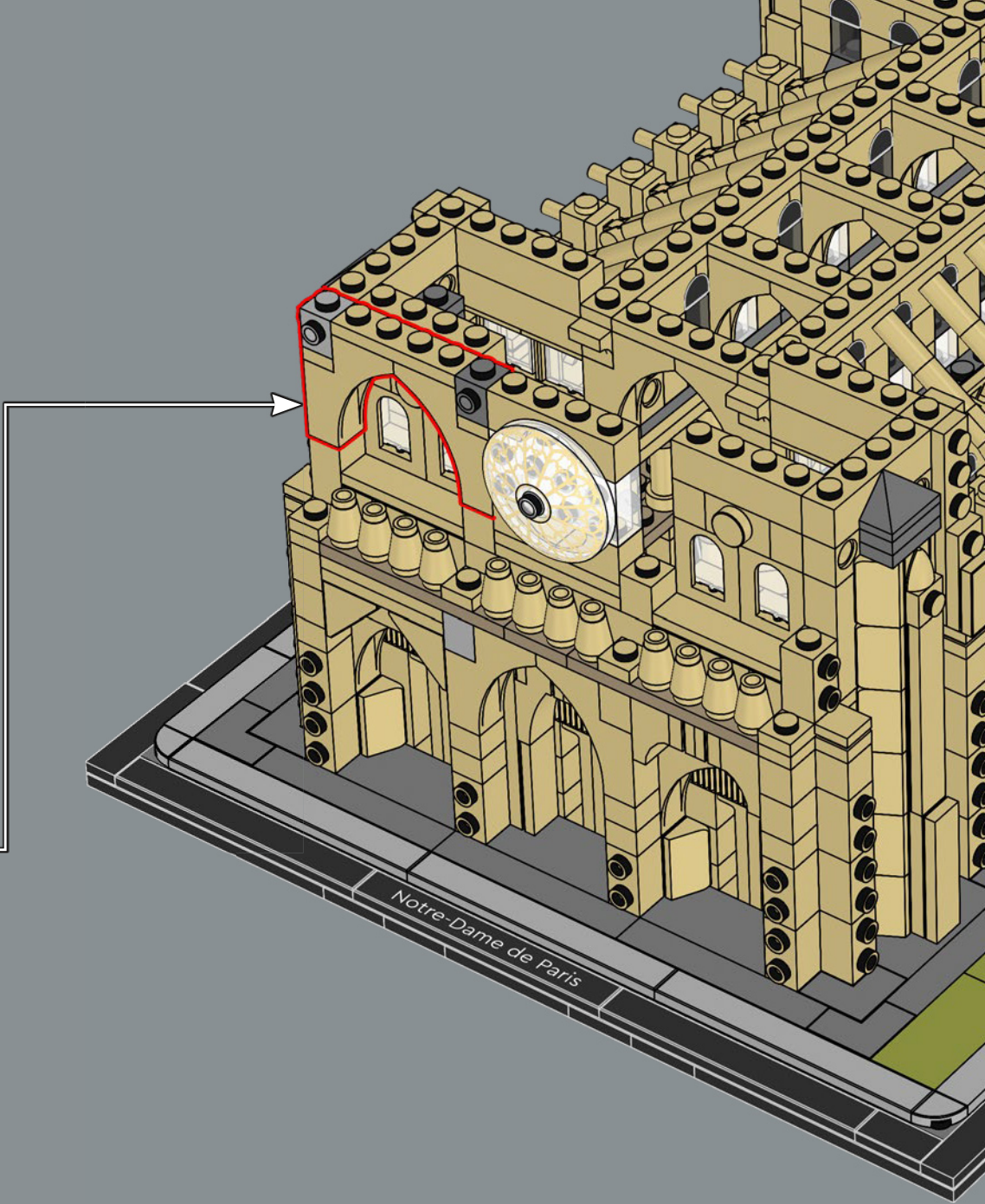
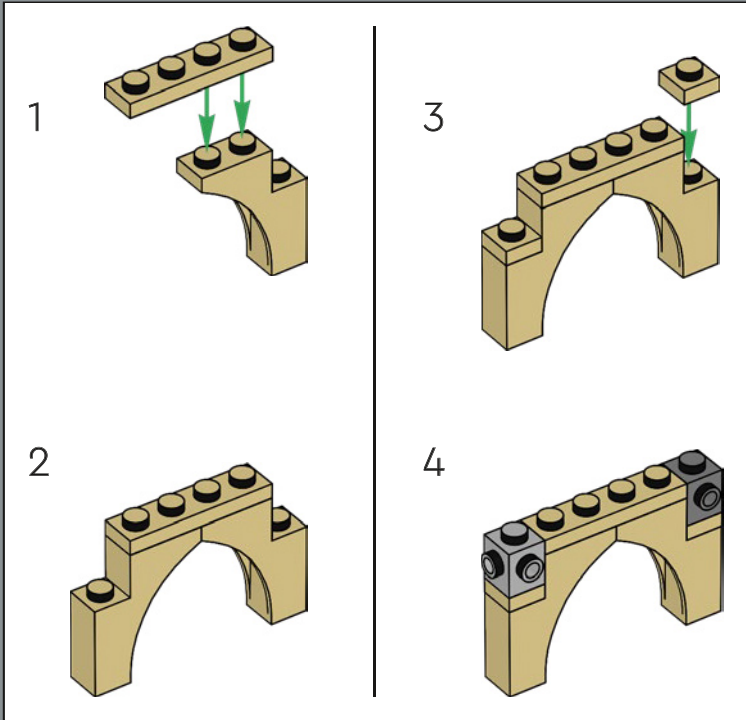

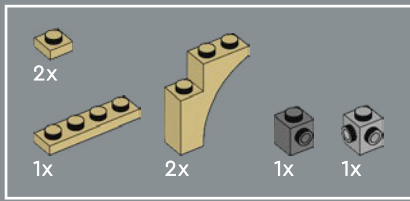

266

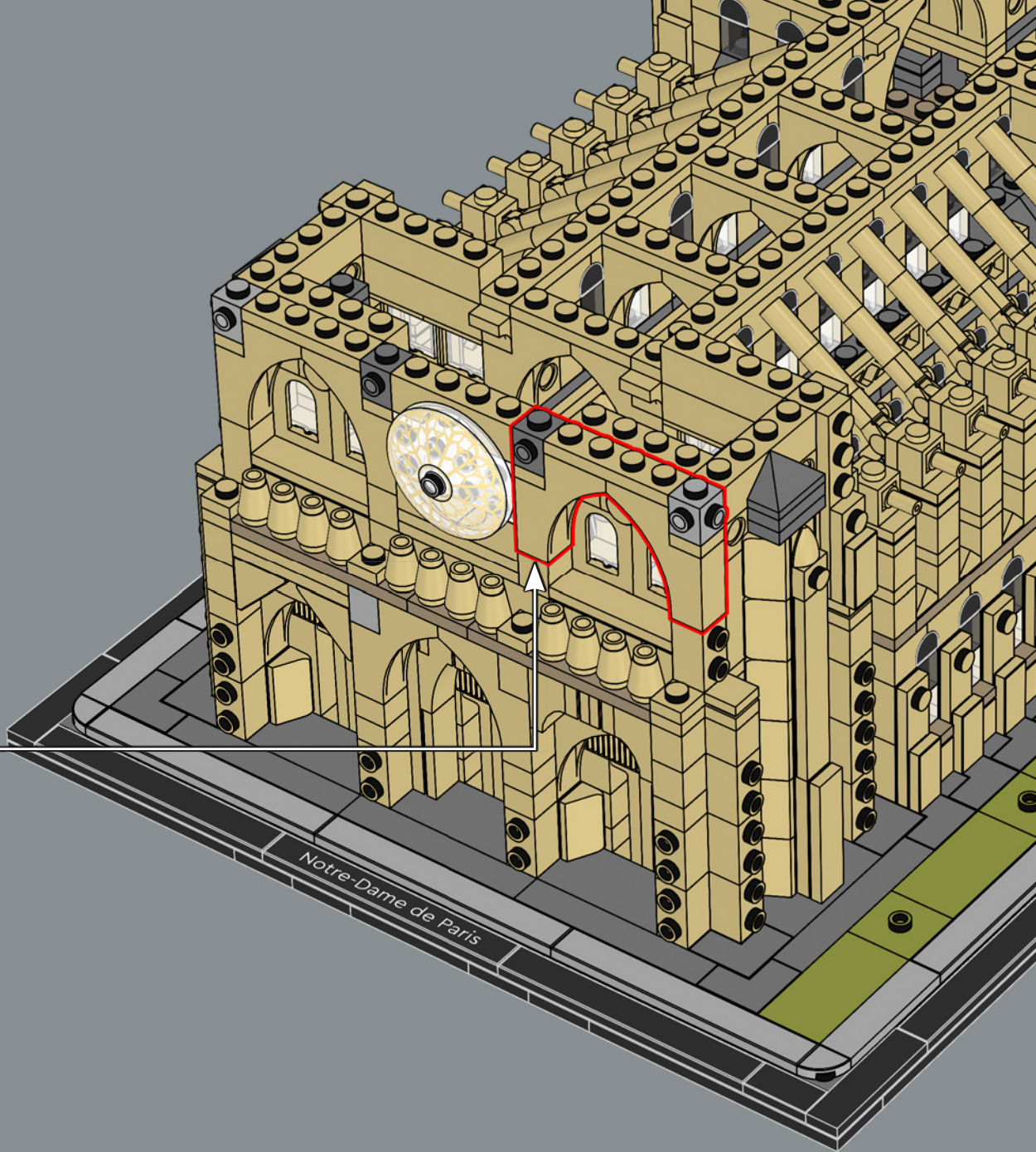
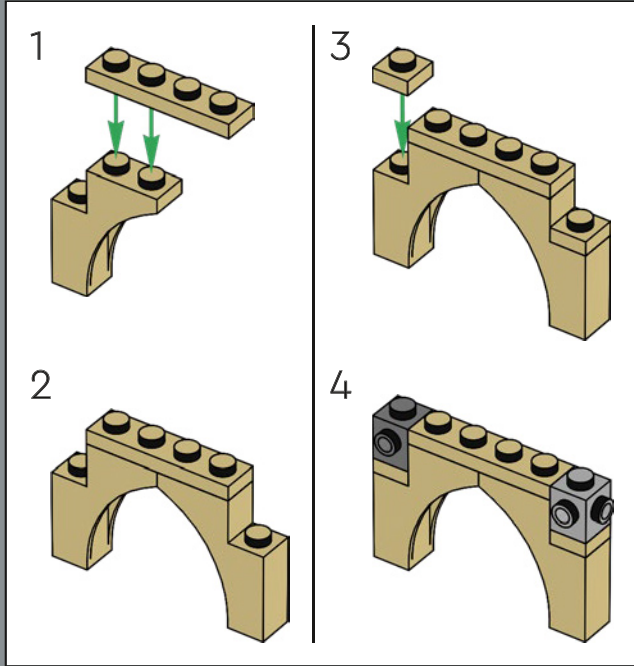

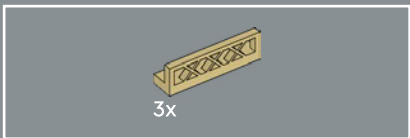

267

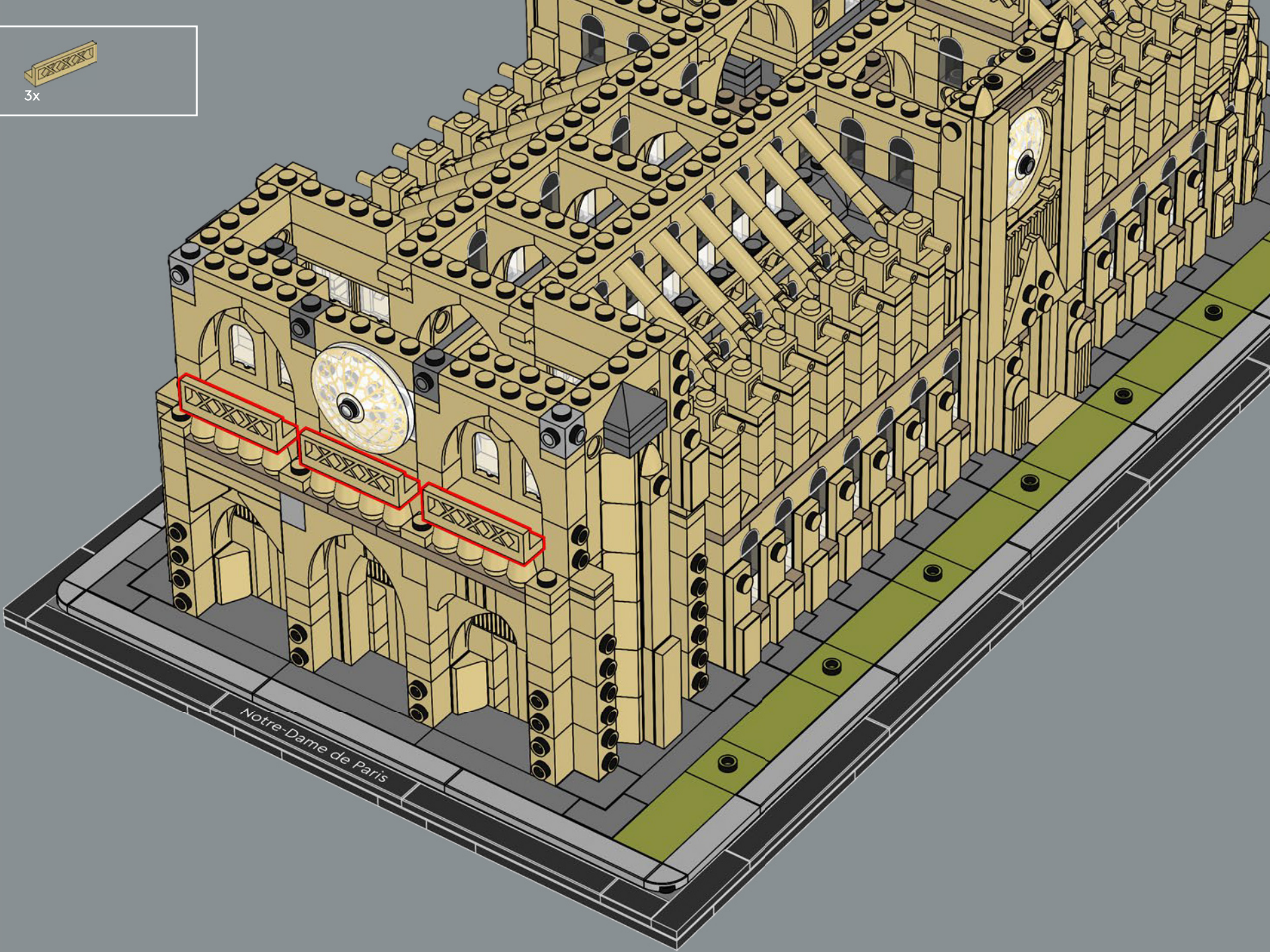

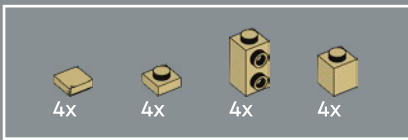

268

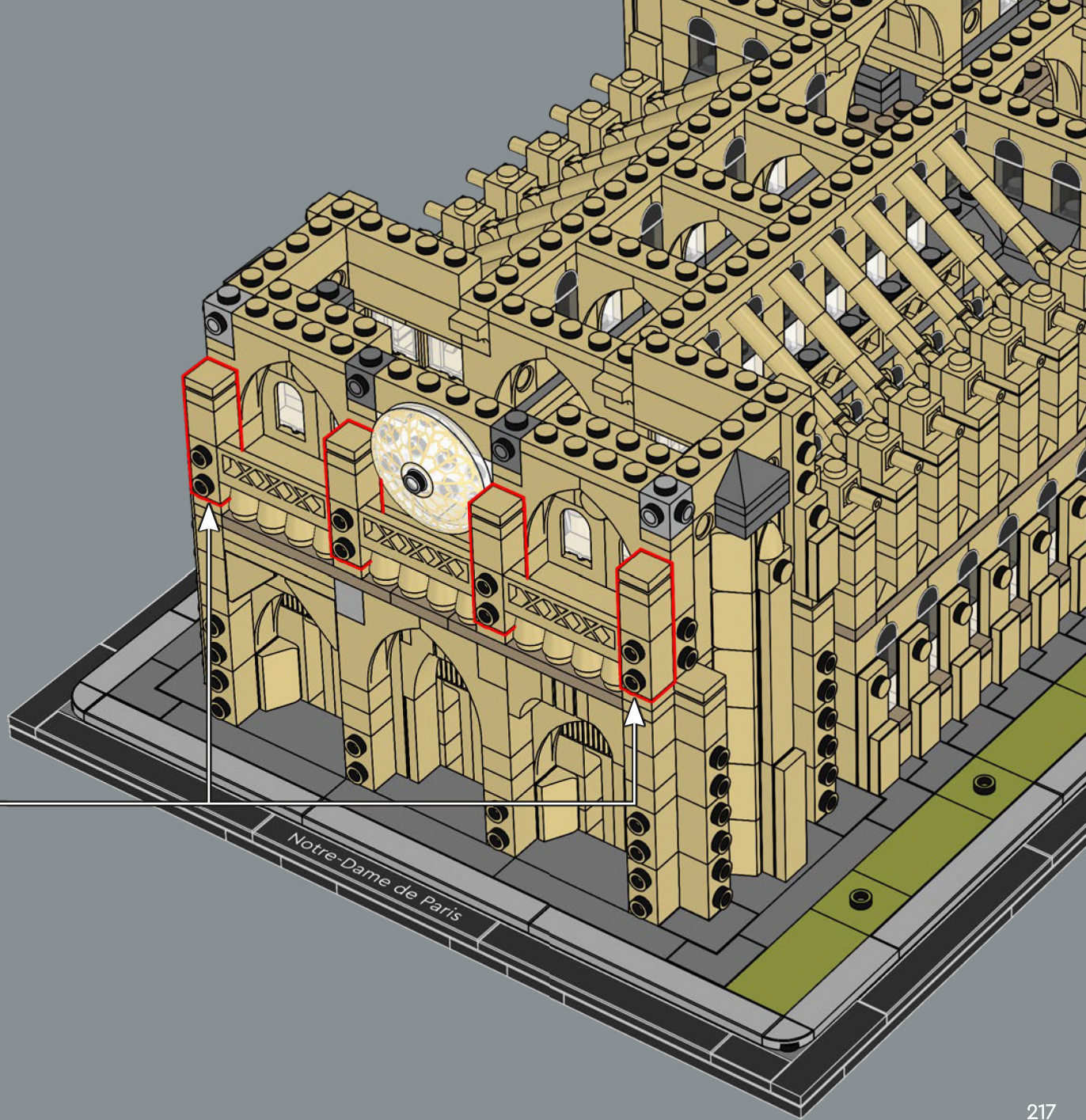
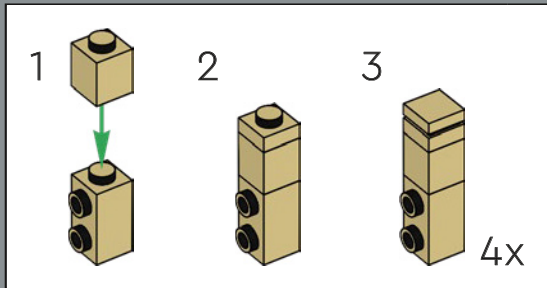

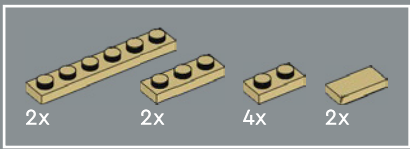

269

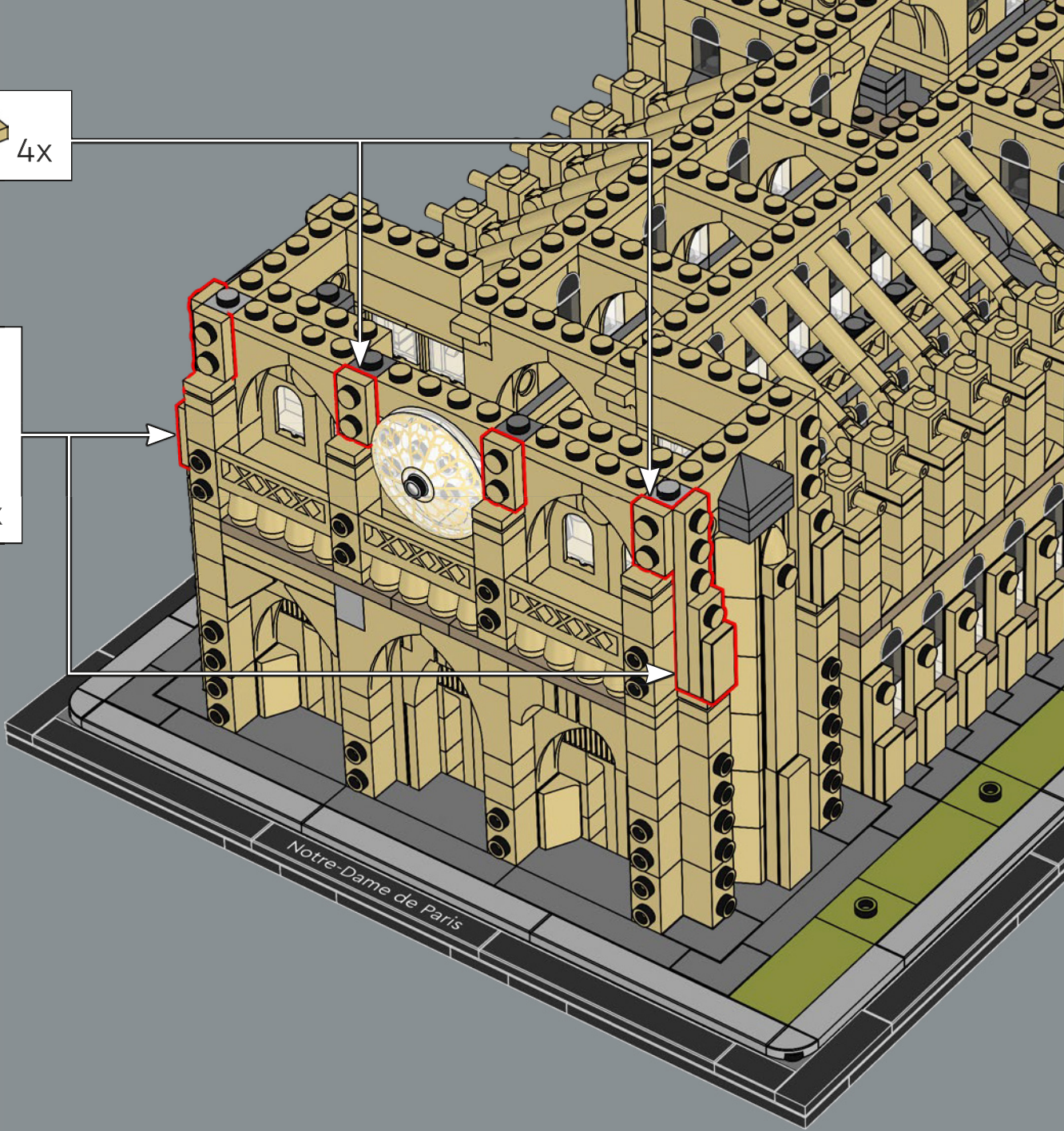
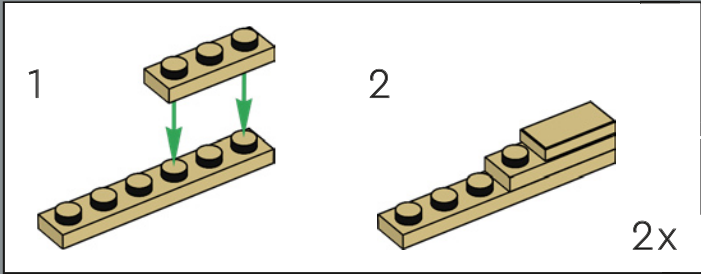
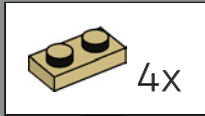

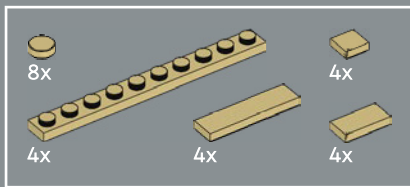

1220 – Three portals, overseen by the Gallery of Kings, welcome visitors through a majestic entrance to the cathedral. The 28 colossal statues are represented by 20 LEGO® cones and round elements.

270

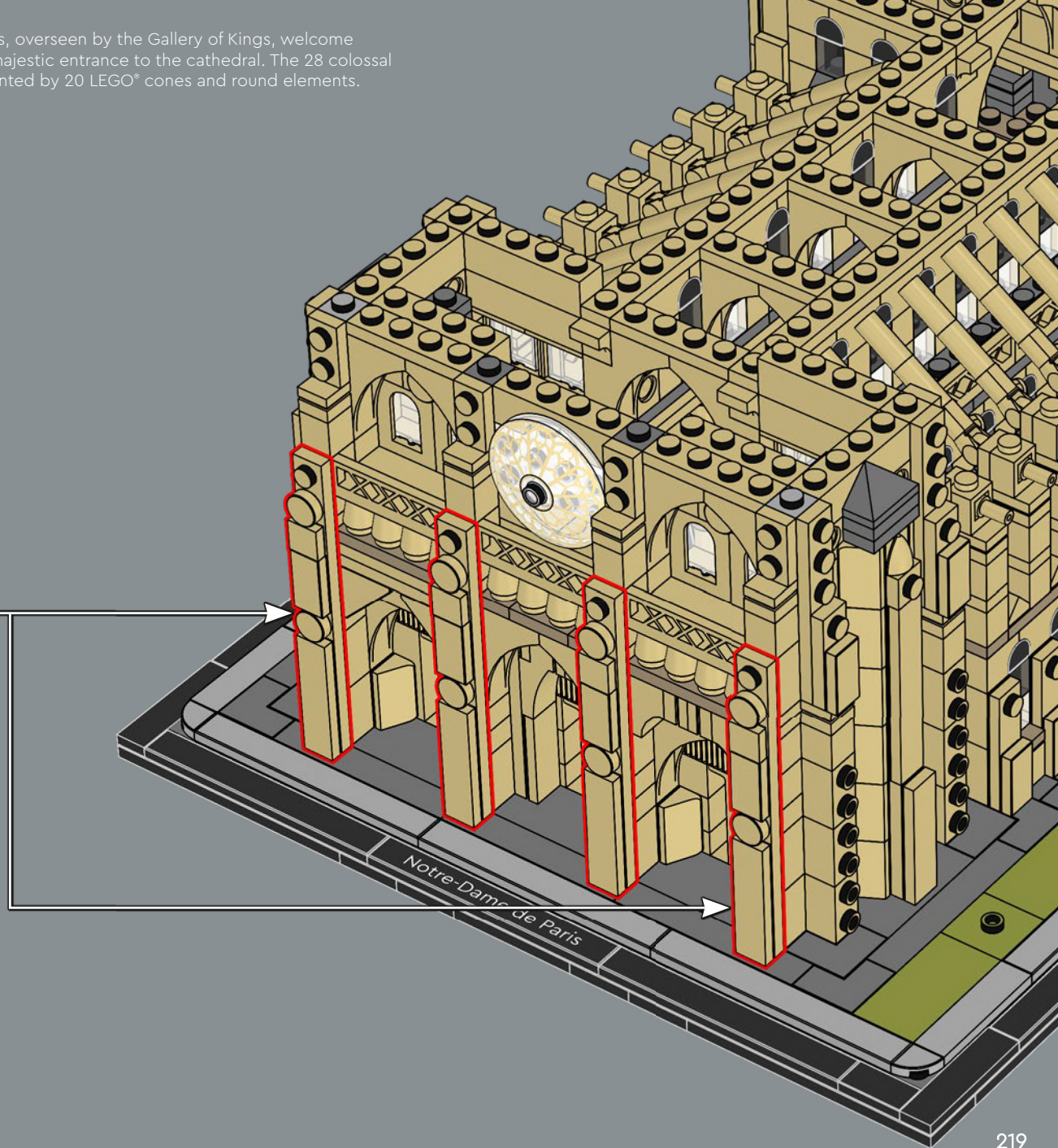
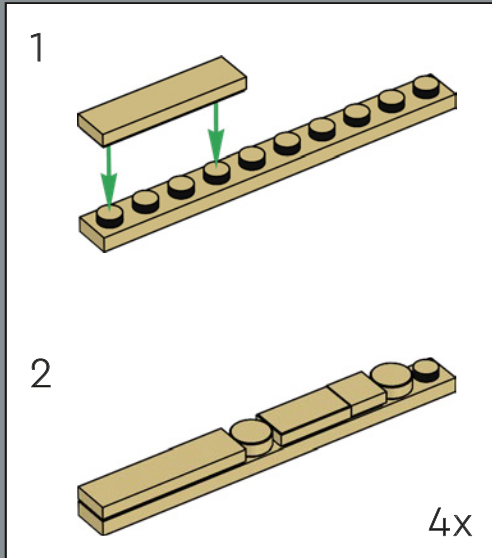

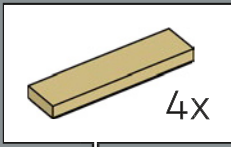
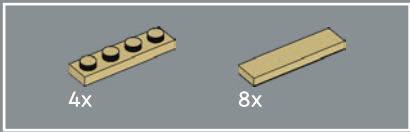

271

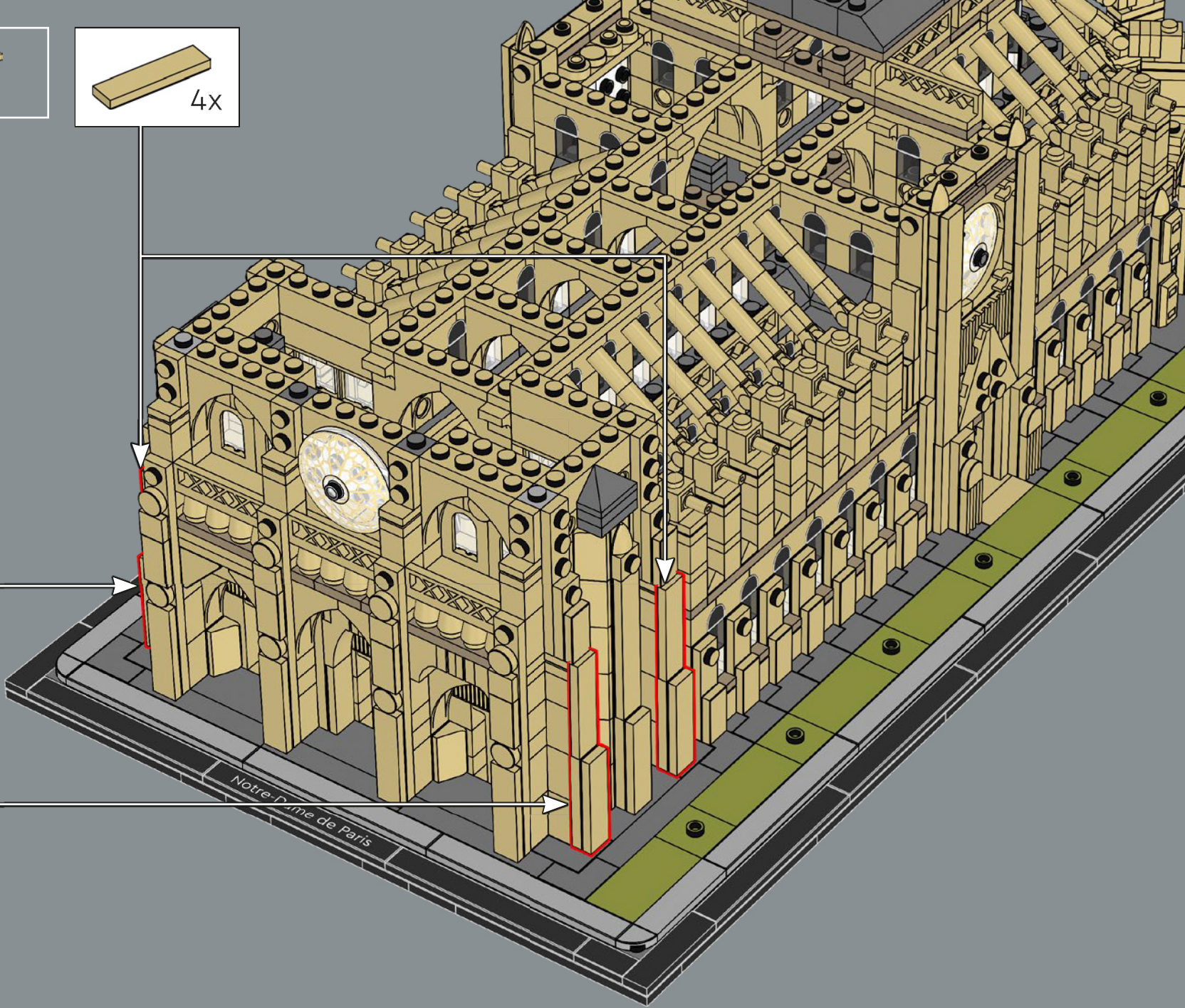
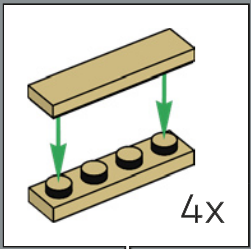

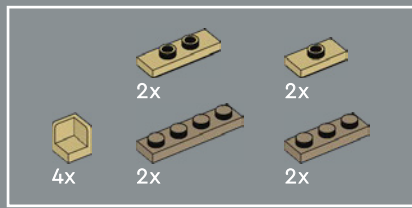

272

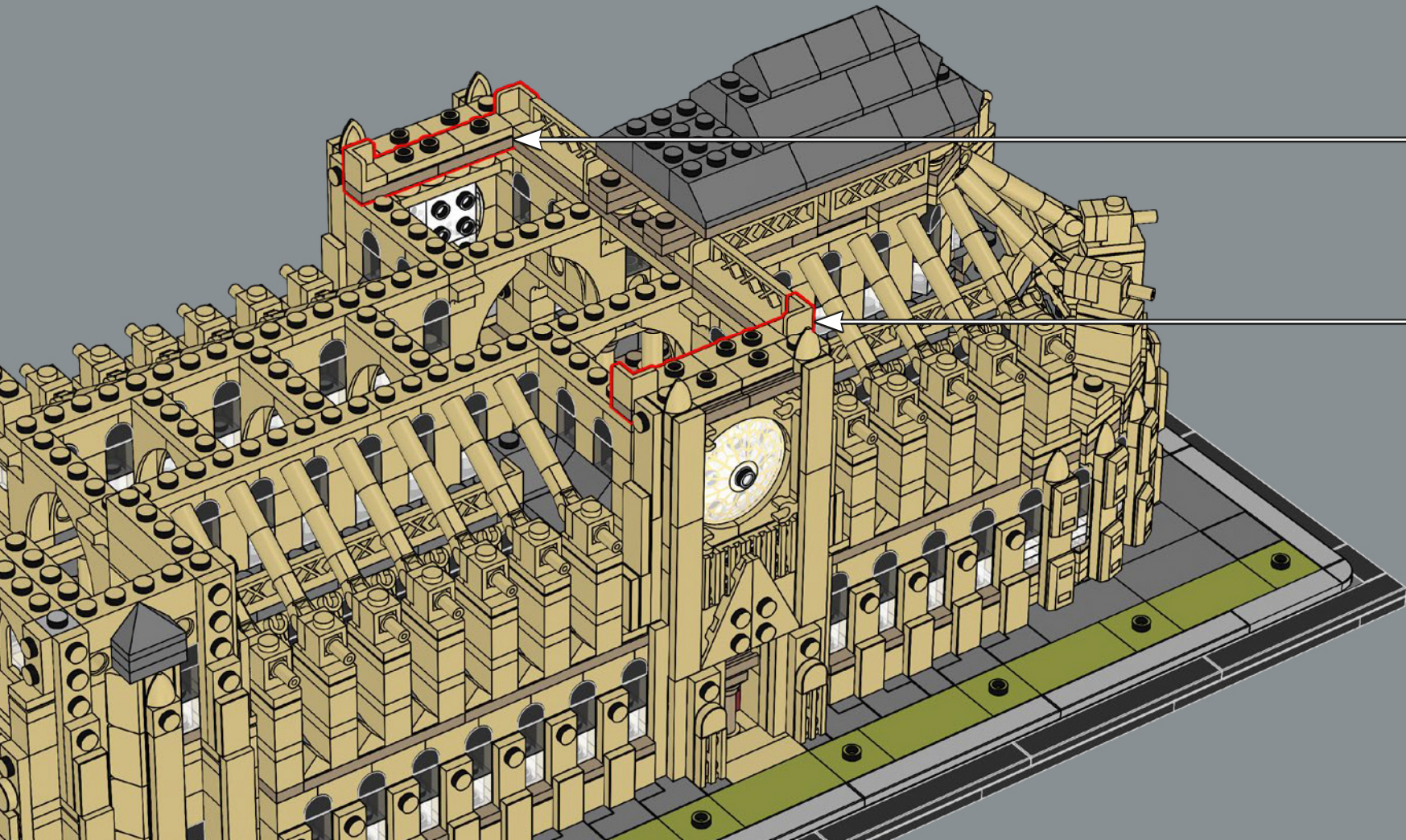
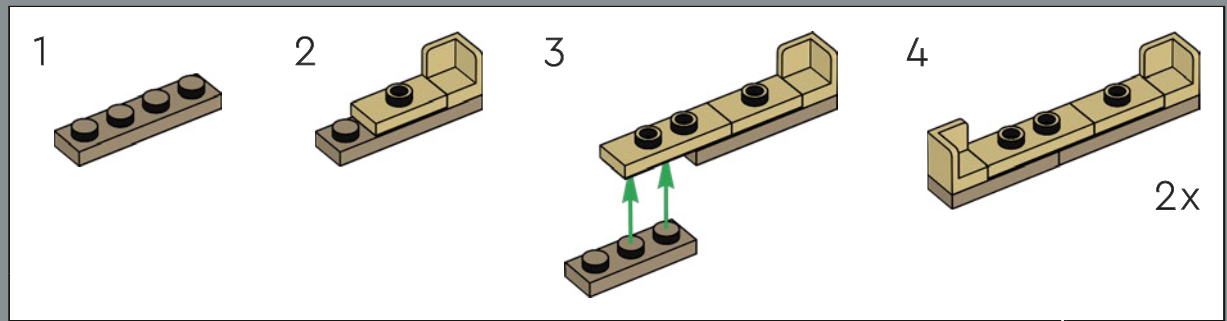

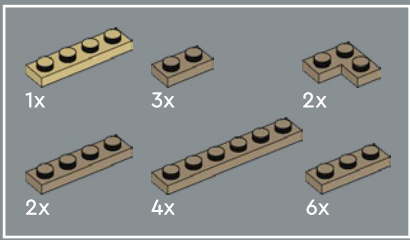

273

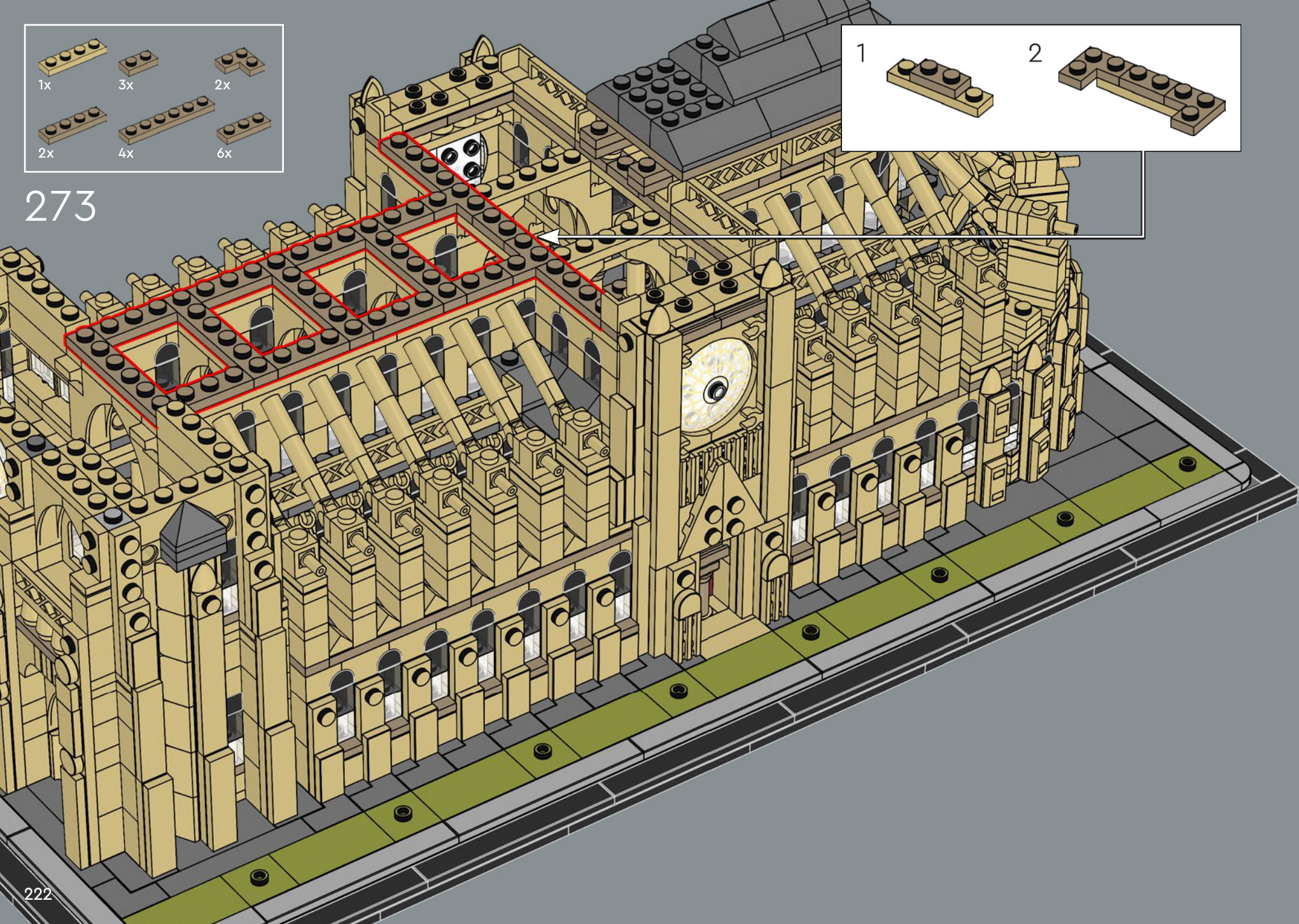
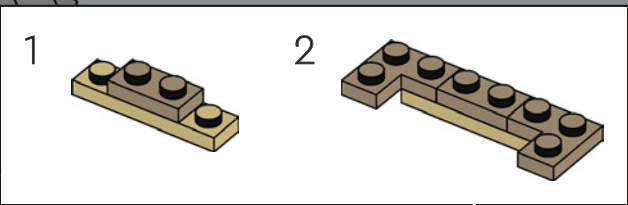

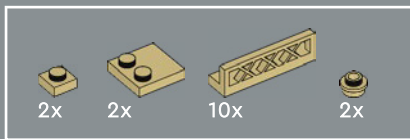

274

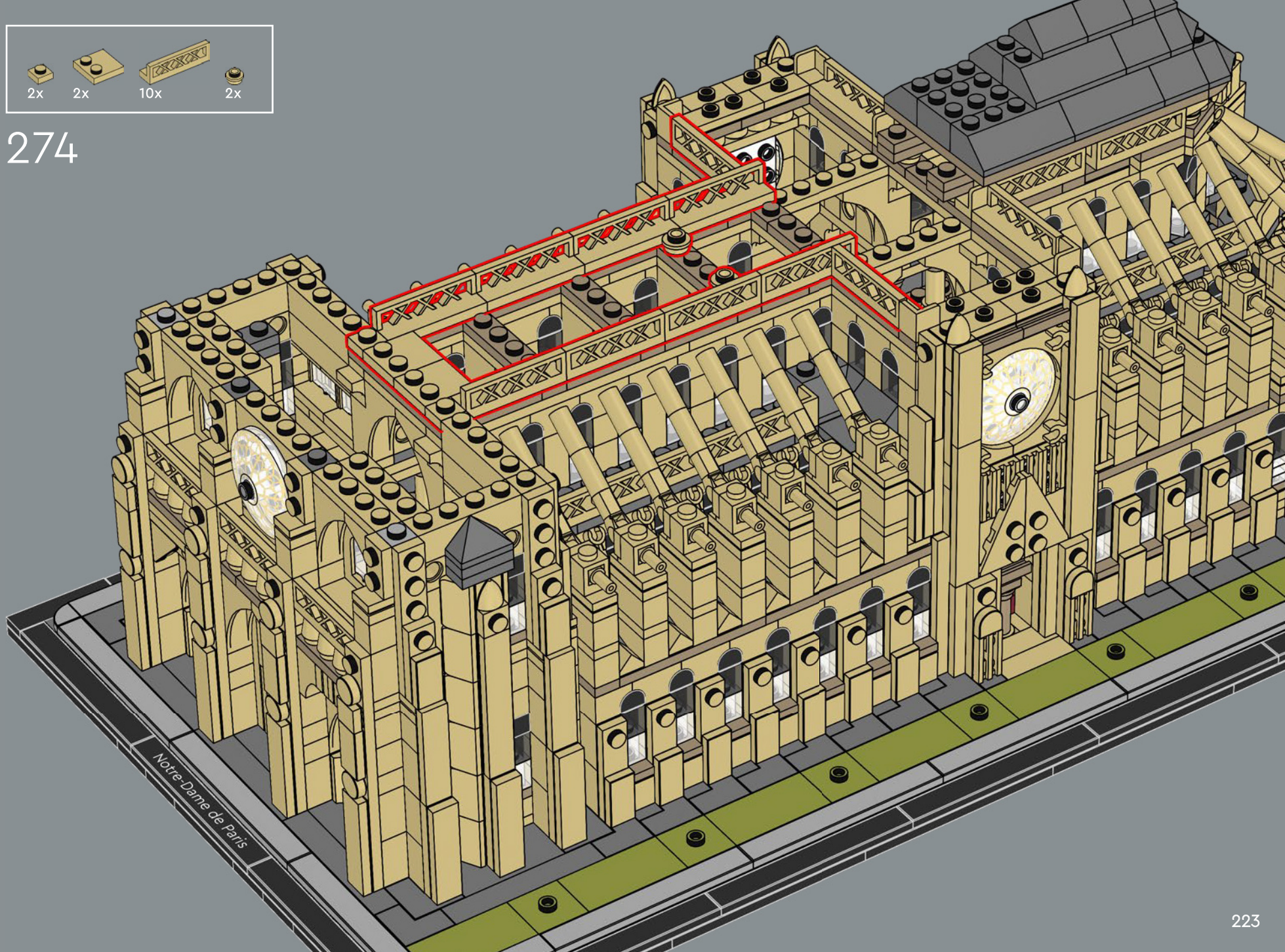

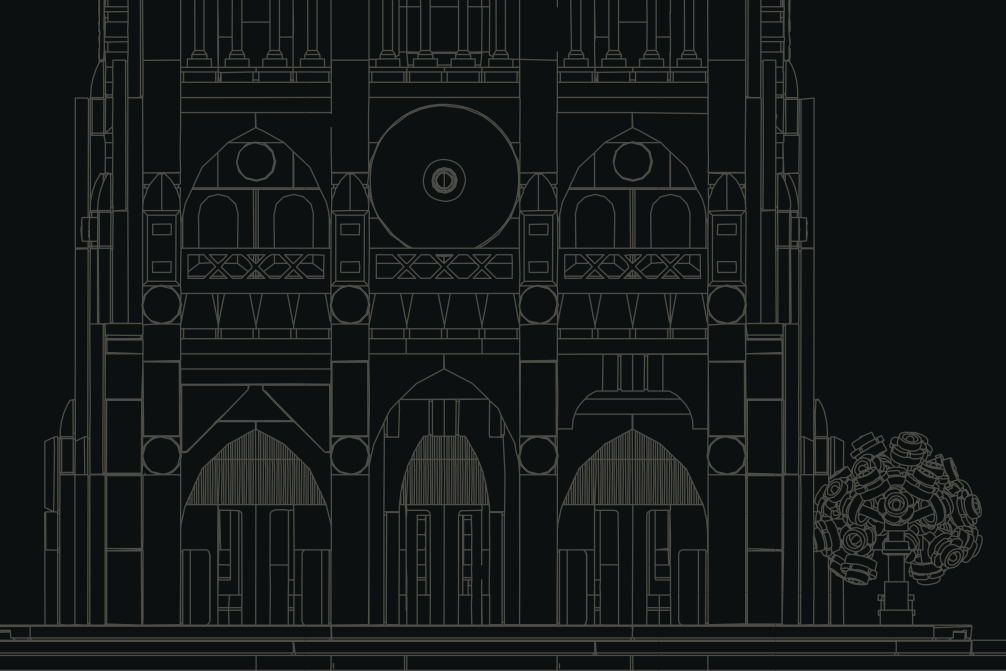

THE TRANSFORMATION CONTINUES

✂ In 1245, all towers were complete. As you build the towers, you can experience some of the inner workings of the cathedral's belfry and the superstructure that supports the legendary bells. Throughout the following five centuries, wear and tear set in. New generations of architects oversaw modifications, repairs and additions – like a lead-covered wooden spire constructed above the crossing. In 1300, the chapels were added to the perimeter of the choir.



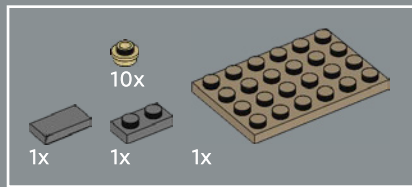

275

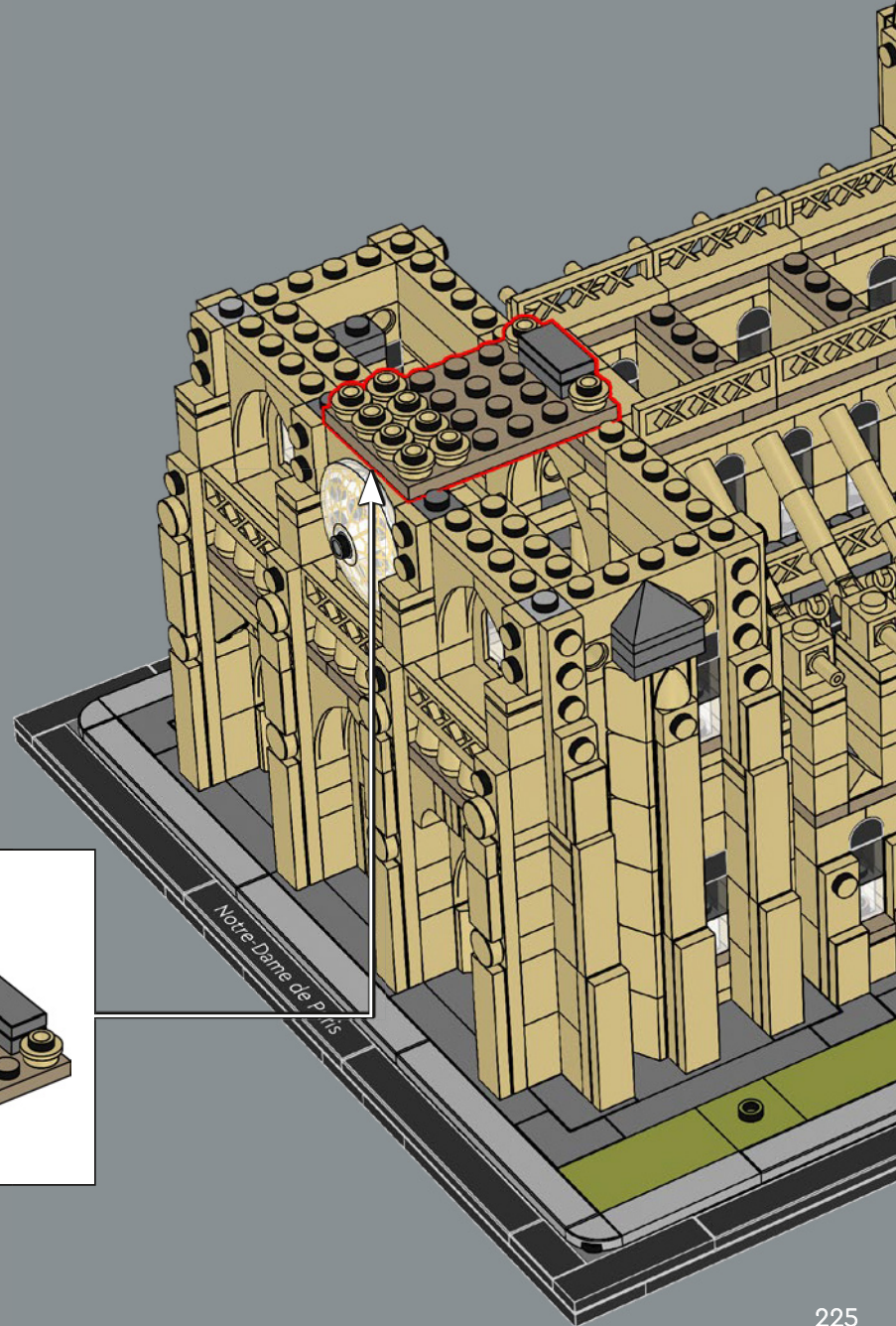
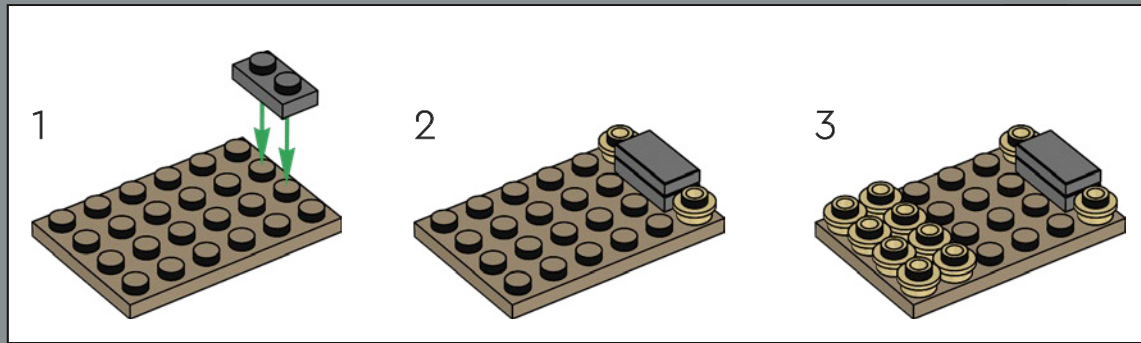

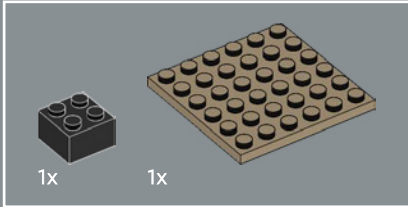
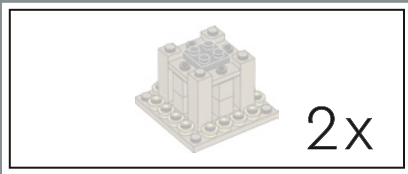

276

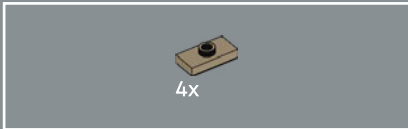
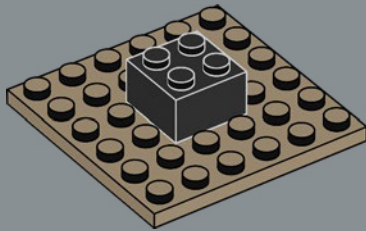

277

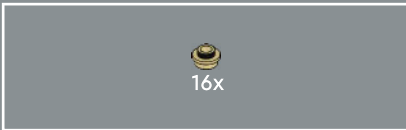
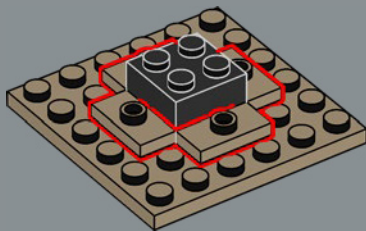

278

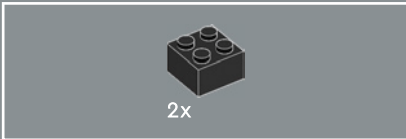
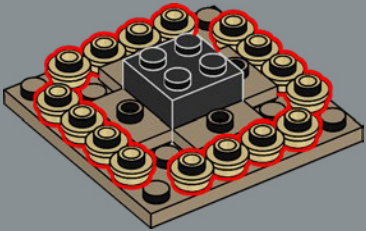

279

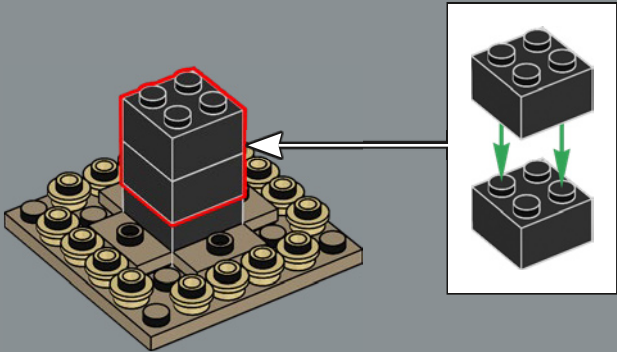



280

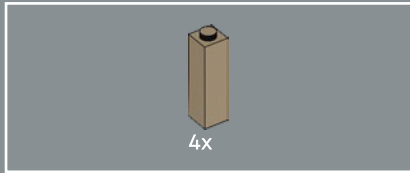
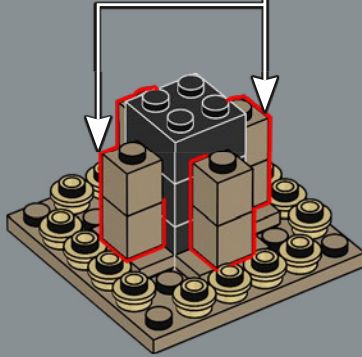
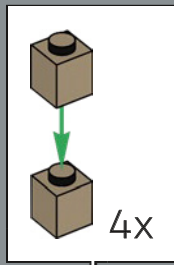

281

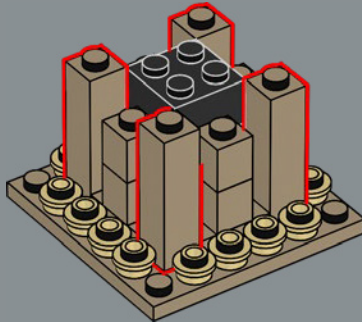

282

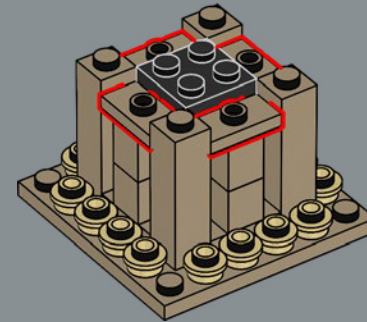

2x

283



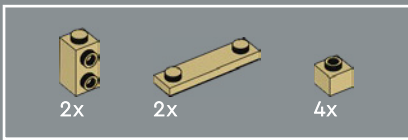

284

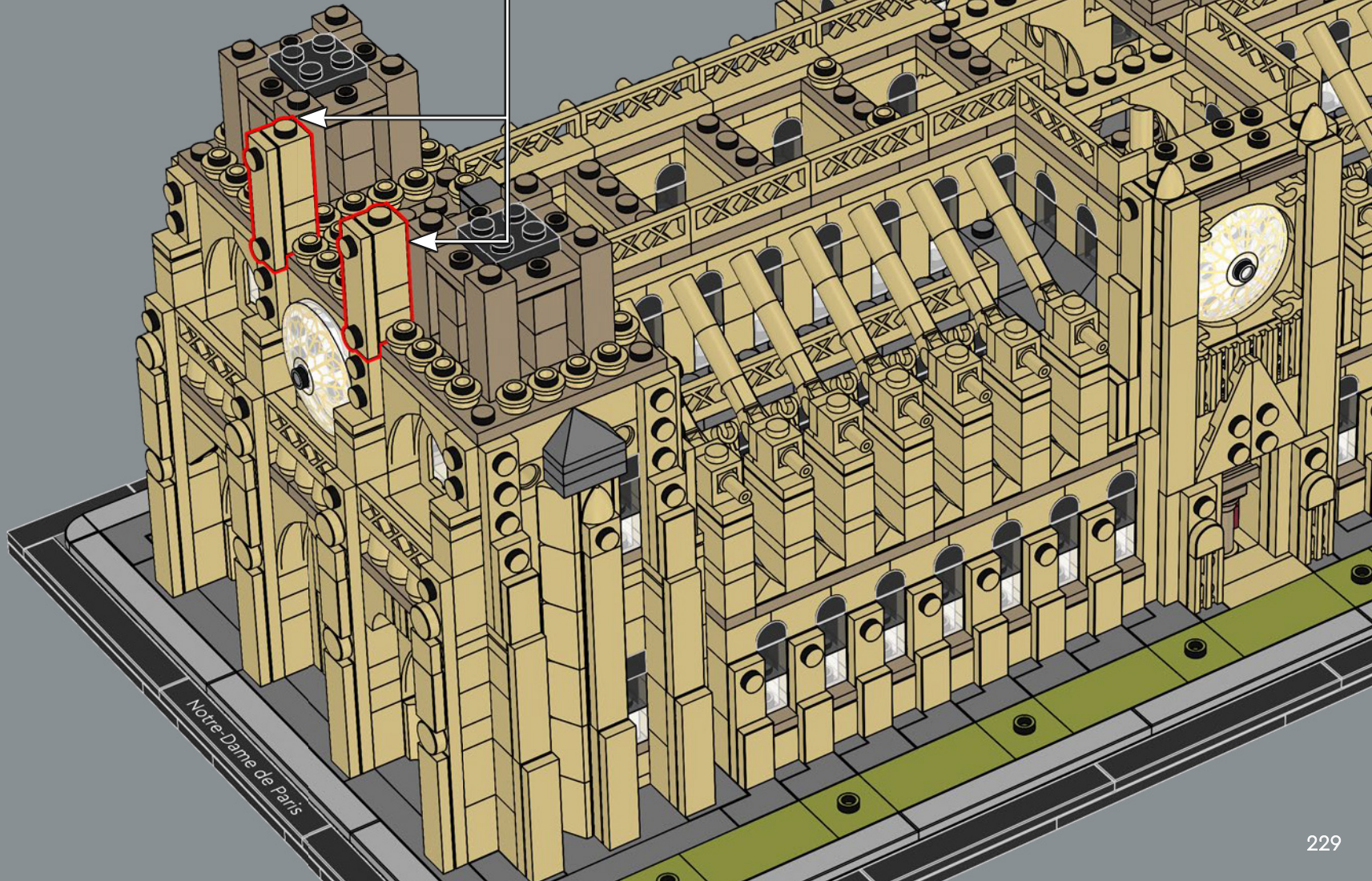
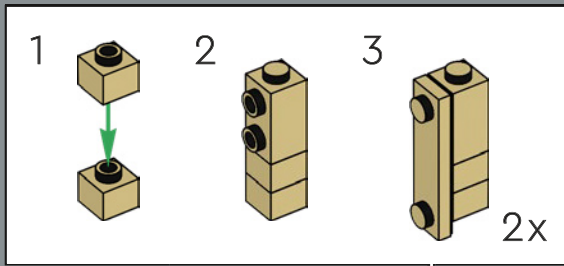



285

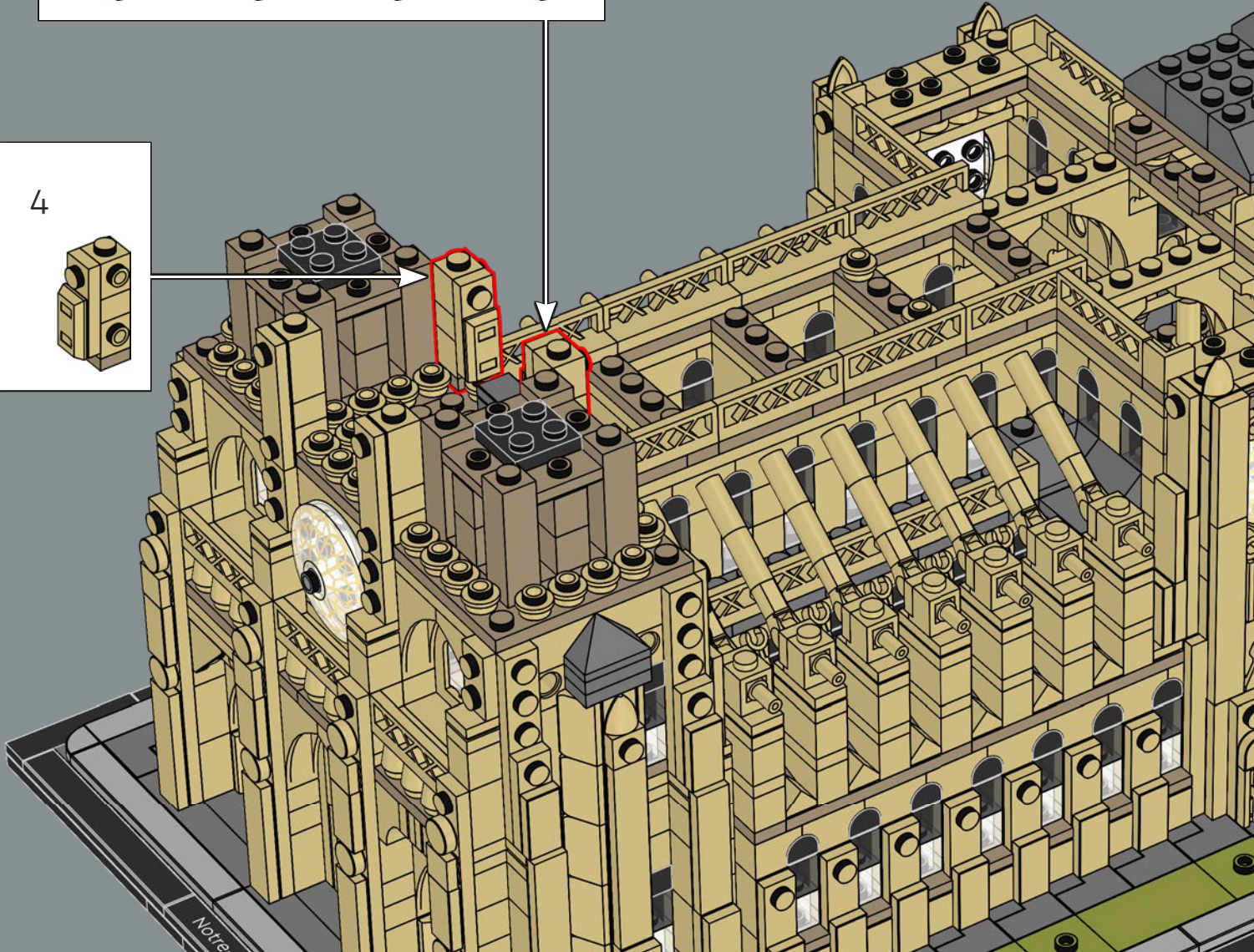
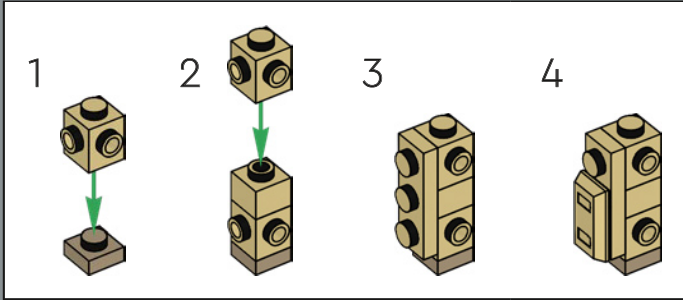
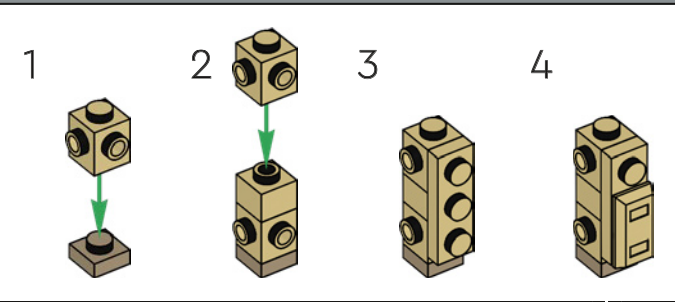

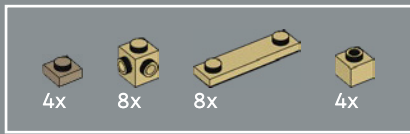

286

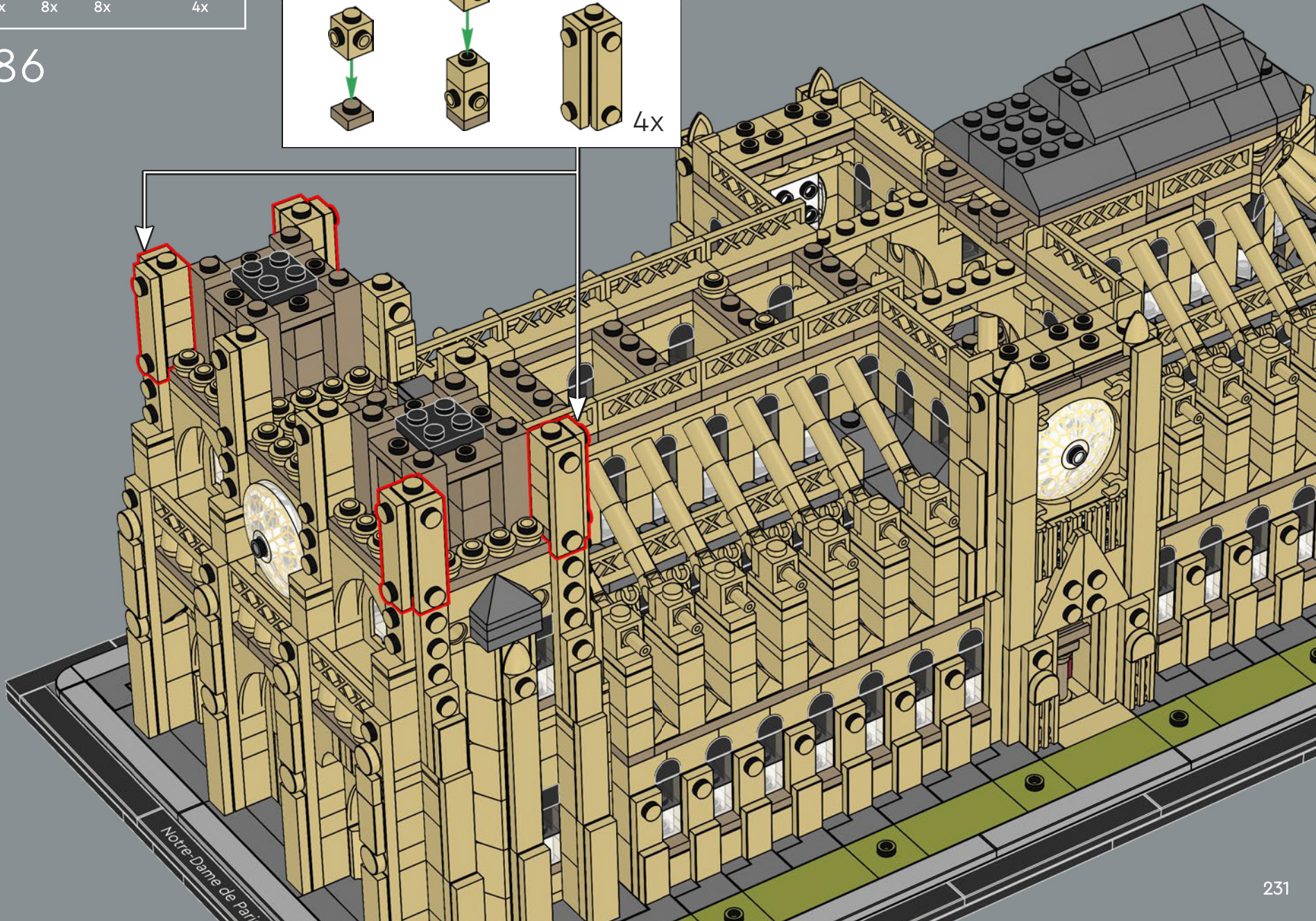
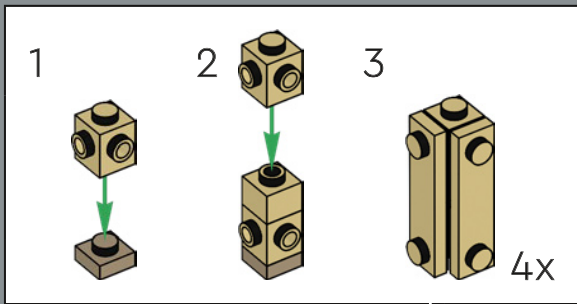

Notre-Dame de Paris

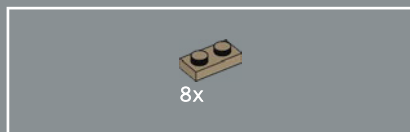

287

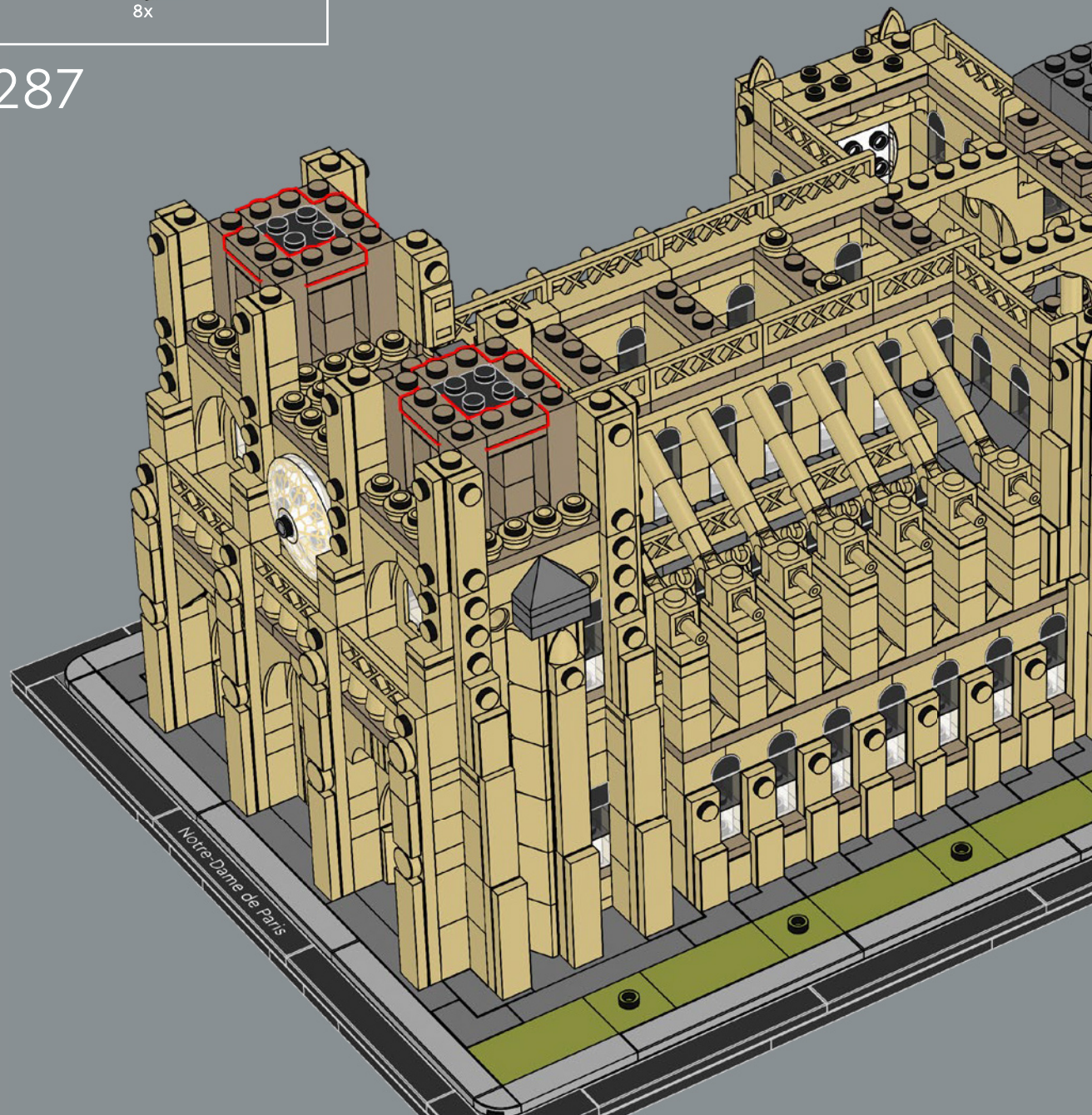



40x

288

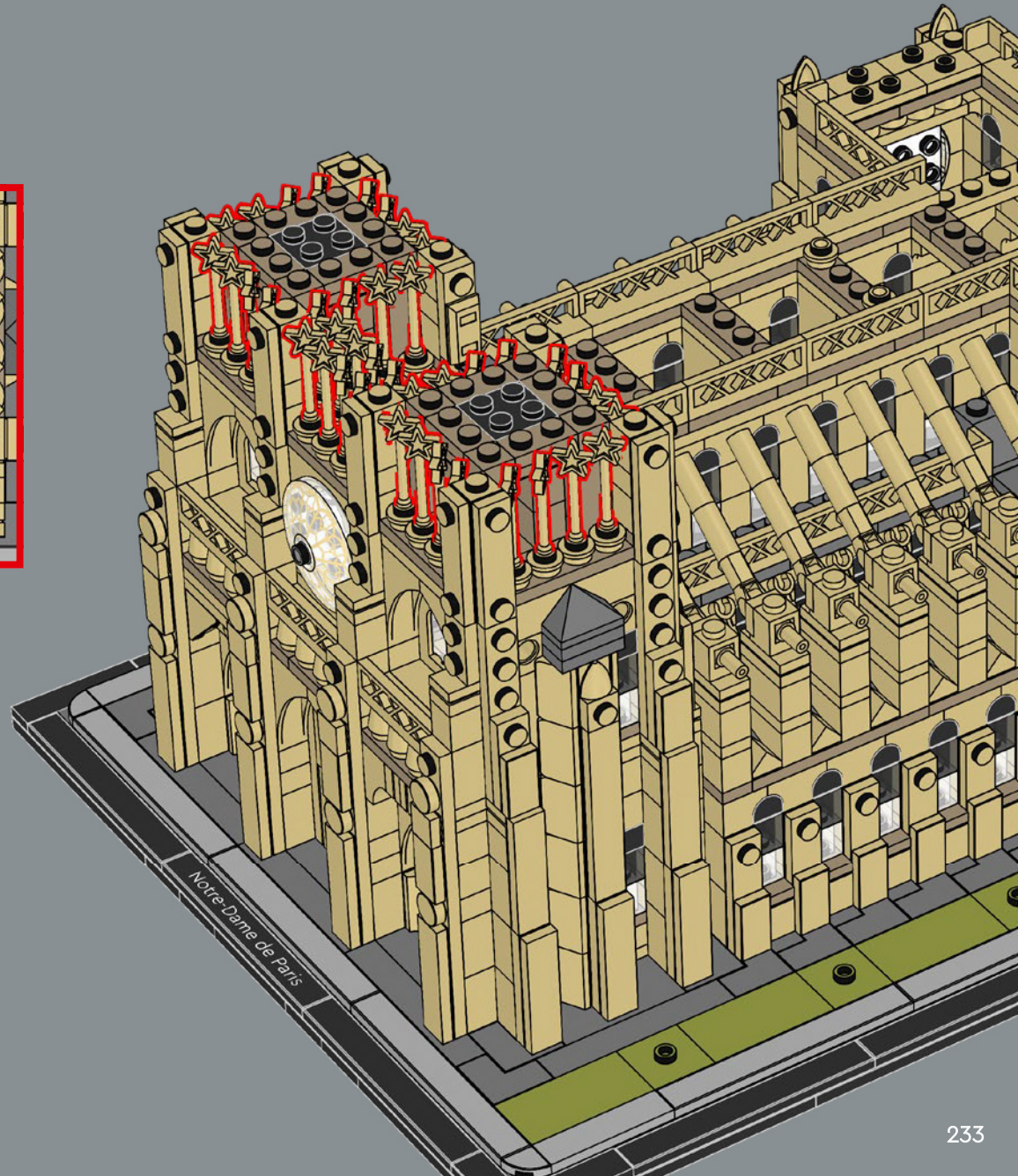
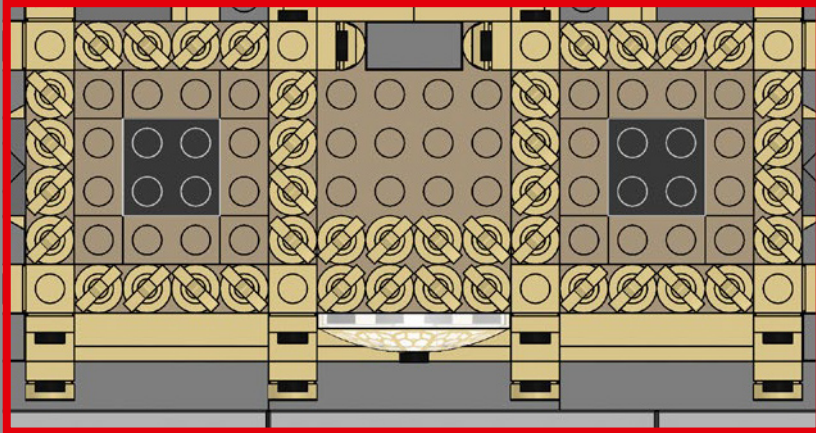

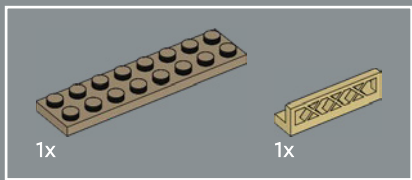

289

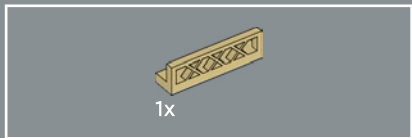
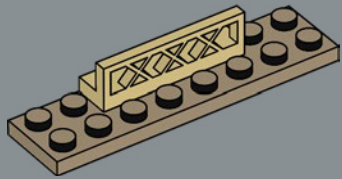

290

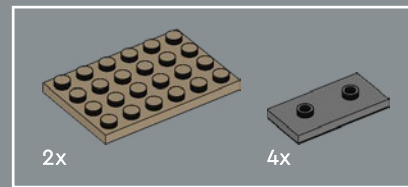
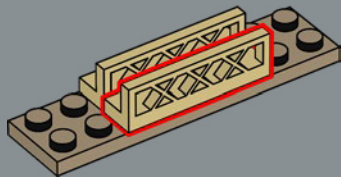

291

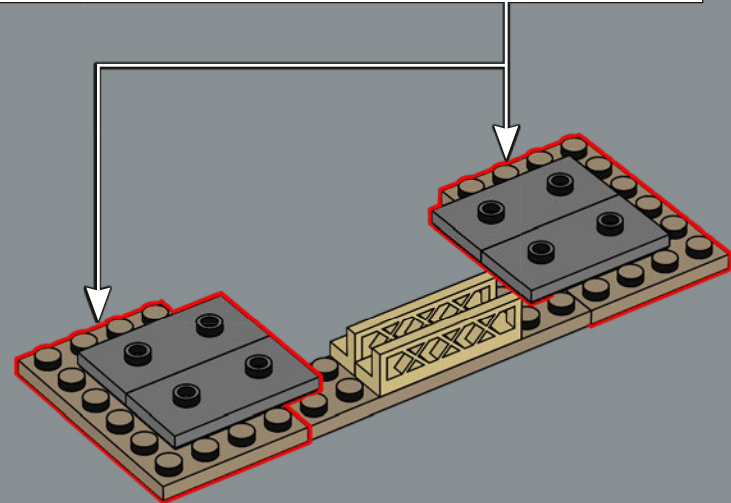
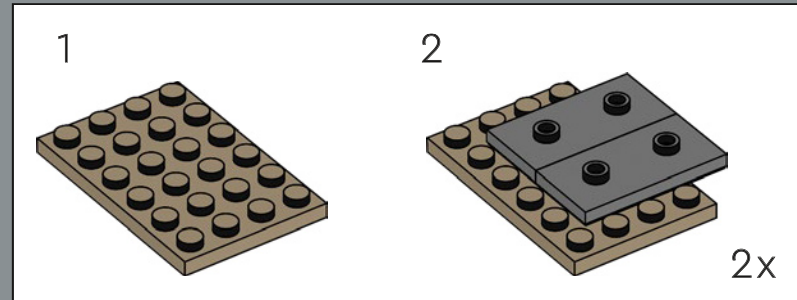

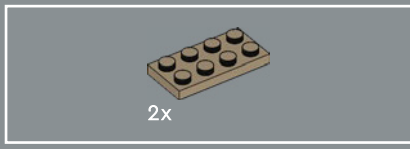

292

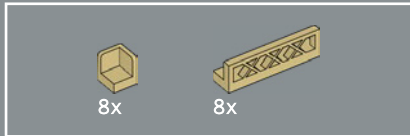
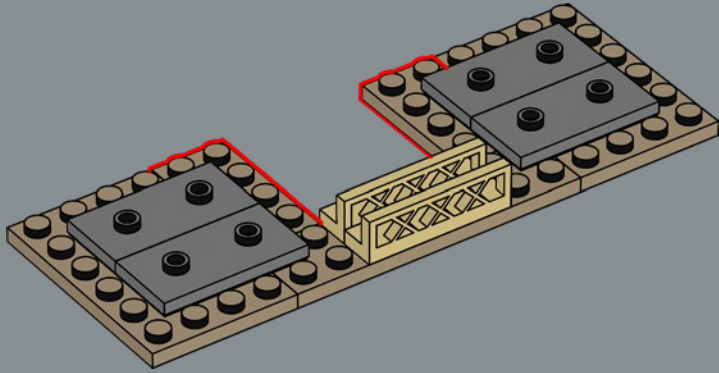

293

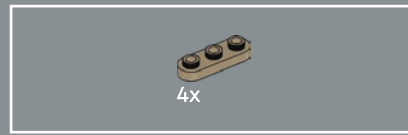
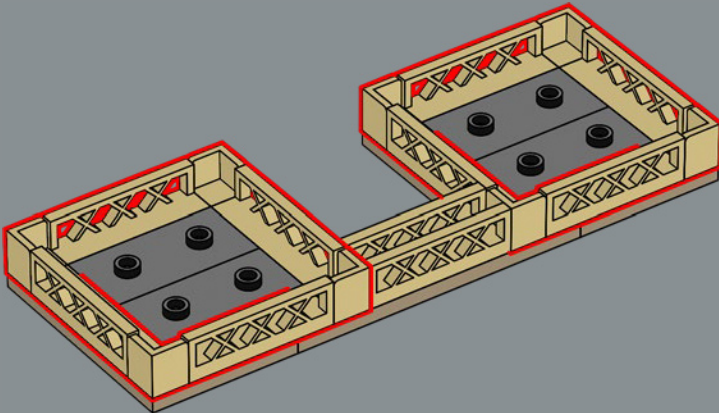

294

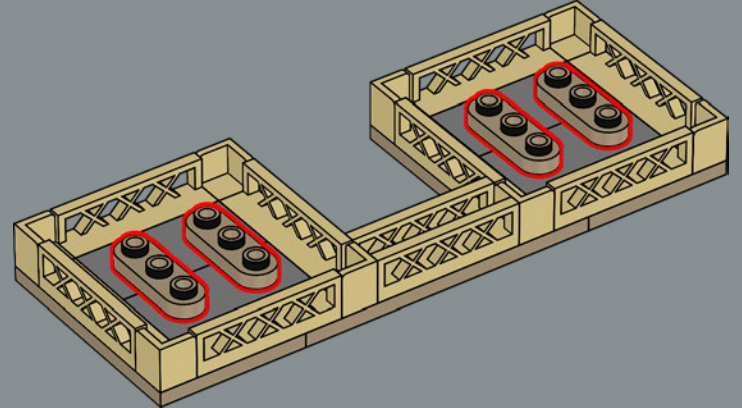

295

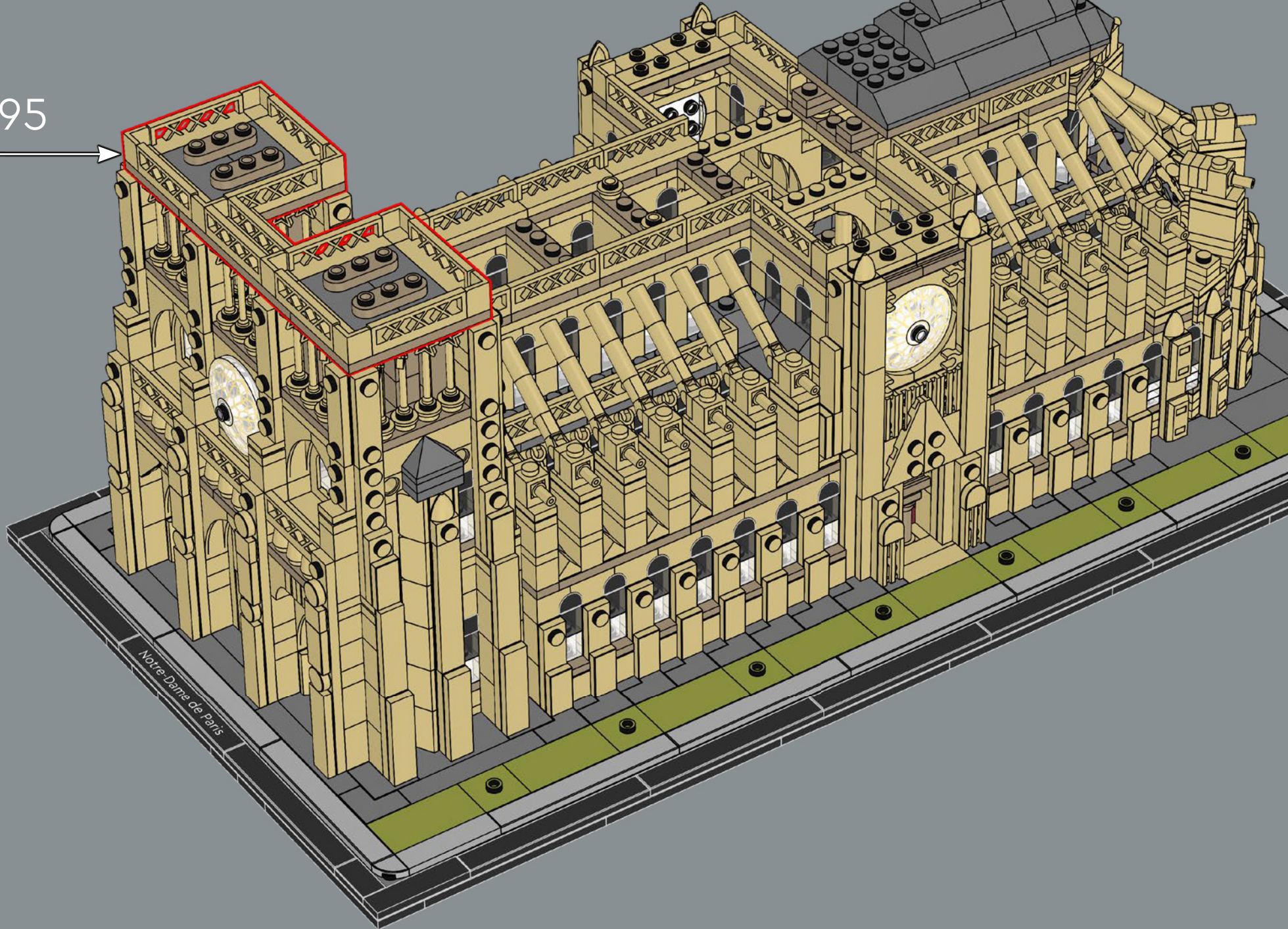

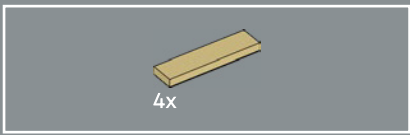

296

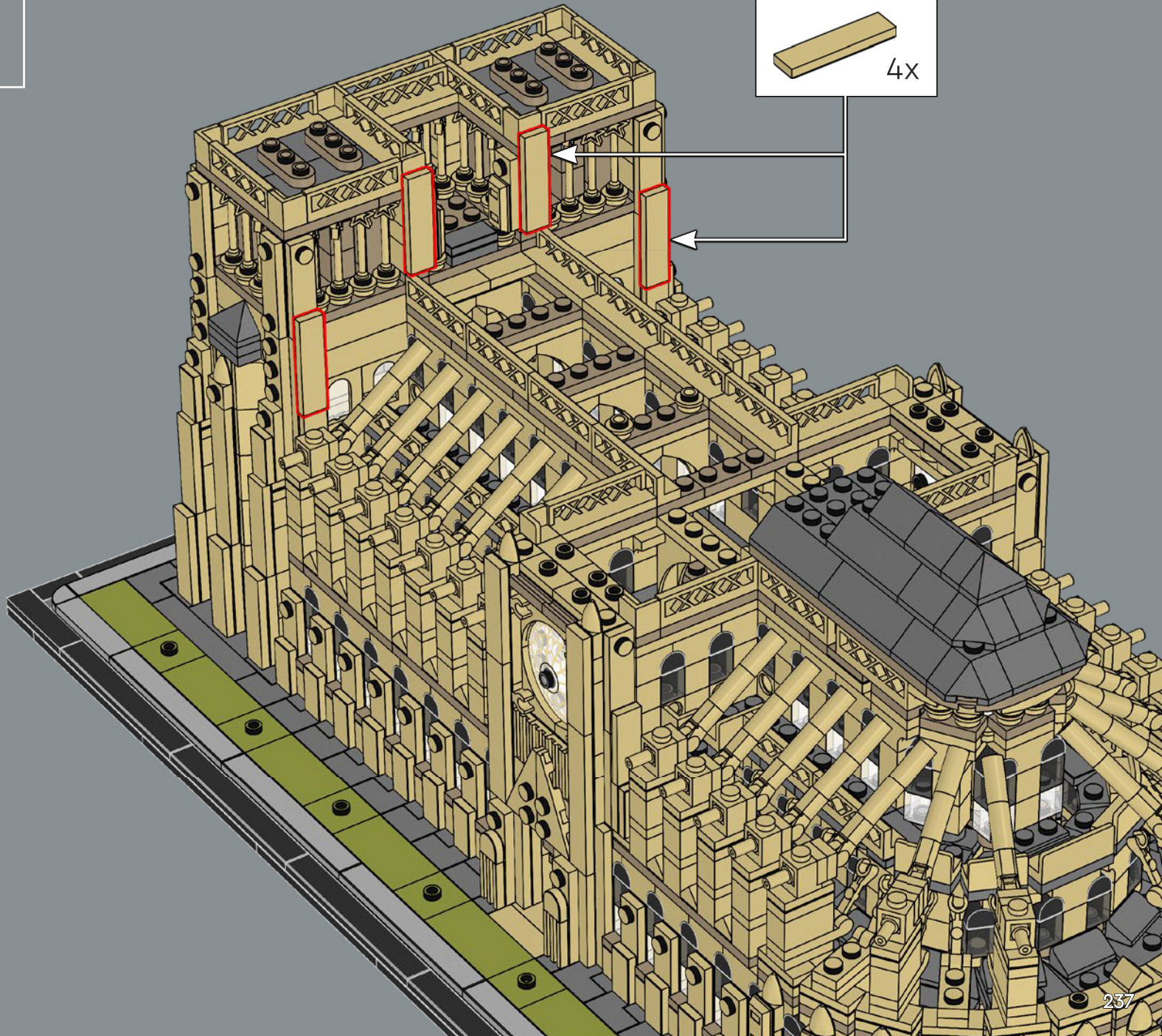
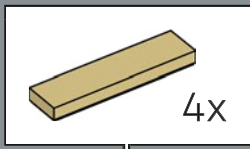



297

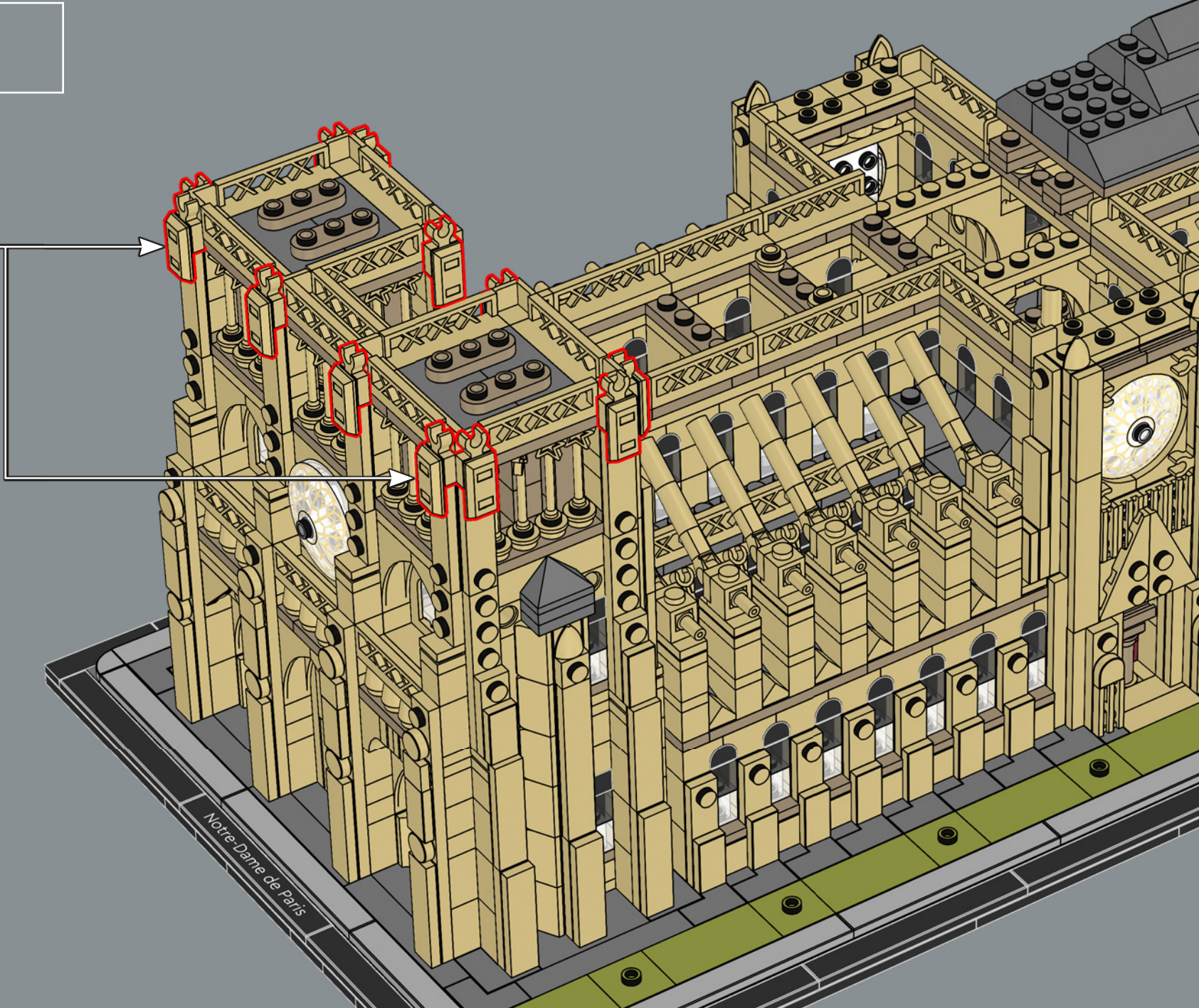
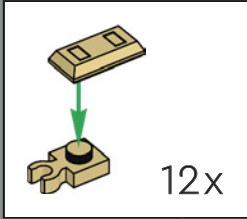

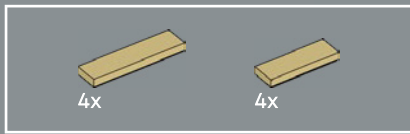

298

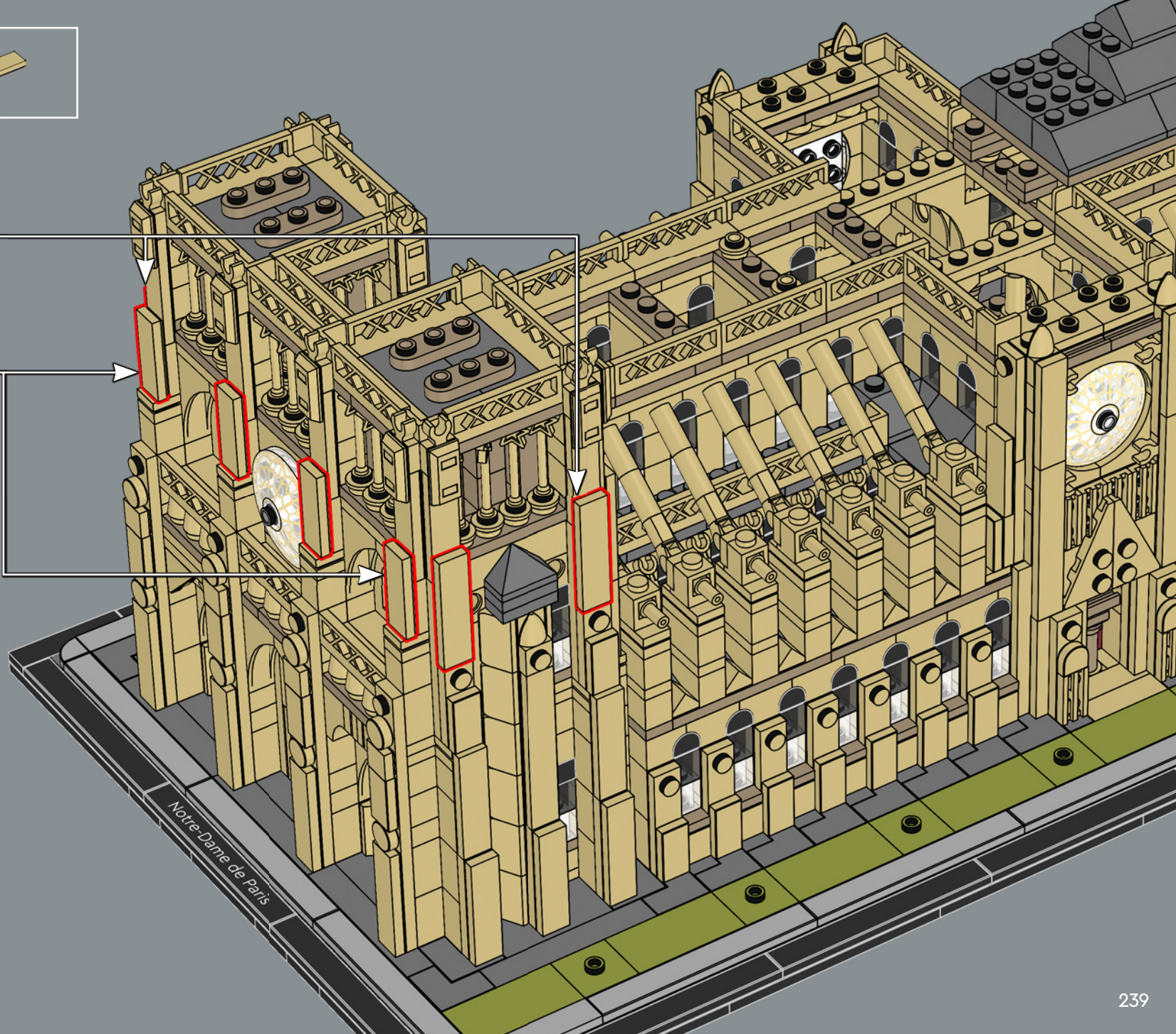
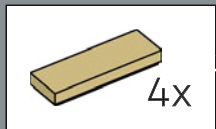
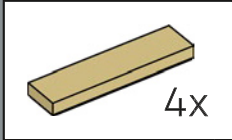



4x

299



4x

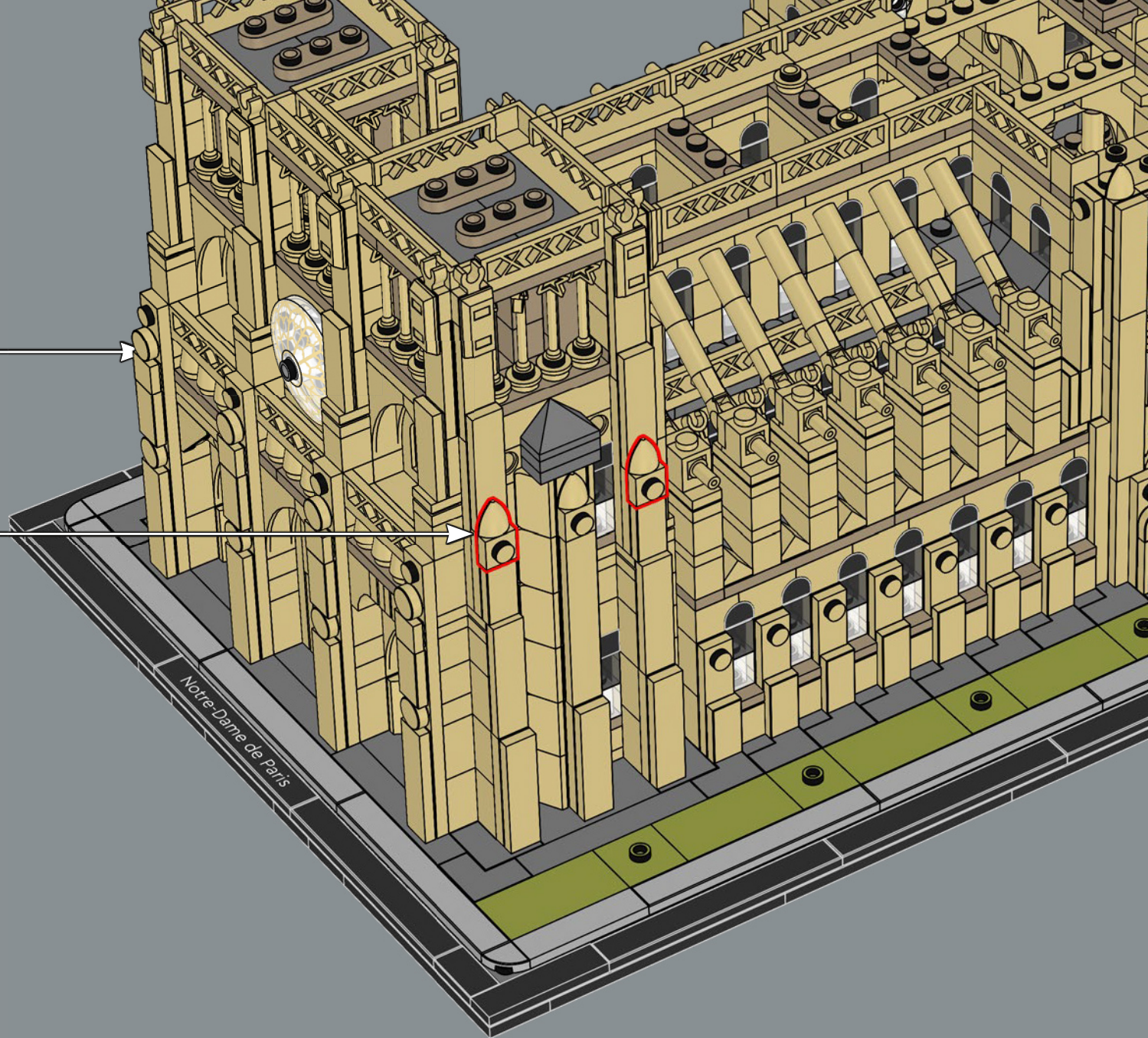

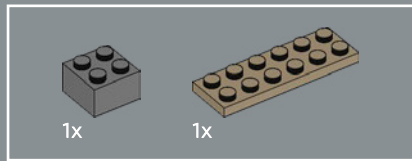
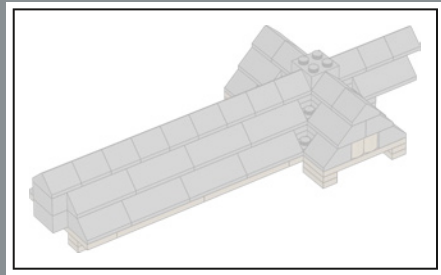

300

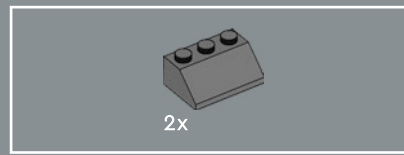
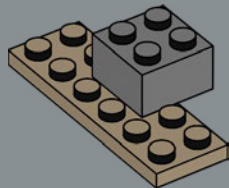

301

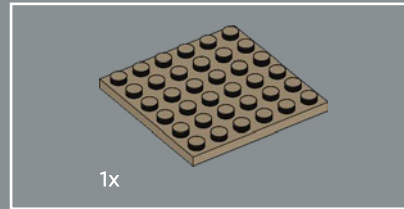
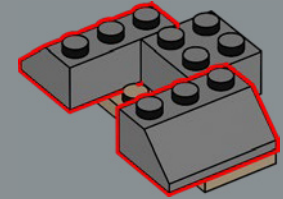

302

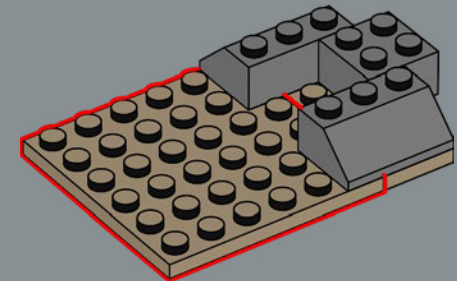

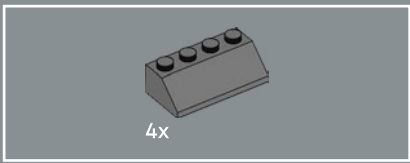

303

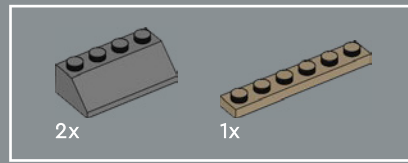
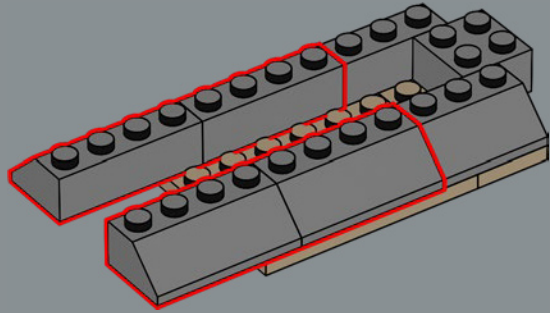

305

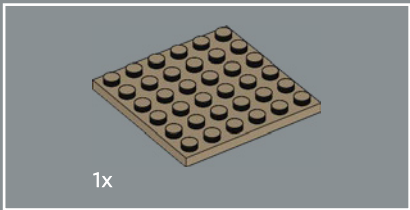
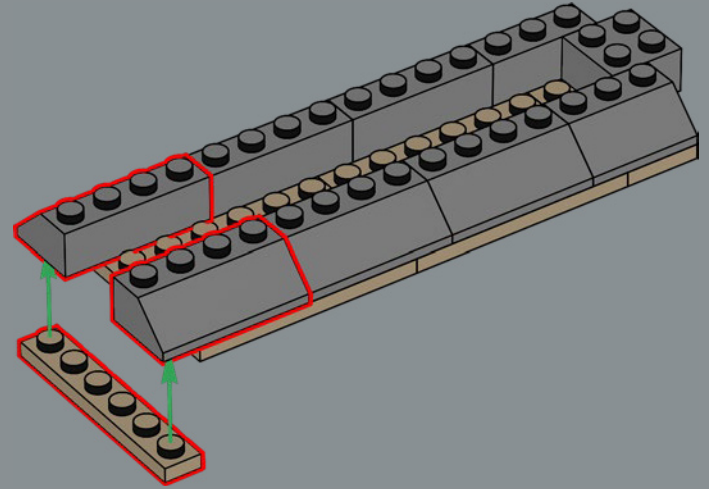

304

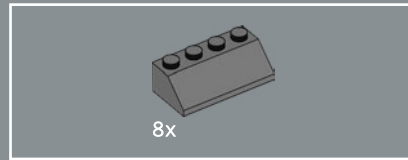
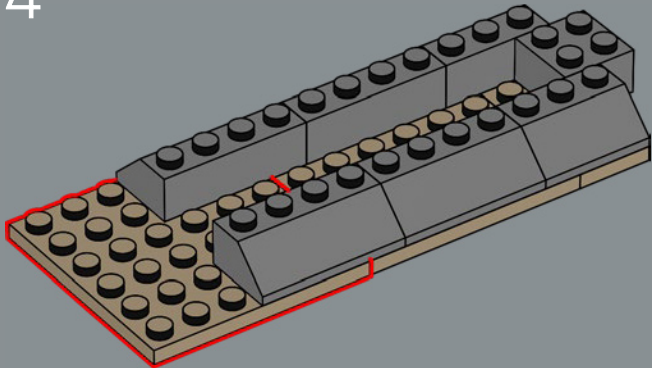

306

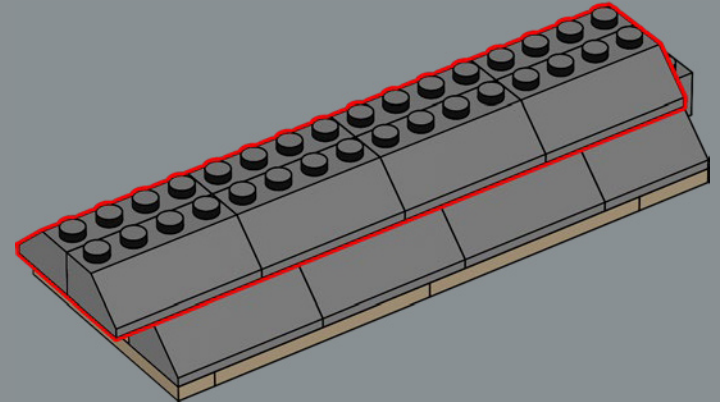

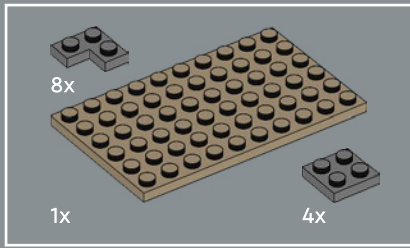

307

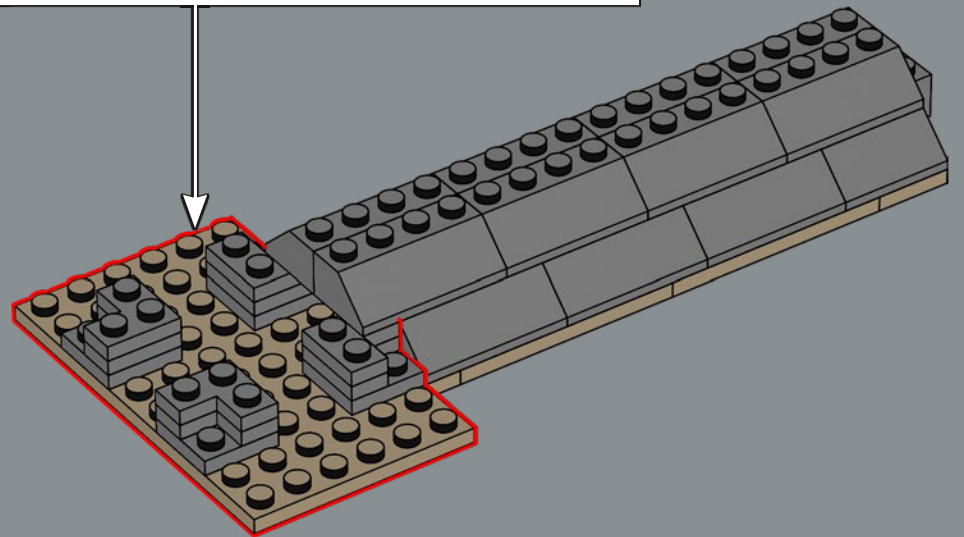
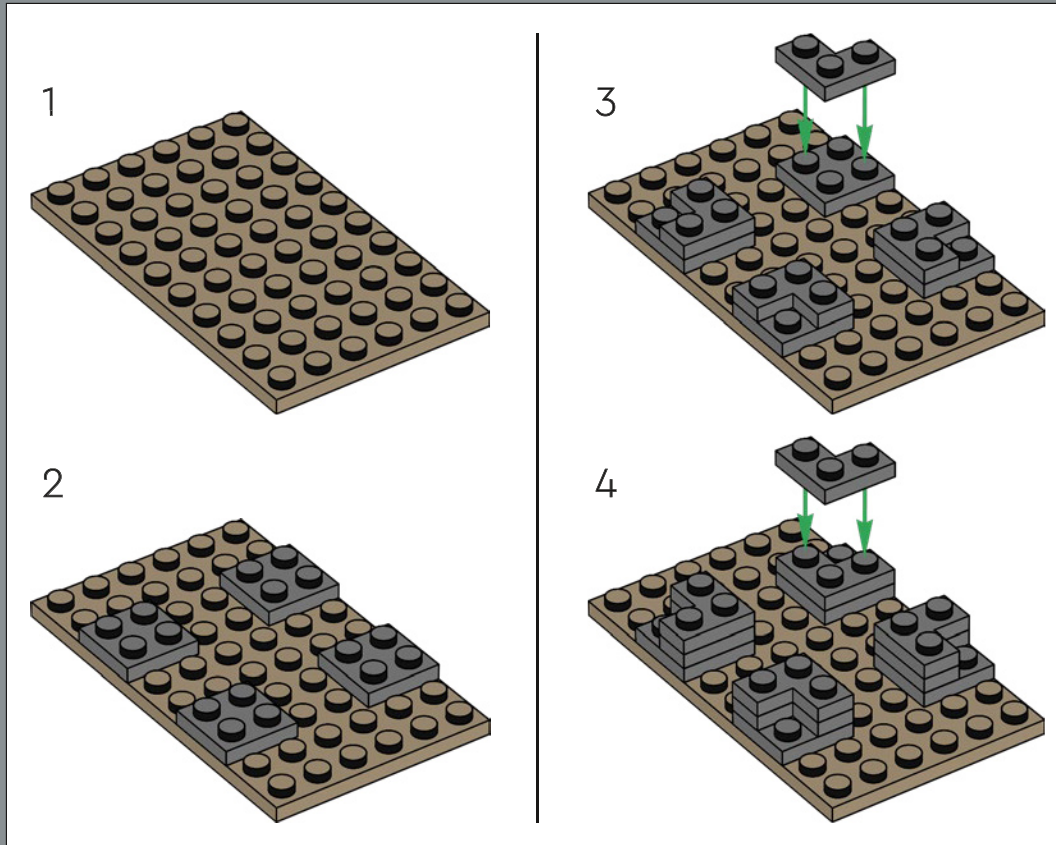

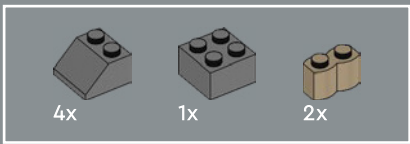

308

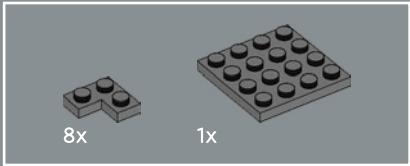
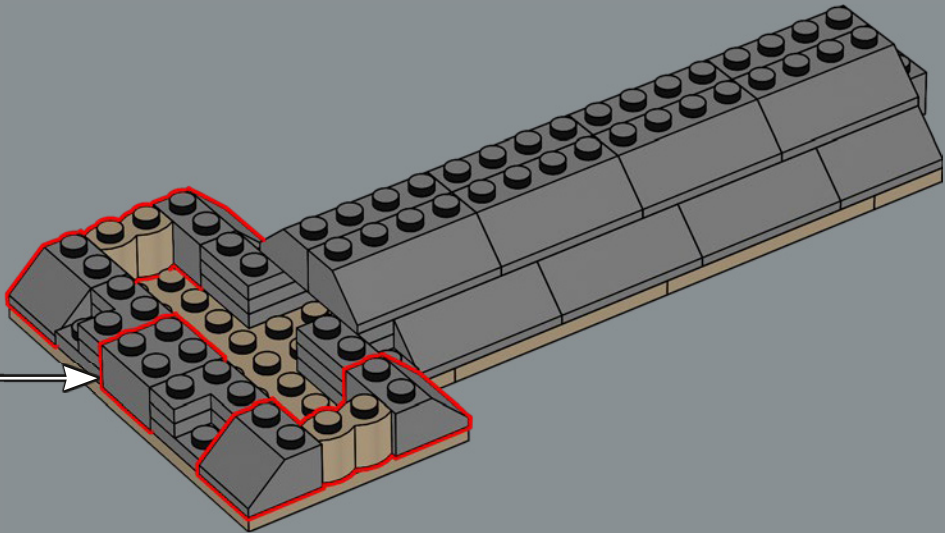
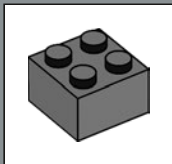

309

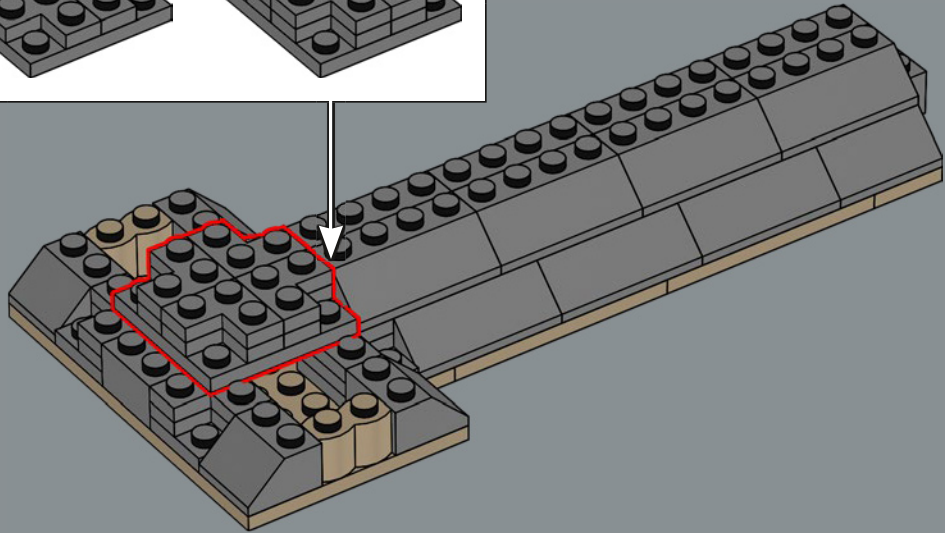
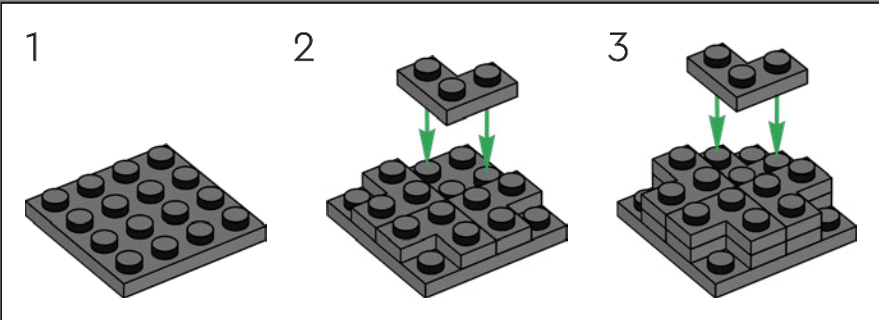

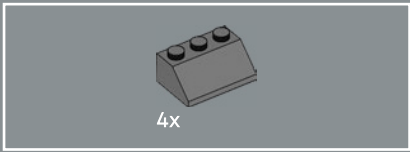

310

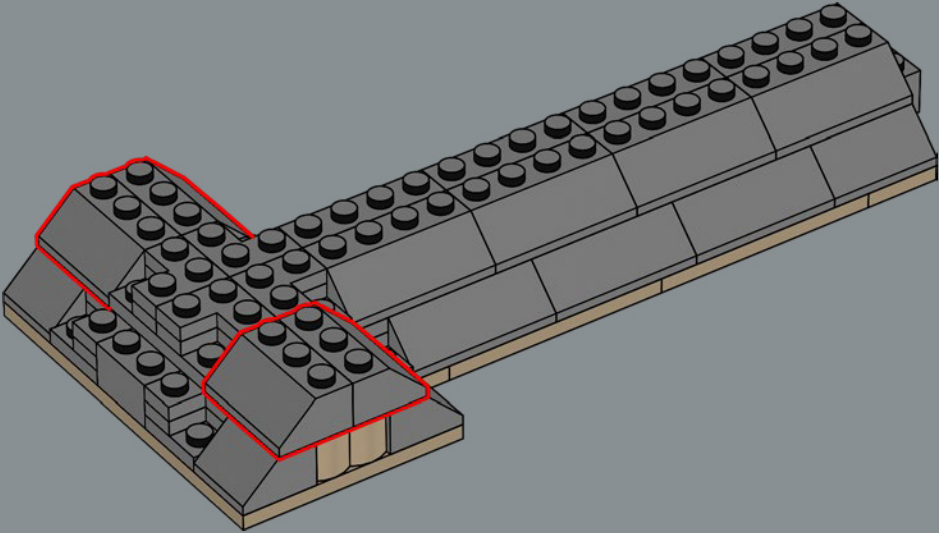

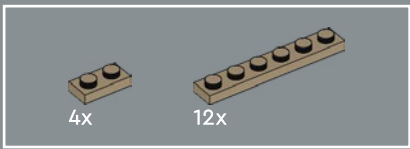

311

1

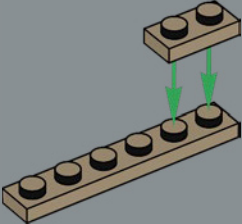

2

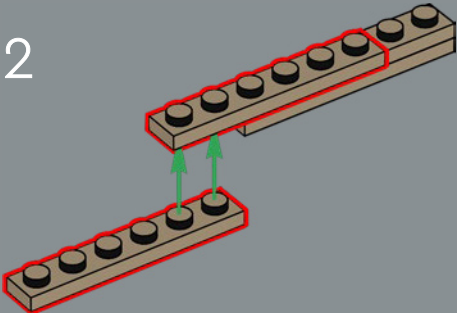

3

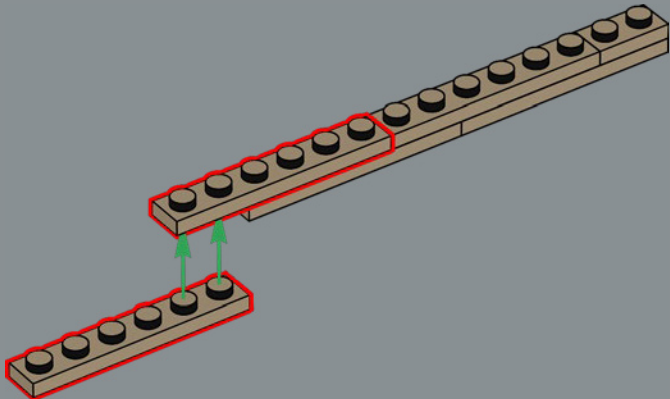

4

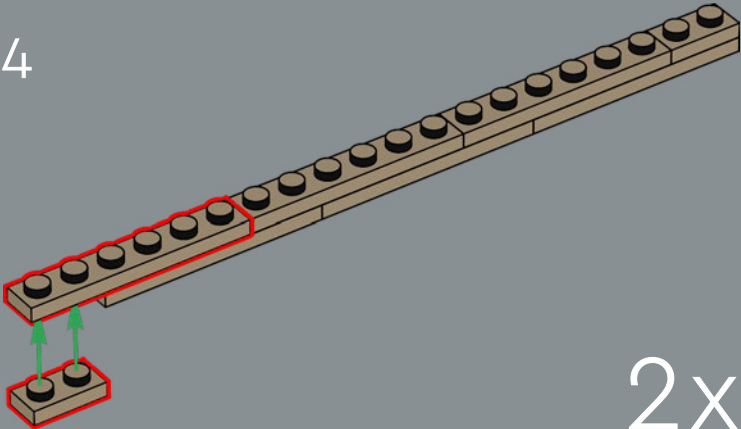

2x

Timber for the wooden structure of the cathedral came from around 1,300 oaks, or the approximate equivalent of 21 hectares (51.8 acres) of forest!

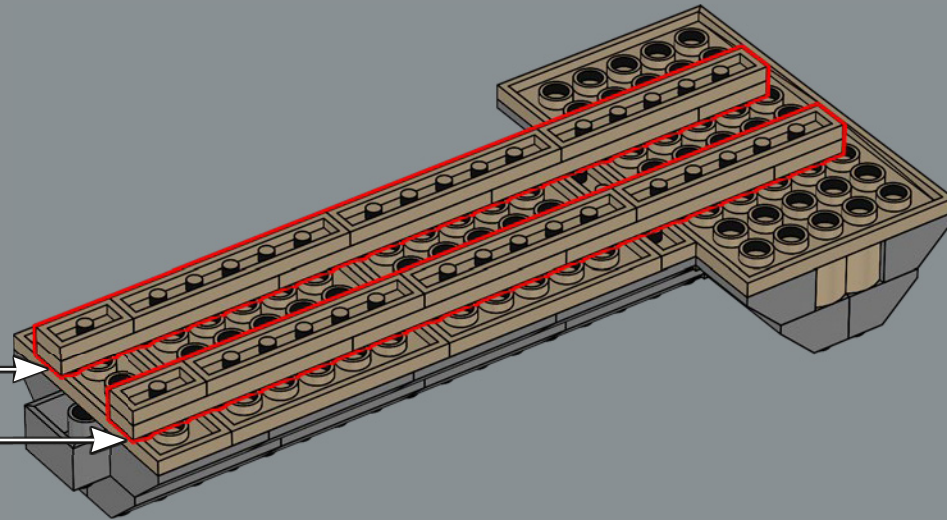



8x

312

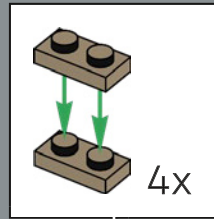

4x

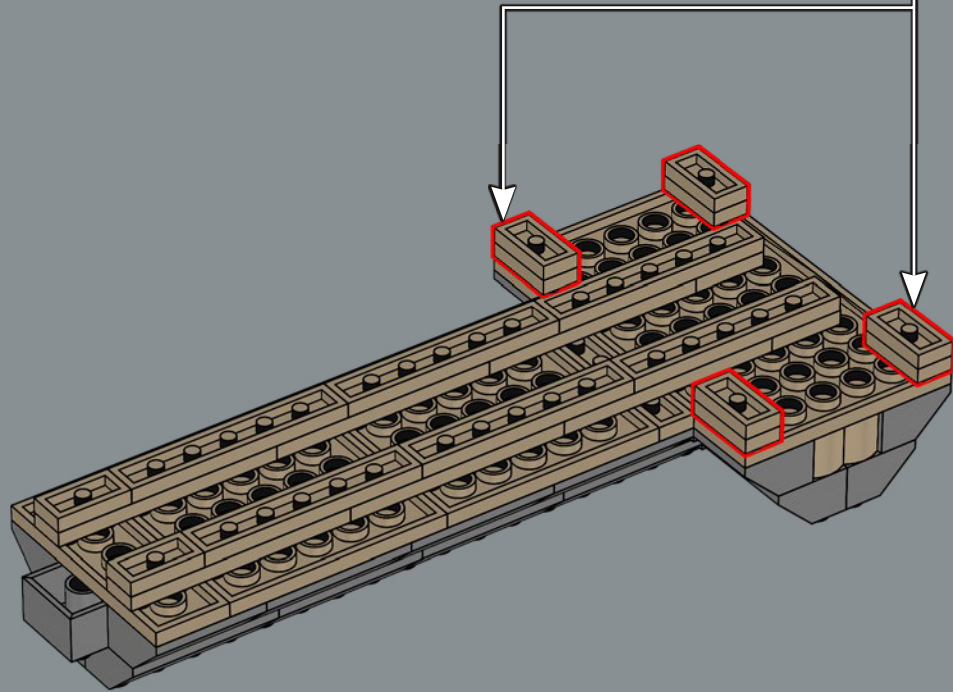

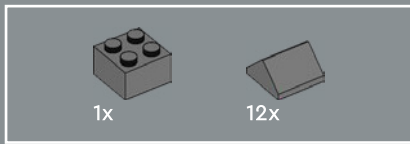

313

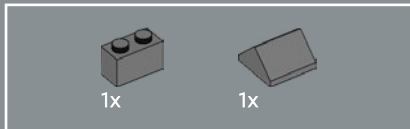
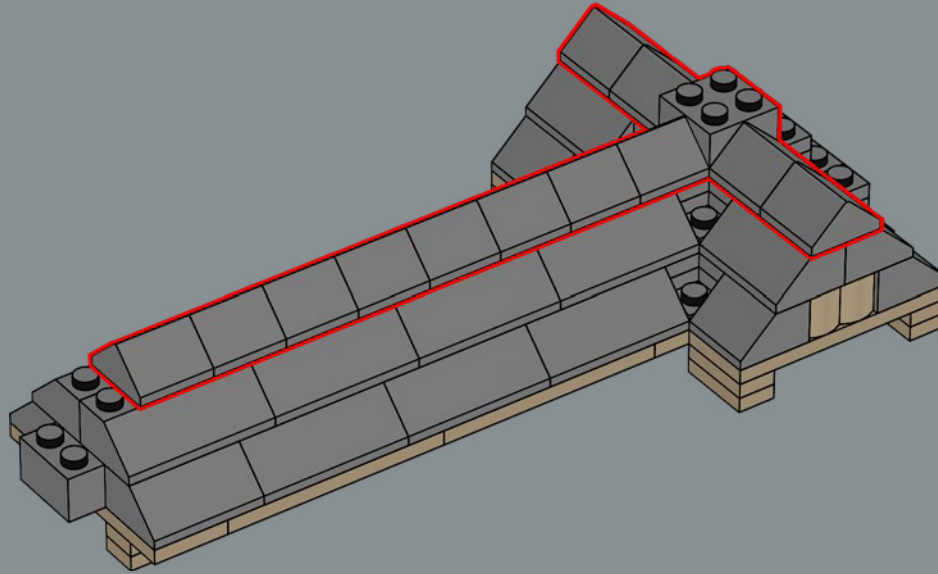

314

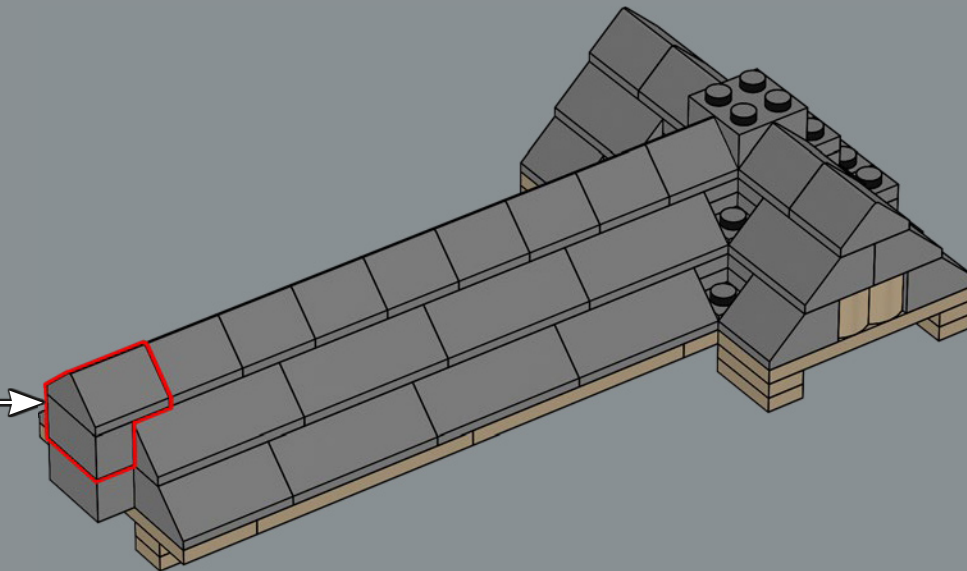
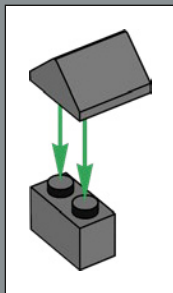

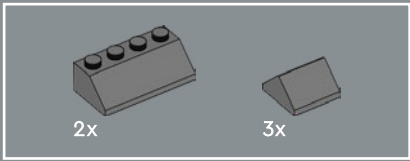

315

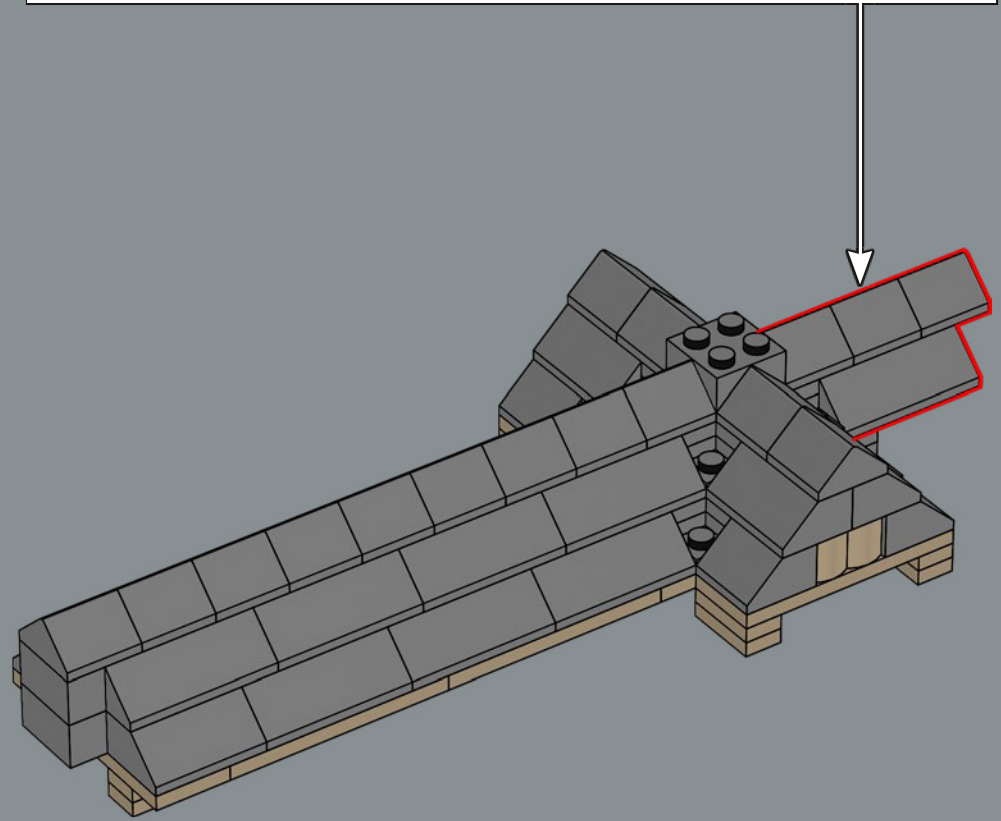
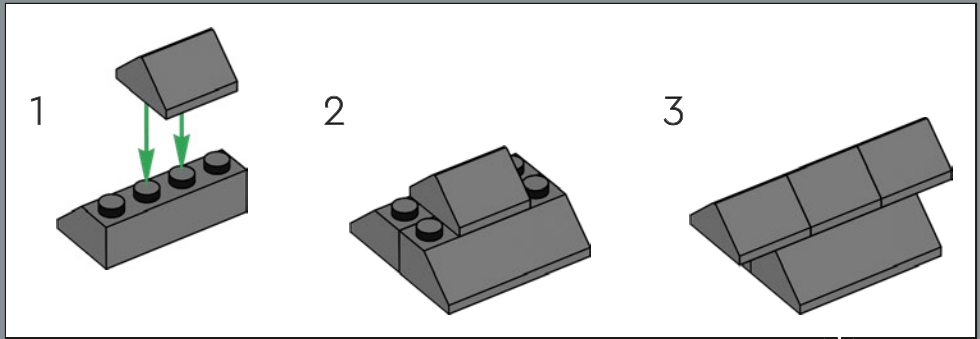

316

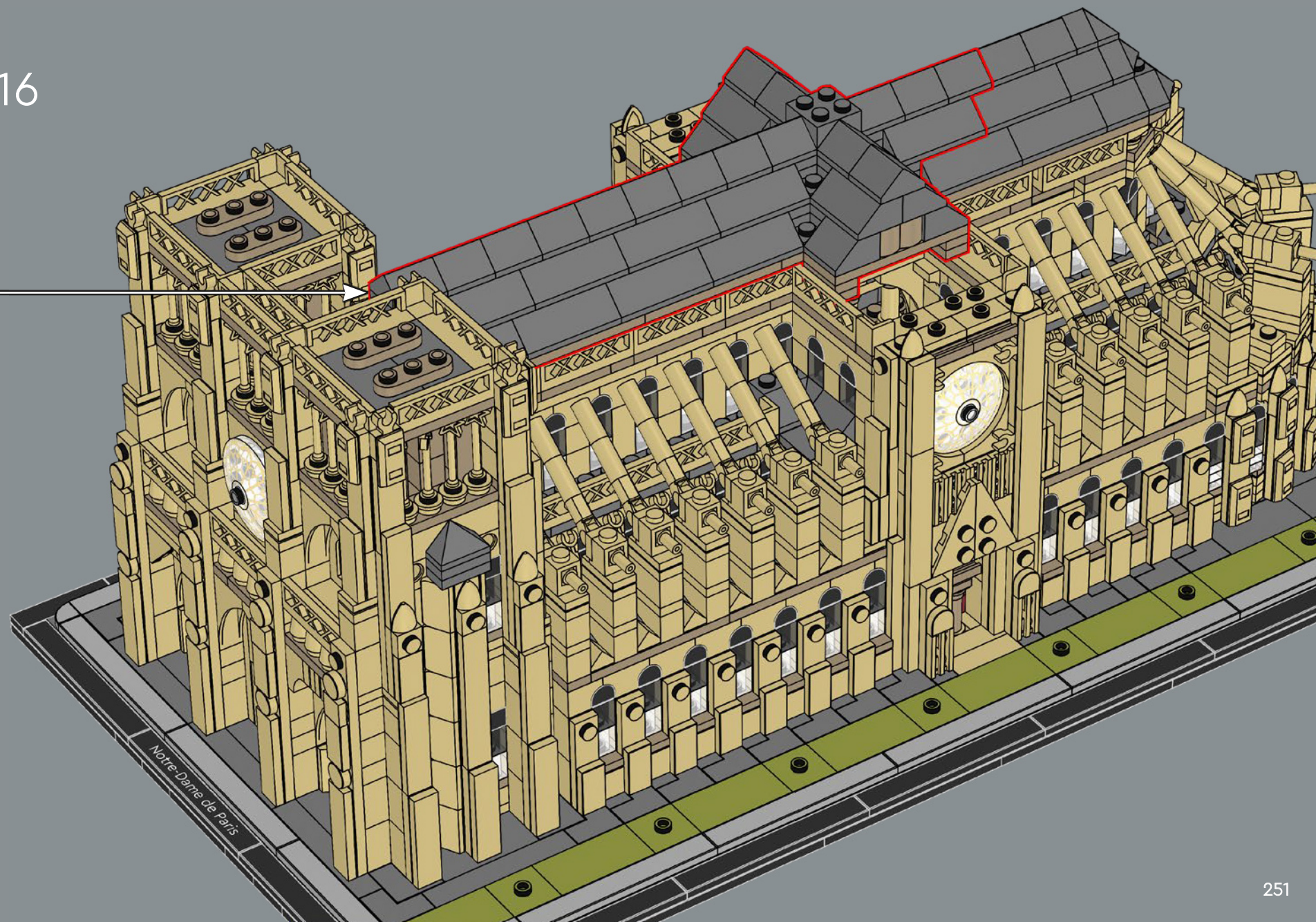

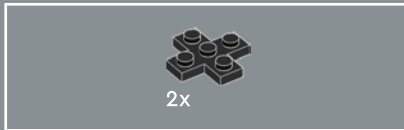
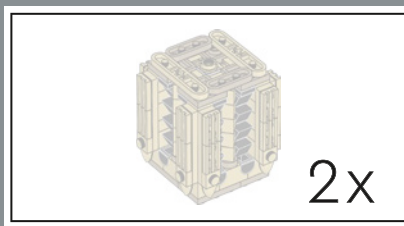

317

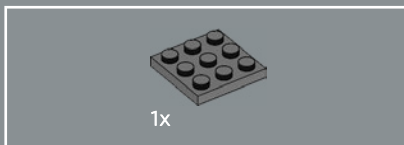
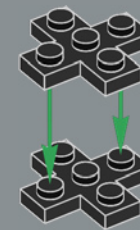

318

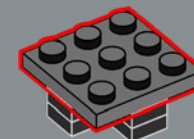

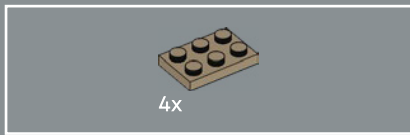

319

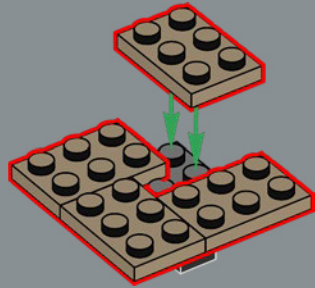

320

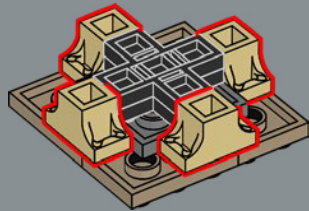

321

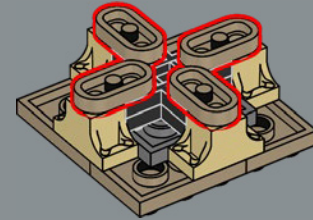

322

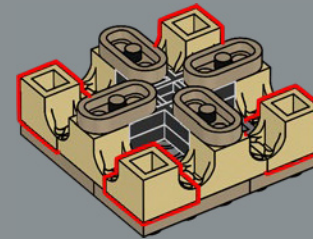



323

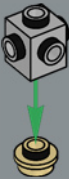

324

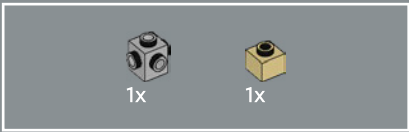

325



326



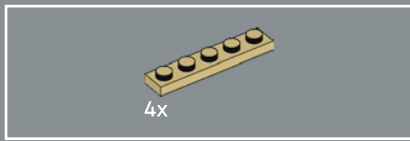

327

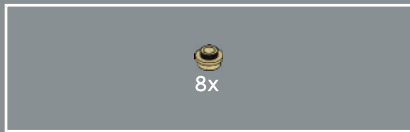

328

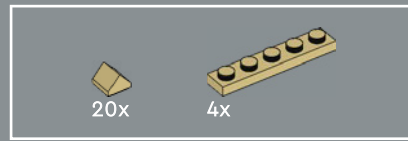
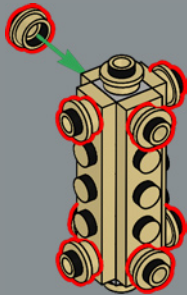

329

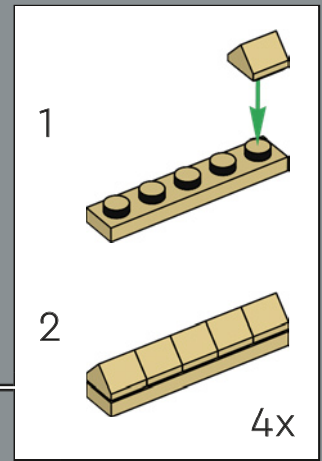
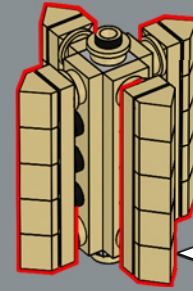

330

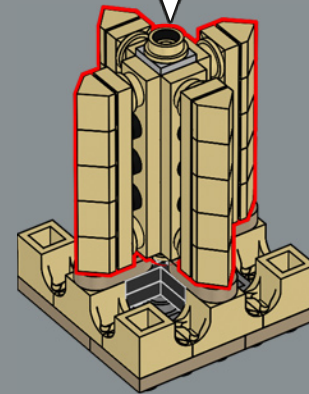

2x



331



332

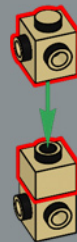

333



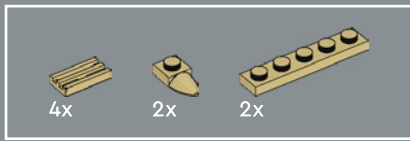

334

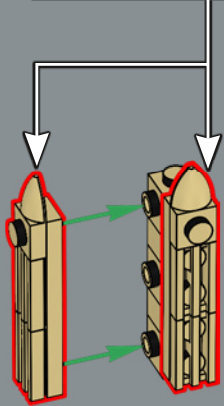
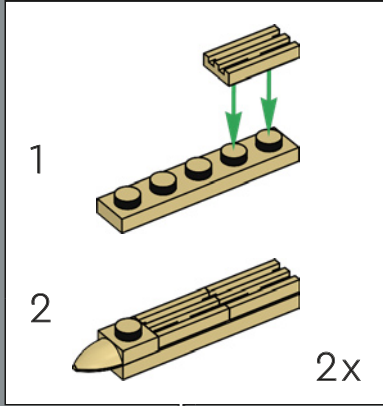

335

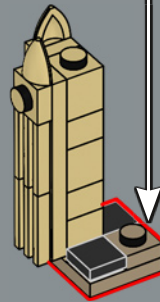
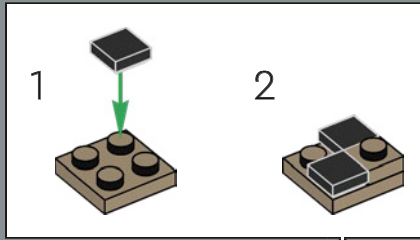

336

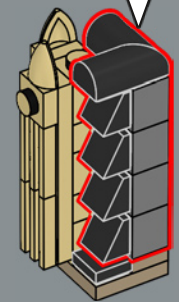
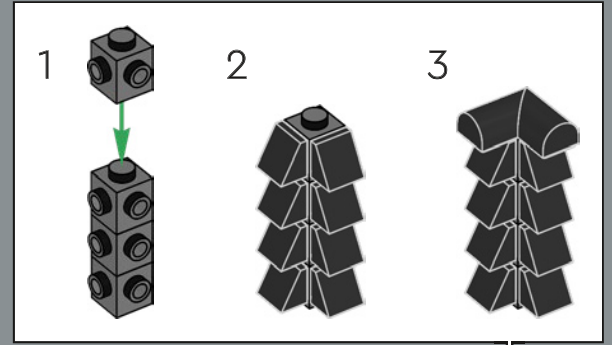

4x

337

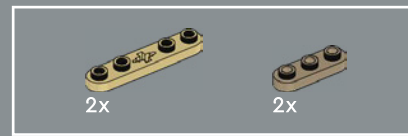
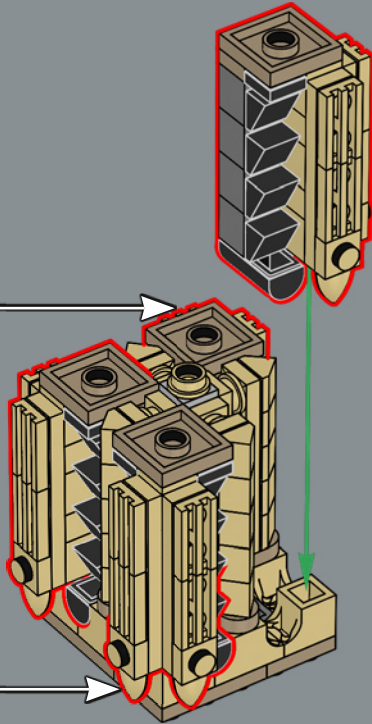

338

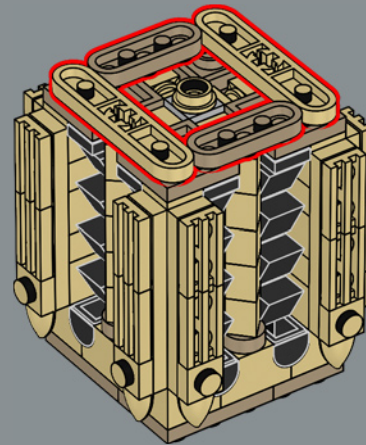

2x

The towers house the cathedral's legendary bells. They were first installed in the north tower, also known as the Grosse Tour or 'Guillaume Tower'.

339

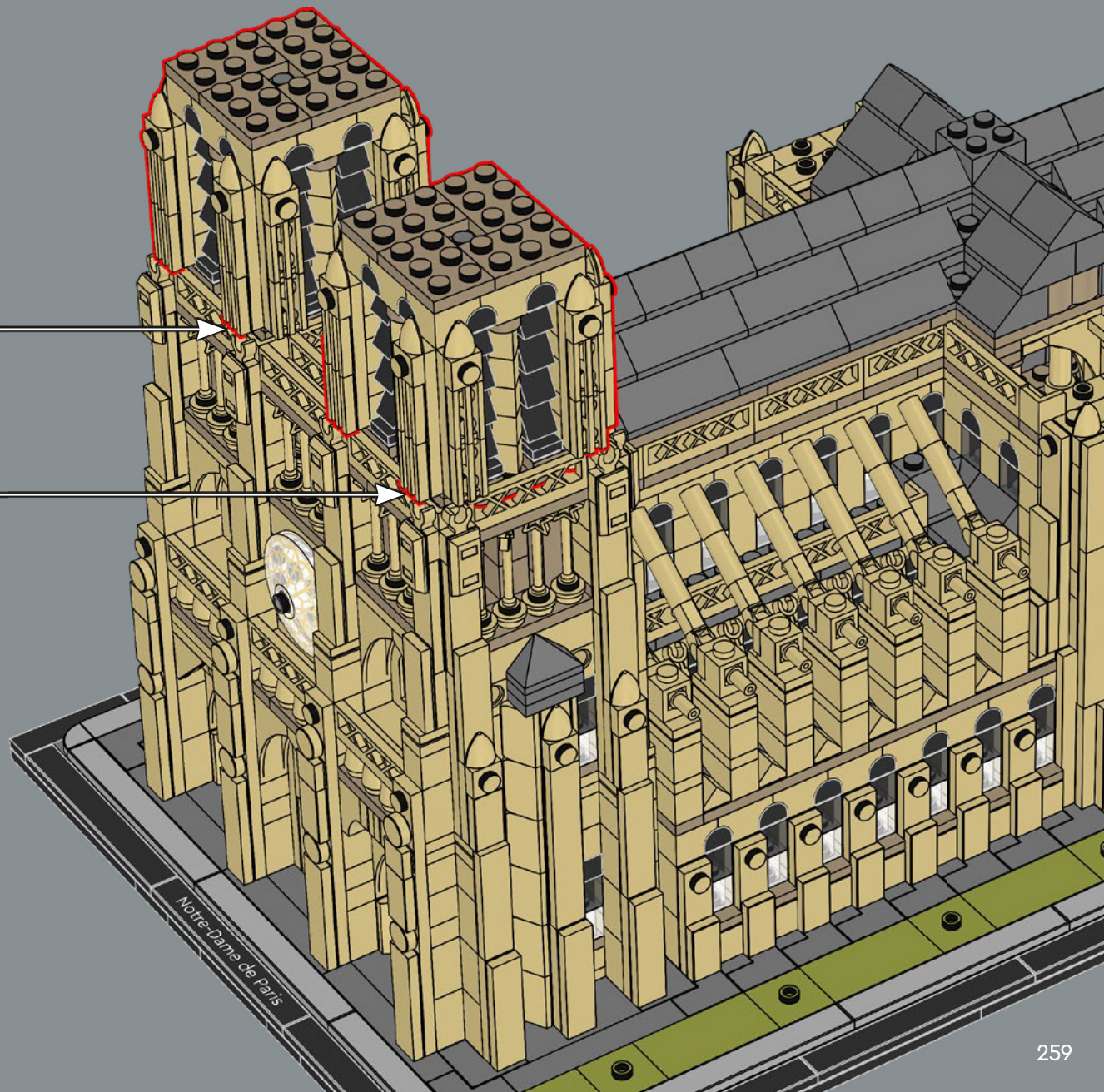



340

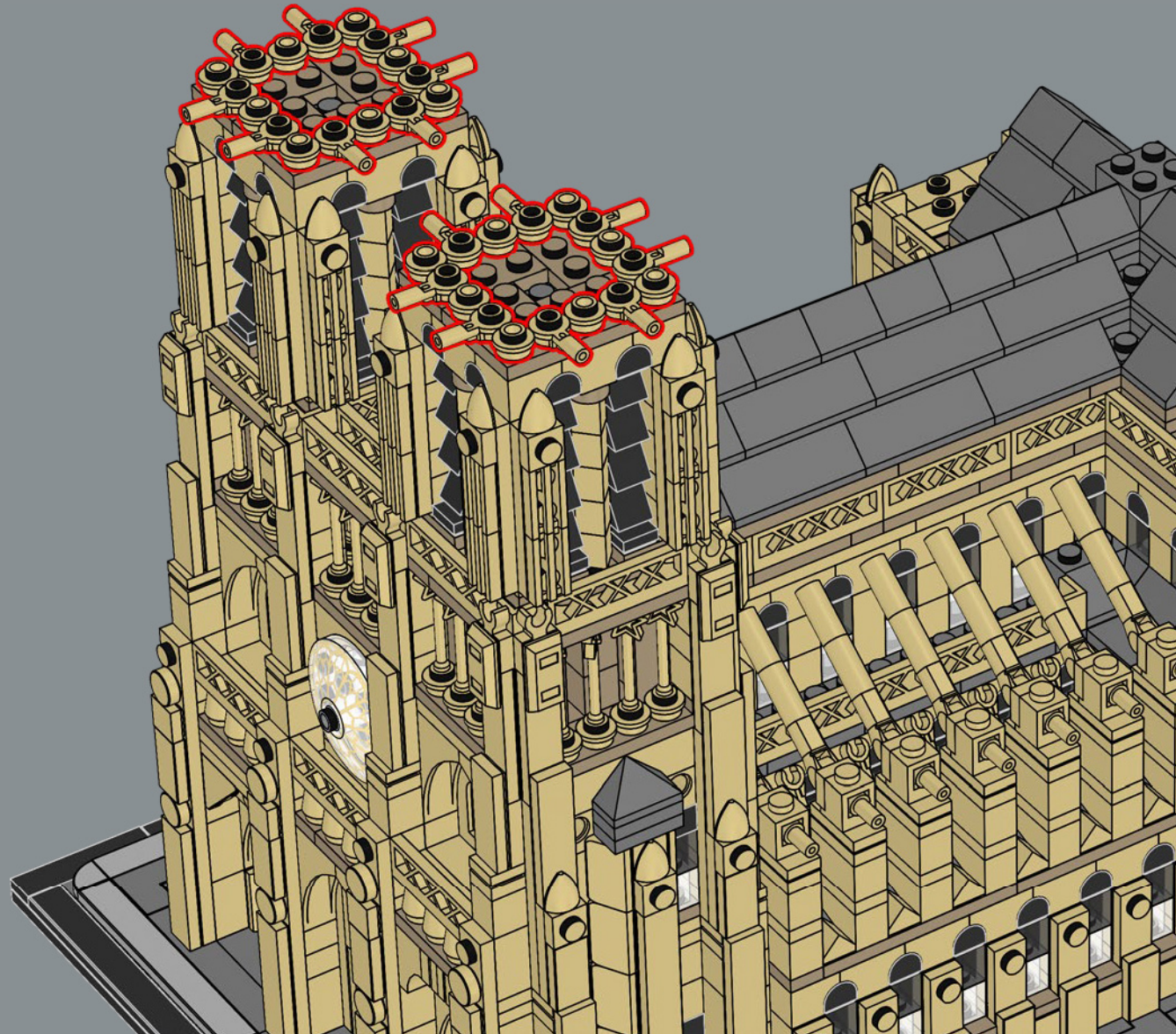

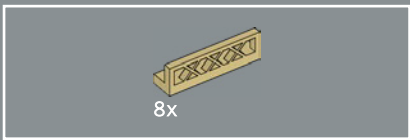

341

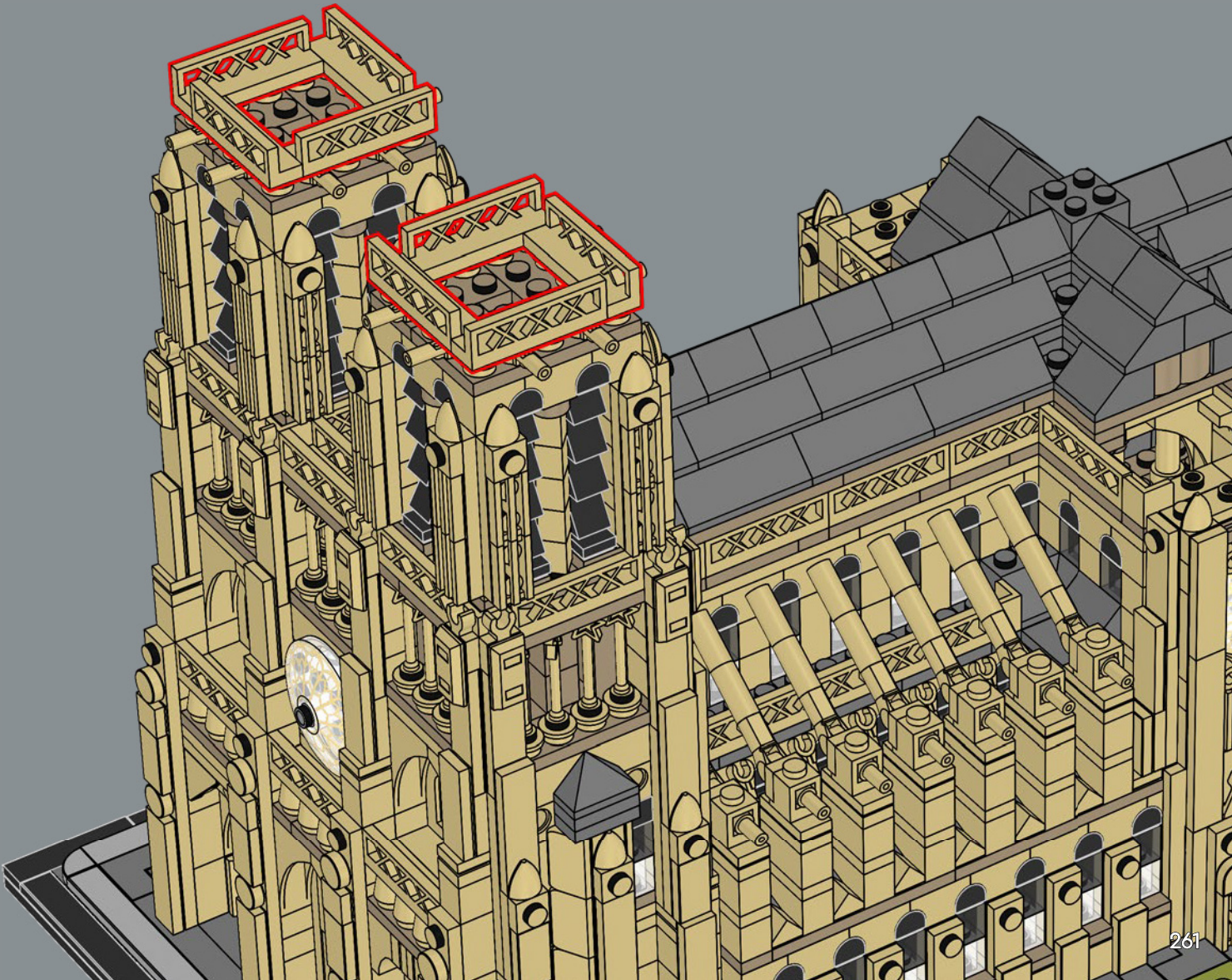

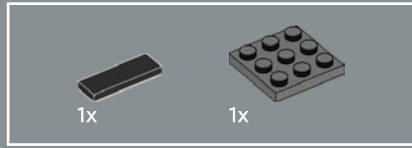

342

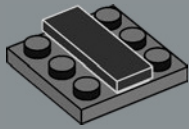

343

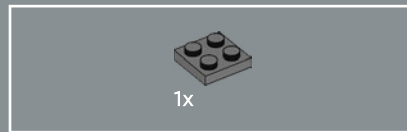
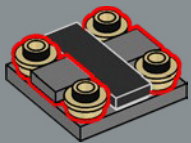

344

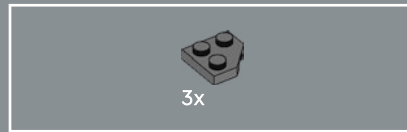
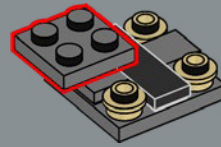

345

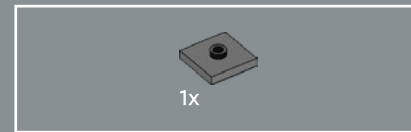
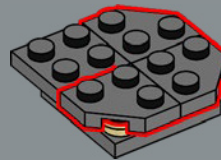

346

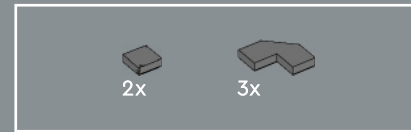
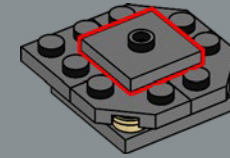

347

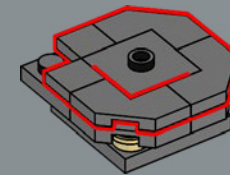



348

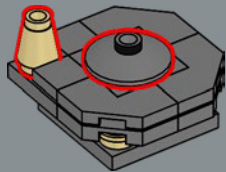

2x

349

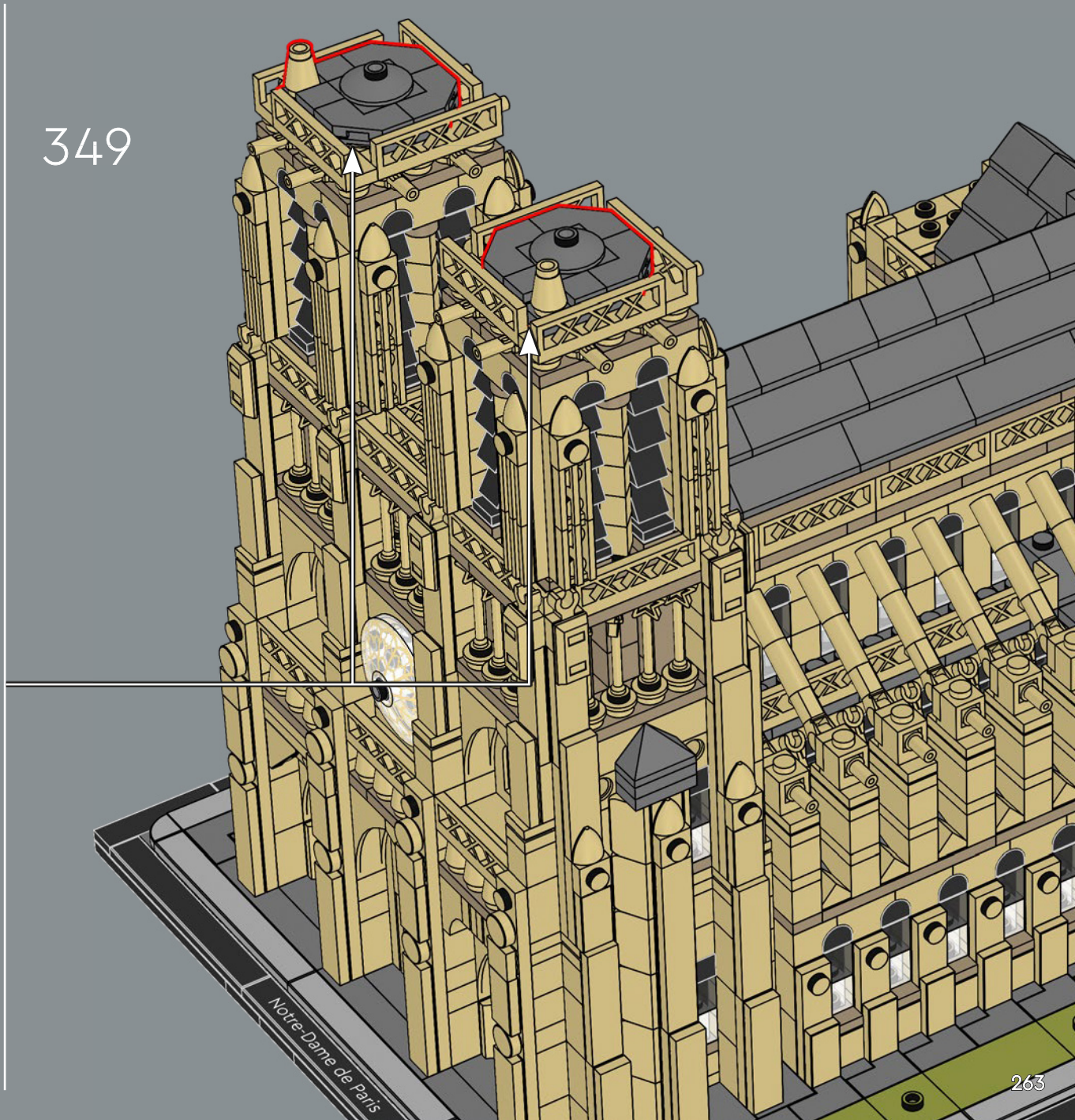

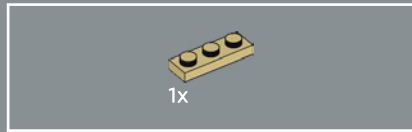
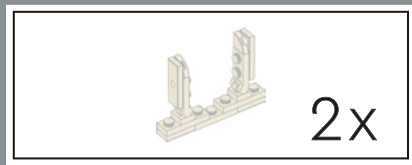

350

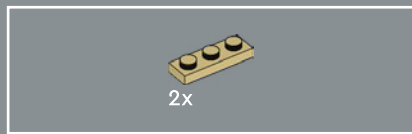
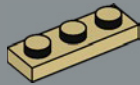

351

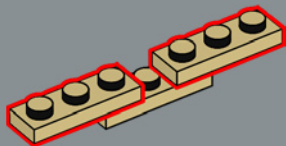

352

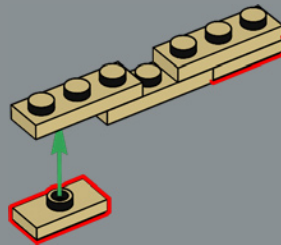

353

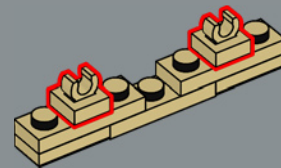

354

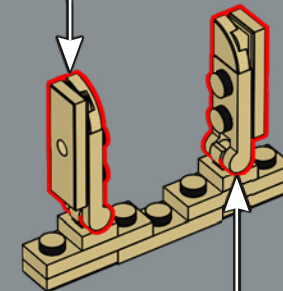
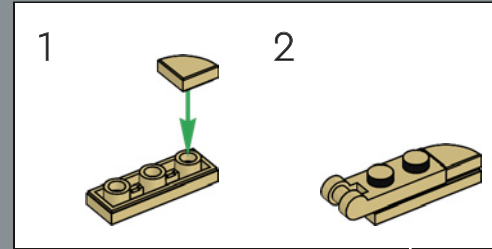

2x

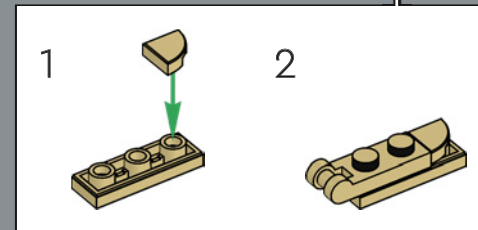

355

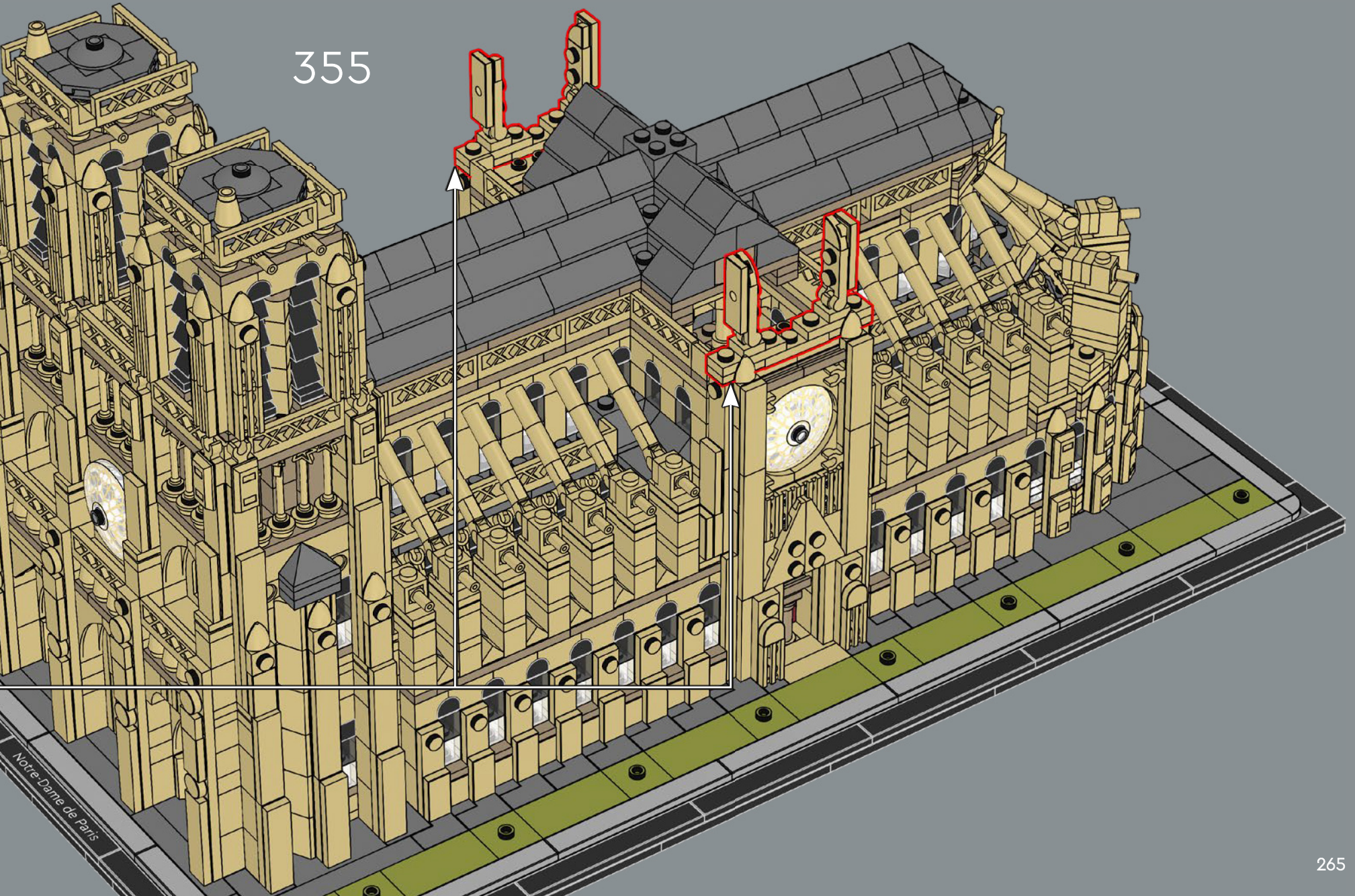

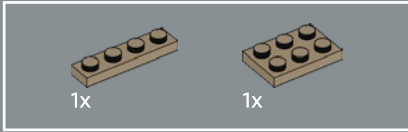
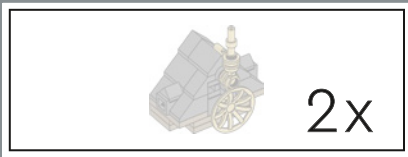

356

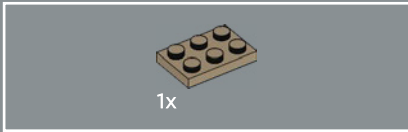
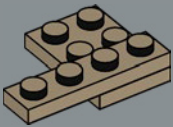

357

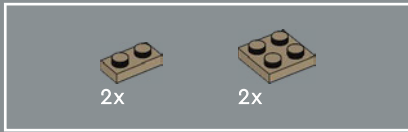
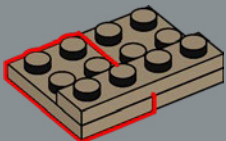

358

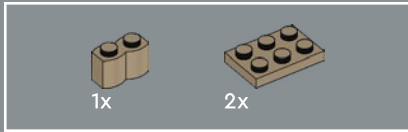
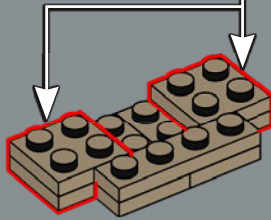
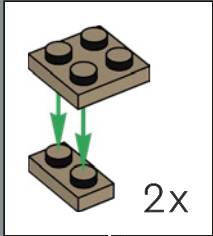

359

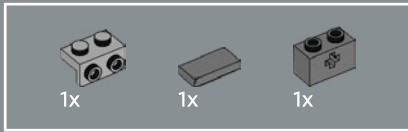
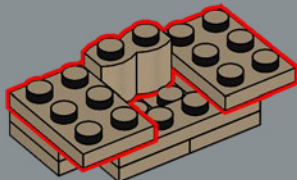

360

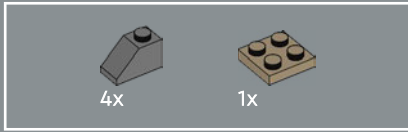
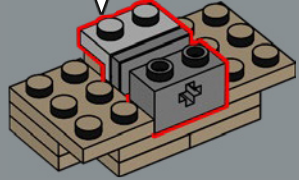
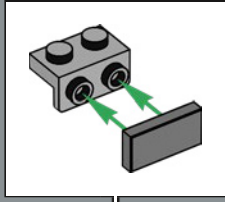

361

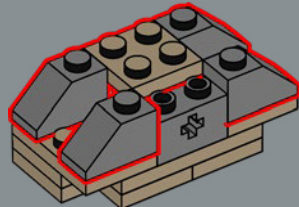

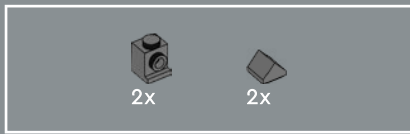

362

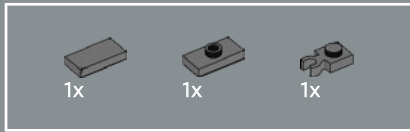
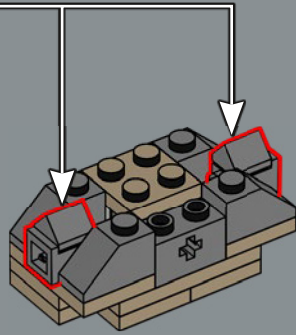
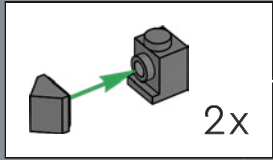

363

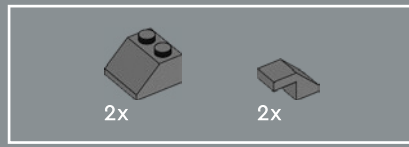
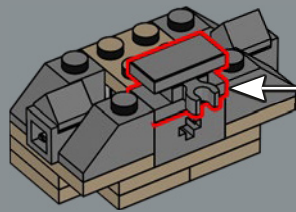
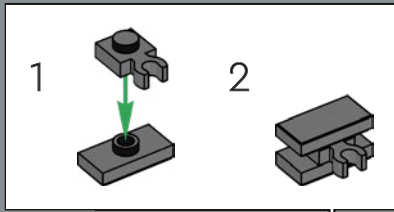

364

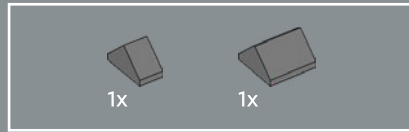
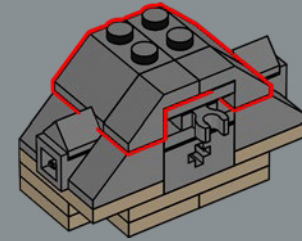

365

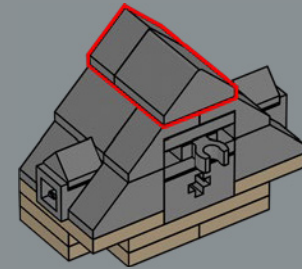



366

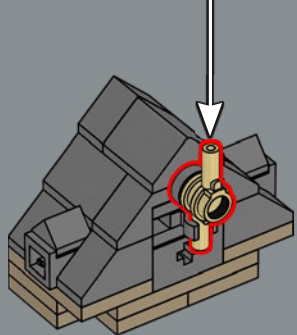
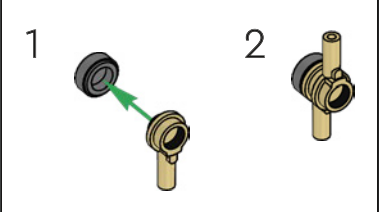

367

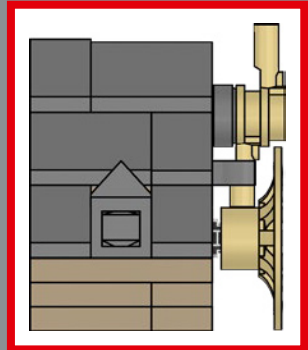
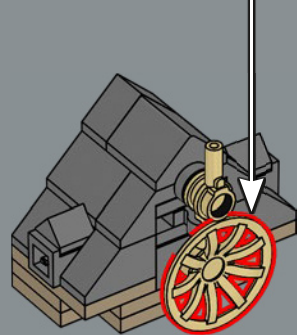
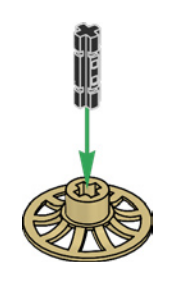

The smaller rose windows are represented with
LEGO® hubcap elements.



368

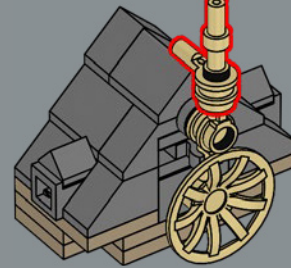
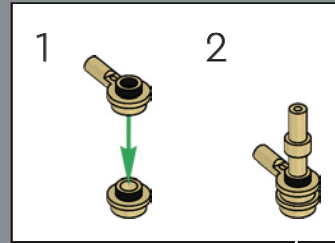



369

270

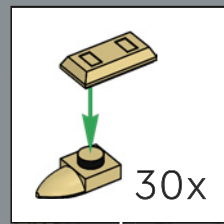
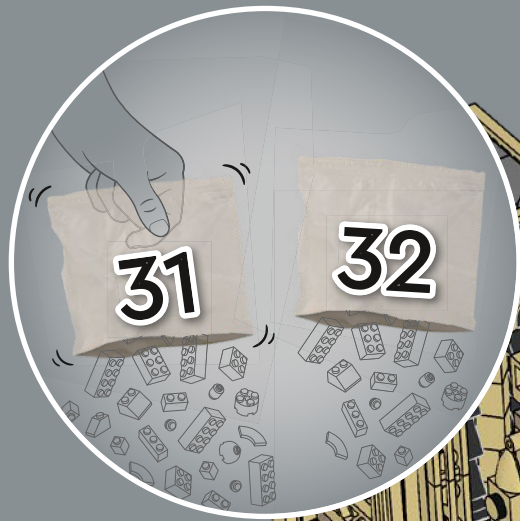



REVOLUTION AND CULTURAL LEGACY

✂ During the turbulent years of the French Revolution (1789-1799), the noble Notre-Dame Cathedral suffered damage and gradual decay. Windows, altars and tombs were destroyed and bells were dismantled to be melted down. In 1792, rioters tore down the statues from the Gallery of Kings and dismantled the spire. For a while, the cathedral was even used to store wine and other goods. But in the wake of the revolution, there followed an emerging awareness and appreciation of French national heritage. The publication and widespread international acclaim of Victor Hugo's *The Hunchback of Notre-Dame* (1831) cemented the cathedral's status as a cultural gem in world history. From 1843 to 1860, architects Jean-Baptiste Lassus and Eugene-Emmanuel Viollet-le-Duc led the cathedral through an extensive restoration campaign to the version of the historic landmark we know today.



1789-1860

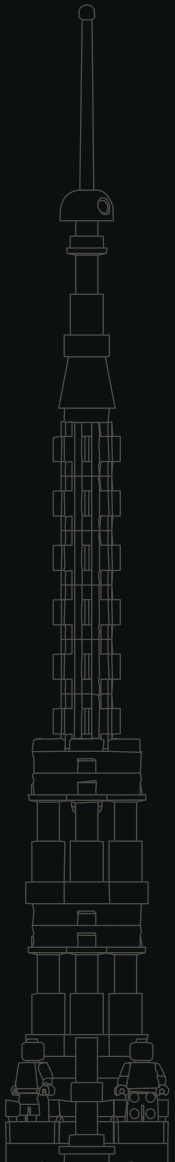



371

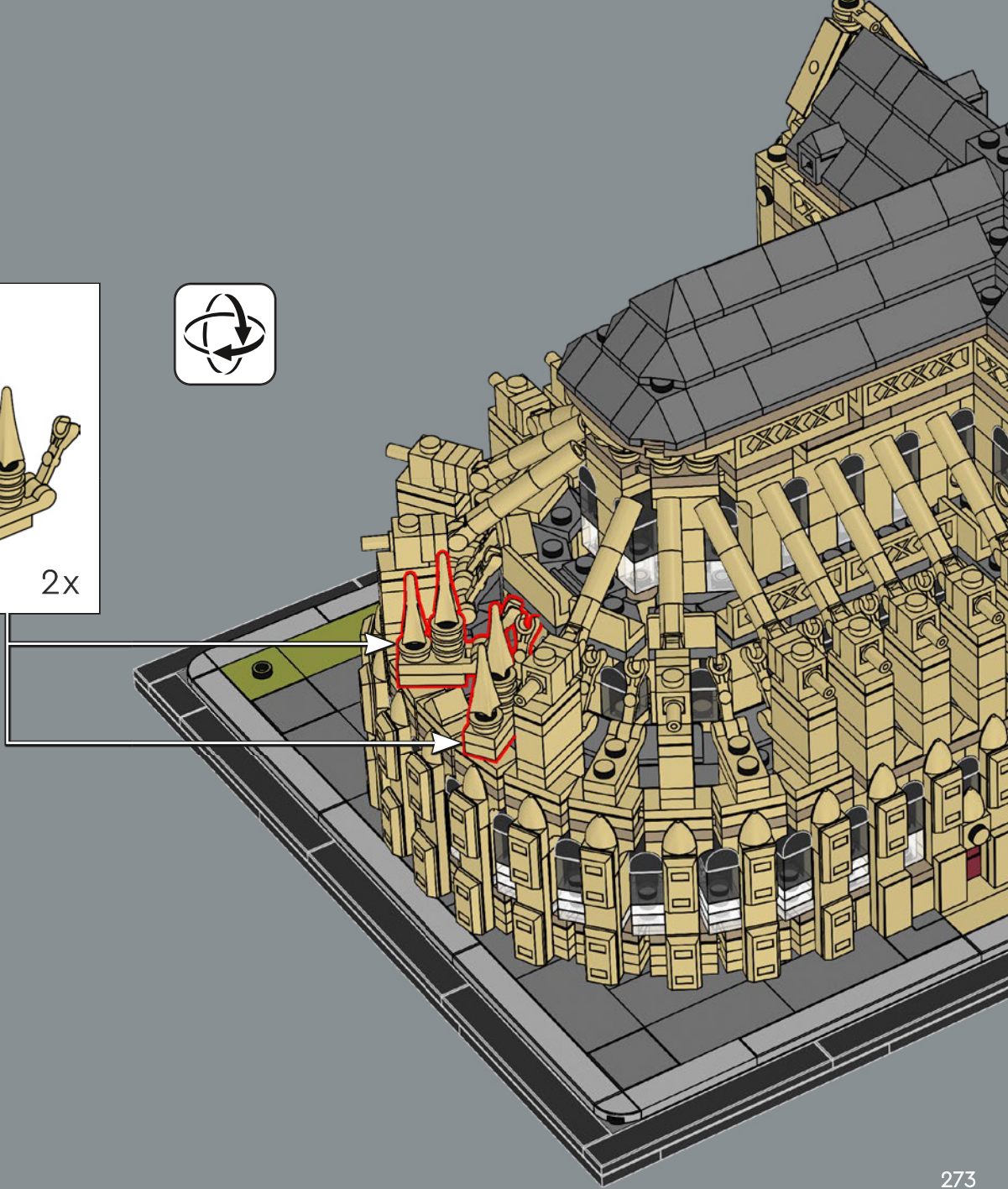
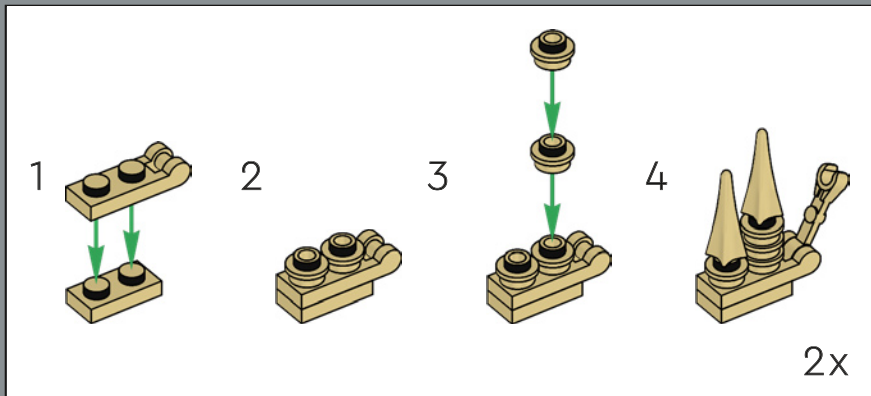



372

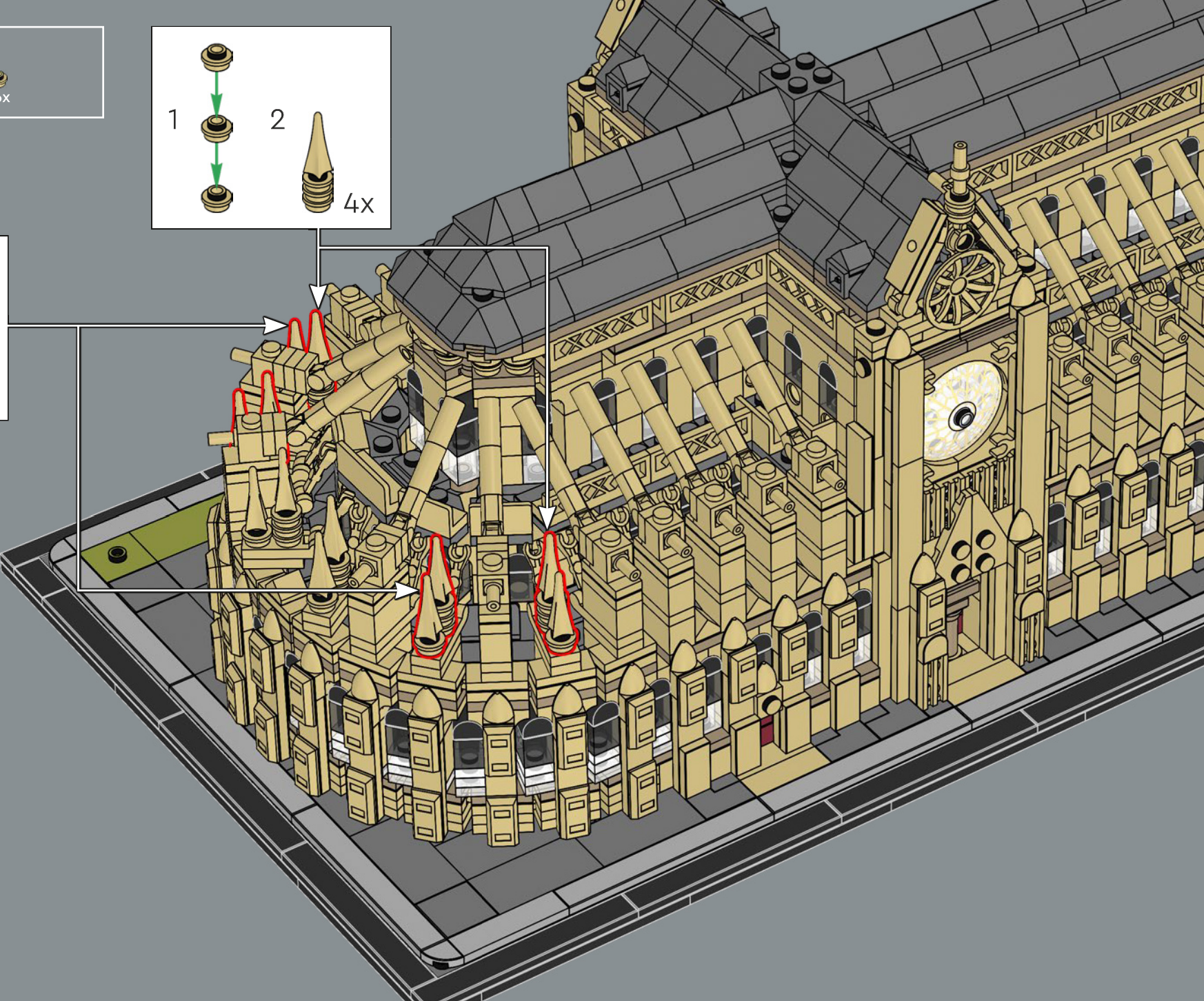
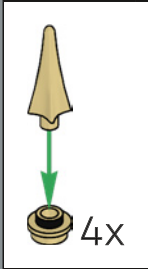
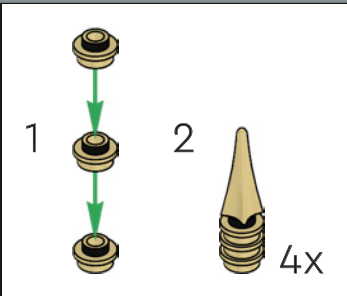



14x



28x

1350 - Finishing touches to Notre-Dame are complete; pinnacles on the uprights of the flying buttresses were redone before they were replaced yet again in the nineteenth century.

373

1



2



14x

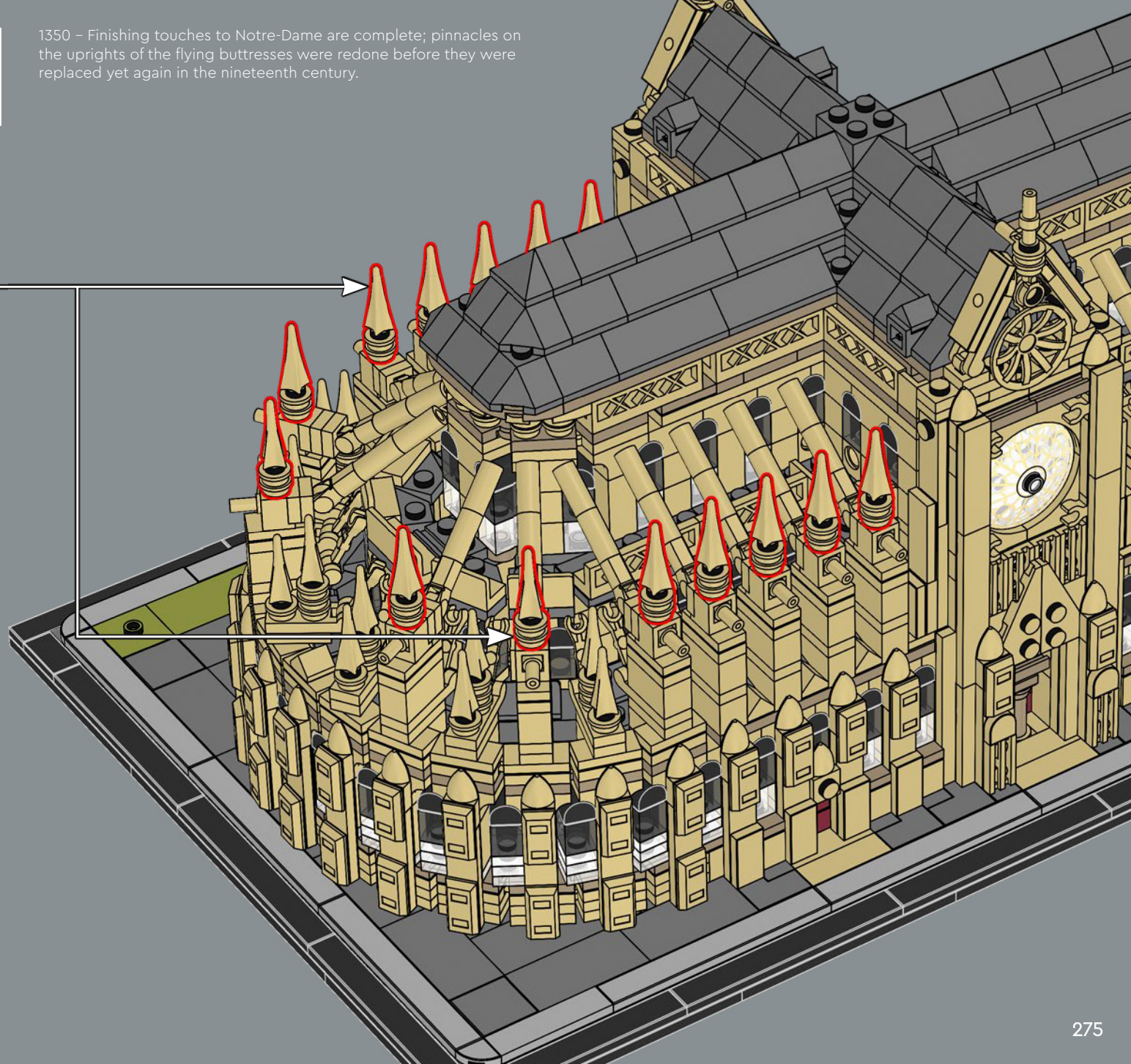



374

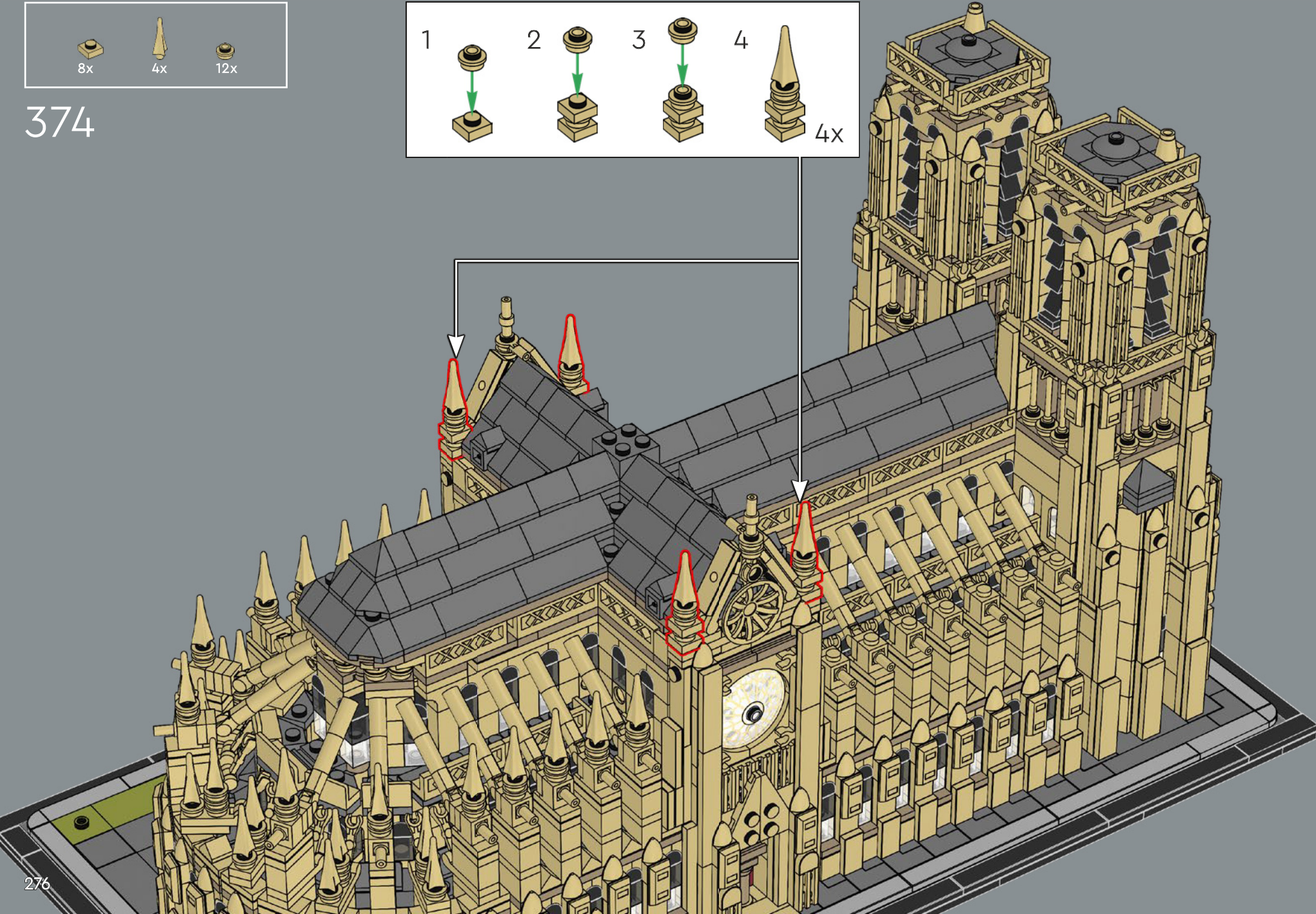
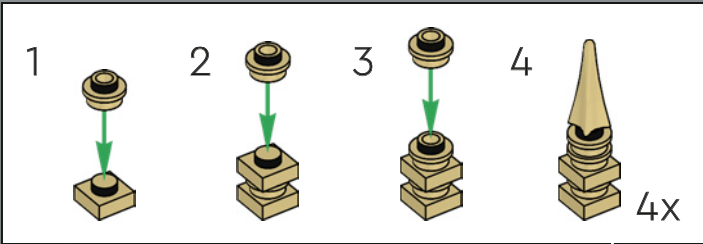



14x



14x

1858 – The tabernacles on the flying buttresses are added by Jean-Baptiste Lassus and Eugene-Emmanuel Viollet-le-Duc.

375



14x

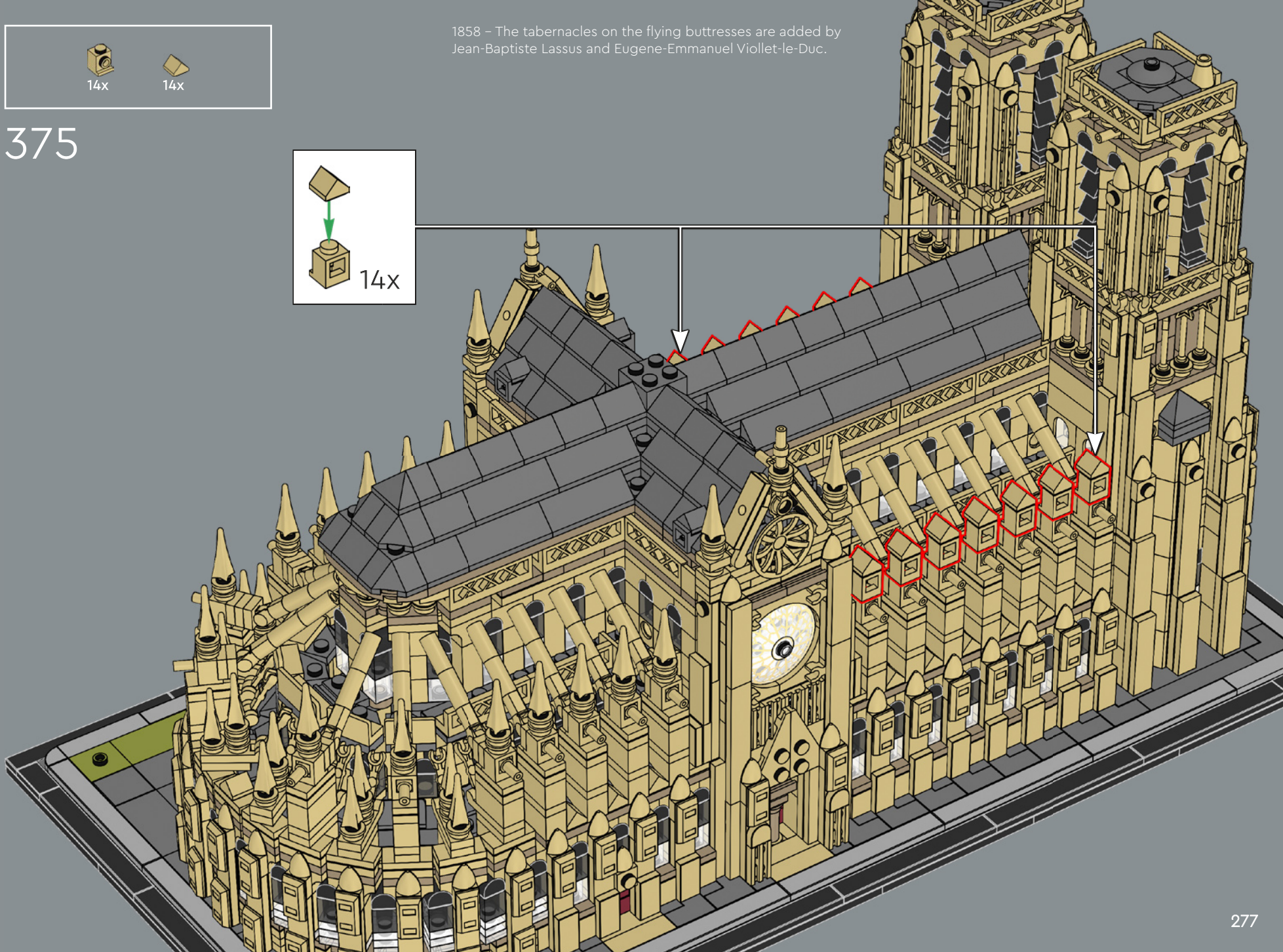



376

At 69 m (226 ft.), the two towers of the western facade made the Notre-Dame Cathedral the tallest building in Paris until the construction of the Eiffel Tower (1887–1889).

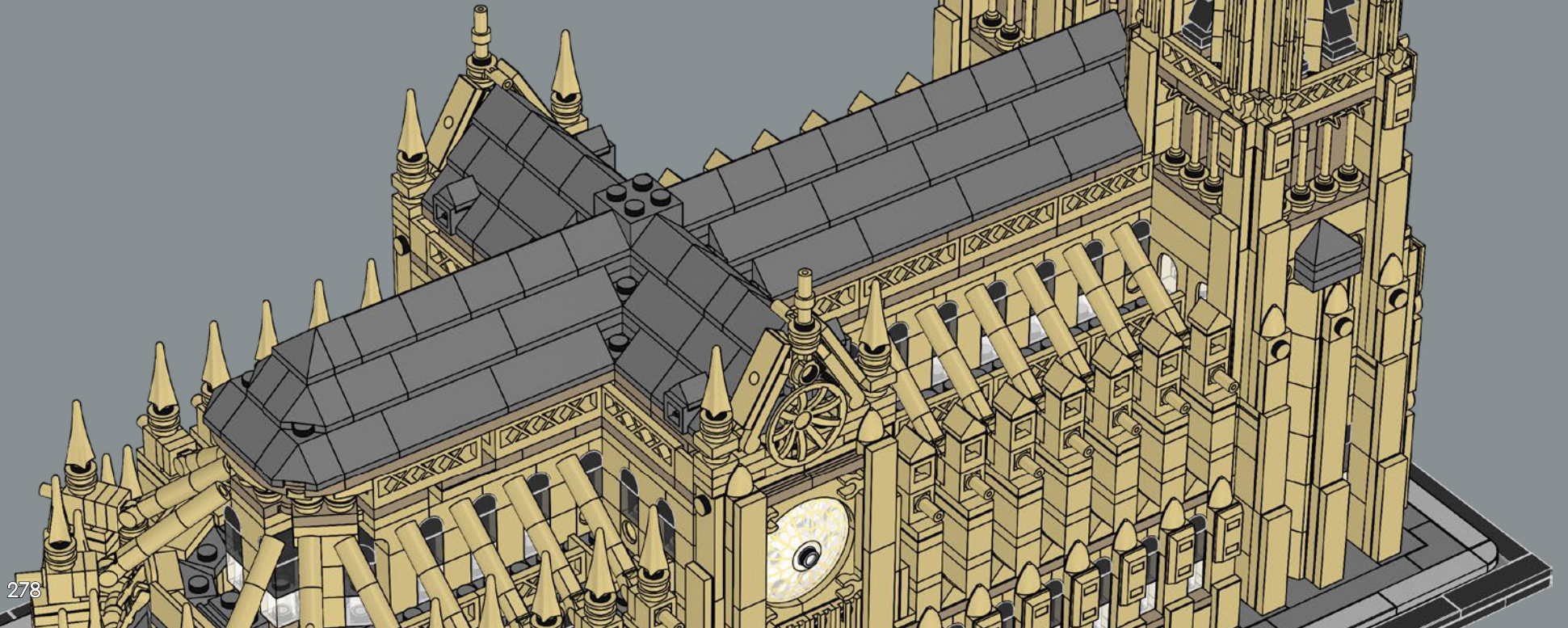



8x

377

1843-1860 – Major restoration by Jean-Baptiste Lassus and Eugene-Emmanuel Viollet-le-Duc.

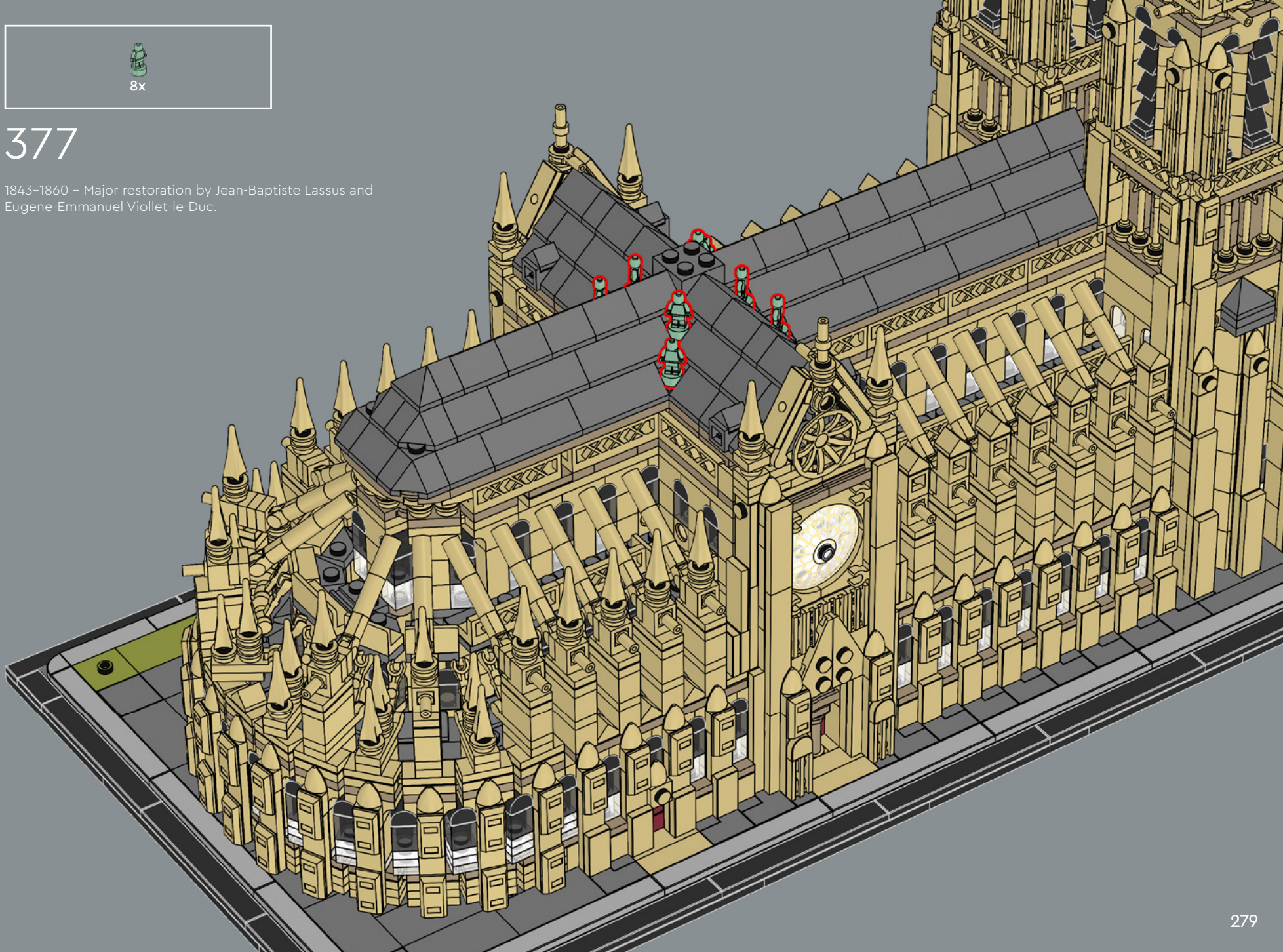



- 2x
- 1x
- 1x
- 8x



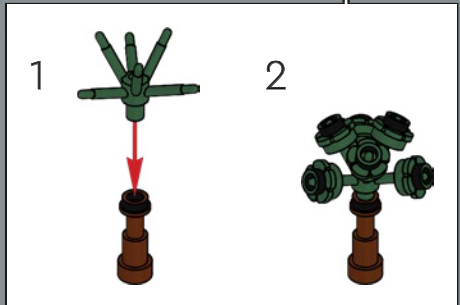
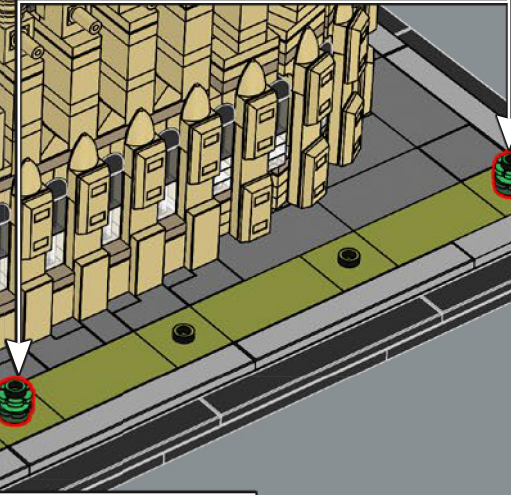
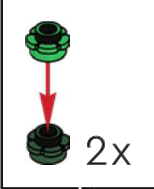

378



 18x
 3x
 3x

379

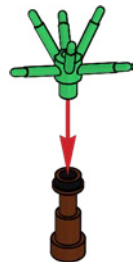

1 
 2 
 3x

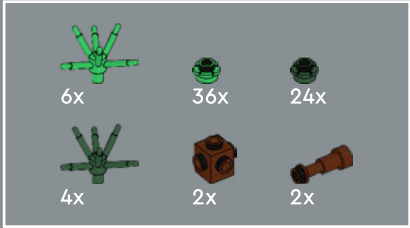
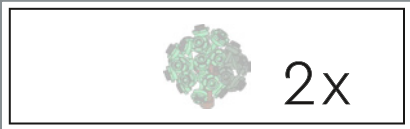

Current sizes of the Notre-Dame Cathedral: Facade width: 43.5 m (142.7 ft.). Transept width: 48 m (157.5 ft.). Total length: 128 m (419.9 ft.). Spire height: 96 m (314.9 ft.). Towers' height: 69 m (226 ft.). Nave roof height: 35 m (114.8 ft.).

380

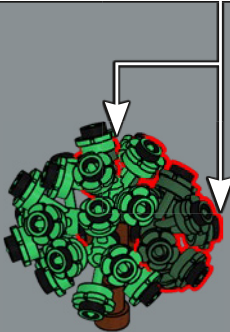
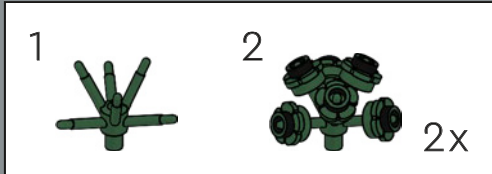
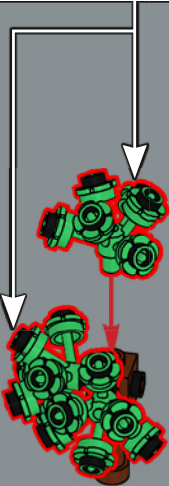
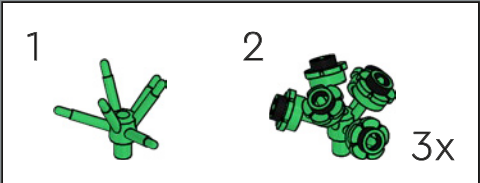

2x



Notre-Dame de Paris

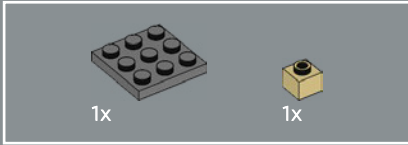
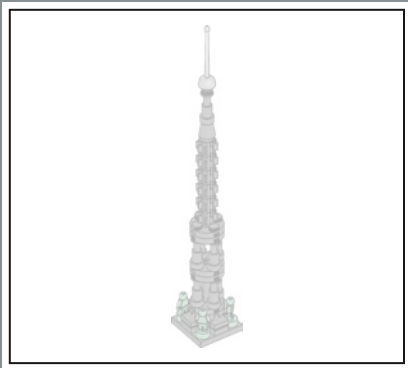

381

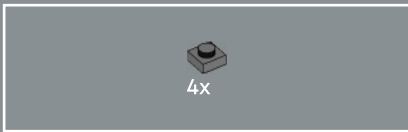
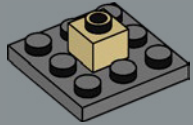

382

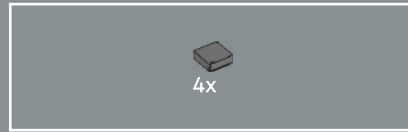
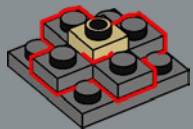

383

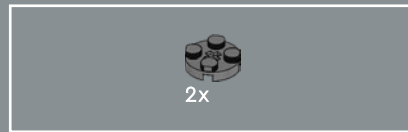
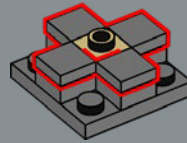

384

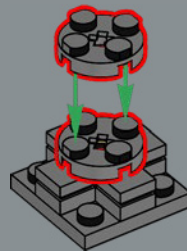

385

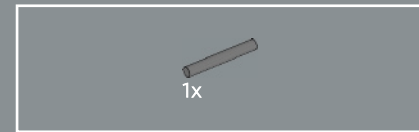
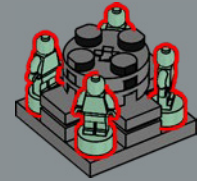

386

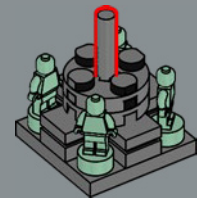



387

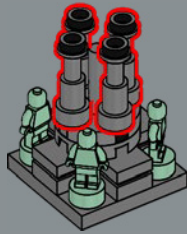

389

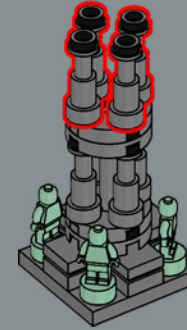

388

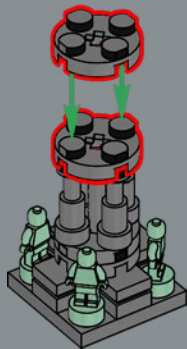

390

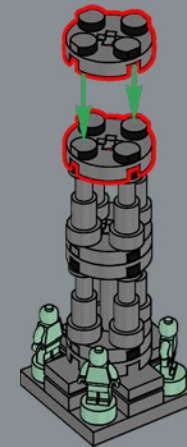

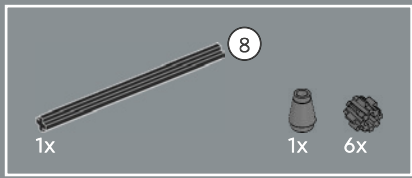

391

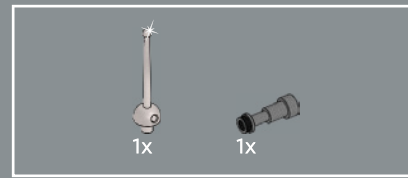
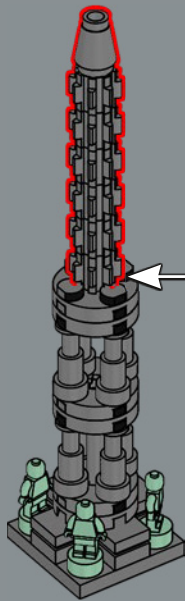
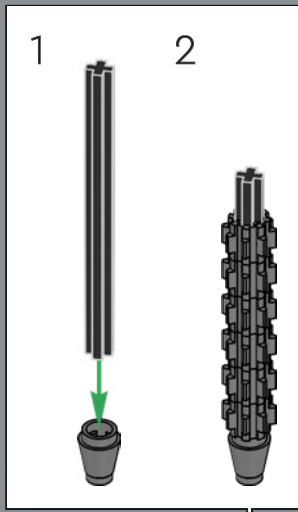

392

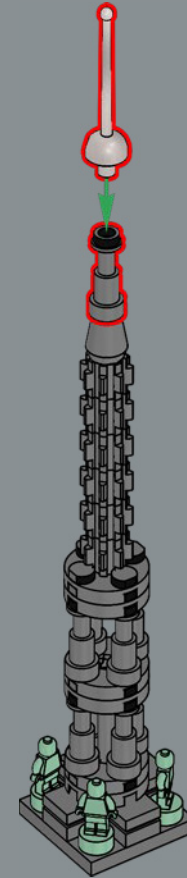

1860 - The spire is reconstructed, now slimmer and taller than the original, with the addition of sculptures of the 12 apostles along the slope of the roof.

The front doors of the LEGO® Notre-Dame Cathedral are open to allow us to peek through and feel the sense of awe you might experience when entering the intricate, vast arched space within.

393

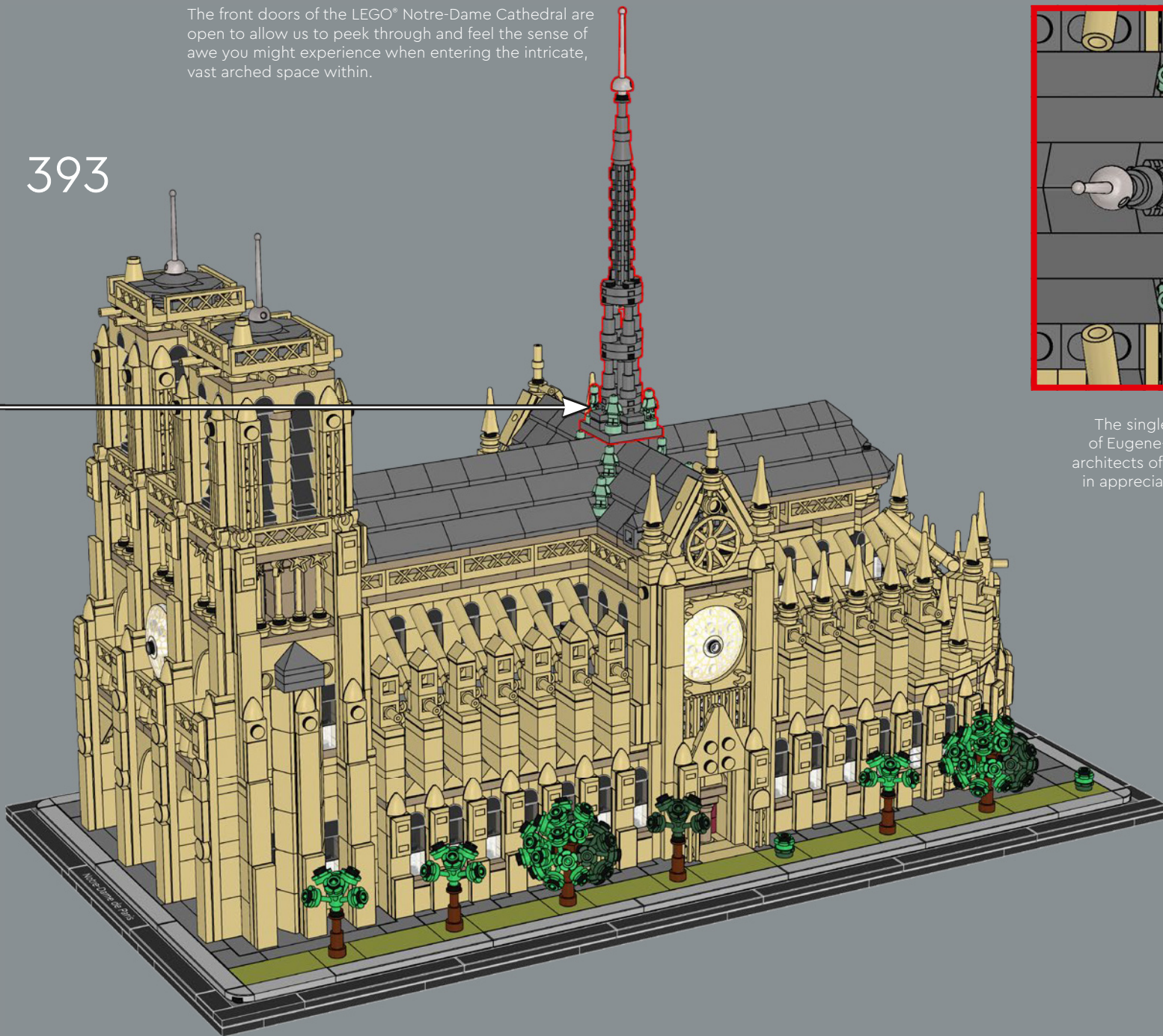

The single statue facing the spire has the face of Eugene-Emmanuel Viollet-le-Duc, one of the architects of the Cathedral. He gazes at the spire in appreciation of the building, while the others watch over Paris.



FIRE AND REBUILDING

After the devastating fire in April 2019, the Notre-Dame Cathedral was forced to close indefinitely, pending reconstruction. As the world watched rescue workers extinguish the fire, global fundraising campaigns raised overwhelming contributions towards the extensive rebuilding efforts in record time. A testament to the lasting impression the Notre-Dame Cathedral has left on people of all cultures throughout its lifespan, and to the incomparable spirit of Paris. With nearly 900 years of history packed into more than 4,000 LEGO® elements, we are excited to include this model in our LEGO Architecture collection.





6x
4616711



80x
6300322



8x
6231386



12x
6449564



1x
6167854



2x
6300321



8x
6458397



32x
6446790



5x
6398343



5x
6264025



1x
6341471



2x
6133765



7x
6428178



6x
6310449



1x
4211389



2x
6267495



6x
4211511



2x
4213567



6x
6383177



4x
6401023



4x
4211356



6x
4211445



16x
4211481



2x
4654582



2x
6469440



4x
6176433



12x
6335936



4x
4211098



1x
4211088



3x
4211060



1x
4211085



4x
4211044



4x
4558955



18x
4535930



22x
4211127



12x
4210848



4x
4210719



9x
4211063



14x
4211052



14x
6092572



16x
4210635



2x
6126083



2x
6309059



6x
6177079



10x
4211094



2x
4211055



31x
6247784



31x
6343852



4x
4568734



1x
4211133



12x
4211043



2x
4211053



19x
6039176



4x
6307616



19x
4560184



5x
42110651



1x
4243831



2x
4210998



1x
4211115



1x
4211134



2x
6296892



1x
4543086



9x
6284596



2x
4210633



4x
6221607



3x
4210872



3x
4210869



6x
4211042



2x
4211010



10x
6164073



2x
4527082



1x
6310596



9x
6396412



6x
6012451



20x
4211045



6x
4218188



2x
4210678



20x
4211114



3x
6222063



8x
6212080



8x
6016488



86x
6470140



24x
6446336



[LEGO.com/service](https://www.lego.com/service)



YOU COULD WIN



YOU COULD WIN

Your feedback will help shape the future development of this product series.

Visit:

DU KÖNNTEST GEWINNEN

Dein Feedback trägt zur Weiterentwicklung dieser Produktreihe bei.

Geh auf:

VOUS POURRIEZ GAGNER

Vos commentaires nous aideront à concevoir les futurs produits de cette gamme.

Visitez :

POTRESTI VINCERE TU

La tua opinione ci aiuterà a migliorare la creazione futura di questa linea di prodotti.

Visita:

PUEDES GANAR

Tu opinión contribuirá al futuro de esta serie de productos.

Visita:

轻松获奖

您的反馈将有助于我们在今后改进本产品系列。

请访问:

LEGO.com/productfeedback

You also have the chance to win a LEGO® set.

Terms and conditions apply.*

Außerdem hast du die Chance, ein LEGO® Set zu gewinnen.

Es gelten die Teilnahmebedingungen.*

Vous pourriez également gagner un ensemble LEGO®.

Des conditions s'appliquent.*

Hai anche la possibilità di vincere un set LEGO®.

Termini e condizioni sono applicabili.*

También tienes la oportunidad de ganar un set LEGO®.

Aplican términos y condiciones.*

您还有机会赢取乐高®套装。

条款和条件适用。*

*LEGO.com/productfeedback-terms

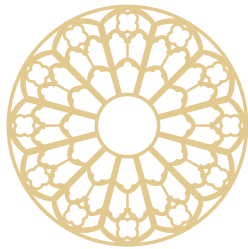

LEGO and the LEGO logo are trademarks of the LEGO Group. ©2024 The LEGO Group. 6521157
Adam Reed Tucker is the co-developer of the LEGO® Architecture product line.