



10333

THE LORD OF THE RINGS



餐厅

👁️ 这一层设有巴拉都的大餐厅。魔栏农半兽人勾斯魔格将军在那里监督饭菜的准备和供应。在野外，半兽人可能无法定期进食，但在这里，长长的餐桌上为将军和他手下摆满了美味佳肴和烈酒。悬挂在熔岩炉上方的大锅正在炖煮菜肴，其中有几种可疑的食材（可能还有一些熟悉的食材）。左边墙壁上有一个密室，里面有关于为精灵锻造的力量之戒的秘密。



半兽人



半兽人



勾斯魔格

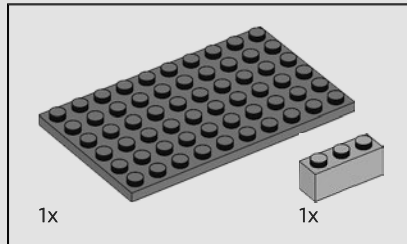
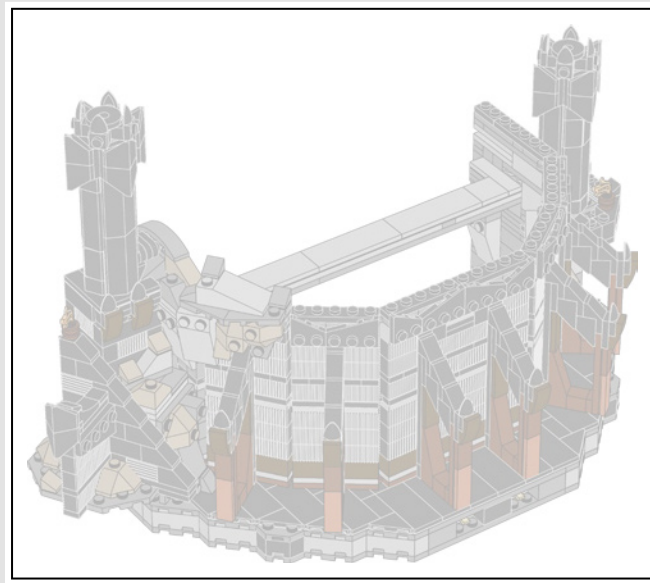

1

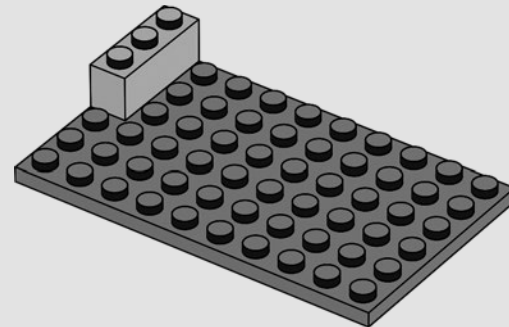

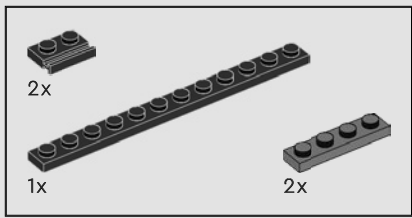

2

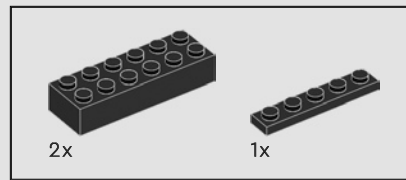
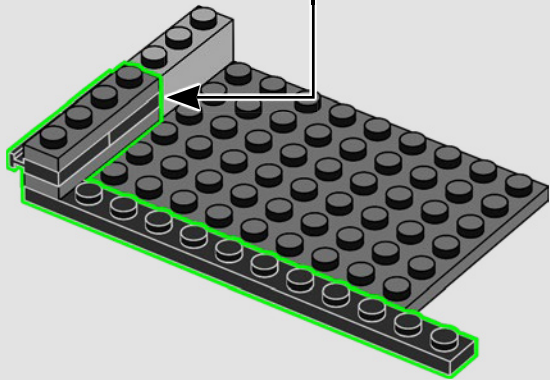
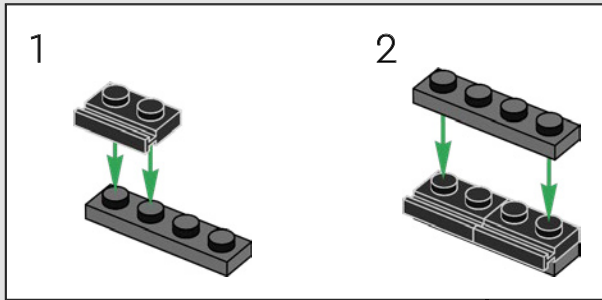

3

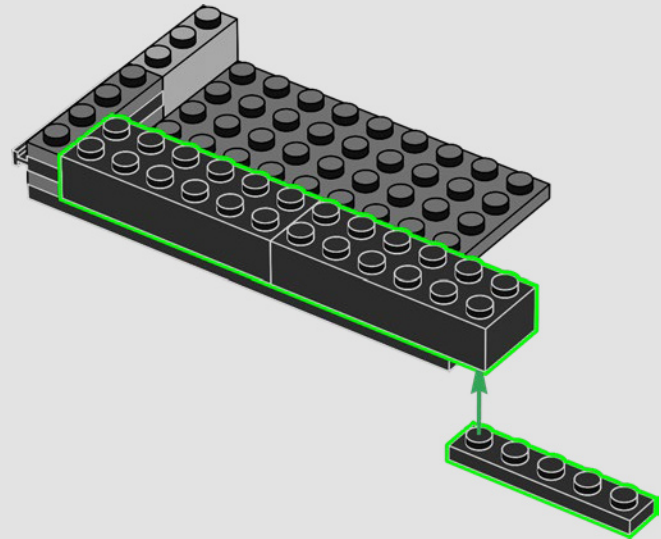

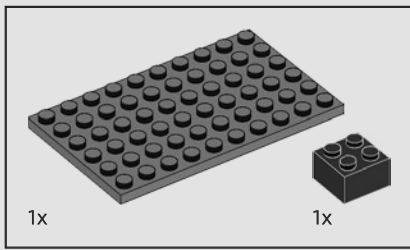

4

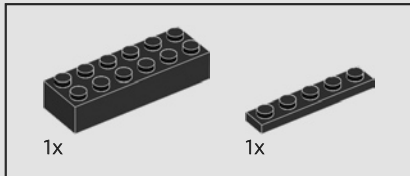
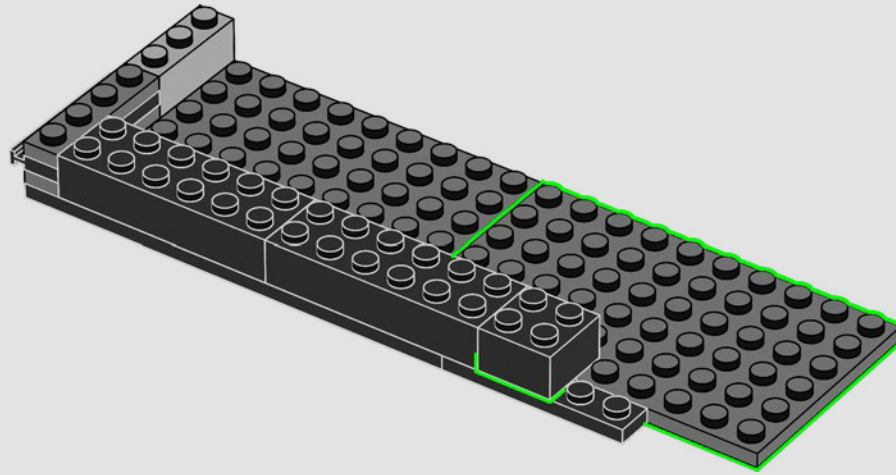

5

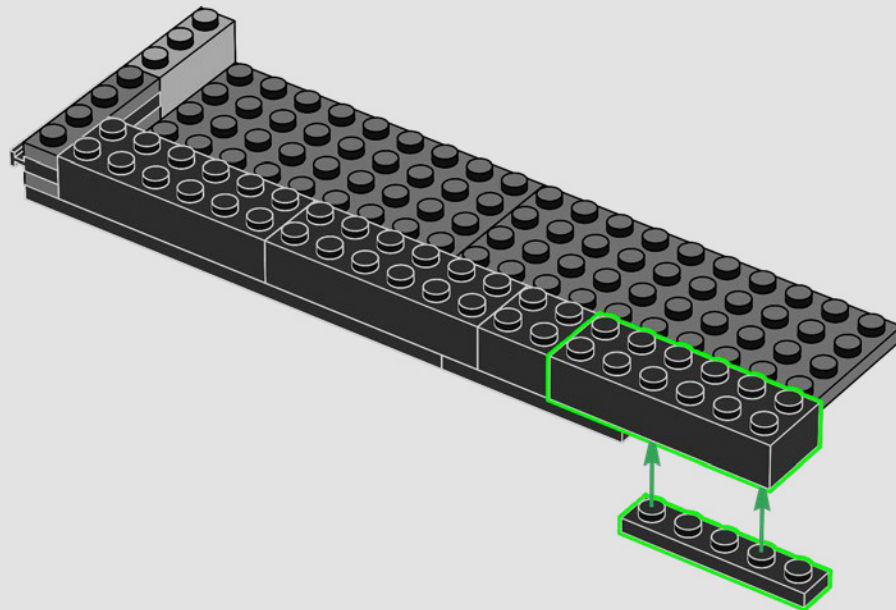

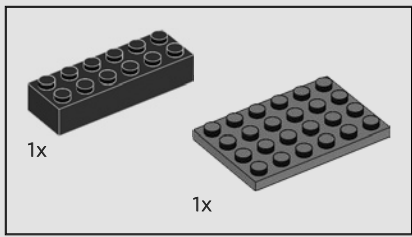

6

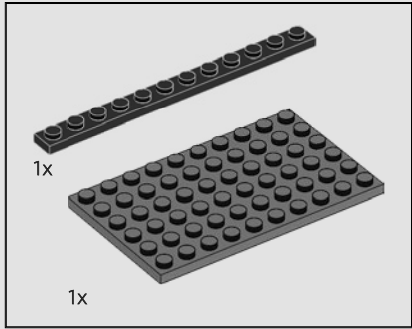
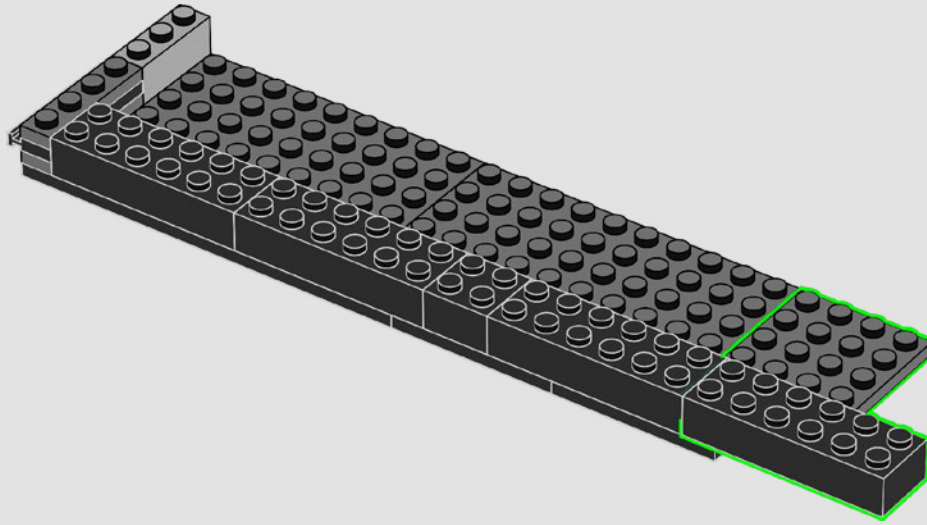

7

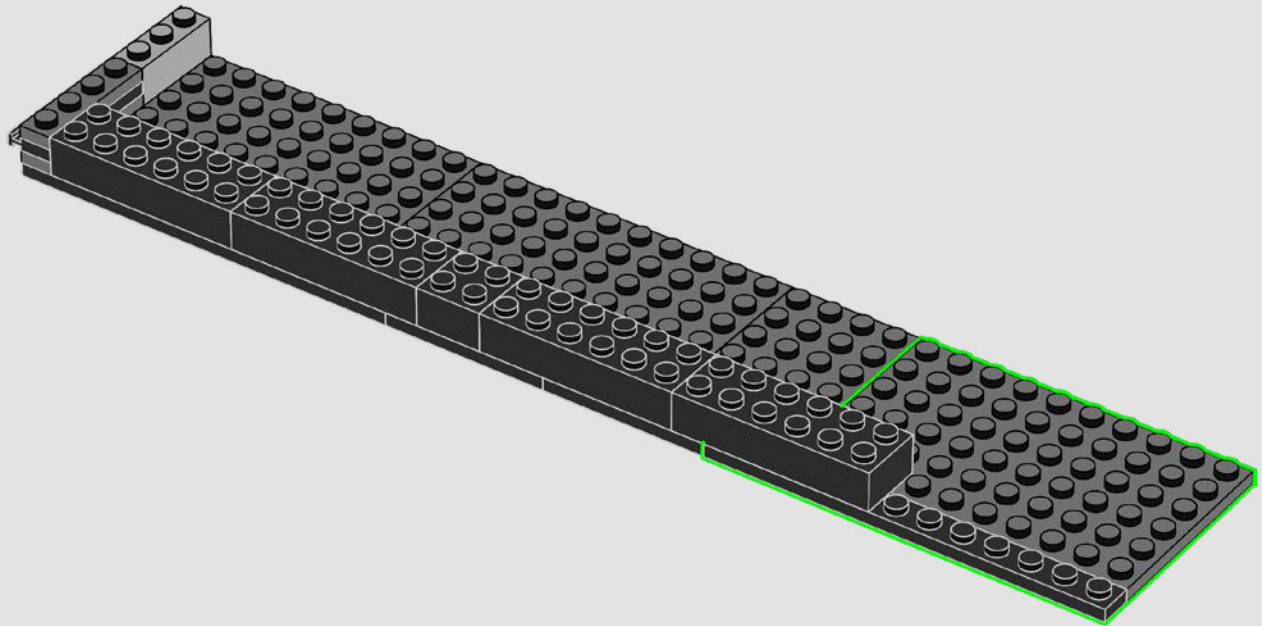

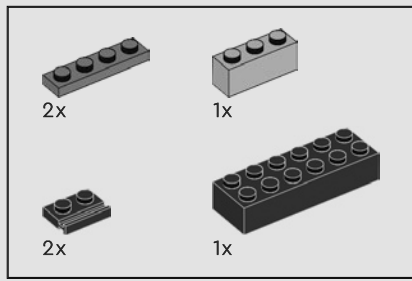

8

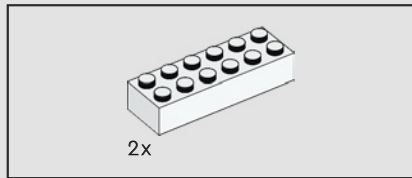
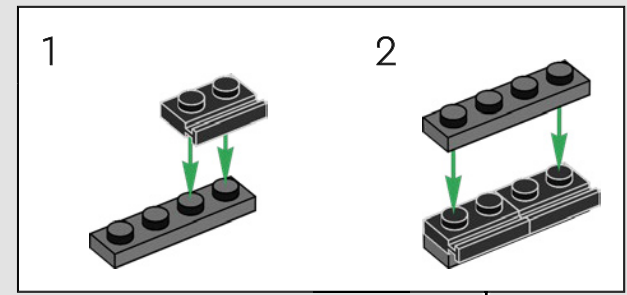
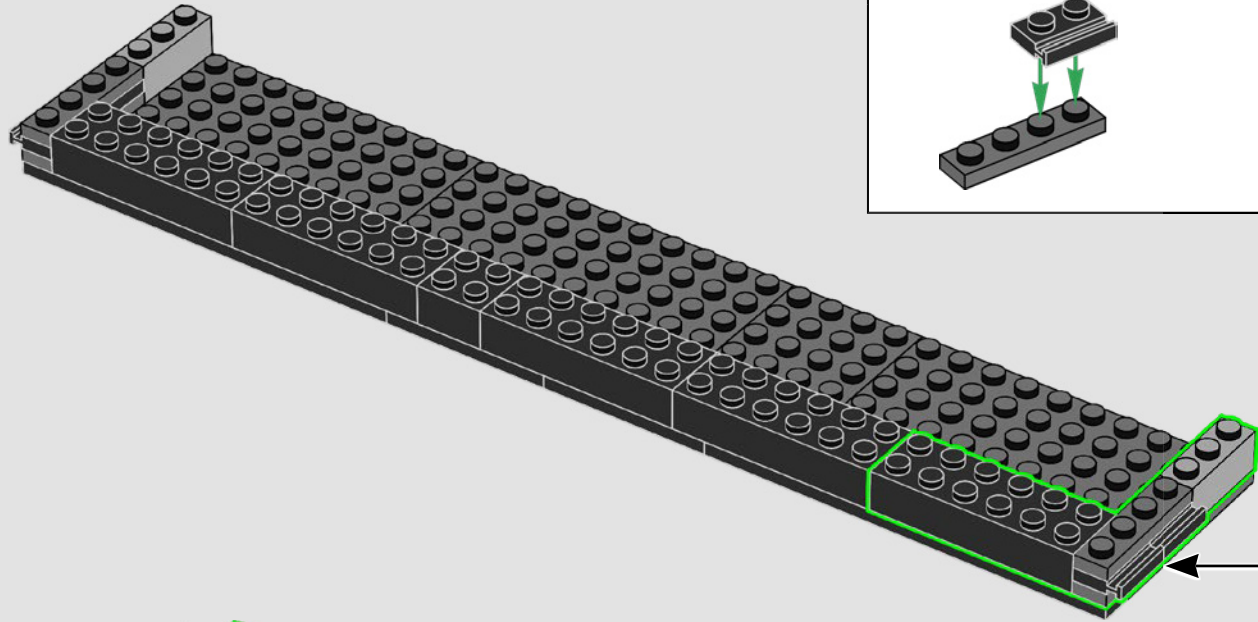

9

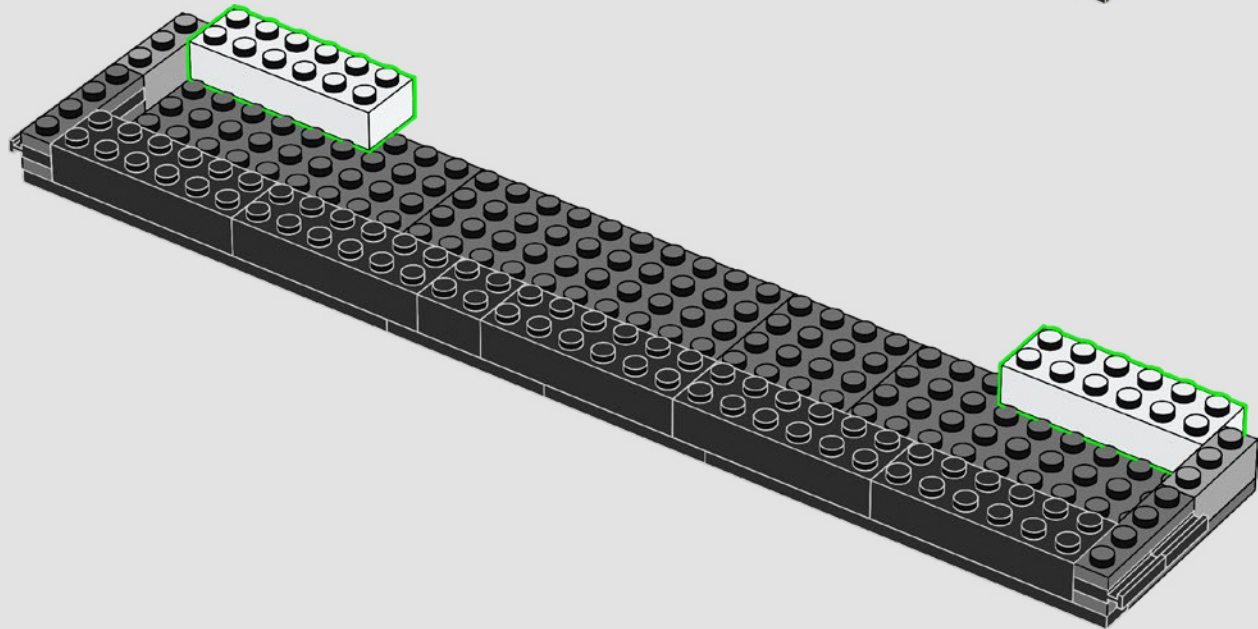

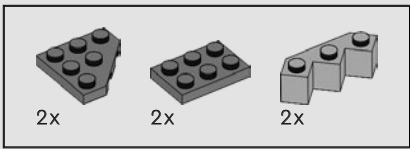

10

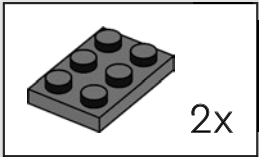
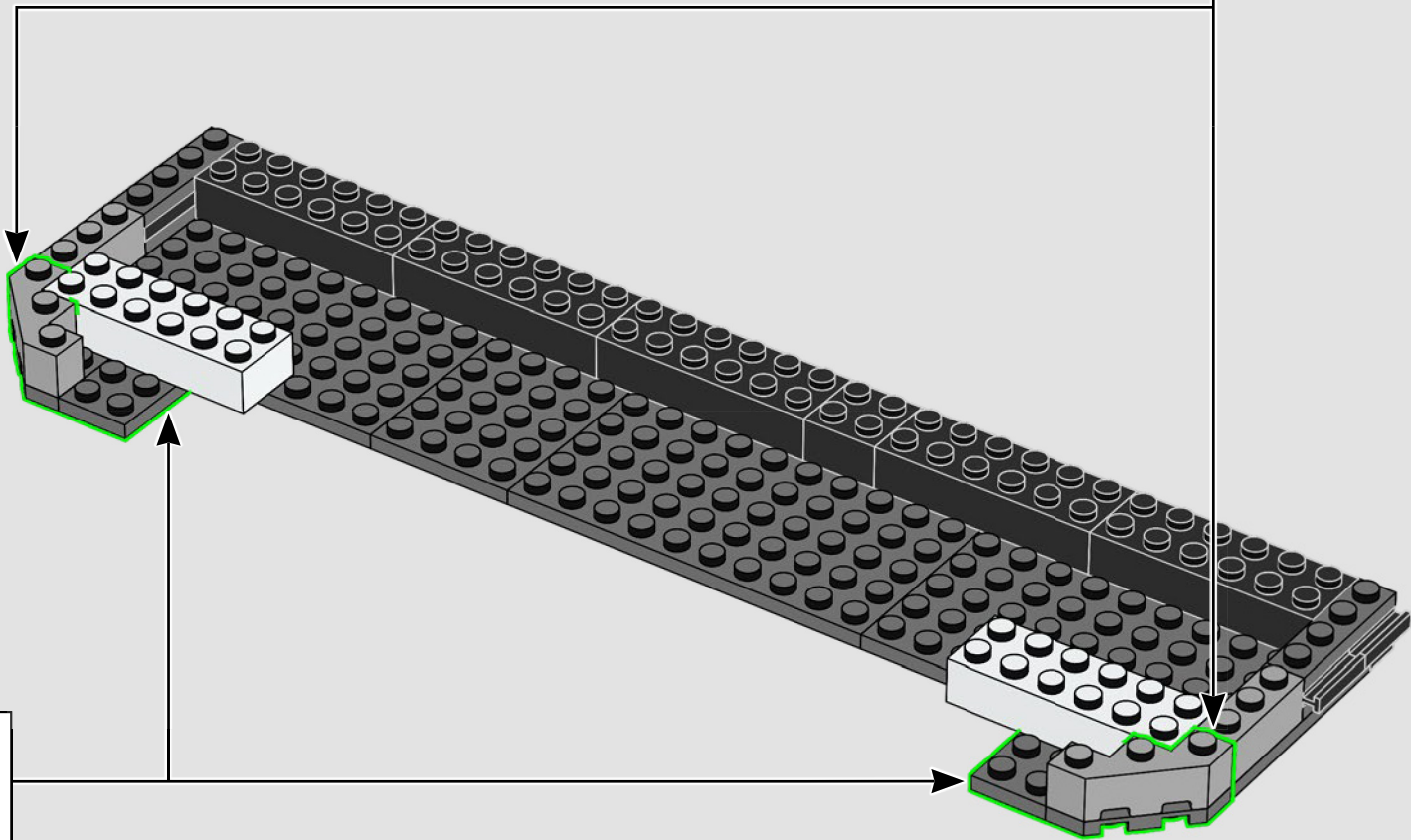
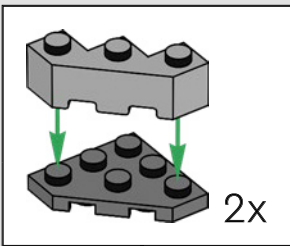

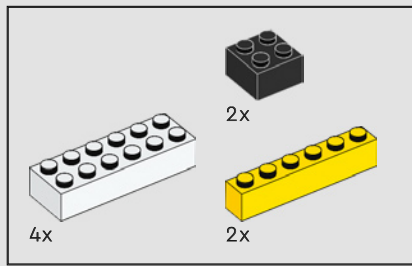

11

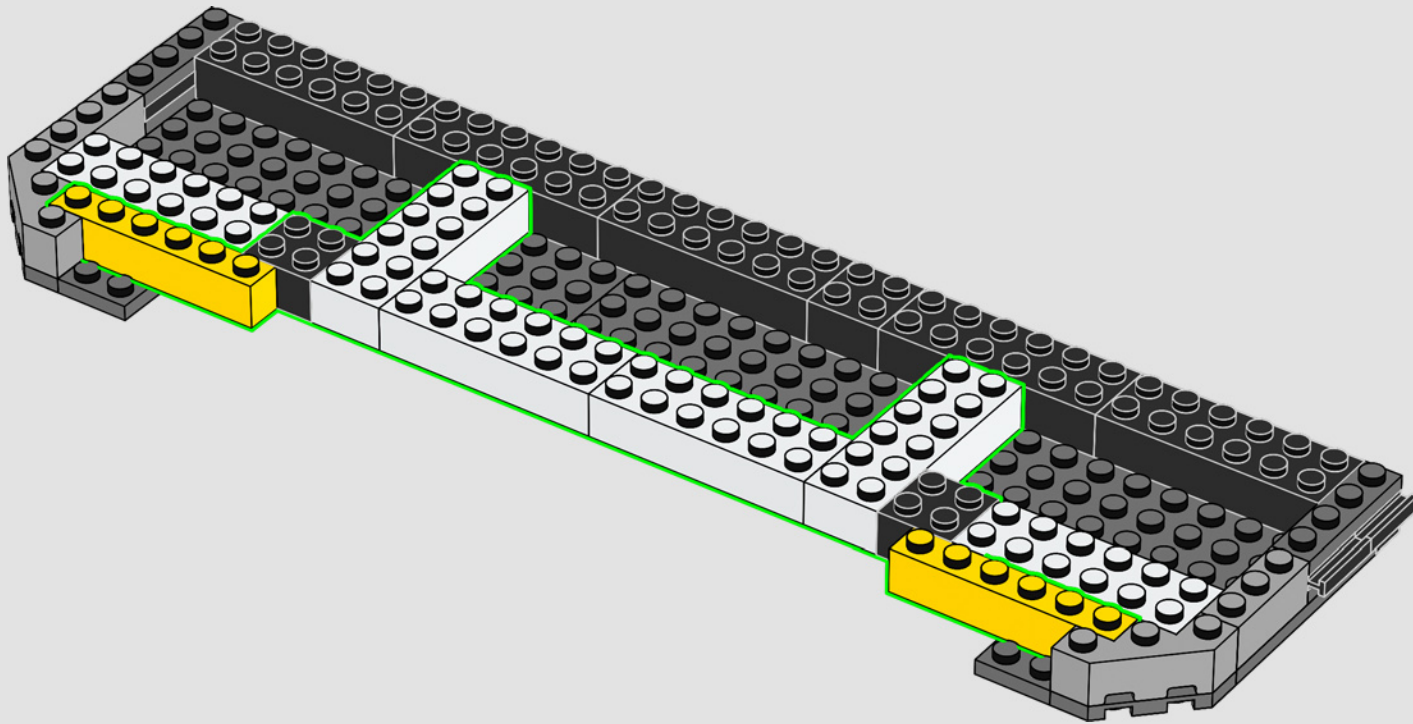



“在魔多之地，黑暗魔王索伦秘密锻造了一枚统领之戒，来控制其余的魔戒。他把自己的残忍、邪恶以及那要凌驾于所有生灵之上的欲念倾注到这枚戒指中。至尊魔戒统御众戒。” - 凯兰崔尔

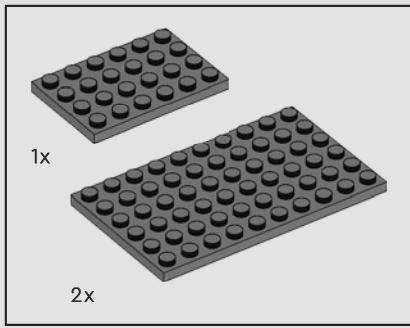

12

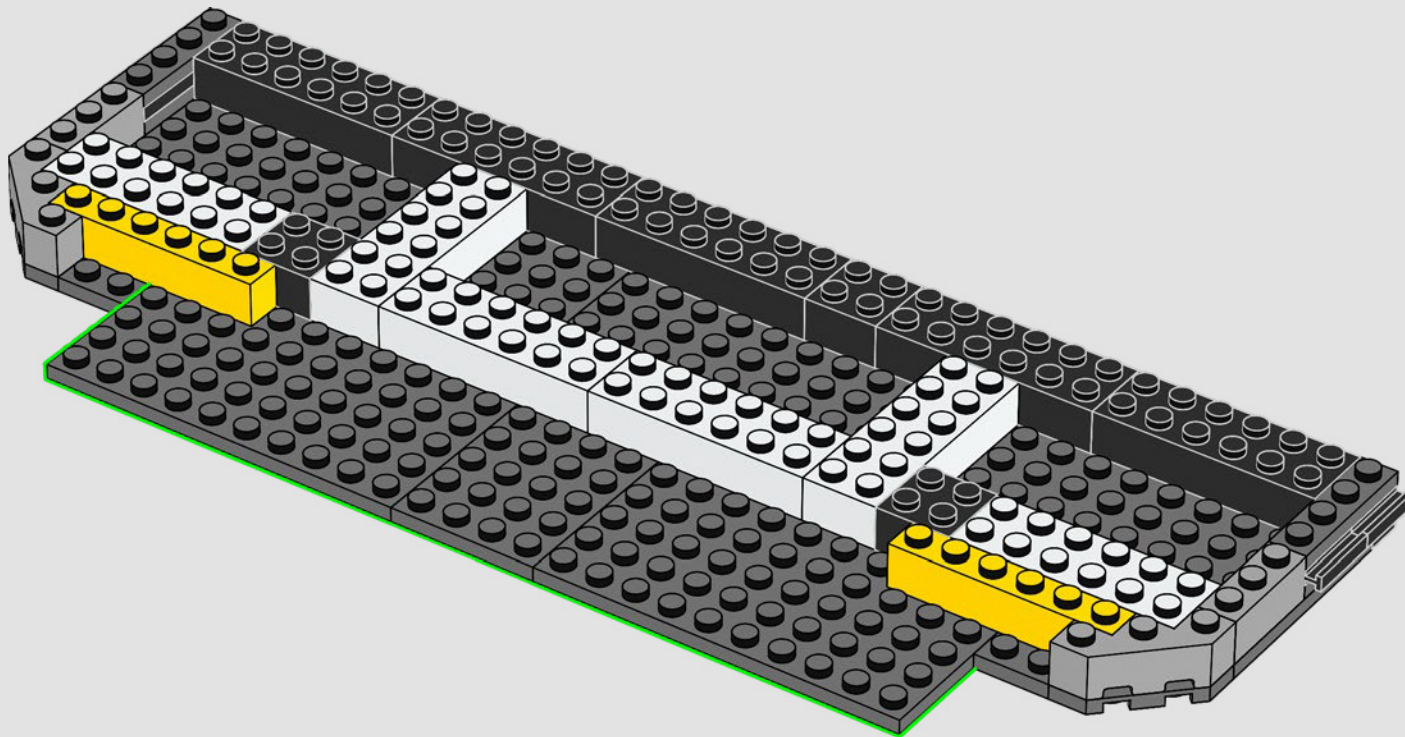

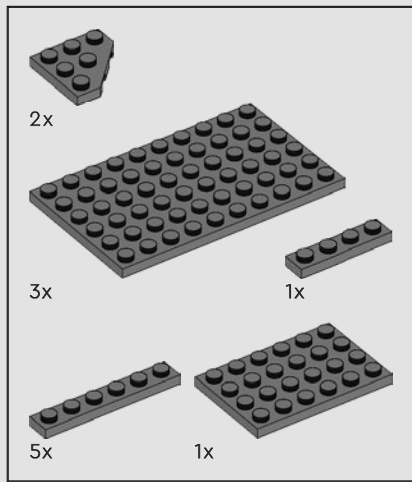

13

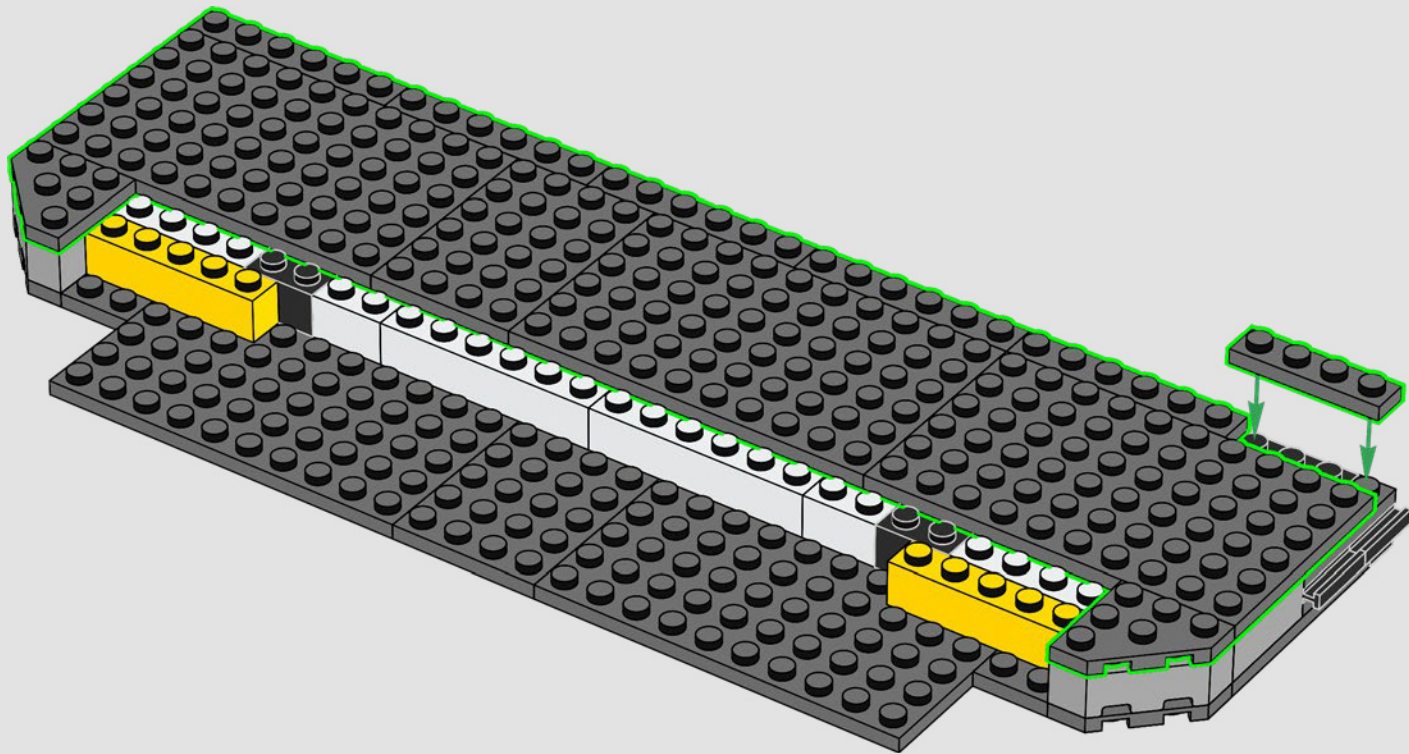

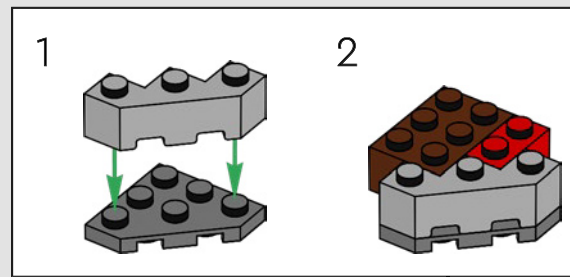
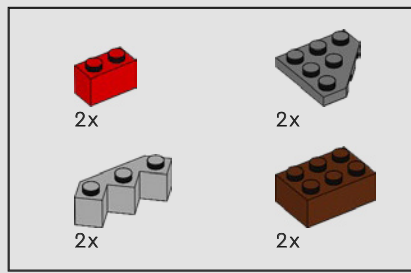

14

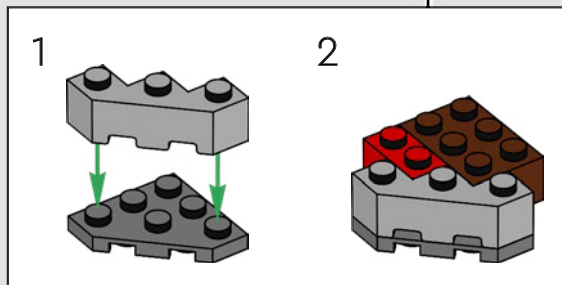
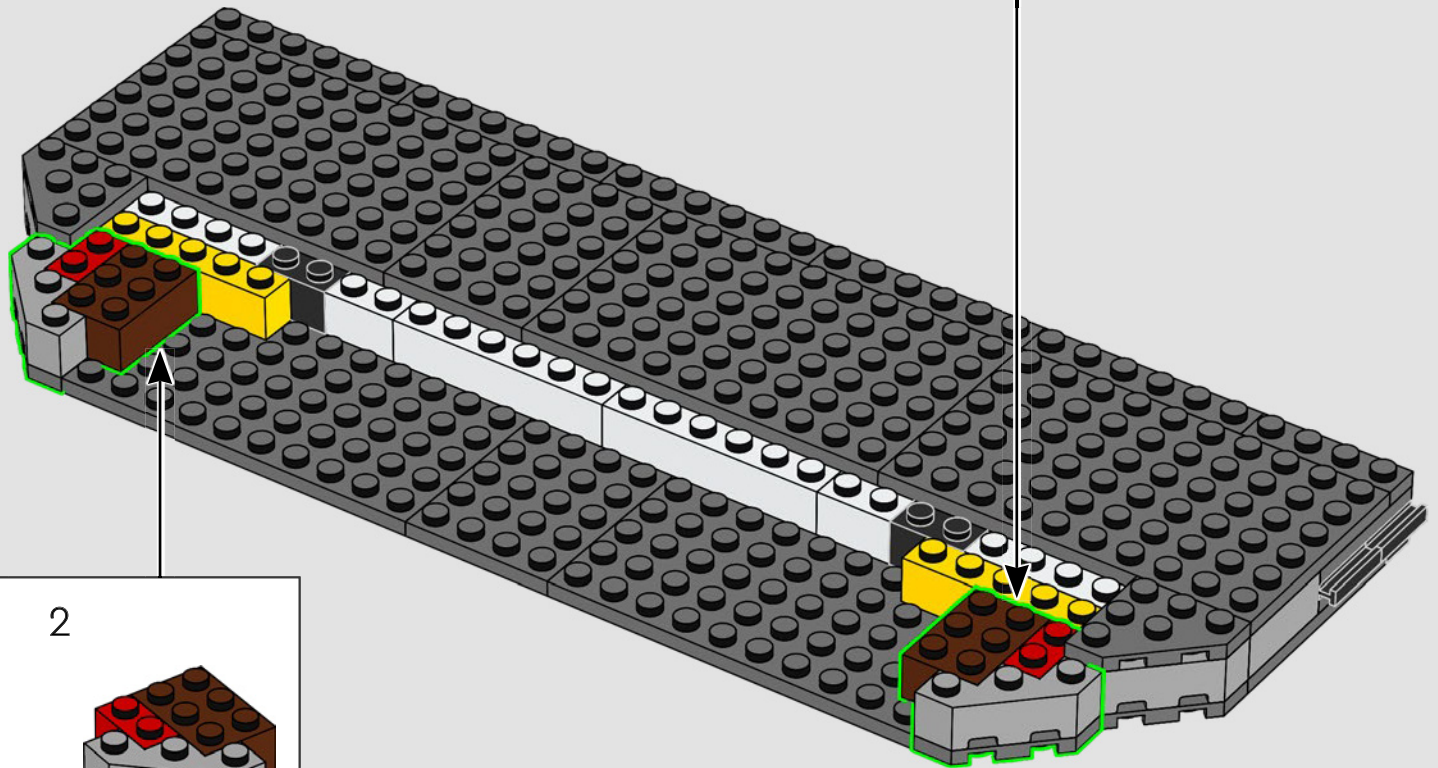

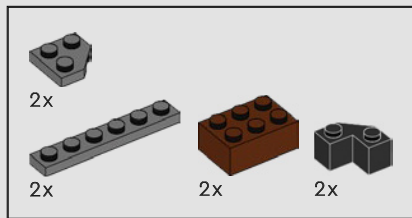

15

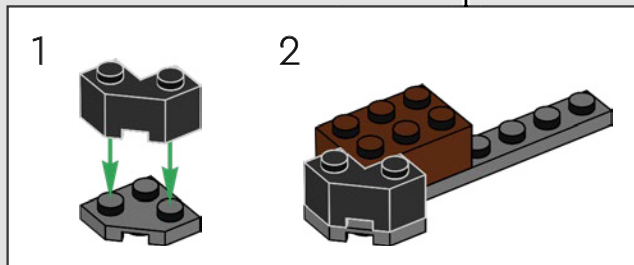
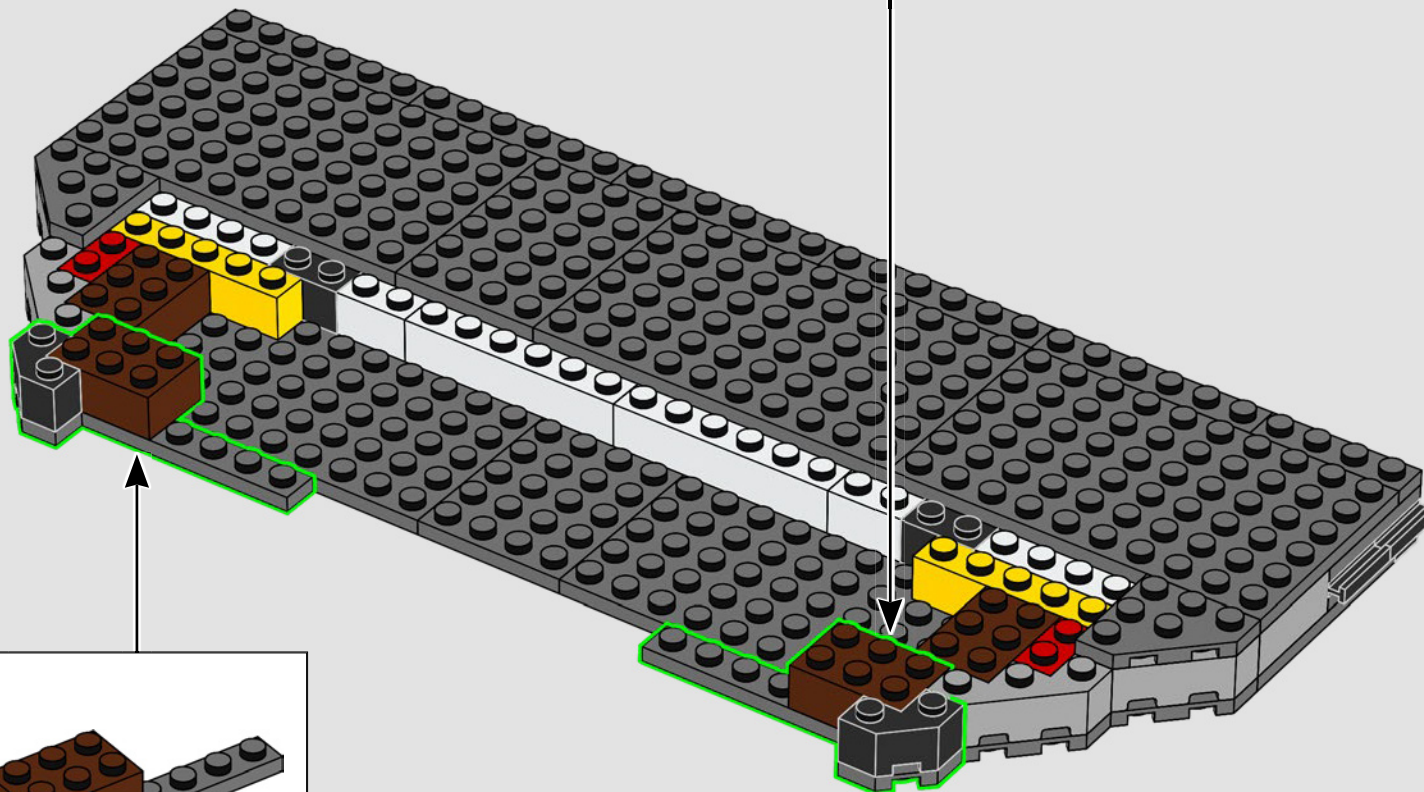
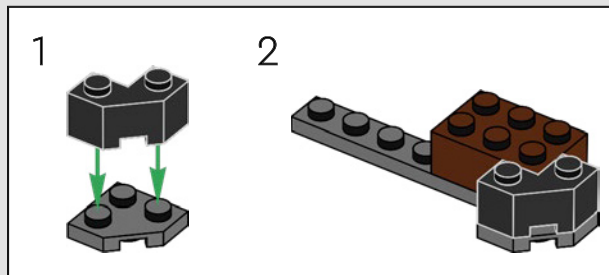

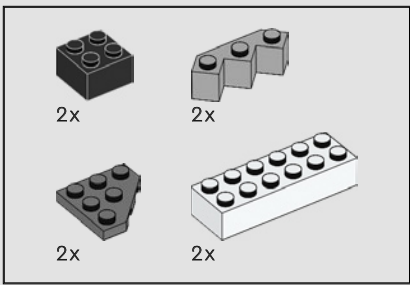

16

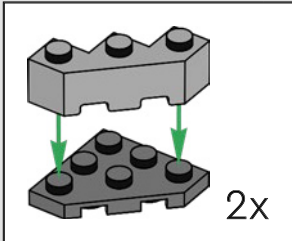
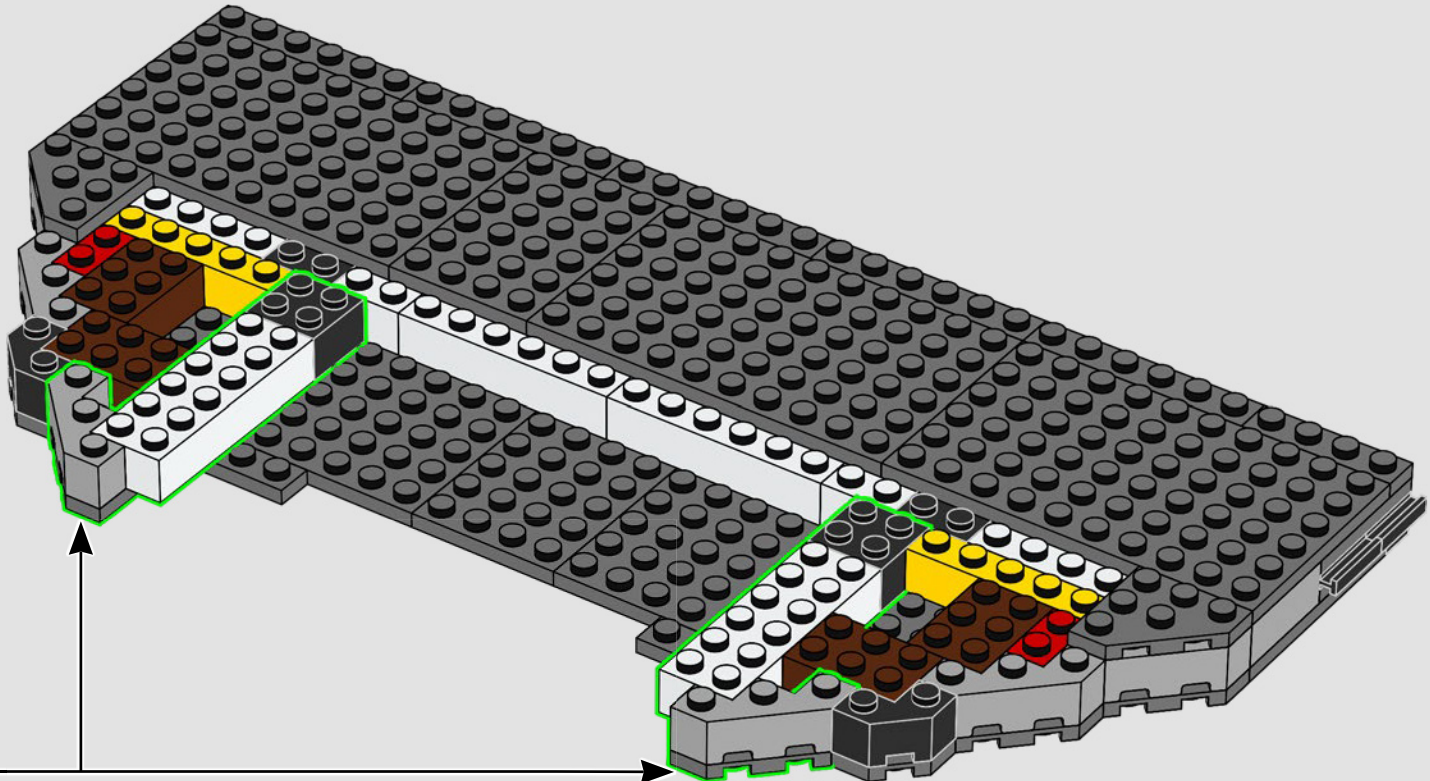

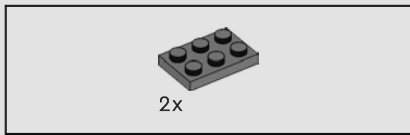

17

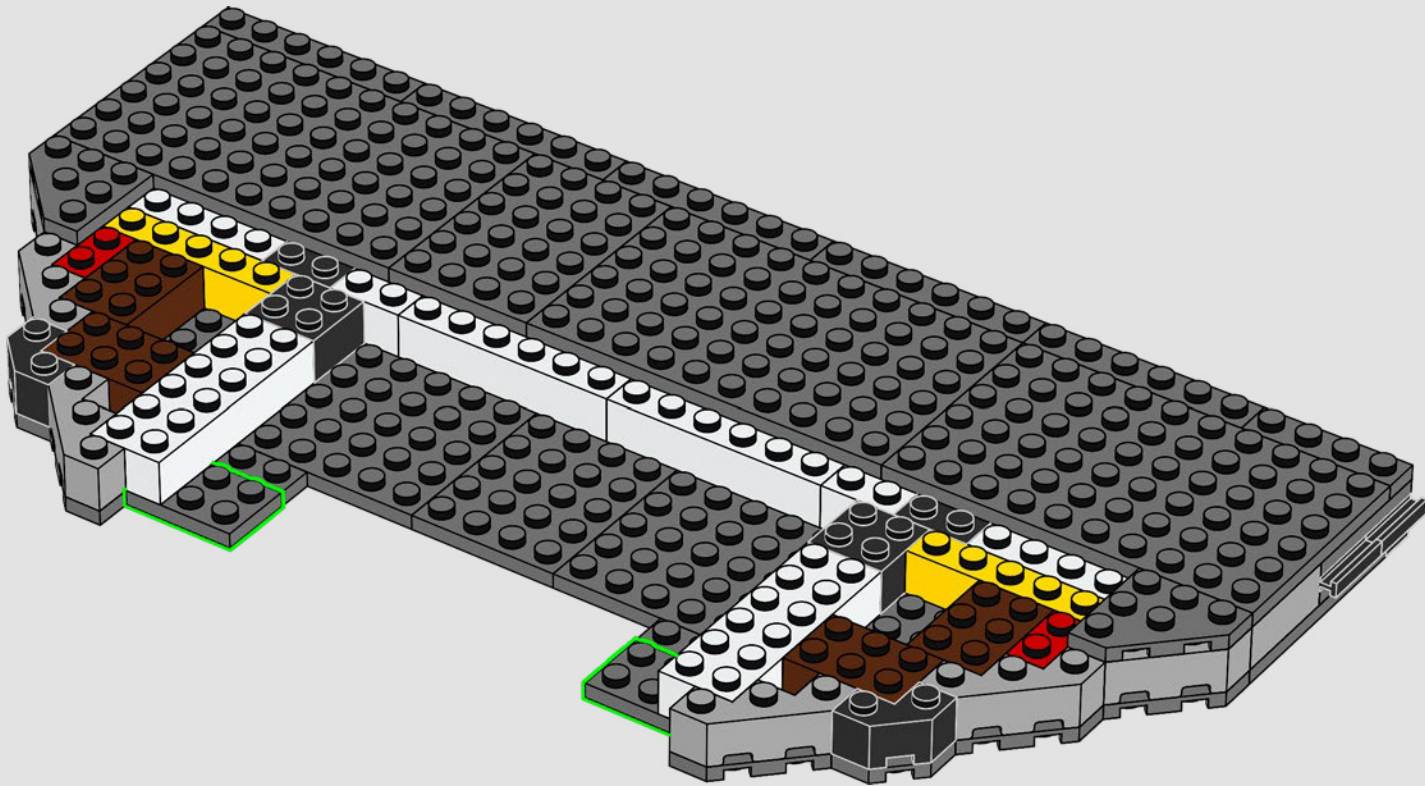

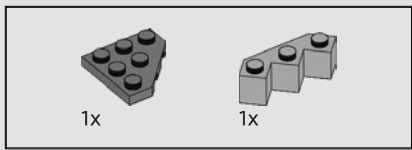

18

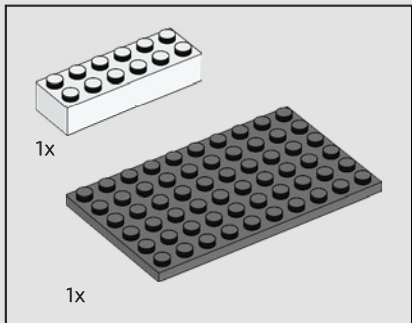
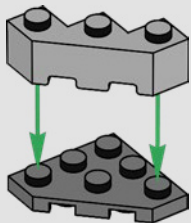

19

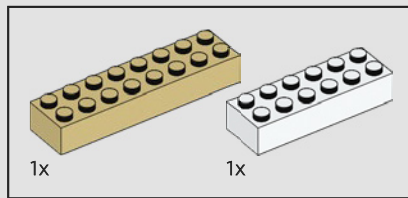
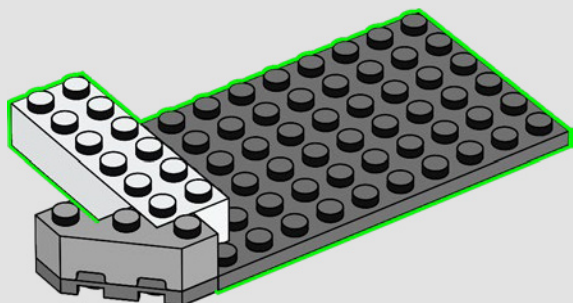

20

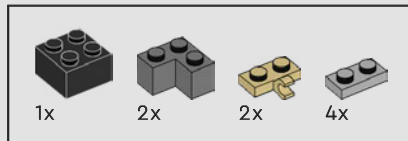
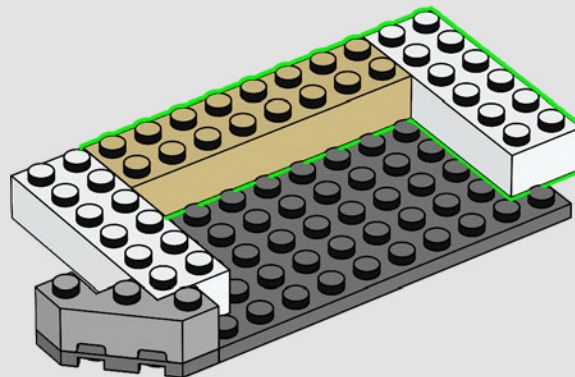

21

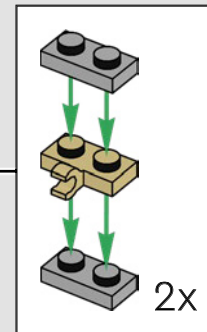
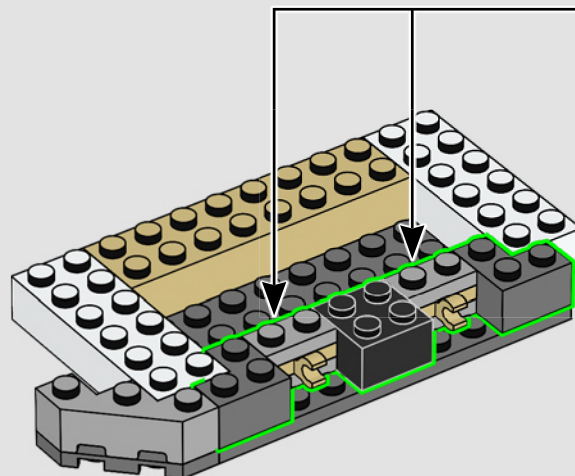

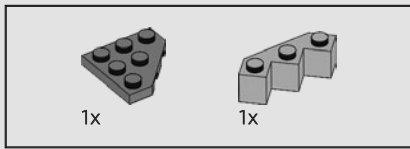

22

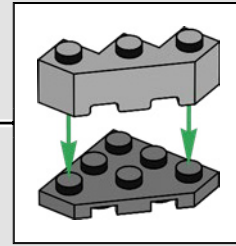
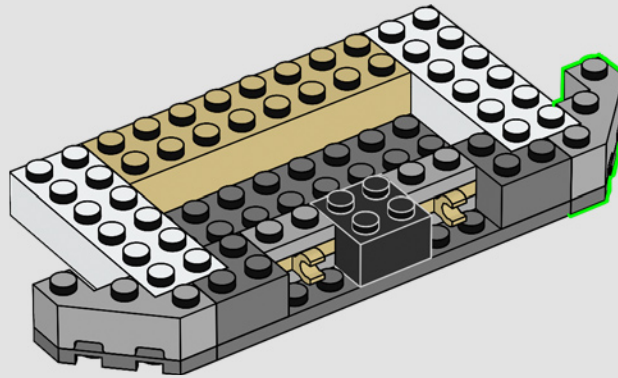

23

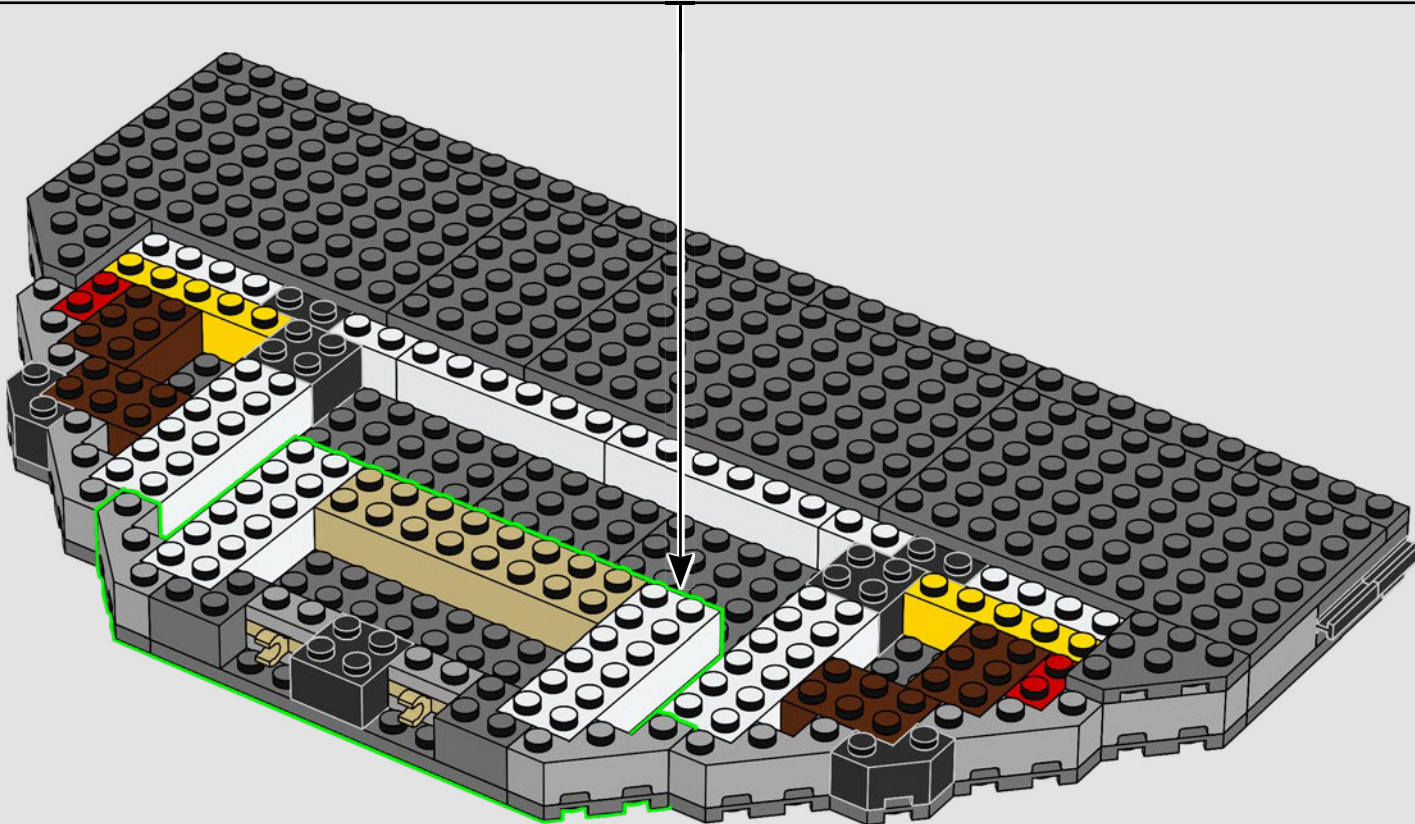

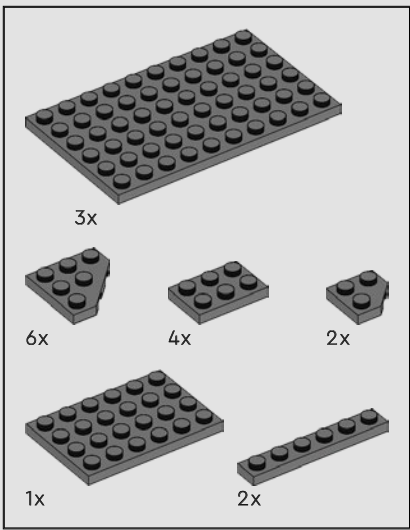

24

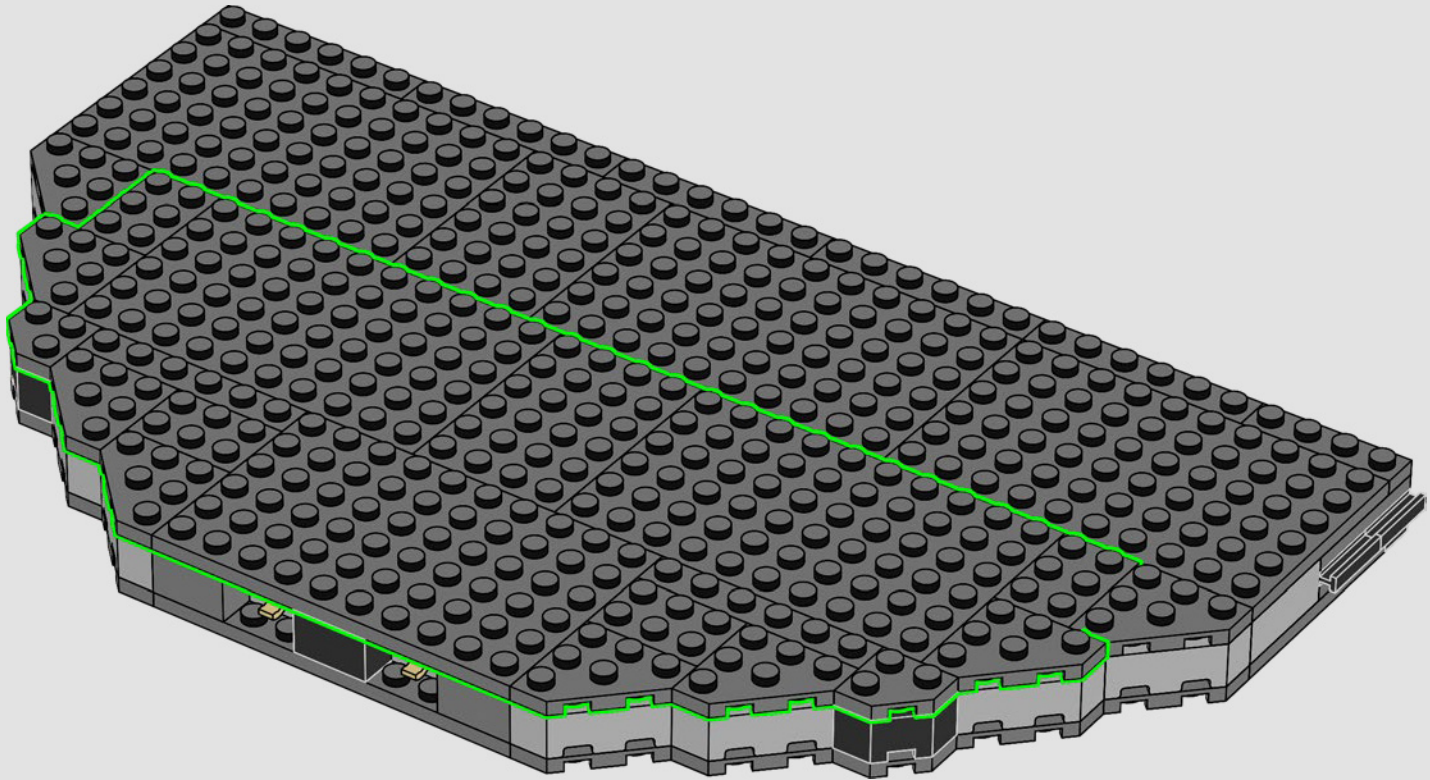

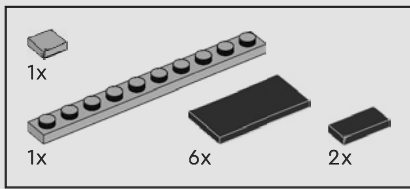

25

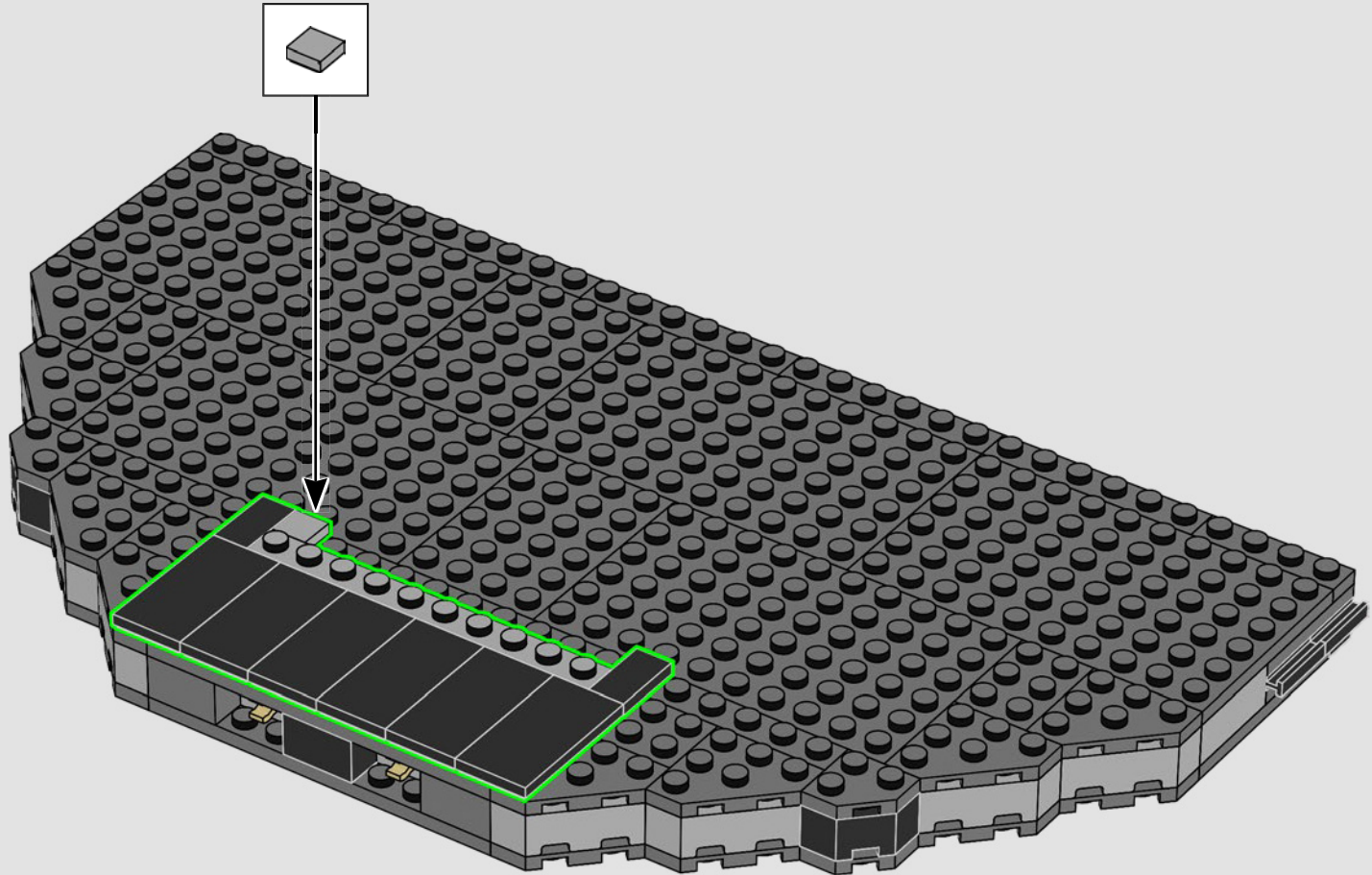

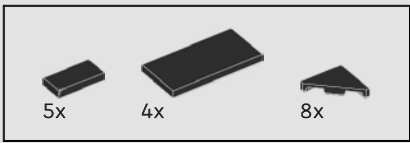

26

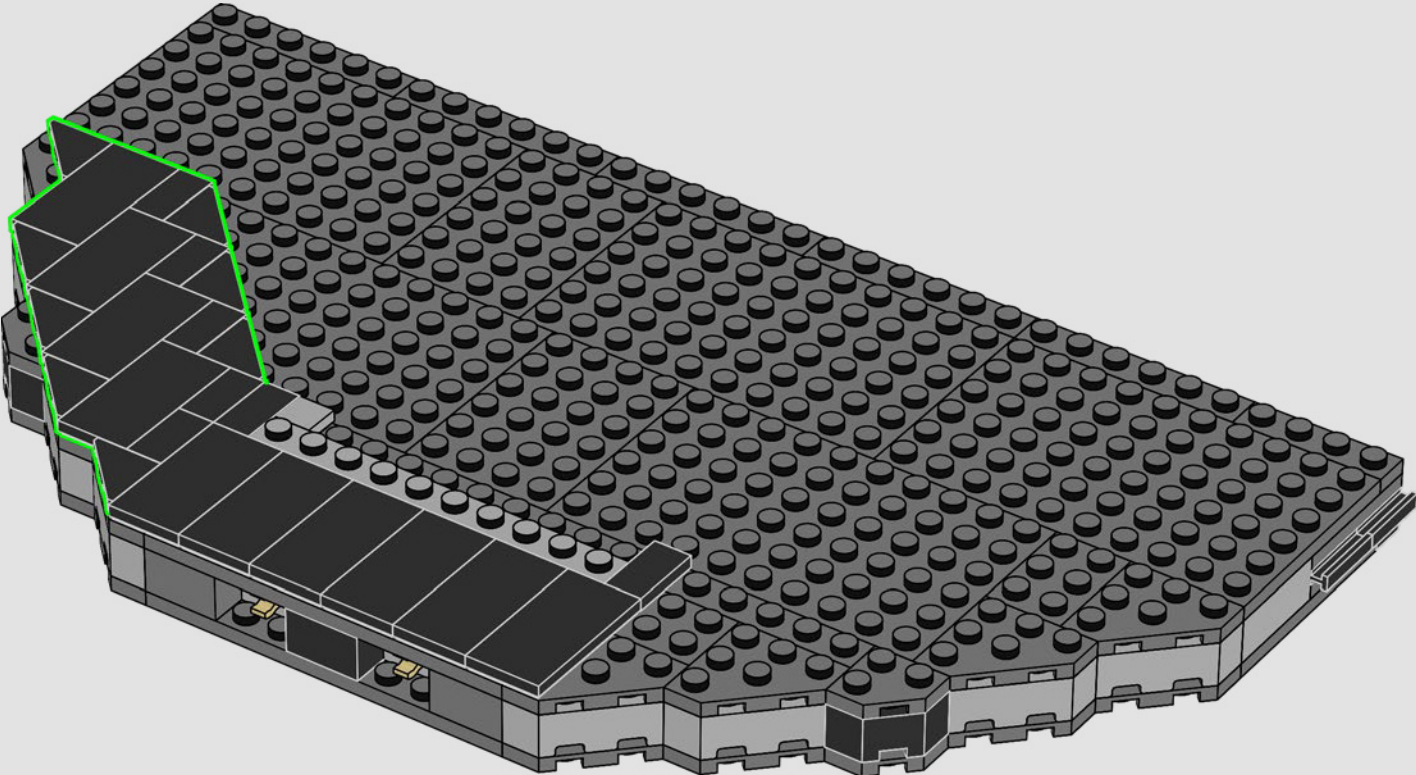

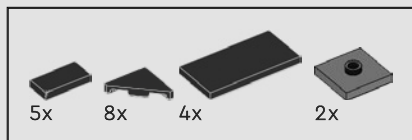

27

 模型的每层都可以取出，以便更轻松地查看内部并获得最佳的拼搭体验。

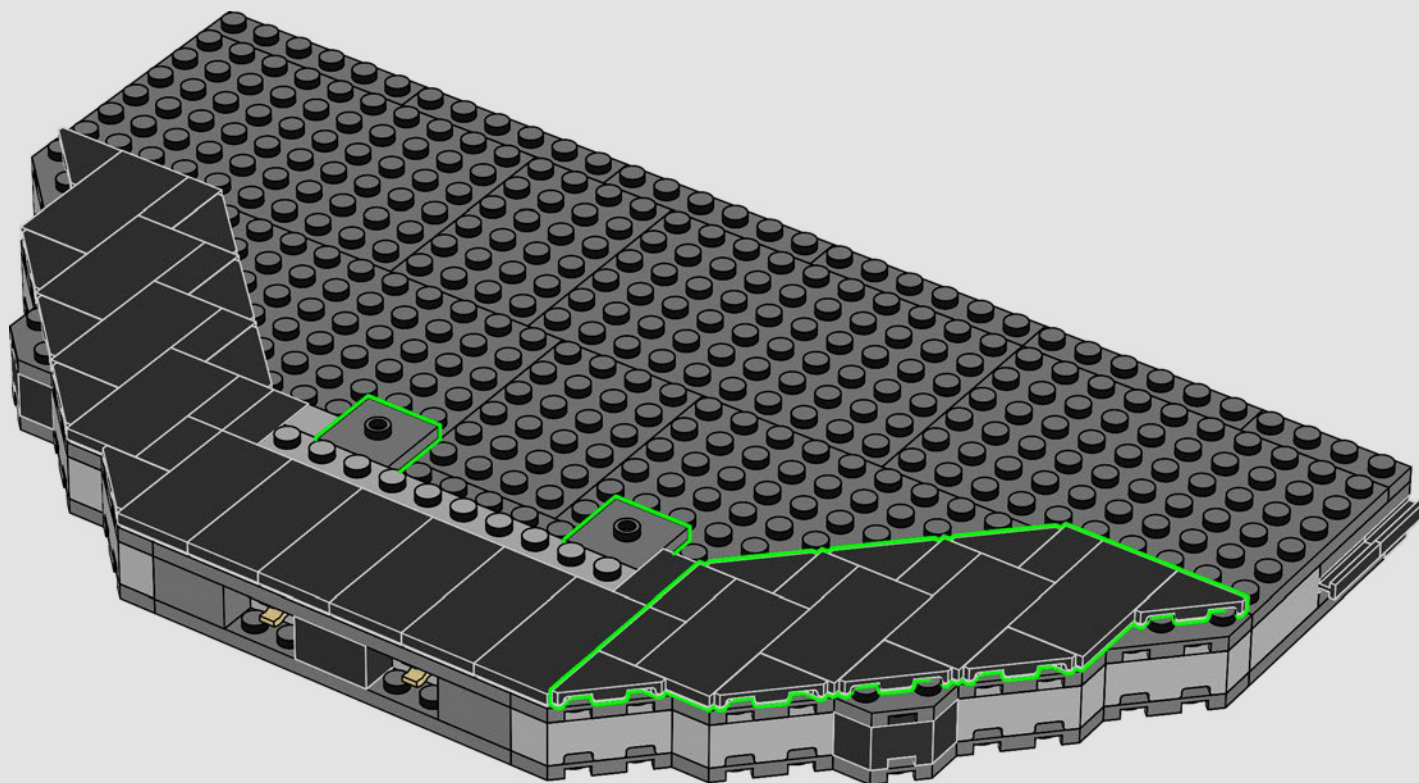

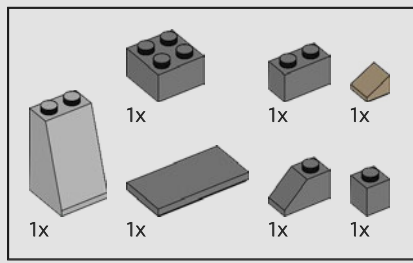

28

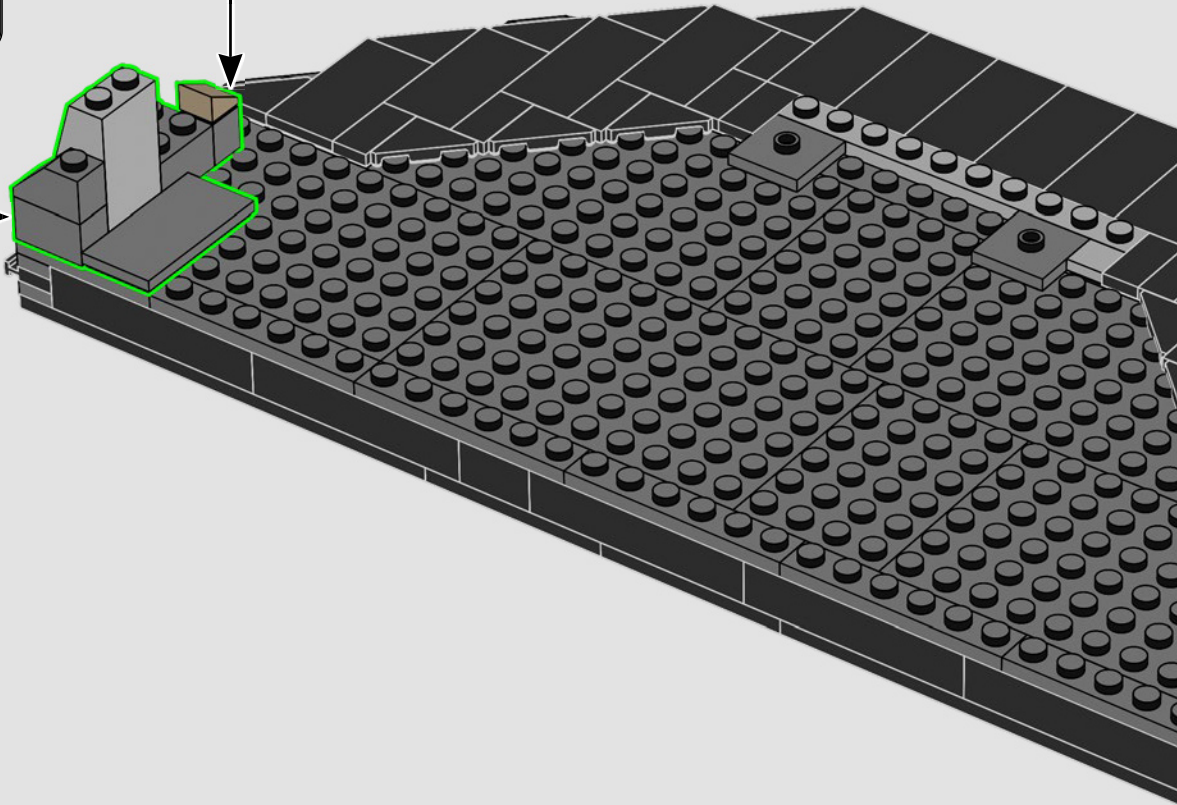
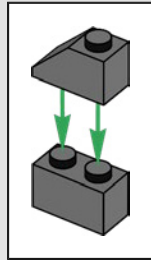
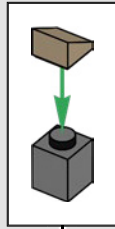

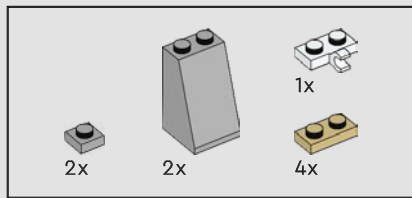

29

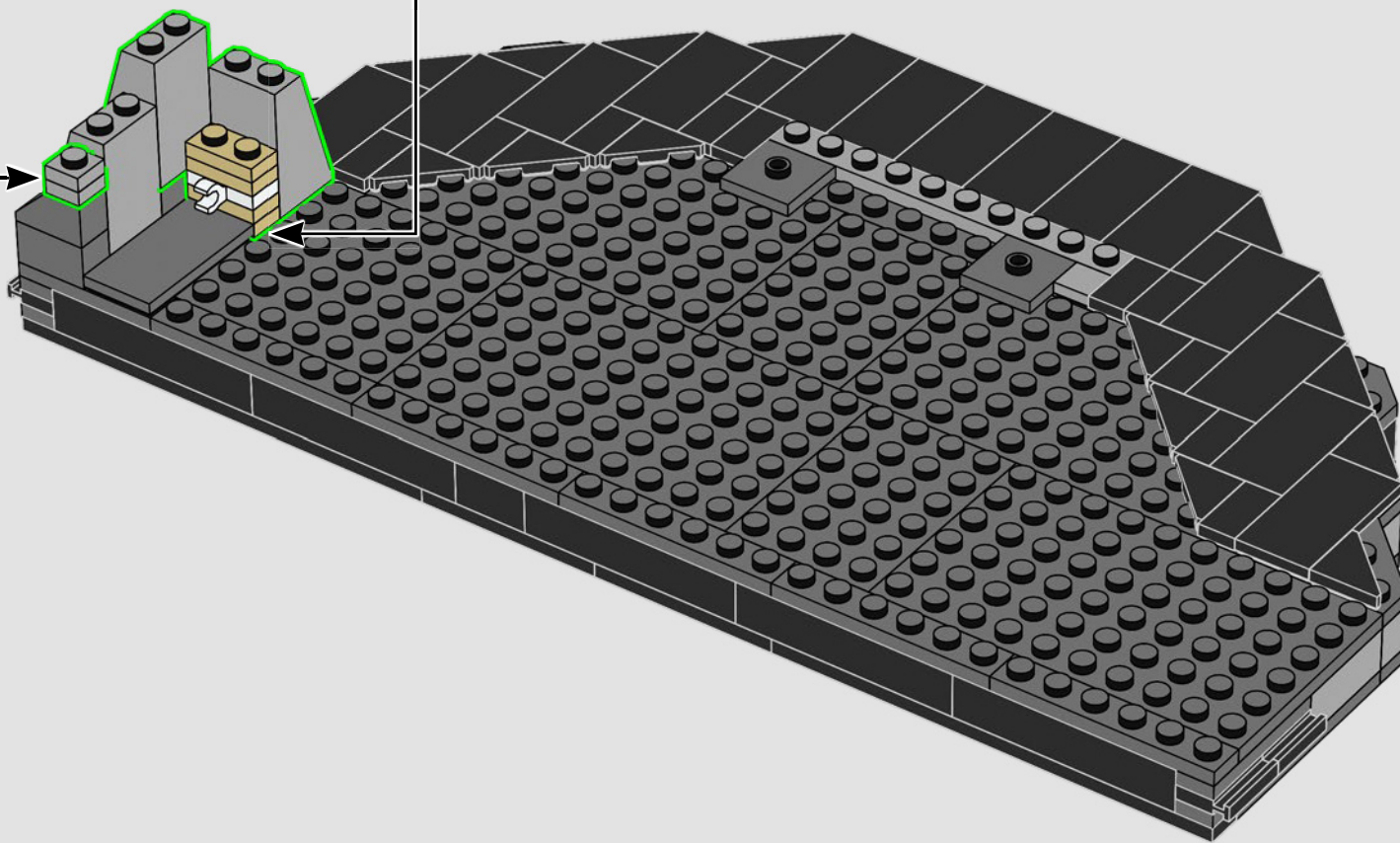
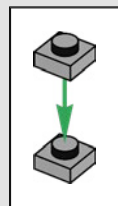
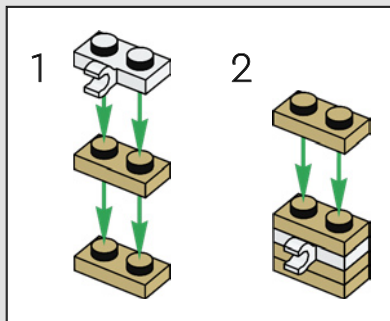

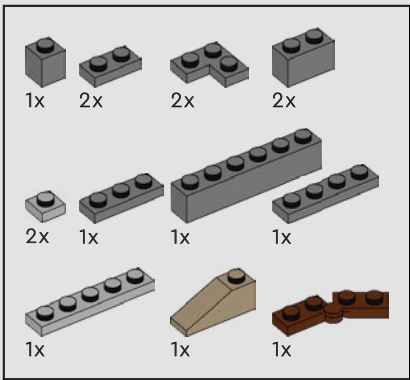

30

1

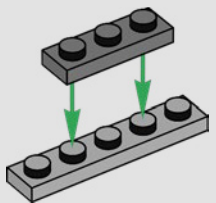

2

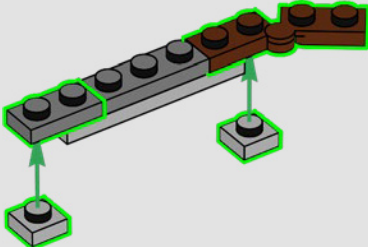

3

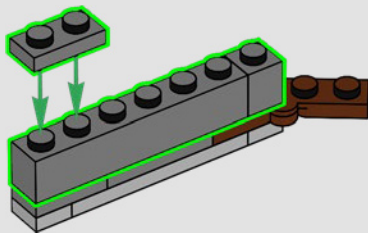

4

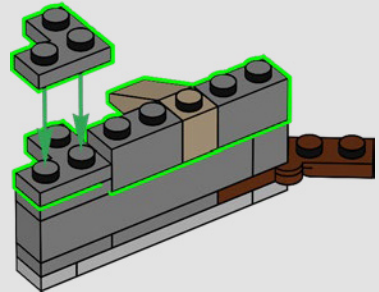

5

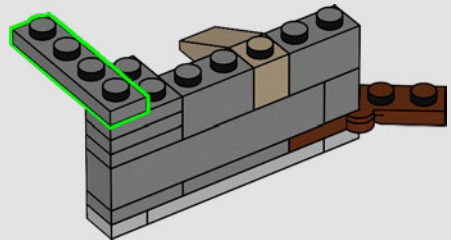

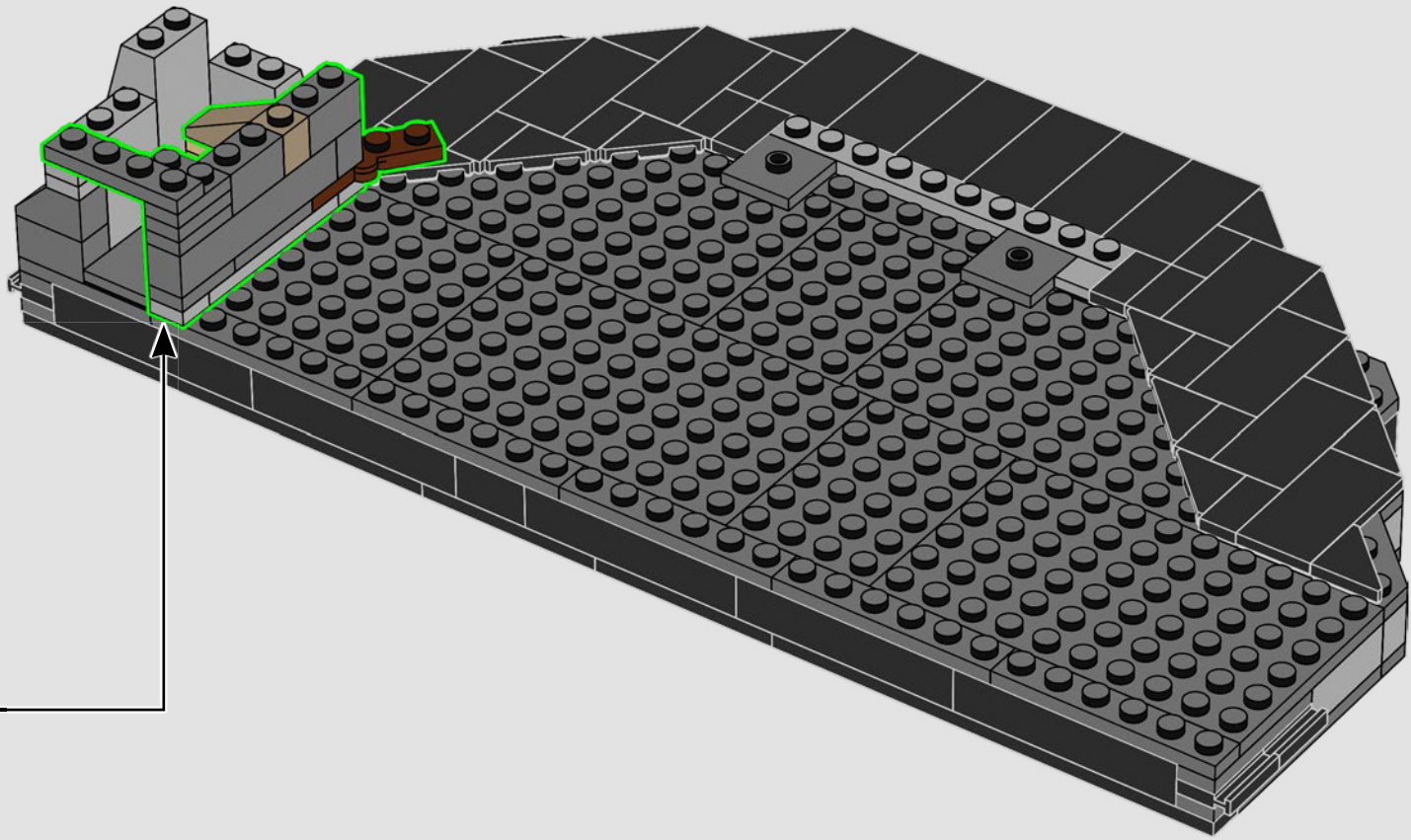

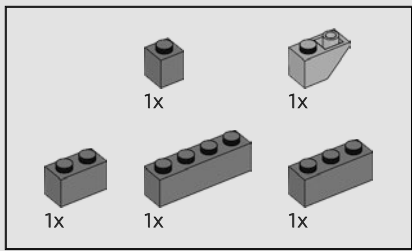

31

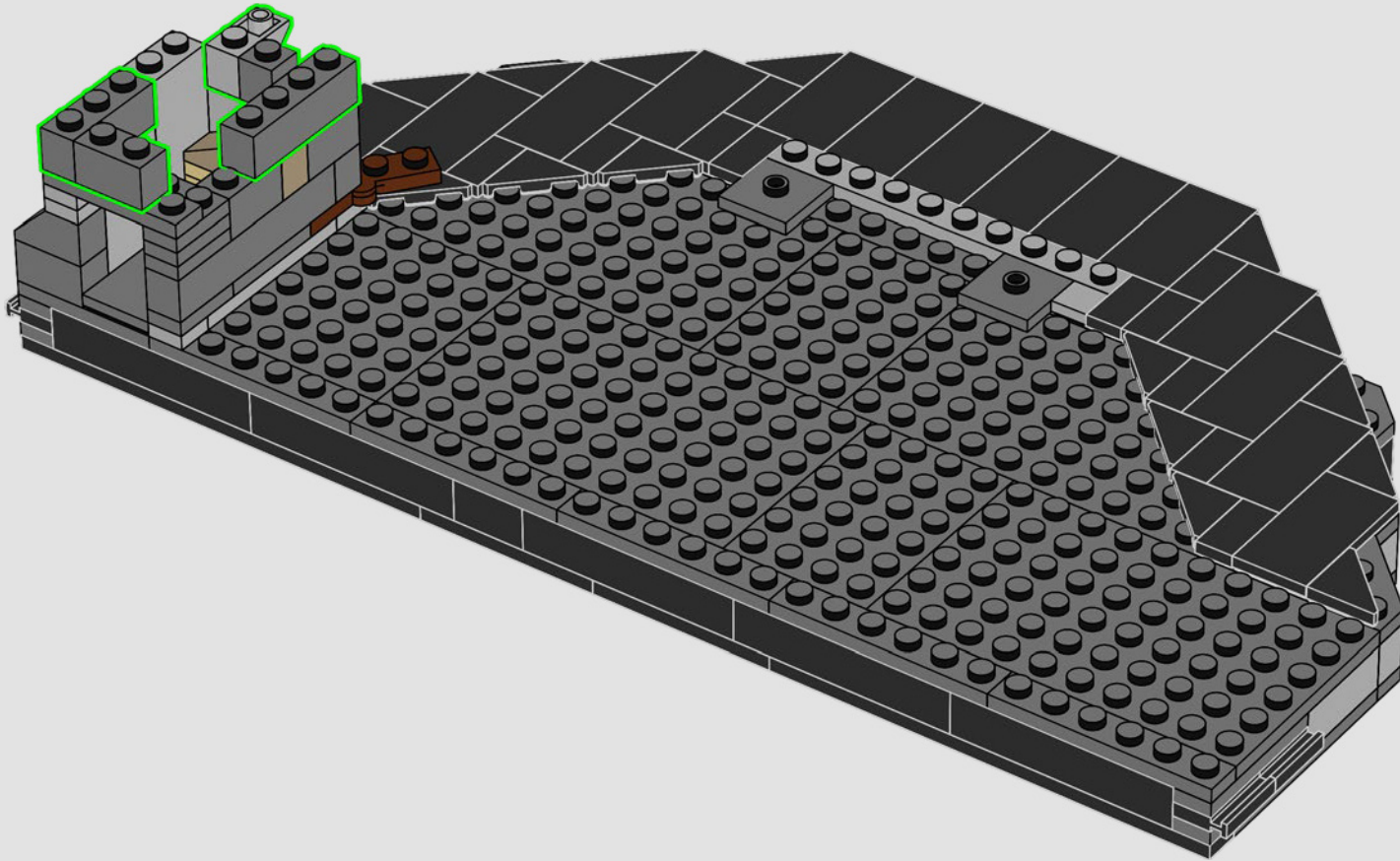

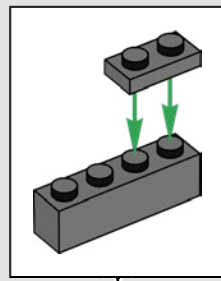
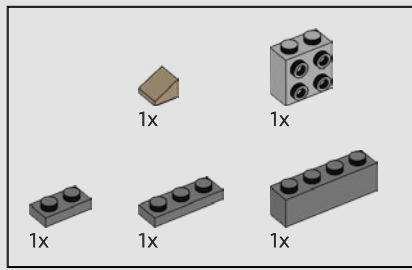

32

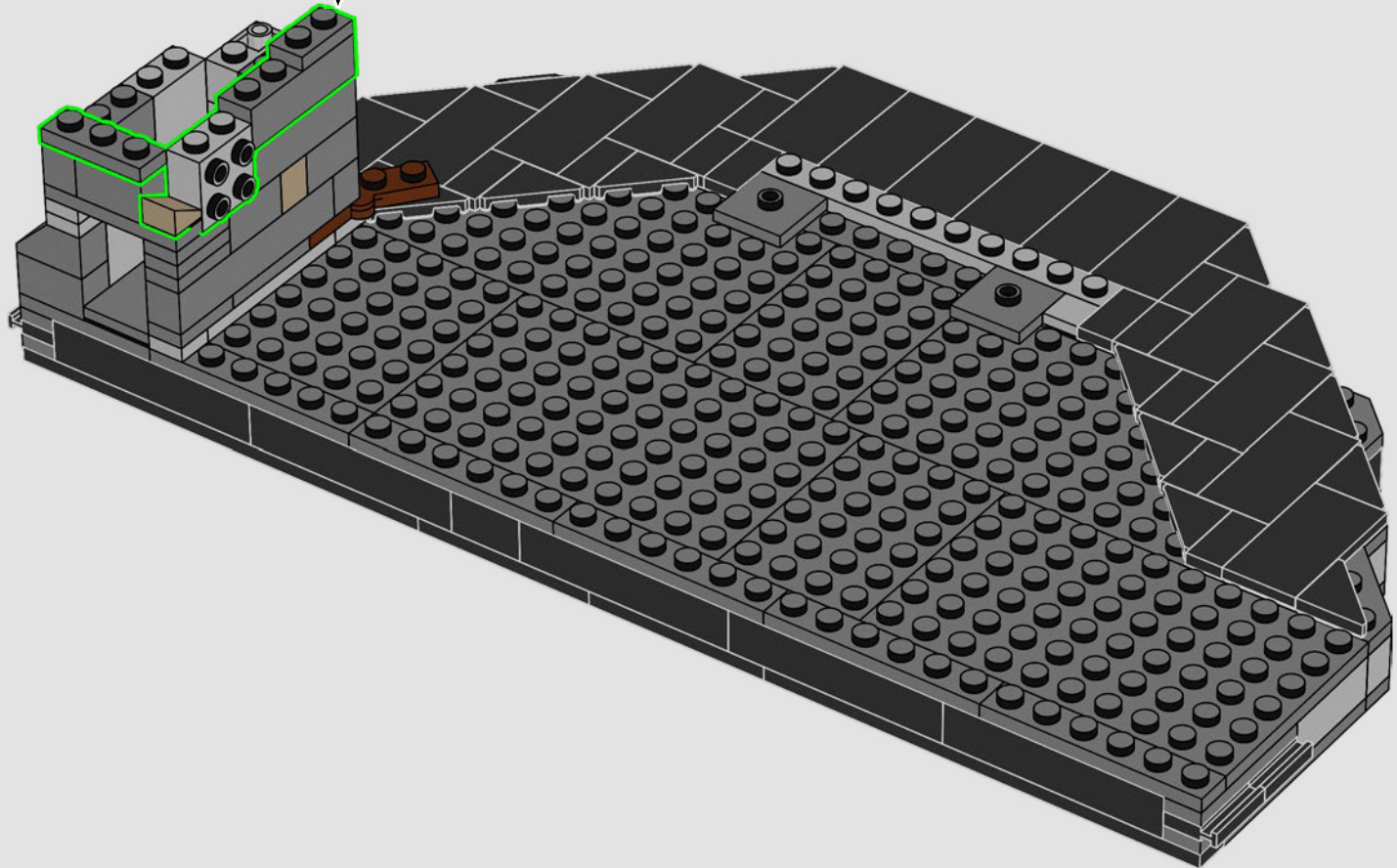

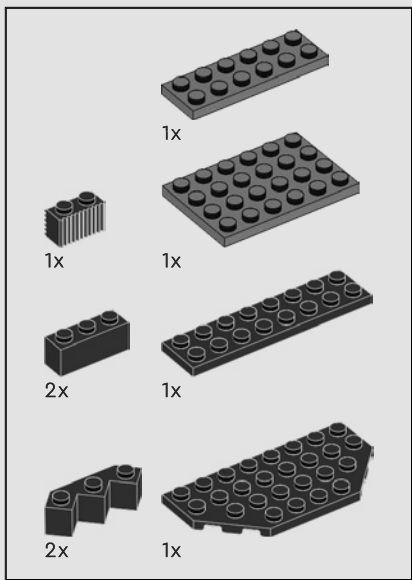

33

1

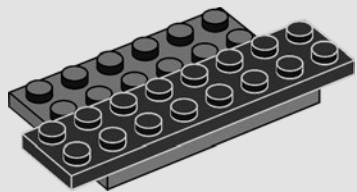

2

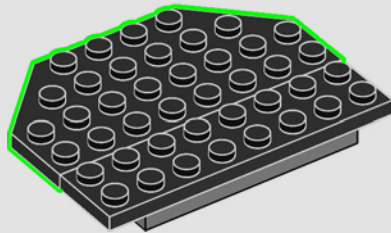

3

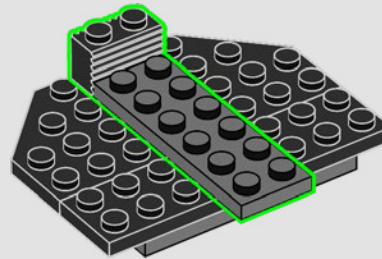

4

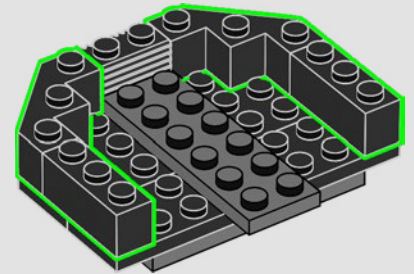

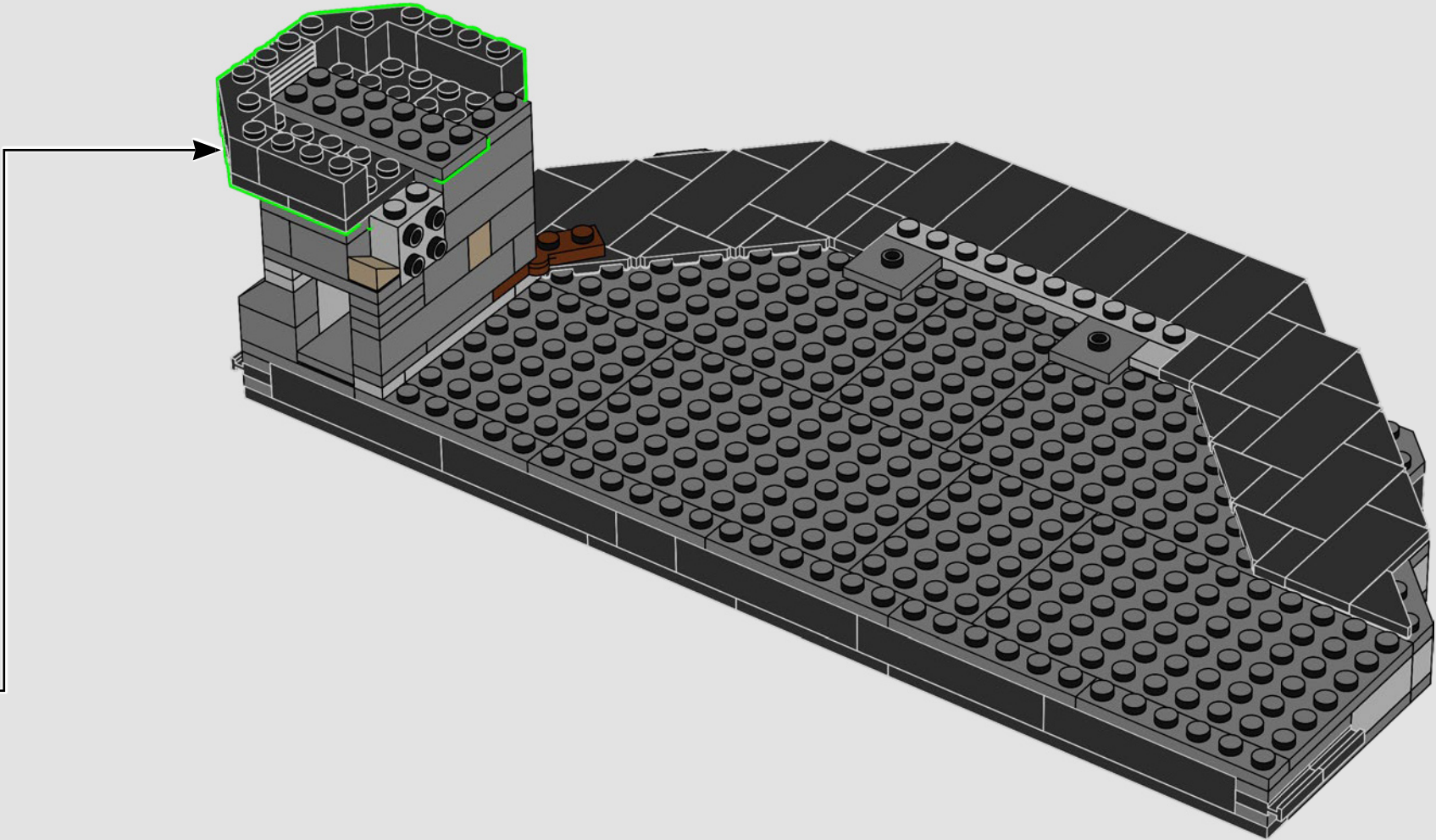

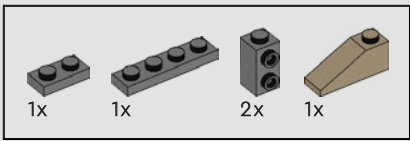

34

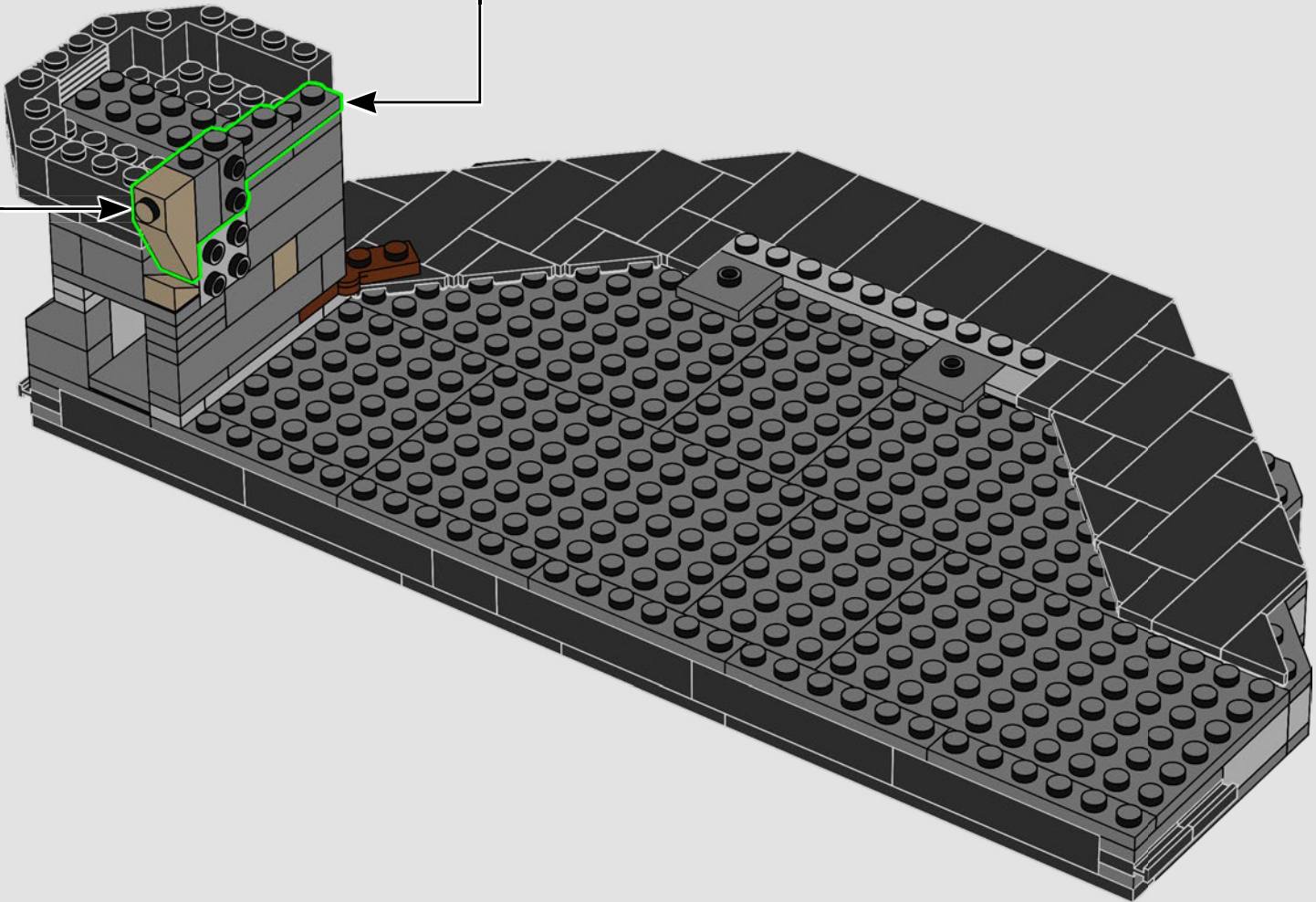
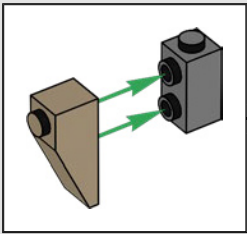
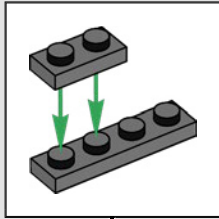

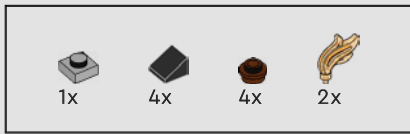

35

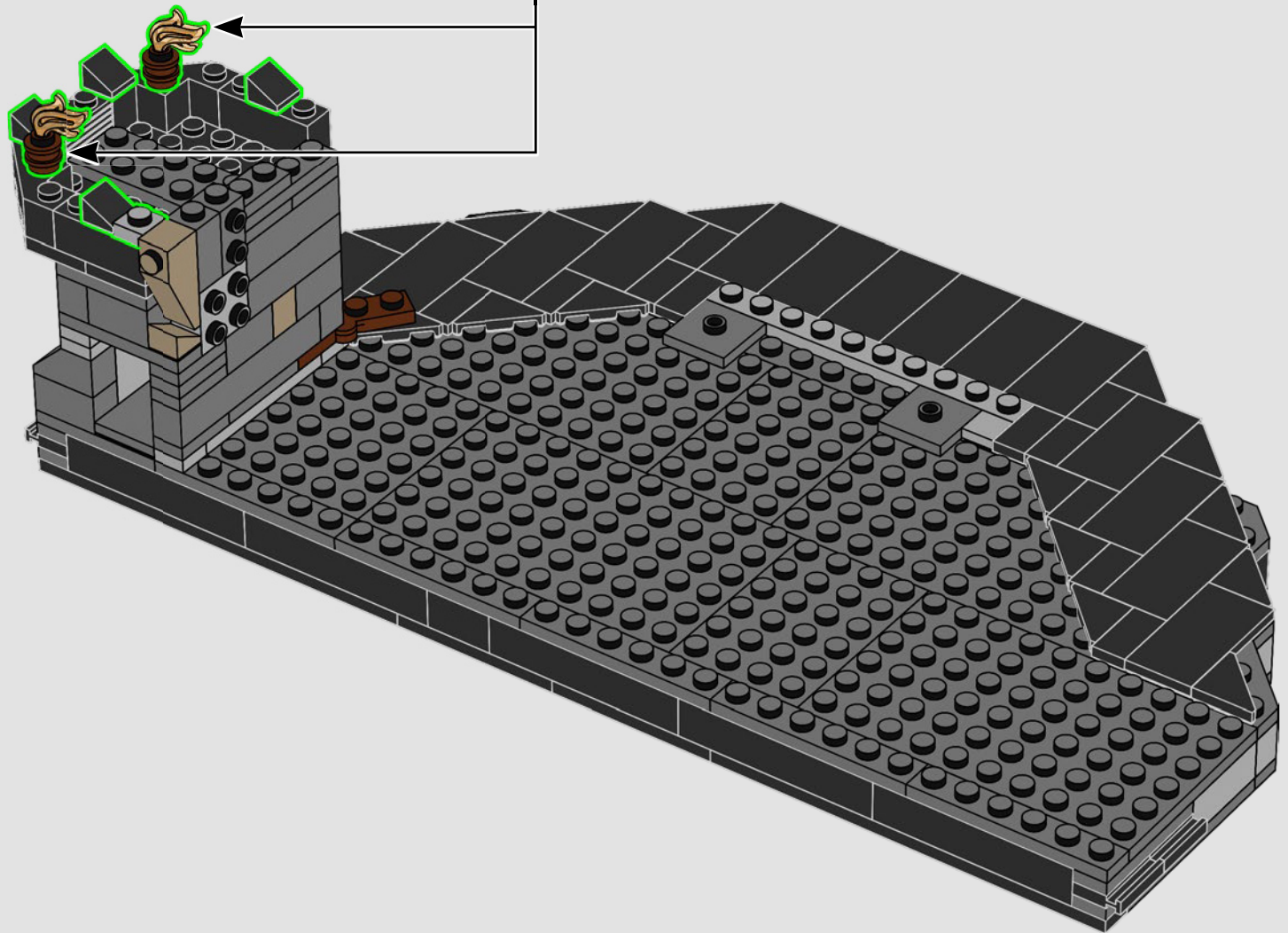
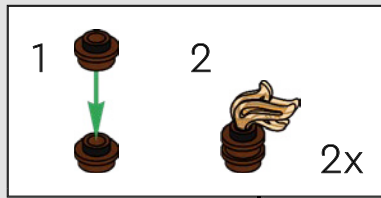

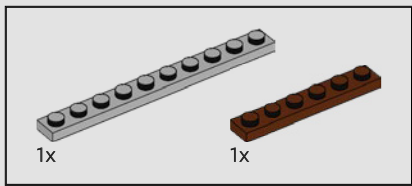

36

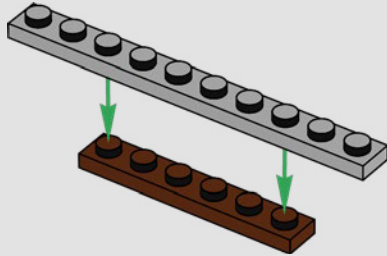

37

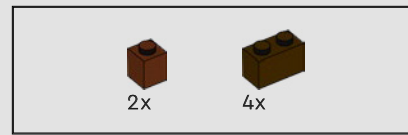
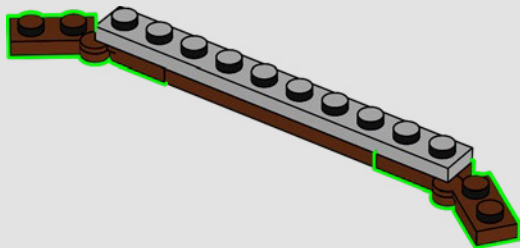

38

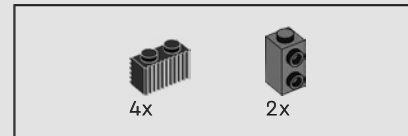
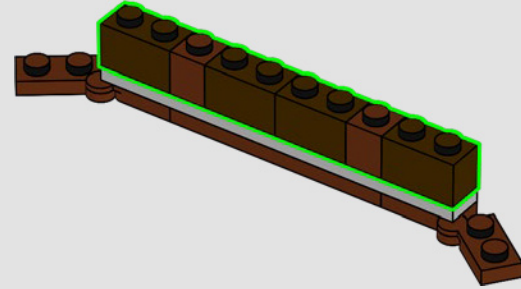

39

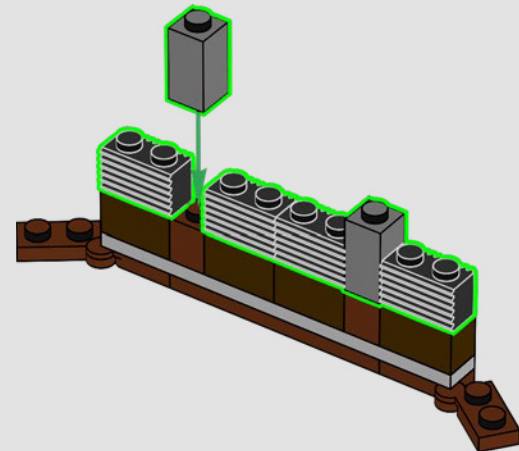

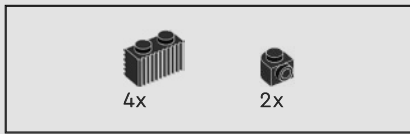

40

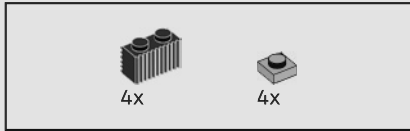
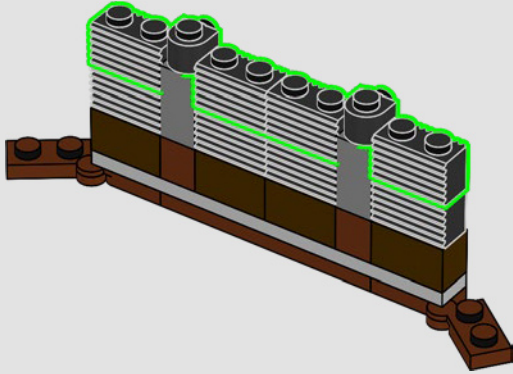

41

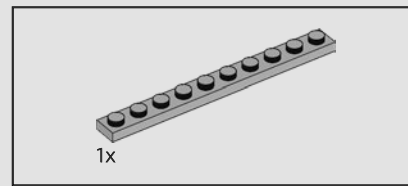
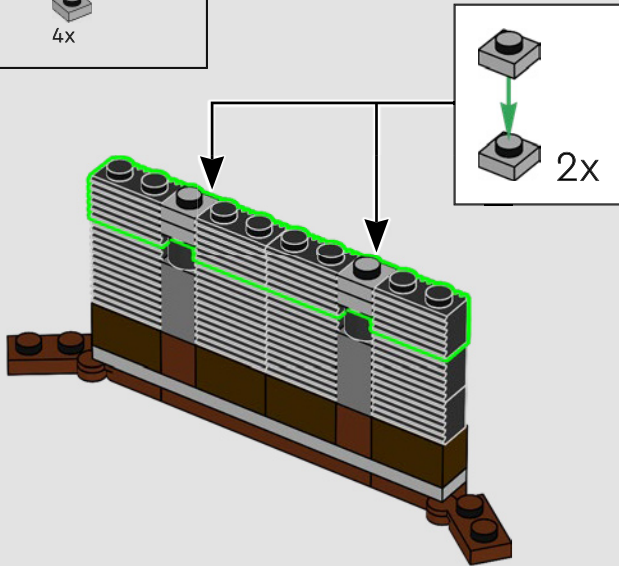

42

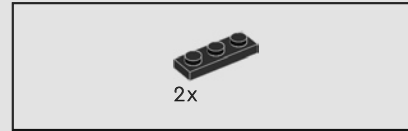
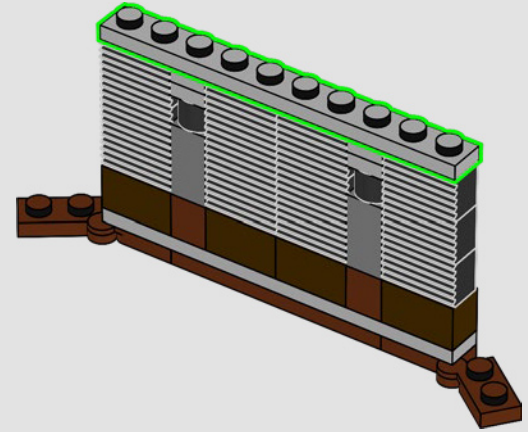

43

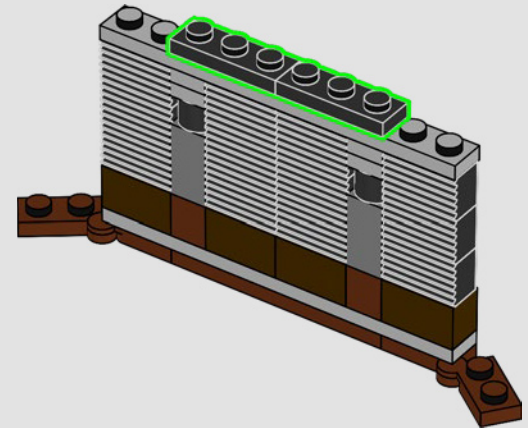

44

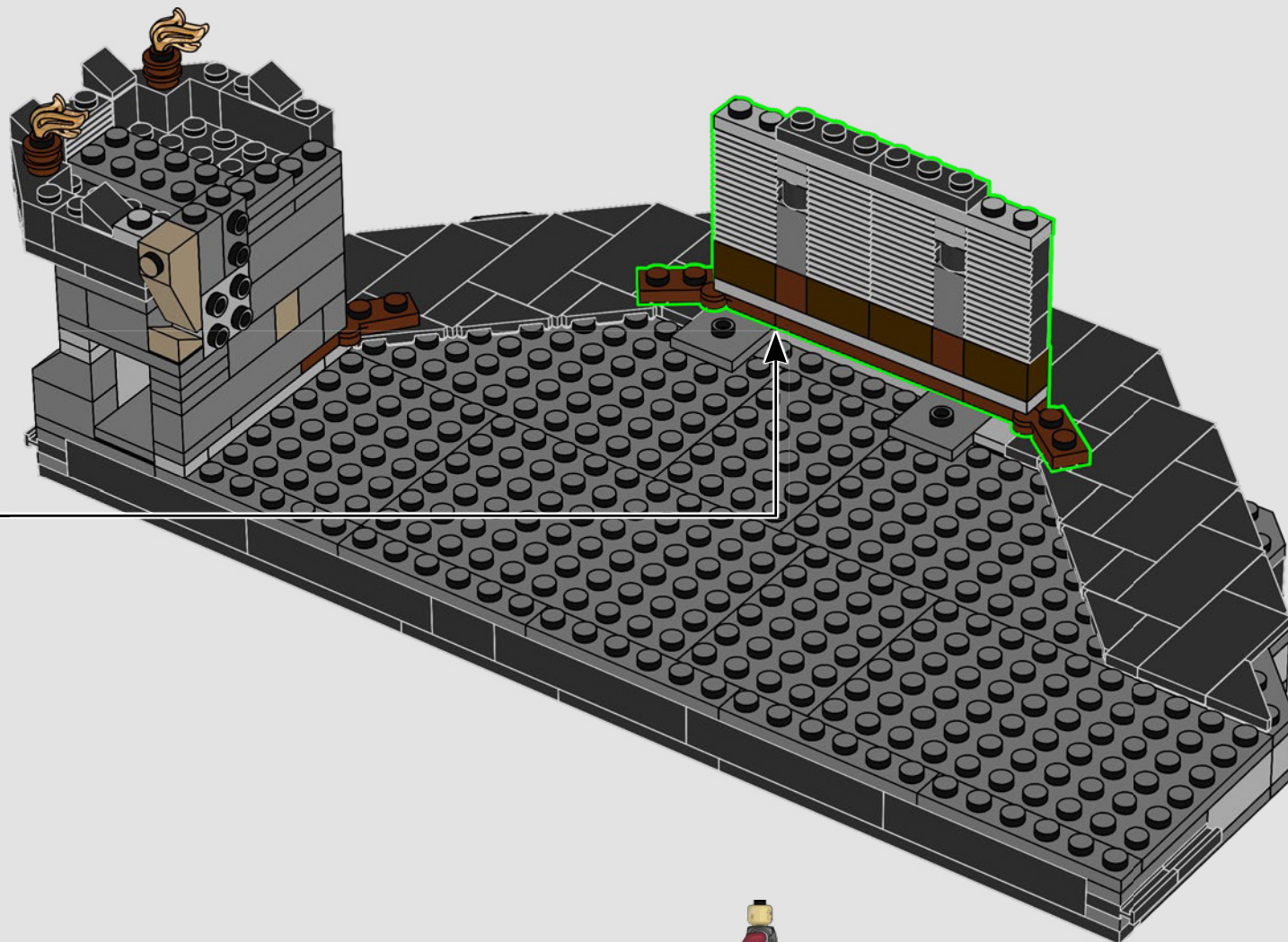

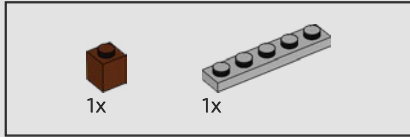
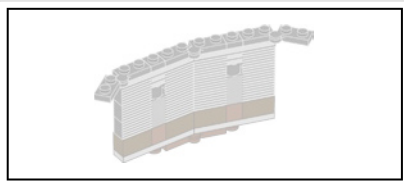

45

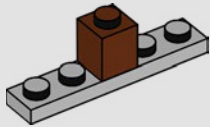

46

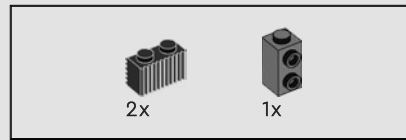
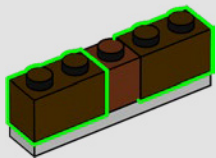

47

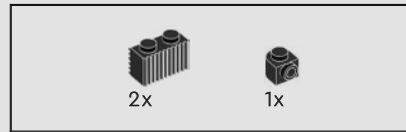
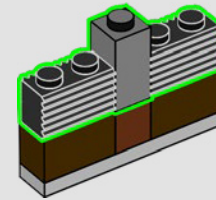

48

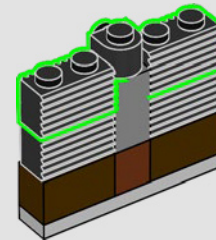

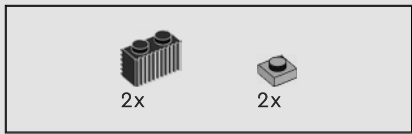

49

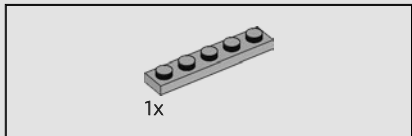
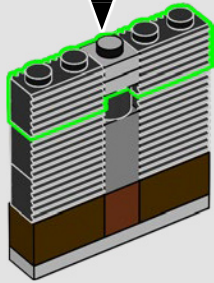
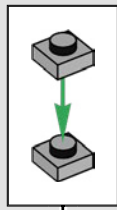

50

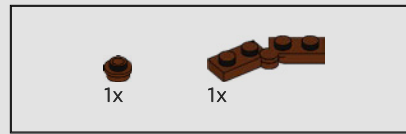
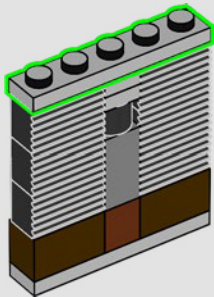

51

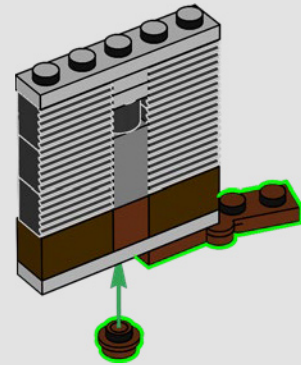

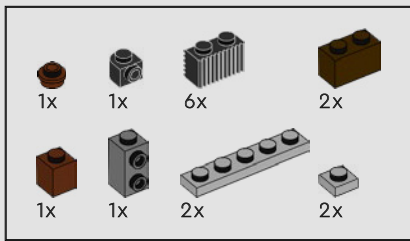

52

1

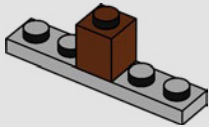

2

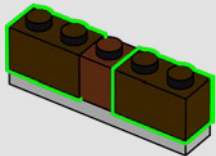

3

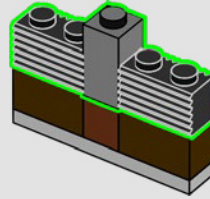

4

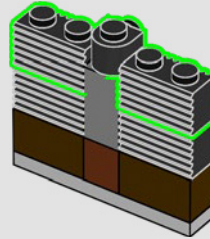

5

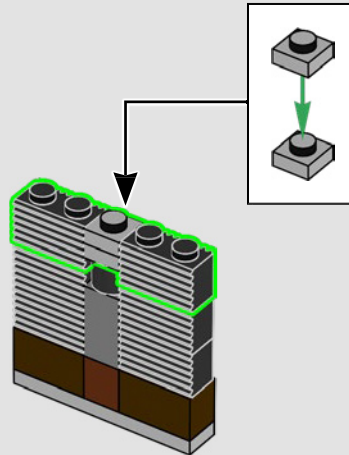

6

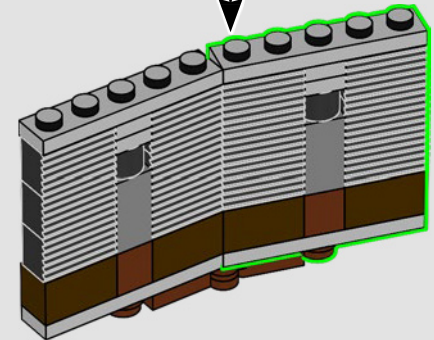
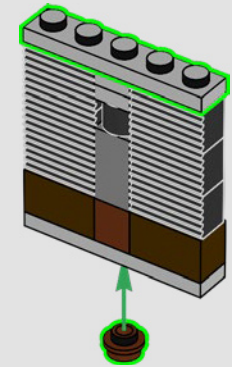



53

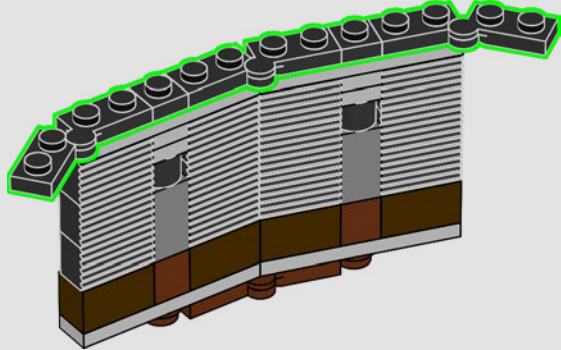

54

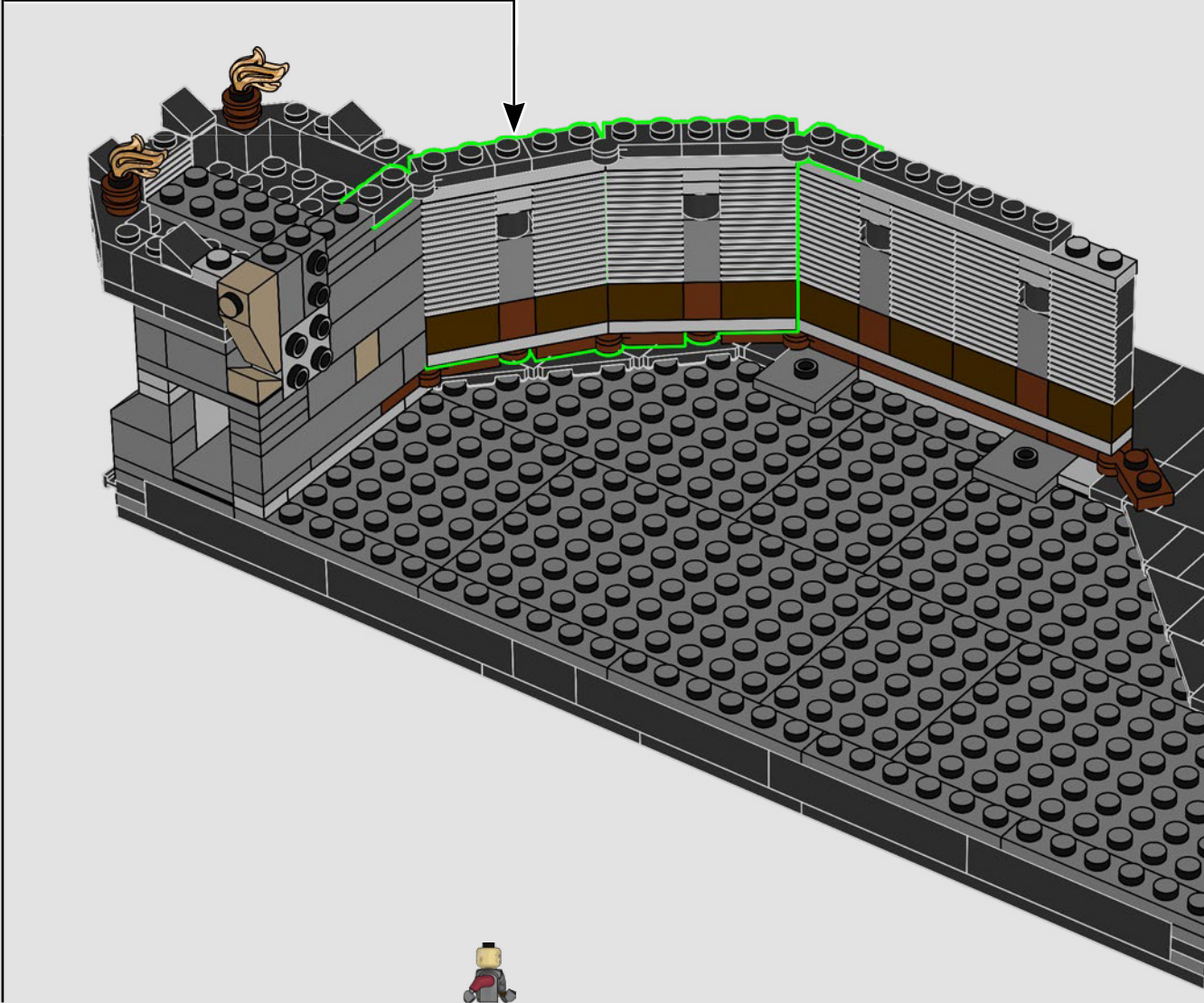

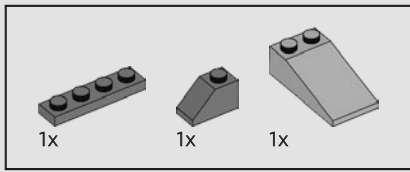

55

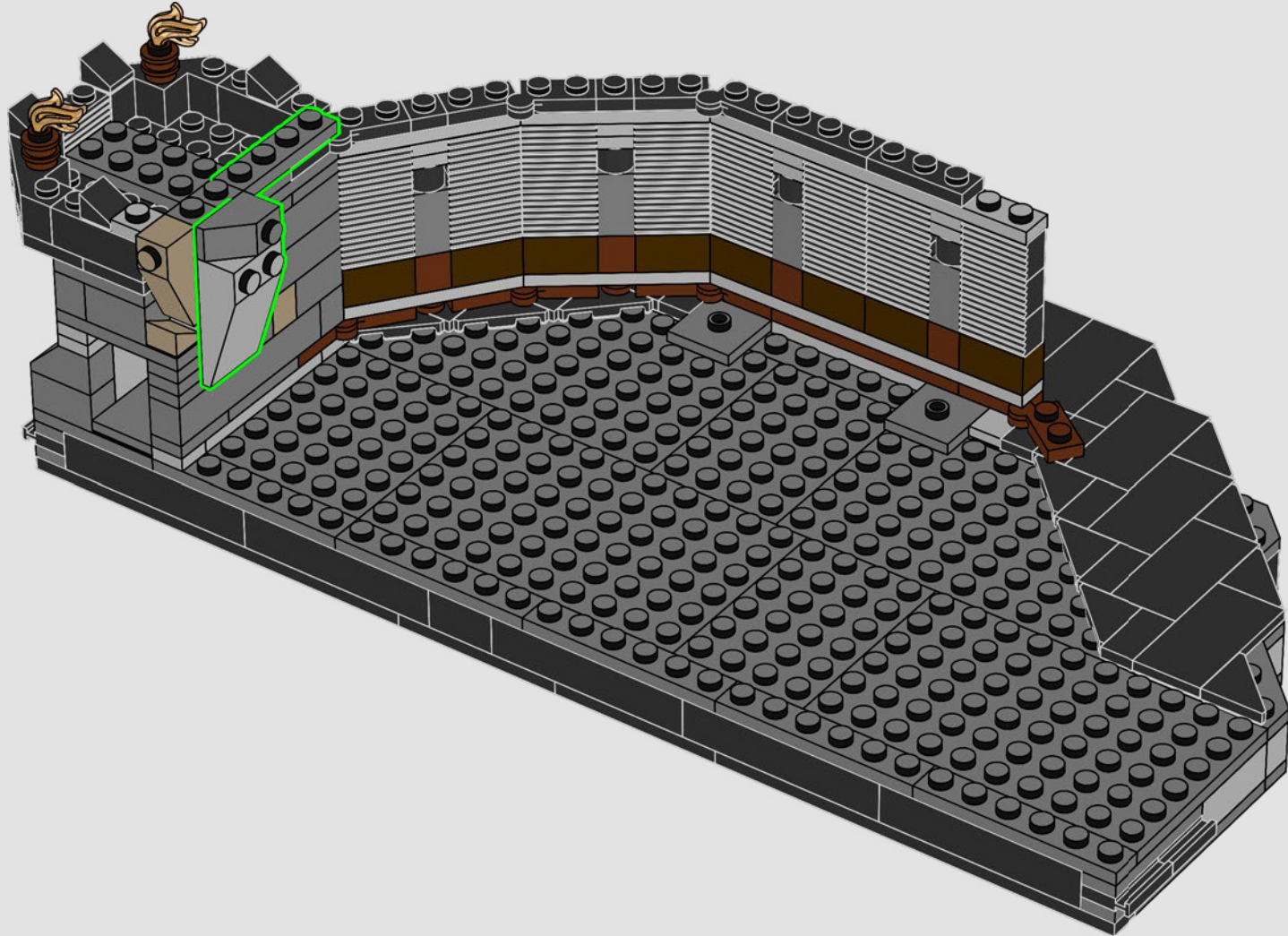

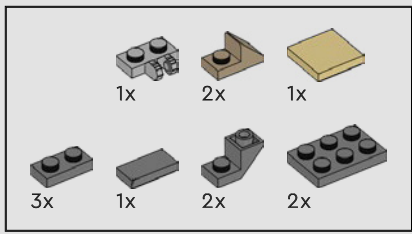

56

1

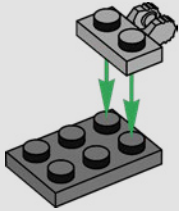

2

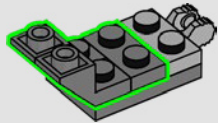

3

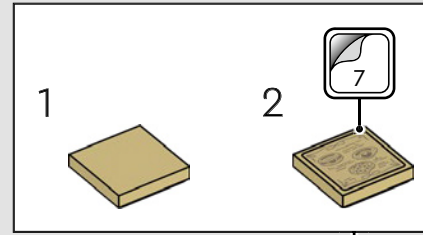
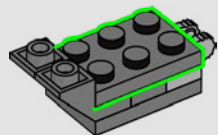

4

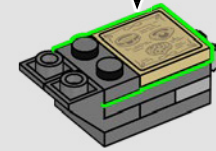

5

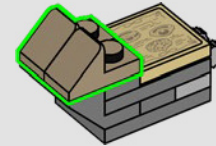

6

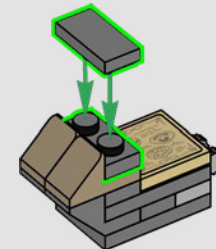



岩石中的隐秘角落里隐藏着送给精灵的三枚戒指的设计。

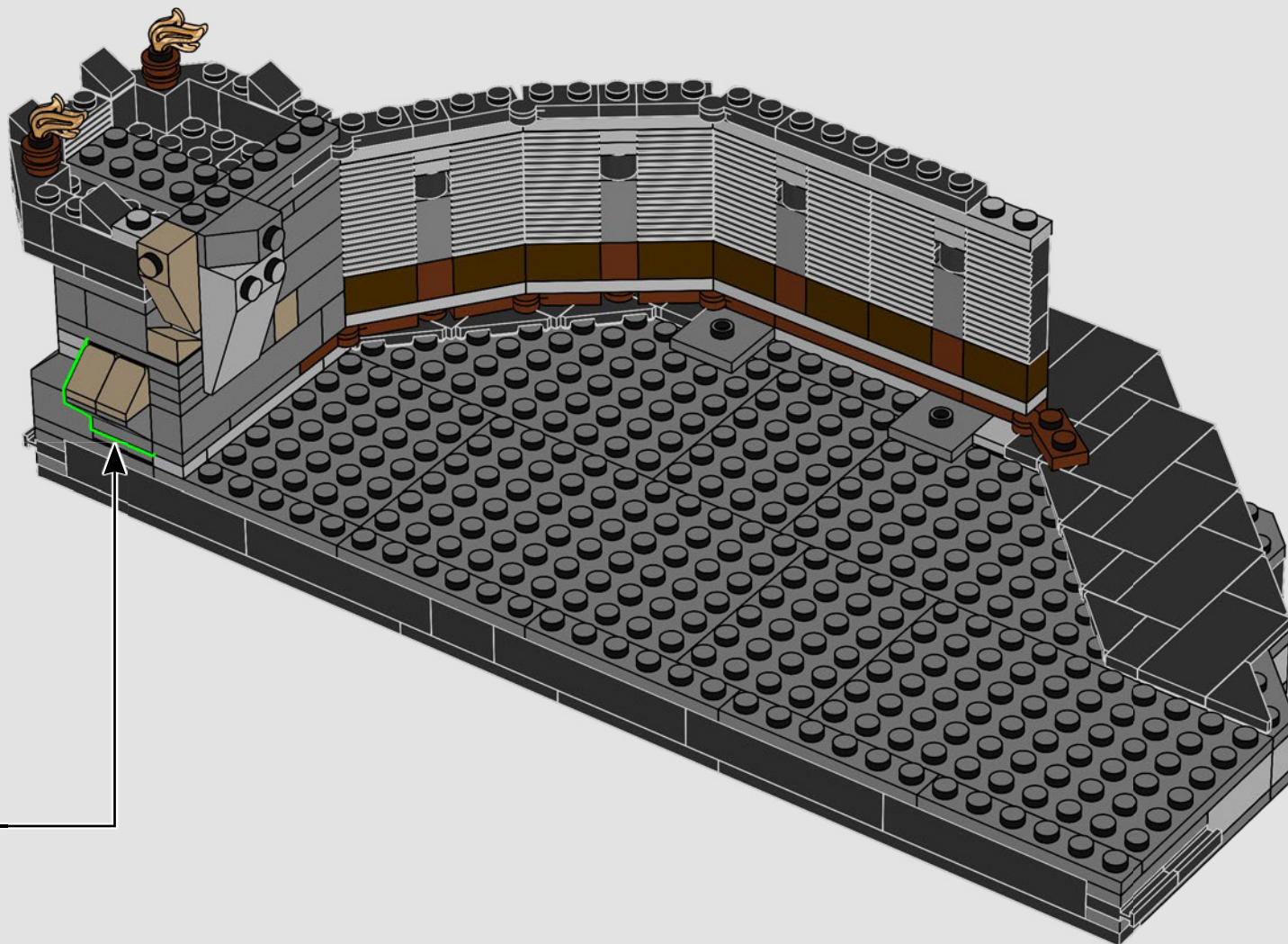



勾斯魔格是魔王的第一副手，因领导了对奥斯吉力亚斯的进攻以及紧随其后的米那斯提力斯围攻，而声名显赫。



1



2



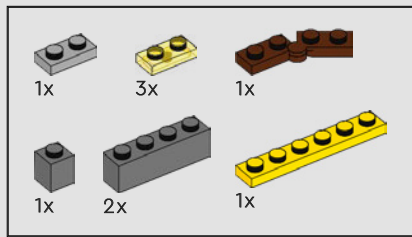

57

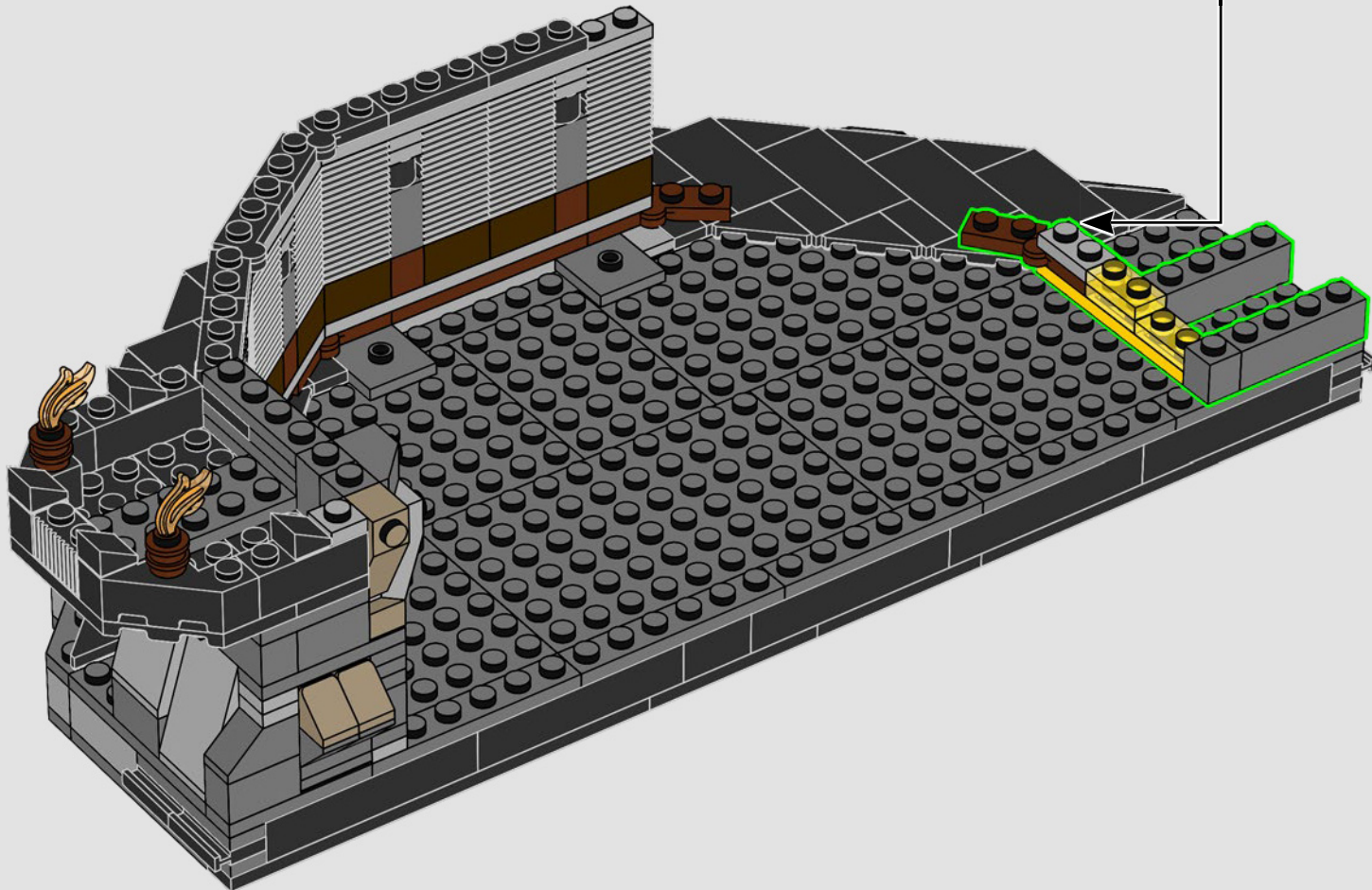
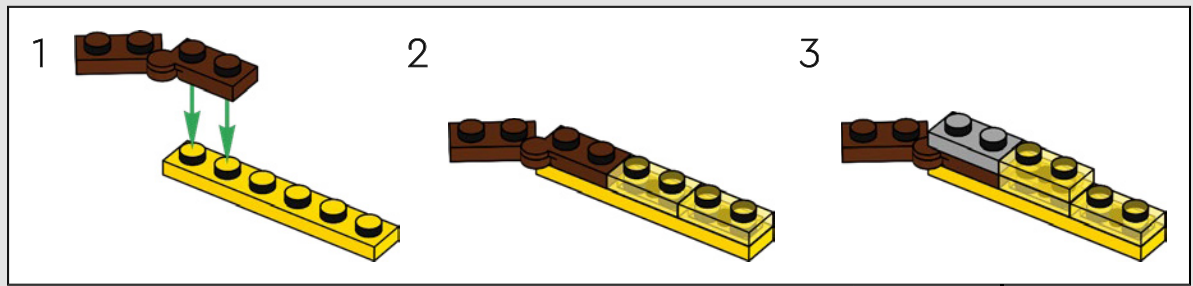

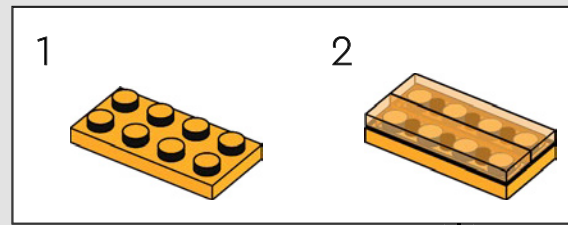
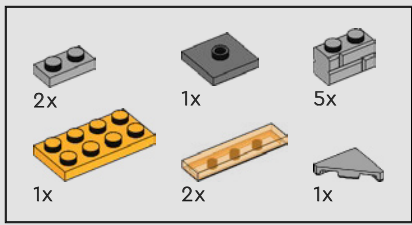

58

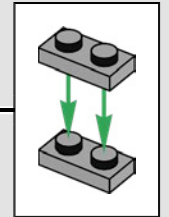
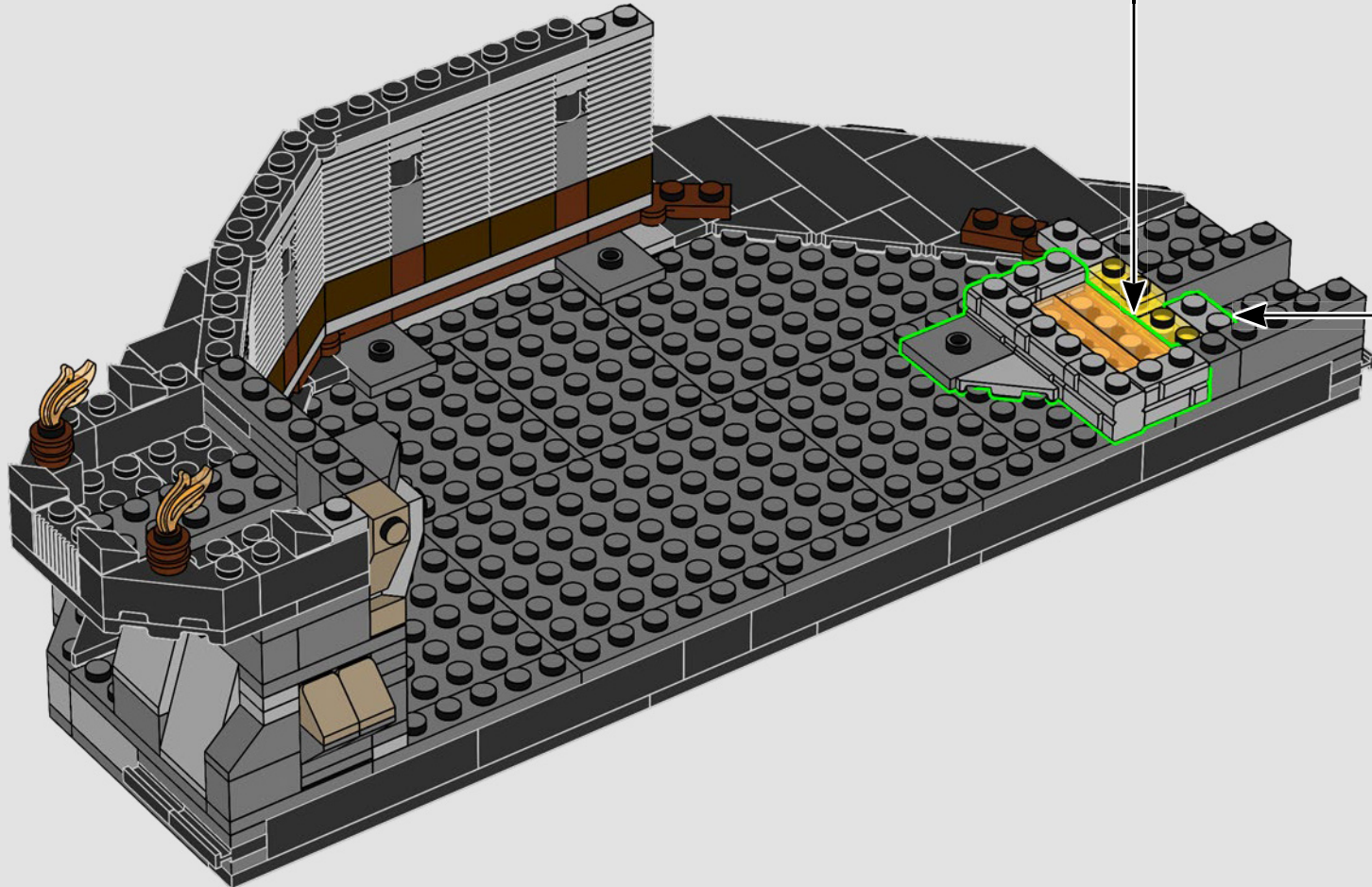

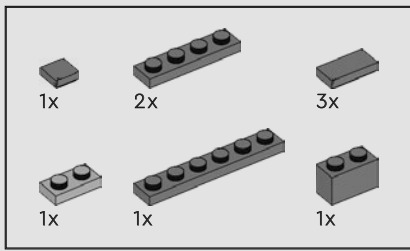

59

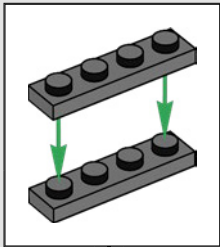
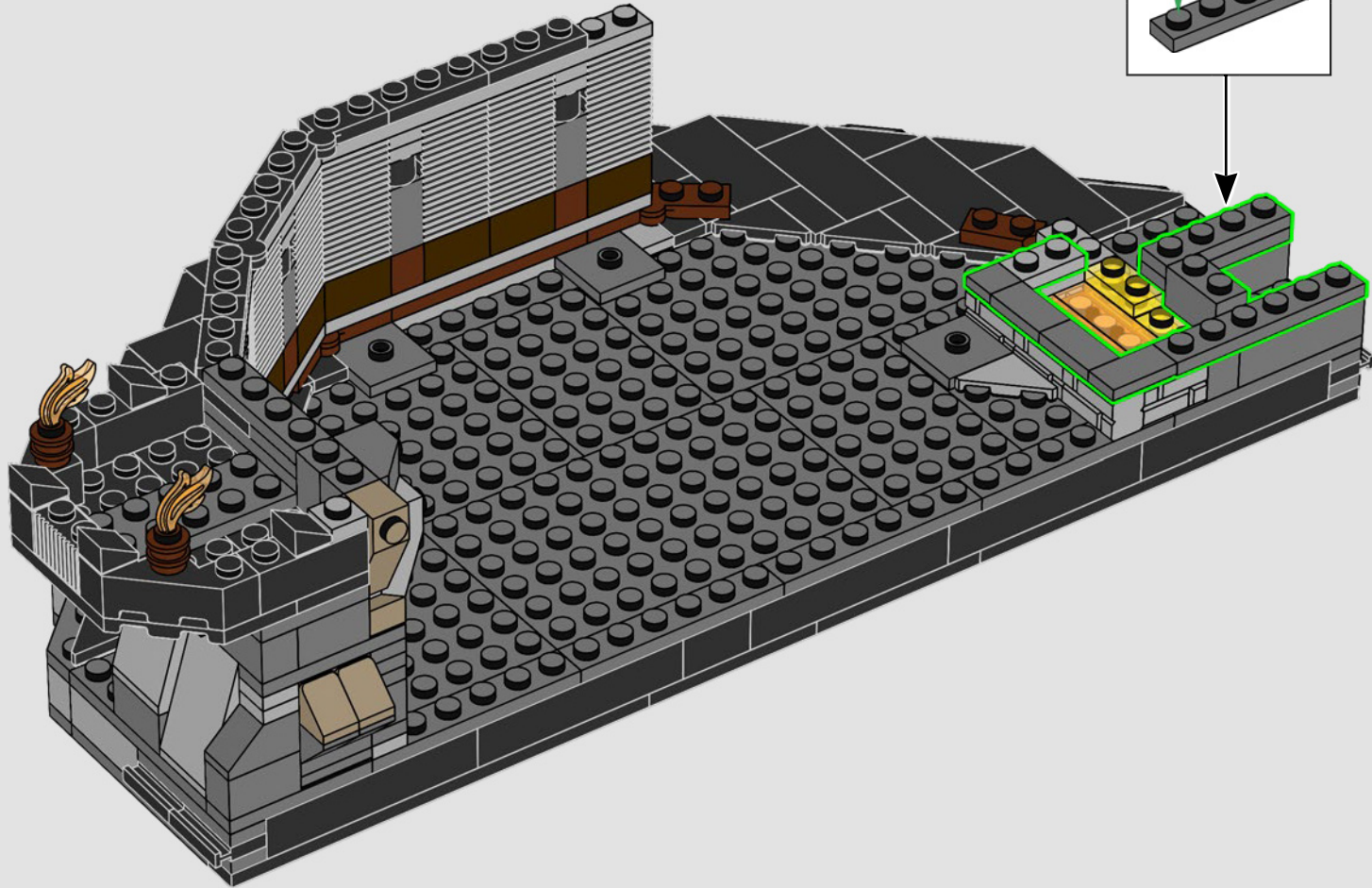

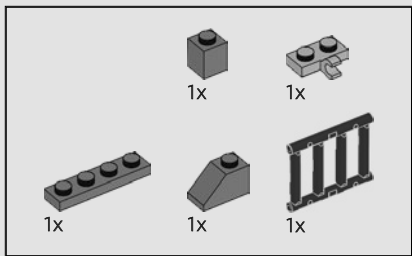

60

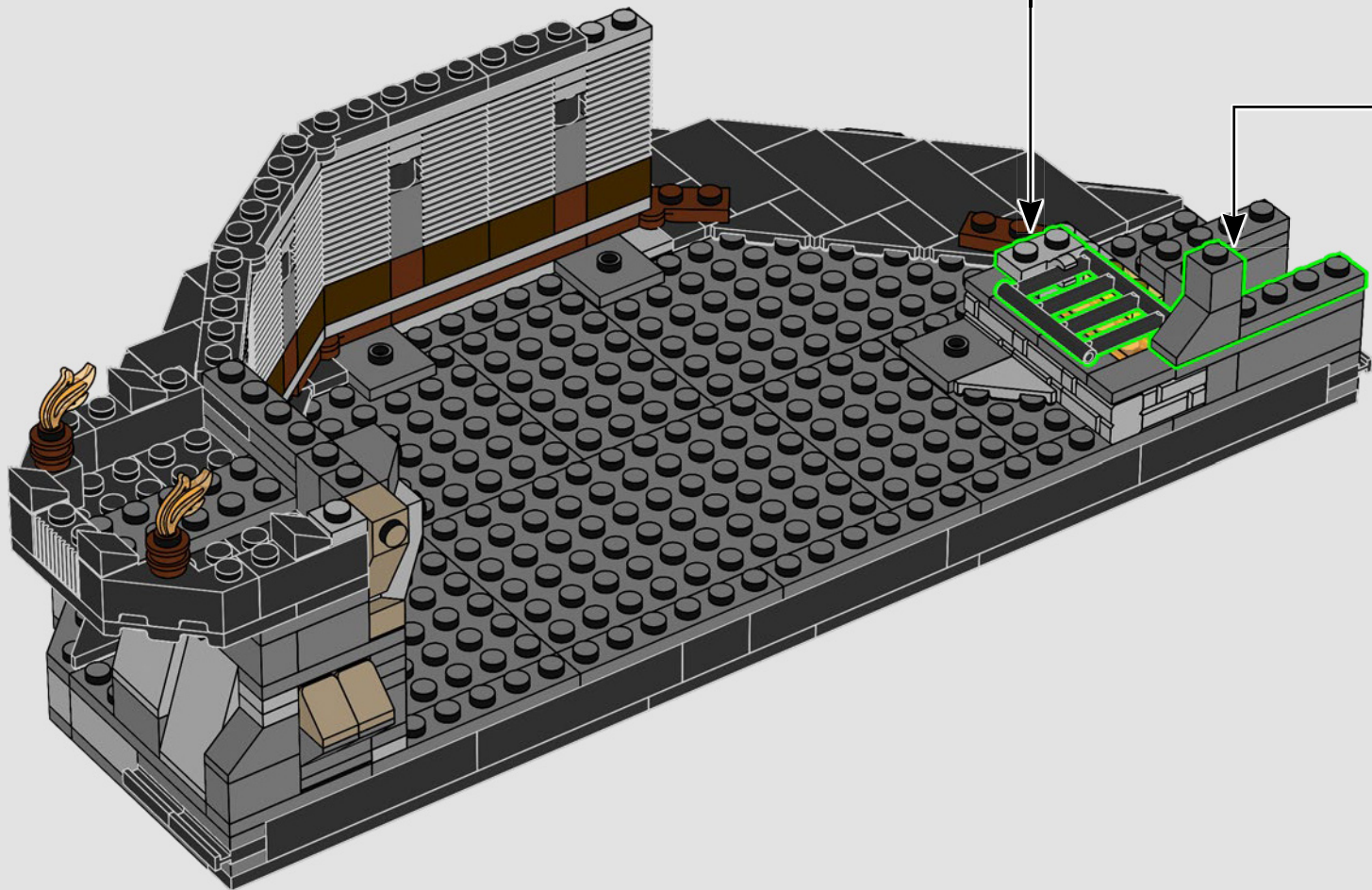
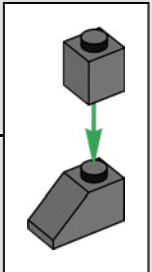
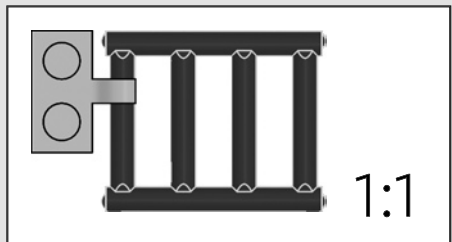

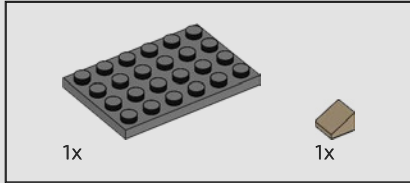
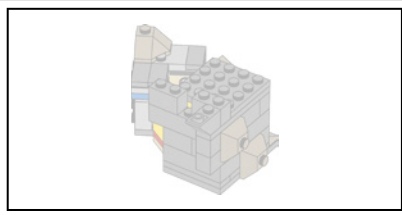

61

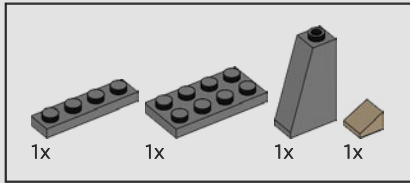
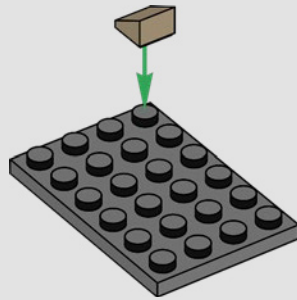

62

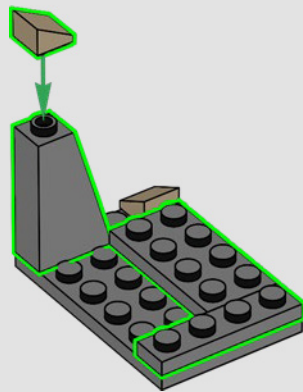

63

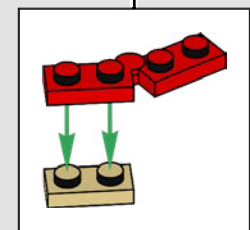
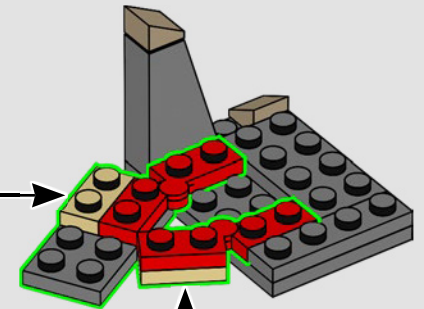
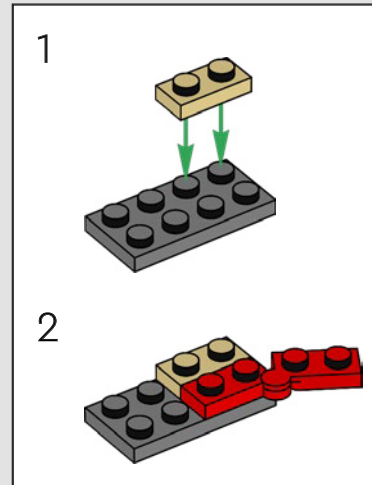

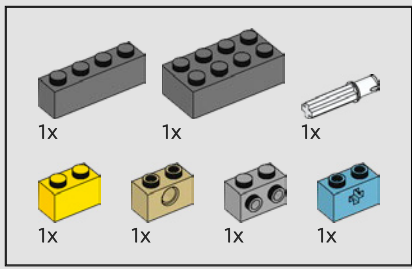

64

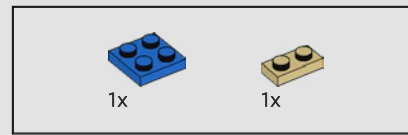
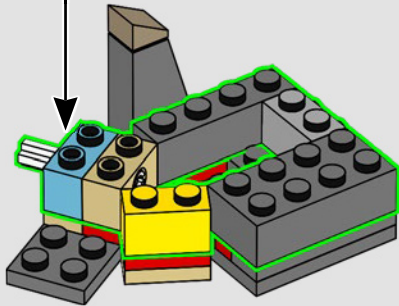
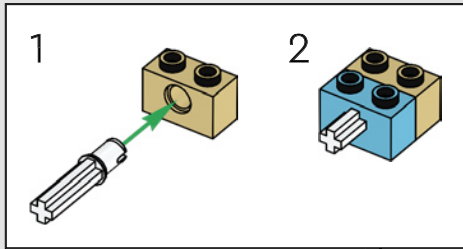

65

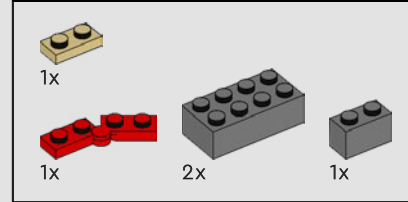
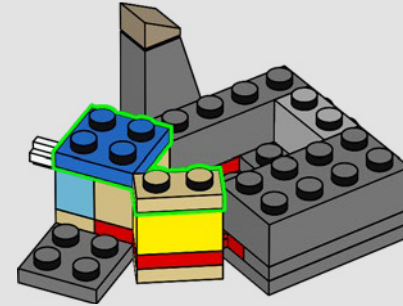

66

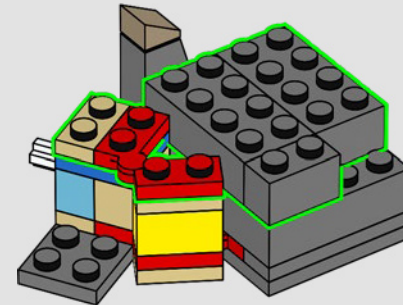

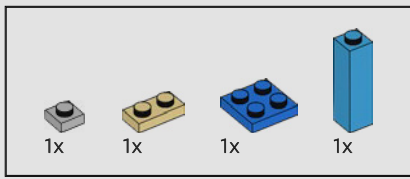

67

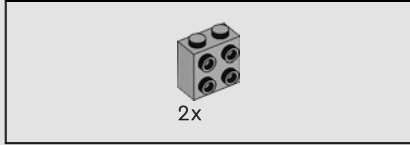
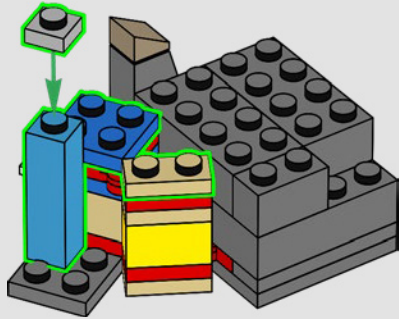

68

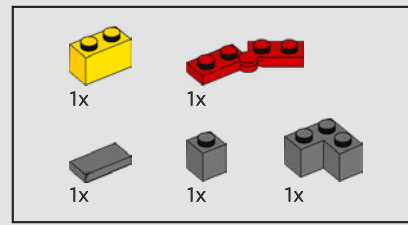
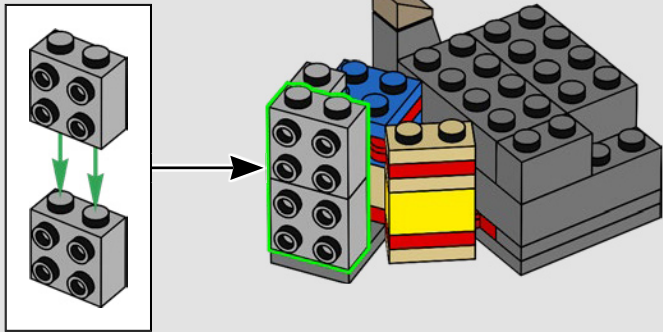

69

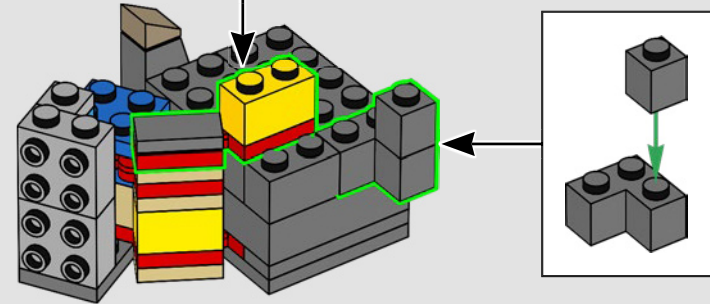
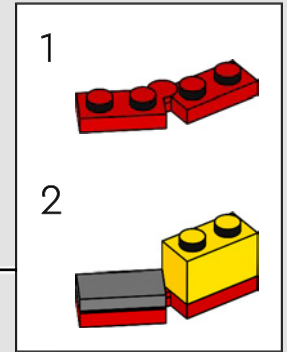

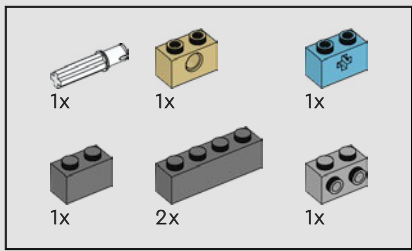

70

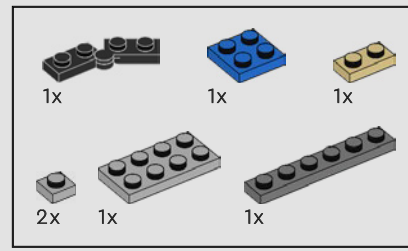
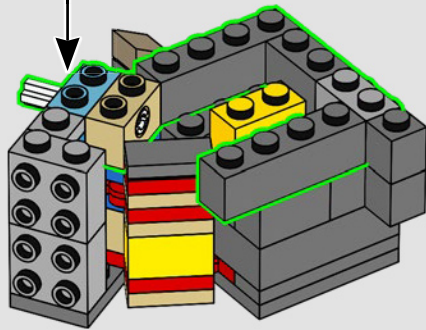
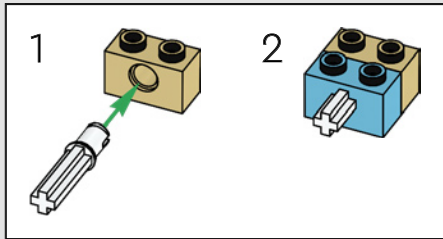

71

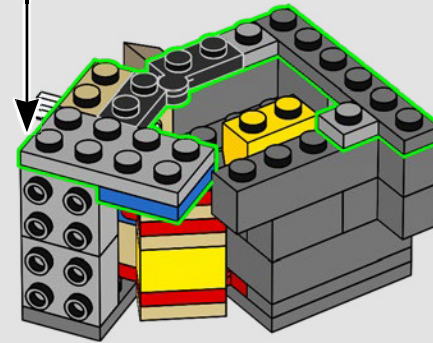
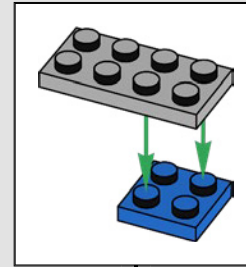

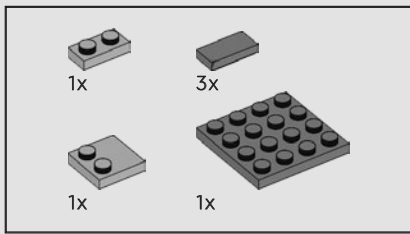

72

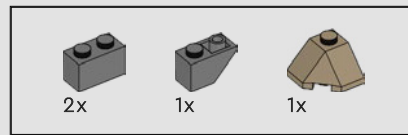
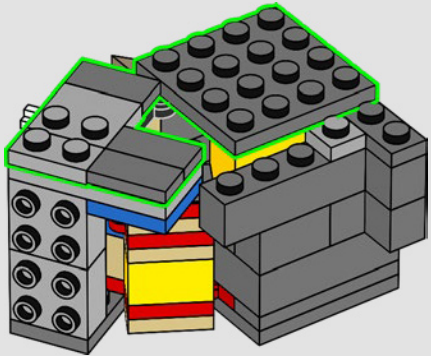

73

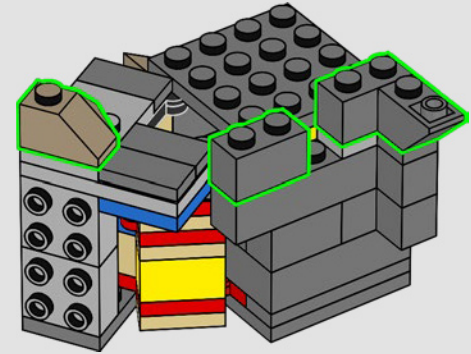

74

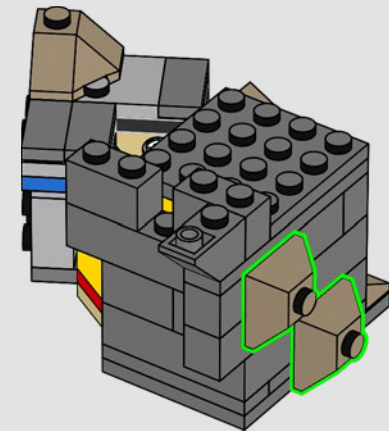
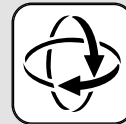

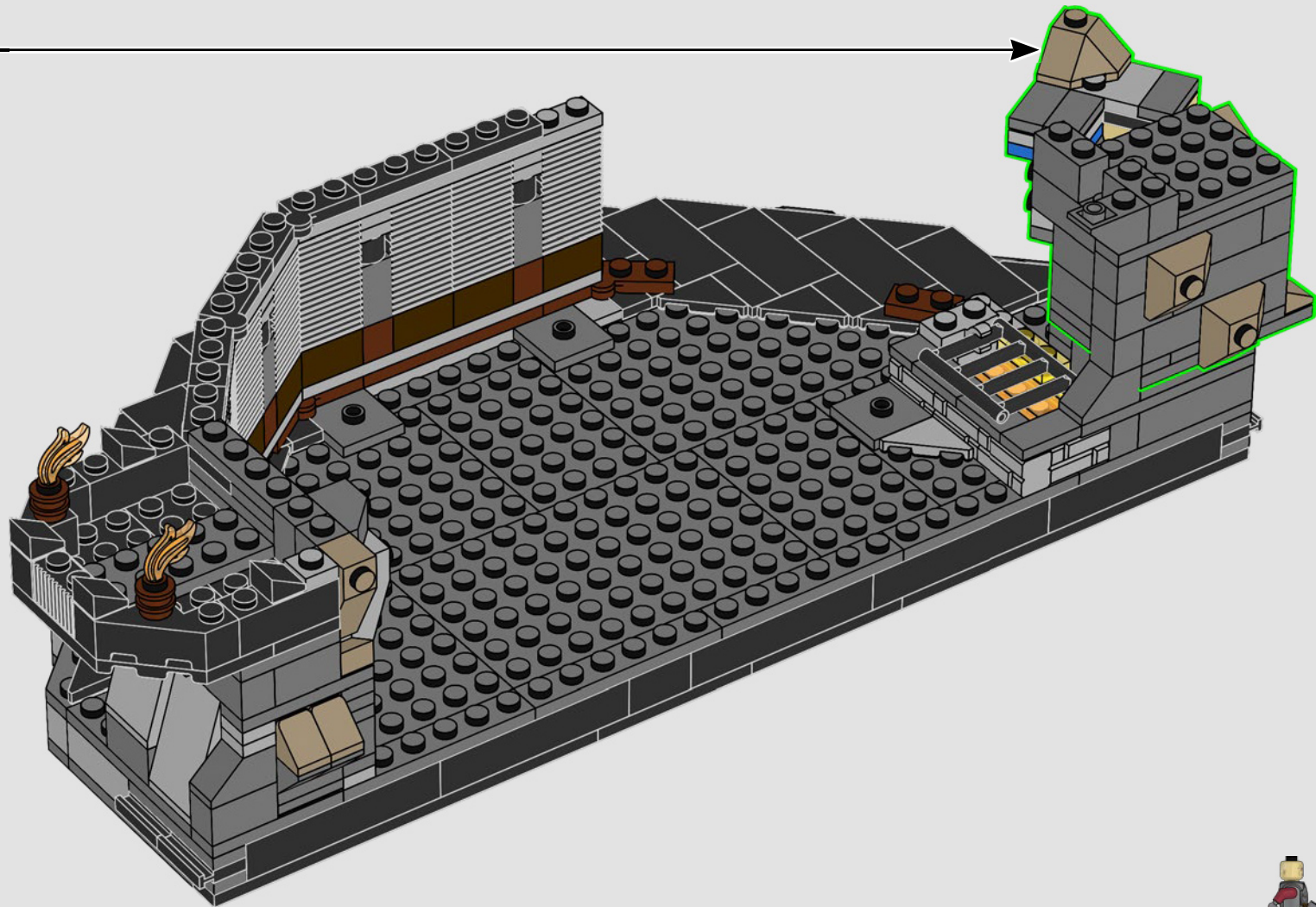

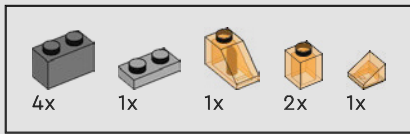

76

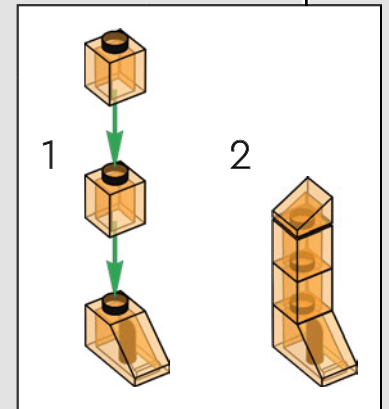
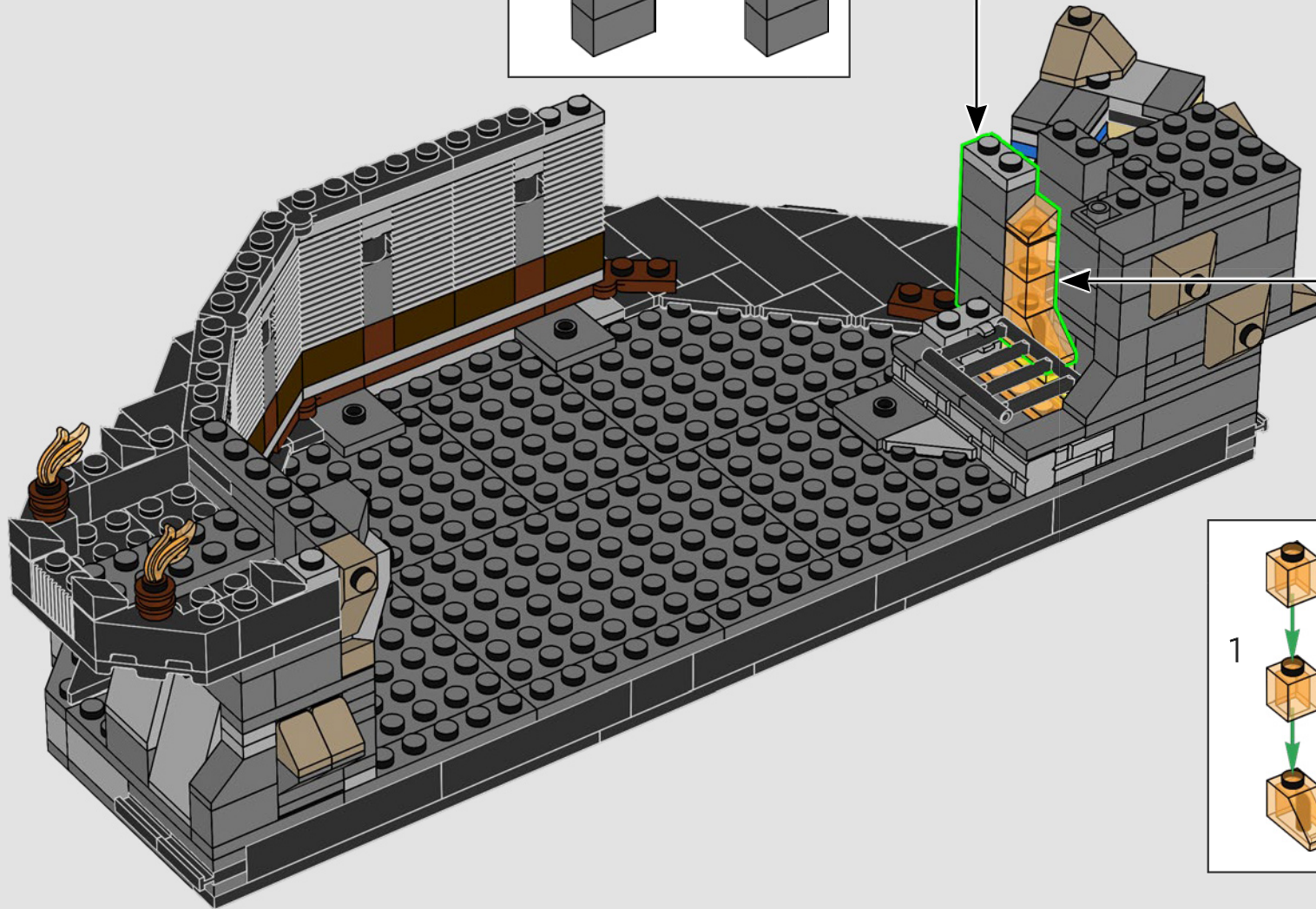
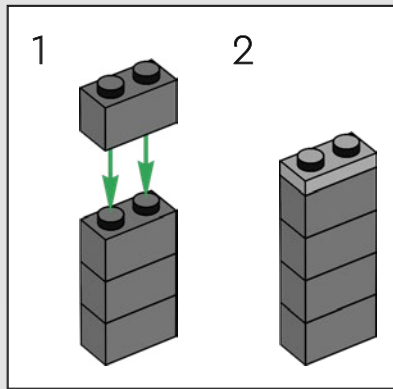

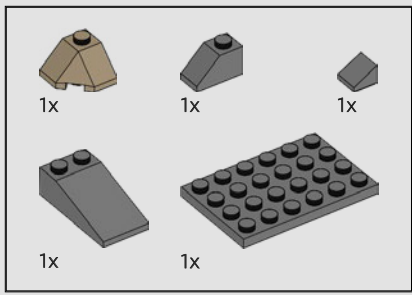

77

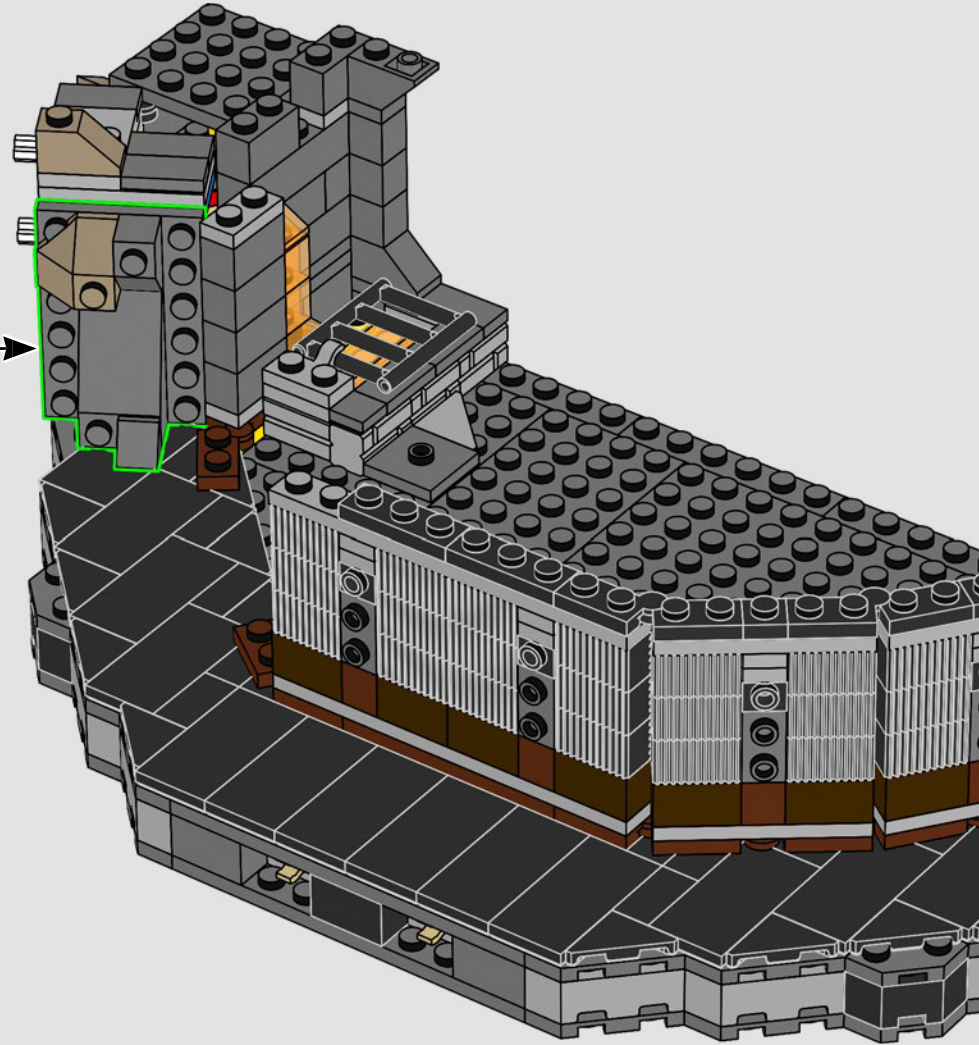
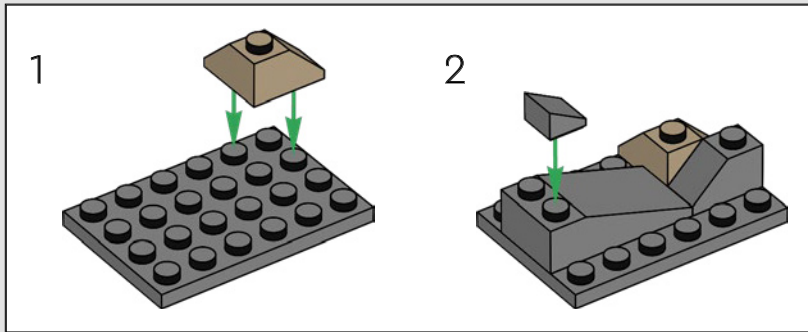

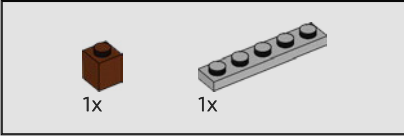
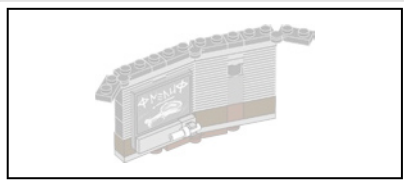

78

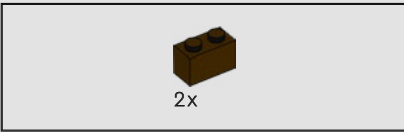
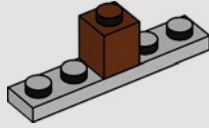

79

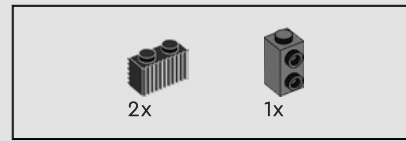
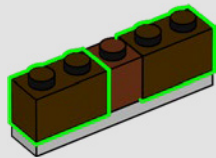

80

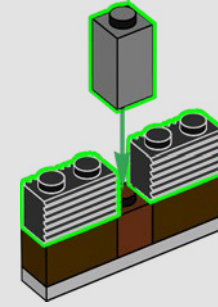

81

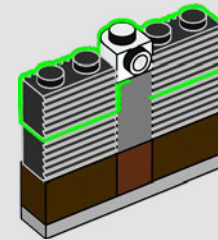

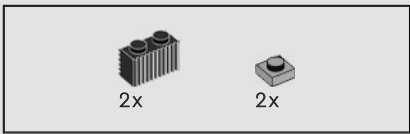

82

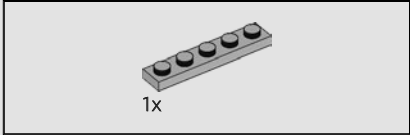
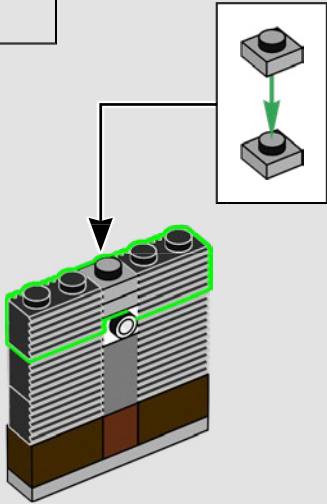

83

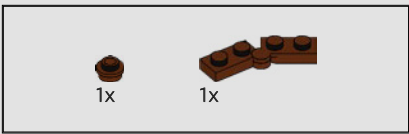
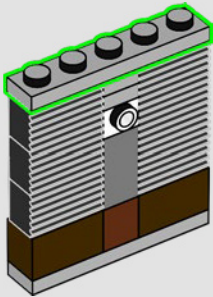

84

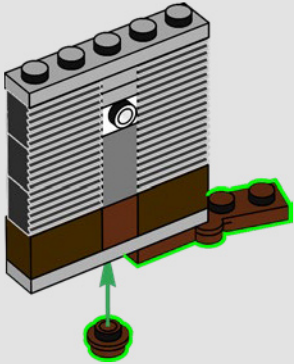

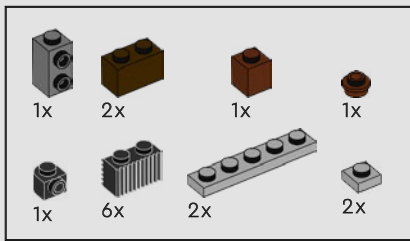

85

1

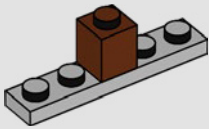

2

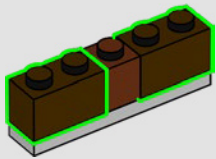

3

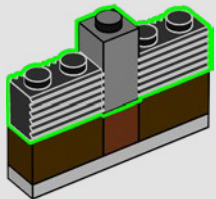

4

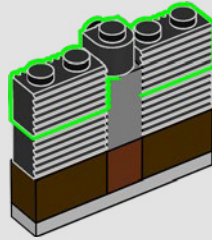

5

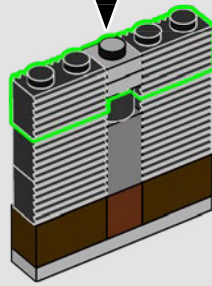

6

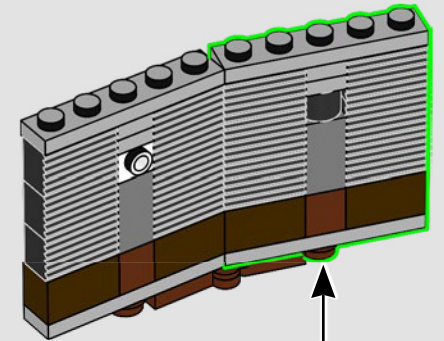
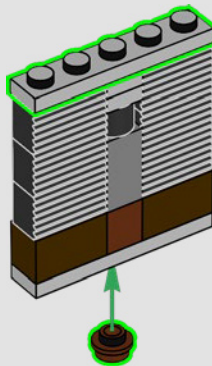



86

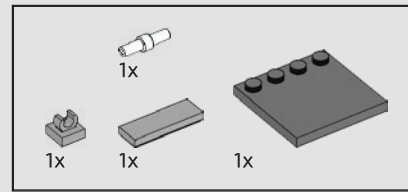
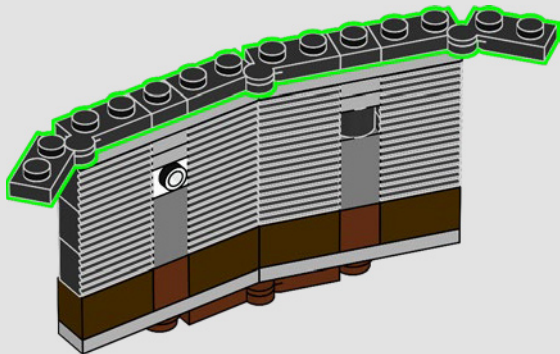

87

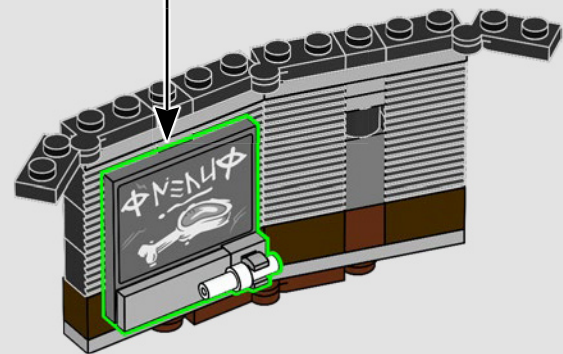
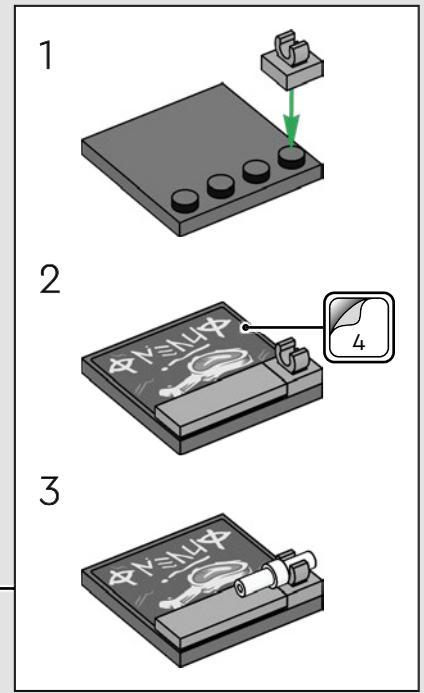



“看来有肉吃了, 小崽子们!” - 乌格鲁克

88

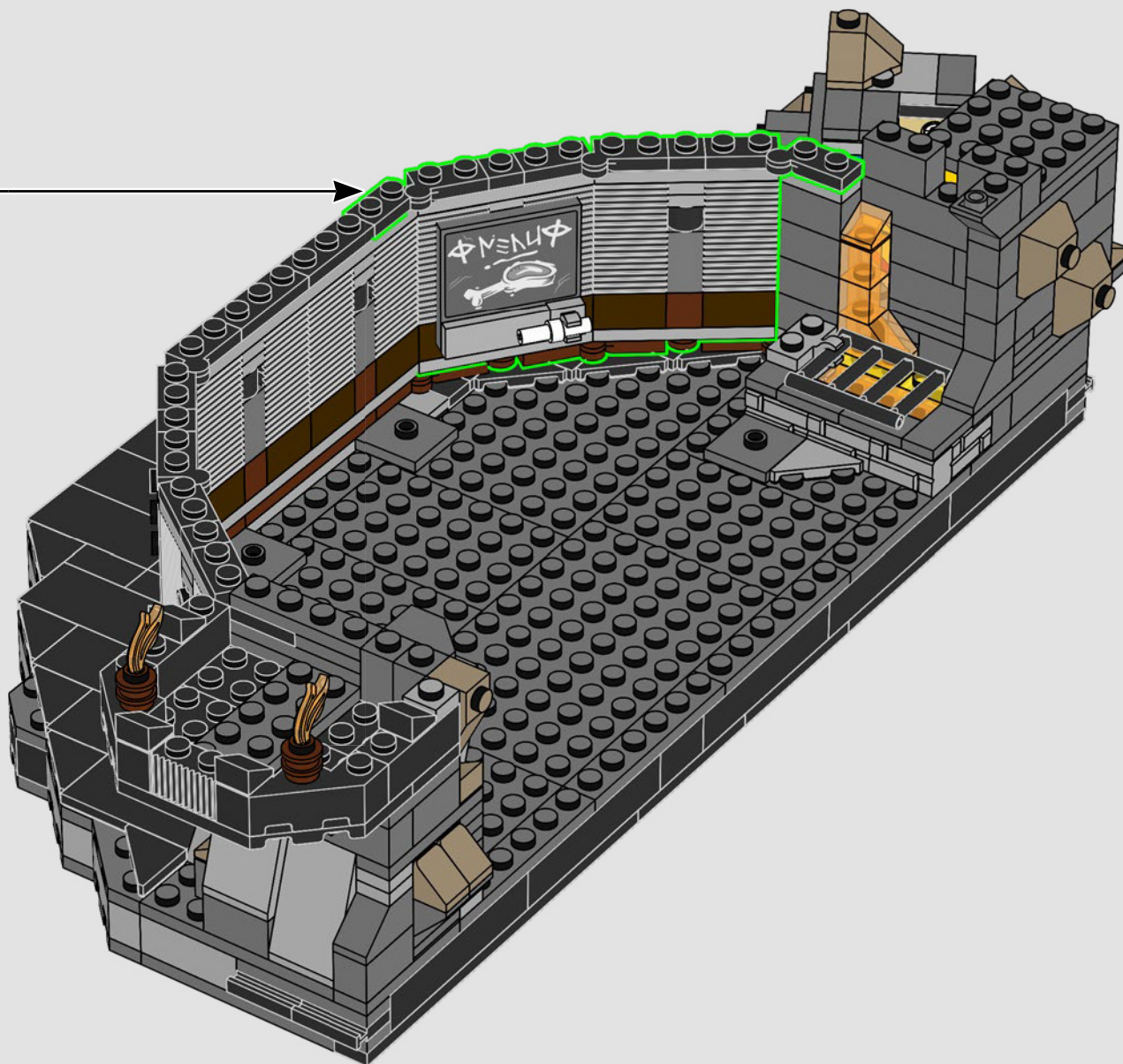

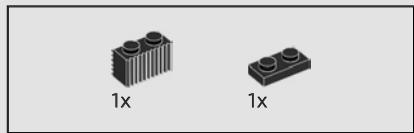

89

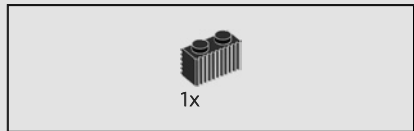

90

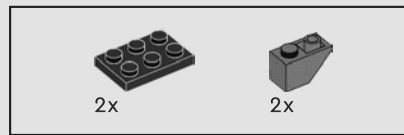
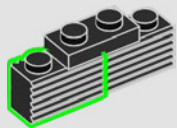

91

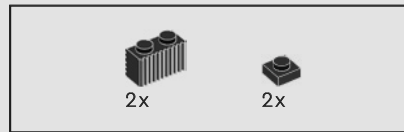
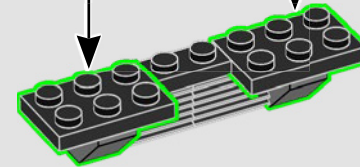
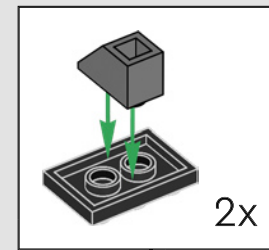

92

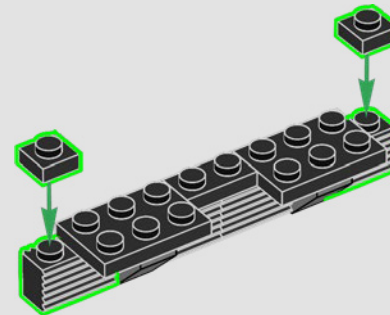

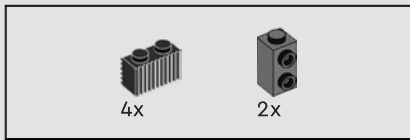

93

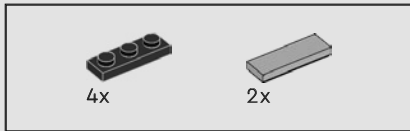
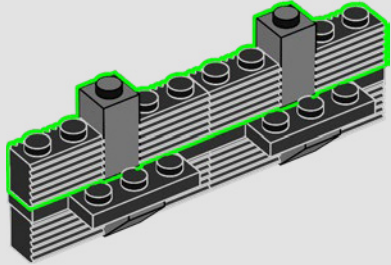

94

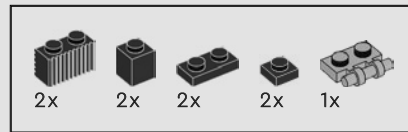
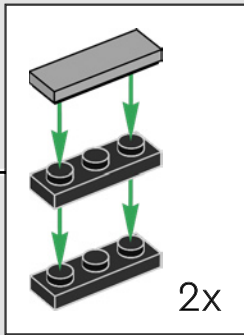
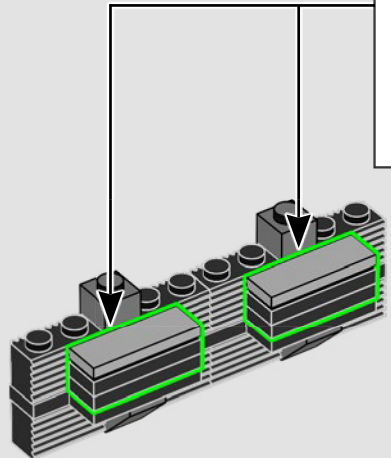

95

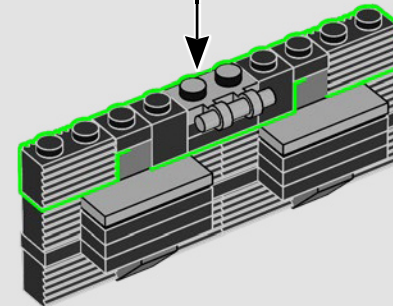
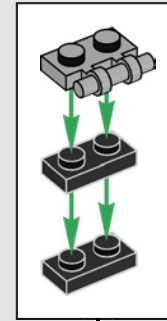

96

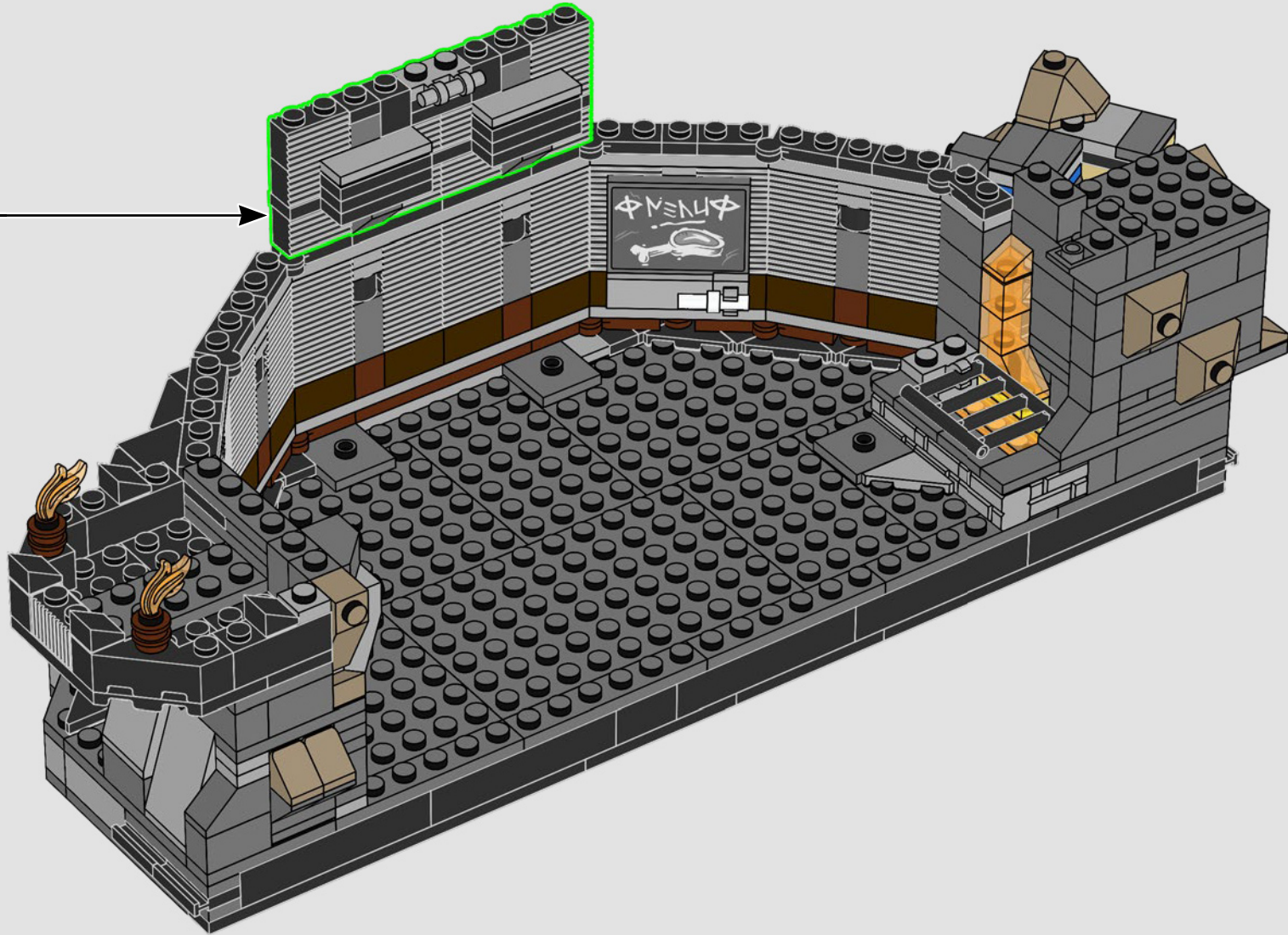

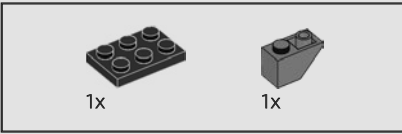
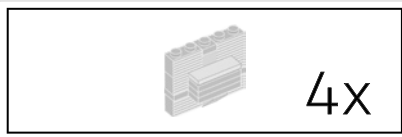

97

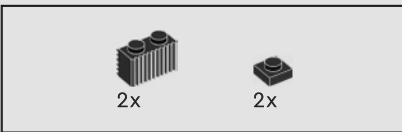
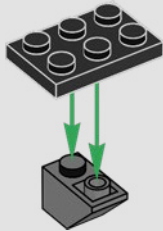

98

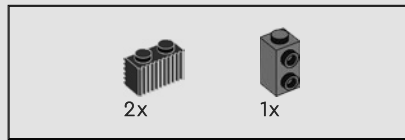
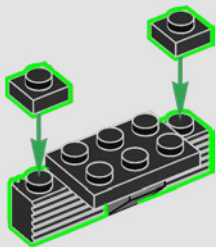

99

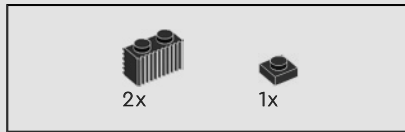
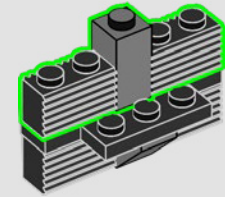

100

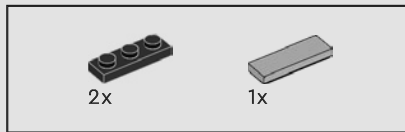
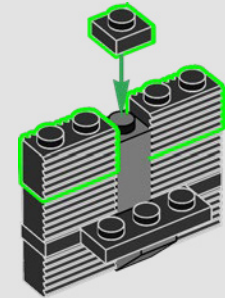

101

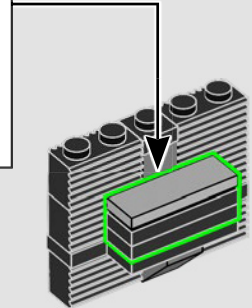
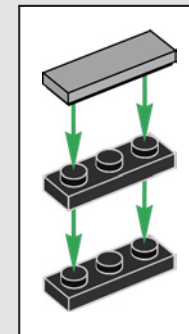

4x



102

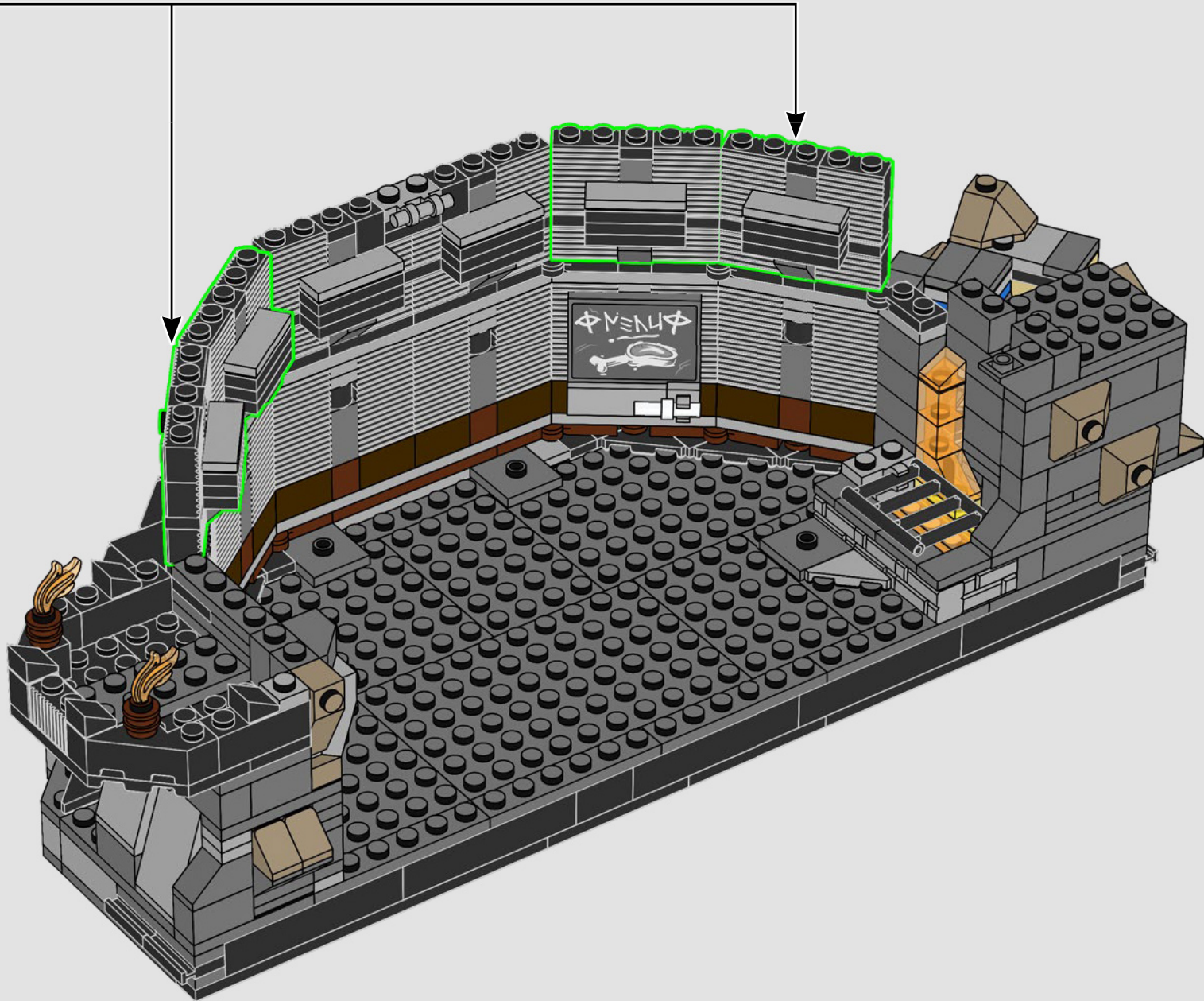

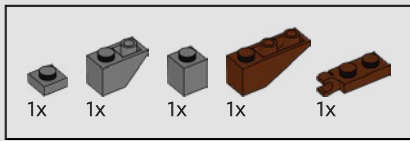

103

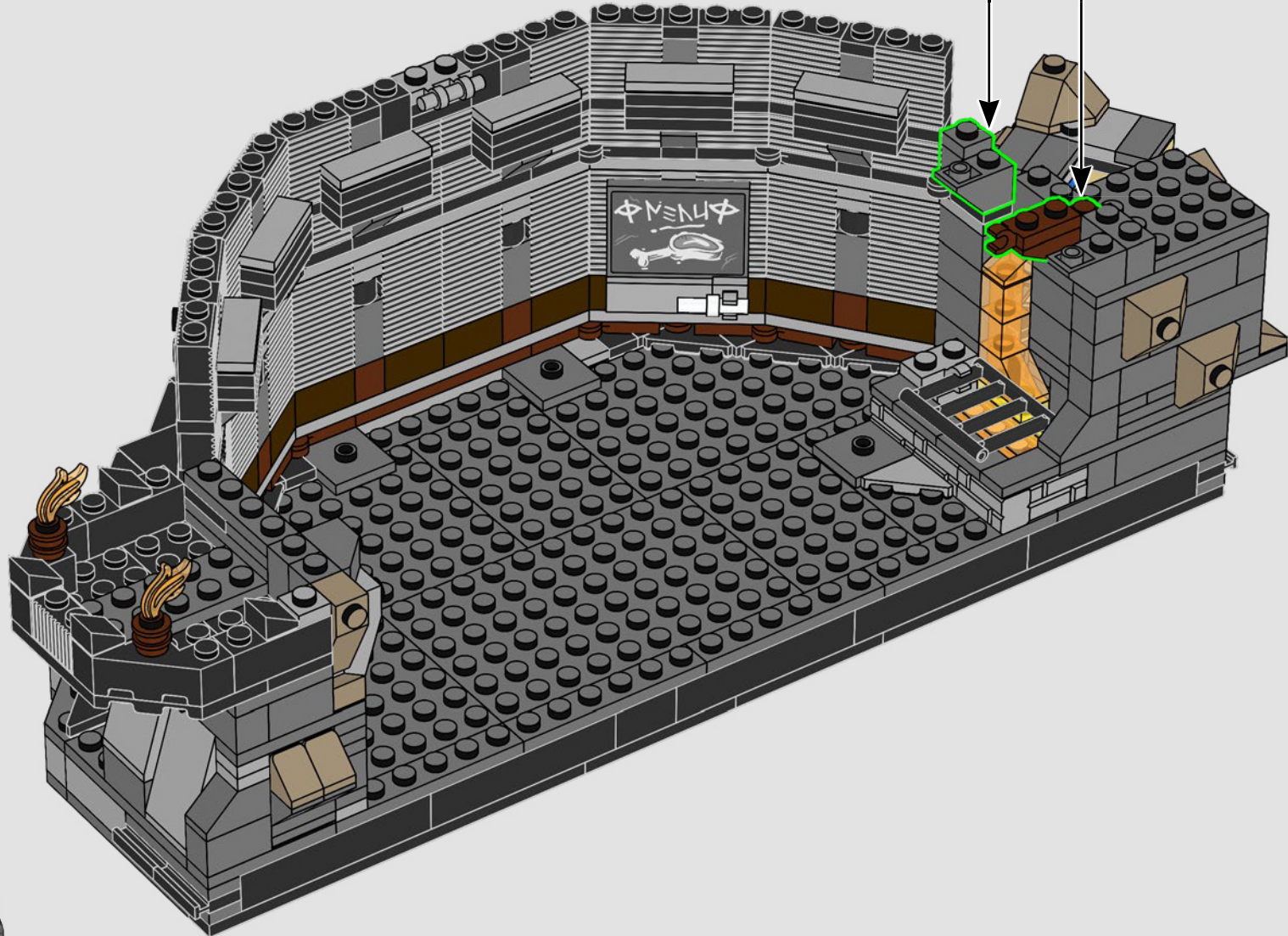
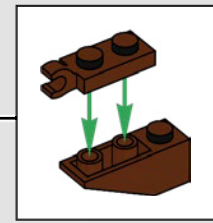
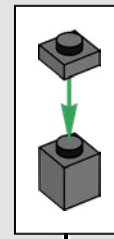

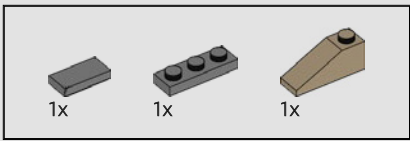

104

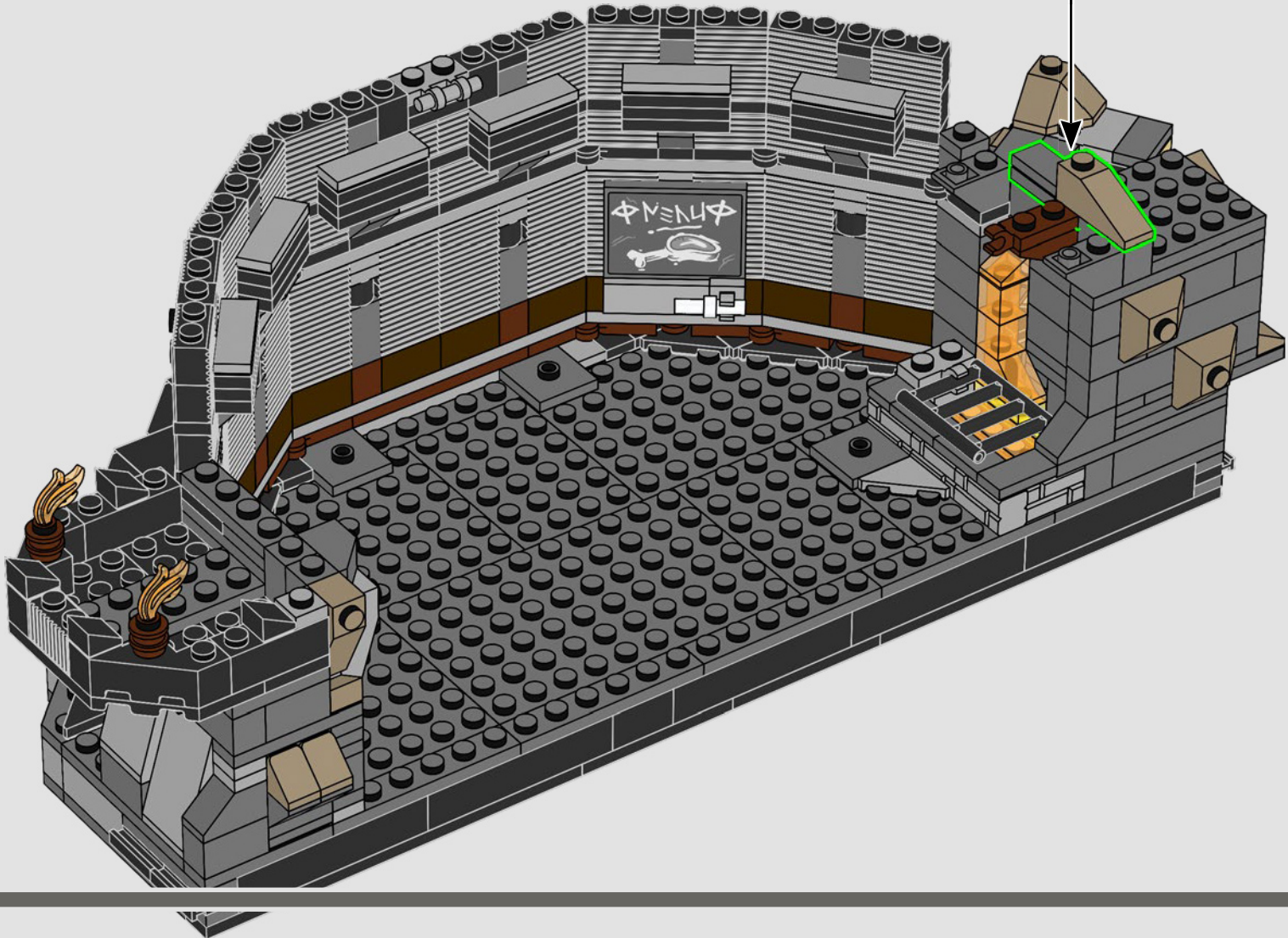
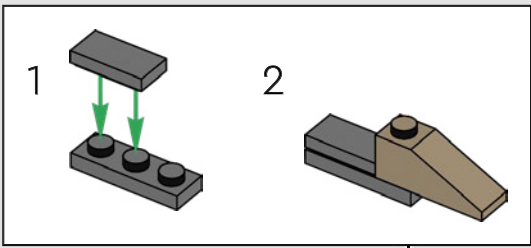

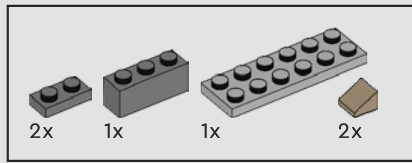

105

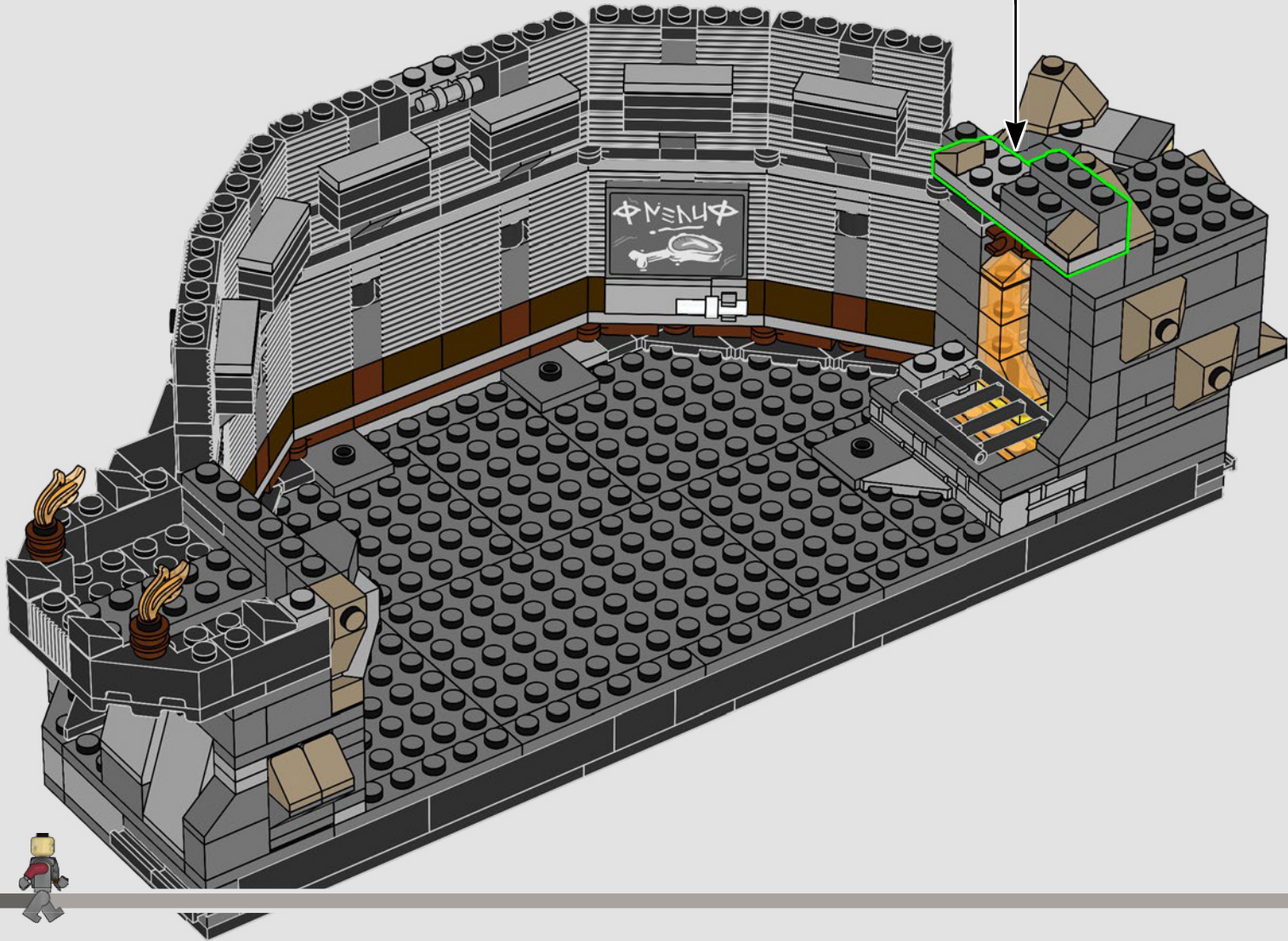
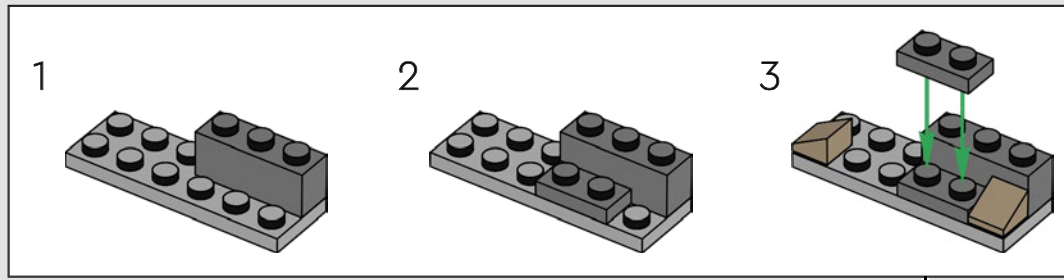

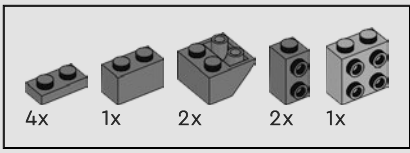

106

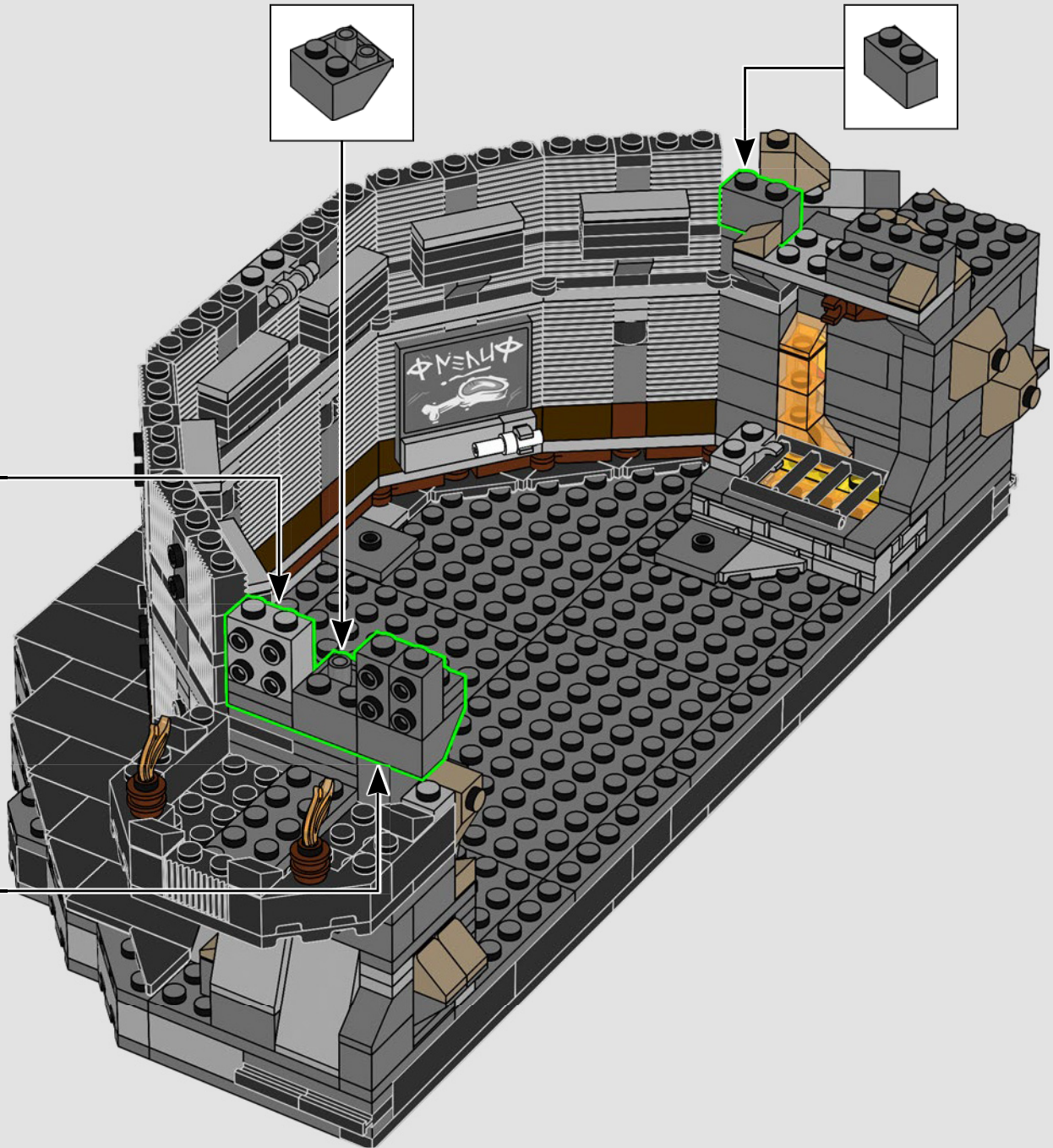
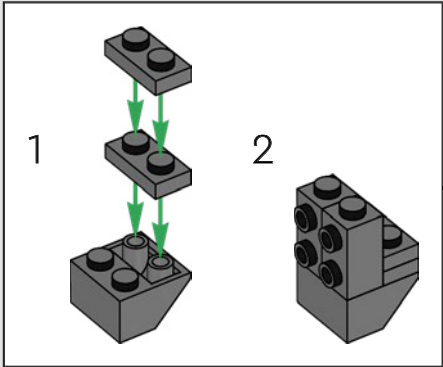
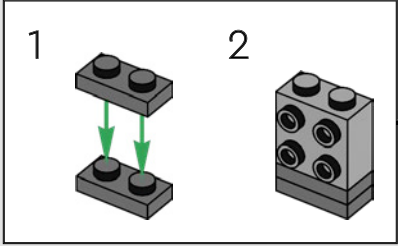

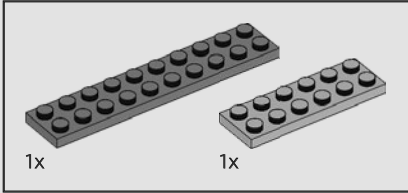
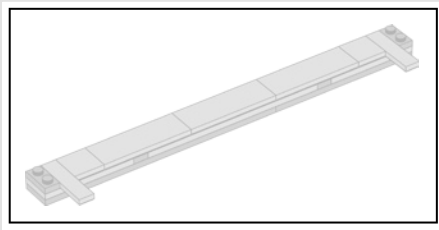

107

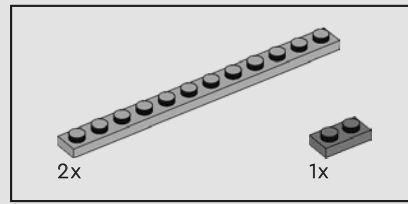
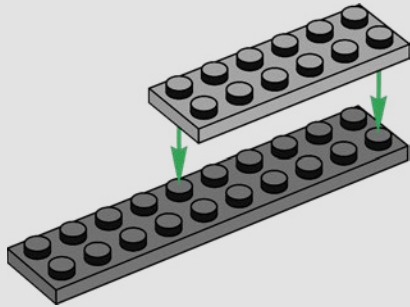

108

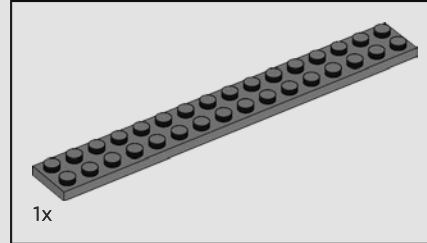
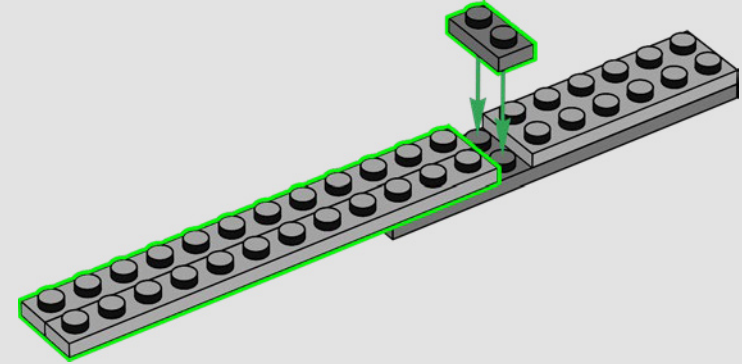

109

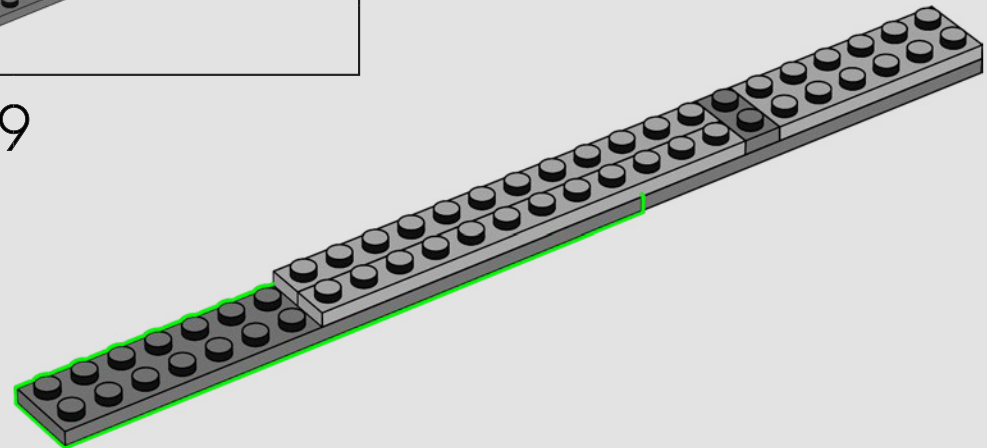

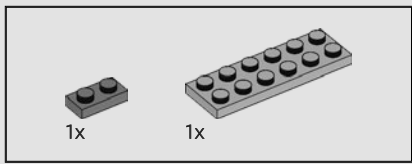

110

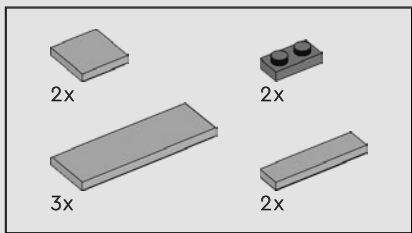
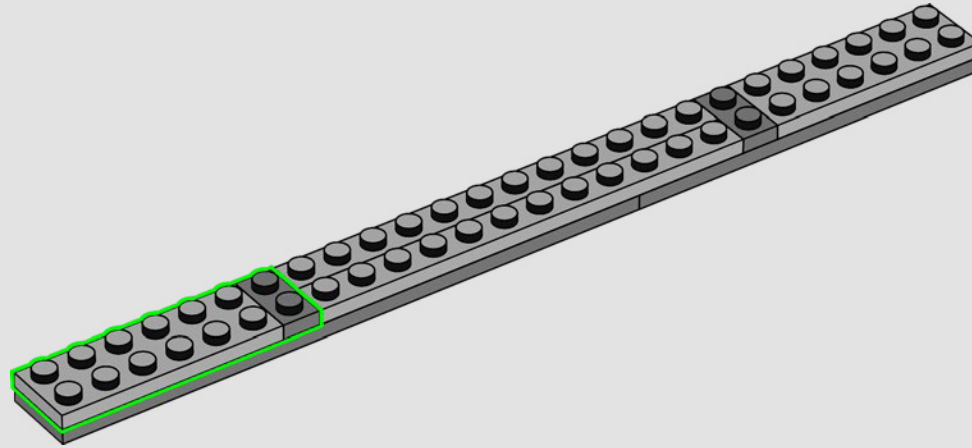

111

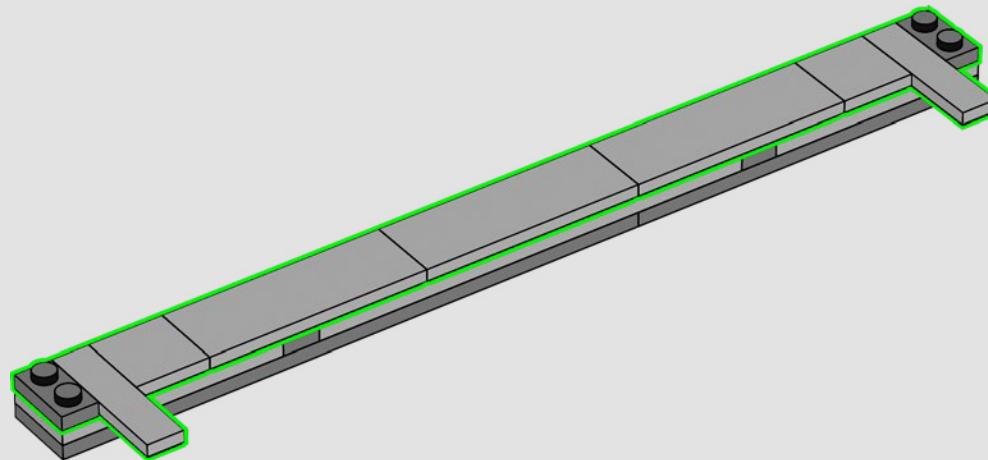

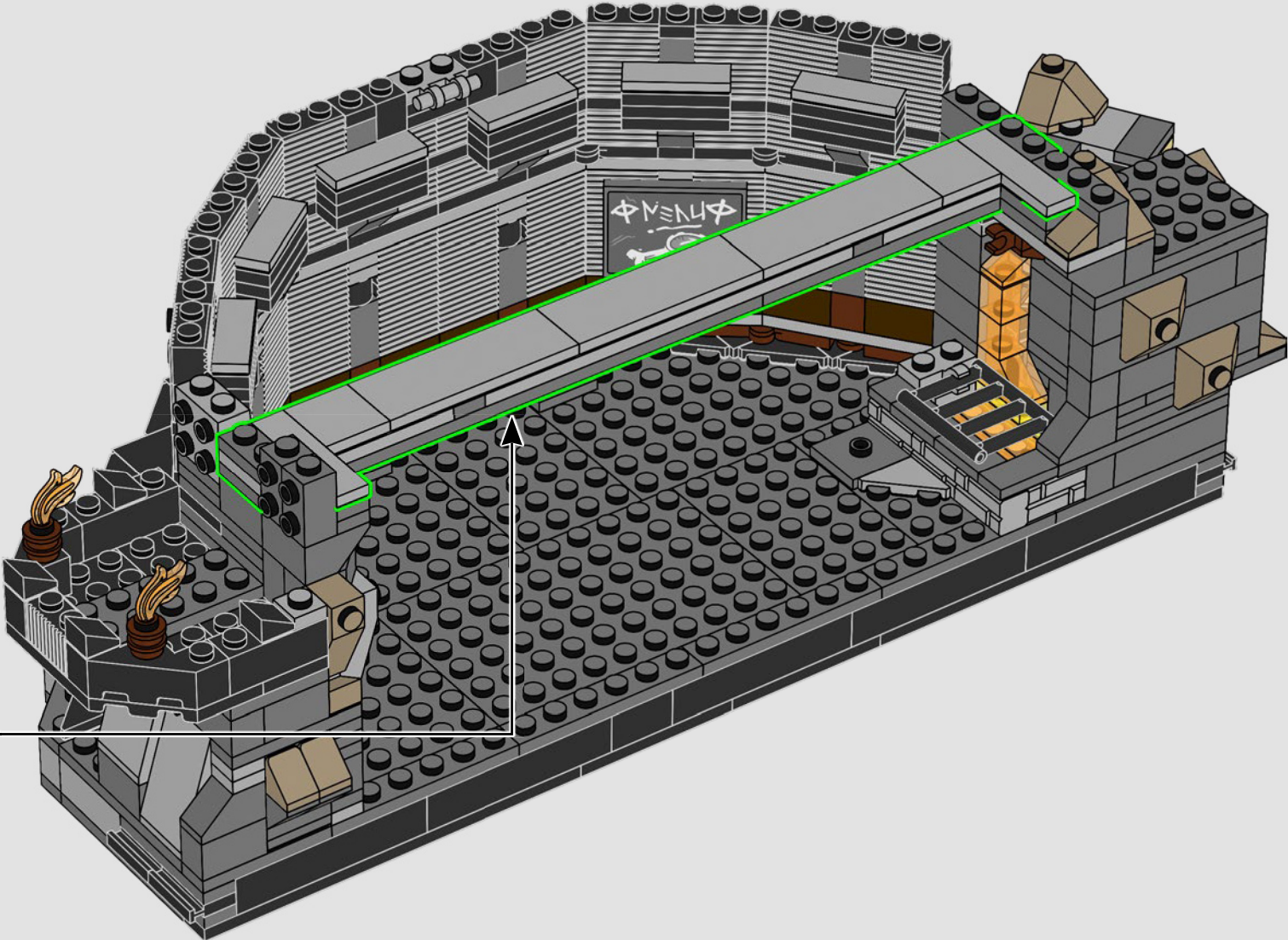

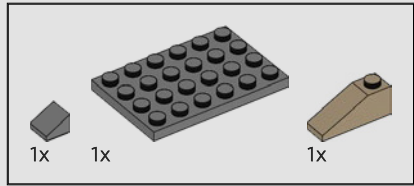

113

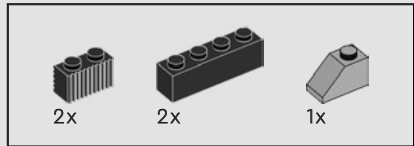
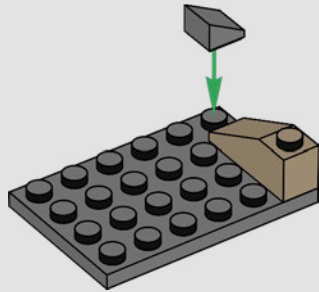

114

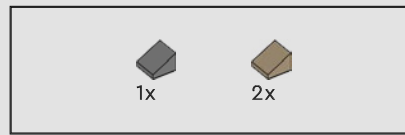
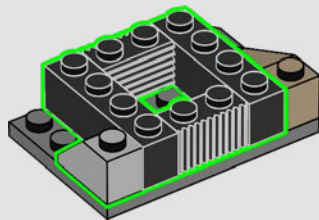

115

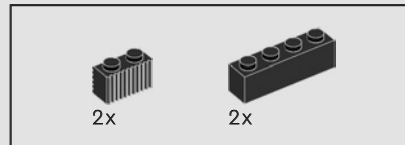
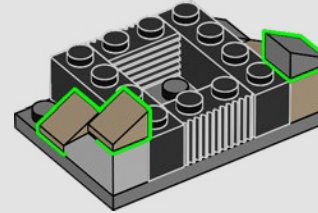

116

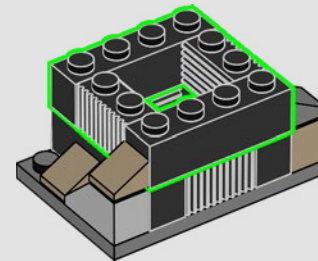

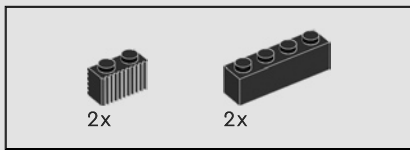

117

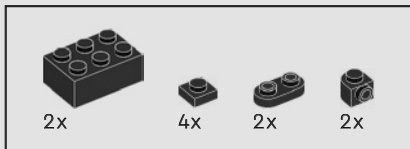
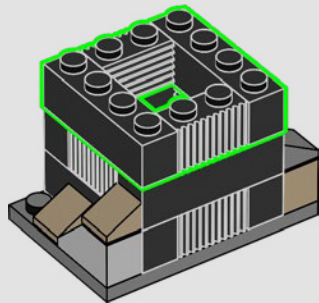

118

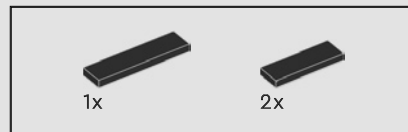
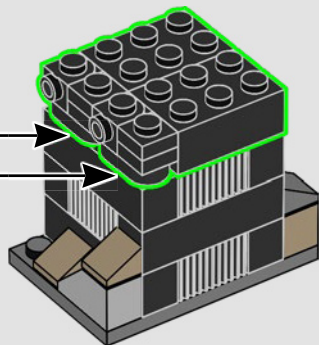
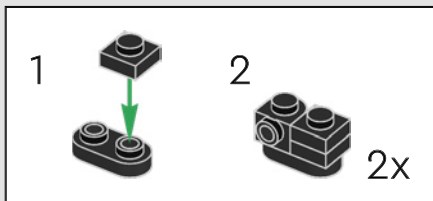

119

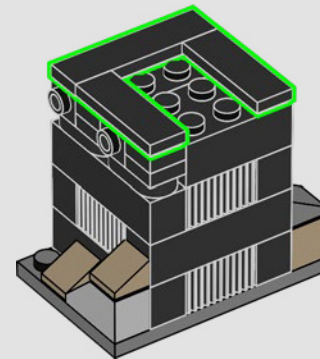

120

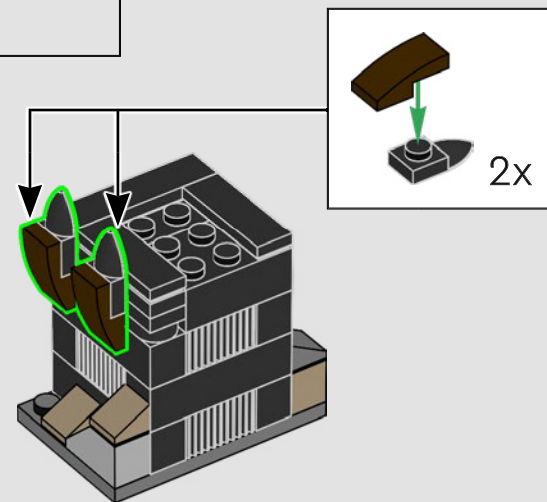

121

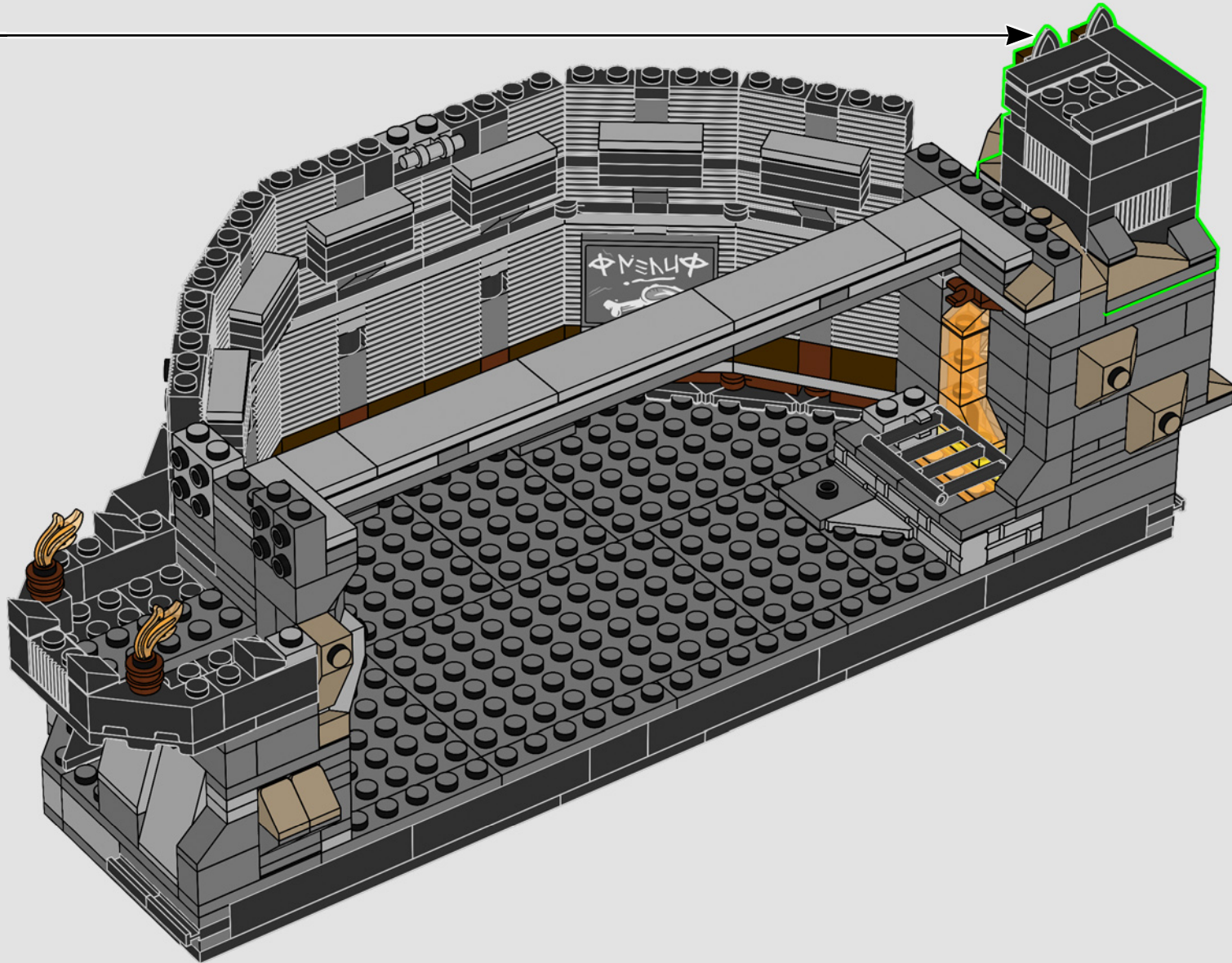

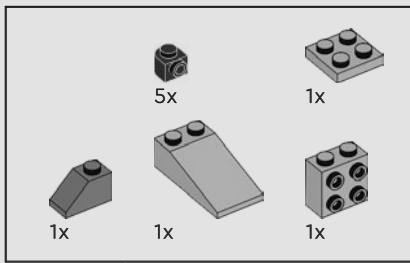

122

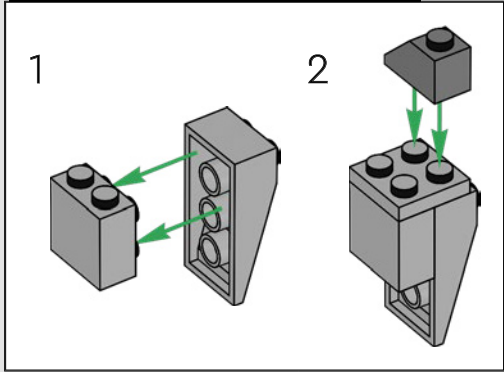
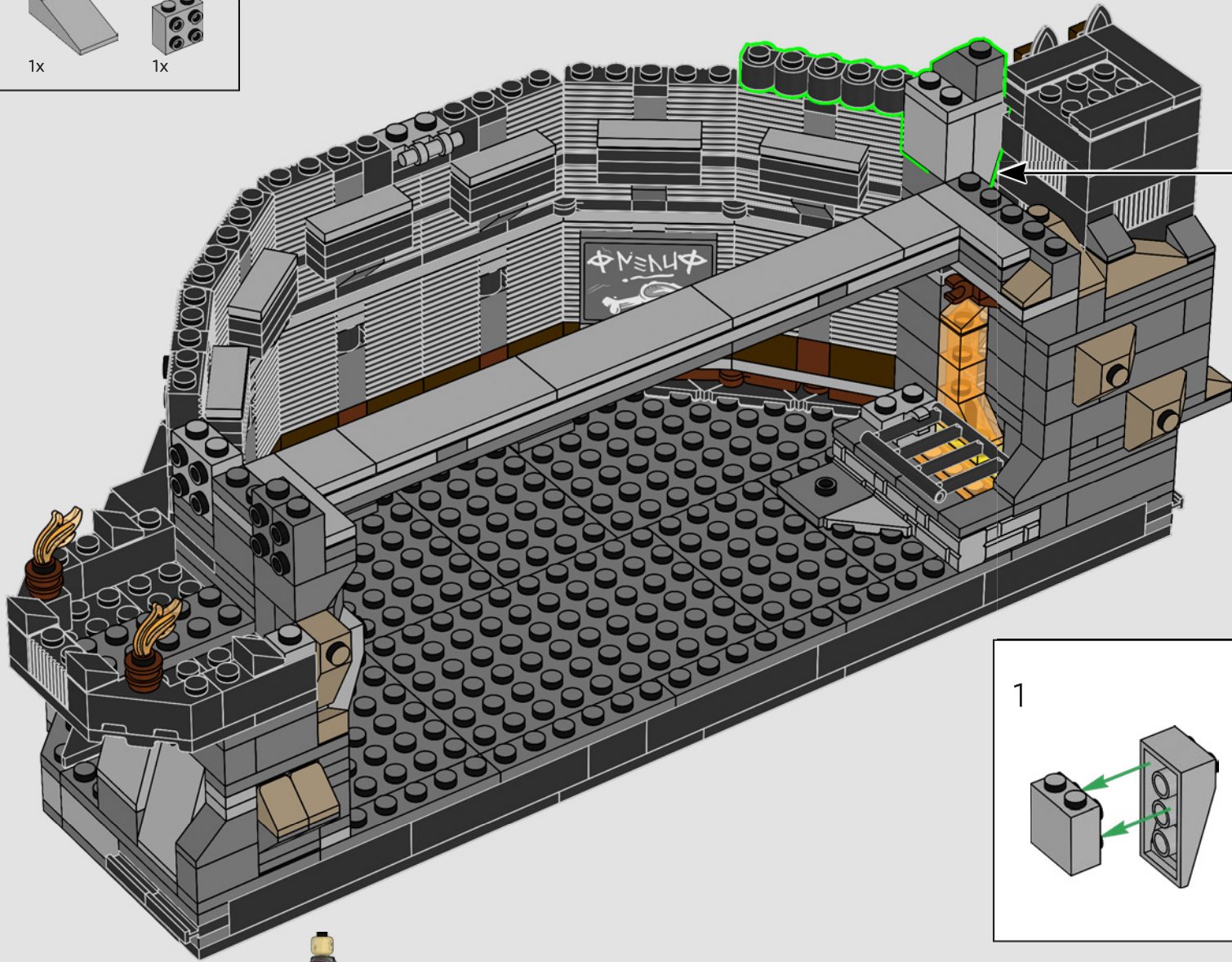

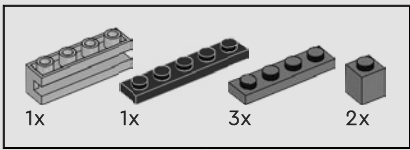

123

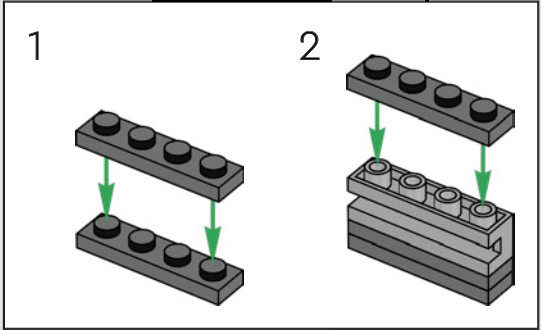
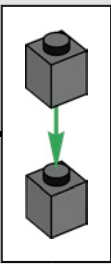
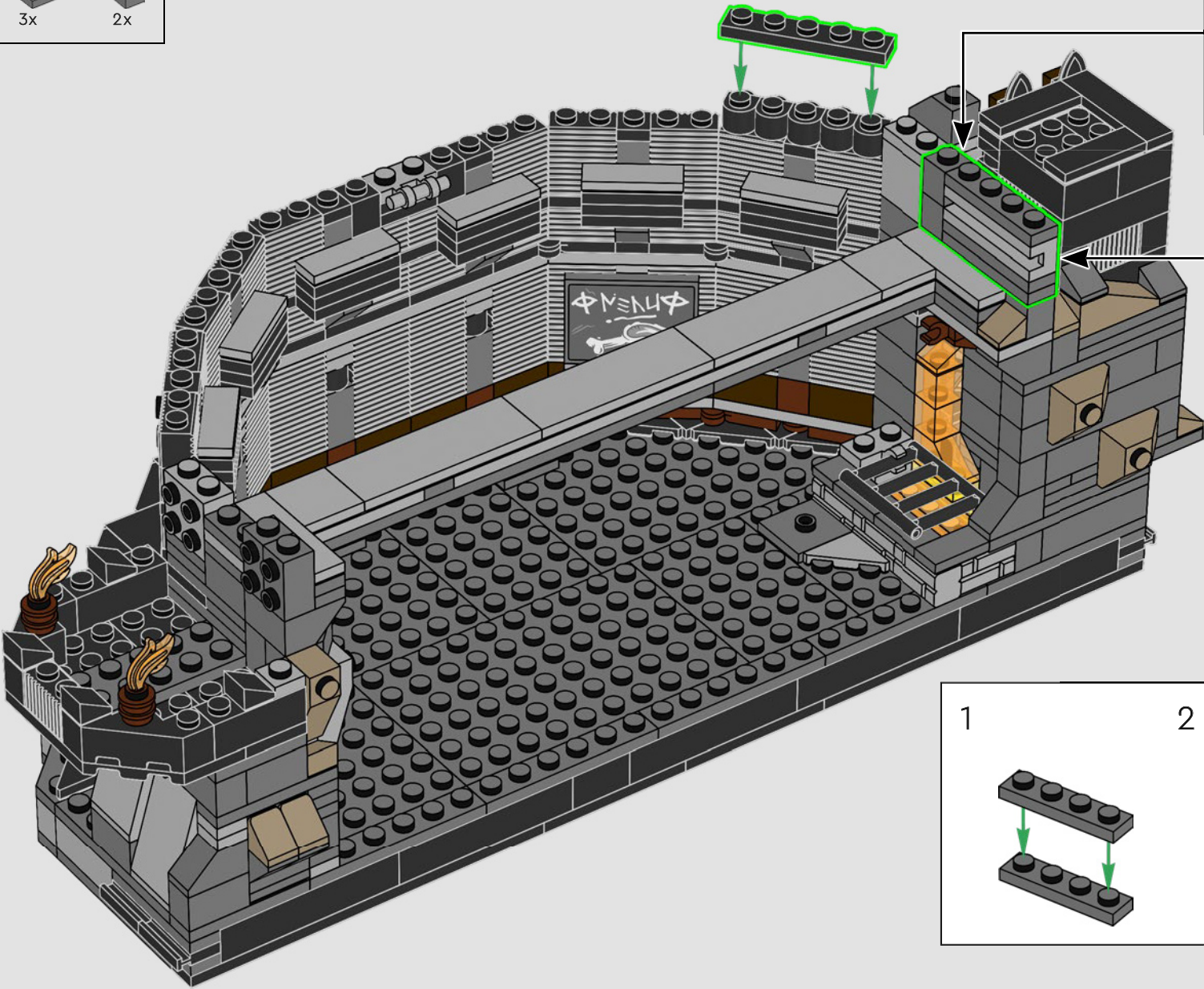

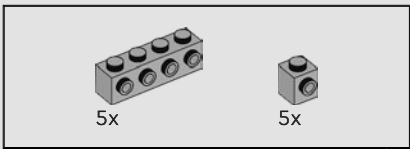

124

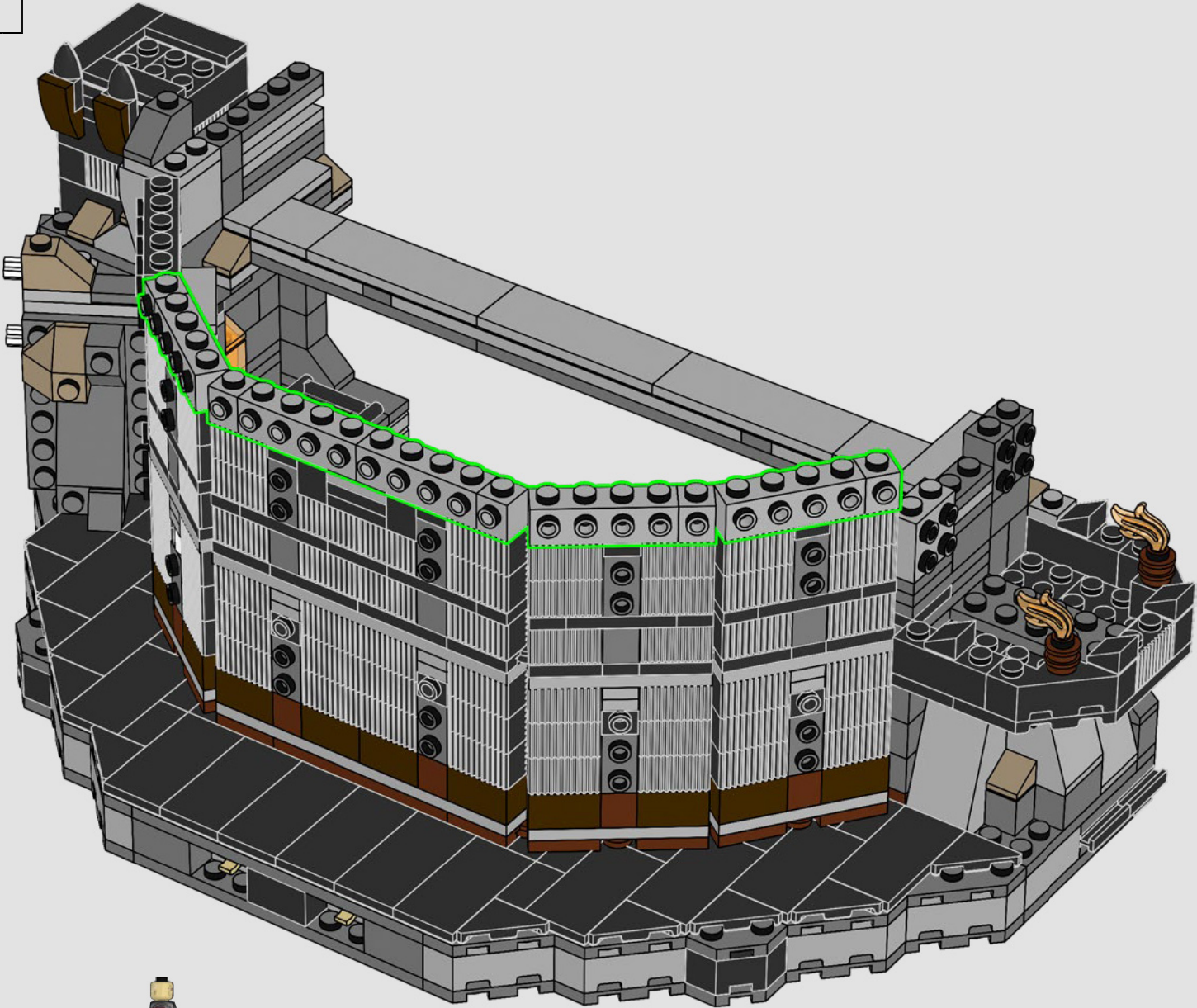

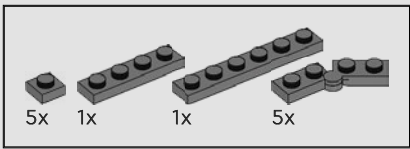

125

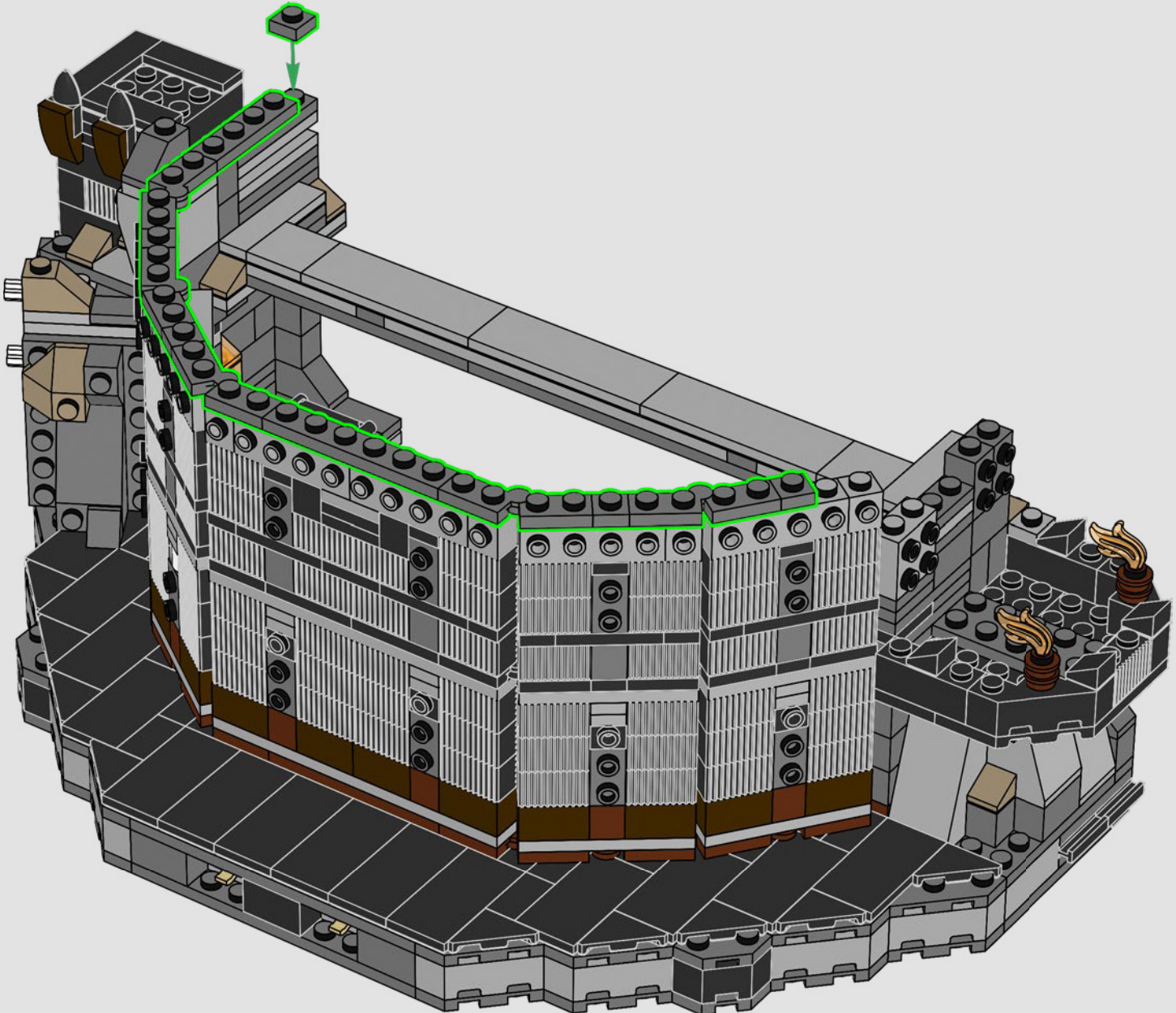

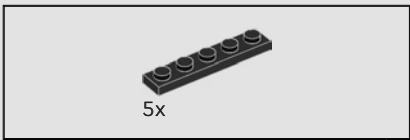

126

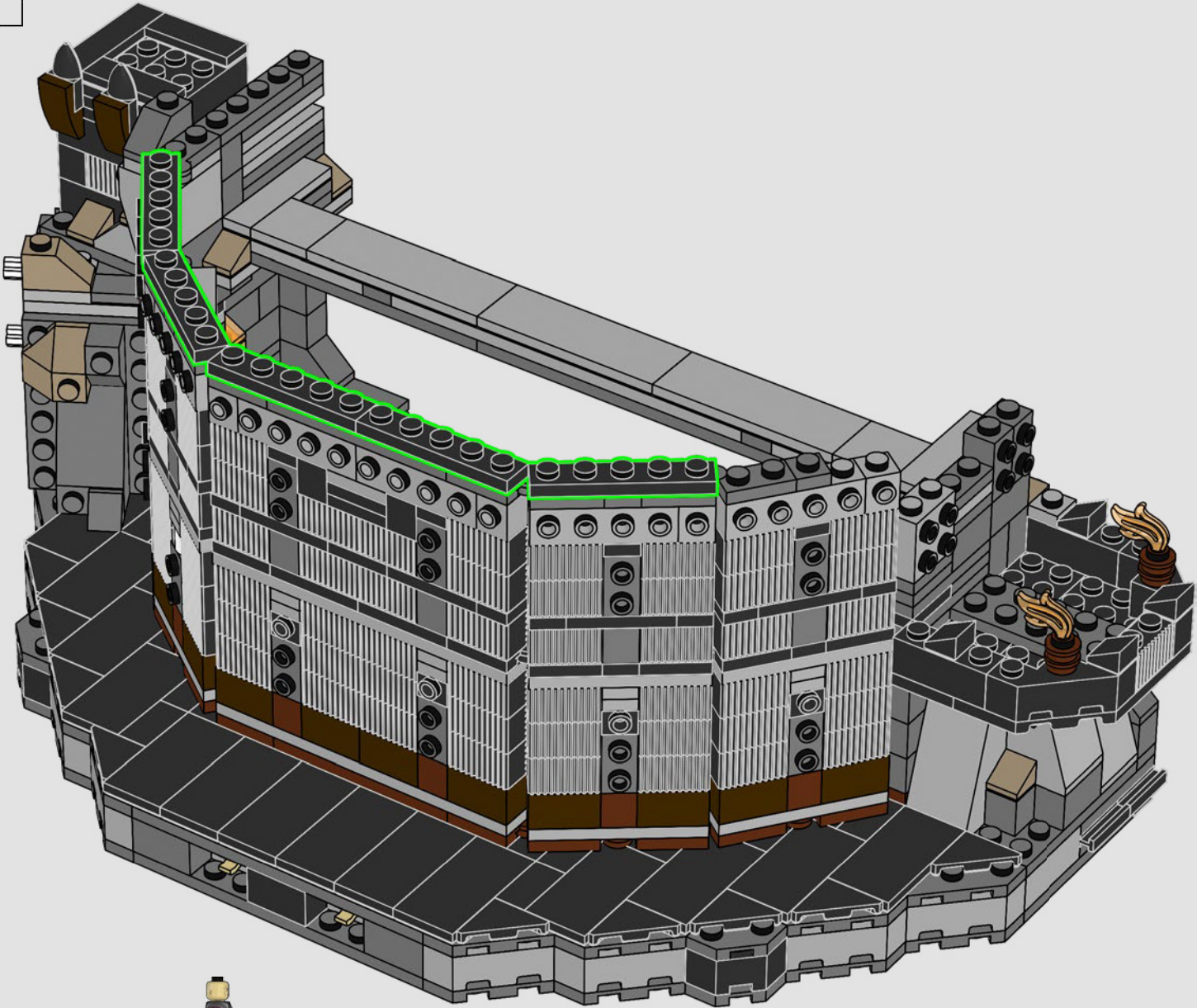



为了《指环王》电影的拍摄，以 1:66 的比例建造了一个高达 8.2 米的巴拉都模型。



127

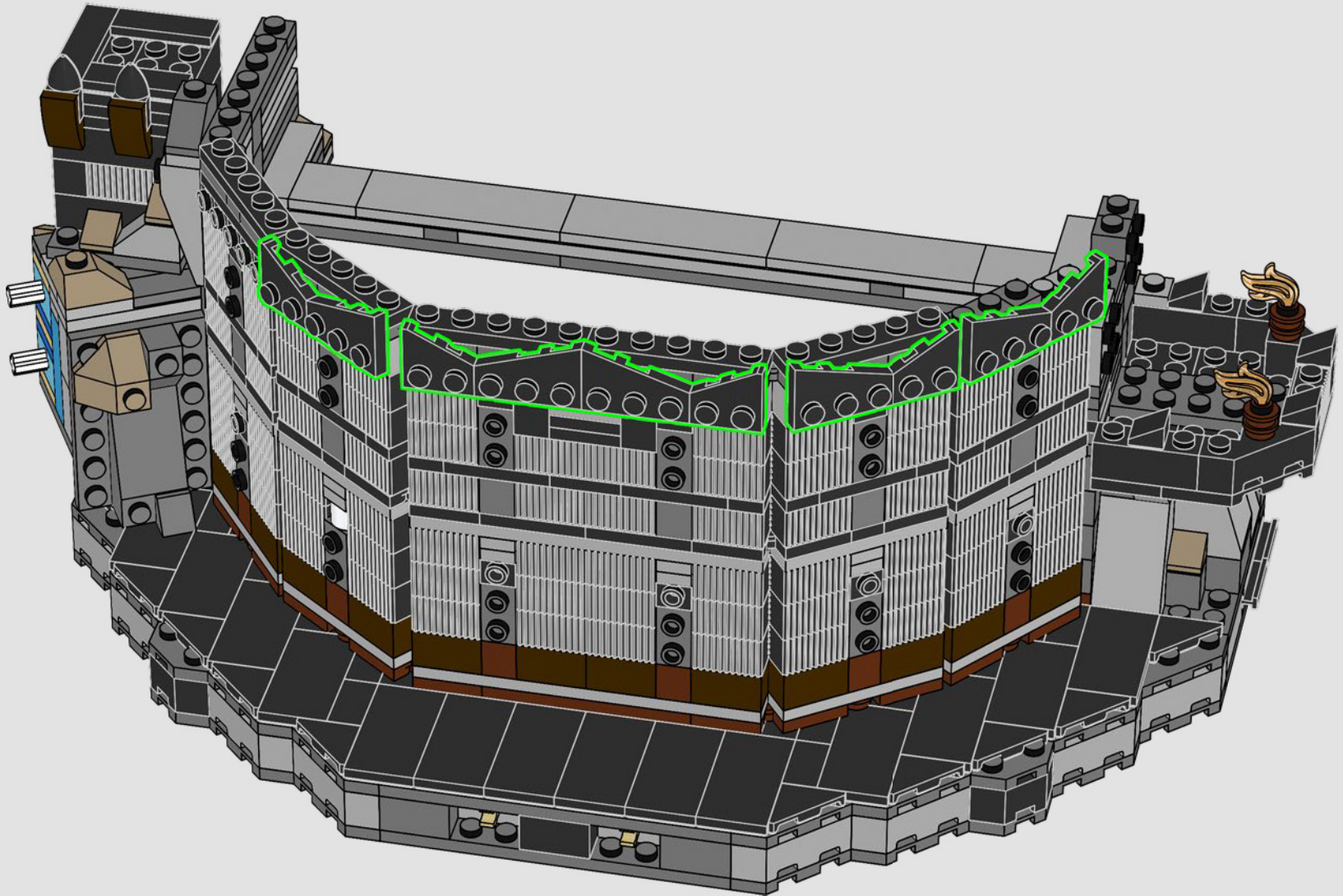

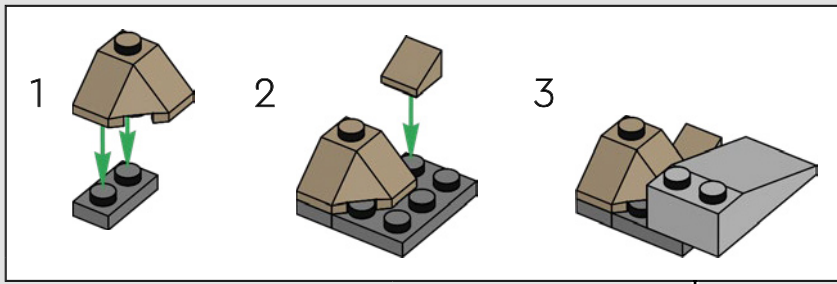
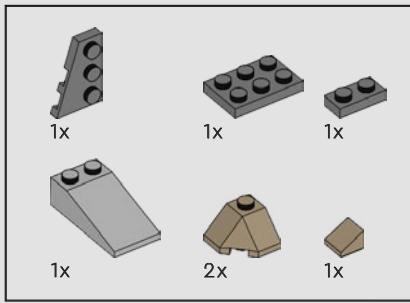

128

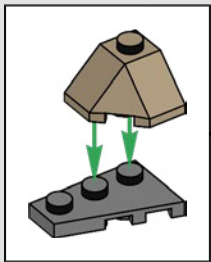
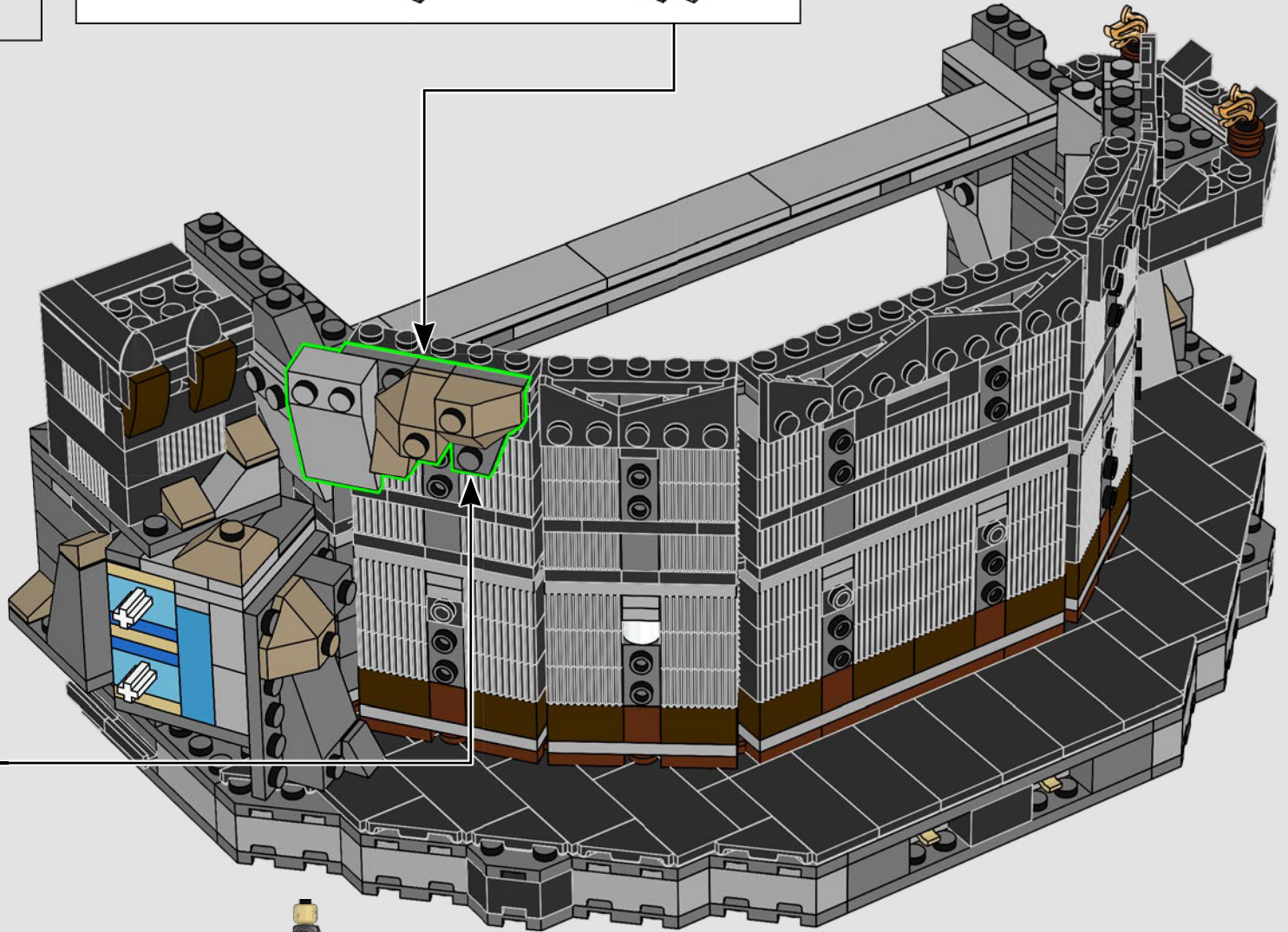

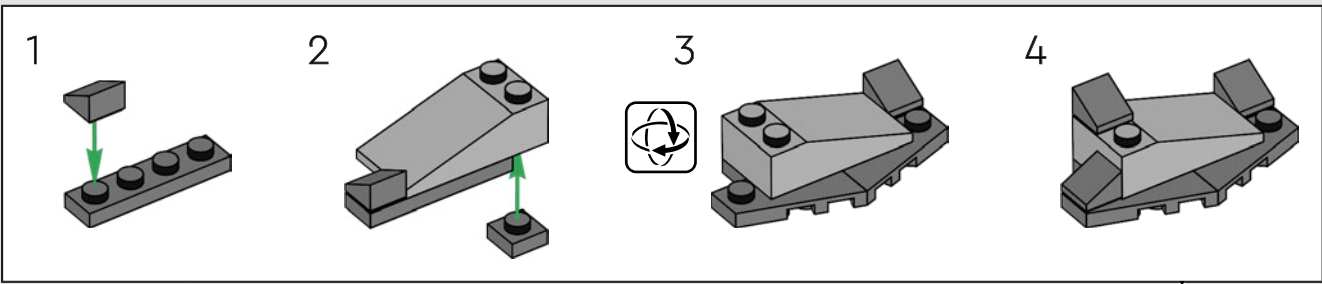
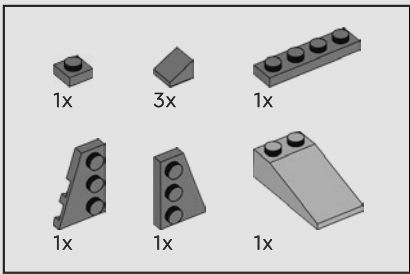

129

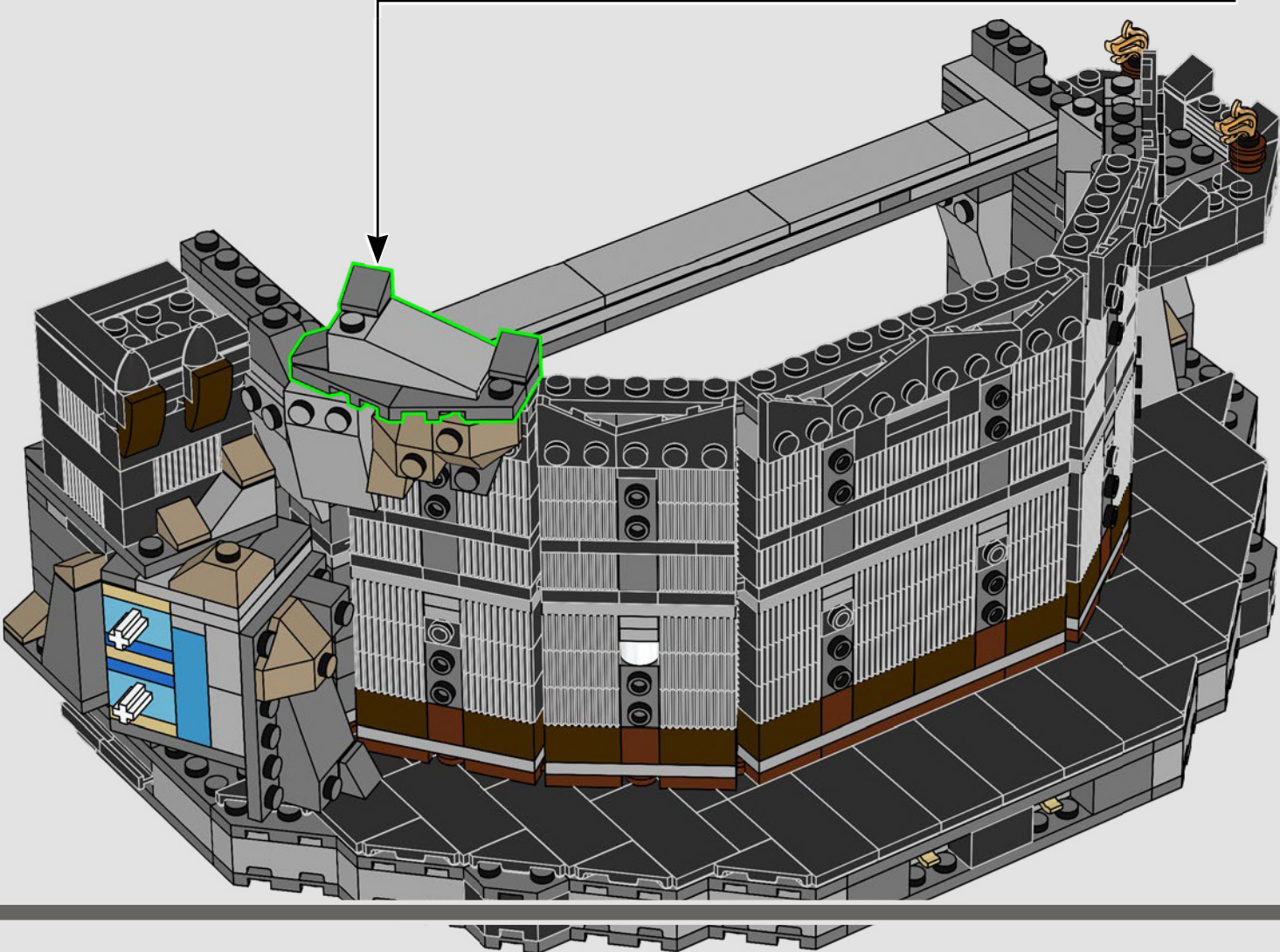

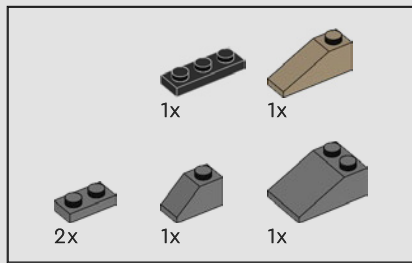

130

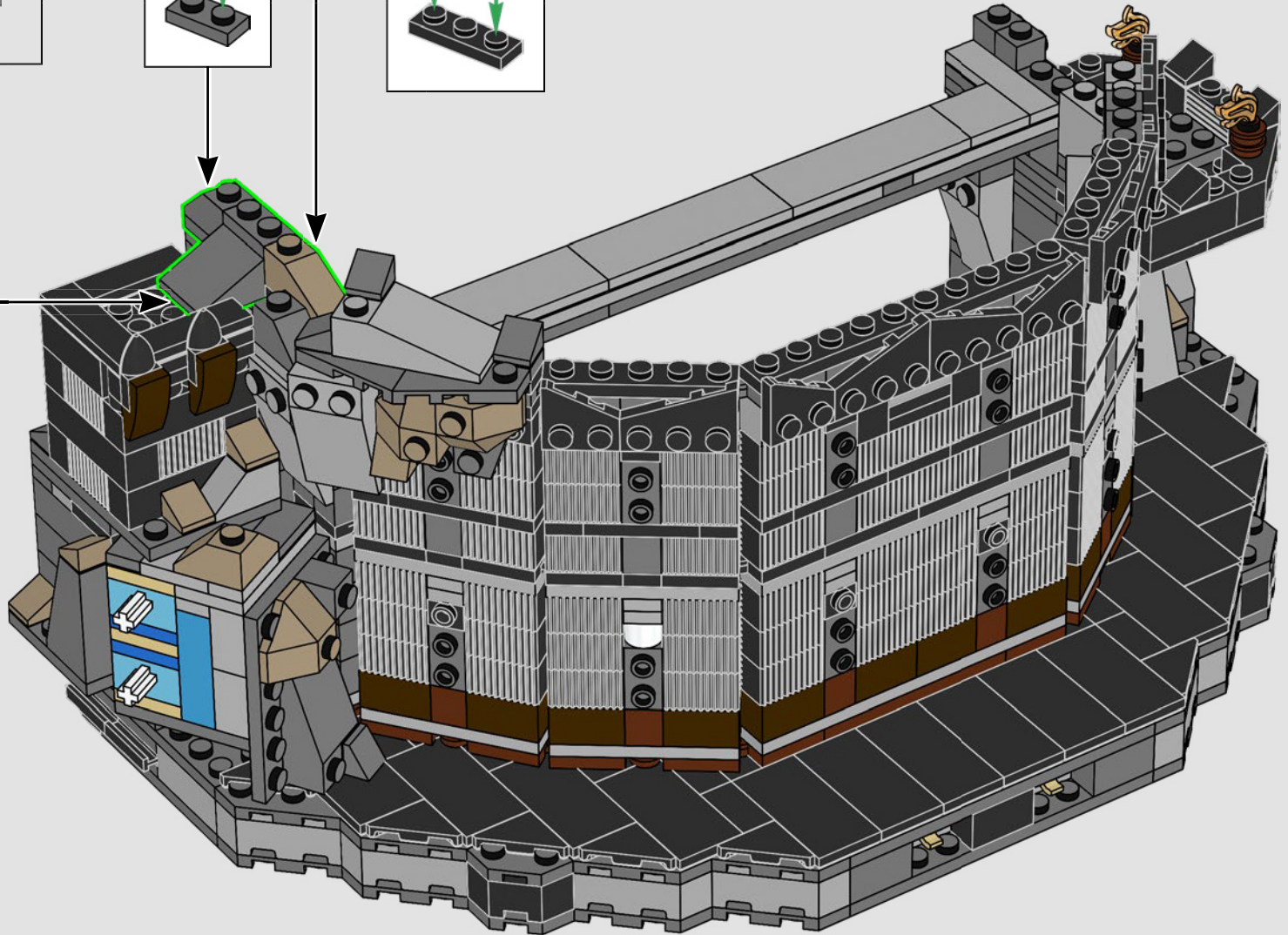
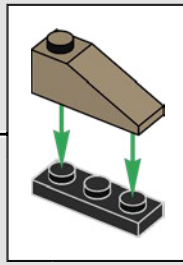
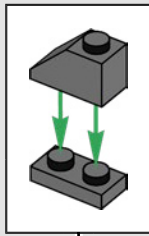
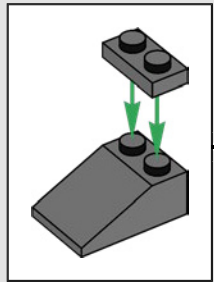

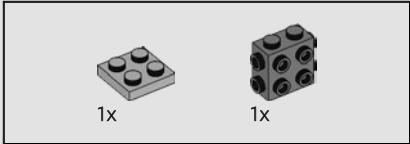
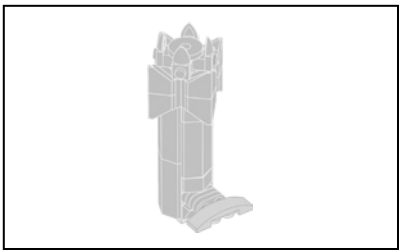

131

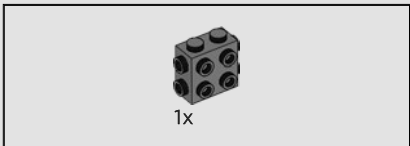
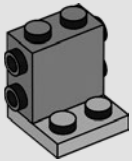

132

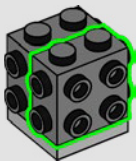

133

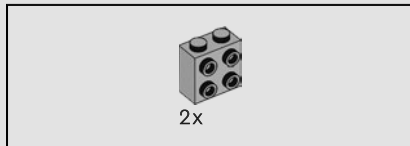
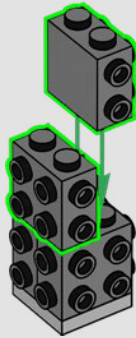

134

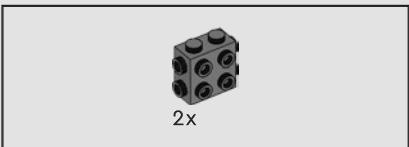
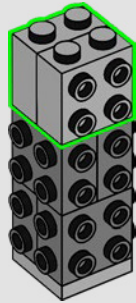

135

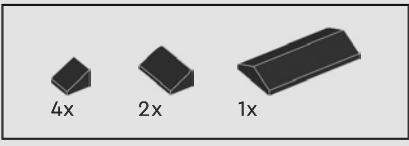
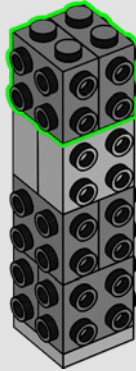

136

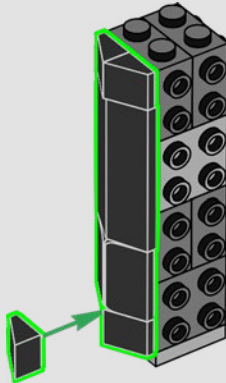

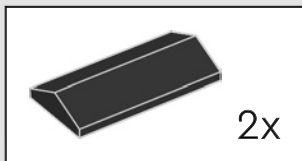
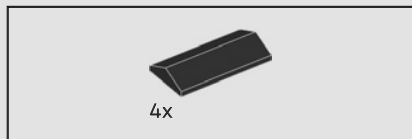

137

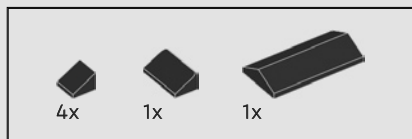
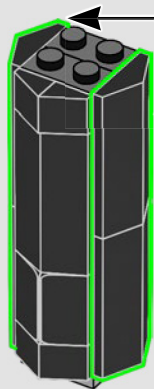

138

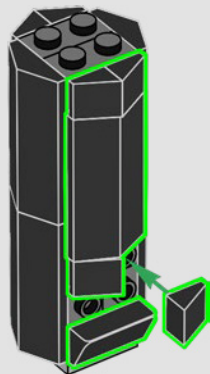

139

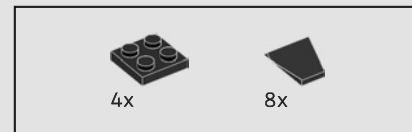
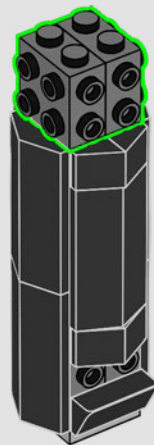

140

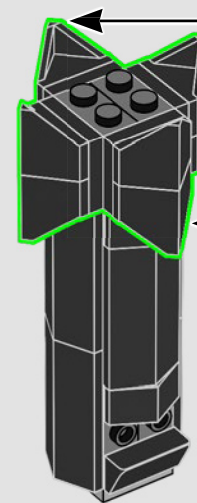
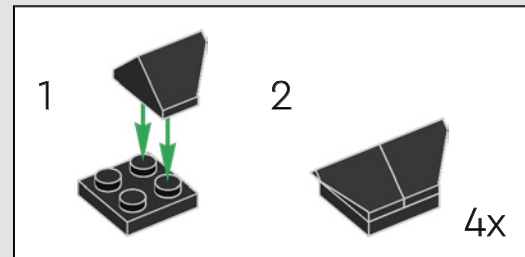



141

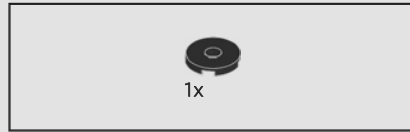
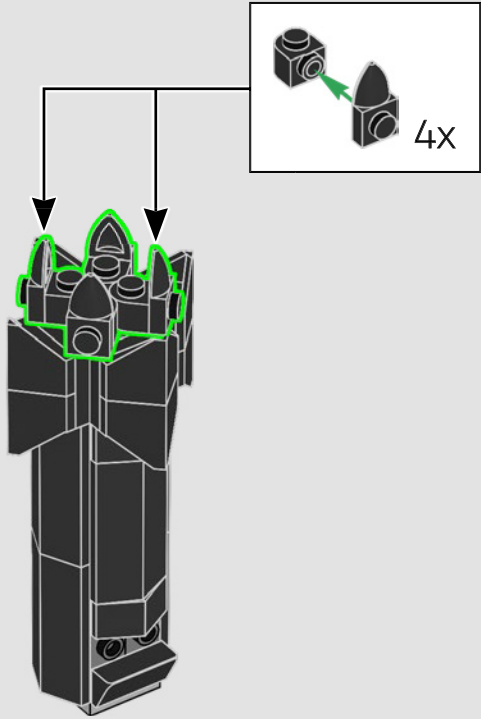

142

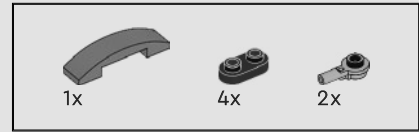
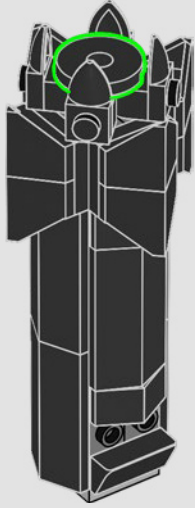

143

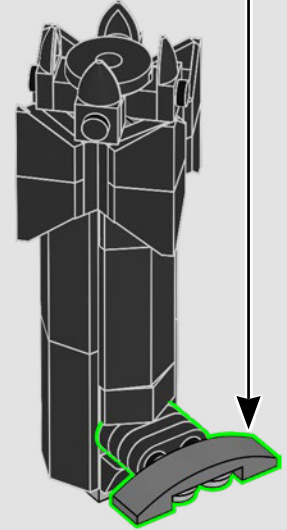
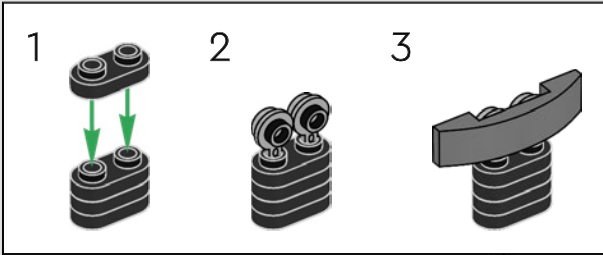

144

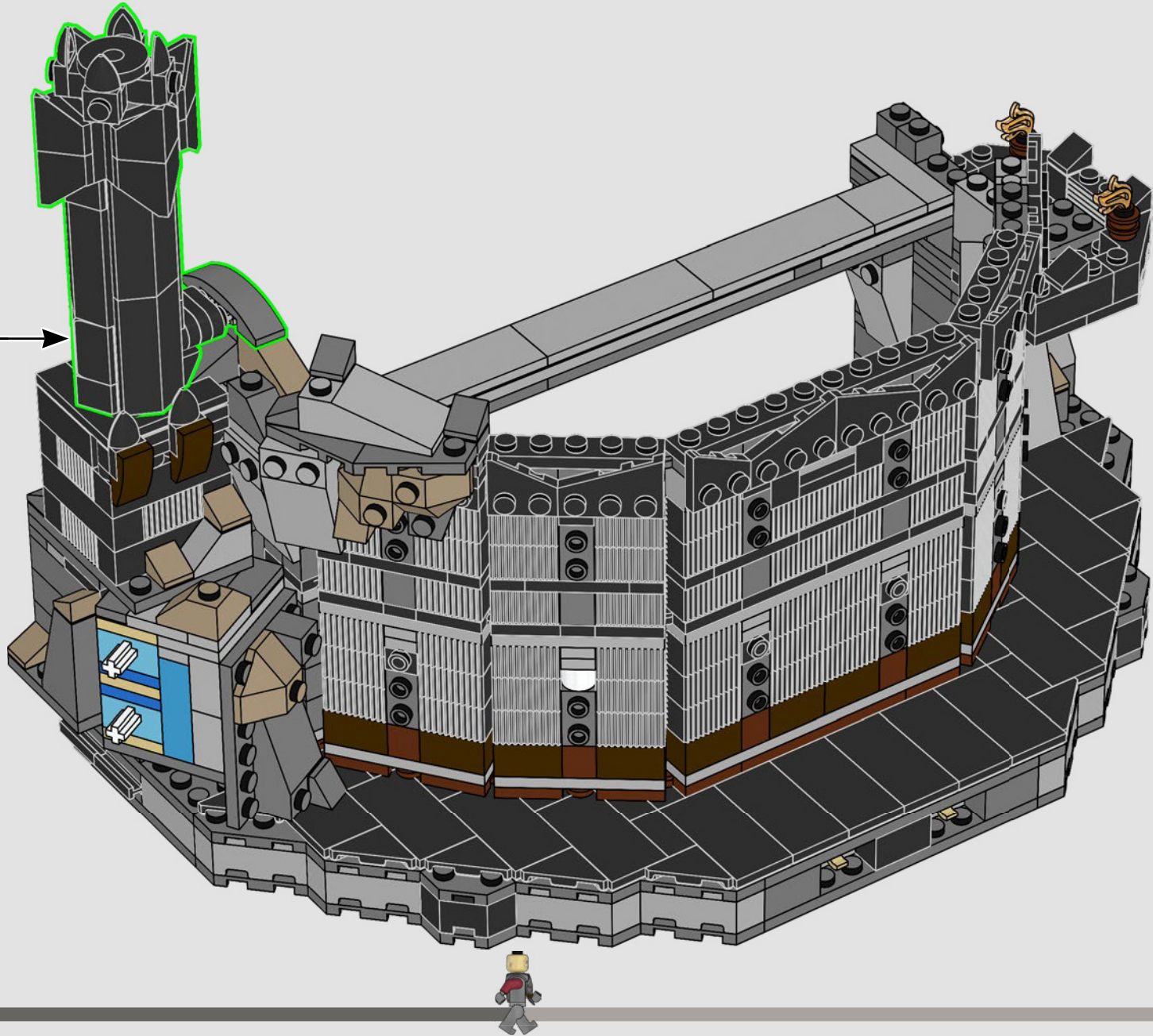

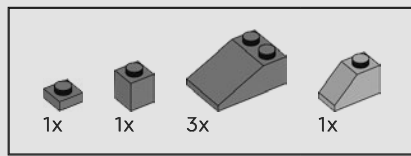

145

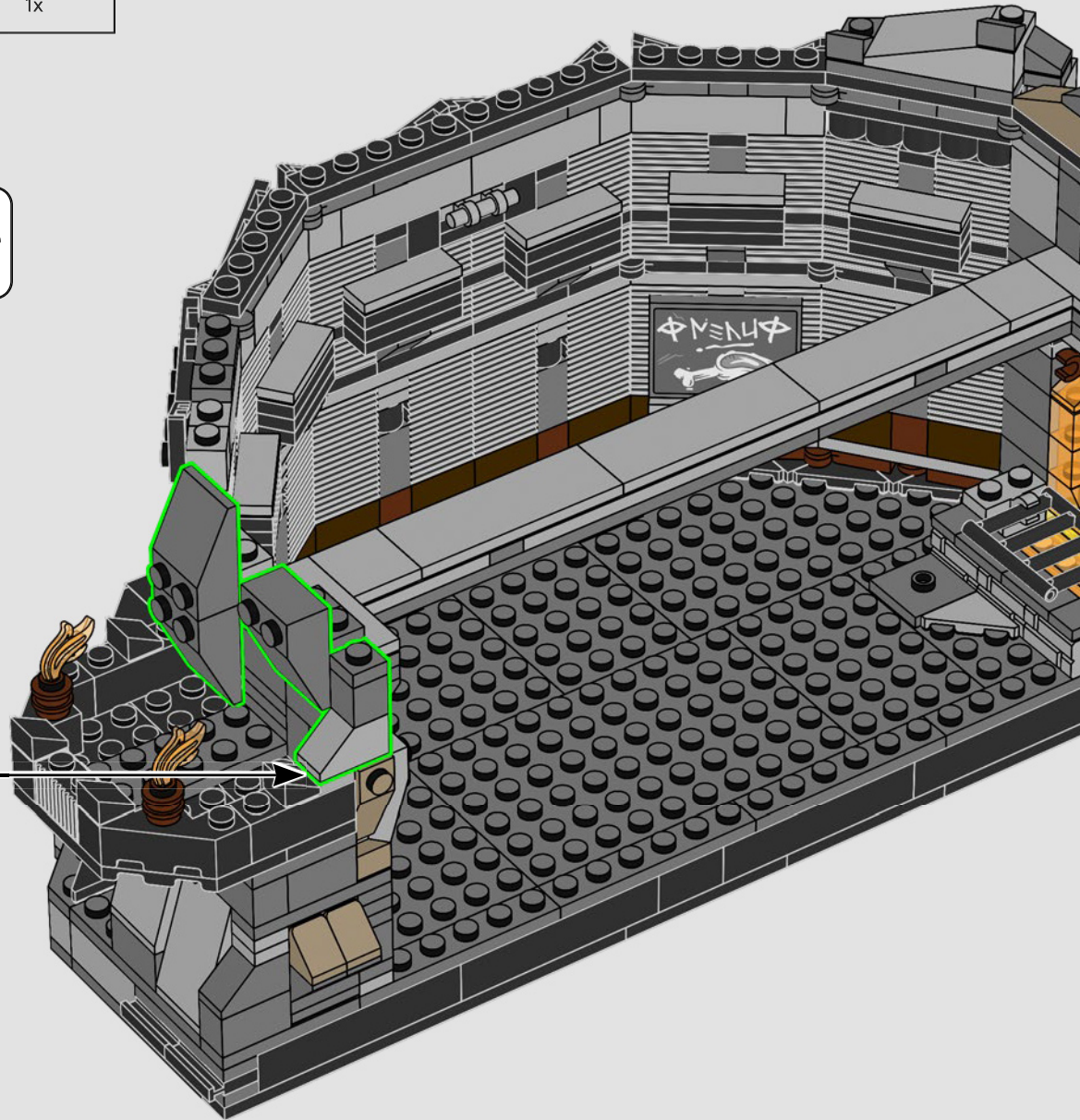
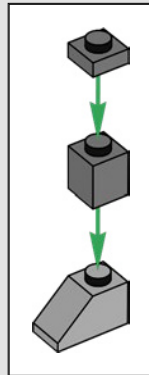

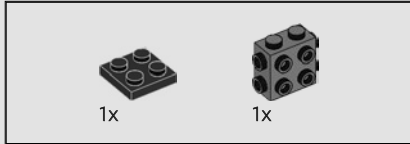
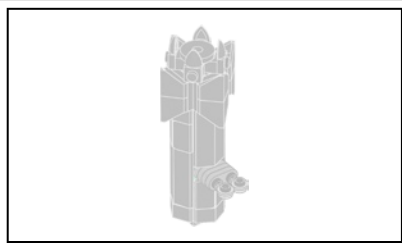

146

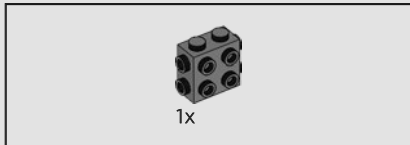
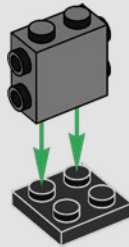

147

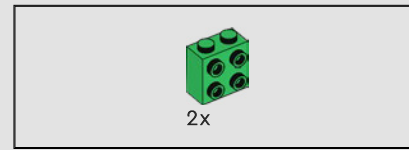

148

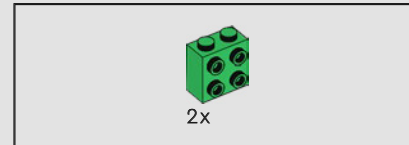
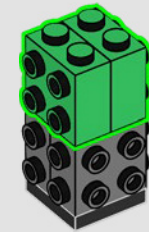

149

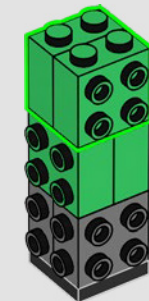

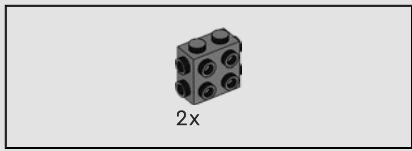

150

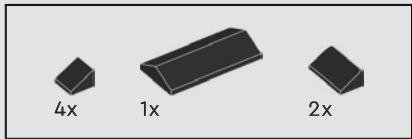
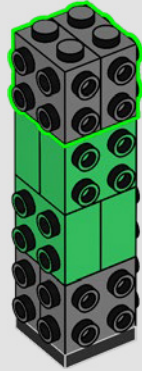

151

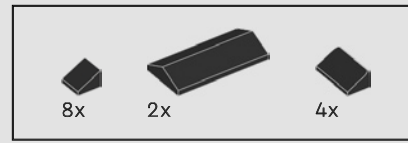
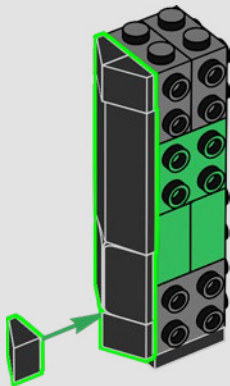

152

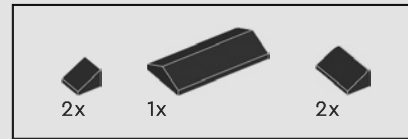
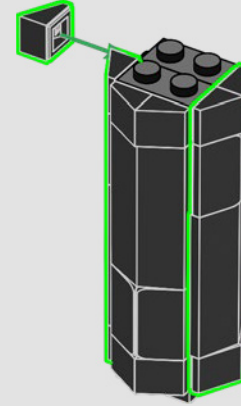

153

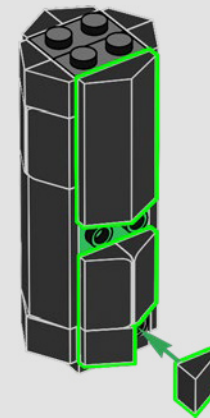
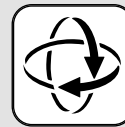

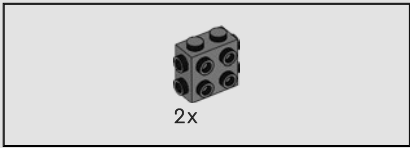

154

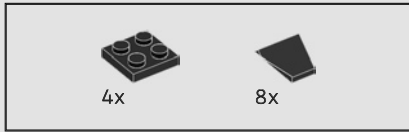
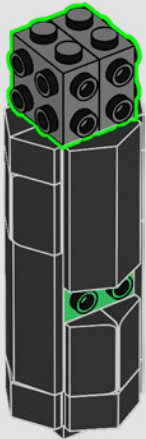

155

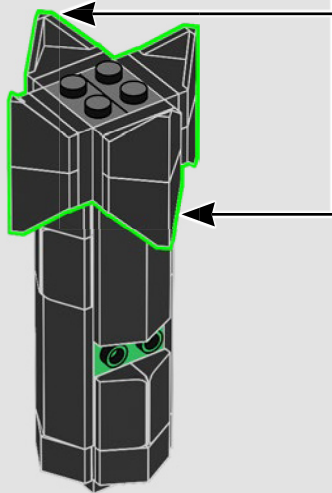
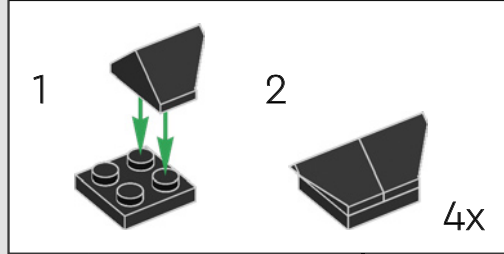

156

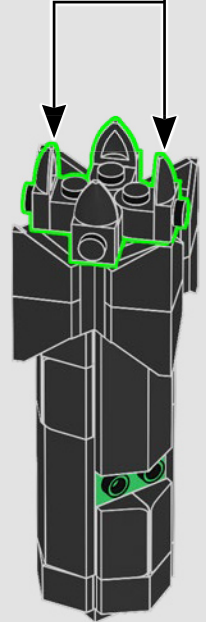
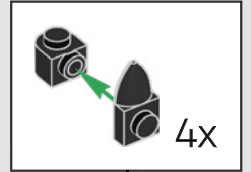



1x

157

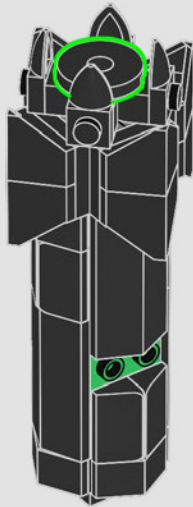

4x



2x

158

1

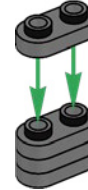

2

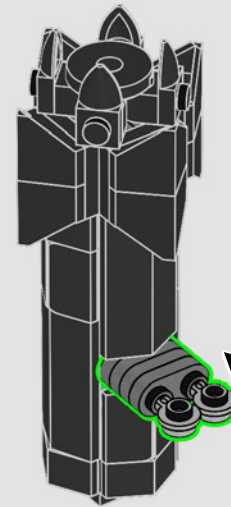

159

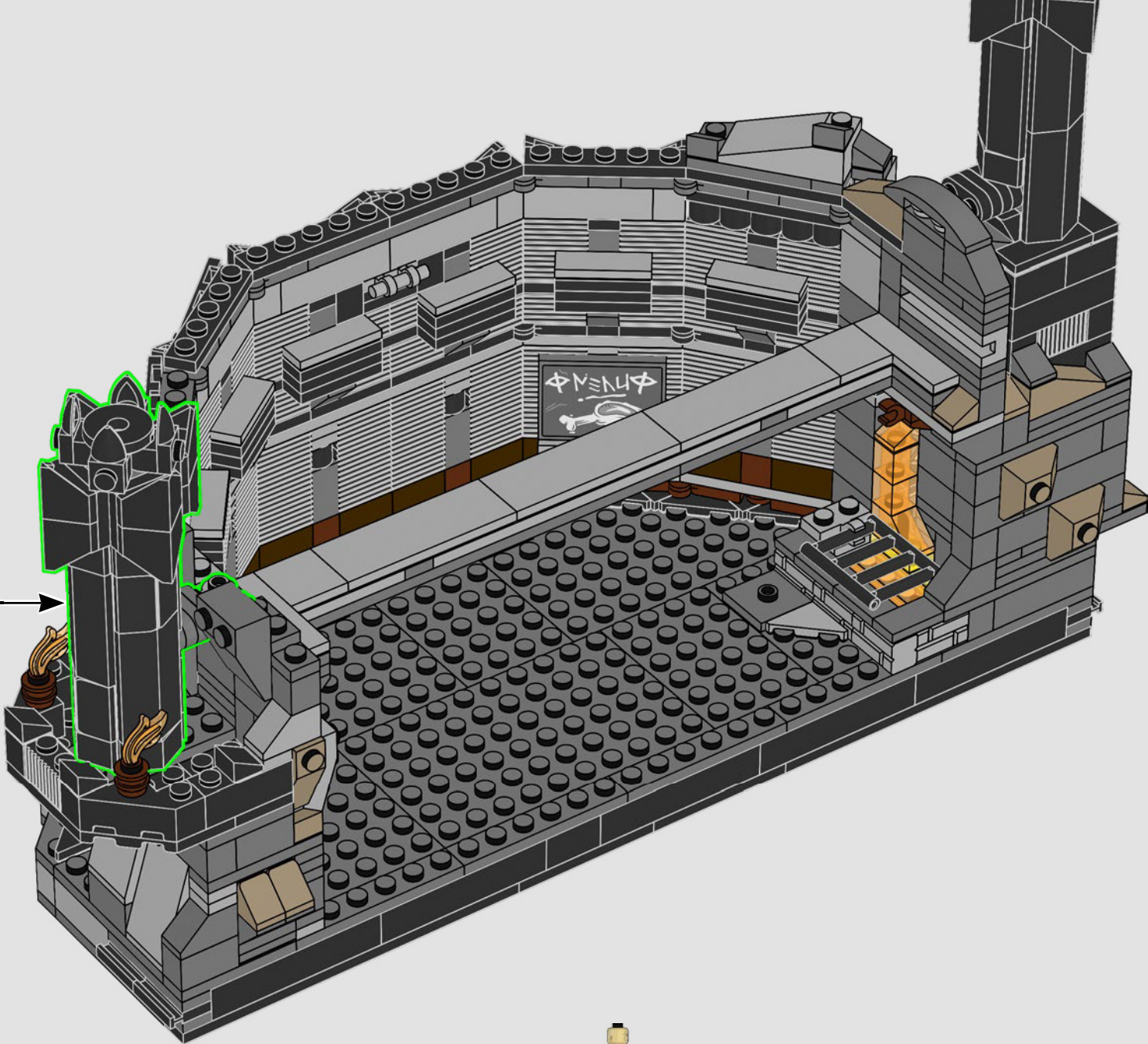

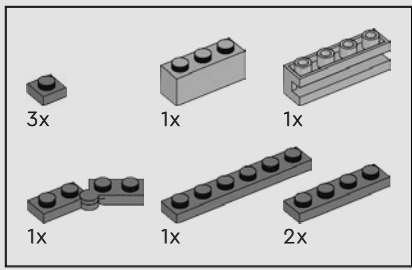

160

1

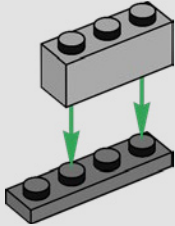

2

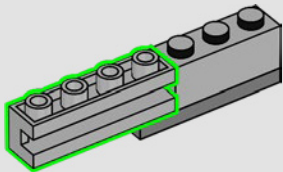

3

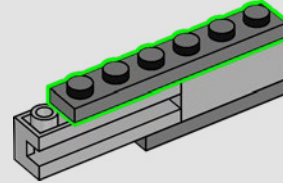

4

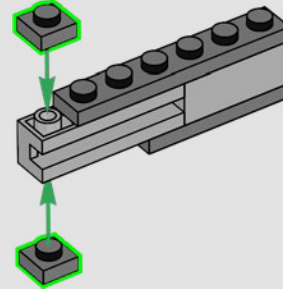

5

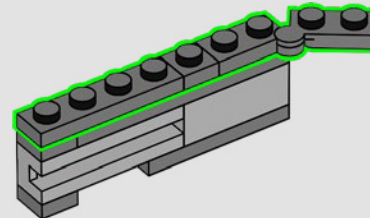

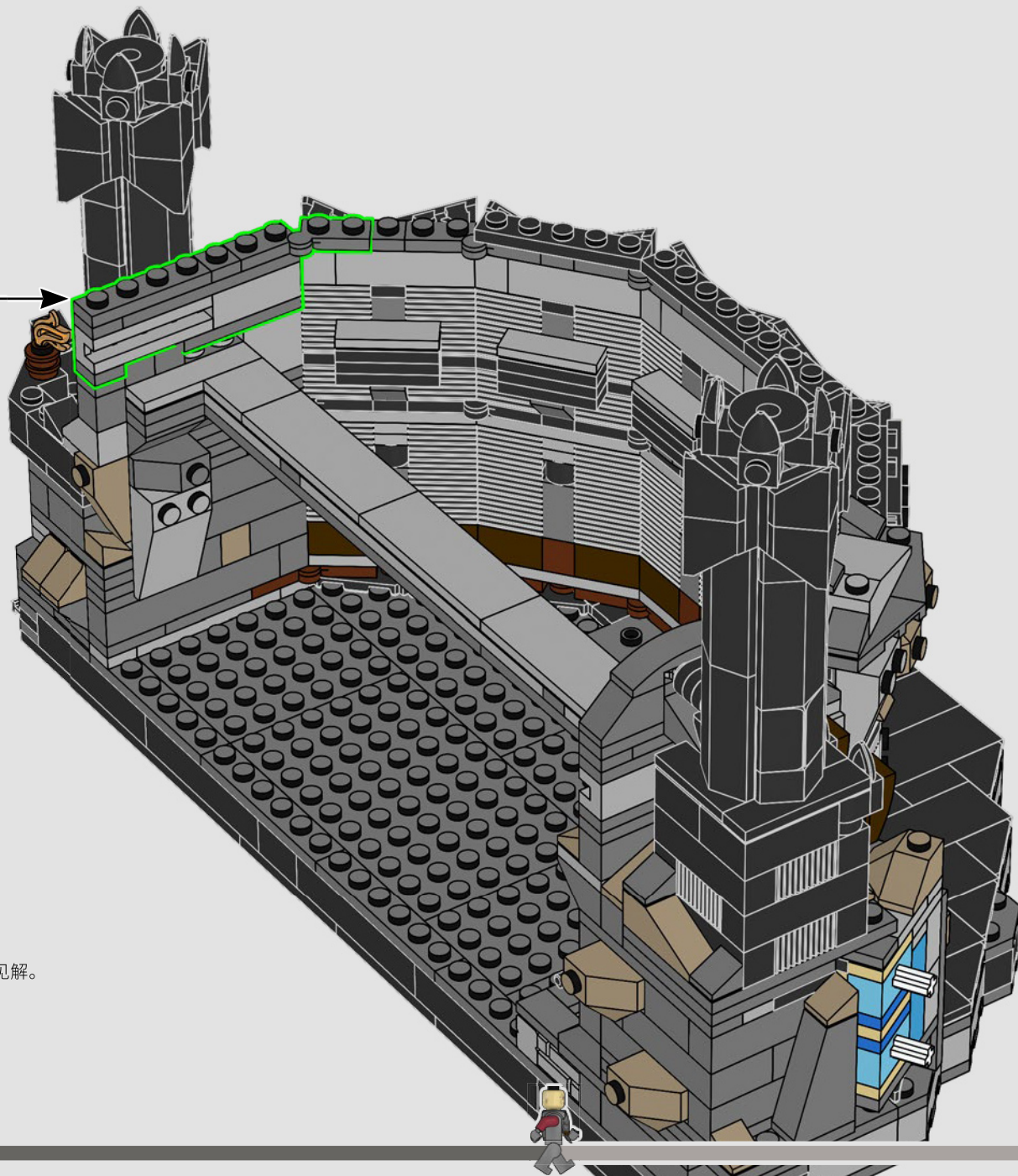

这座堡垒黑暗、尖锐，看似高大无比，反映了索伦的性格以及他对自己形象的见解。

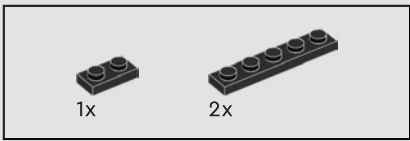

161

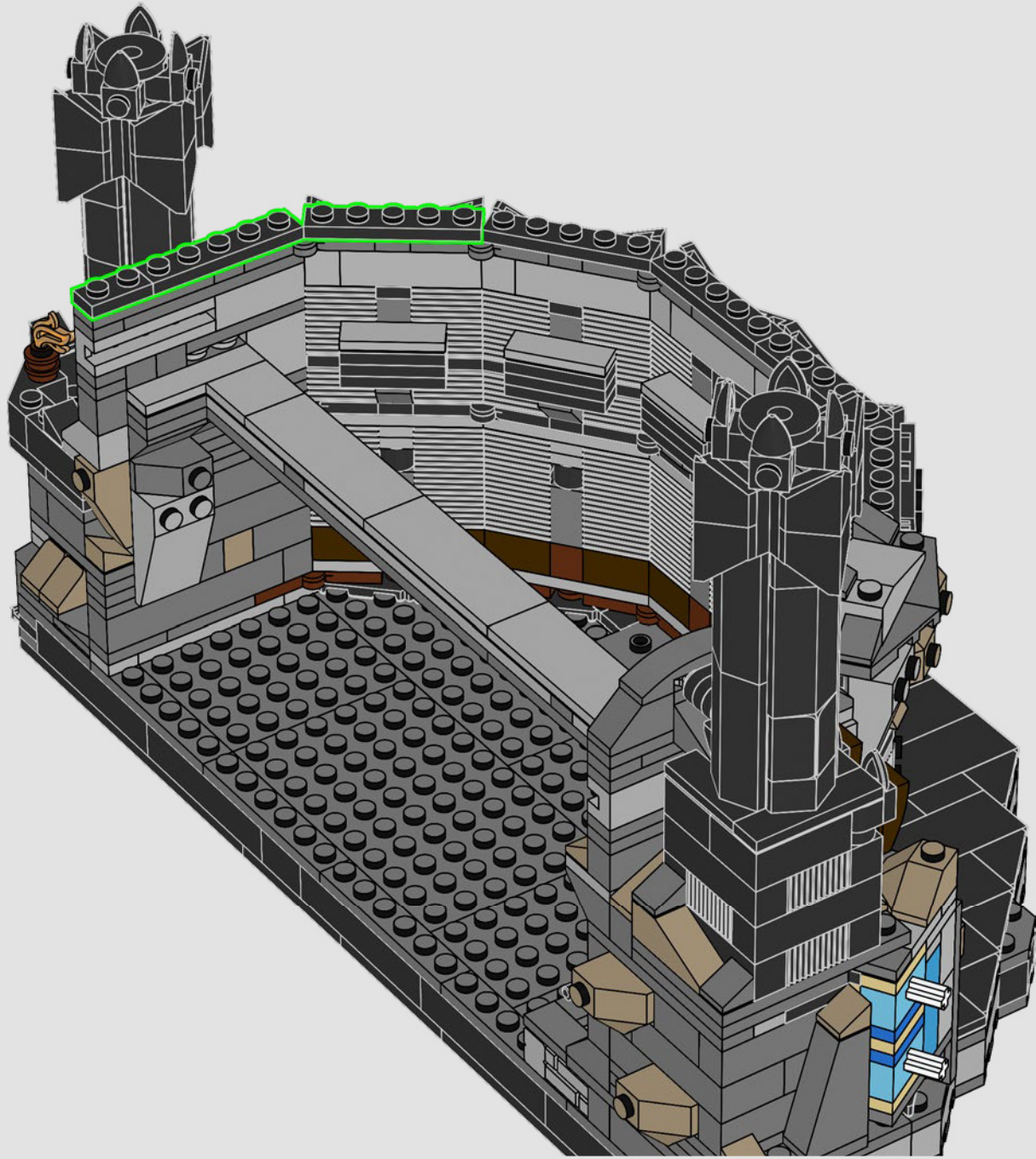

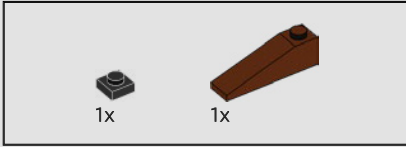
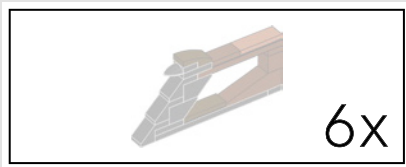

162

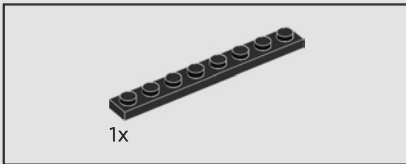
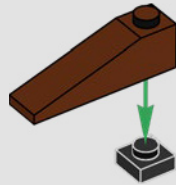

163

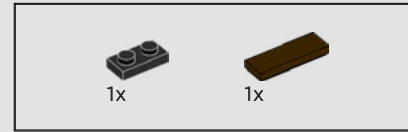
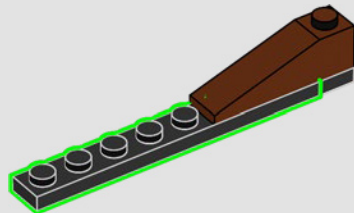

164

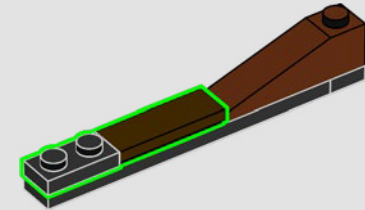

165

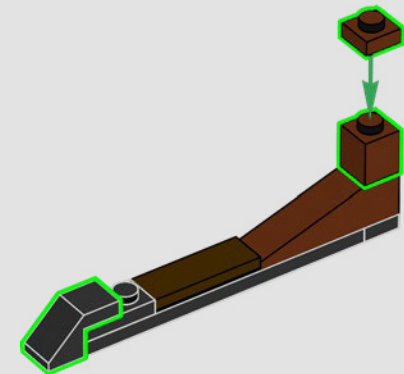



166

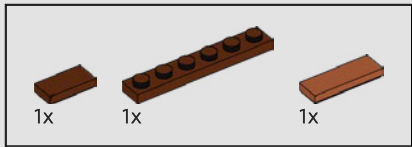
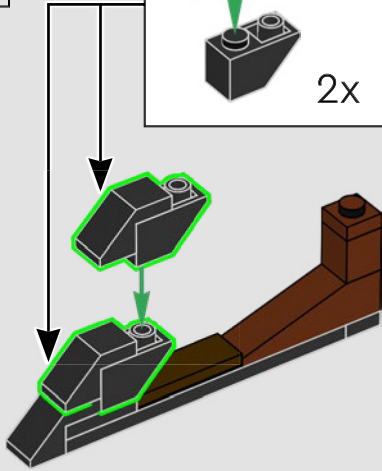
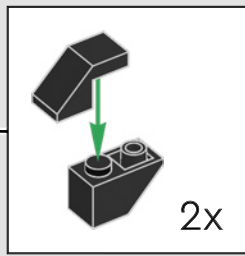

167

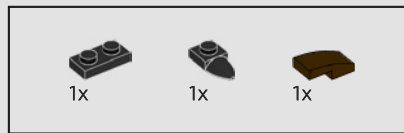
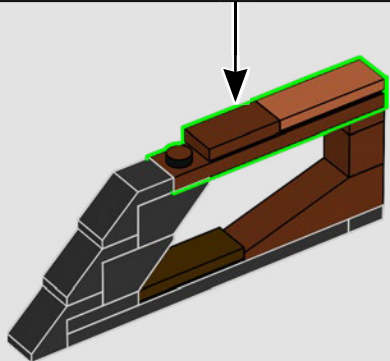
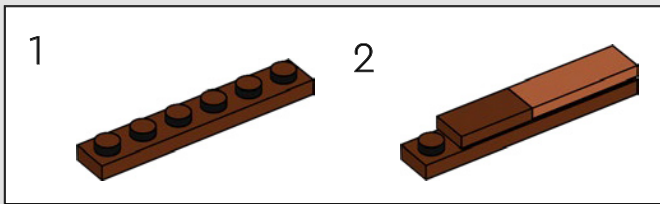

168

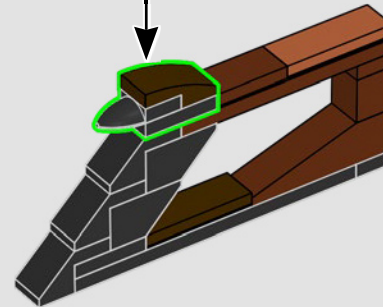
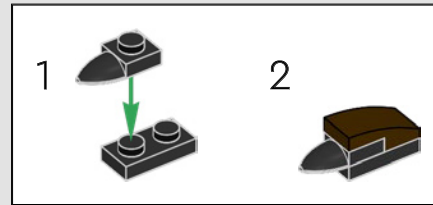

6x

169

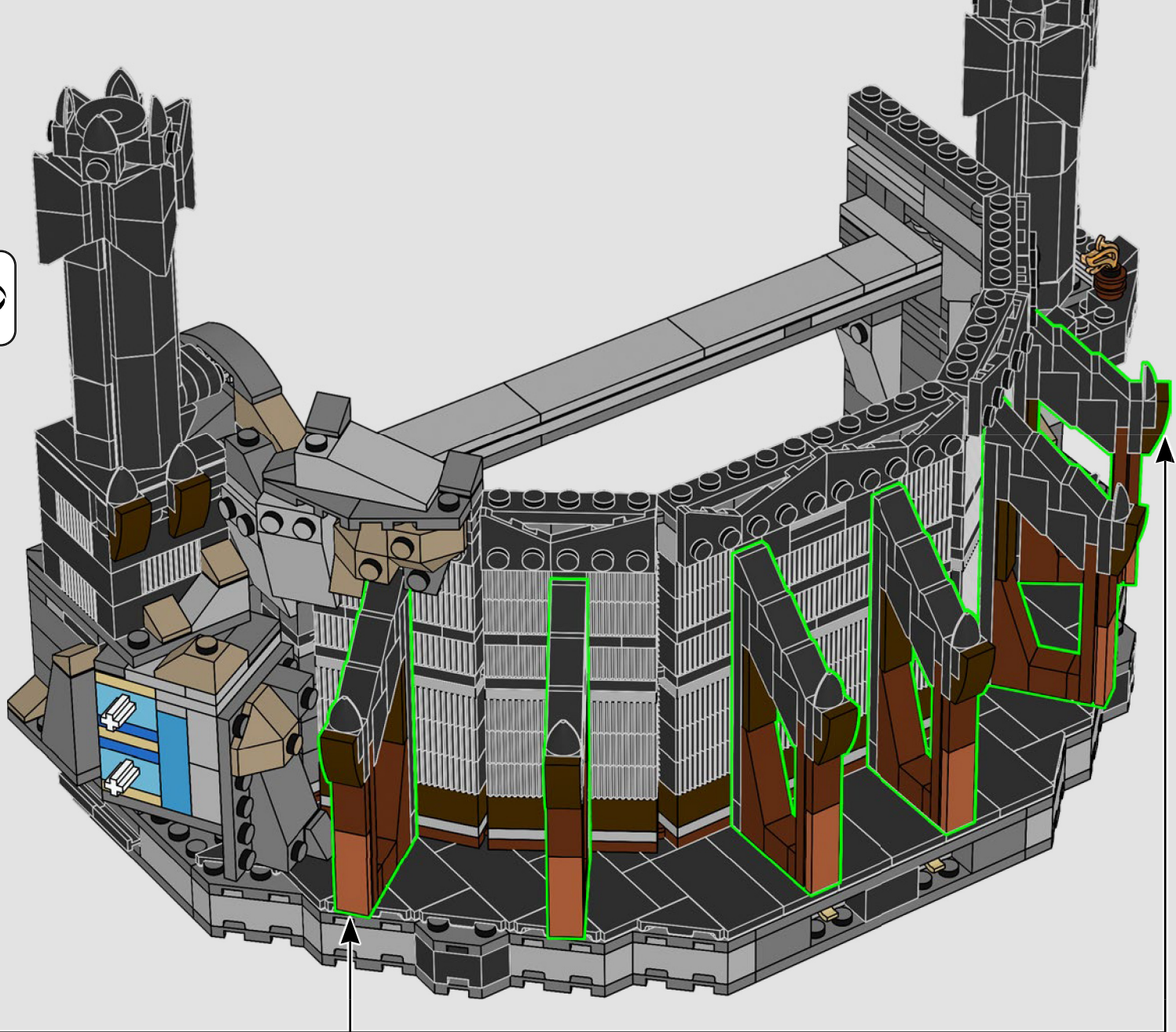



专为此模型设计了全新的盾牌，
从这里可以看到忙碌的半兽人正在锻造它们。

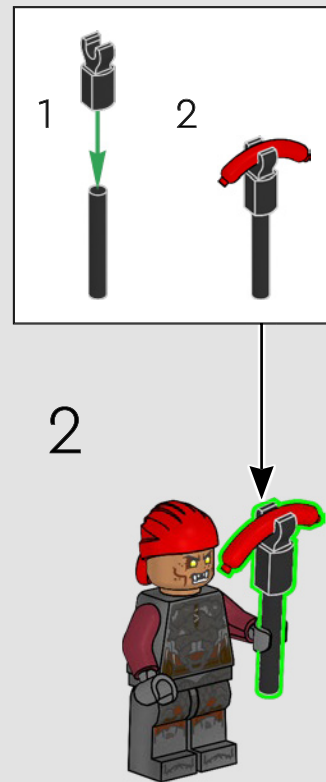
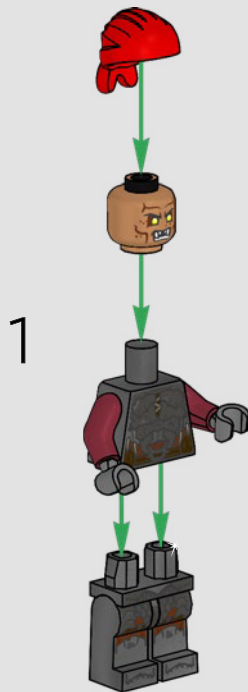
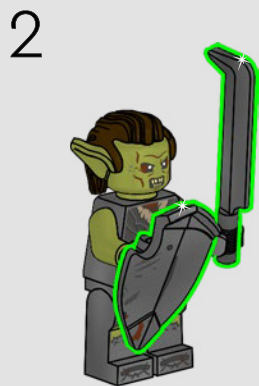
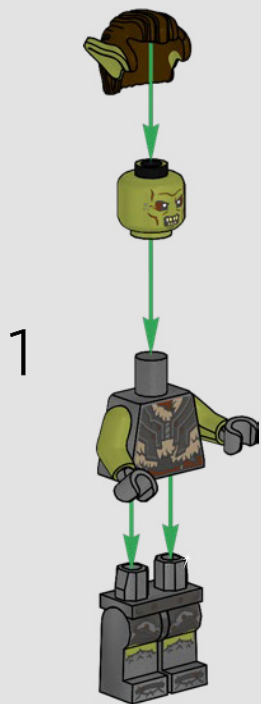

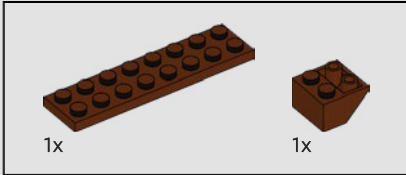
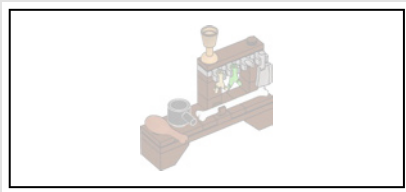

170

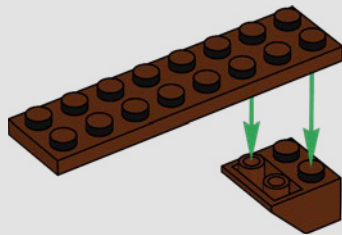

171

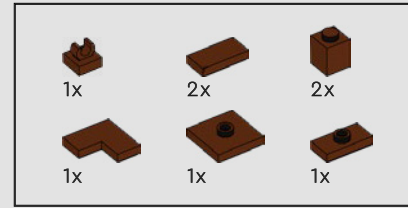
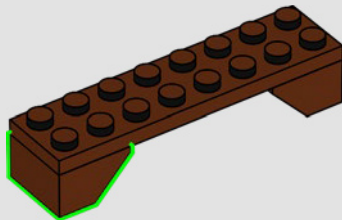

172

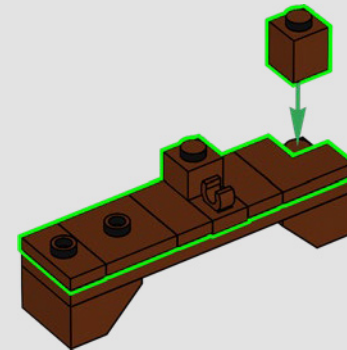

173

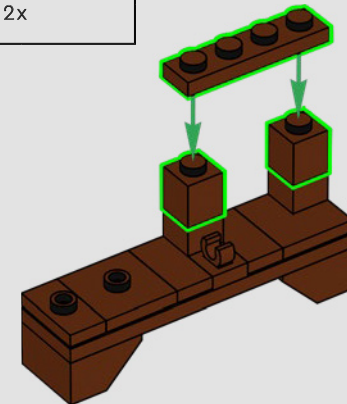

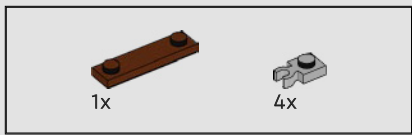

174

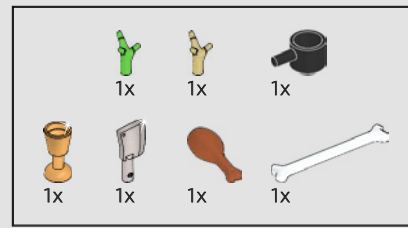
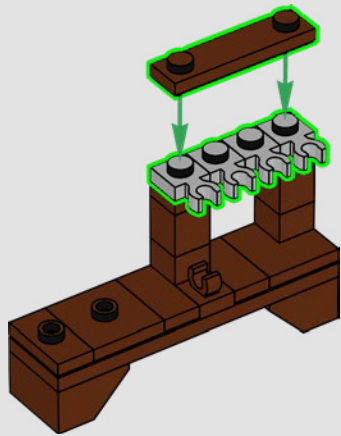

175

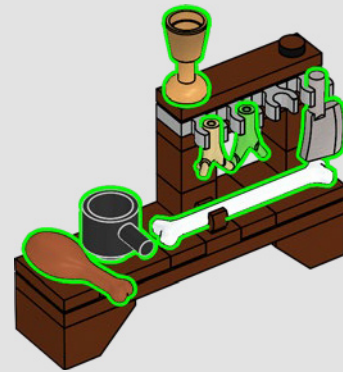

176

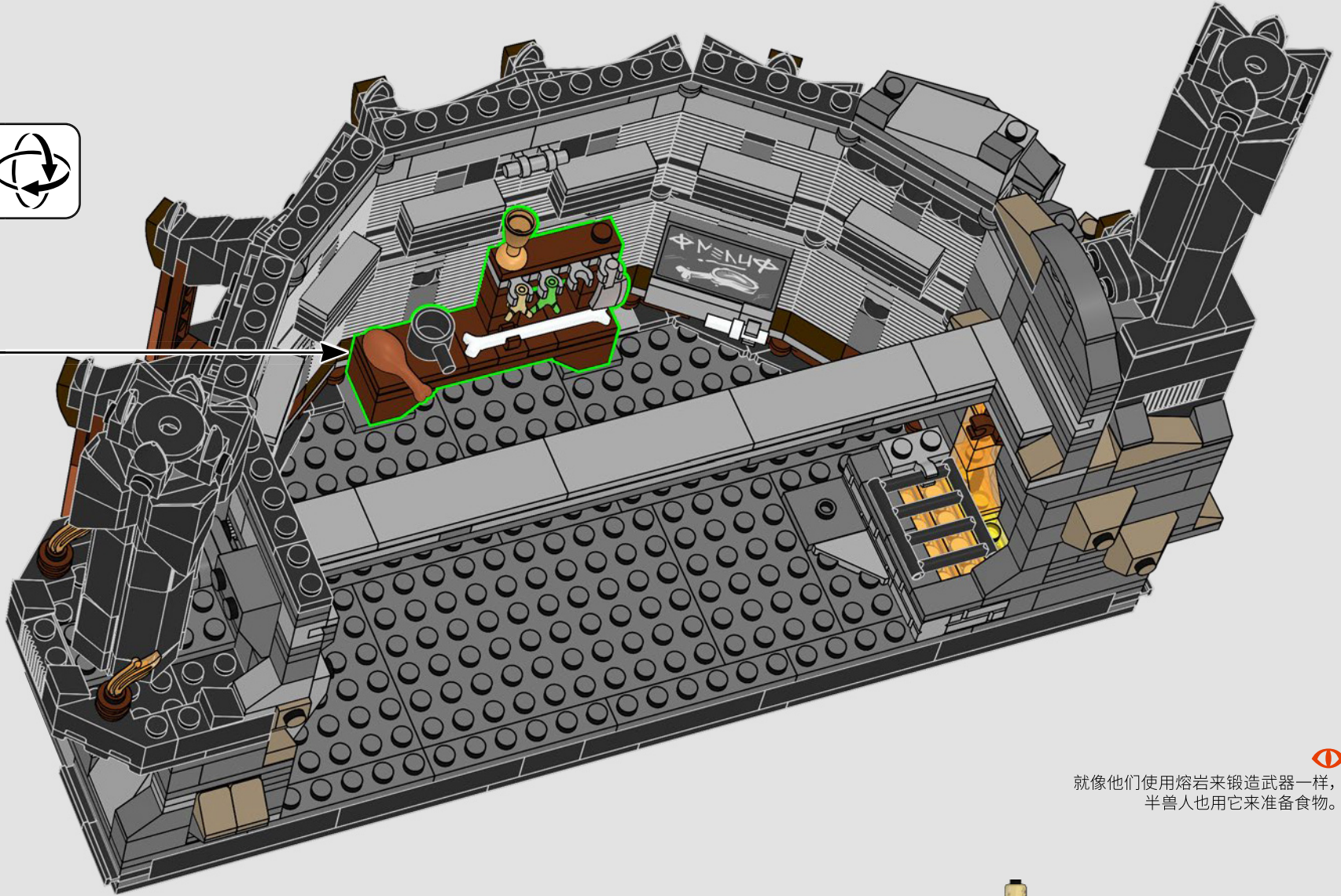

 就像他们使用熔岩来锻造武器一样，半兽人也用它来准备食物。



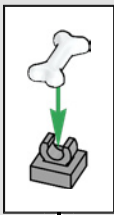
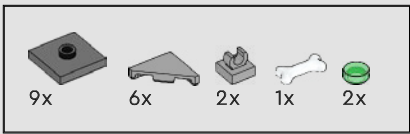

177

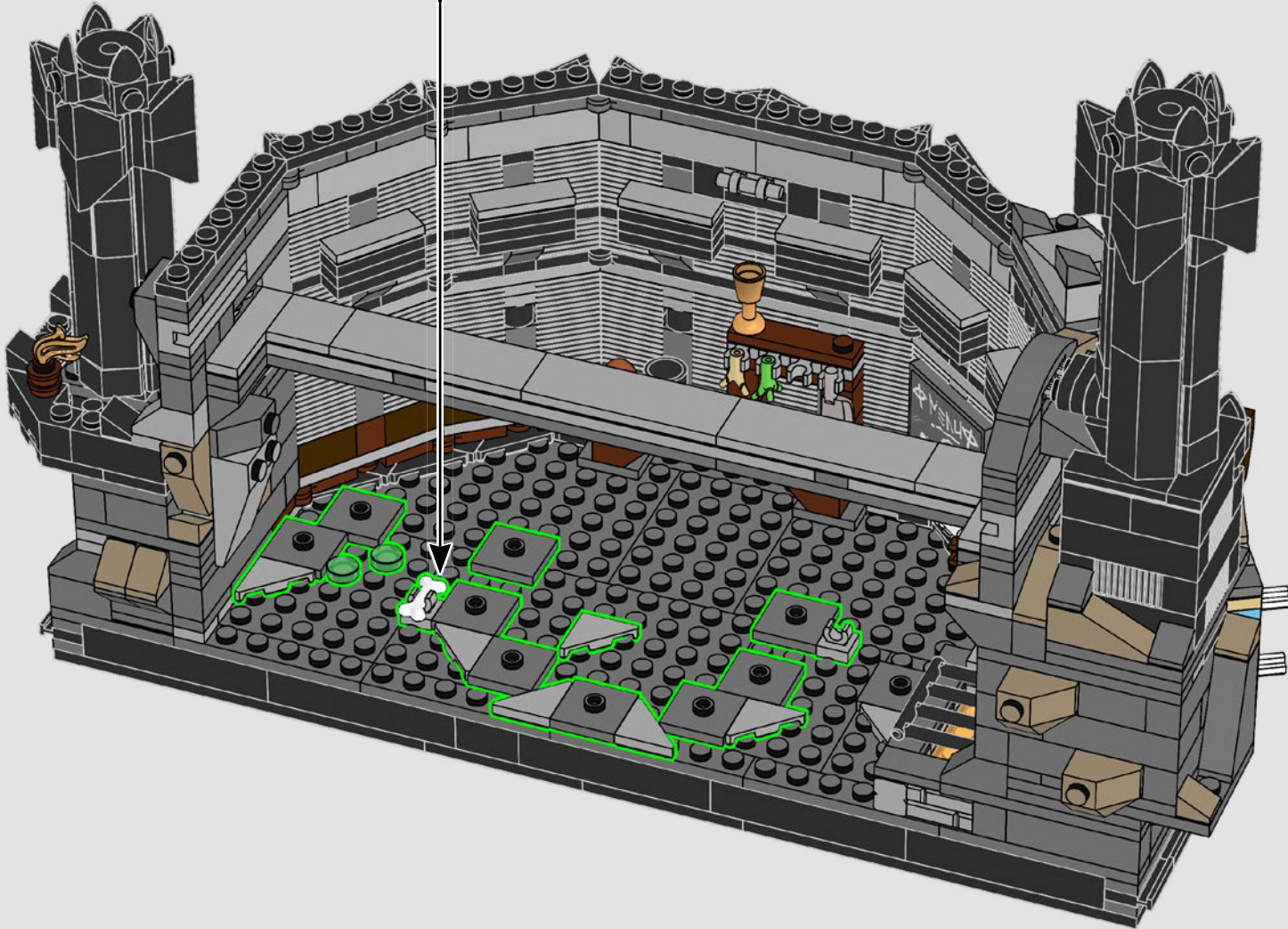

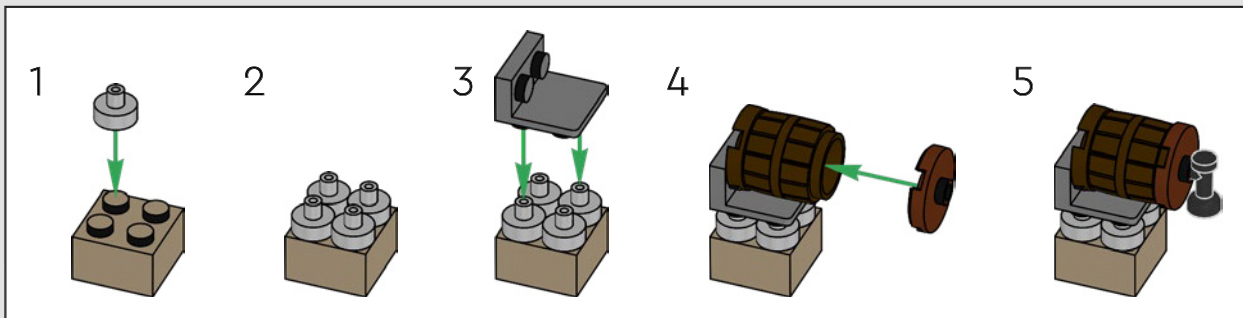
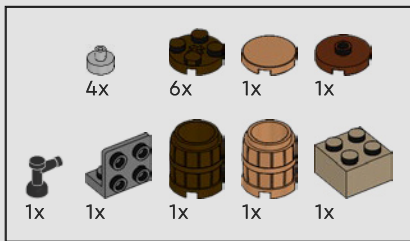

178

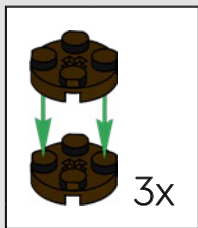
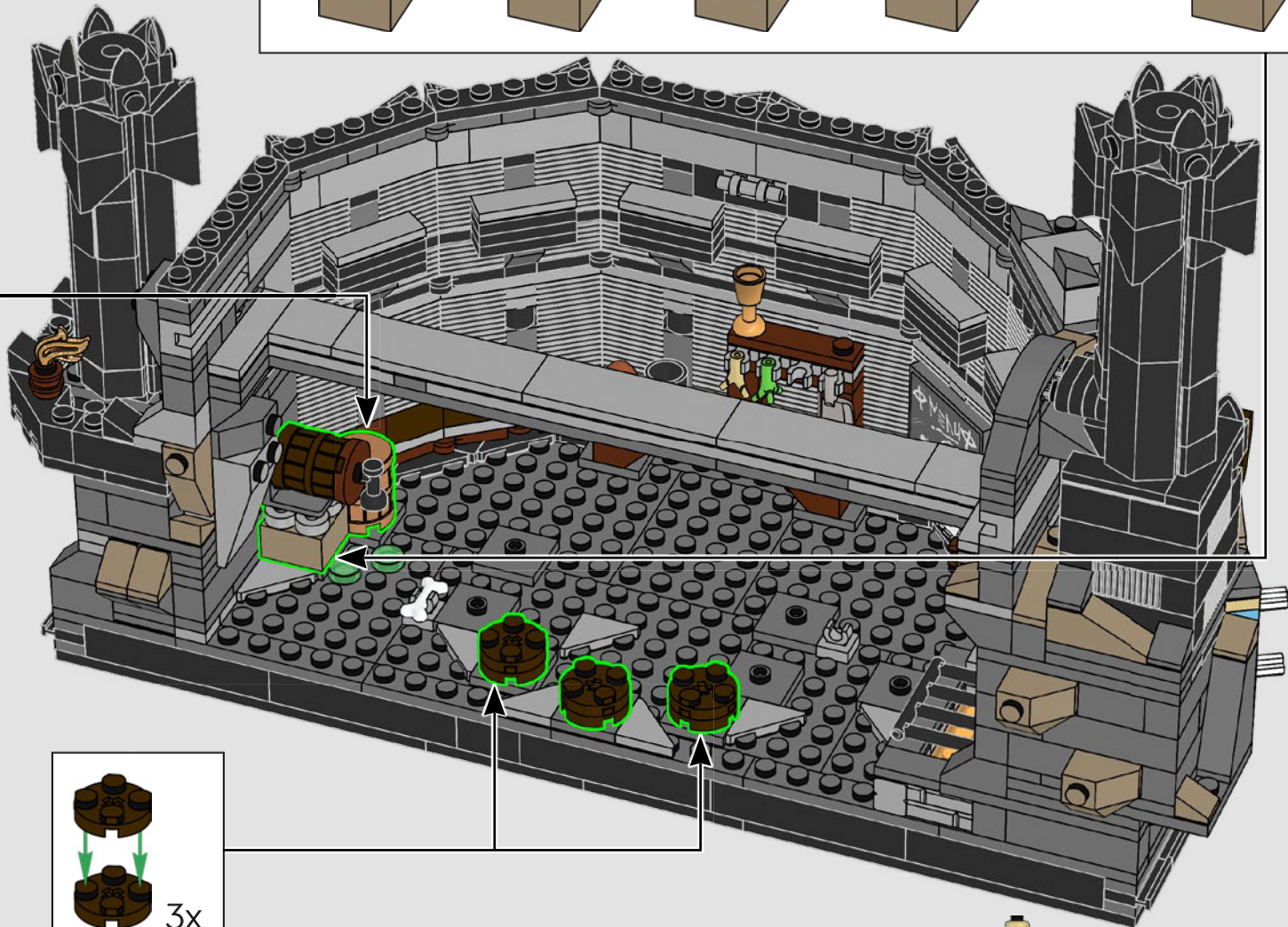
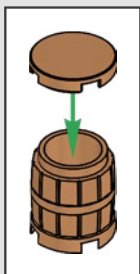

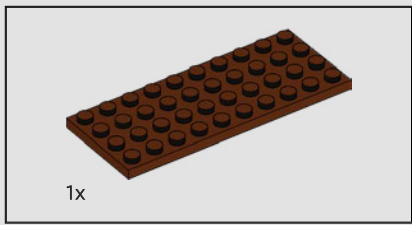

179

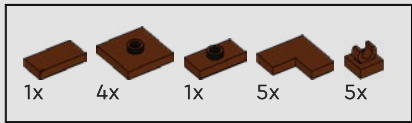
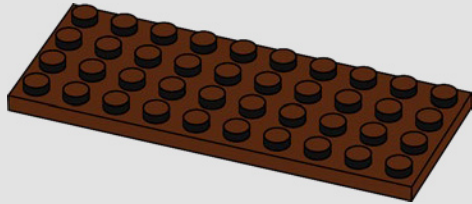

180

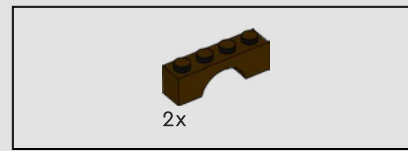
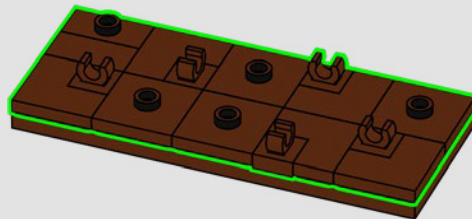

181

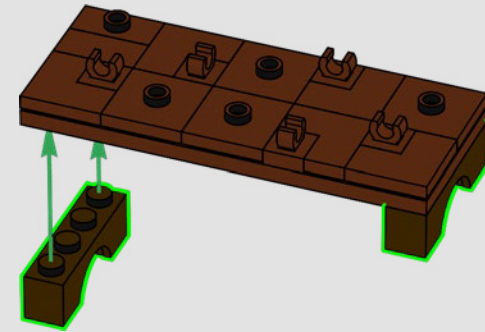

182

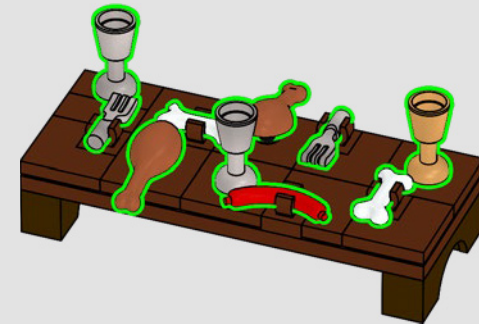

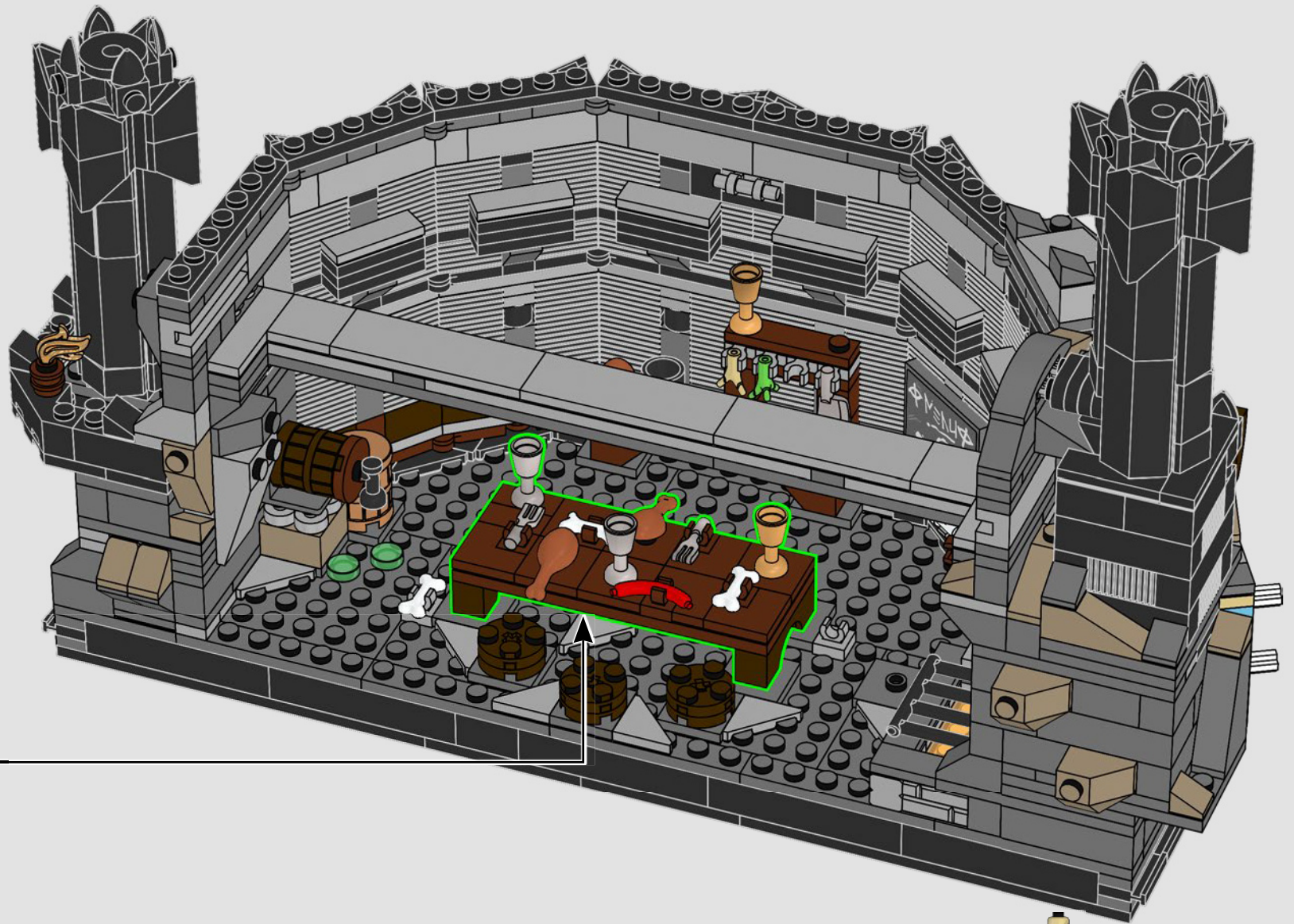

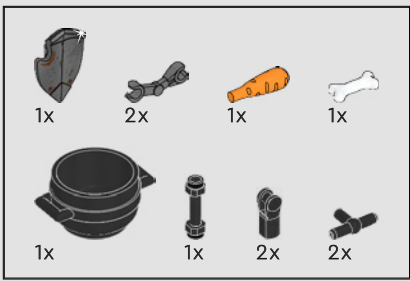

184

1



2

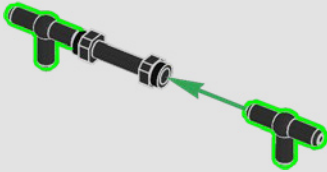

3

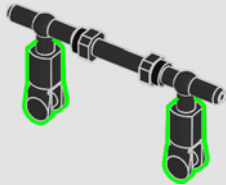

4

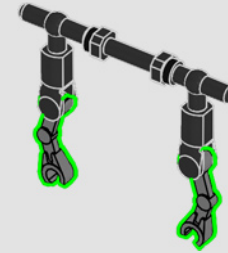

5

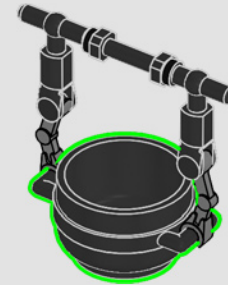

6



没有人知道胡萝卜是如何进入半兽人菜单的。

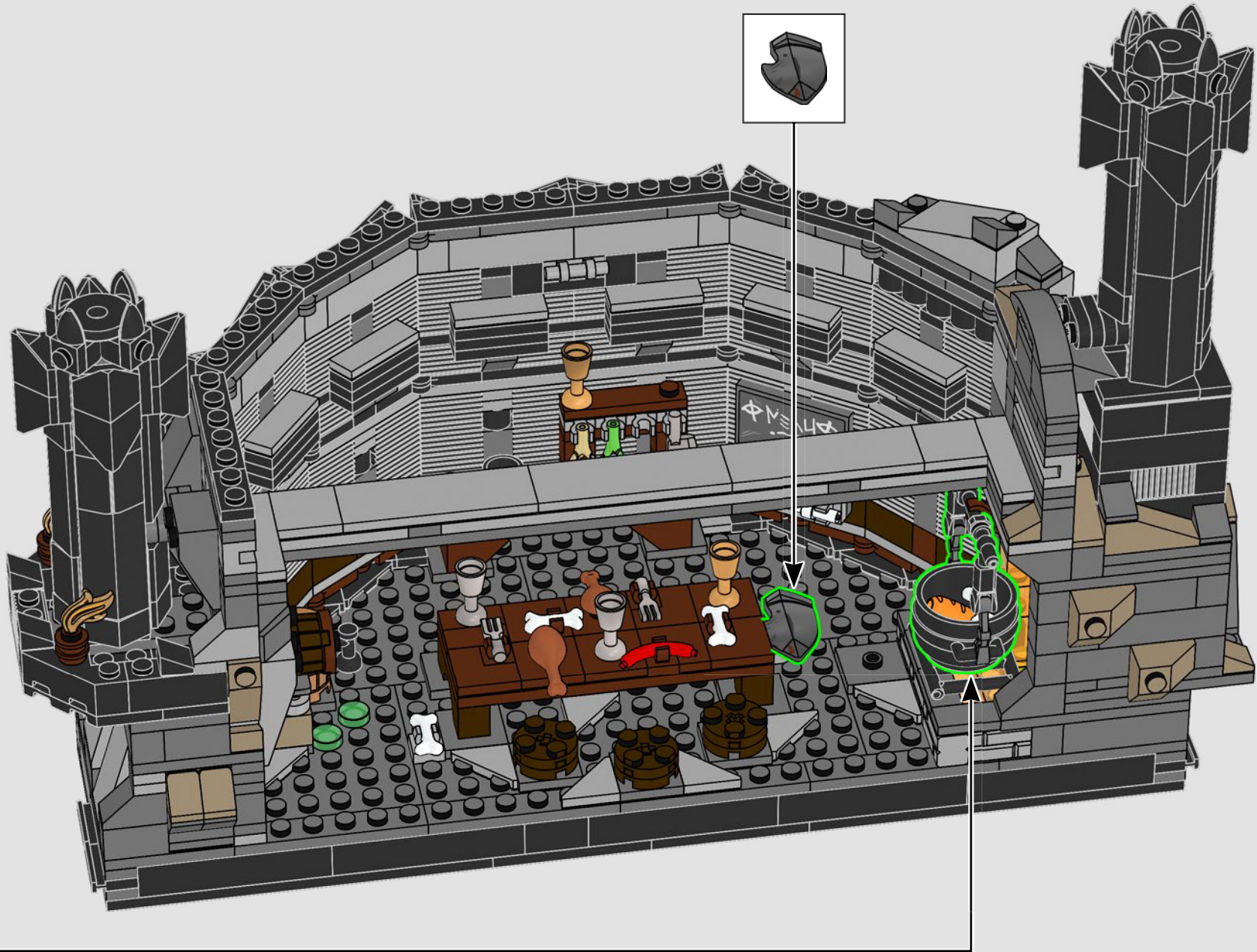

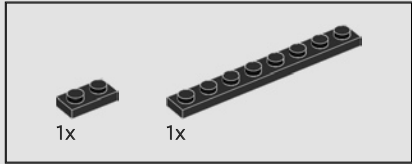
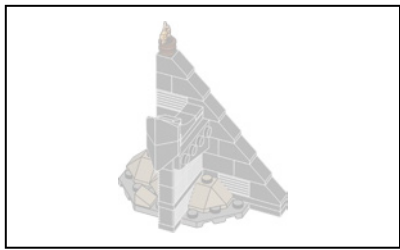

185

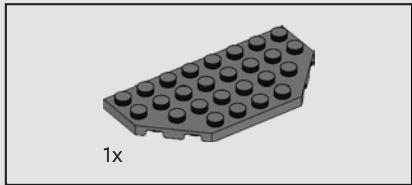
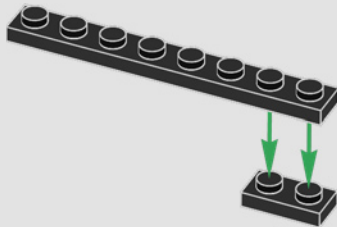

186

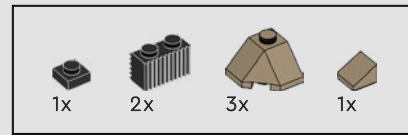
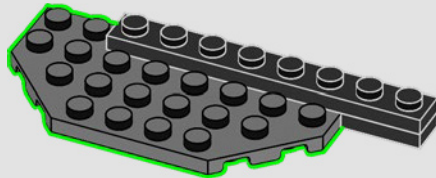

187

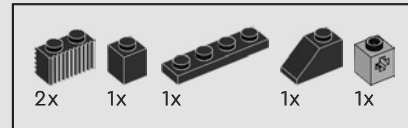
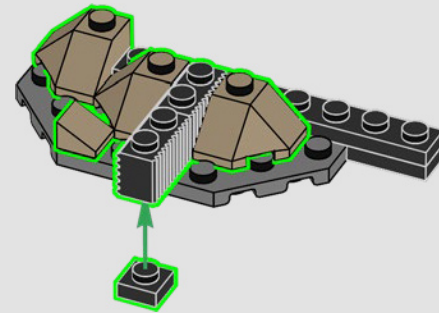

188

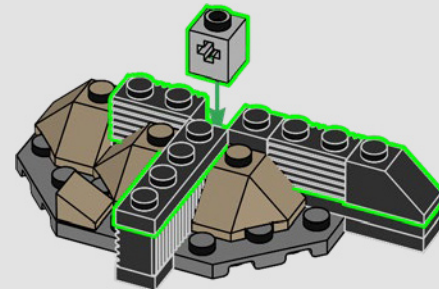

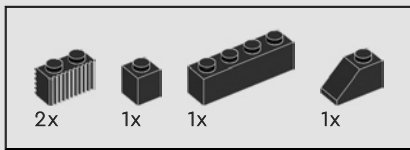

189

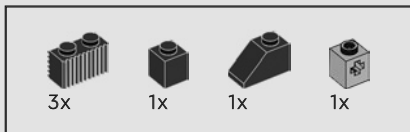
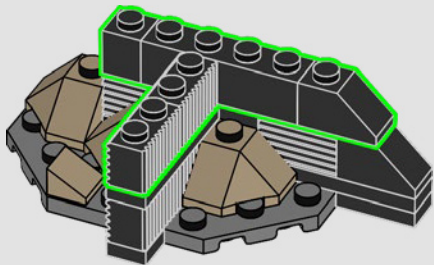

190

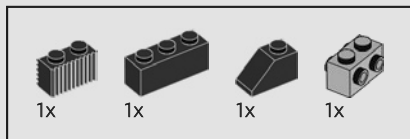
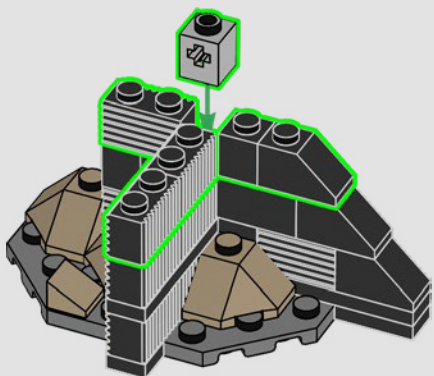

191

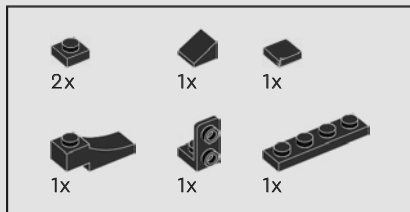
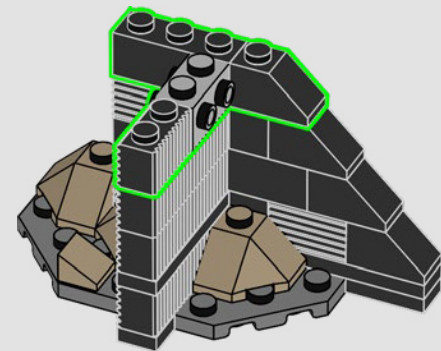

192

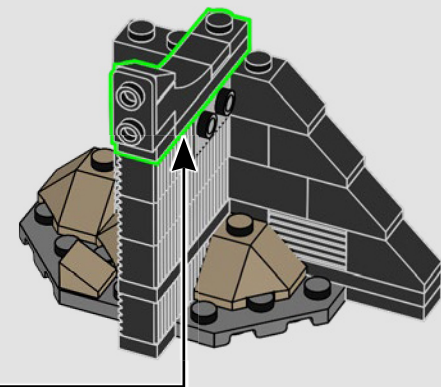
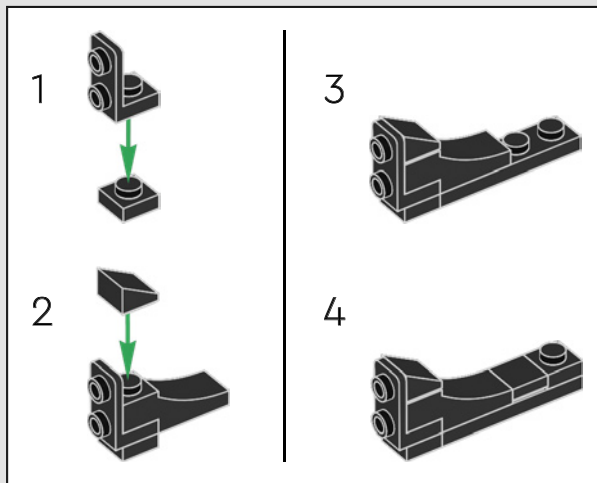

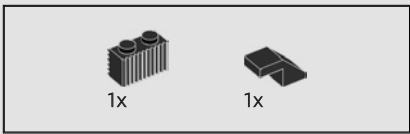

193

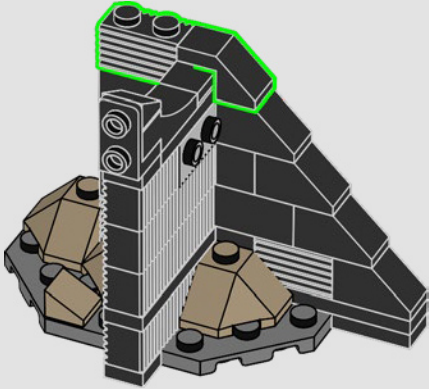

194

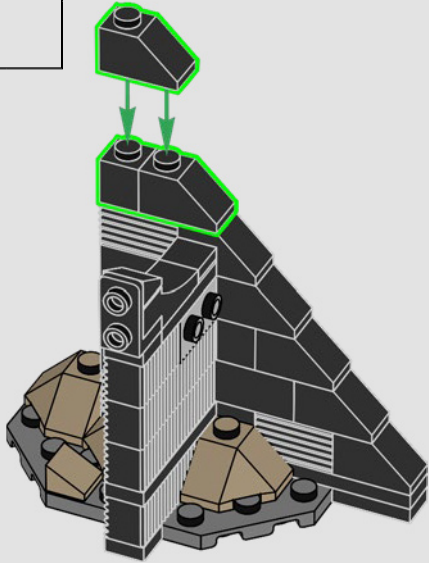

195

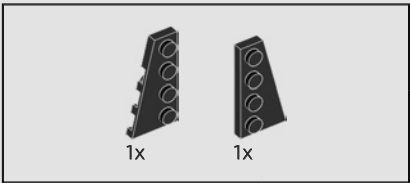
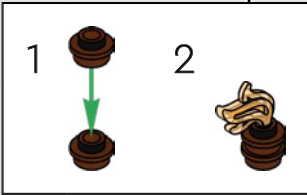
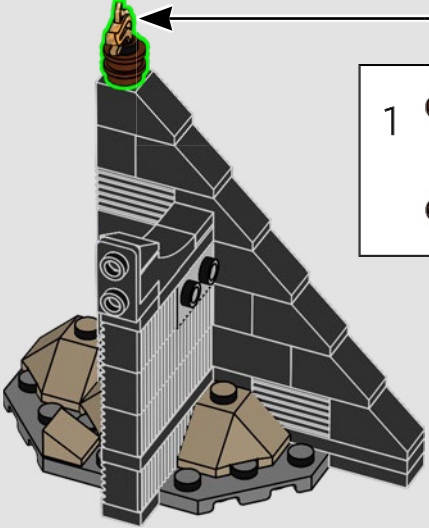

196

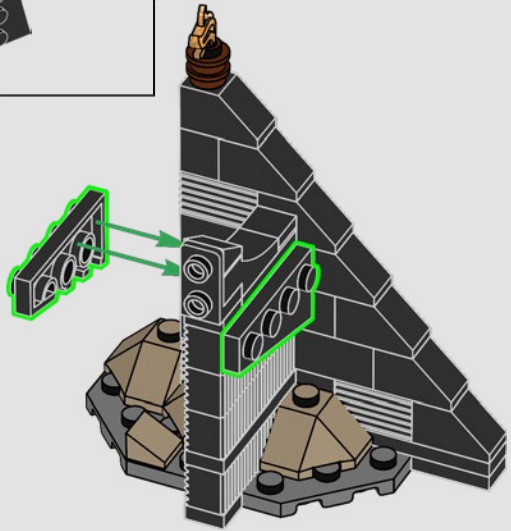



197

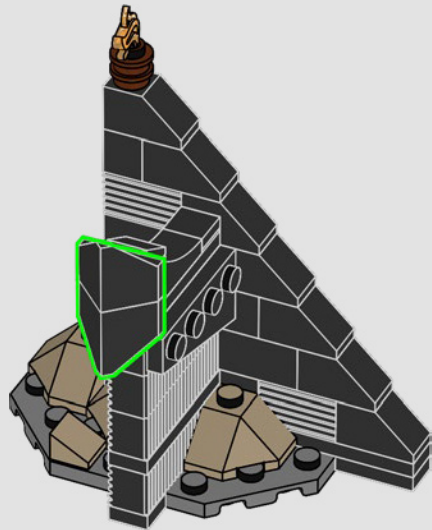

198

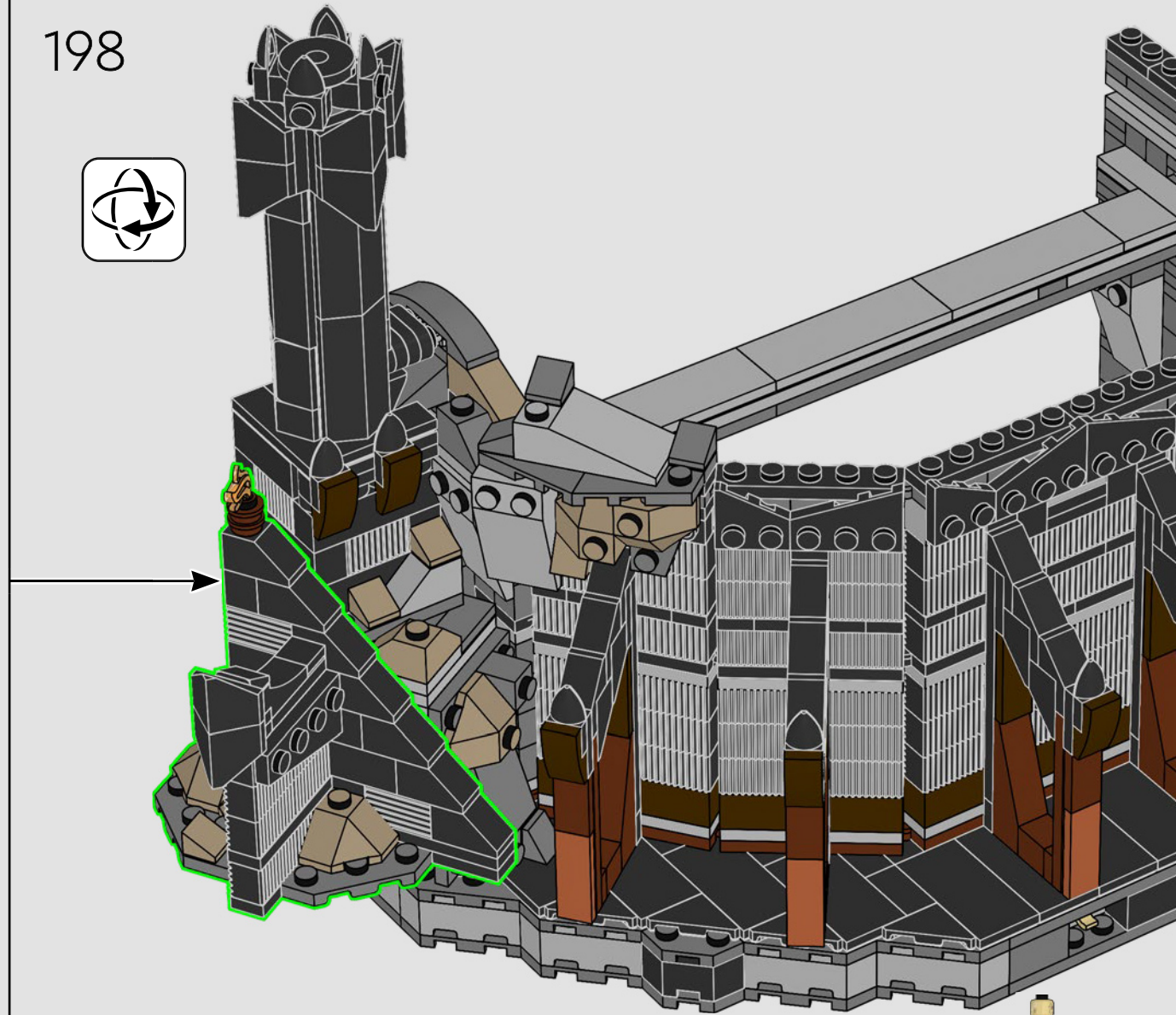
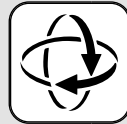

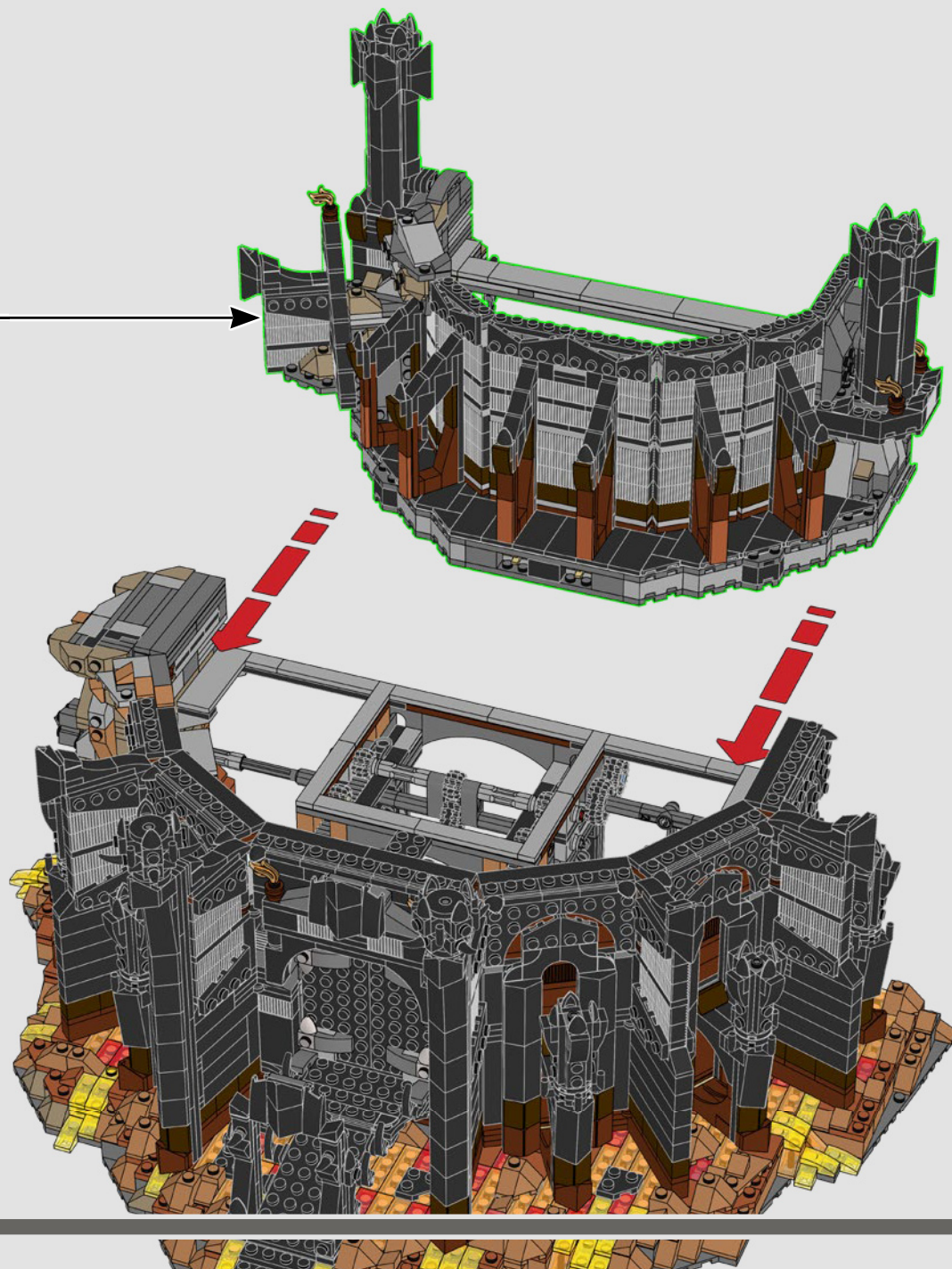

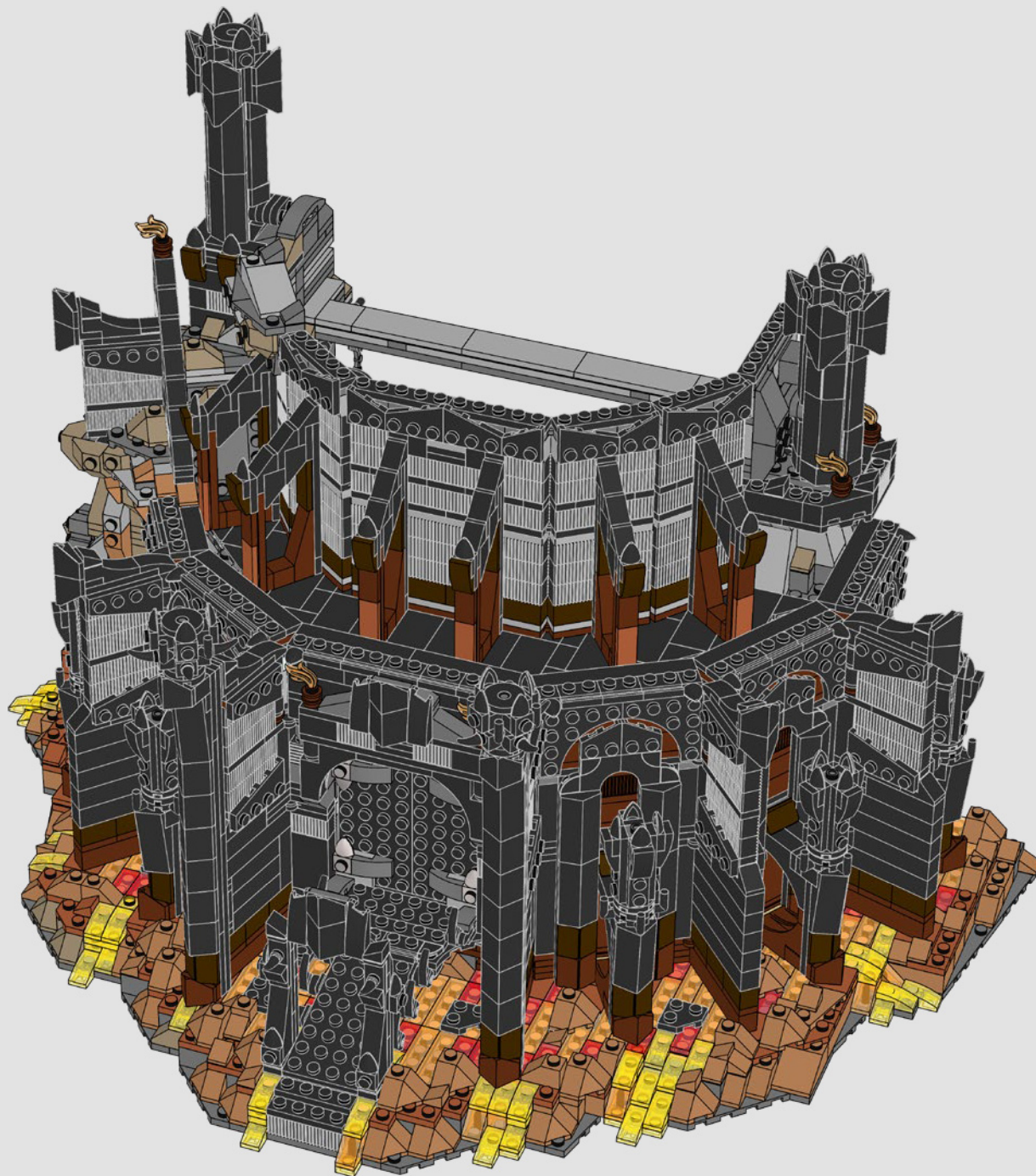



LEGO and the LEGO logo are trademarks of the LEGO Group. ©2024 The LEGO Group.



© New Line Productions Inc. All rights reserved.
THE LORD OF THE RINGS TRILOGY and all names
of the characters, items, events, and places therein
are ™ of Middle-earth Enterprises, LLC under license
to New Line Productions, Inc. (s24)