



Booklet available in English on
Livret disponible en français sur
Folleto disponible en español en



WE'RE MAKING OUR PACKAGING MORE SUSTAINABLE

We're transitioning from single-use plastic to paper-based packaging. As we progress, you may find a mix of paper and plastic in our boxes.

NOUS RENDONS NOS EMBALLAGES PLUS DURABLES

Nous passons des emballages en plastique à usage unique aux emballages à base de papier. Durant la transition, vous pourriez trouver un mélange de papier et de plastique dans nos boîtes.

QUEREMOS HACER MÁS SUSTENTABLES NUESTROS MATERIALES DE EMBALAJE

Estamos cambiando las bolsas de plástico desechables por bolsas con base de papel. Conforme avanzamos en este propósito, puedes encontrar una mezcla de papel y de plástico en nuestras cajas.

LEGO.com/sustainable-packaging

LEGO® VIP

- 1.** SIGN UP
INSCRIVEZ-VOUS
REGÍSTRATE

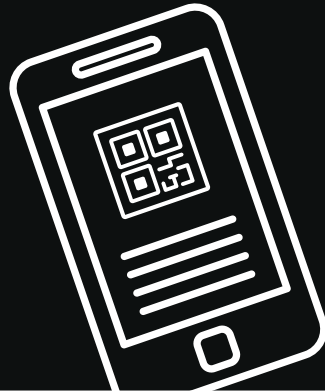

- 2.** EARN POINTS
FOR PURCHASES
GAGNEZ DES POINTS
POUR VOS ACHATS
GANA PUNTOS POR
TUS COMPRAS

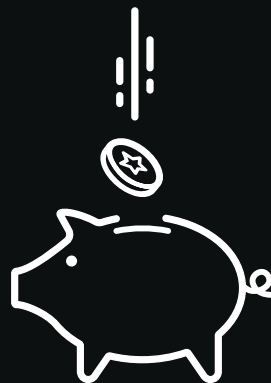

- 3.** REDEEM POINTS FOR REWARDS, EXPERIENCES,
DISCOUNTS & MORE
ÉCHANGEZ DES POINTS CONTRE DES RÉCOMPENSES,
DES EXPÉRIENCES, DES RÉDUCTIONS ET PLUS ENCORE
CANJEA PUNTOS POR RECOMPENSAS, EXPERIENCIAS,
DESCUENTOS Y MUCHO MÁS

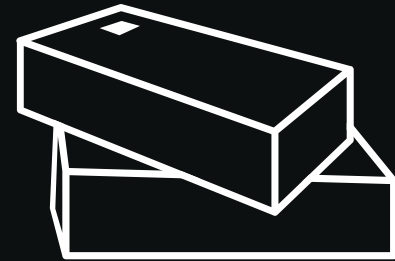
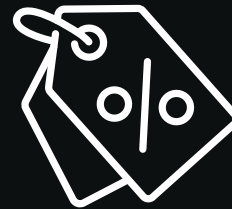



"These days, being in Nature is becoming a rare occurrence. We are an urban, technology-dependent society. But we need Nature to relate to each other and understand ourselves. This LEGO® Tranquil Garden, inspired by Japanese gardens, at least symbolically brings Nature to your mind. Which is one of the most important things for our lives now."

HOICHI KURISU

Japanese Garden Designer and Builder

« De nos jours, il est rare de se retrouver dans la nature. Nous sommes une société urbaine dépendante de la technologie. Mais nous avons besoin de la nature pour nous rapprocher les uns des autres et nous comprendre. Le jardin zen LEGO®, inspiré des jardins japonais, introduit la nature dans votre esprit, du moins de façon symbolique. C'est l'une des choses les plus importantes dans nos vies aujourd'hui. »

HOICHI KURISU

Concepteur et constructeur de jardins japonais

"En nuestra época, pasar tiempo en la naturaleza se está convirtiendo en algo bastante inusual. Formamos parte de una sociedad urbana y dependiente de la tecnología. Pero necesitamos la naturaleza para relacionarnos con los demás y entendernos a nosotros mismos. Inspirado en los jardines japoneses, el Jardín Meditativo LEGO® lleva a tu mente la naturaleza de manera simbólica, algo que resulta fundamental para la vida en los tiempos modernos".

HOICHI KURISU

Diseñador de jardines japoneses y constructor



Created for mindful living

Créé pour la vie spirituelle

Creado para vivir la atención plena

● Follow the stepping stones to your private pavilion, make yourself at home, relax and be one with nature for a moment. Or stay as long as you like. Inspired by the elements of millennia-old tranquil gardening traditions, this set has been created in collaboration with Hoichi Kurisu, who has several years of experience in creating mindful gardens. A serene retreat where you can reflect and recharge without distractions. Each element in the garden lets you dwell on the colorful wonders and playful beauty of Mother Earth. As you spend time with your garden, allow the seasons to come and go. Feel your creativity blossom with each visit, rearrange the scenery, plant new LEGO® vegetation, or add decorative ornaments that are meaningful to you. Prepare a pot of your favorite matcha tea, tune into a soothing nature soundtrack, slip into your softest slippers and take time to enjoy your mind's space.

● Suivez les pierres de gué jusqu'à votre pavillon privé, installez-vous confortablement, détendez-vous et communiez avec la nature pendant un instant. Ou restez aussi longtemps que vous le souhaitez. Inspiré par les éléments des traditions millénaires de jardinage zen, cet ensemble a été créé en collaboration avec Hoichi Kurisu, qui a plusieurs années d'expérience dans la création de jardins spirituels. Une retraite sereine où vous pouvez réfléchir et vous ressourcer sans distractions. Chaque élément du jardin vous permet de contempler les merveilles colorées et la beauté ludique de la nature. Profitez du temps passé avec votre jardin et laissez les saisons se succéder. Nourrissez votre créativité à chaque visite, réorganisez le décor, plantez de nouvelles plantes LEGO® ou ajoutez des ornements décoratifs qui comptent pour vous. Préparez une tasse de votre thé matcha préféré, écoutez la musique apaisante de la nature, enfiler vos pantoufles les plus douillettes et prenez le temps de découvrir l'espace de votre esprit.

● Sigue el sendero de piedras que conduce a tu pabellón privado, siéntete como en casa, relájate y sé uno con la naturaleza por un instante. O, si así lo deseas, prolonga el momento tanto como quieras. Inspirado en los elementos esenciales de las milenarias tradiciones de la jardinería japonesa, este set se creó en colaboración con Hoichi Kurisu, quien cuenta con una experiencia de muchos años diseñando jardines para la práctica de la atención plena. Un refugio de serenidad donde puedes reflexionar y recargar tus baterías sin distracciones. Cada componente del jardín te permite sumergirte en las coloridas maravillas y la alegre belleza de la madre tierra. Mientras pasas tiempo en tu jardín, deja que las estaciones vengan y vayan. Siente tu creatividad florecer con cada visita, reorganiza el paisaje, planta nueva vegetación LEGO® o añade elementos decorativos que signifiquen algo para ti. Prepara una vasija de tu té matcha favorito, reproduce una relajante banda sonora inspirada en la naturaleza, ponte tus pantuflas más suaves y reserva tiempo para disfrutar del espacio de tu mente.





"Give the set your own personal touch to match your mood."

MICHAEL PSIAKI & CARL MERRIAM
LEGO® Icons Model designers

Tend to your garden

● "Building a LEGO® set can be an immersive escape – like reading a great book. It allows you to focus on something fun and gives you a feeling of pride and gratification, even long after it's completed. You can return to this garden as often as you like. Tend to the elements and change the landscape as you would an actual garden or maybe a bonsai tree. Prune or replant the blossoming cherry trees, lush evergreens and bamboo, or move the smooth stone lanterns to fit your style and mood. Or gaze at the vibrant Koi and water lilies in the burbling pond, and simply surrender to your creative freedom."

Prenez soin de votre jardin

● La construction d'un ensemble LEGO® peut être une échappatoire immersive, comme la lecture d'un bon livre. Elle vous permet de vous concentrer sur une activité amusante et vous procure un sentiment de fierté et de satisfaction, même longtemps après son achèvement. Vous pouvez revenir dans ce jardin aussi souvent que vous le souhaitez. Prenez soin des éléments et modifiez le paysage comme vous le feriez pour un vrai jardin ou un bonsaï. Taillez ou replantez les cerisiers en fleurs, les conifères luxuriants et les bambous, ou déplacez les lanternes en pierre lisse selon votre style et votre humeur. Vous pouvez aussi contempler les carpes koi et les nénuphars dans l'étang et laisser libre cours à votre créativité.

Cuida de tu jardín

● "Construir un set LEGO® tiene mucho en común con leer un libro extraordinario: es una experiencia inmersiva que lleva tu mente lejos del aquí y el ahora. Te permite centrarte en algo divertido y te da la oportunidad de sentir orgullo y satisfacción, incluso largo tiempo después de haberlo completado. Puedes volver a este jardín tan seguido como quieras. Cuida de cada uno de los elementos que lo componen y haz cambios en el paisaje tal como lo harías en un jardín de verdad o con un bonsaï. Poda o trasplanta los cerezos en flor, los exuberantes árboles de hoja perenne y el bambú, o mueve a otro lugar las linternas de piedra según tu estilo y estado de ánimo. También puedes contemplar las vibrantes carpas koi y los nenúfares en el burbujeante estanque y dejarte llevar por tu libertad creativa".



« Donnez à l'ensemble votre
touche personnelle pour qu'il
reflète votre humeur »

MICHAEL PSIAKI & CARL MERRIAM
Concepteurs de modèles LEGO® Icons

"Dale al set tu toque personal
según tu estado de ánimo"

MICHAEL PSIAKI & CARL MERRIAM
Modelistas de LEGO® Icons

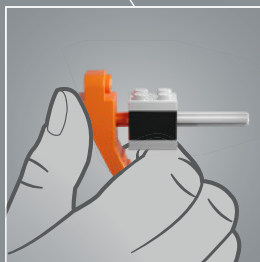
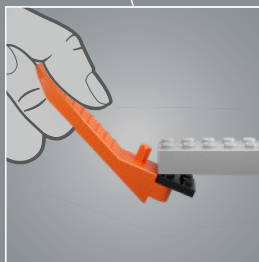
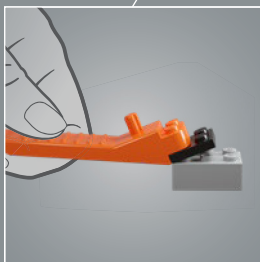
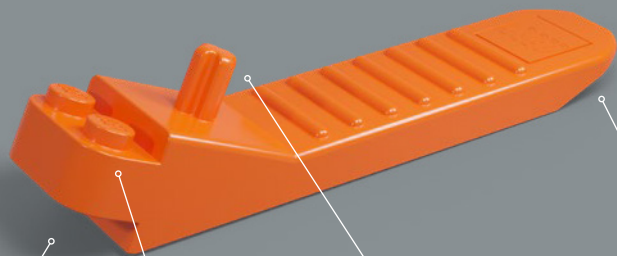

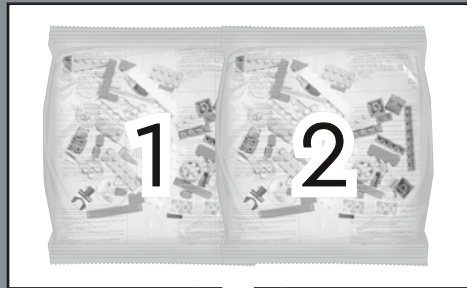

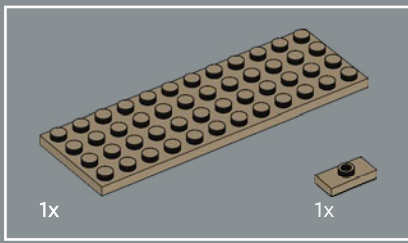
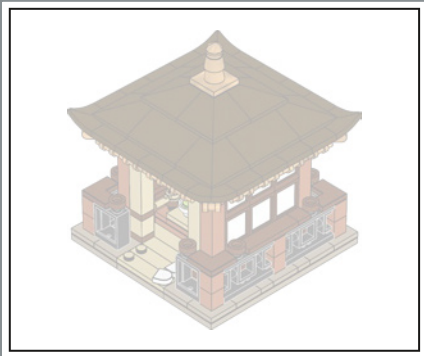

1

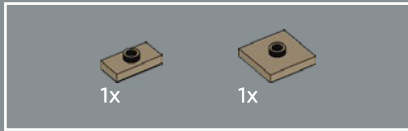
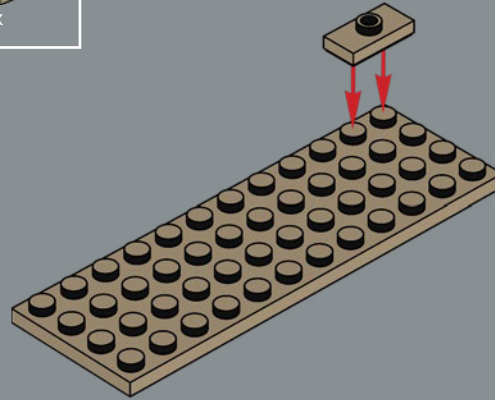

2

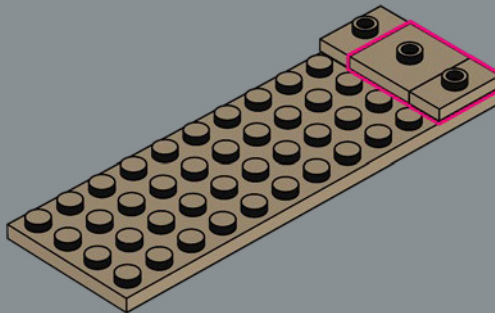

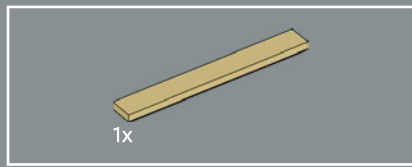

3

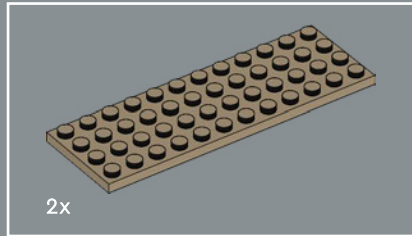
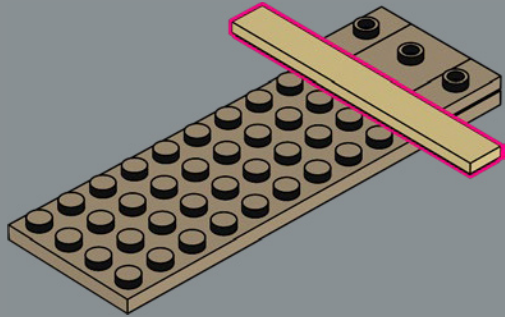

4

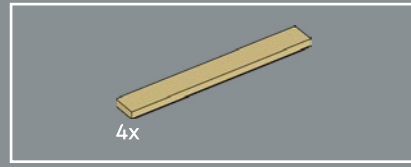
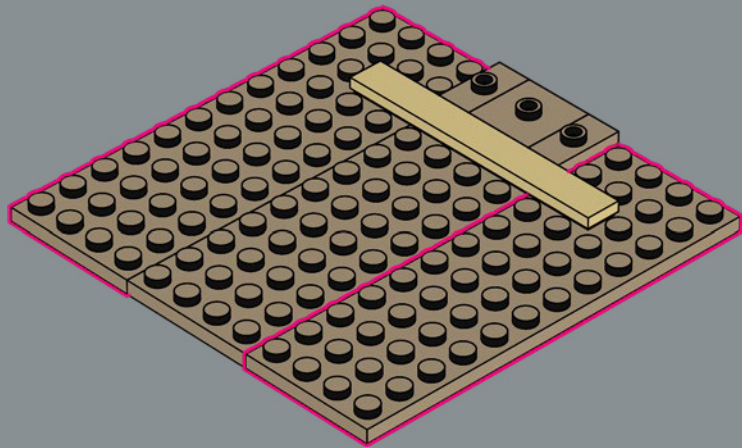

5

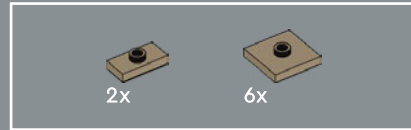
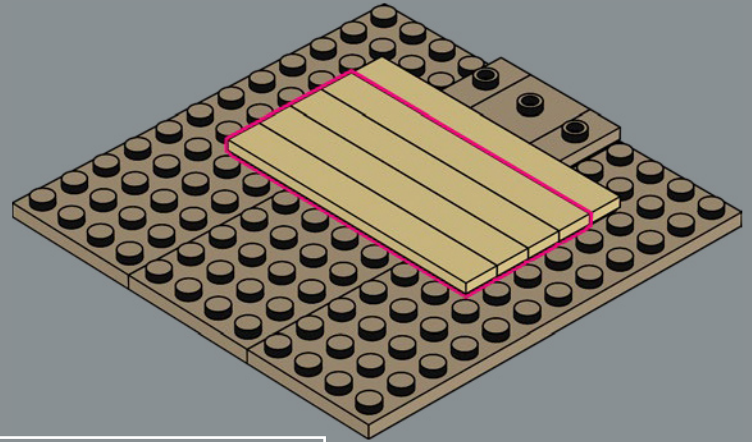

6

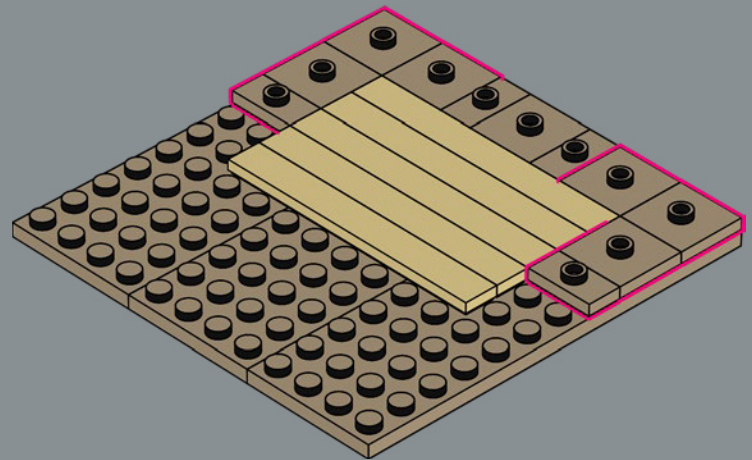

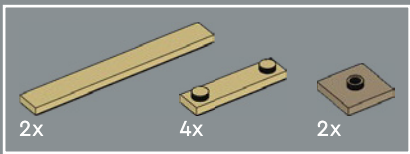

7

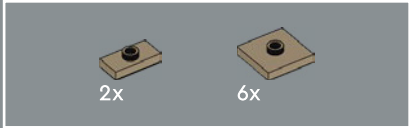
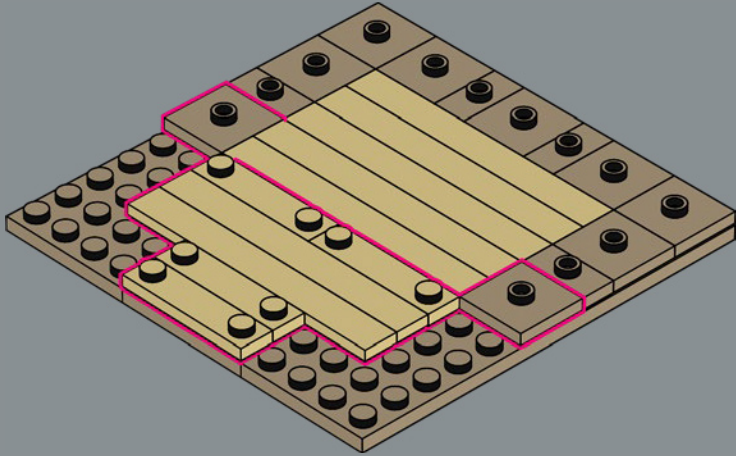

8

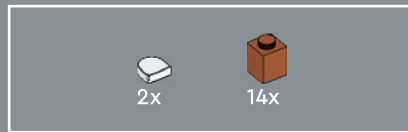
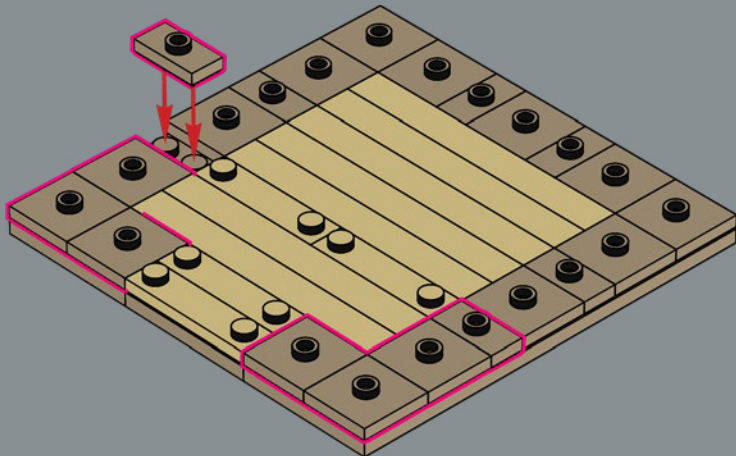

9

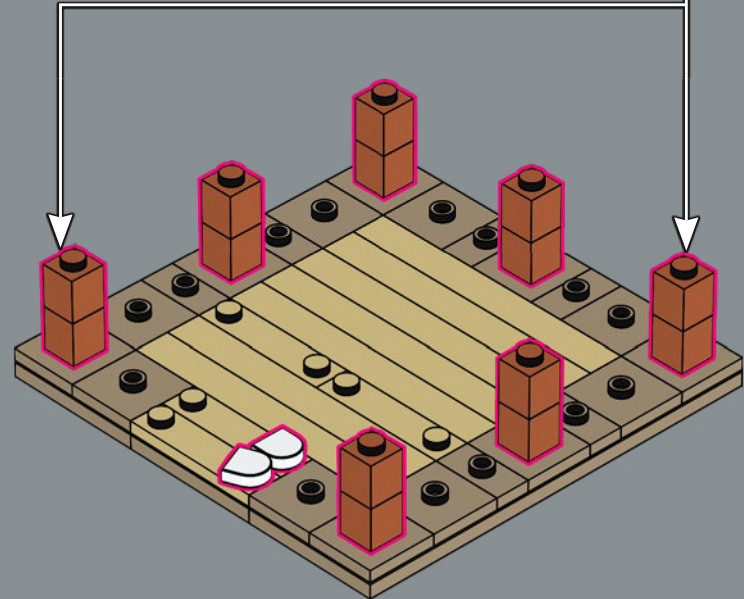
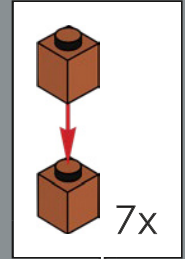

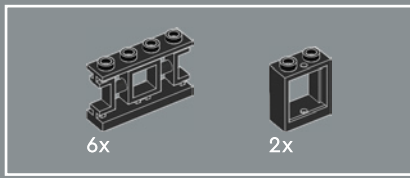

10

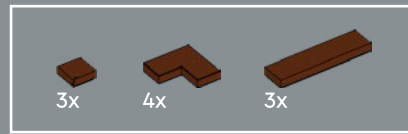
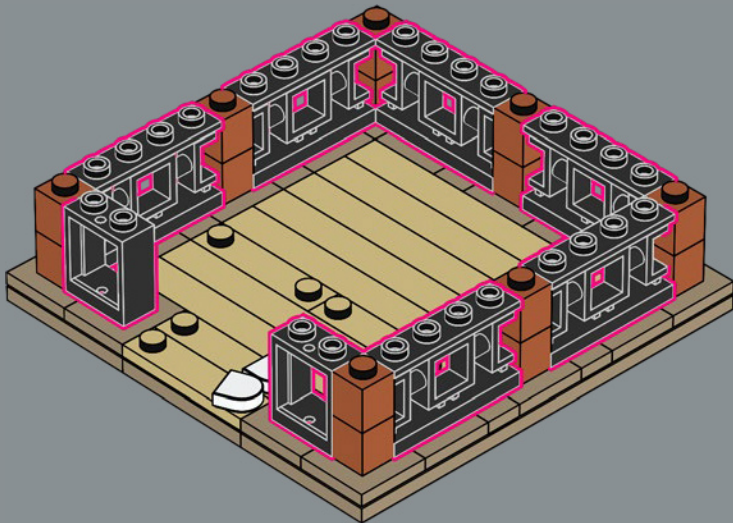

11

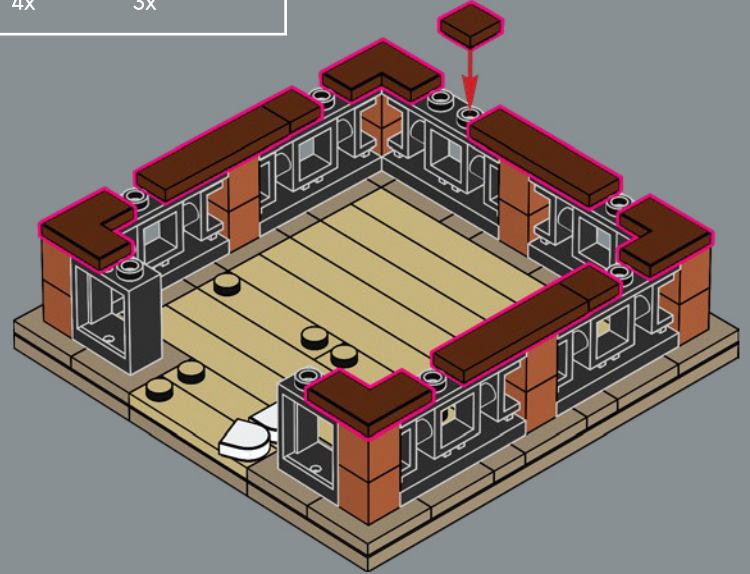

12

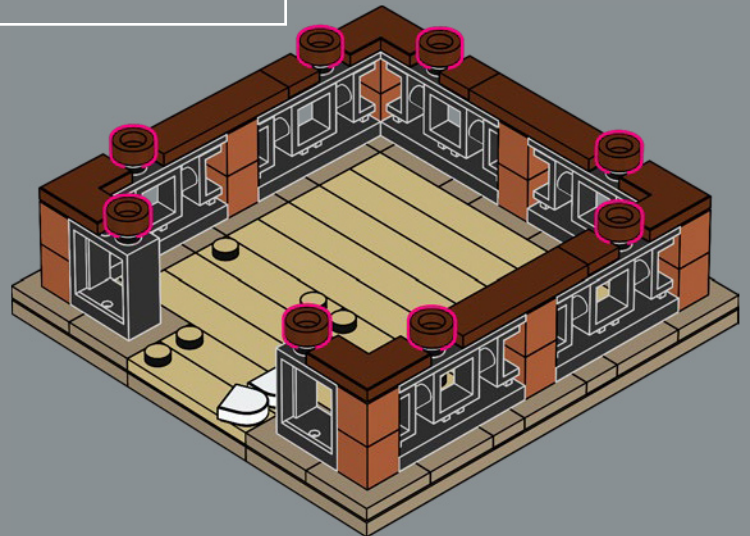

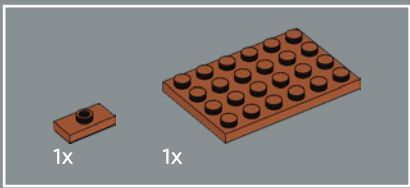

13

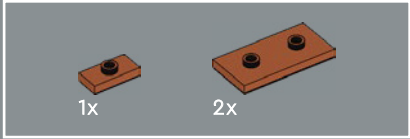
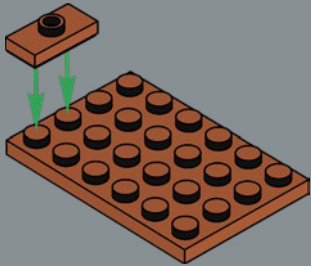

14

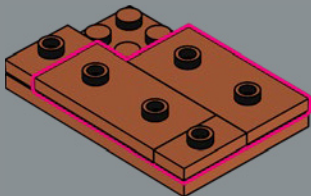

15

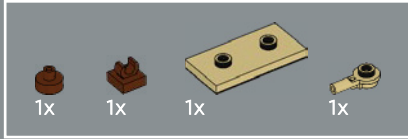
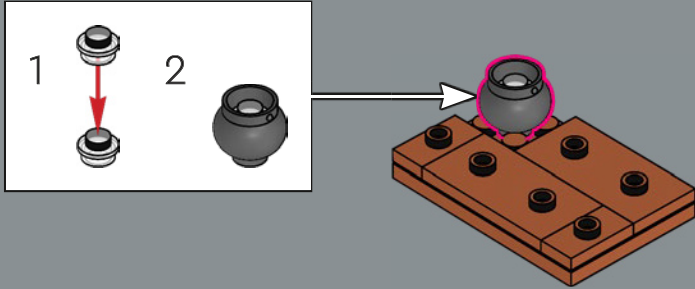

16

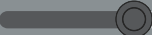
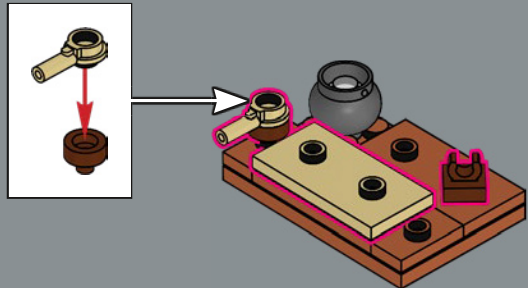

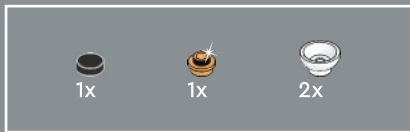

17

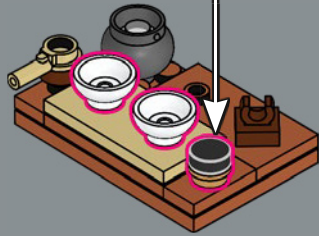
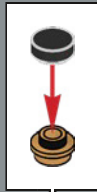

18

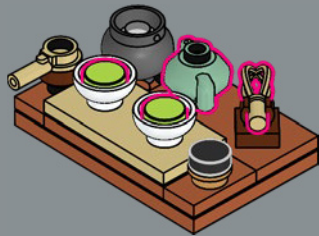

19



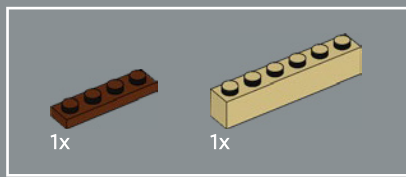

20

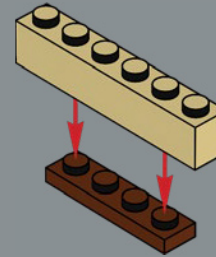

21

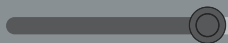
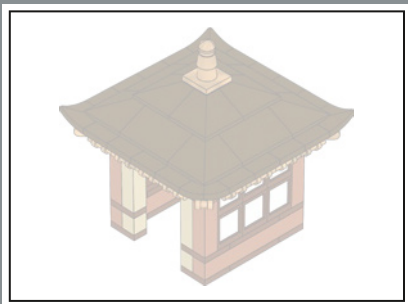
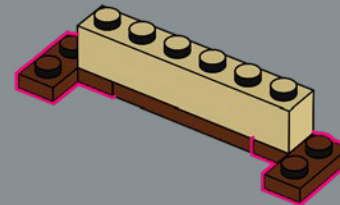

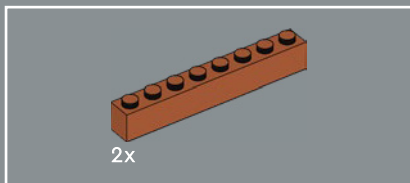

22

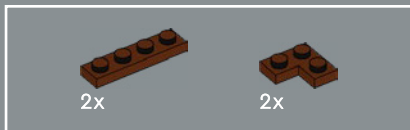
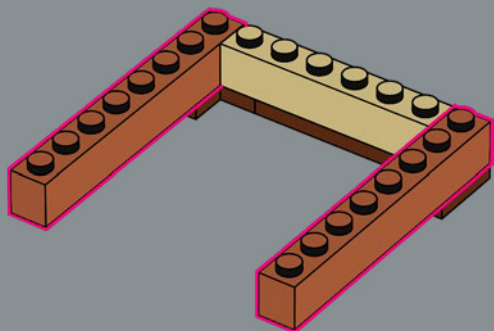

23

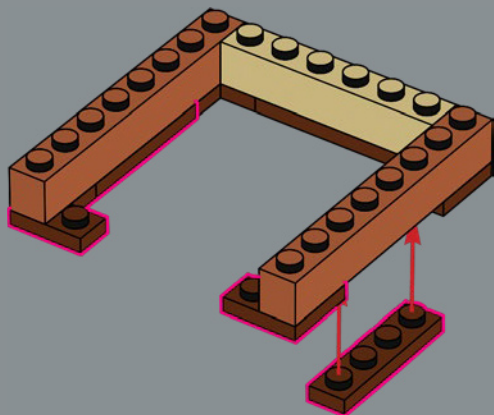

24

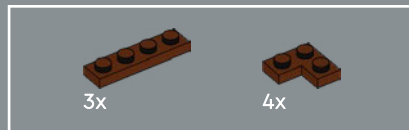
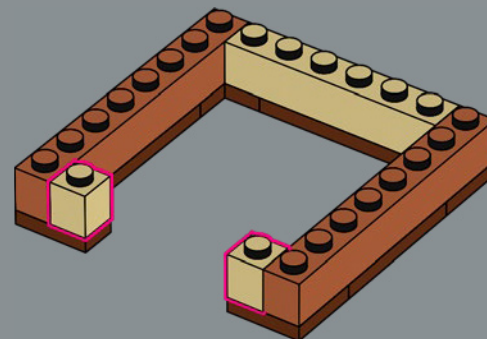

25

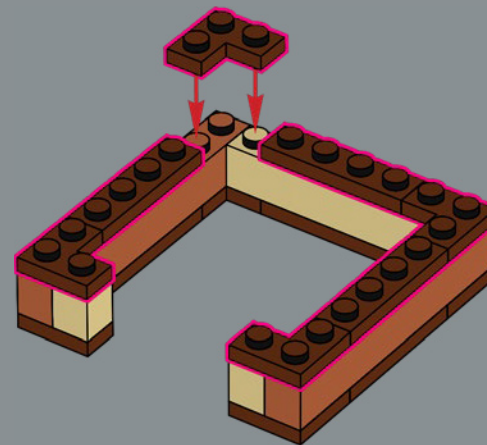

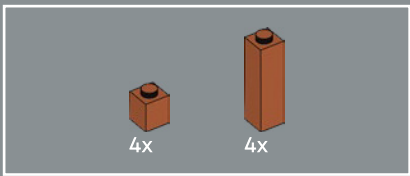

26

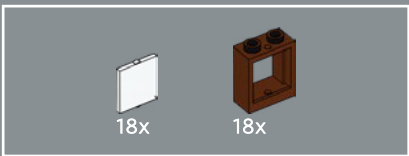
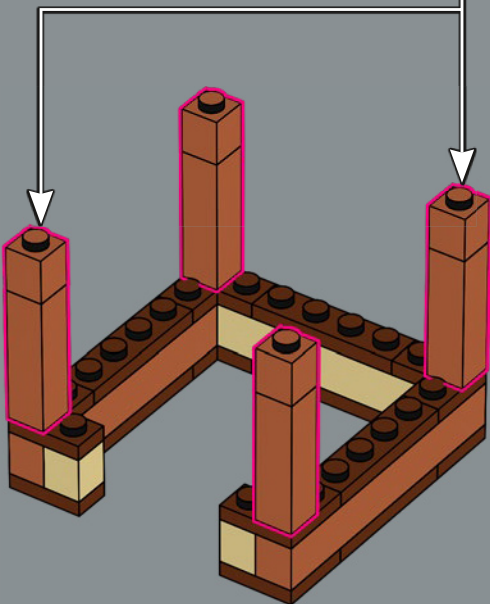
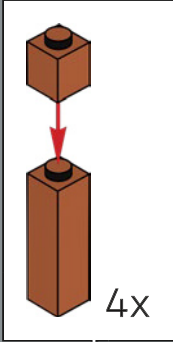

27

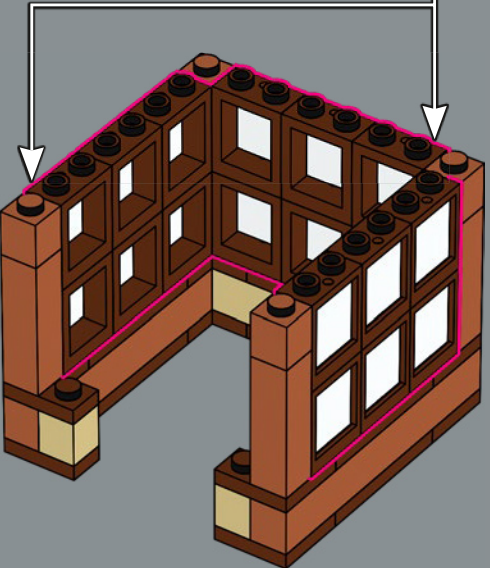
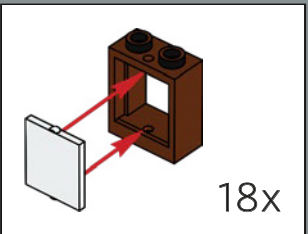

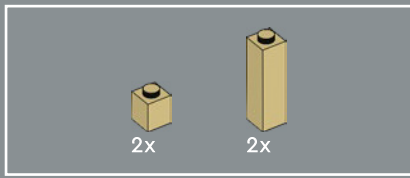

28

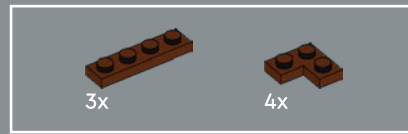
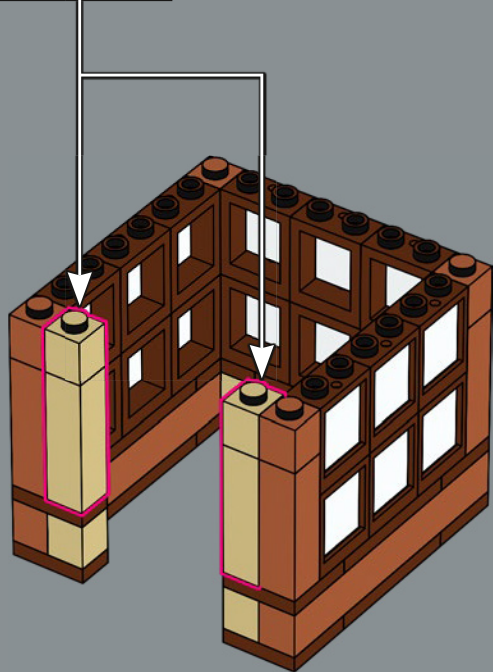
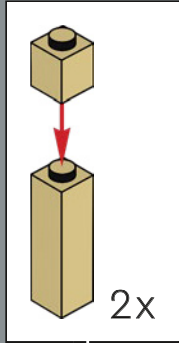

29

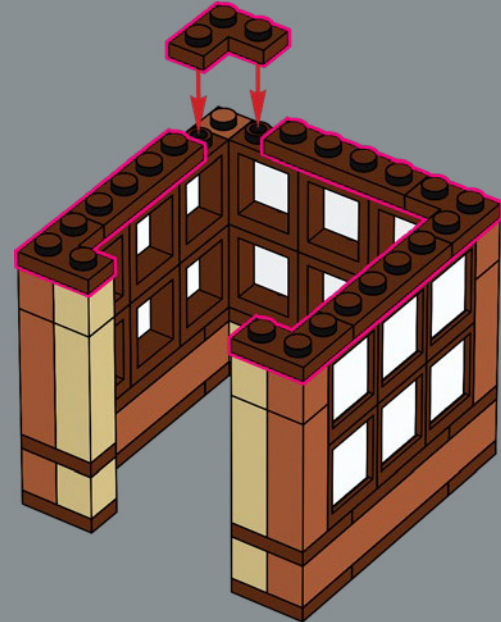

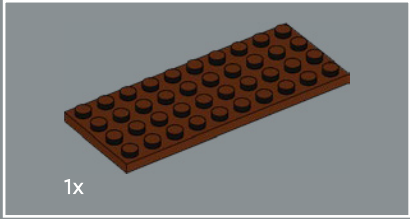
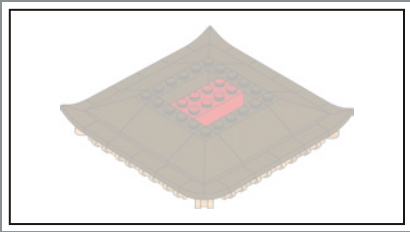

30

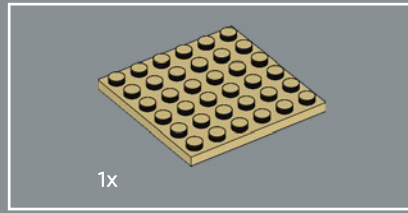
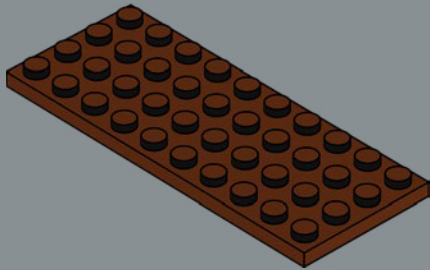

31

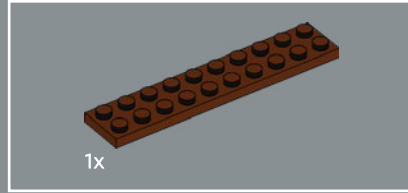
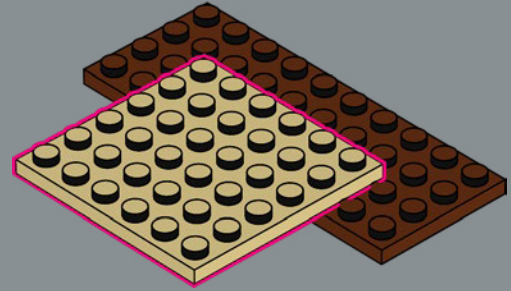

32

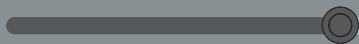
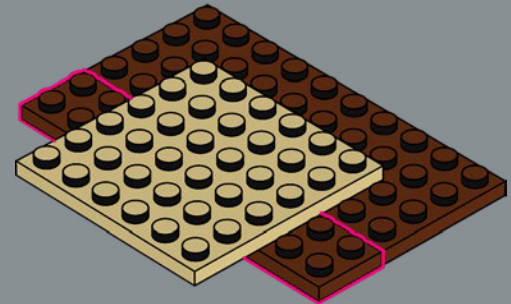

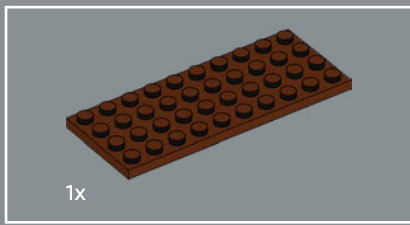

33

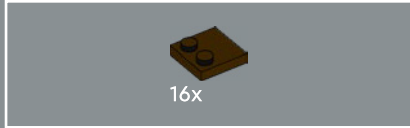
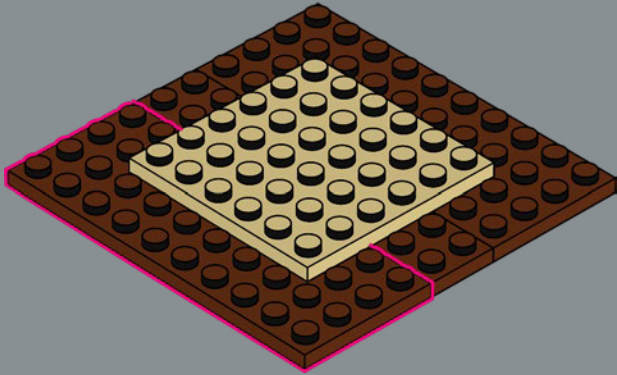

34

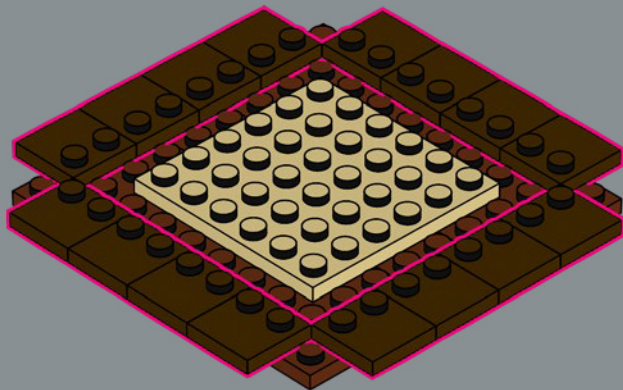

35

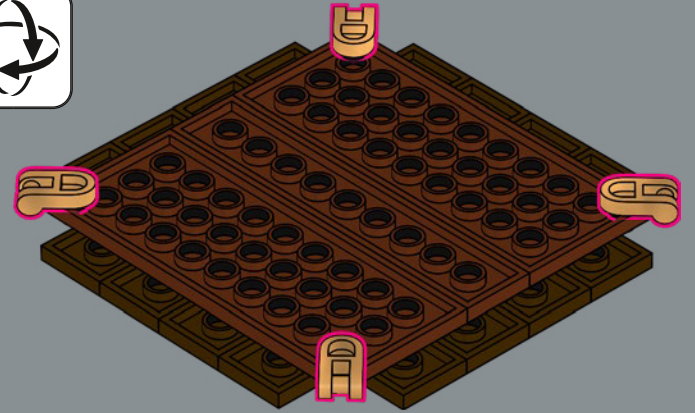

36



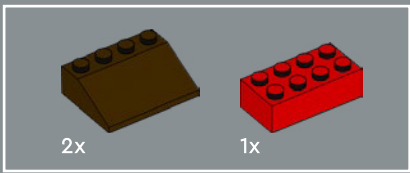

37

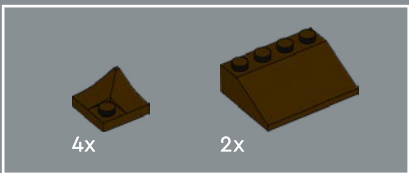
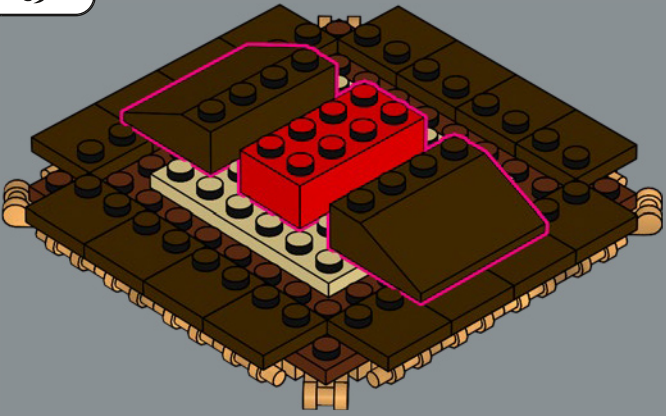

38

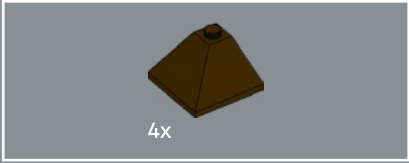
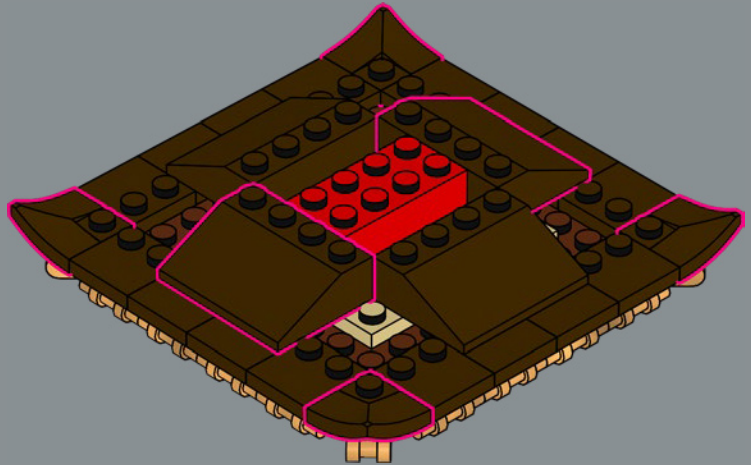

39

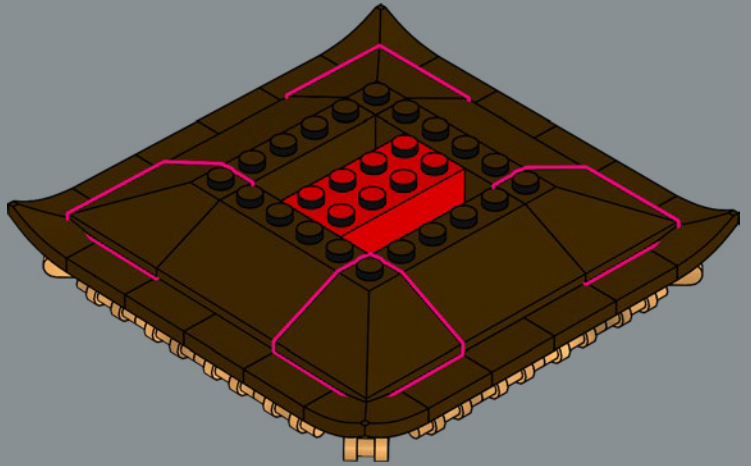

40



41

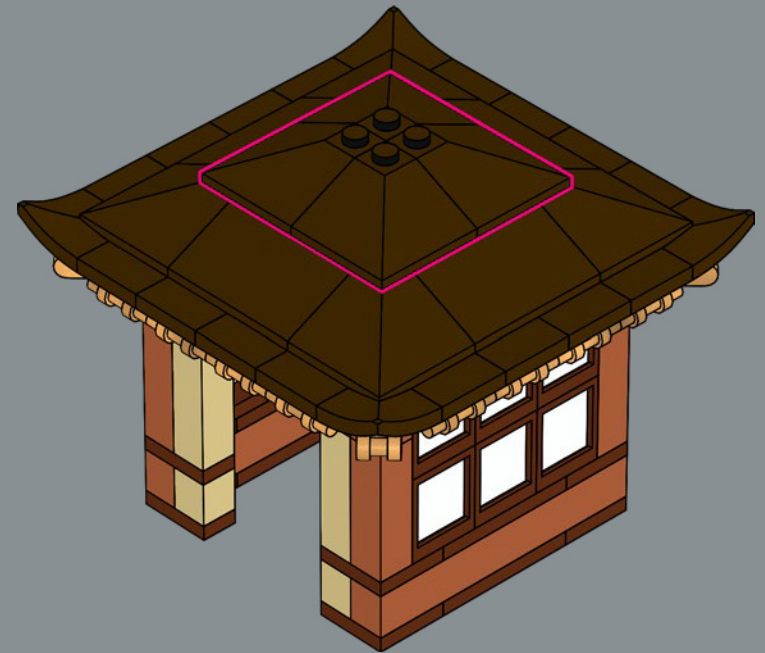
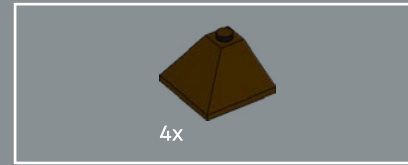

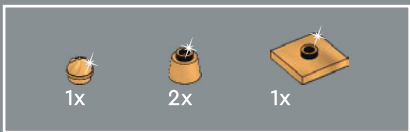

42

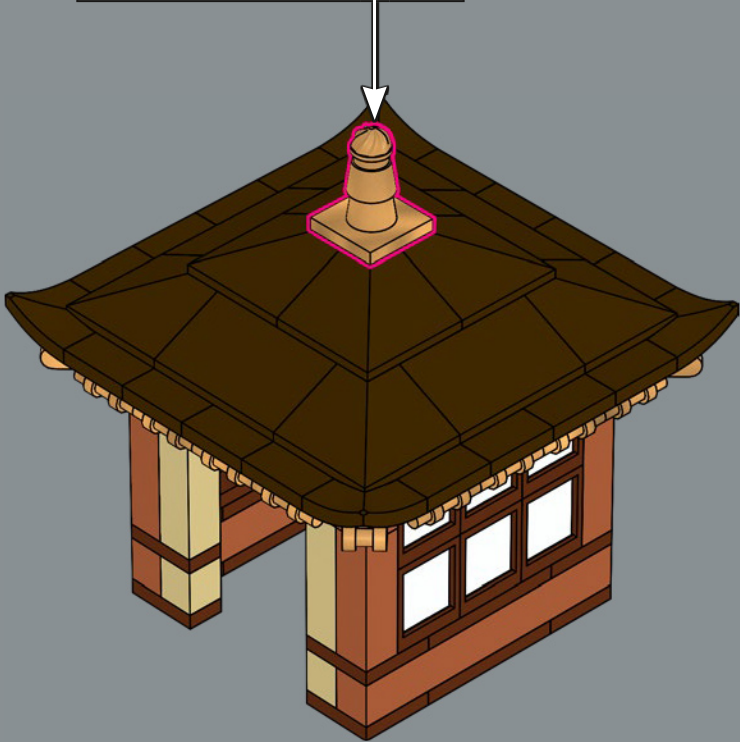
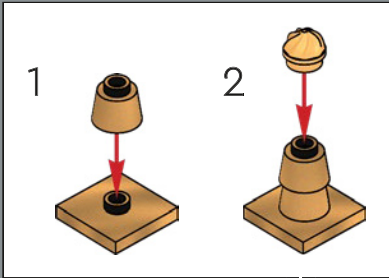

43

Most tranquil garden pavilions are made from wood to blend into the natural surroundings.

La plupart des pavillons du jardin zen sont fabriqués en bois pour se fondre dans l'environnement naturel.

La mayoría de los pabellones de los jardines meditativos están hechos de madera con el objetivo de que se integren armoniosamente en el entorno.

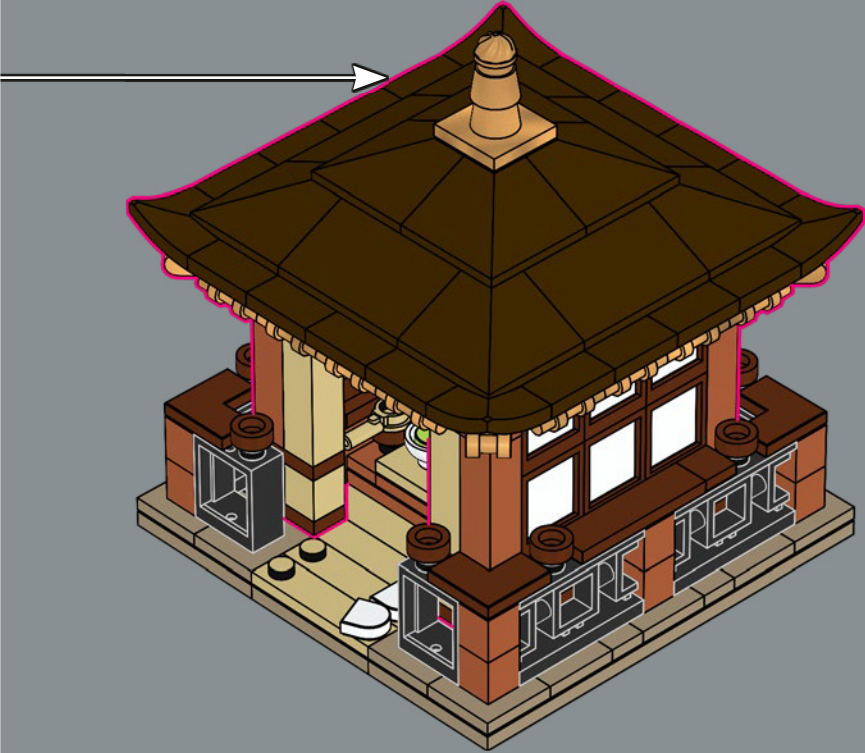

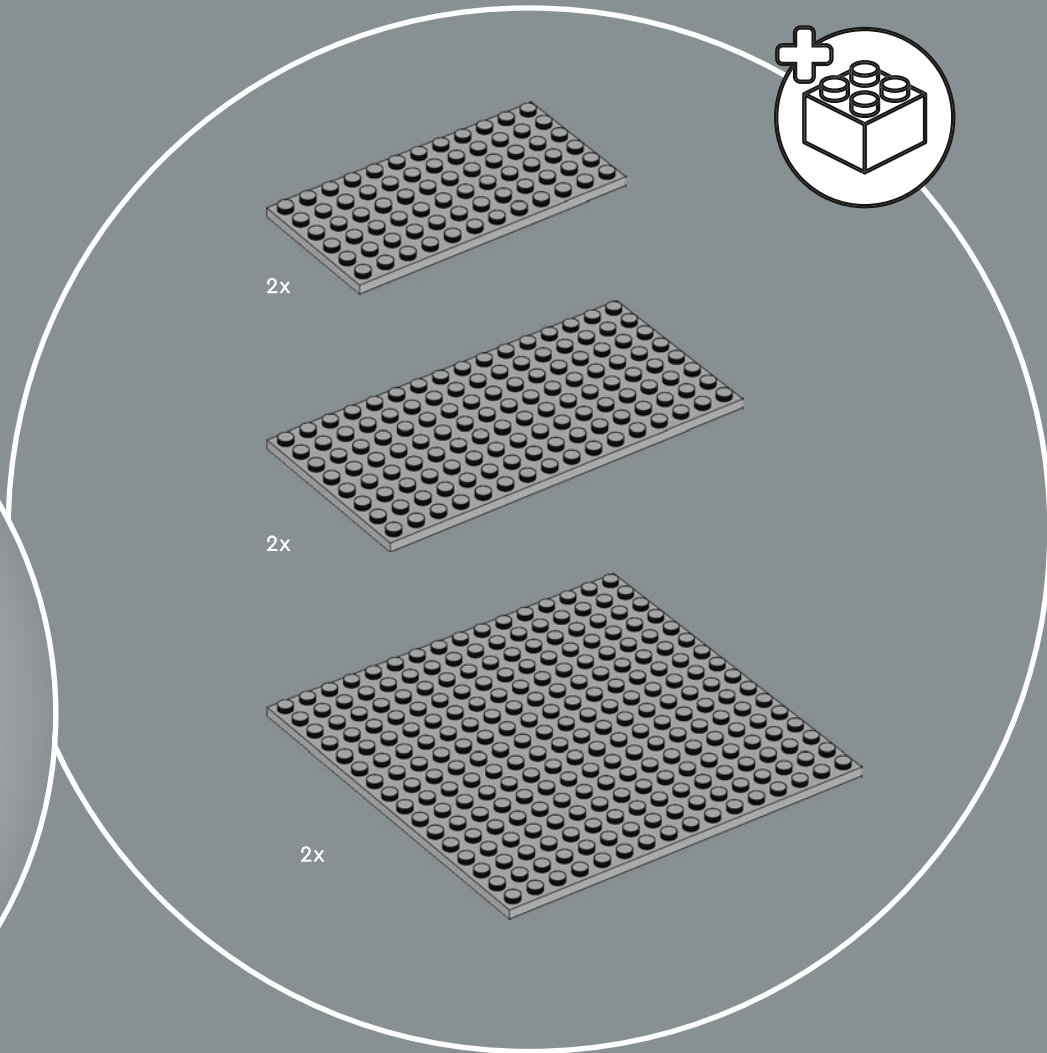

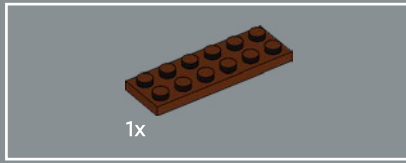
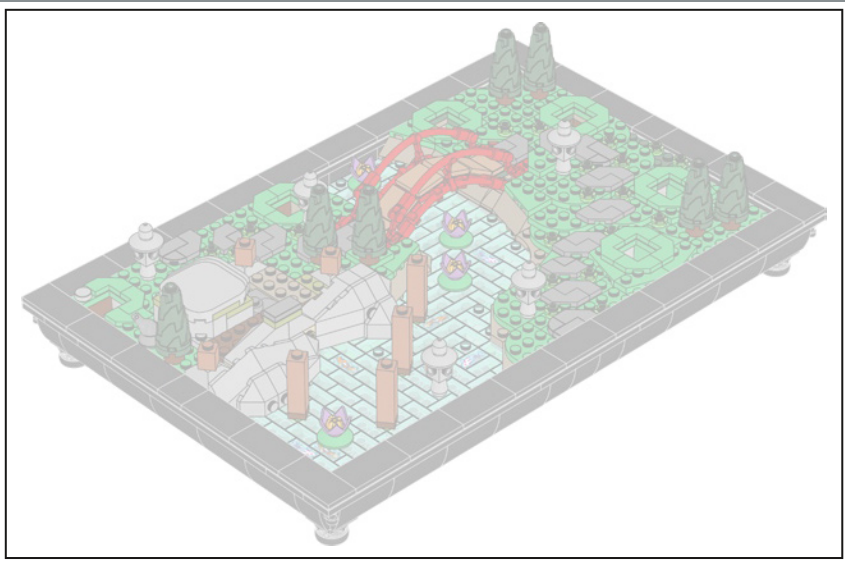

44

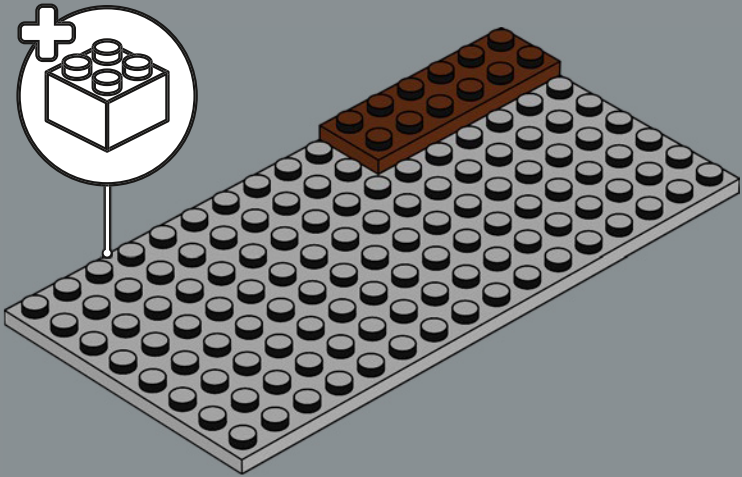

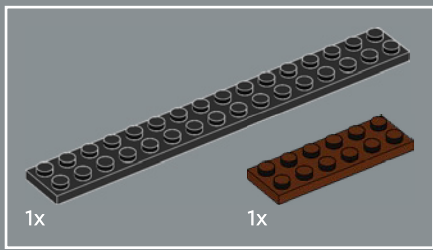

45

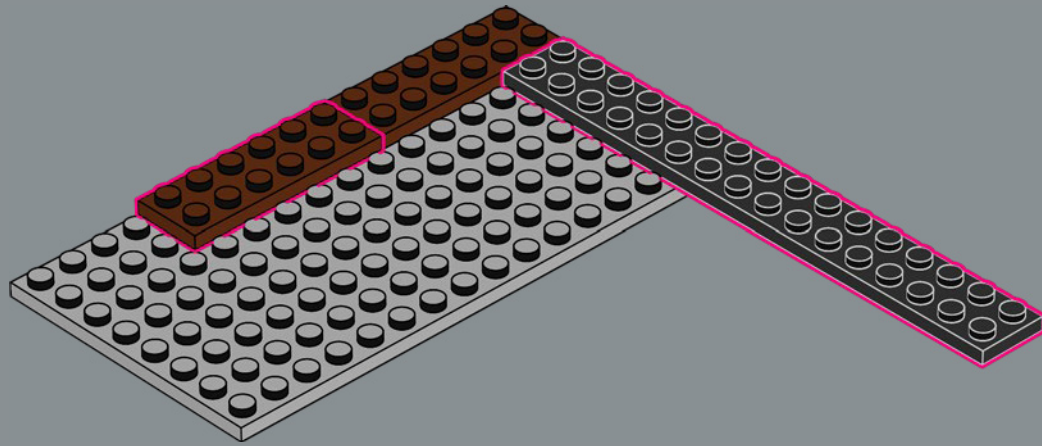

46

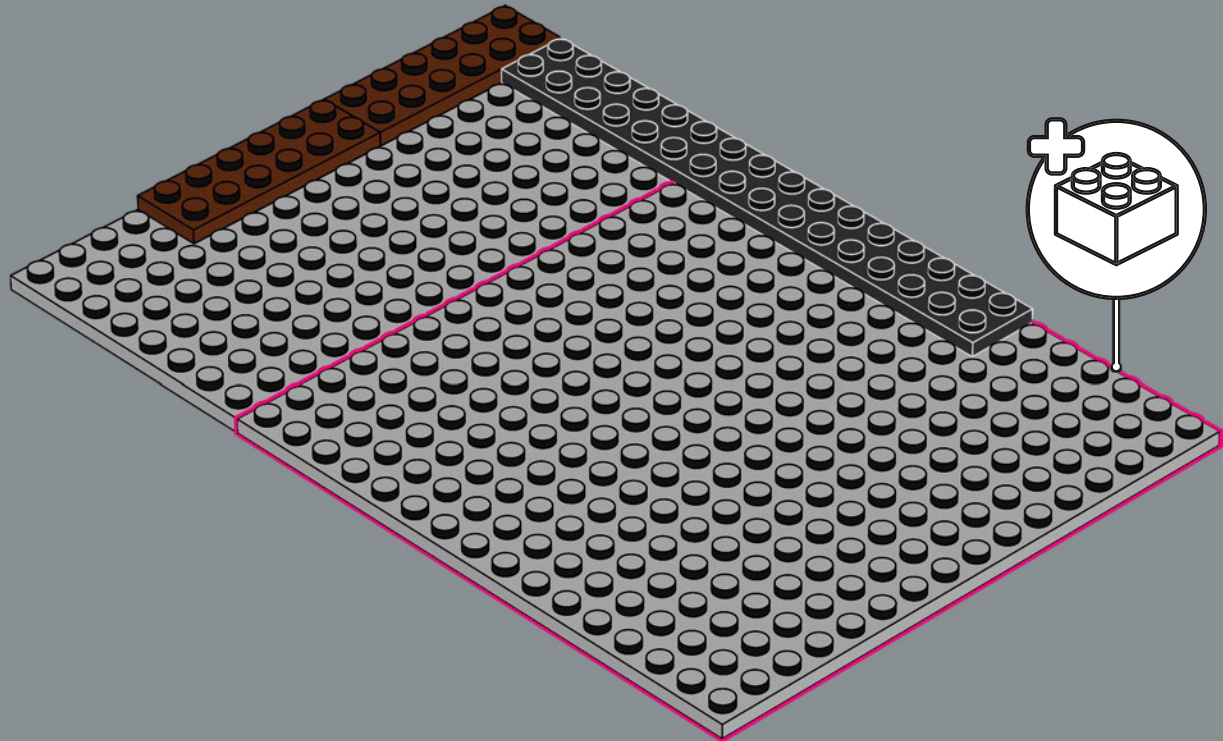

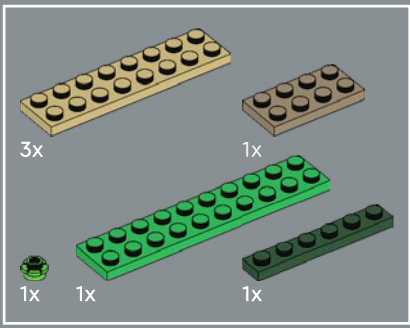

47

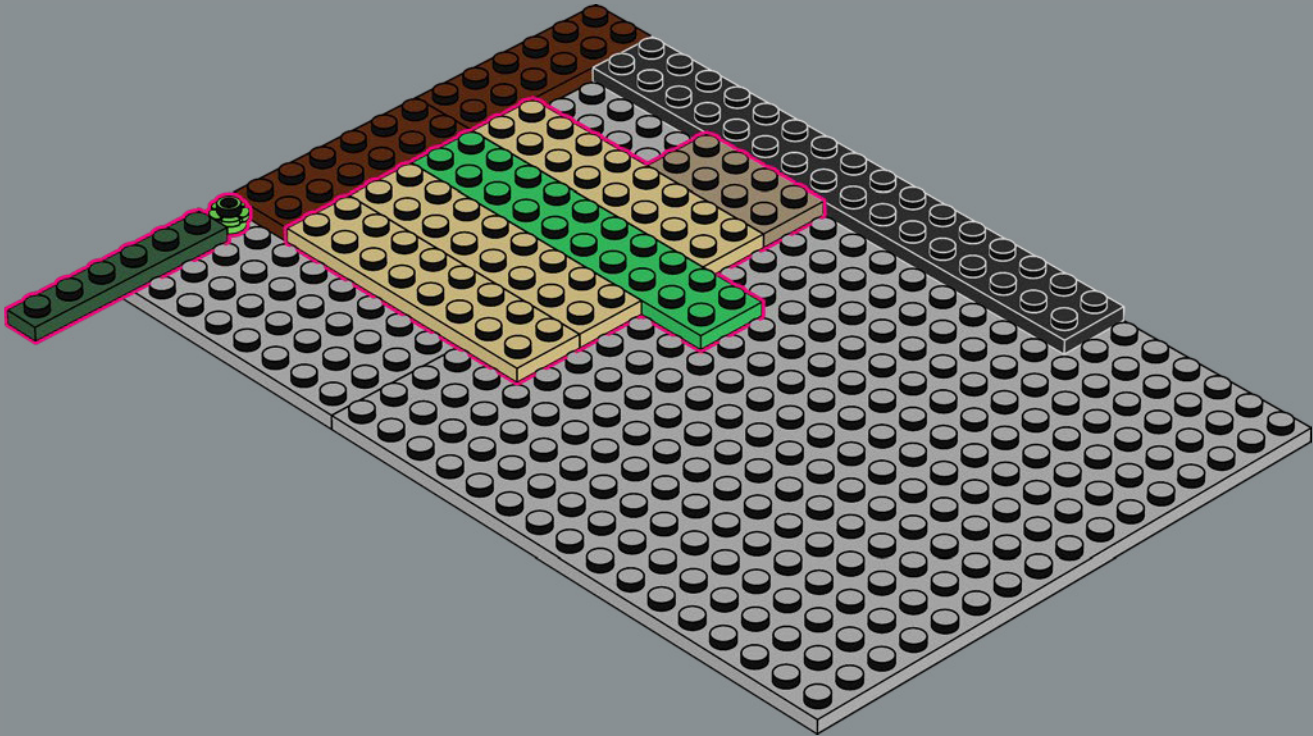

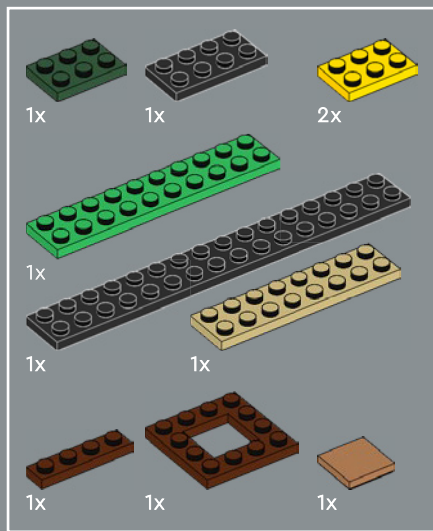

48

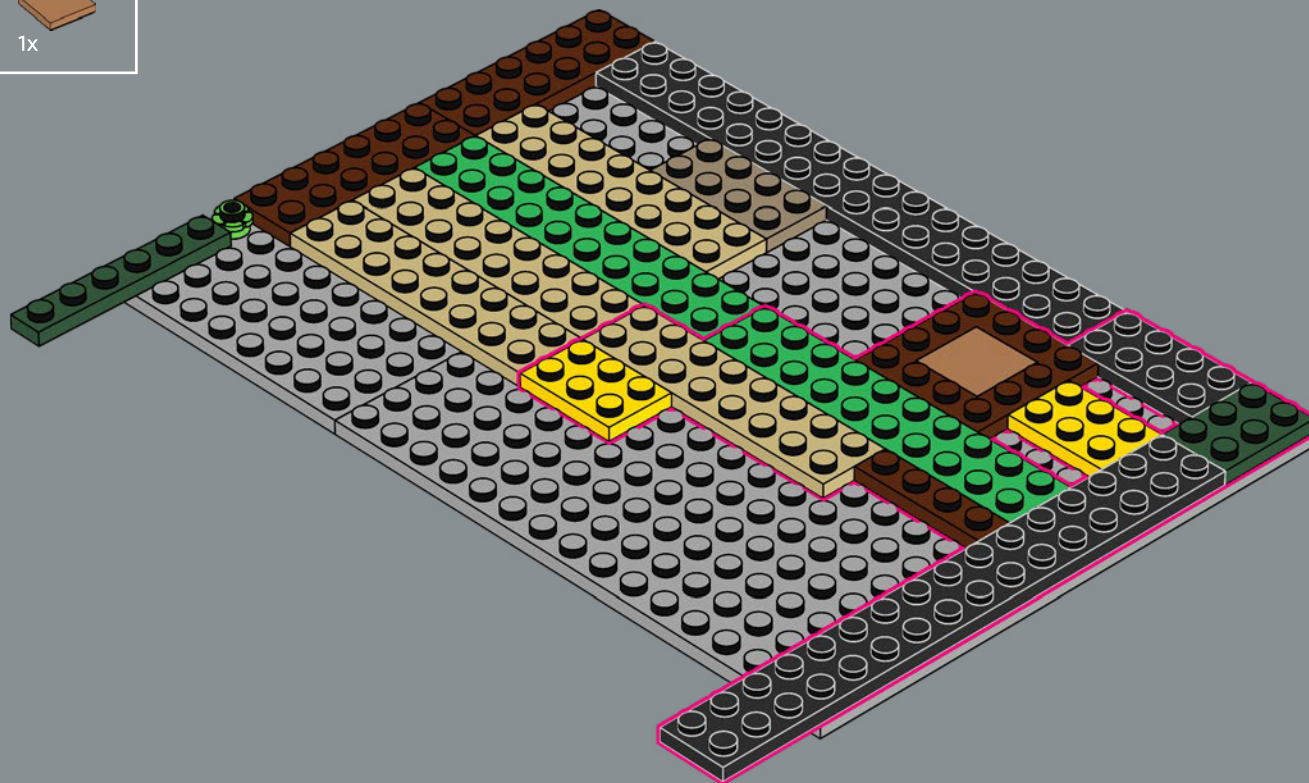

49

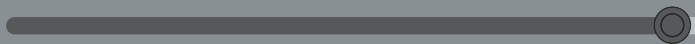
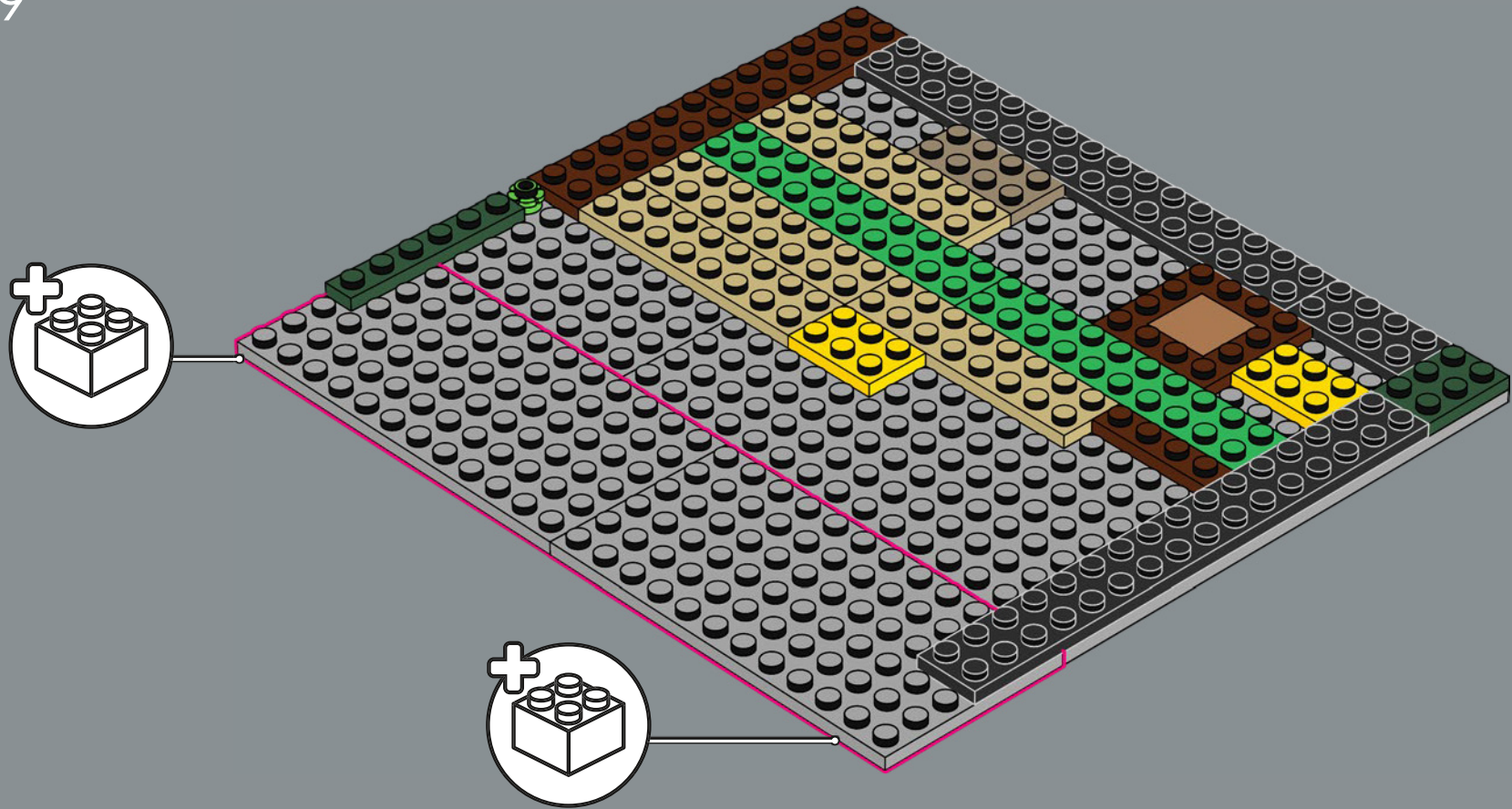

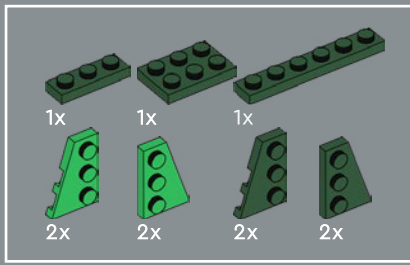

50

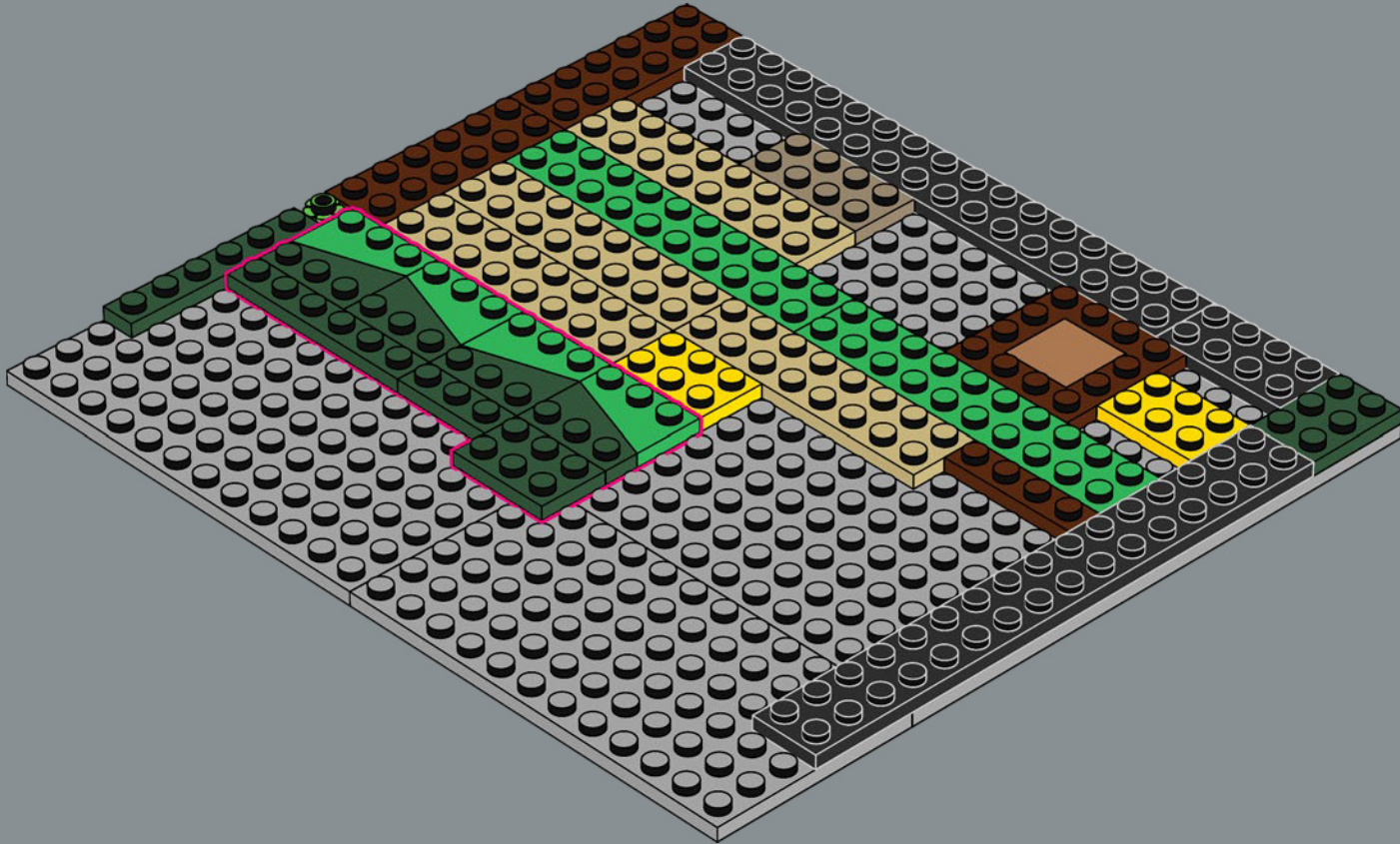

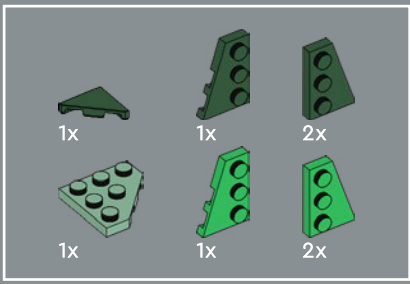

51

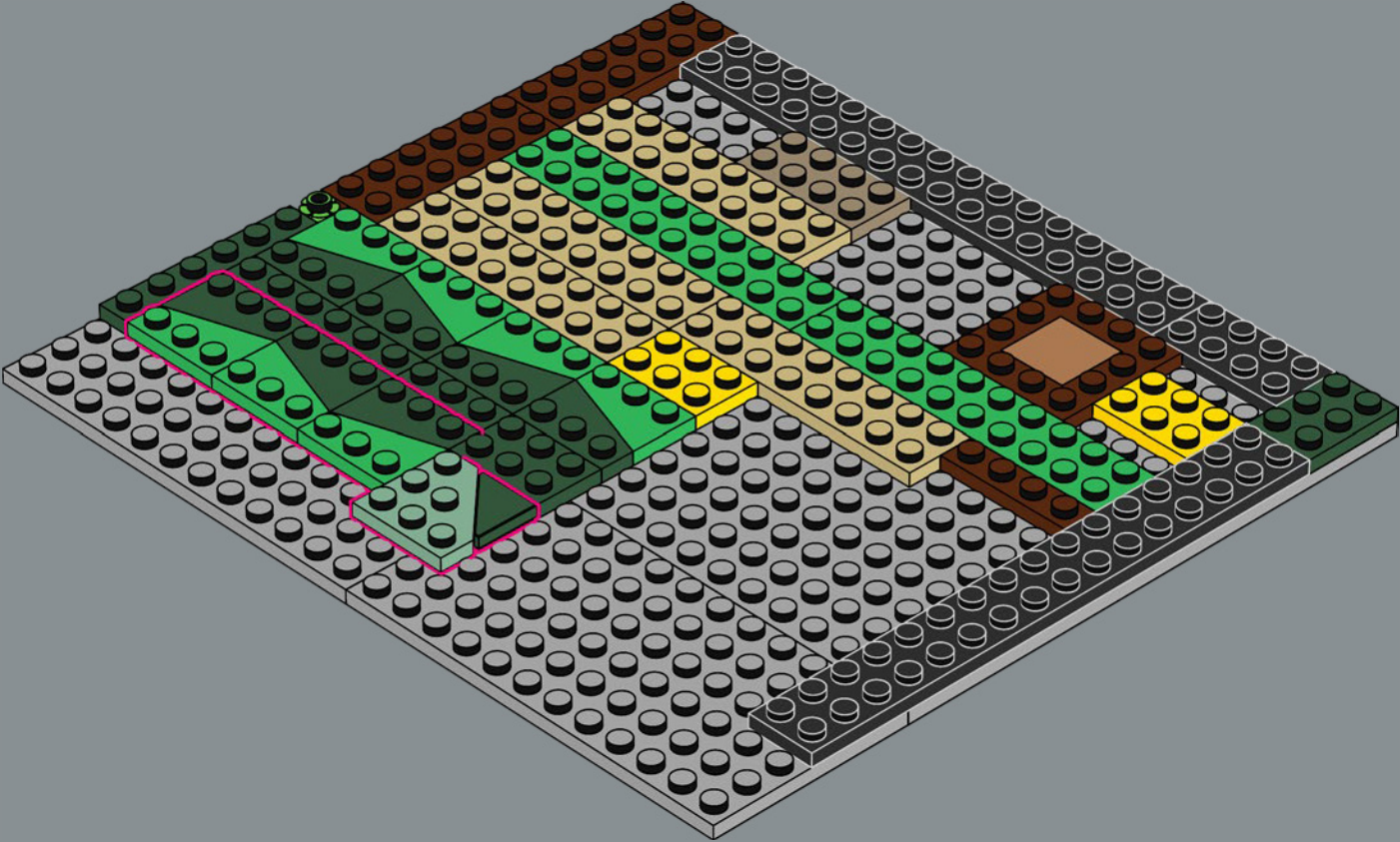

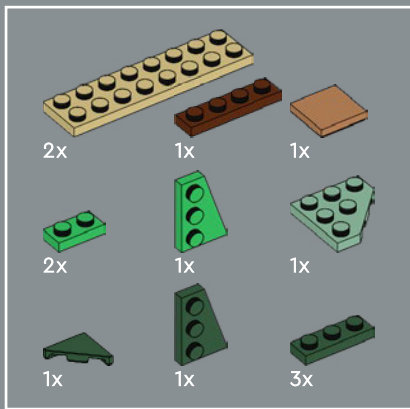

52

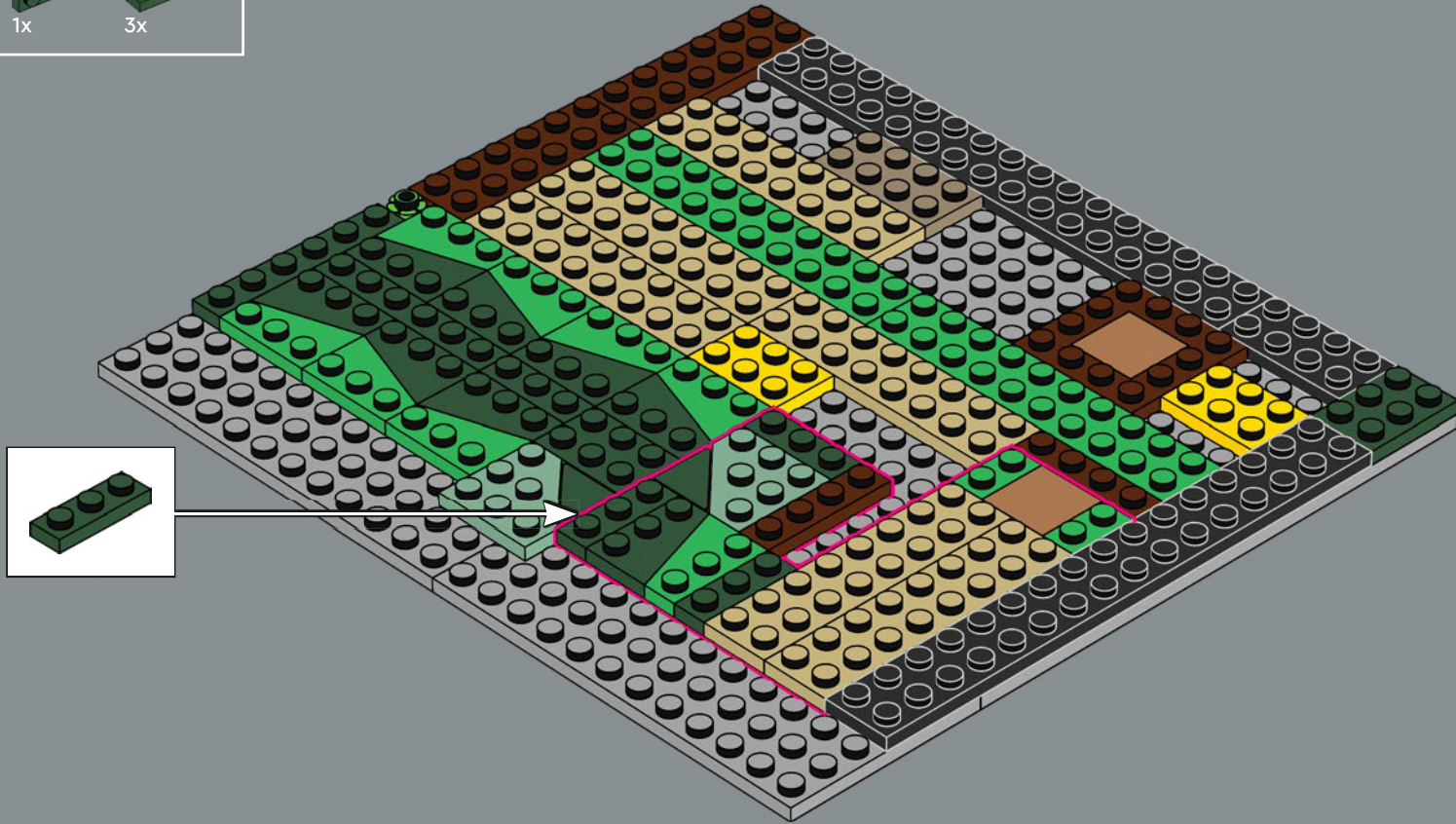

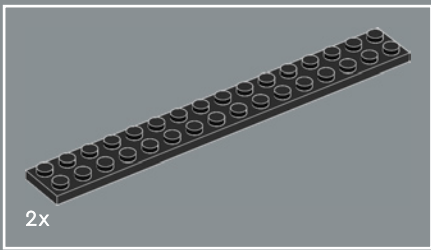

53

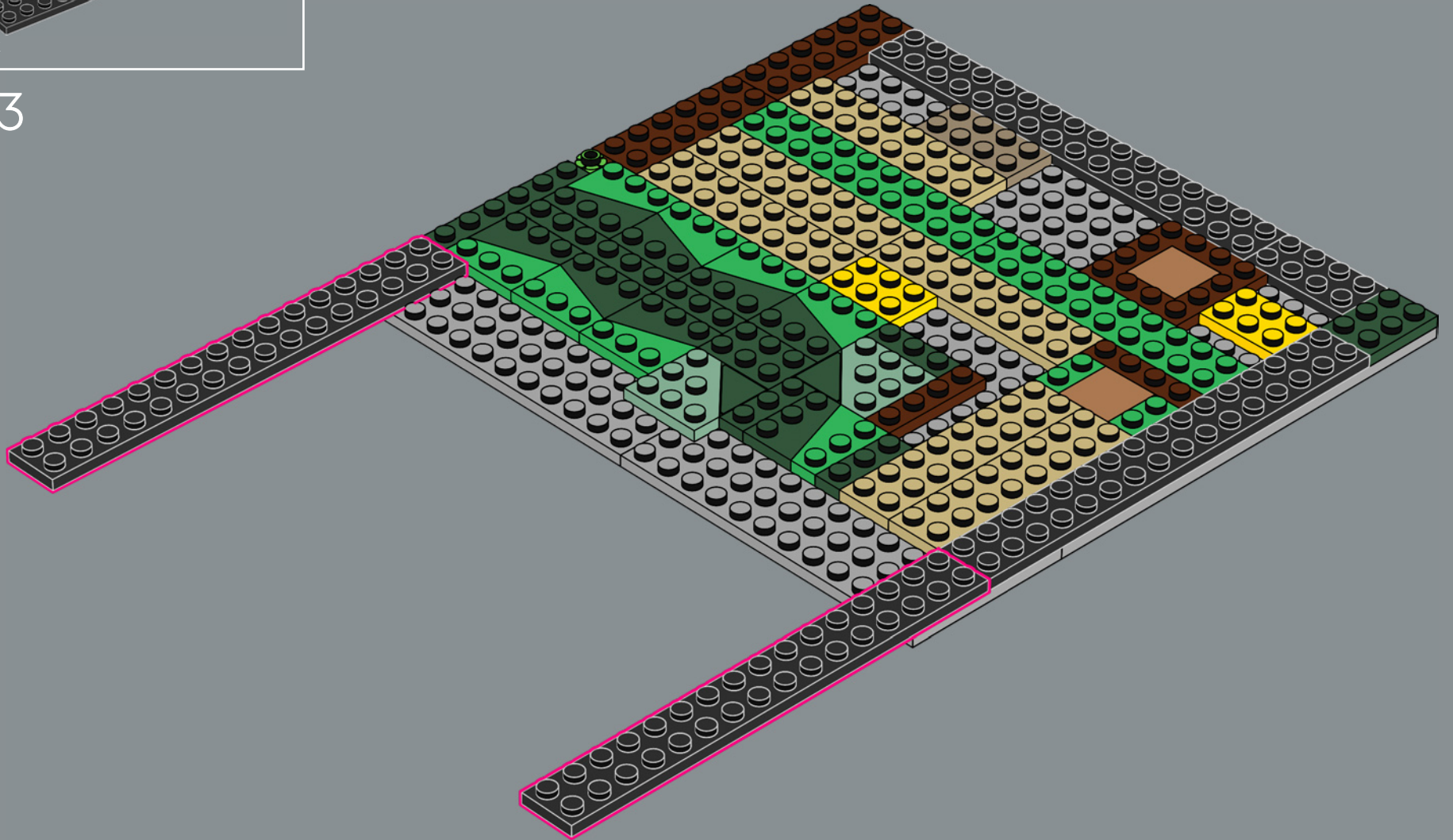

54

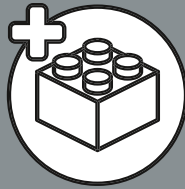
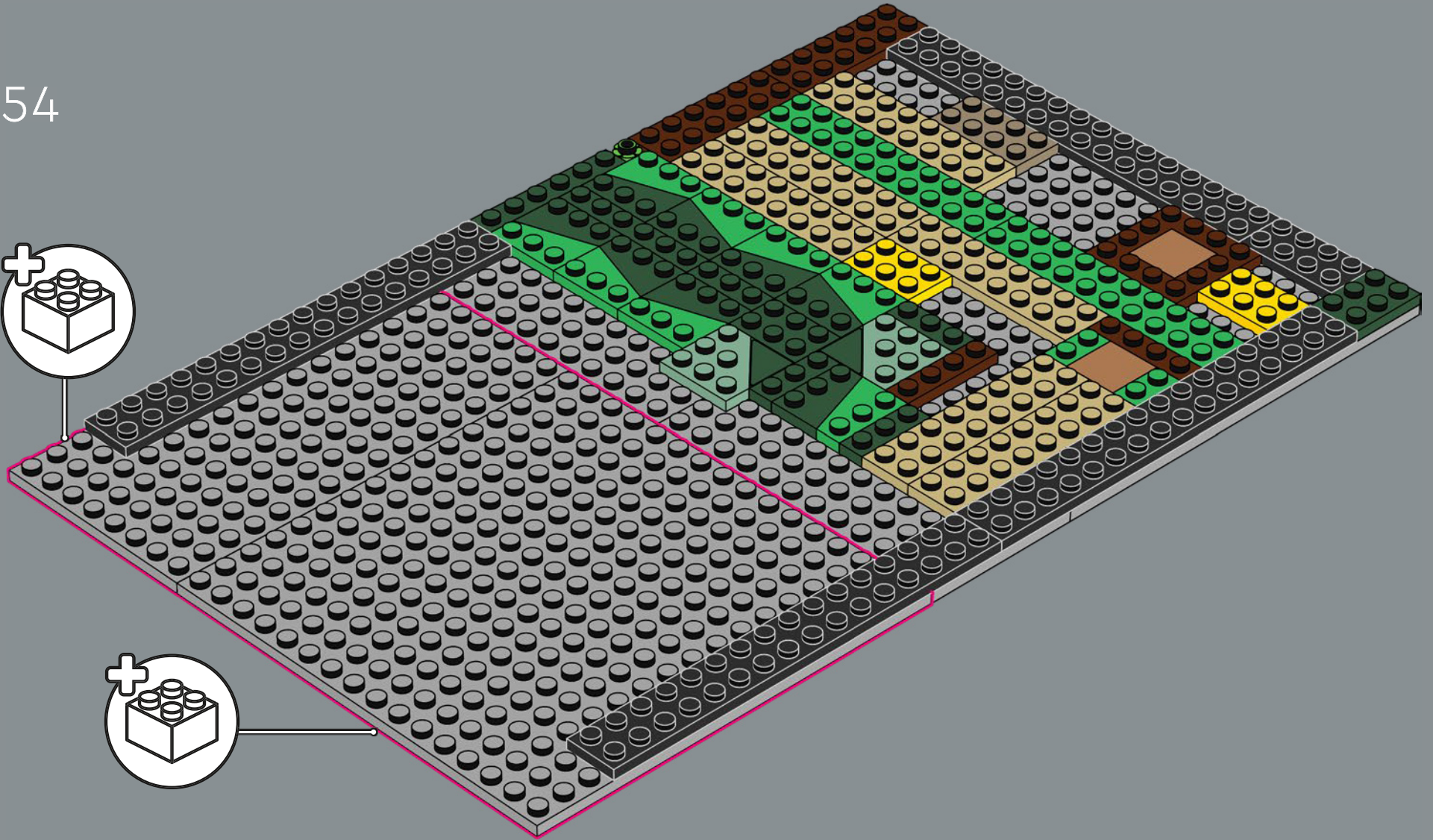

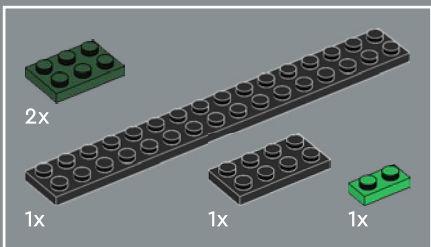

55

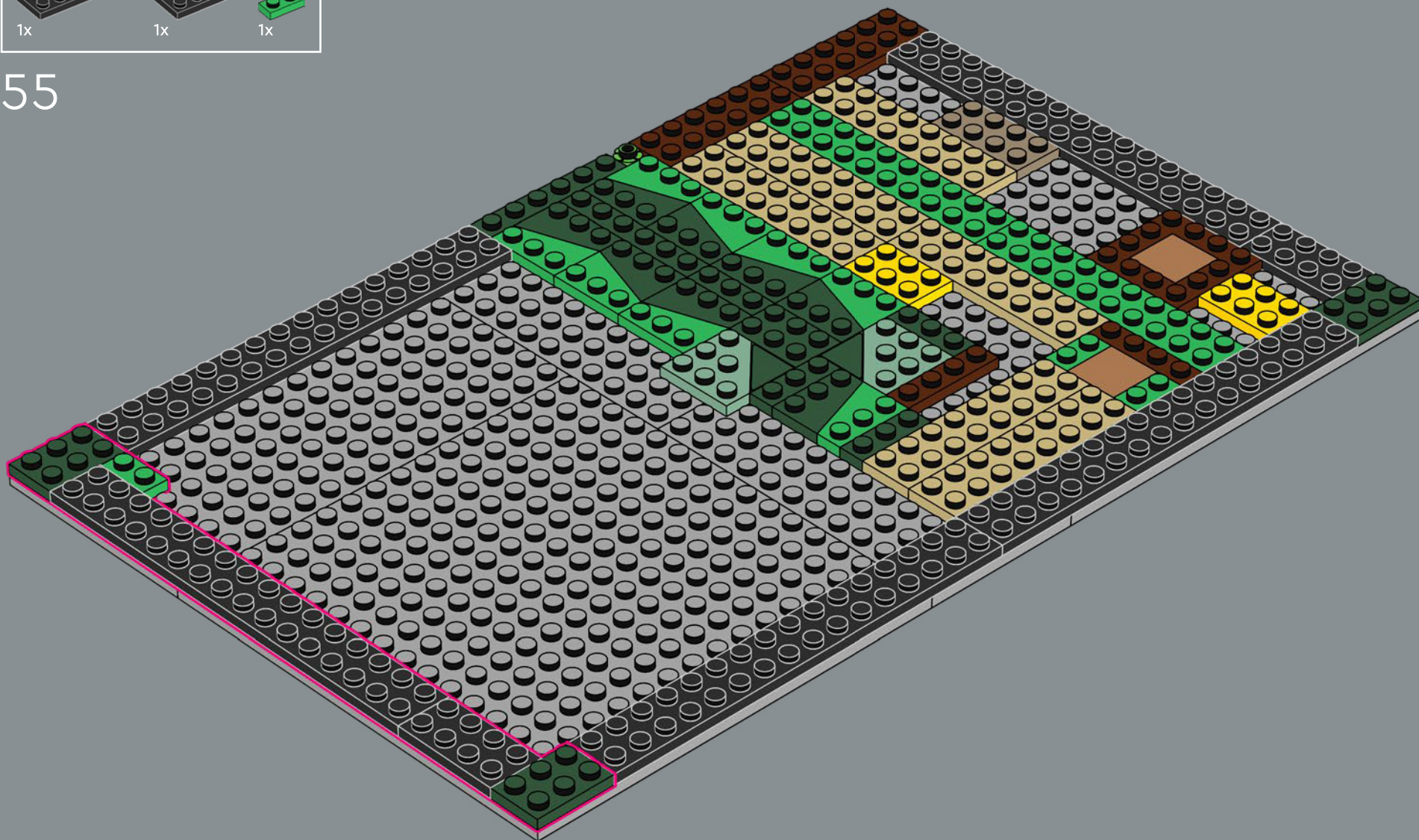

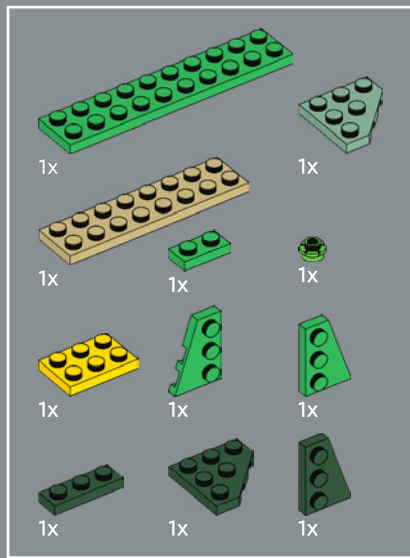

56

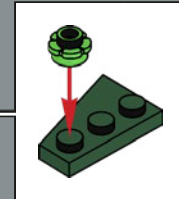
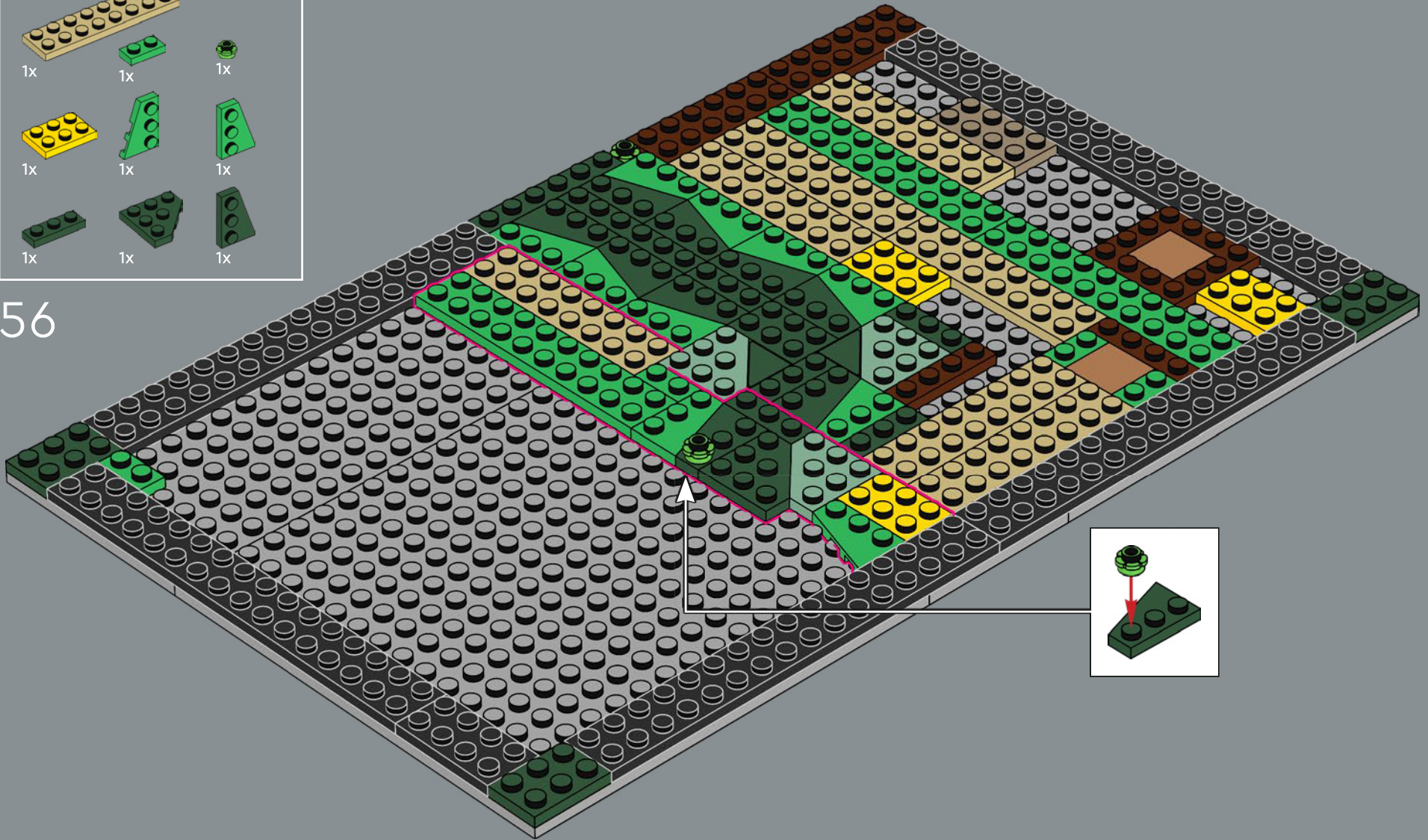

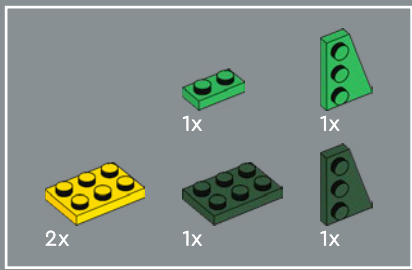

57

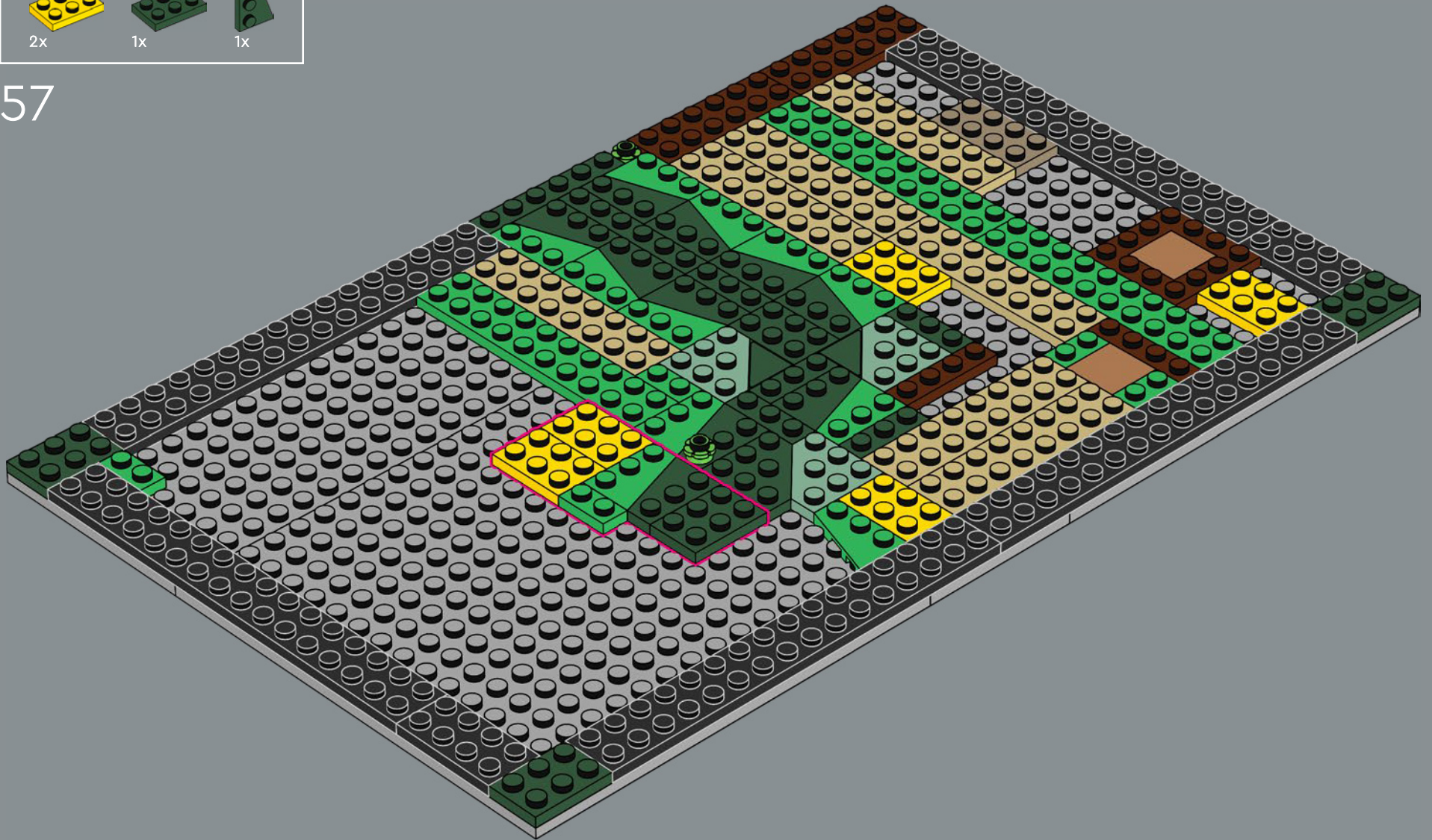

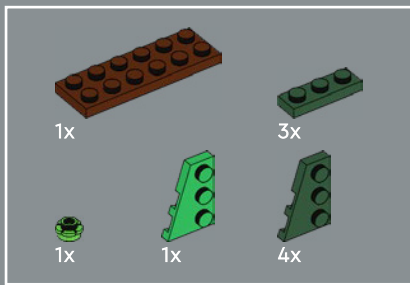

58

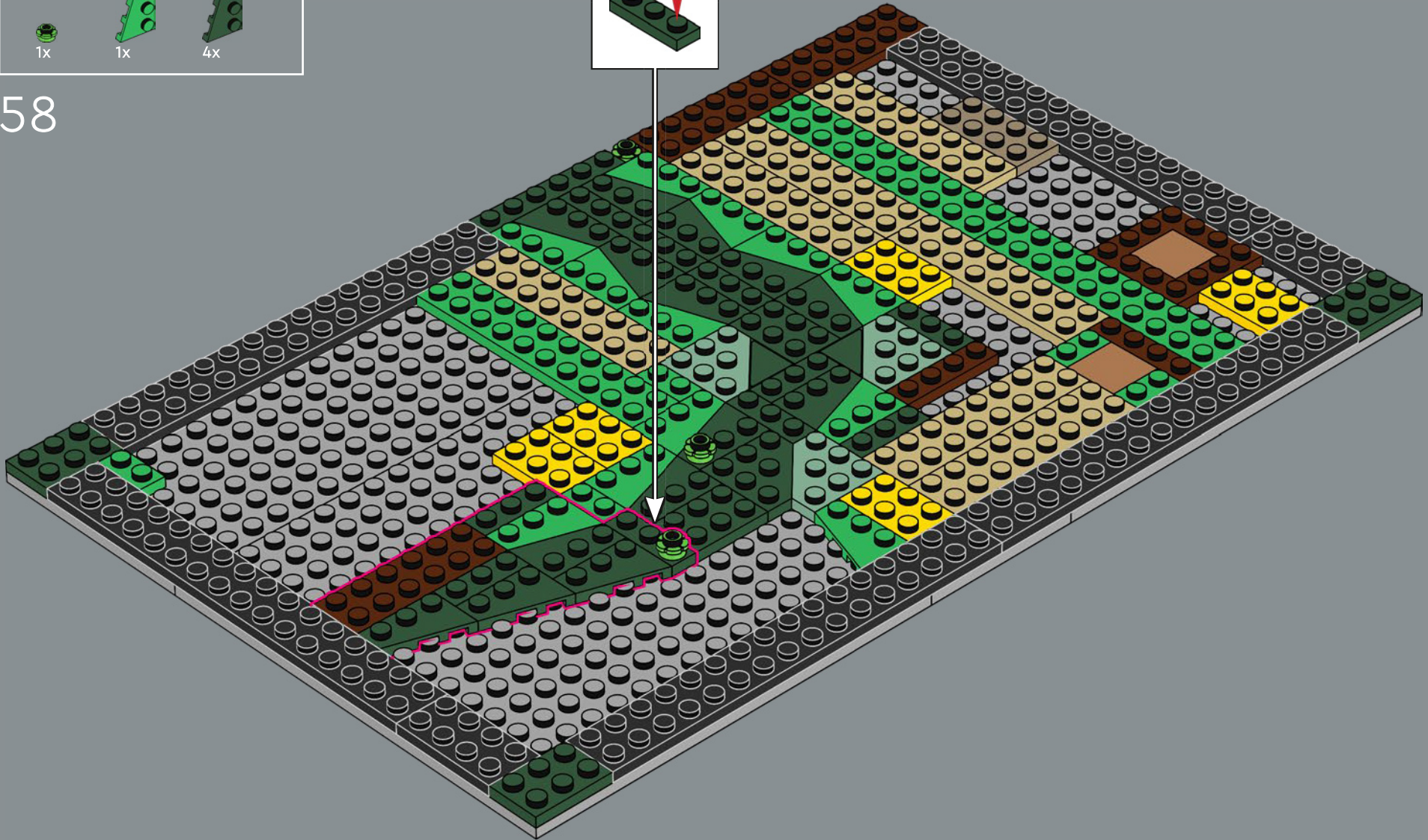
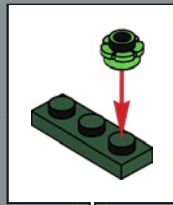

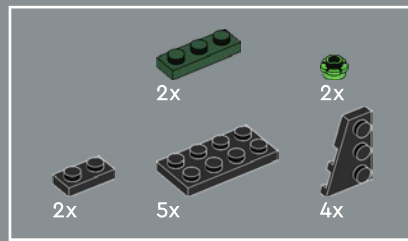

59

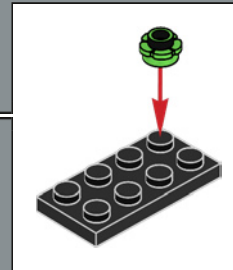
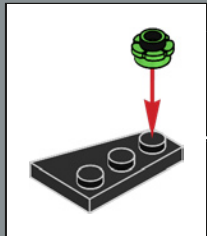
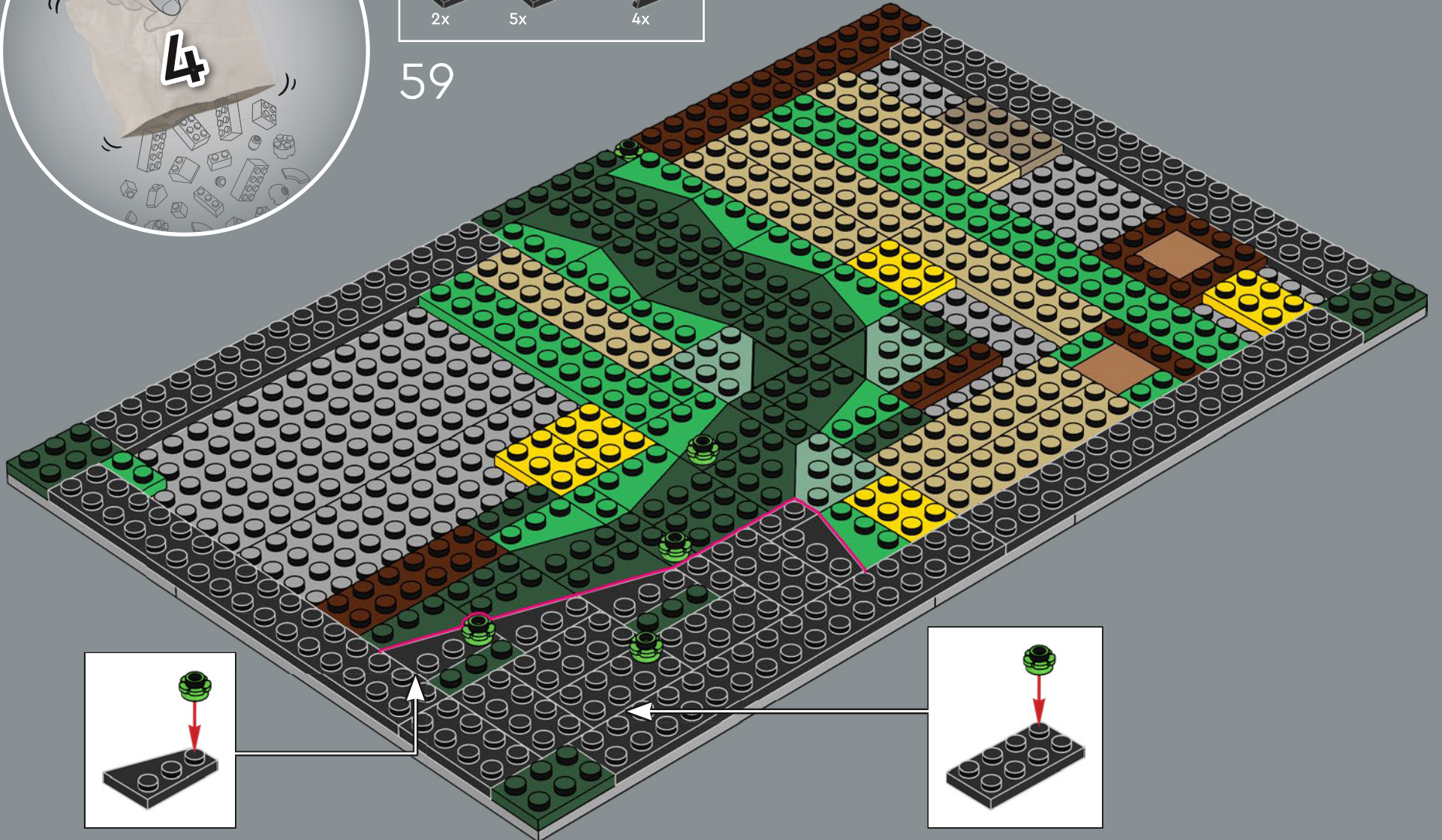

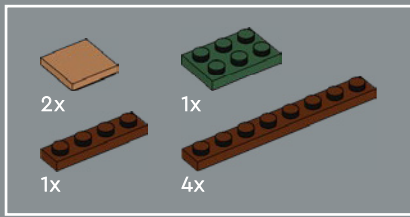

60

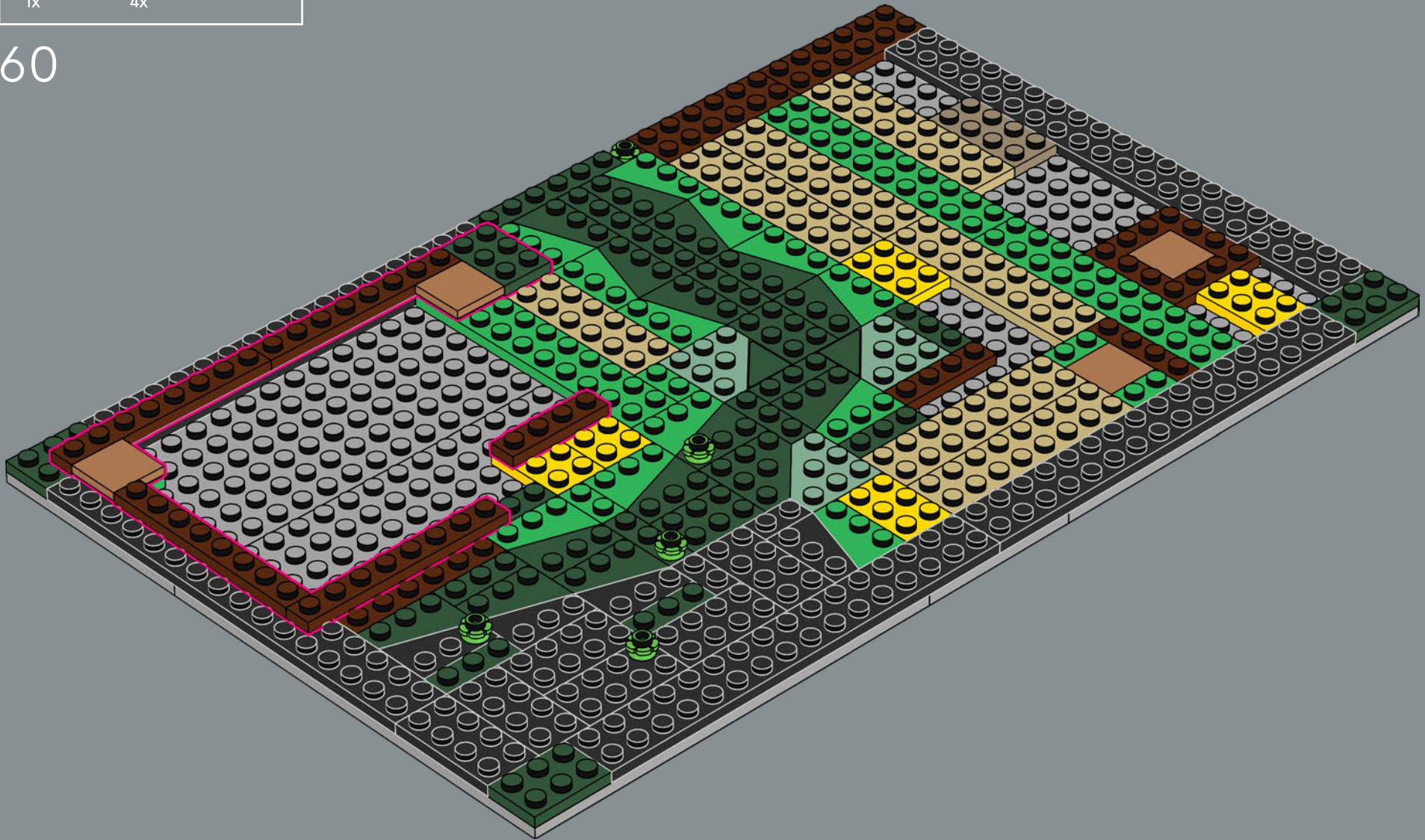

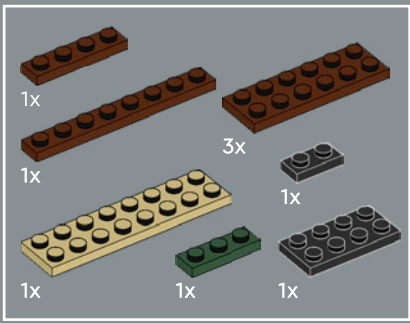

61

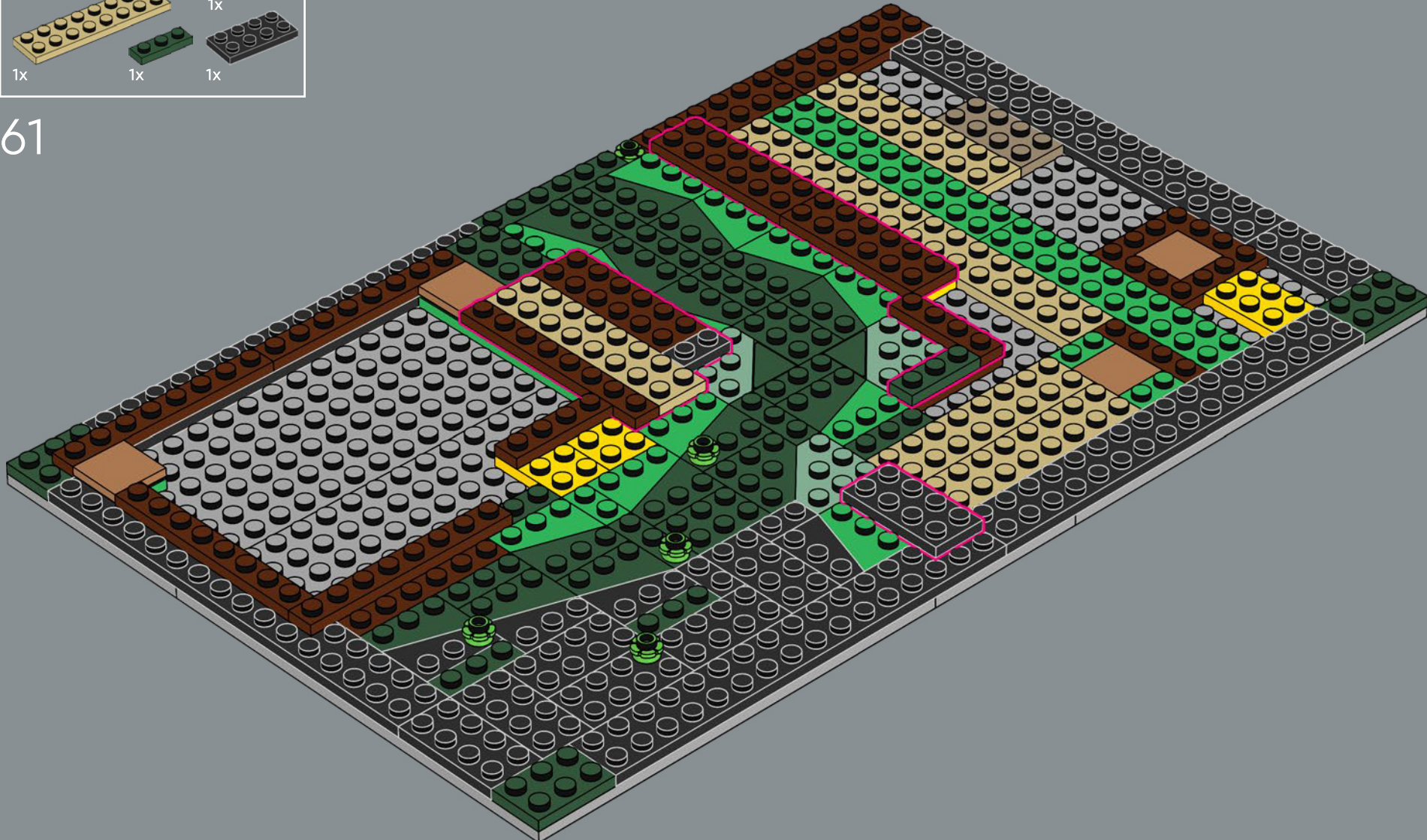

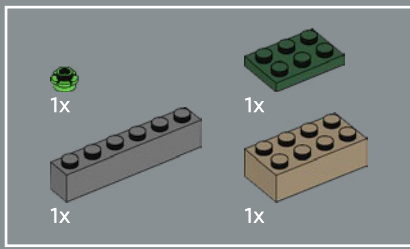

62

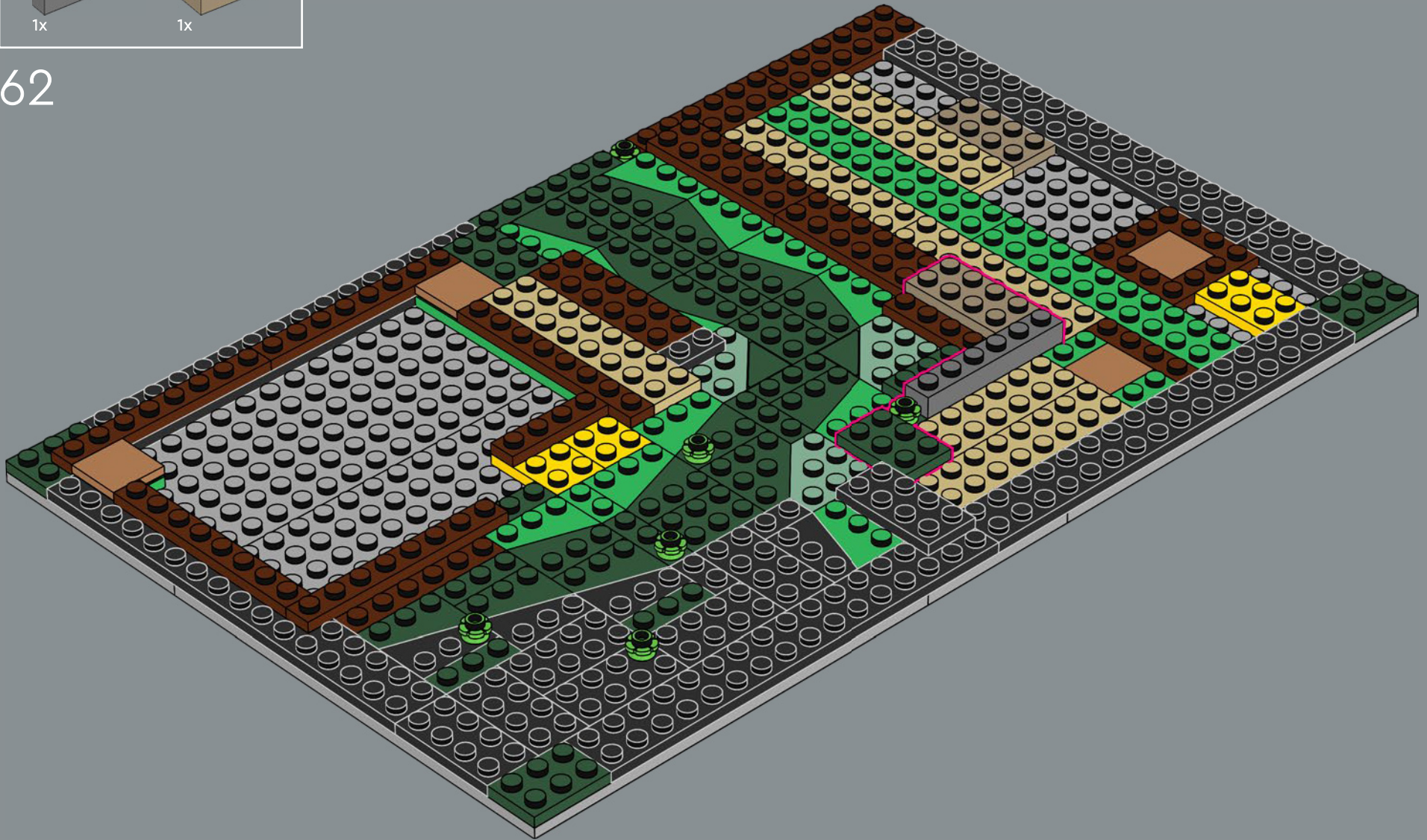

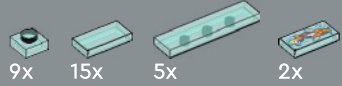

63

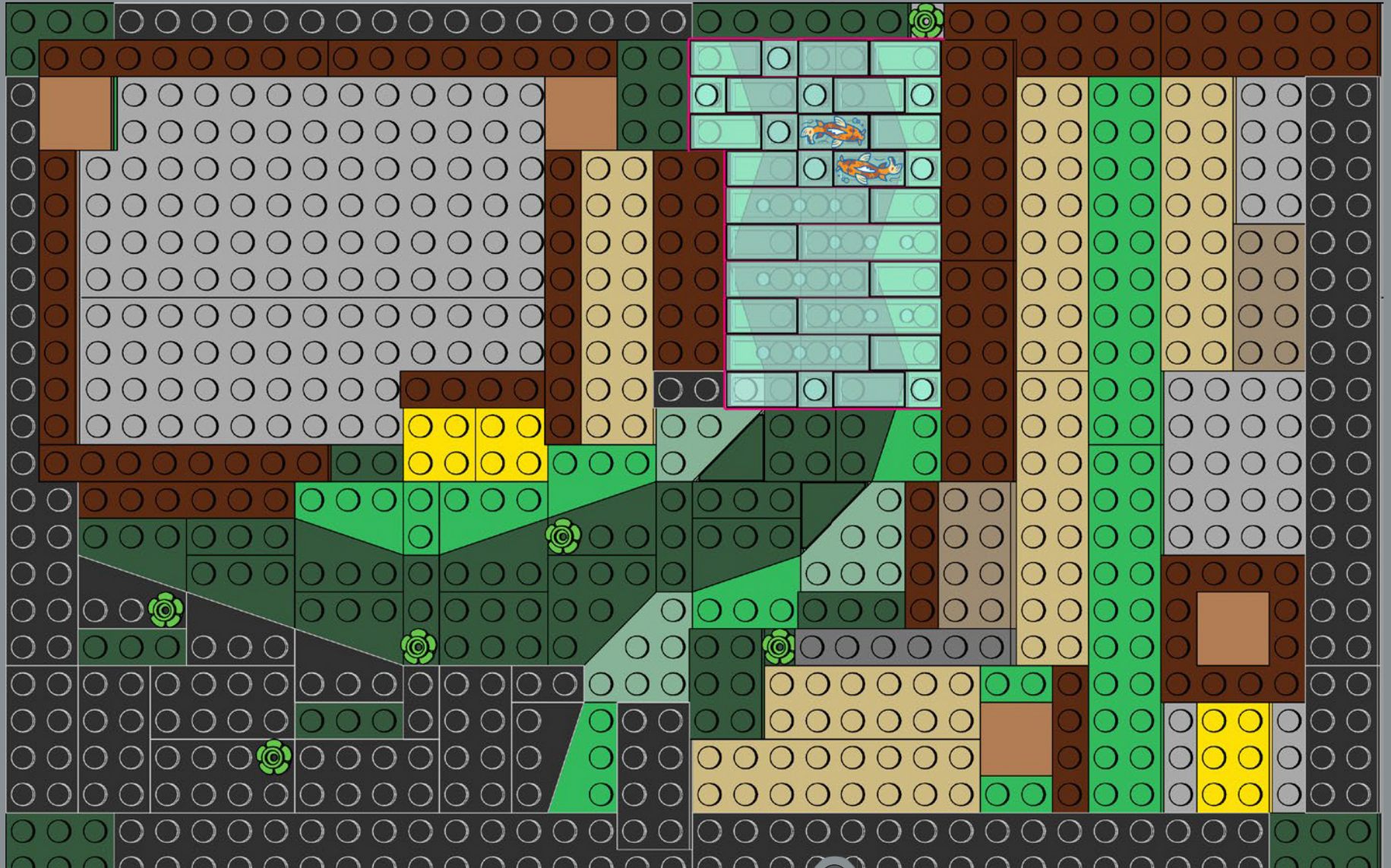



64

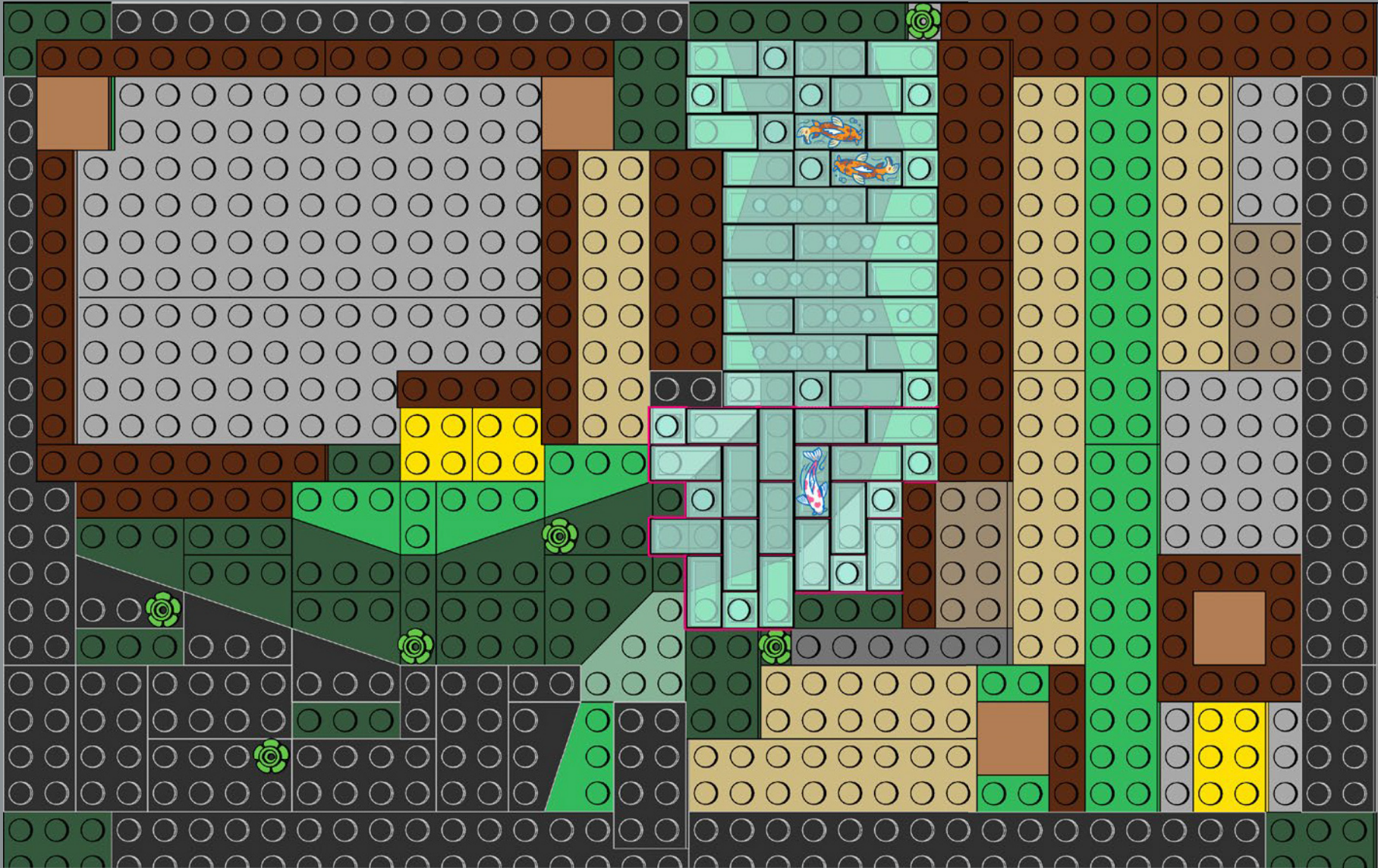



65

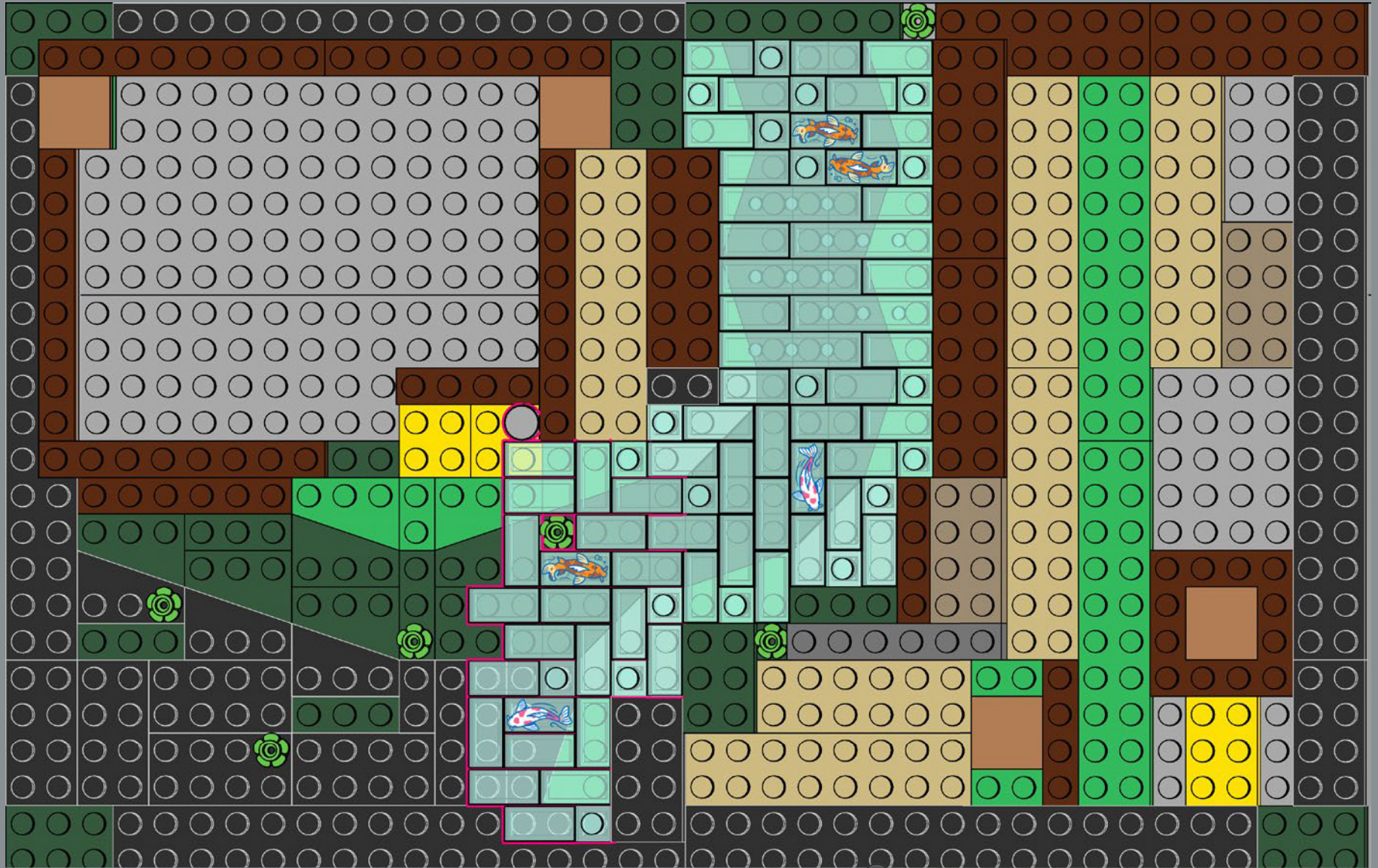

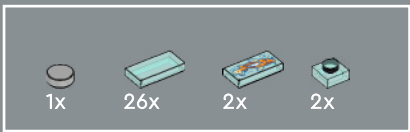

66

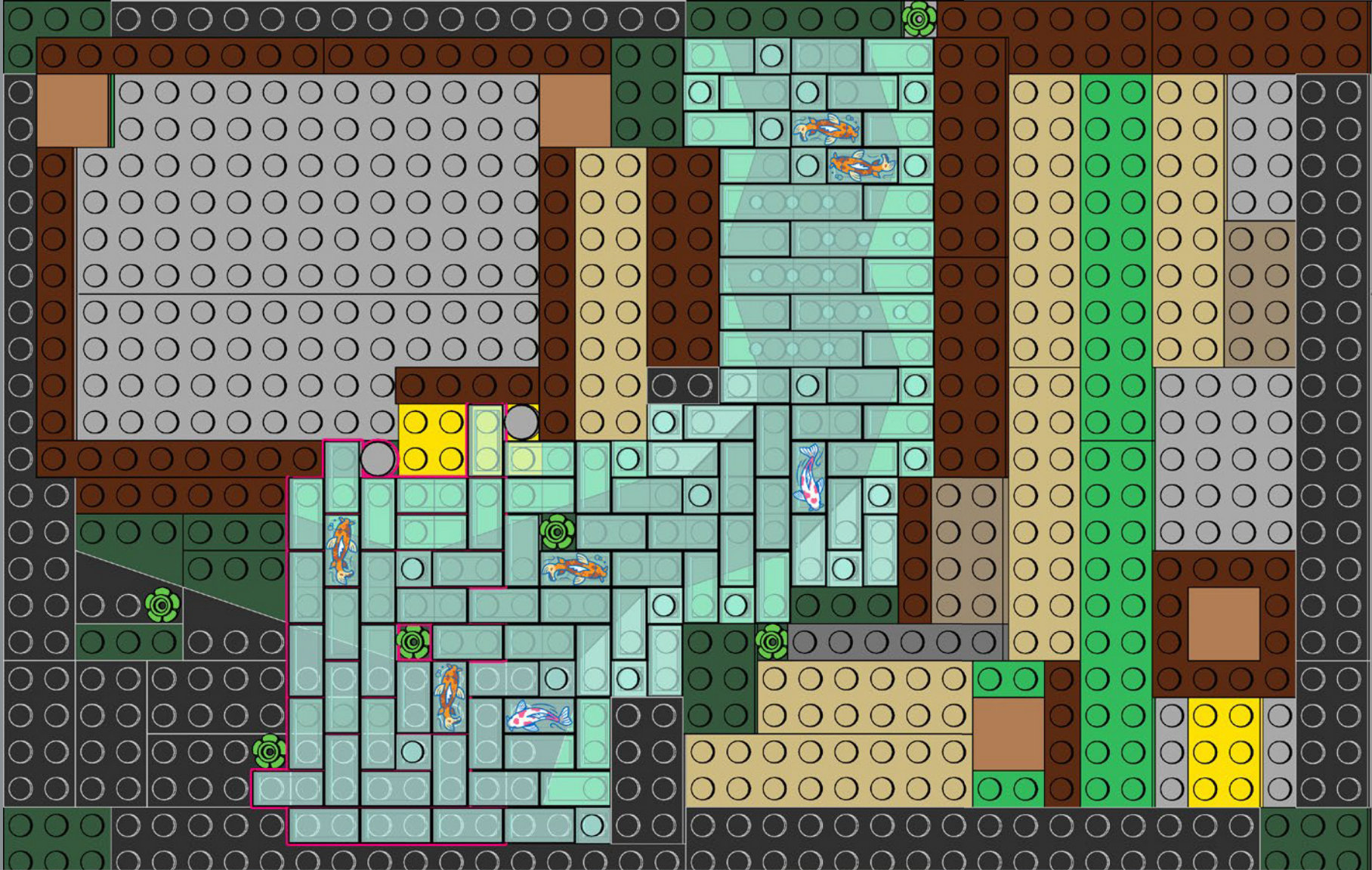

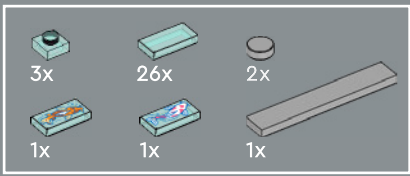

67

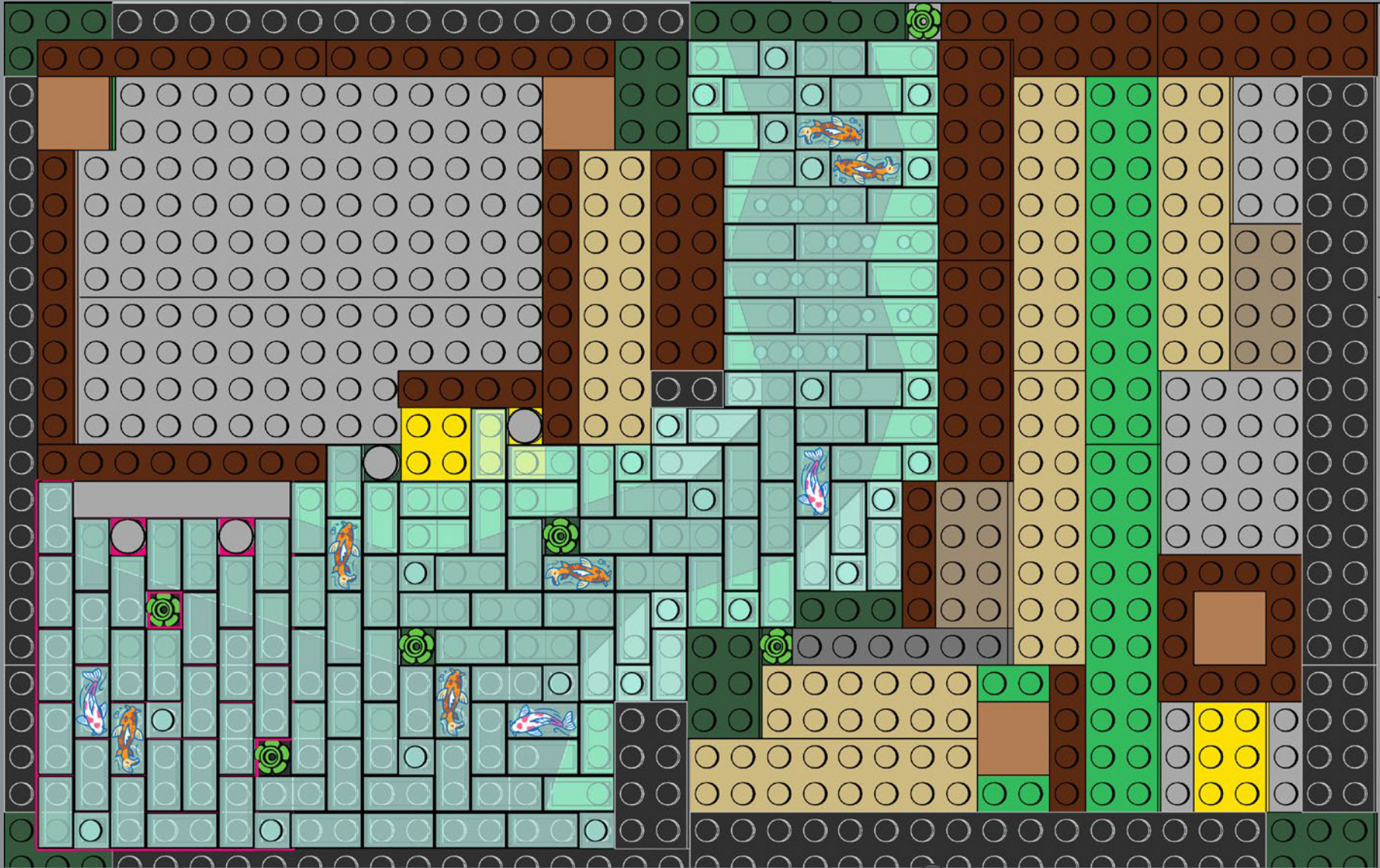



68

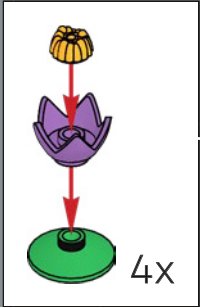

Pond shapes usually represent *kanji* (a system of Japanese writing) that carry significant meanings, such as *kokoro*, or 'heart.'

Les formes des étangs représentent généralement des caractères *kanji* (un système d'écriture japonais) qui ont une signification importante, comme *kokoro*, ou « cœur ».

Con frecuencia, las formas de los estanques representan *kanjis* (caracteres de un sistema de escritura japonés) con significados notables, como el de la palabra *kokoro*, que quiere decir "corazón".

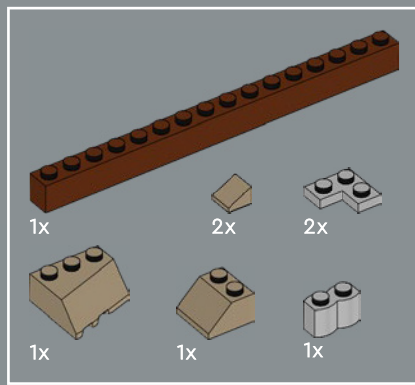

69



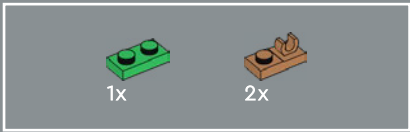

70



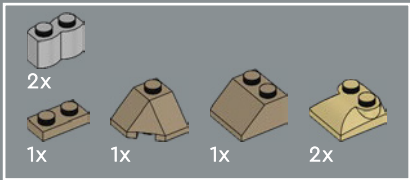

71

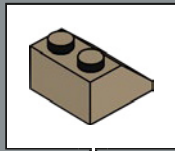
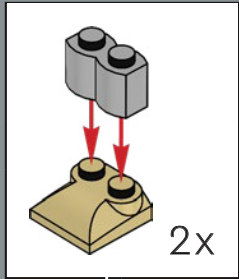

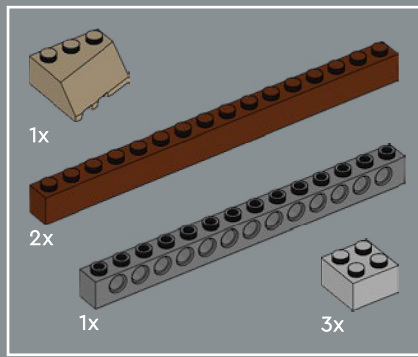

72



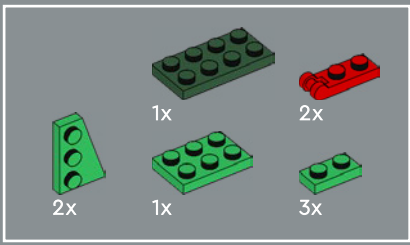

73

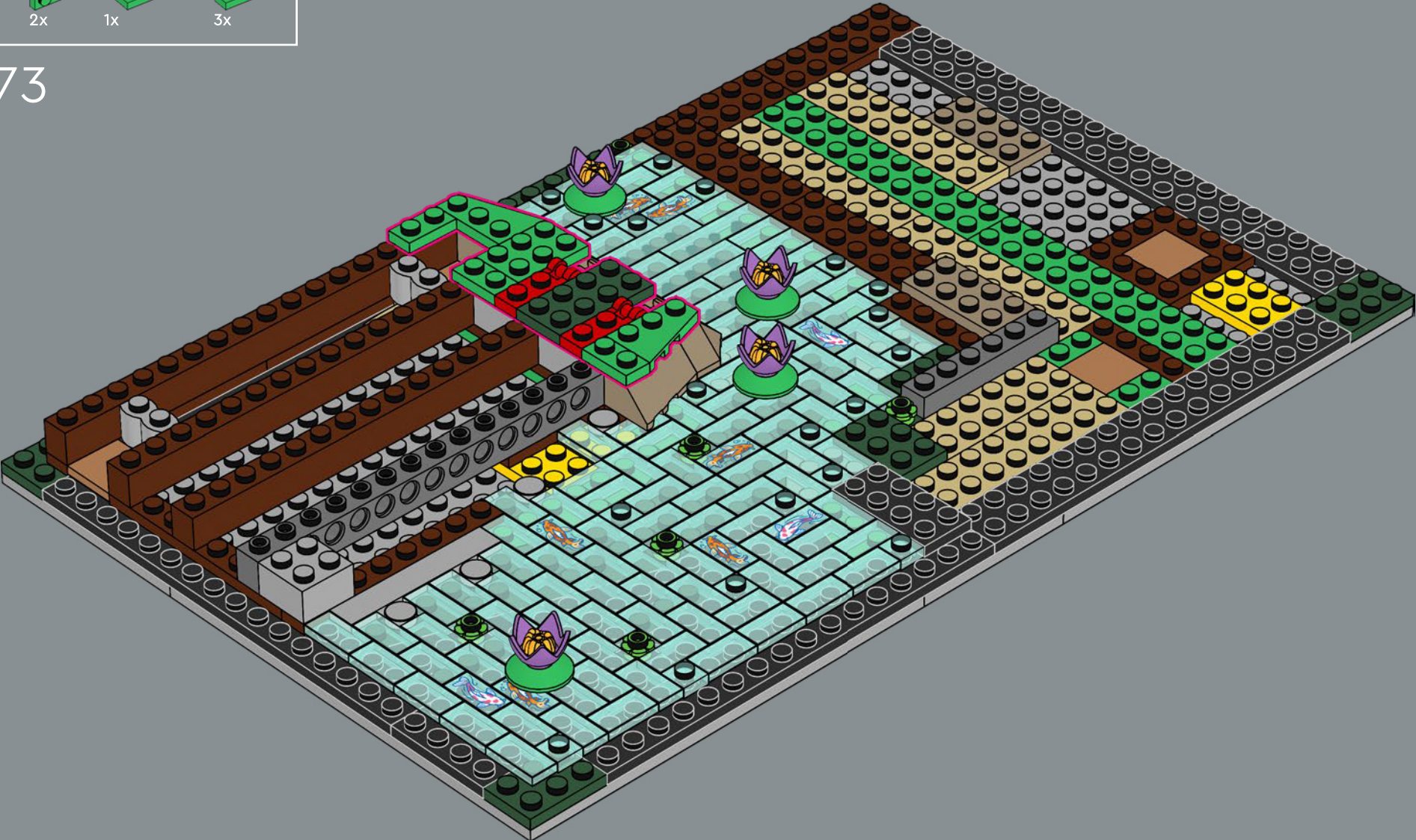

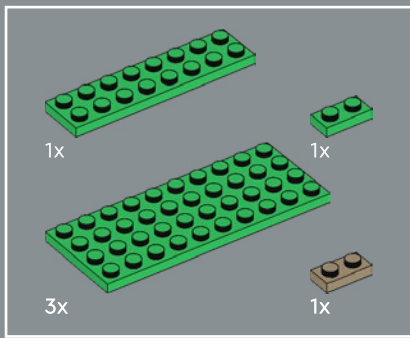

74



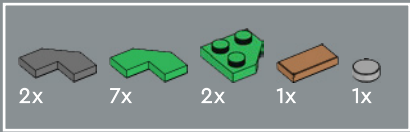

75



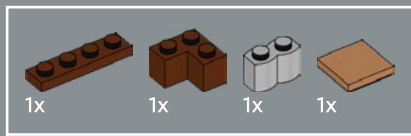

76



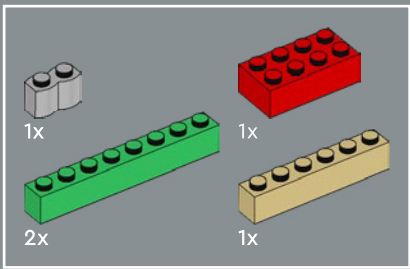

77



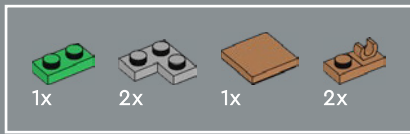

78

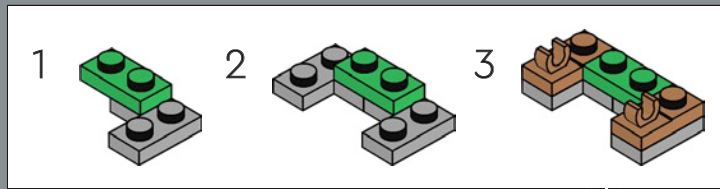

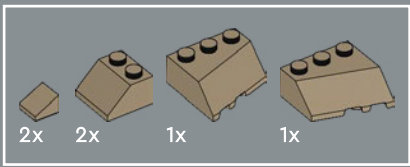

79

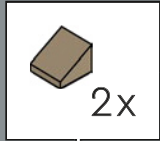

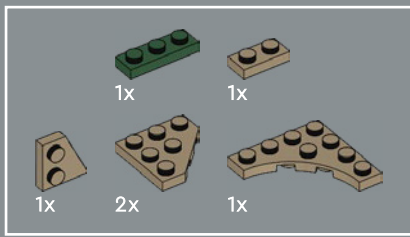

80



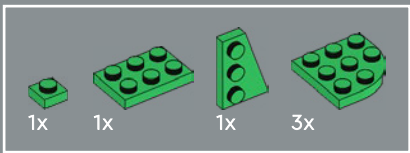

81



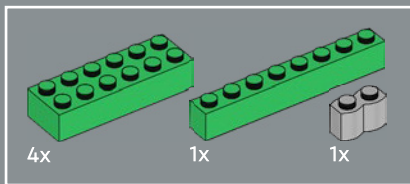

82



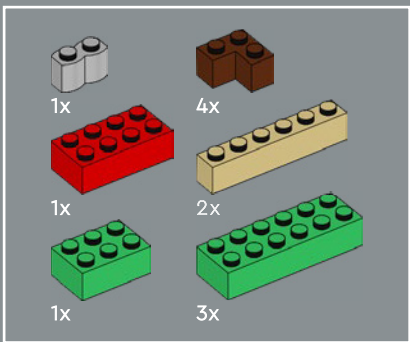

83



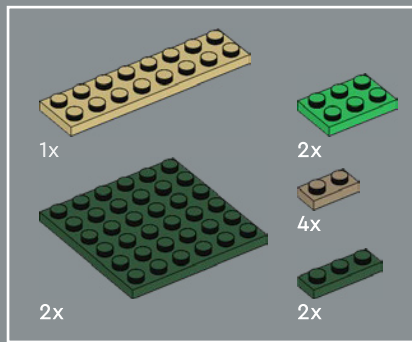

84



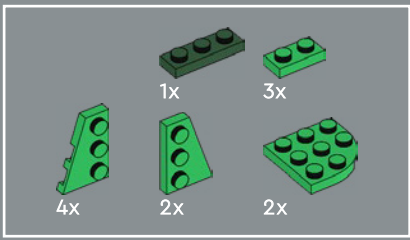

85



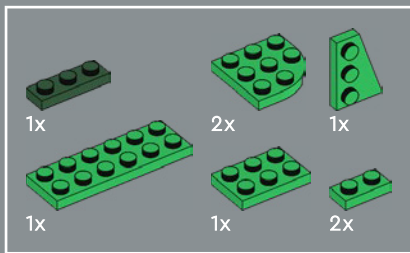

86



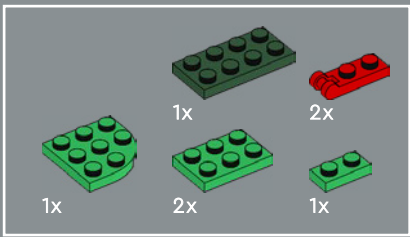

87



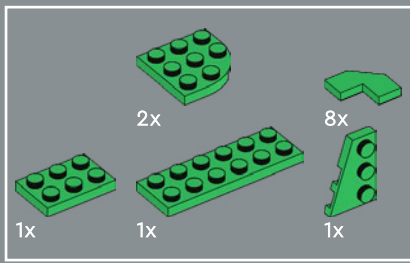

88



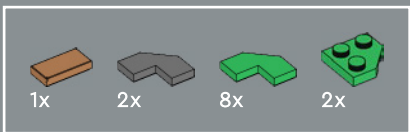

89



Tranquil garden islands can be symbols of mystical or mythical mountains, turtles, or cranes (often associated with longevity).

Les îles d'un jardin zen peuvent symboliser des montagnes mystiques ou mythiques, des tortues ou des grues (souvent associées à la longévité).

Las islas de los jardines meditativos pueden ser símbolos de montañas, tortugas o grullas (a menudo asociadas con la longevidad) místicas o de la mitología.

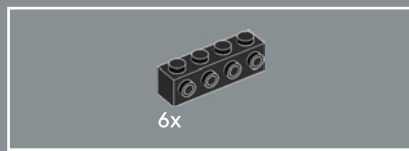

90



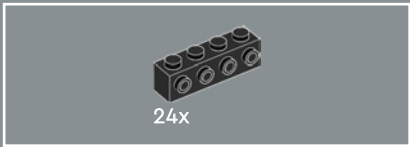

91



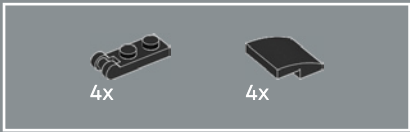

92

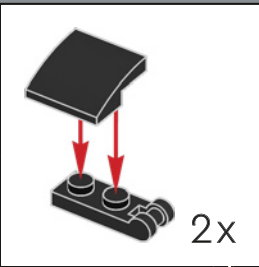
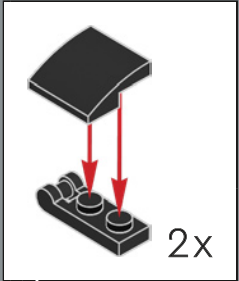

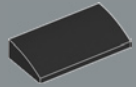

26x

93



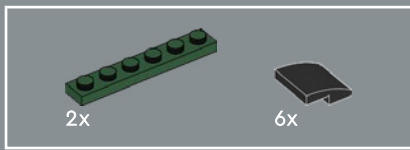

94

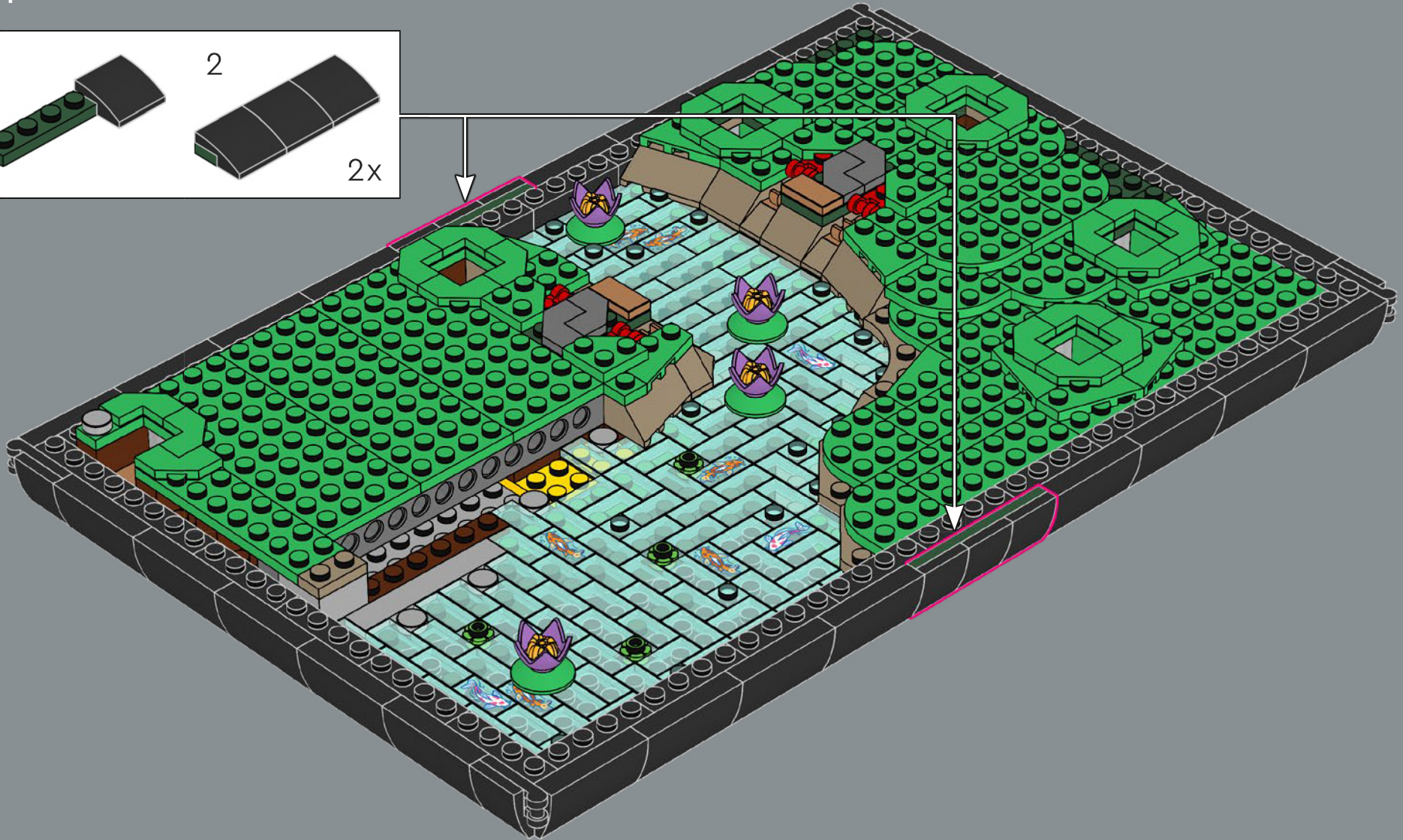
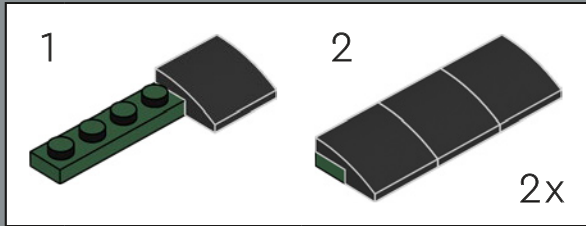

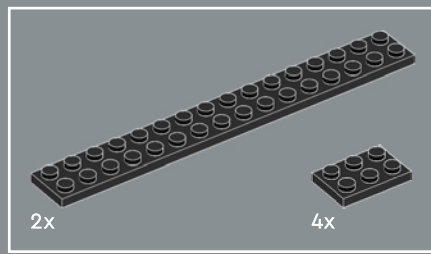

95

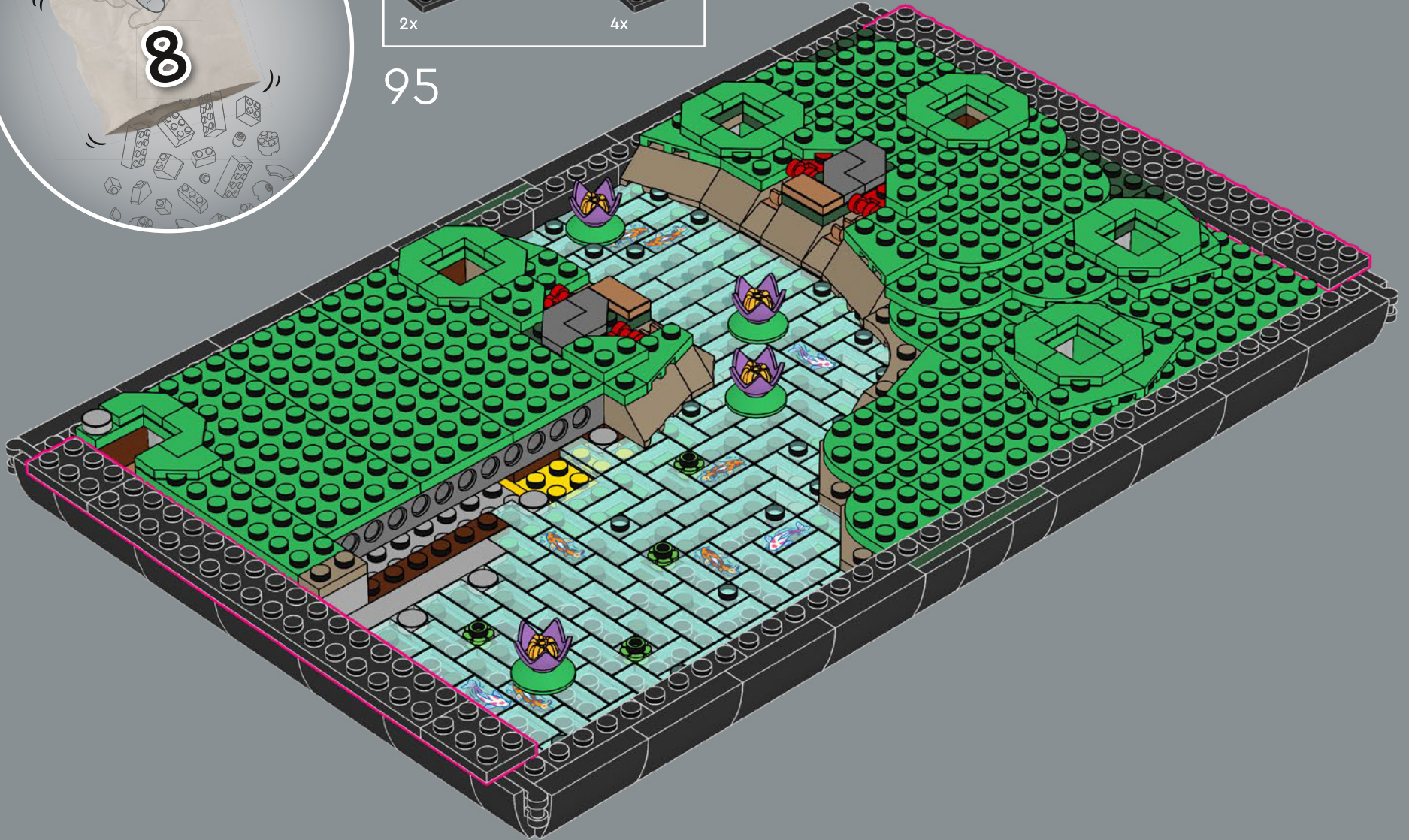

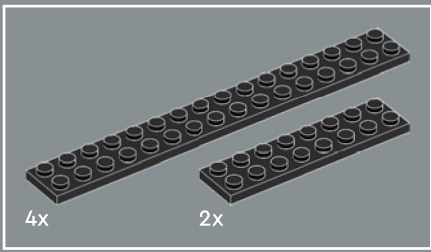

96



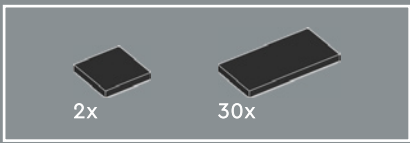

Reconnaissez-vous la conception du cadre de base de ce modèle ? Nous avons repris la conception du pot de fleurs de l'ensemble LEGO® Icons 10281 Le bonsaï pour obtenir un aspect similaire.

¿Reconoces el diseño de la base de este modelo? Reutilizamos el diseño de la maceta del Bonsái LEGO® Icons (10281) para emular su apariencia y la sensación que inspira.

97



Recognize the base frame design for this model? We reused the flowerpot design from the LEGO® Icons 10281 Bonsai Tree set to emulate a similar look and feel.

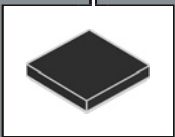
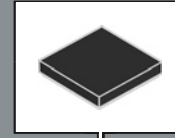

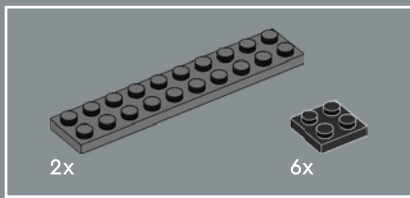

98

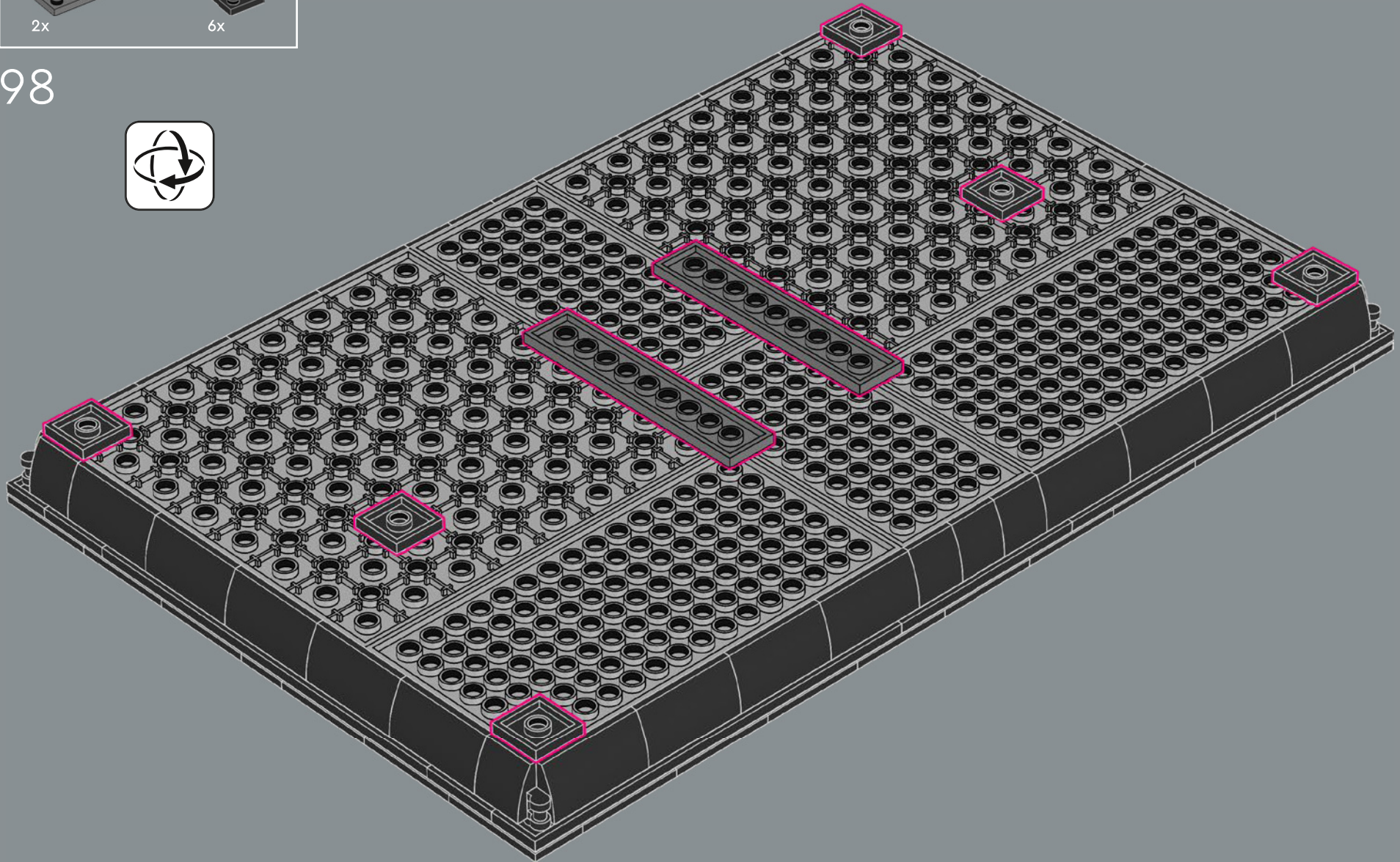



99

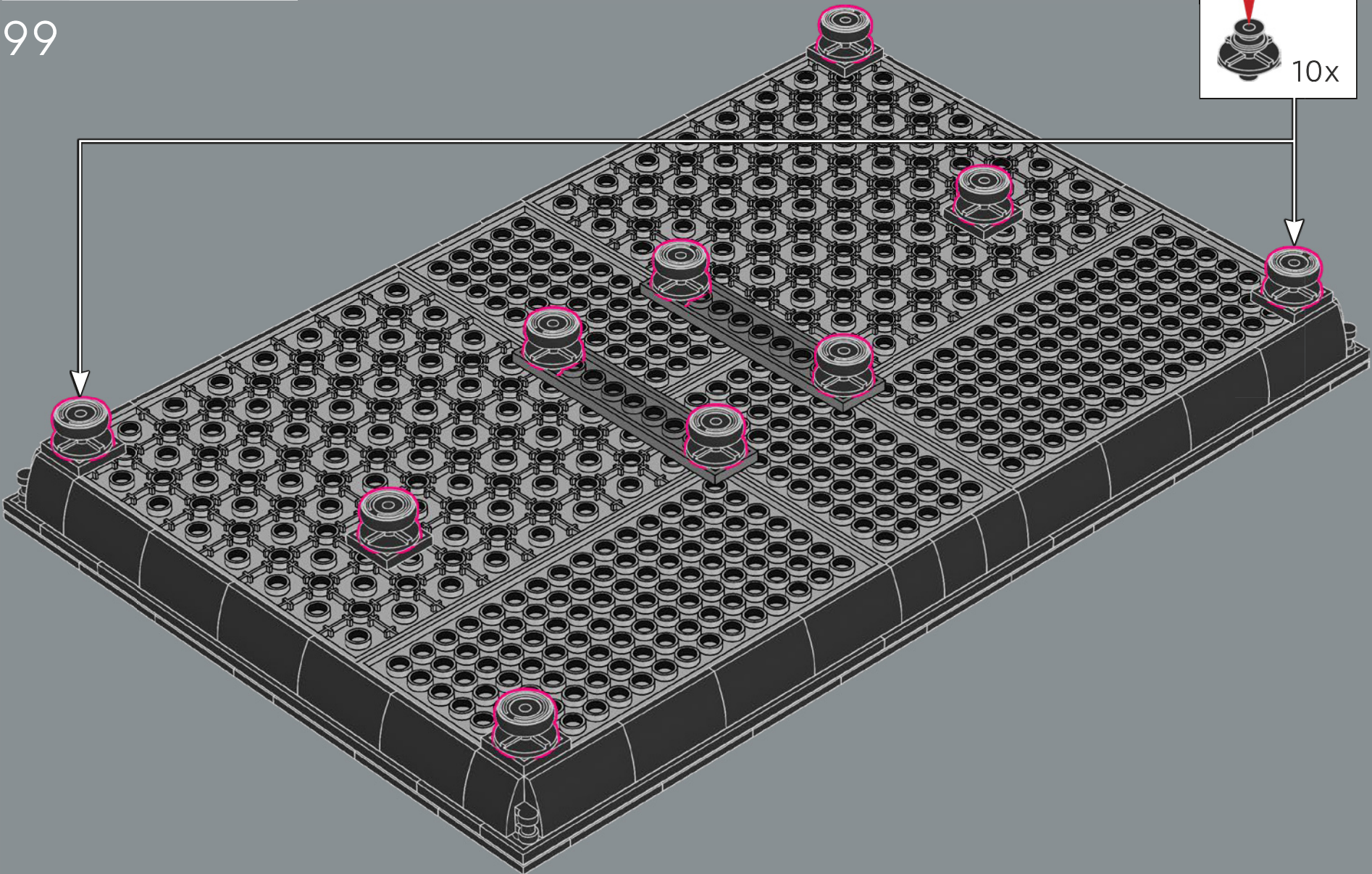
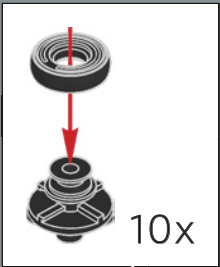



2x 12x 4x 16x



100

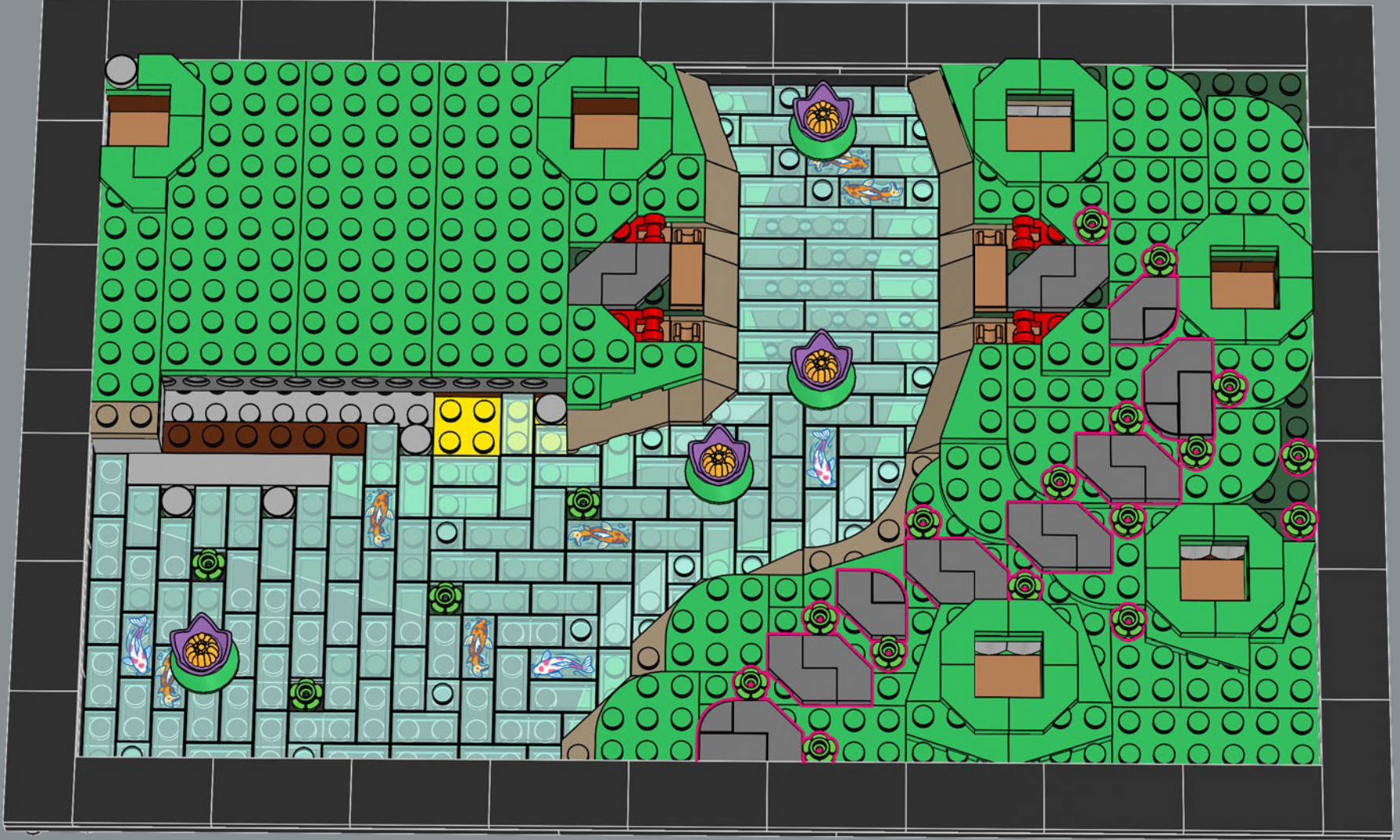

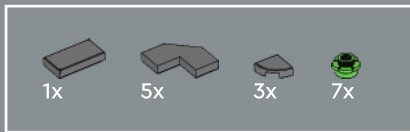

Winding pathways invite you to see the garden (and maybe other things?) from different perspectives.
Les sentiers sinueux vous invitent à admirer le jardin (et peut-être d'autres choses ?) sous différents angles.
Los sinuosos senderos te invitan a mirar el jardín (y quizá otras cosas) desde distintas perspectivas.

101

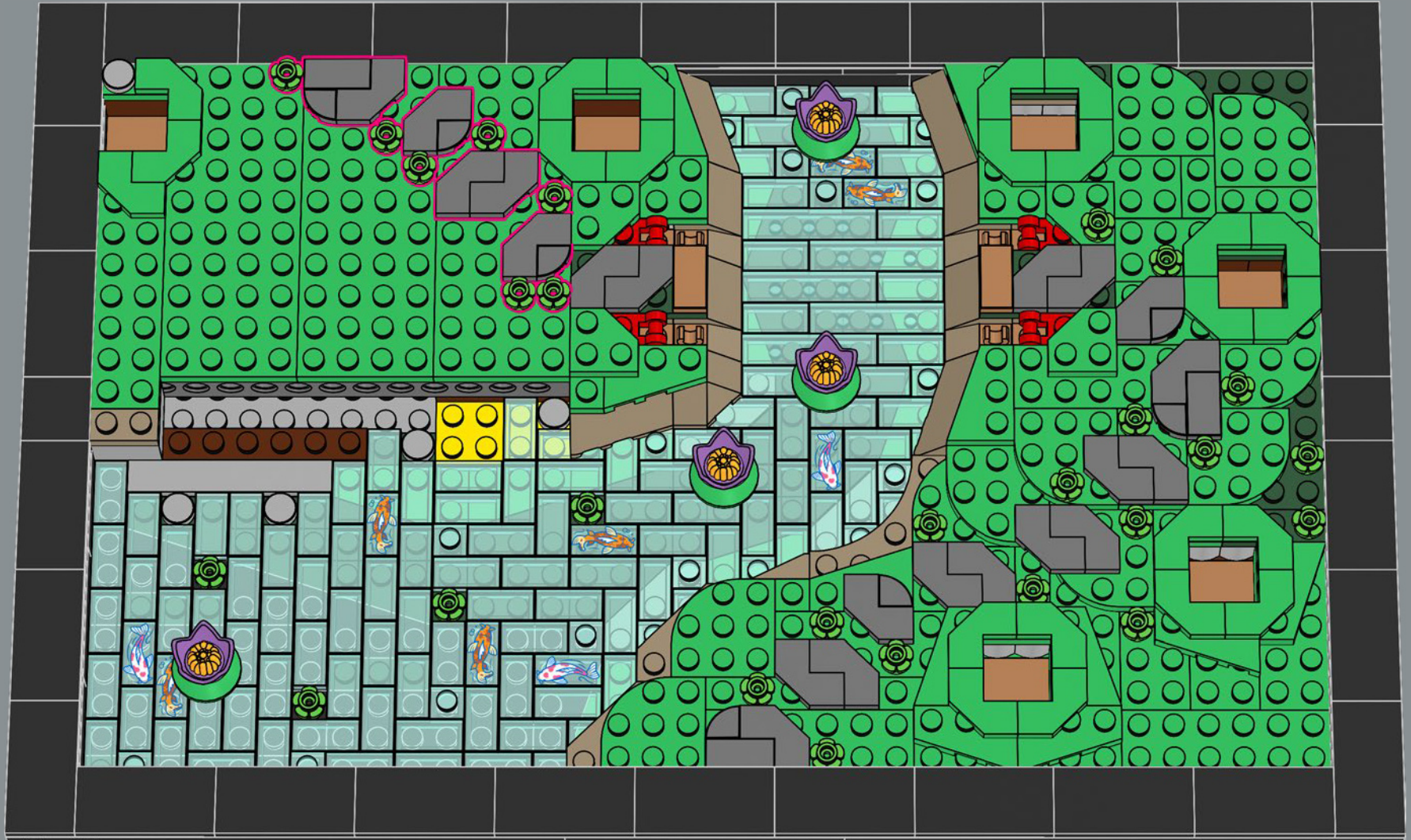

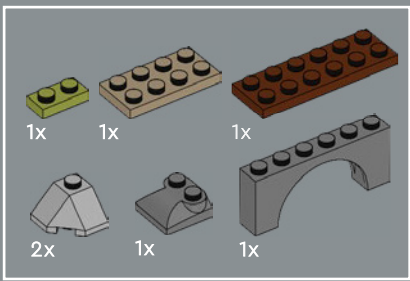

102

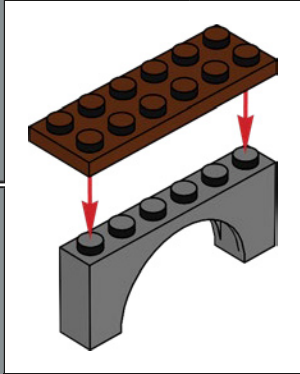

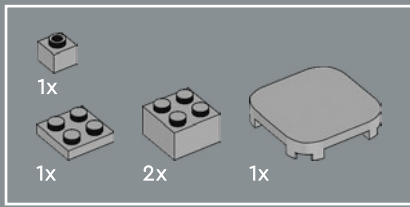

103

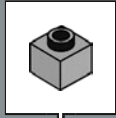
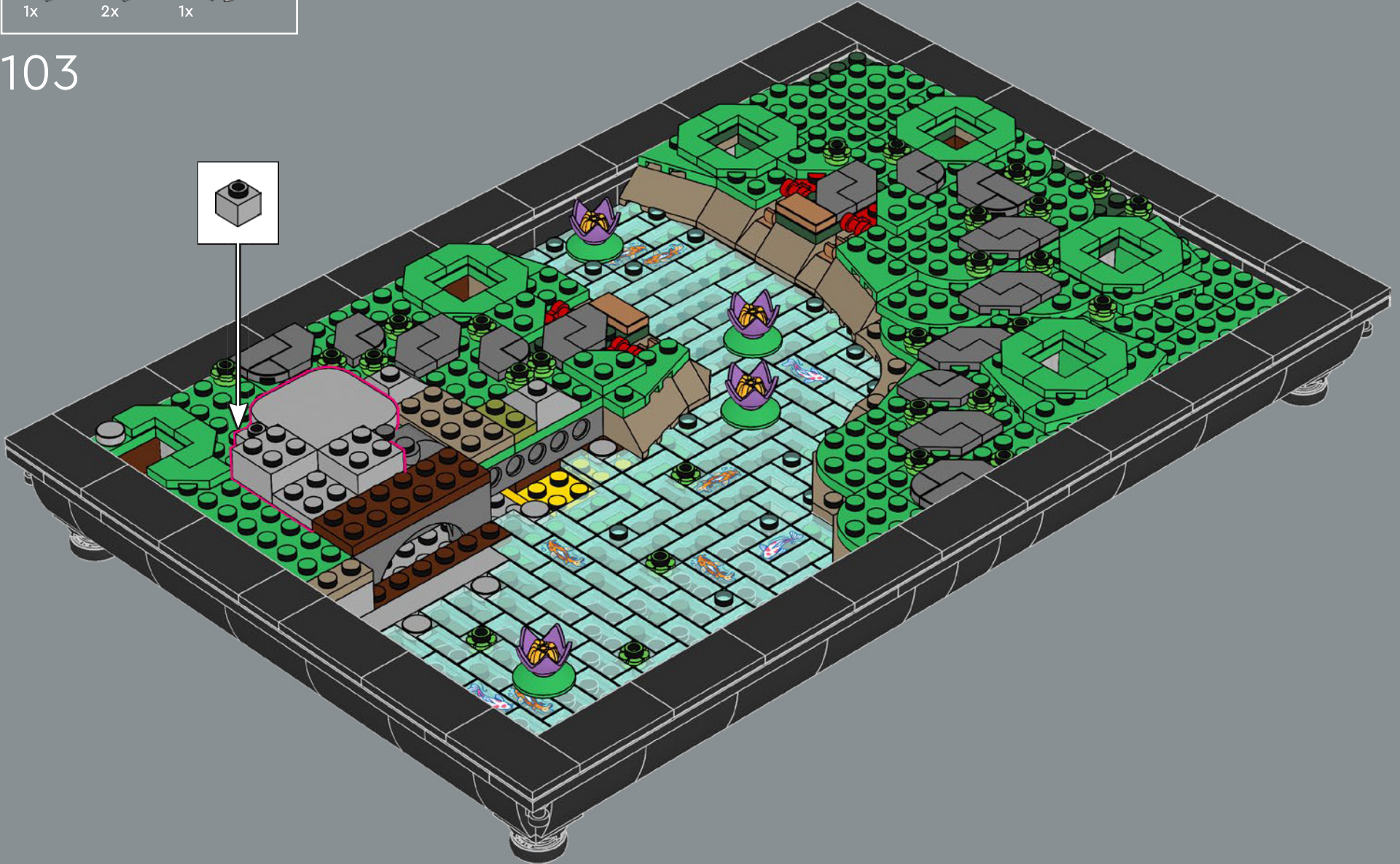

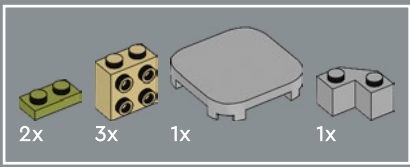

104

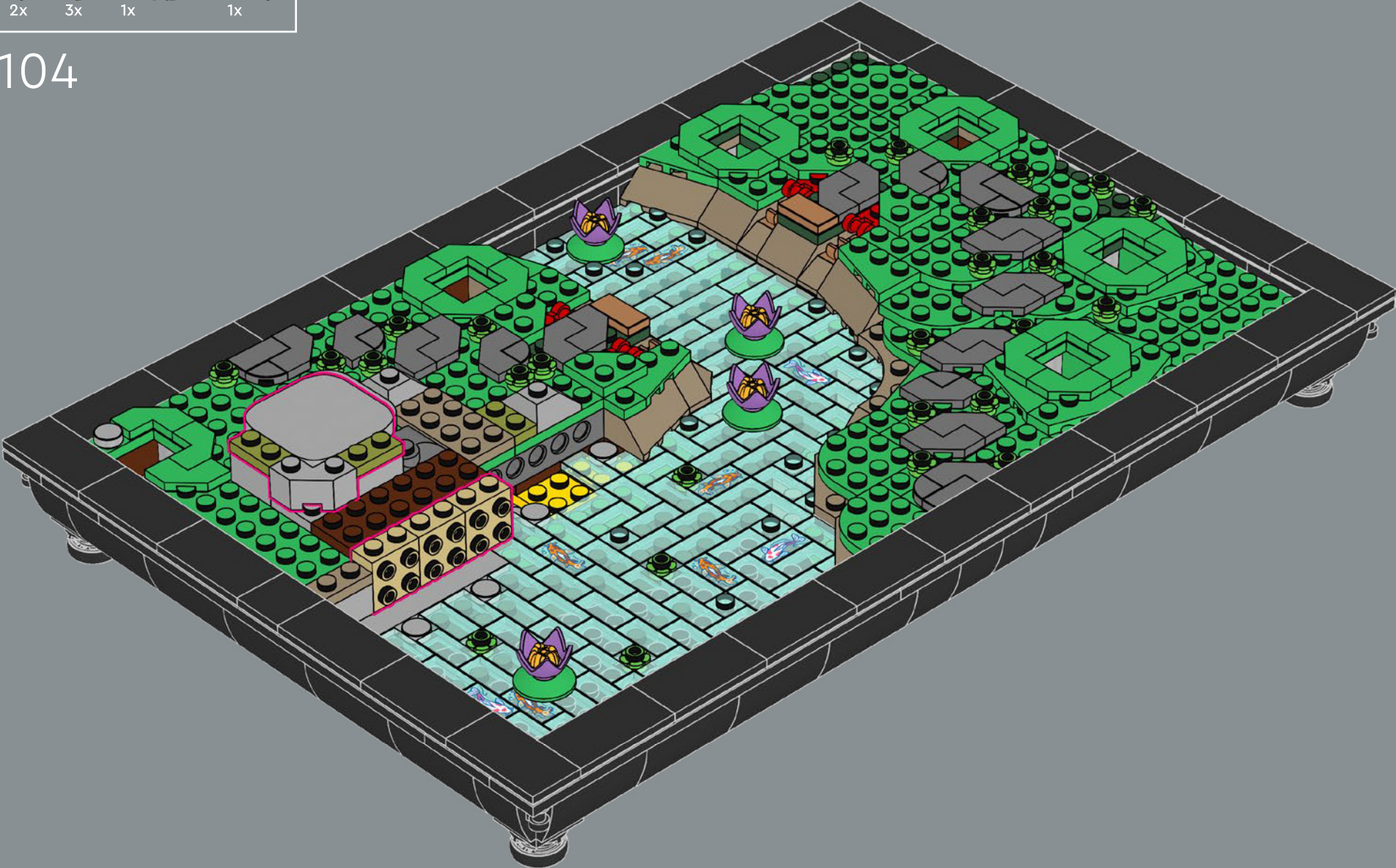

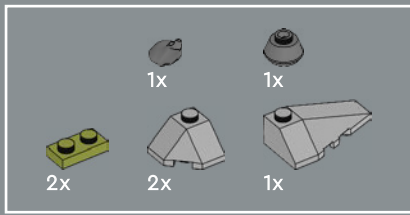

105

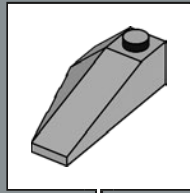

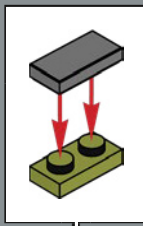
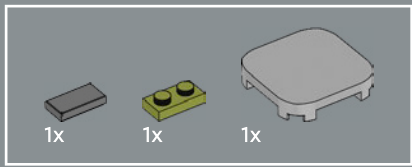

106



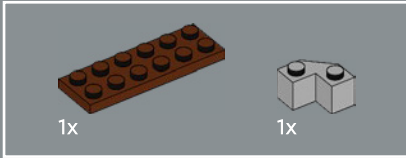
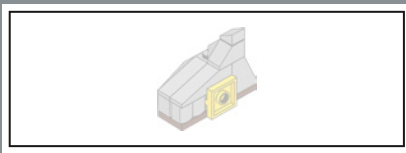

107

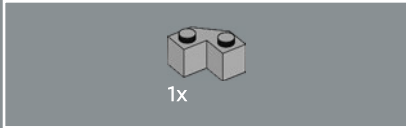
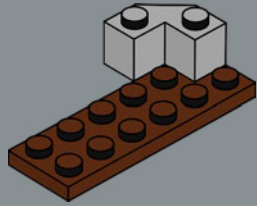

108

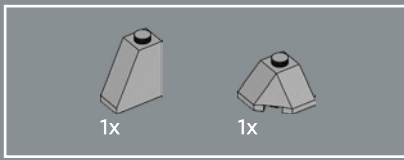
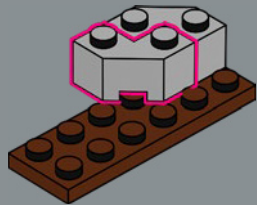

109

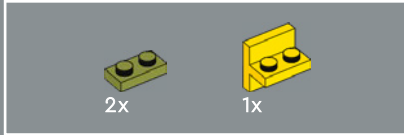
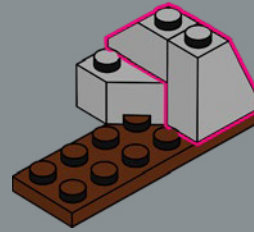

110

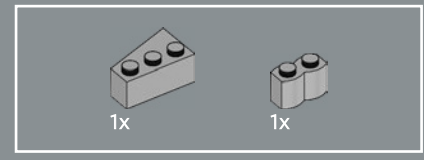
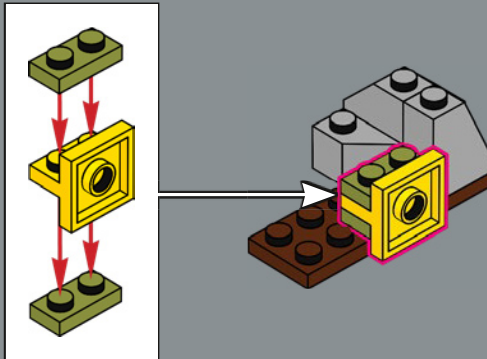

111

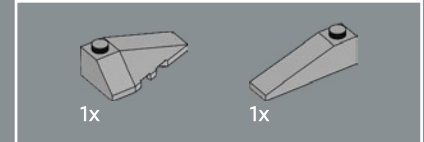
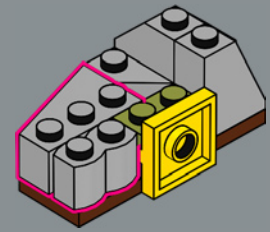

112

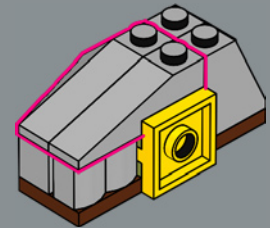

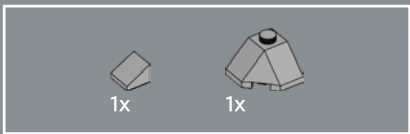

113

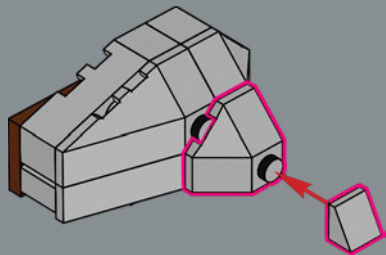

114



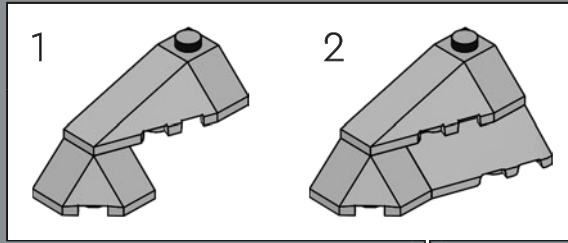
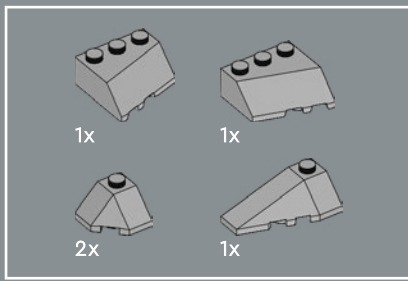

115

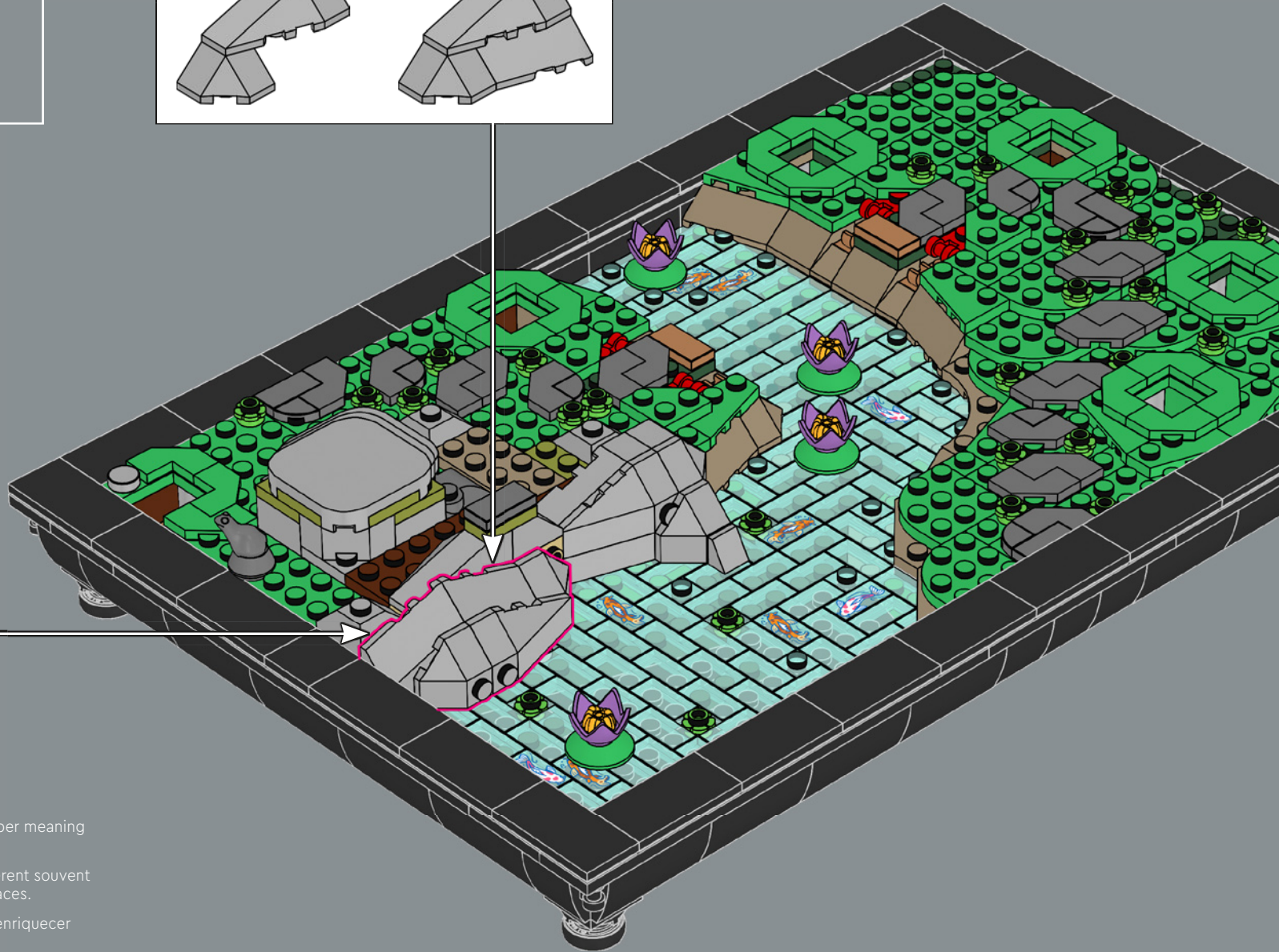
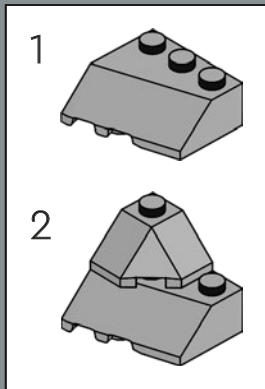

Stones, rocks and sand often bring deeper meaning to the grounds.

Les pierres, les rochers et le sable confèrent souvent une signification plus profonde aux espaces.

Las piedras, las rocas y la arena suelen enriquecer los terrenos.

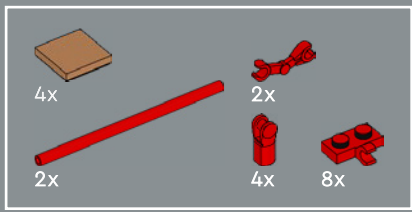

116

1

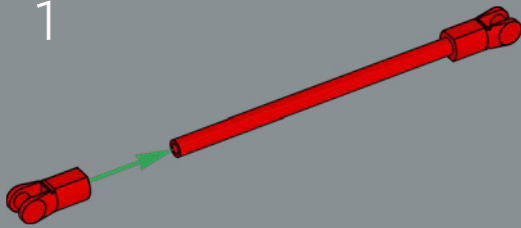

2

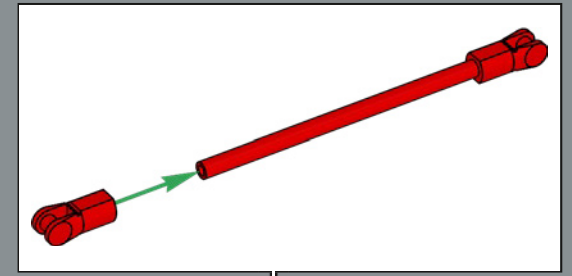
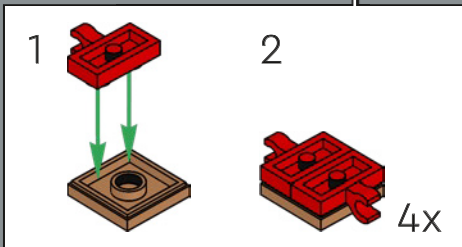
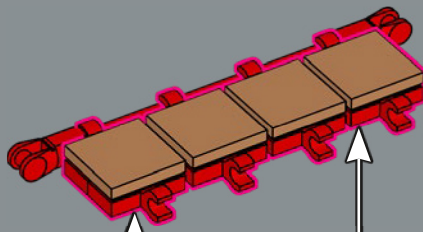

3

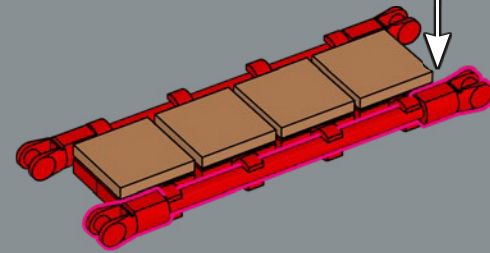

4

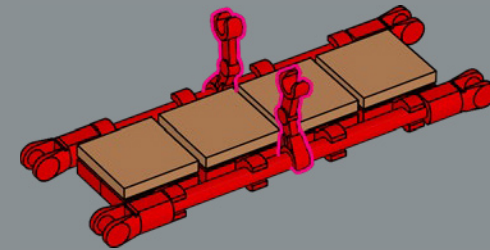

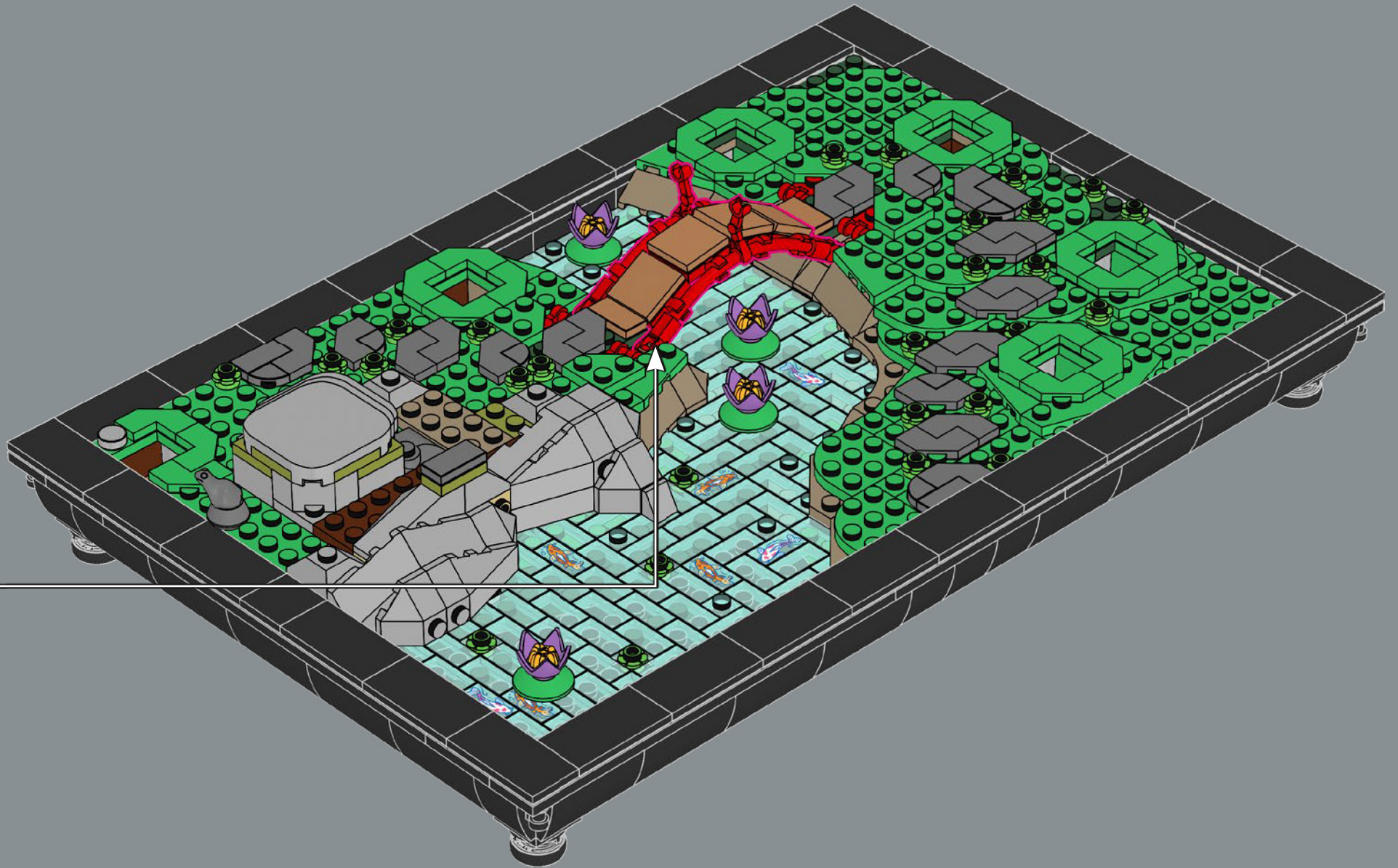

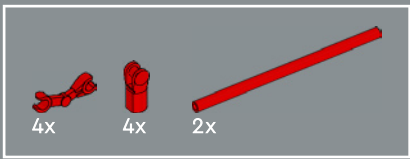

117

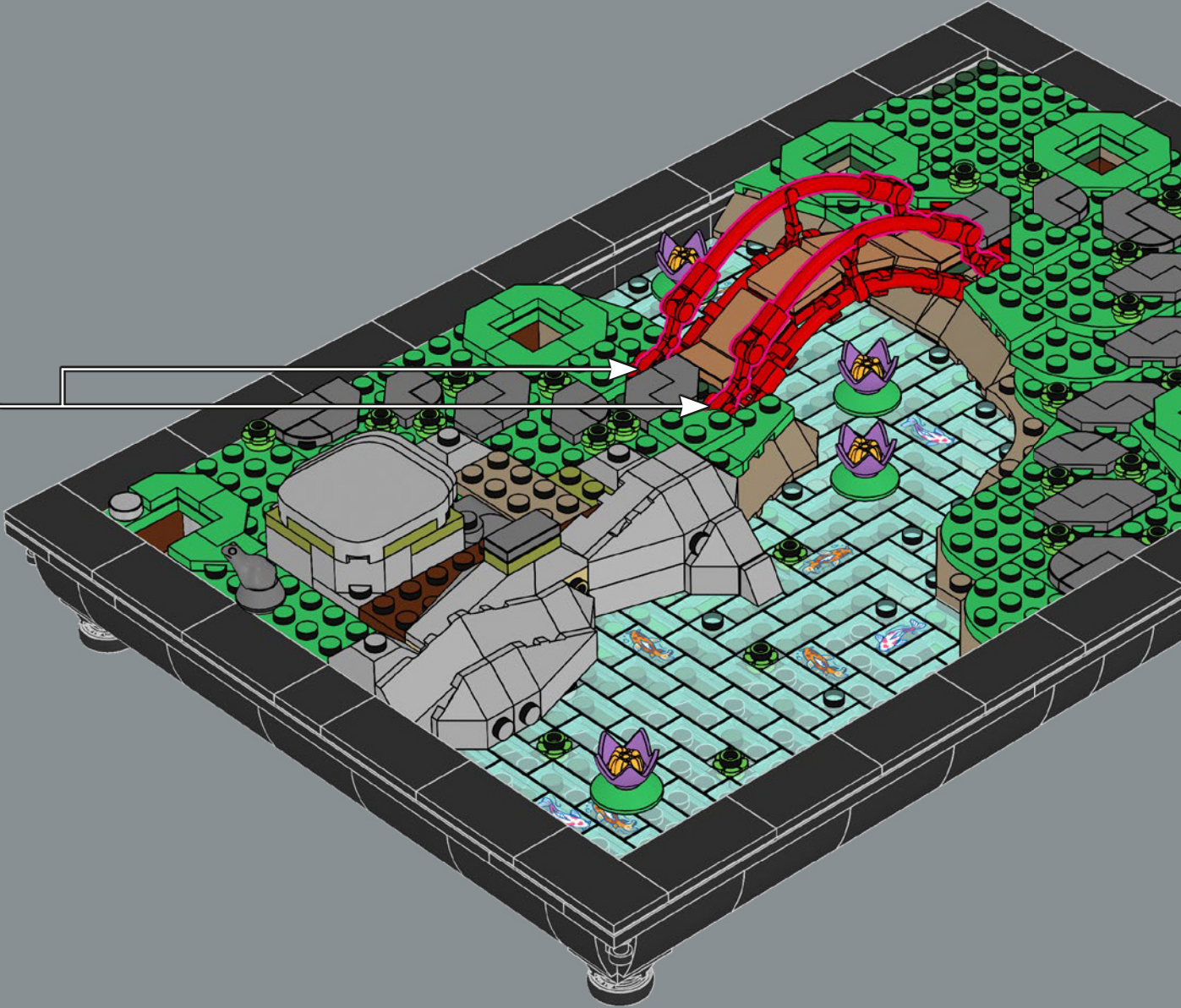
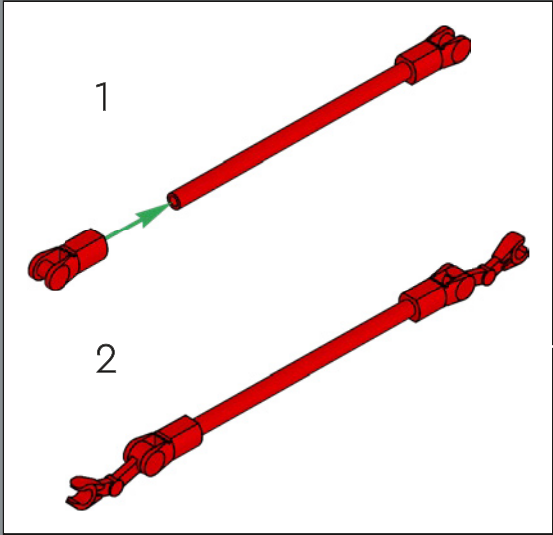



118

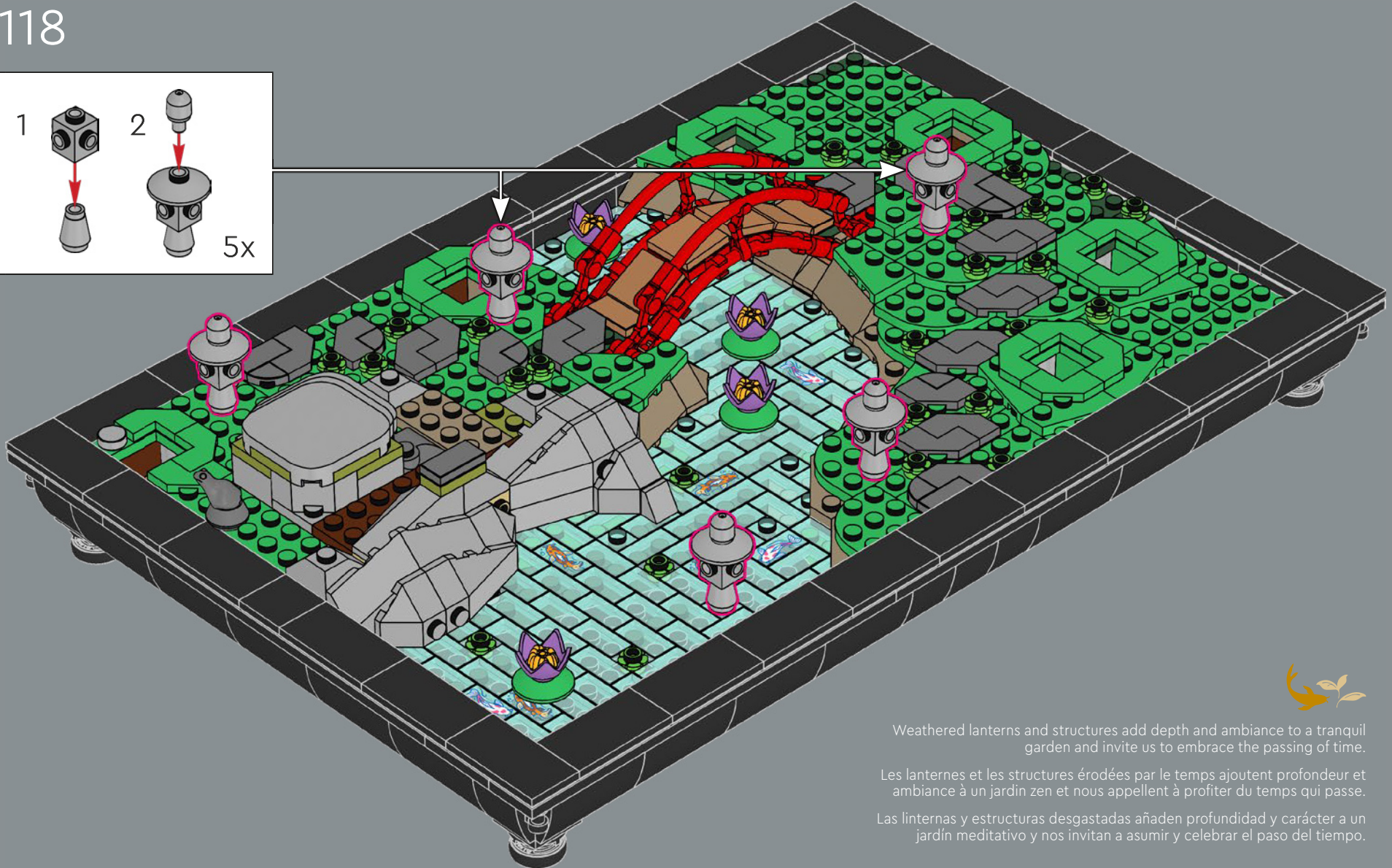
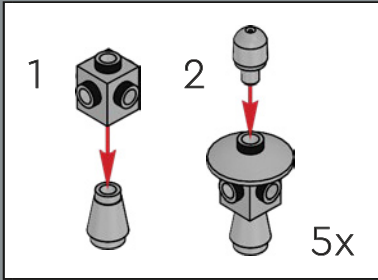

Weathered lanterns and structures add depth and ambiance to a tranquil garden and invite us to embrace the passing of time.

Les lanternes et les structures érodées par le temps ajoutent profondeur et ambiance à un jardin zen et nous appellent à profiter du temps qui passe.

Las linternas y estructuras desgastadas añaden profundidad y carácter a un jardín meditativo y nos invitan a asumir y celebrar el paso del tiempo.

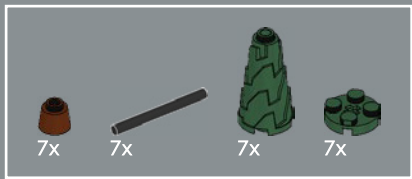

119

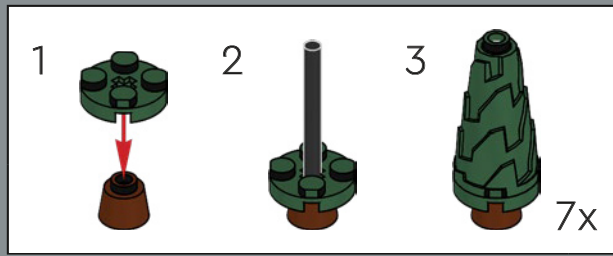

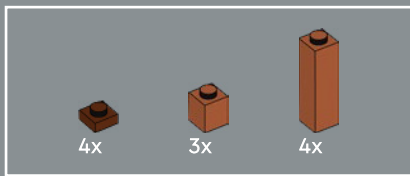

120

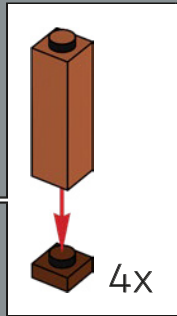
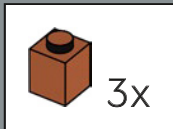

121



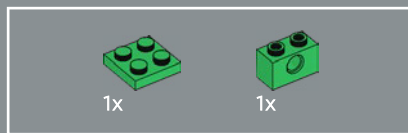
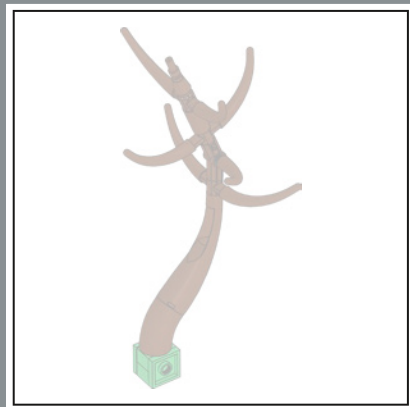

122

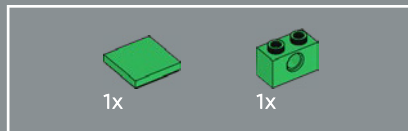
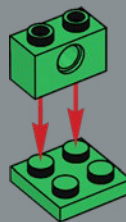

123

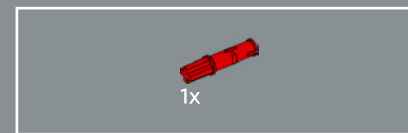
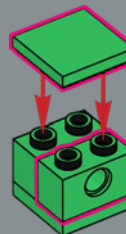

124

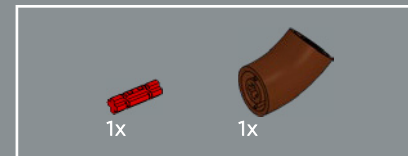
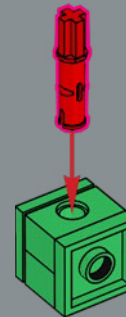

125

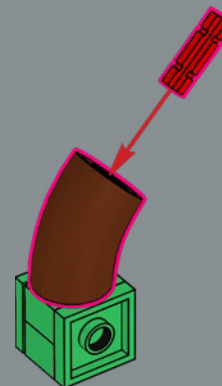

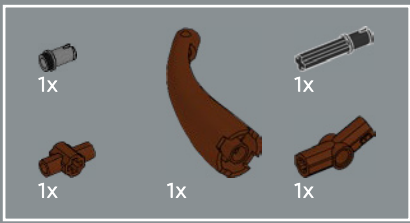

126

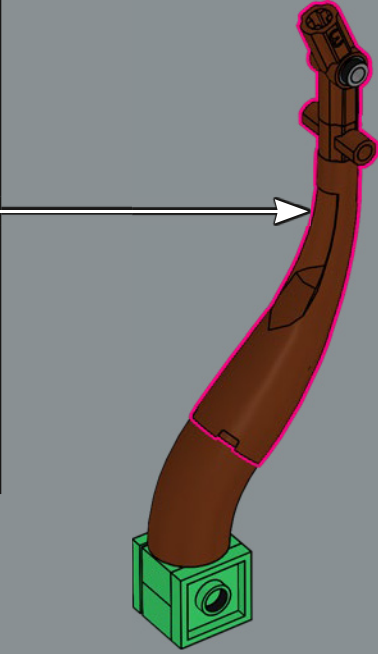
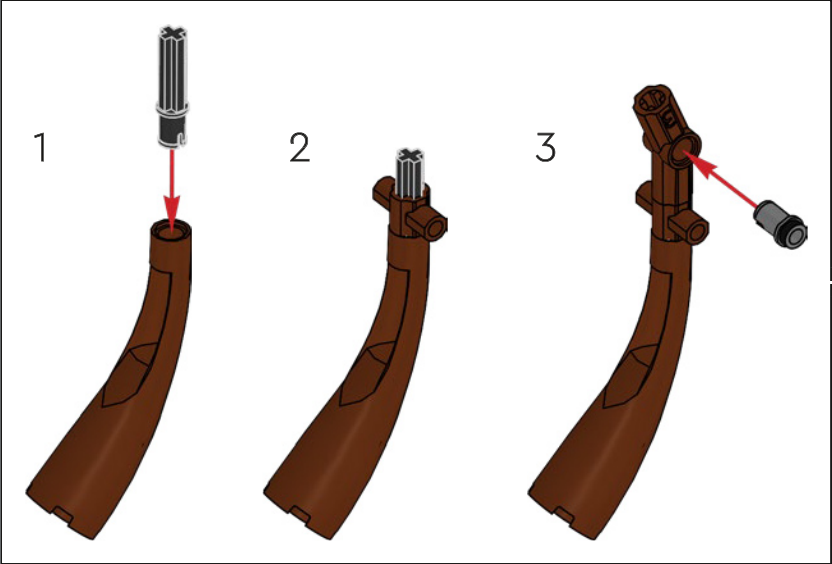

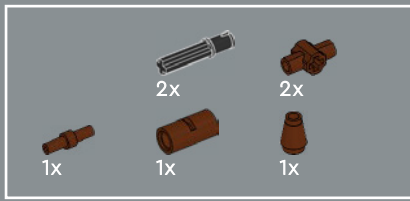

127

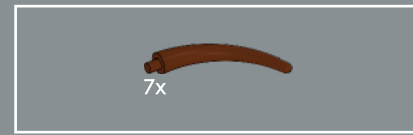
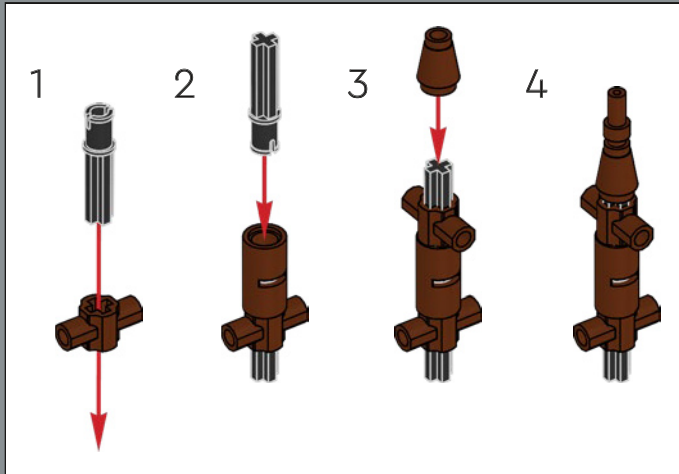

128





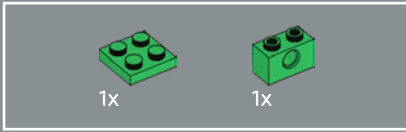
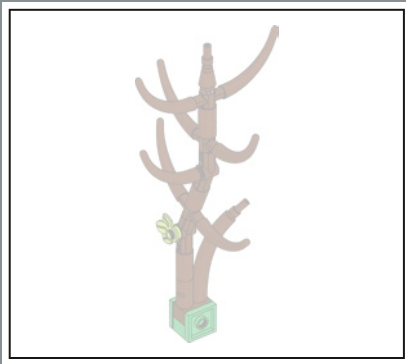

130

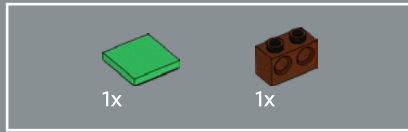
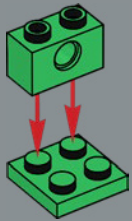

131

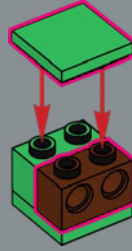

132

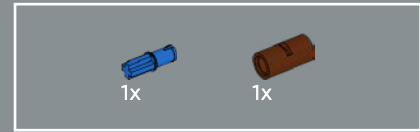

133

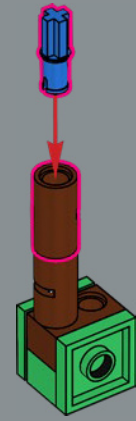

134

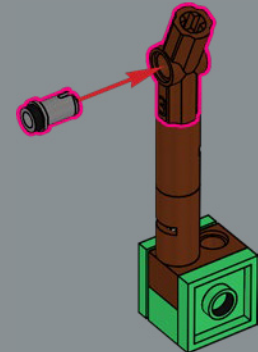

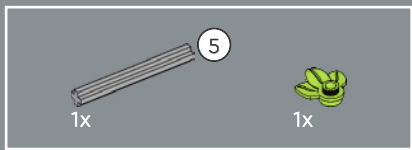

135

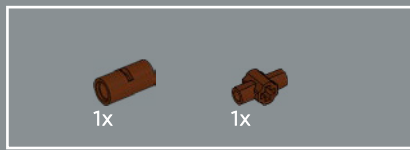
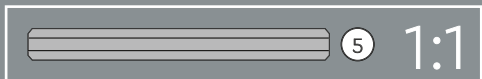

136

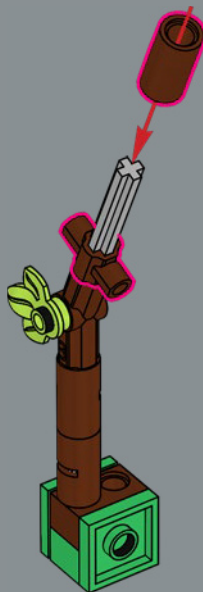

137



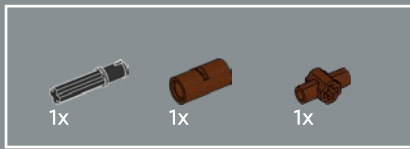

138

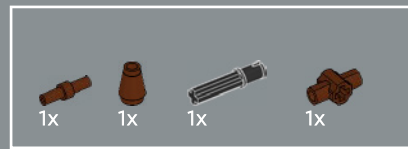
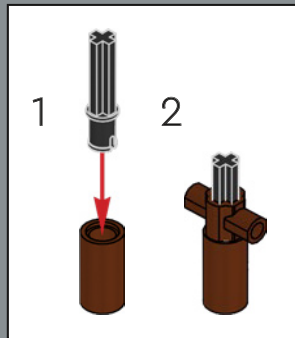

139

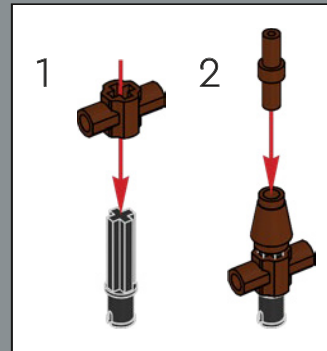

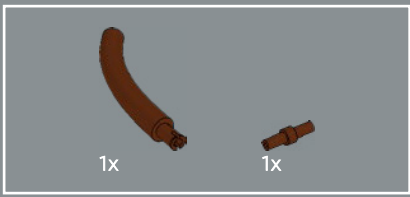

140

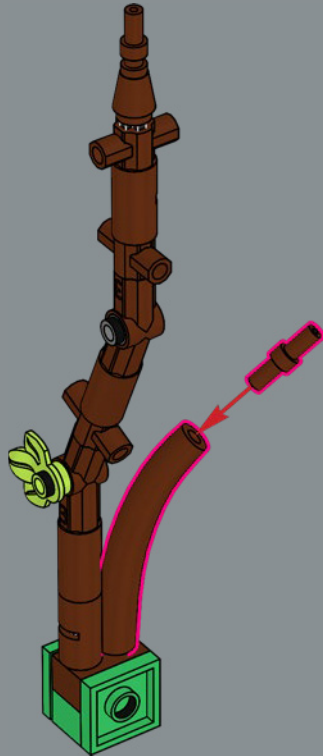

141

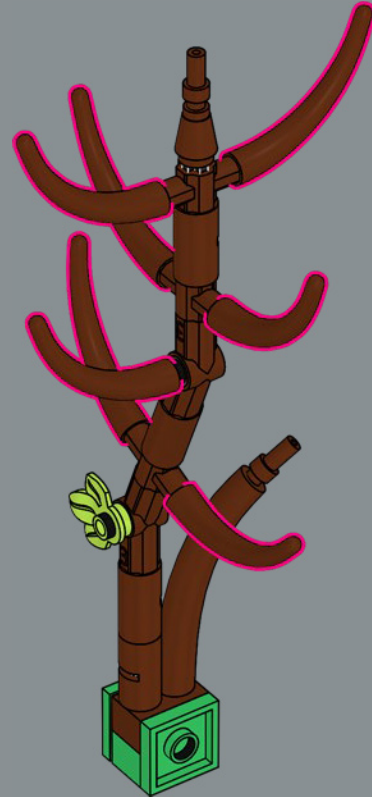

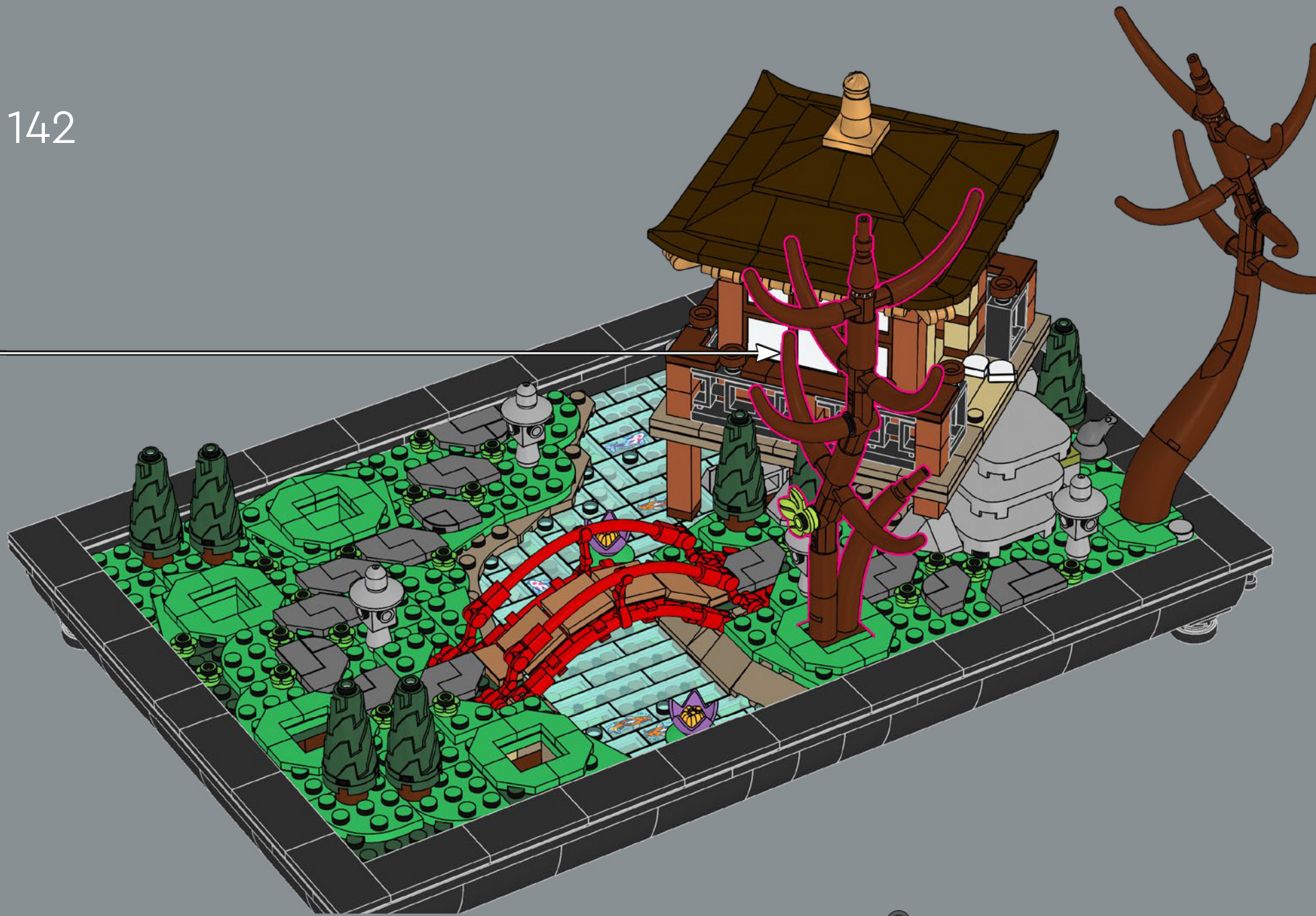

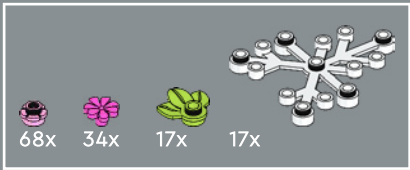

143

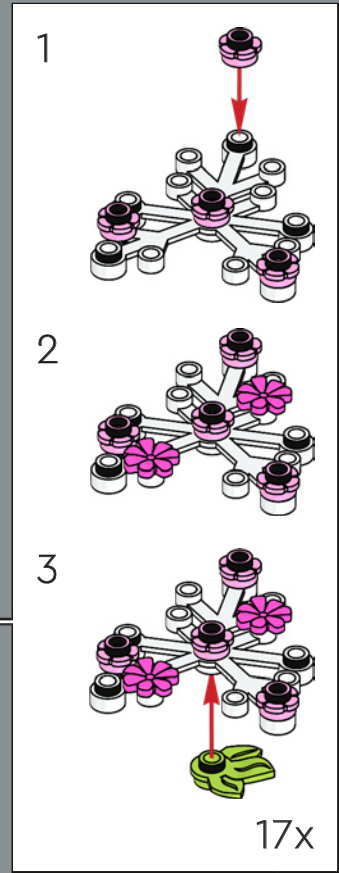

A balance of elements like water, carefully selected plants and different uses of rocks helps create a tranquil environment in your garden.

L'équilibre entre des éléments tels que l'eau, des plantes sélectionnées avec soin et des rochers utilisés de différentes manières permet de créer un environnement zen dans votre jardin.

Un equilibrio entre elementos como el agua, una cuidada selección de plantas y rocas utilizadas de formas diversas crea un entorno sereno en tu jardín.

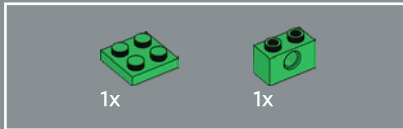
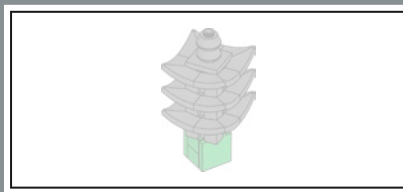

144

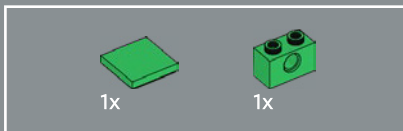
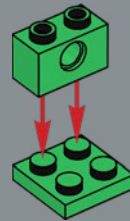

145

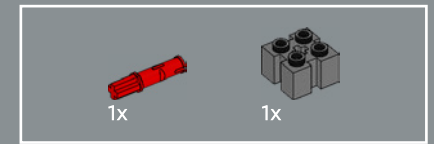
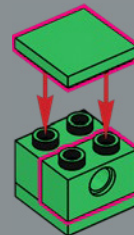

146

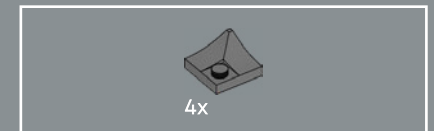
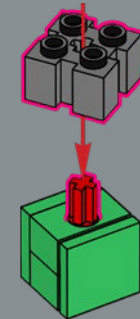

147

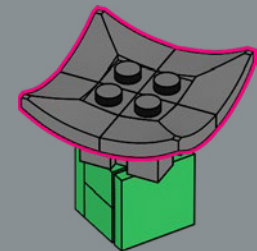

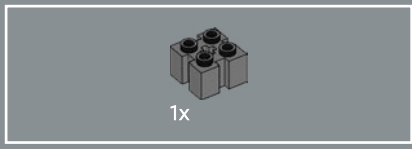

148

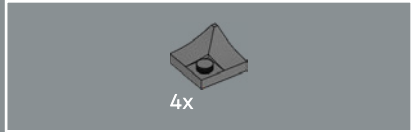
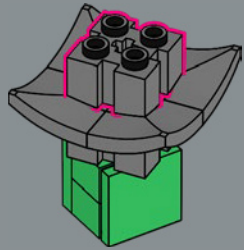

149

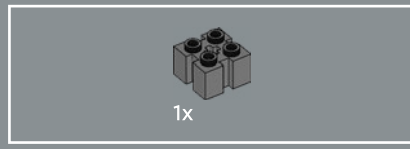
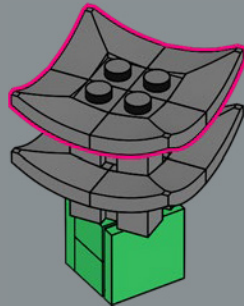

150

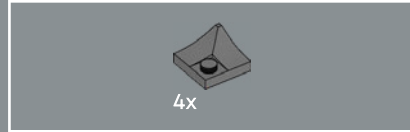
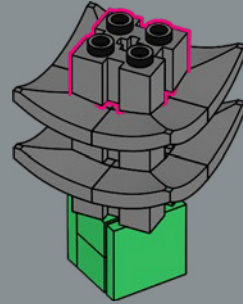

151

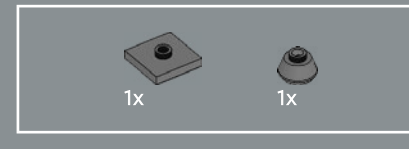
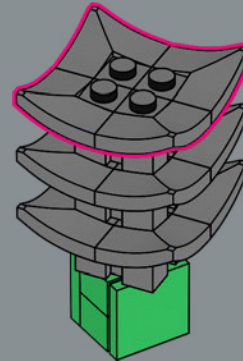

152

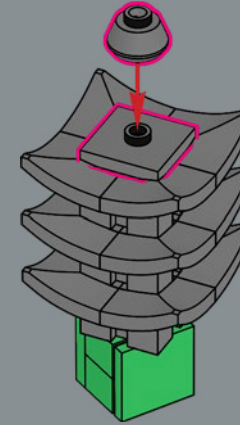

153

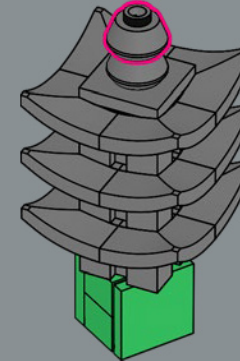

154

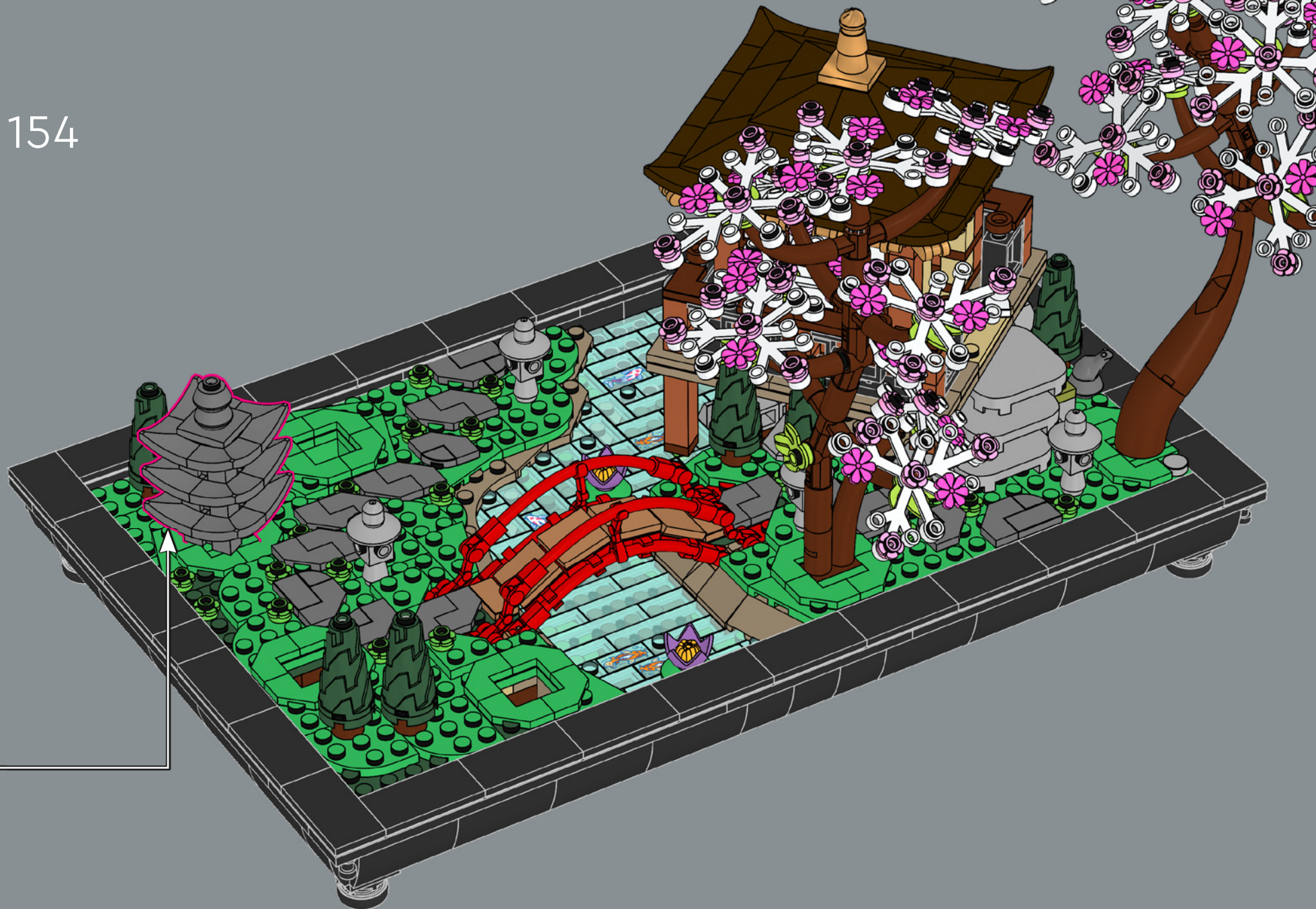

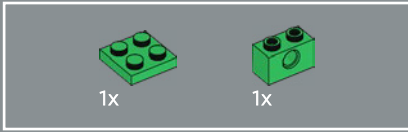
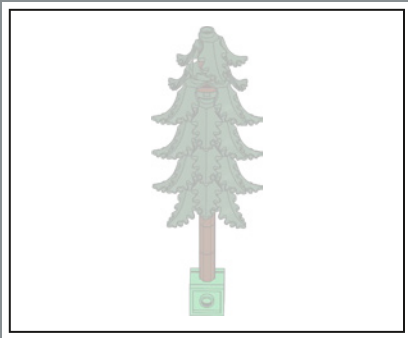

155

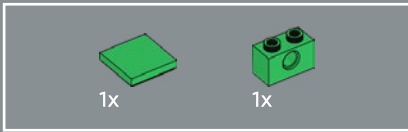
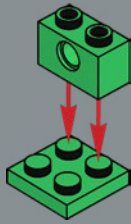

156

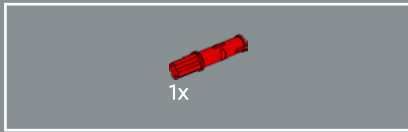
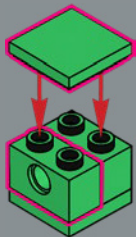

157

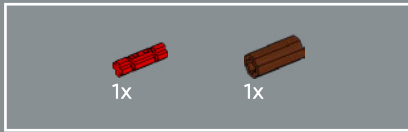
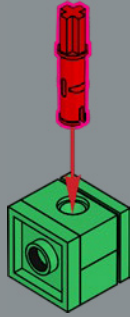

158

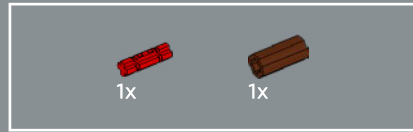
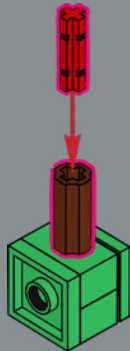

159

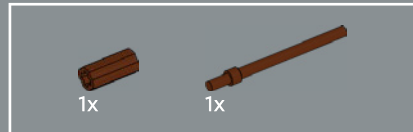
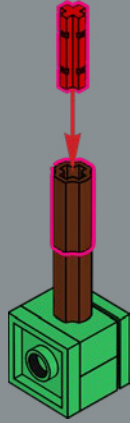

160

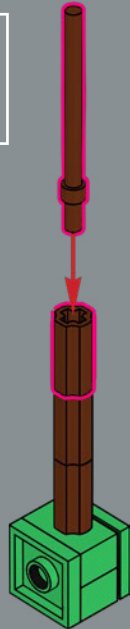



161

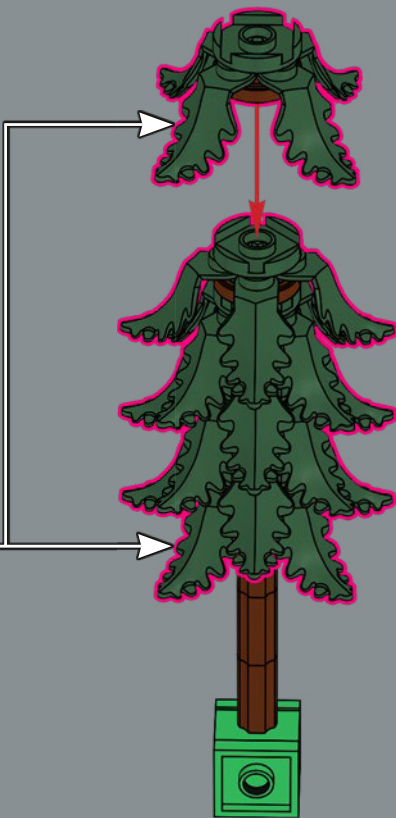

162

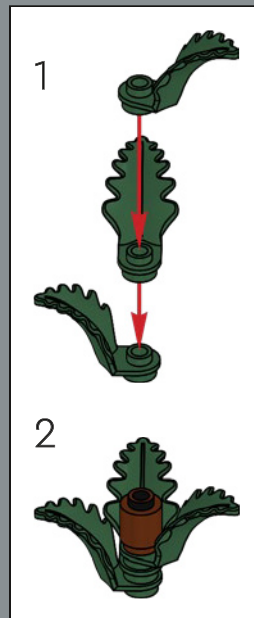



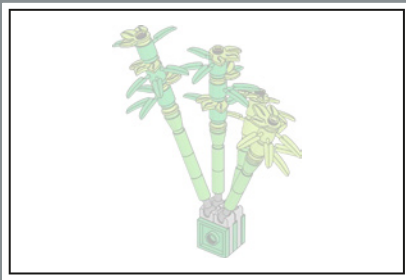

164

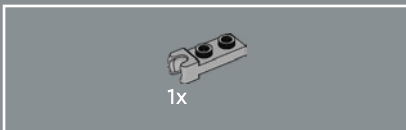
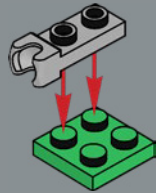

165

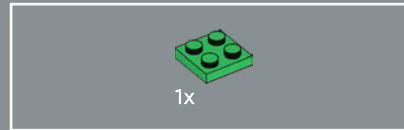
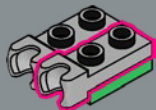

166

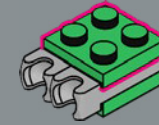

167

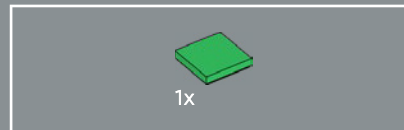
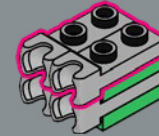

168

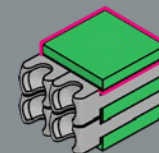



169

1



2



3

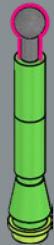

4



5

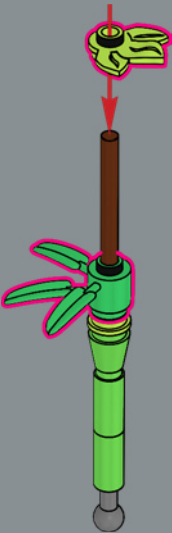

6

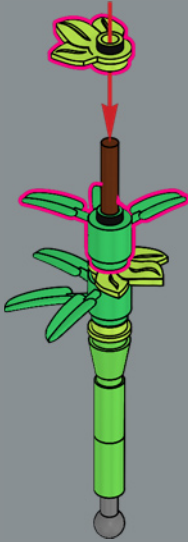

7

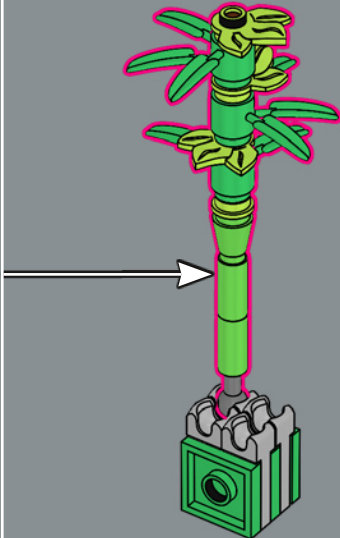
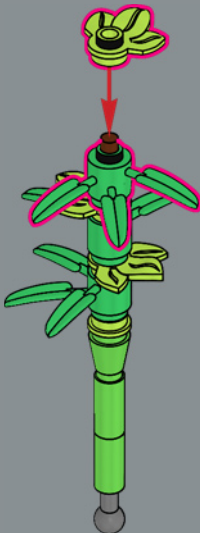

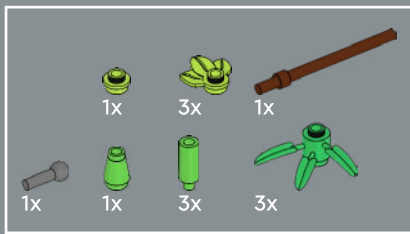

170

1

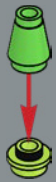

2

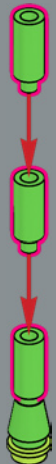

3



4



5

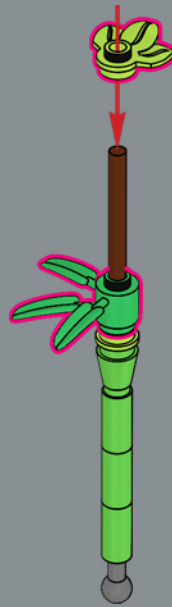

6

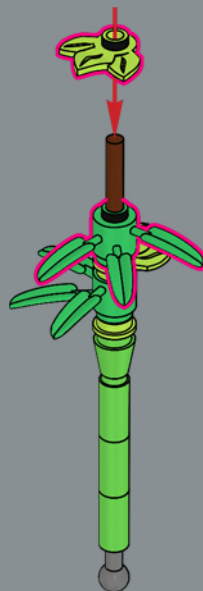

7

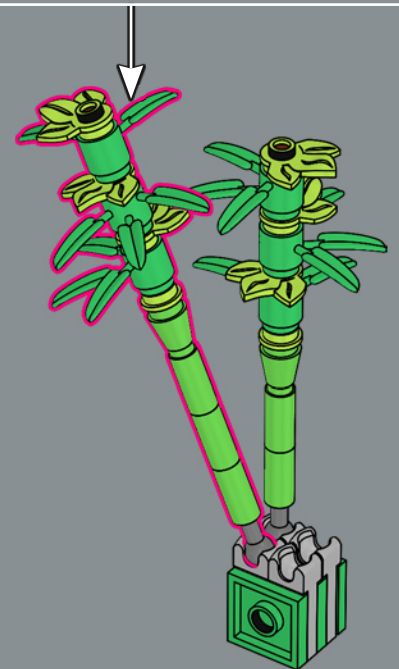

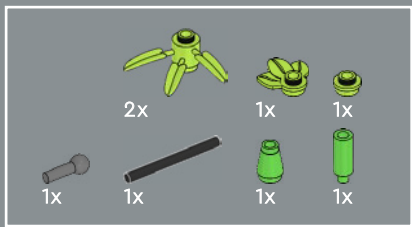

171

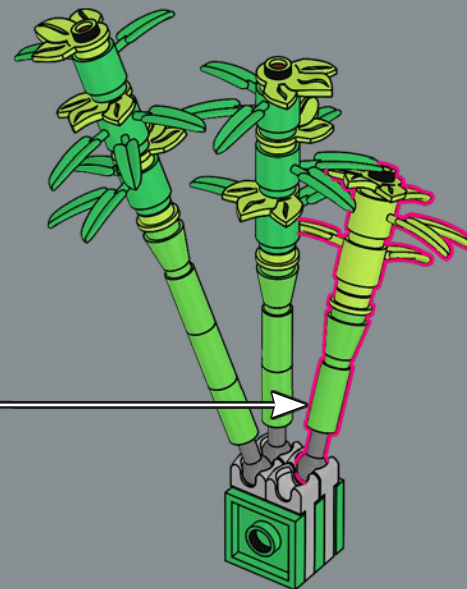
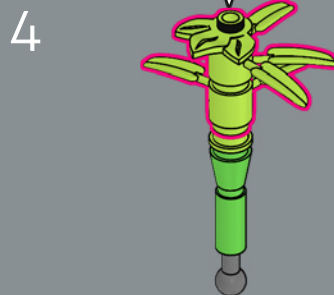
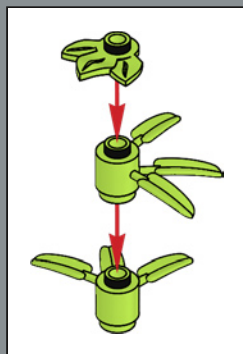
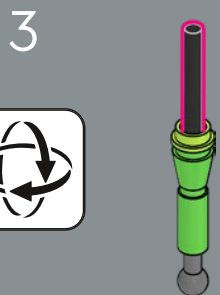
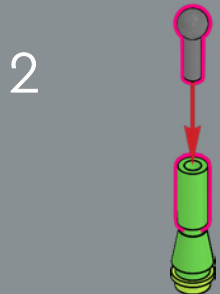
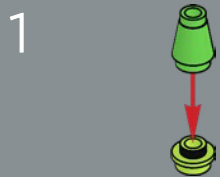

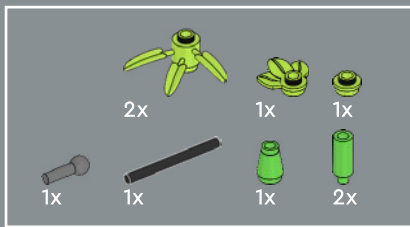

172

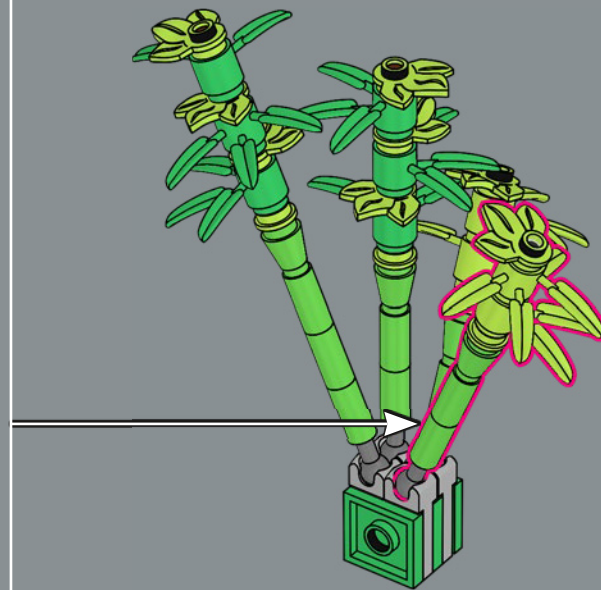
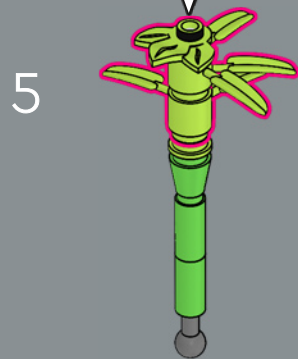
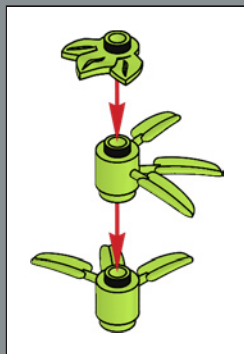
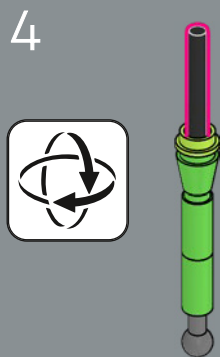
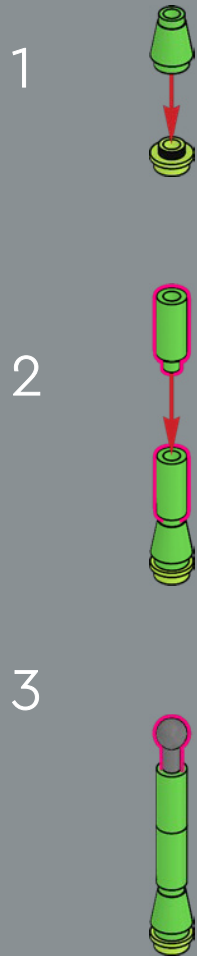



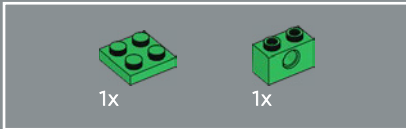
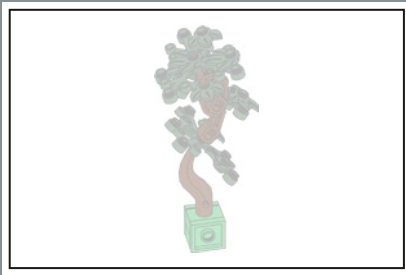

174

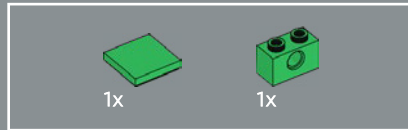
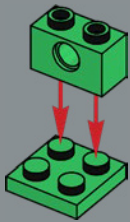

175

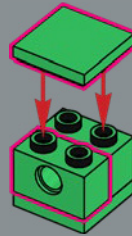

176

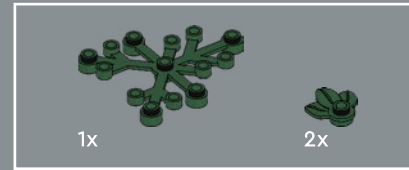
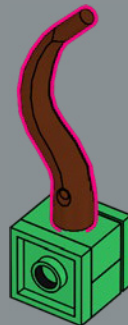

177

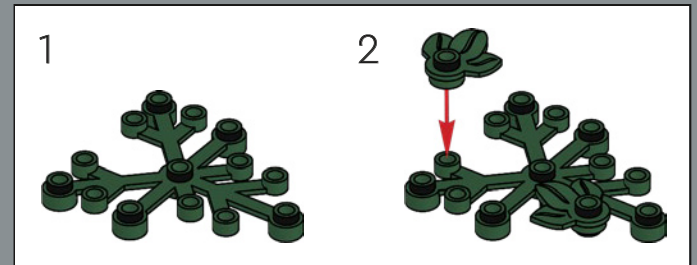

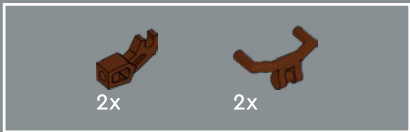

178

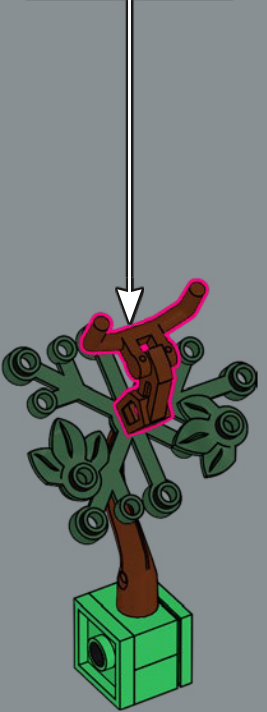
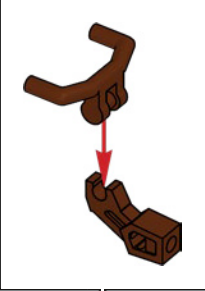

179

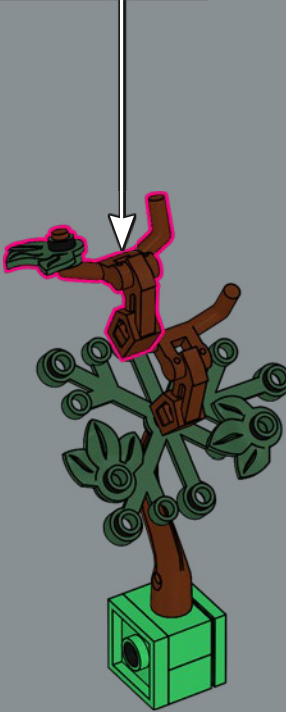
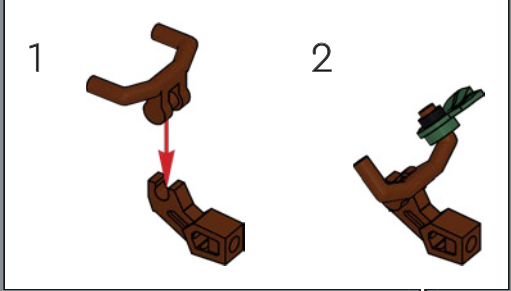

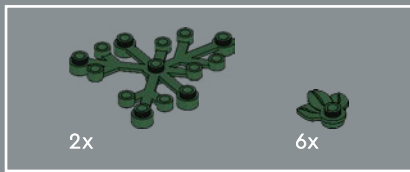

180

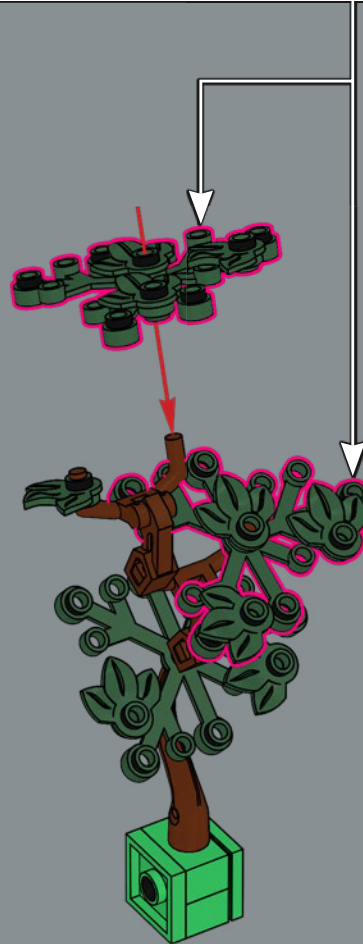
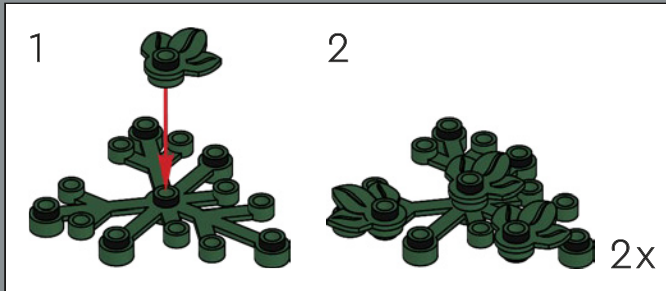



Want to add your personal touch to your model?
Be inspired by the five principles of tranquil gardens: enclosure,
balance, borrowed scenery, symbolism and asymmetry.

Vous voulez ajouter une touche personnelle à votre modèle ?
Laissez-vous inspirer par les cinq principes des jardins zen : la miniaturisation,
l'équilibre, la capture de paysages, le symbolisme et l'asymétrie.

¿Quieres añadir tu toque personal a tu modelo?
Déjate inspirar por los cinco principios de los jardines meditativos:
apartamento, equilibrio, paisaje adoptado, simbolismo y simetría.

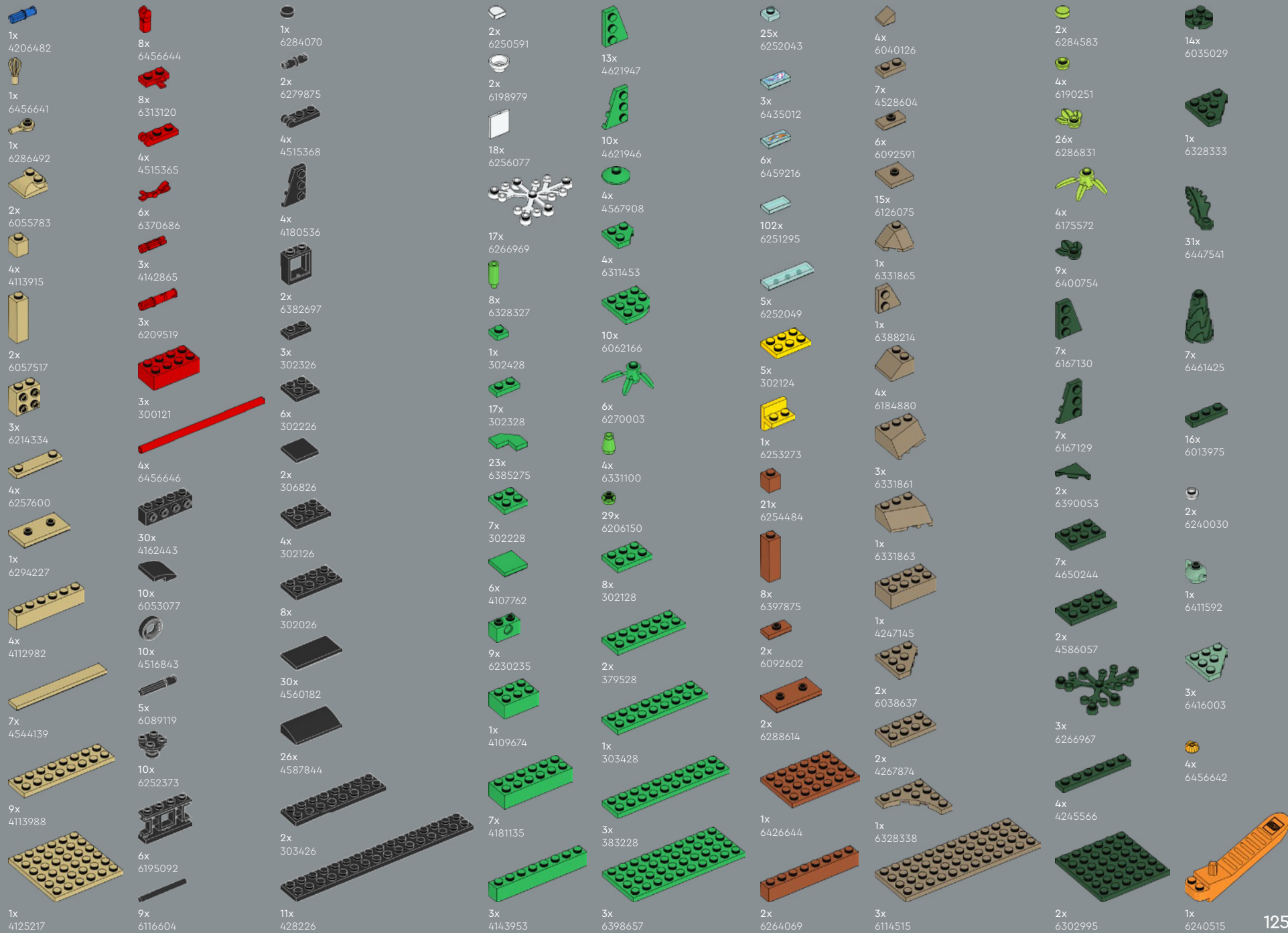

- 1x 4211183
- 3x 4211288
- 4x 4221744
- 1x 6151461
- 14x 4211190
- 5x 4216945
- 1x 4211214
- 2x 4225715
- 3x 6258989

- 1x 6348057
- 2x 4529242
- 7x 6173143
- 7x 6102360
- 3x 6451002
- 3x 4531751
- 2x 6276868
- 18x 6382102
- 1x 6326087
- 1x 6383996
- 1x 6327811

- 9x 6186673
- 12x 4211257
- 4x 6221608
- 2x 6327818
- 5x 6173132
- 3x 6261388
- 5x 4211200
- 3x 4211194
- 6x 6459423
- 3x 6170468
- 1x 6292952
- 14x 6372430
- 1x 6070442
- 8x 4211247

- 8x 4550325
- 5x 4211387
- 5x 4211511
- 3x 4651063
- 1x 4526932
- 1x 4521921
- 1x 4515374
- 8x 6034676
- 1x 6013497
- 1x 6315580
- 2x 4180418
- 1x 6315579

- 1x 4180408
- 1x 6401023
- 1x 4211397
- 1x 4211549
- 1x 4211639
- 5x 4211512
- 2x 4211400
- 2x 4598522
- 2x 4620130

5

- 5x 6284071
- 5x 6212288
- 5x 4529241
- 4x 4211353
- 4x 6043639
- 3x 6354325

- 3x 6395635
- 4x 6364352
- 7x 6199549
- 3x 6340333
- 1x 6171103
- 1x 4218696
- 1x 6126083
- 4x 4211052
- 21x 6177079
- 3x 6236949
- 12x 6447212
- 1x 4211100
- 1x 6106191
- 2x 4210678
- 1x 4211137

- 8x 6016483
- 34x 6206151
- 68x 6212501
- 1x 6186383
- 4x 6212377
- 16x 6279731
- 1x 6190252
- 2x 6173139
- 1x 6050916

- 8x 6456639
- 4x 6456643
- 4x 6456663
- 16x 6347604
- 2x 6021997
- 10x 6102990
- 4x 6347304
- 1x 6363146
- 4x 6456640



 [LEGO.com/service](https://www.LEGO.com/service)



YOU COULD WIN



YOU COULD WIN

Your feedback will help shape the future development of this product series.

Visit:

DU KÖNNTEST GEWINNEN

Dein Feedback trägt zur Weiterentwicklung dieser Produktreihe bei.

Geh auf:

VOUS POURRIEZ GAGNER

Vos commentaires nous aideront à concevoir les futurs produits de cette gamme.

Visitez :

POTRESTI VINCERE TU

La tua opinione ci aiuterà a migliorare la creazione futura di questa linea di prodotti.

Visita:

PUEDES GANAR

Tu opinión contribuirá al futuro de esta serie de productos.

Visita:

轻松获奖

您的反馈将有助于我们在今后改进本产品系列。

请访问:

[LEGO.com/productfeedback](https://www.lego.com/productfeedback)

You also have the chance to win a LEGO® set.

Terms and conditions apply.*

Außerdem hast du die Chance, ein LEGO® Set zu gewinnen.

Es gelten die Teilnahmebedingungen.*

Vous pourriez également gagner un ensemble LEGO®.

Des conditions s'appliquent.*

Hai anche la possibilità di vincere un set LEGO®.

Termini e condizioni sono applicabili.*

También tienes la oportunidad de ganar un set LEGO®.

Aplican términos y condiciones.*

您还有机会赢取乐高®套装。

条款和条件适用。*

*[LEGO.com/productfeedback-terms](https://www.lego.com/productfeedback-terms)



LEGO and the LEGO logo are trademarks of the/sont des marques de commerce du/son marcas registradas de LEGO Group.
©2023 The LEGO Group.

6474319