

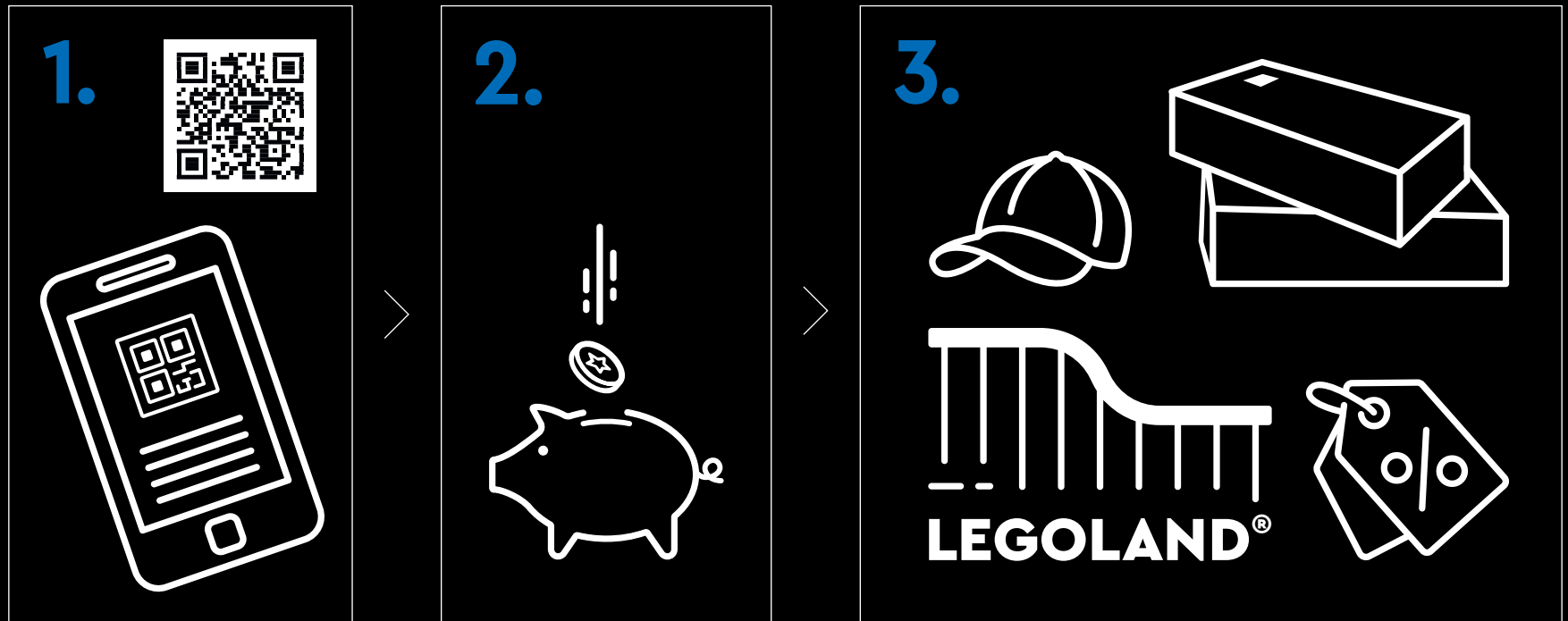



LEGO.com/sustainable-packaging

LEGO® VIP



1. Sign up **2.** Earn points for purchases **3.** Redeem points for rewards, experiences, discounts & more | **1.** Melde dich an **2.** Sammle Punkte bei jedem Kauf **3.** Löse die Punkte für Belohnungen, Erlebnisse, Rabatte und Ähnliches ein | **1.** Inscrivez-vous **2.** Gagnez des points lors de vos achats **3.** Échangez vos points contre des récompenses, des expériences, des remises et bien plus encore | **1.** Iscriviti **2.** Guadagna punti con i tuoi acquisti **3.** Riscatta punti per premi, esperienze, sconti e altro ancora | **1.** Regístrate **2.** Gana puntos por tus compras **3.** Canjea puntos por recompensas, experiencias, descuentos y mucho más | **1.** Registe-se **2.** Ganhe pontos em compras **3.** Troque os pontos para prémios, experiências, descontos e muito mais | **1.** 注册 **2.** 购物赚积分 **3.** 用积分兑换奖励、体验、折扣等 | **1.** Zarejestruj się **2.** Zdobywaj punkty za zakupy **3.** Wymieniaj punkty na rabaty, przygody i inne nagrody | **1.** Zaregistrujte se **2.** Sbírejte body za nákupy **3.** Vyměňujte body za odměny, zážitky, slevy a spoustu dalšího | **1.** Zaregistrujte se **2.** Získavajte body za nákupy **3.** Uplatnite si body a získajte odmeny, rôzne zážitky, zľavy a ešte viac | **1.** Regisztrálj **2.** Szerezz pontokat minden vásárlással **3.** Váltsd be pontjaidat jutalmakra, élményekre, kedvezményekre és egyebekre | **1.** Înscrite-te **2.** Câștigă puncte pentru achiziții **3.** Valorifică puncte pentru recompense, experiențe, reduceri și multe altele | **1.** Регистрируйте се **2.** Получайте точки за покупки **3.** Используйте точки за награды, услуги, отстъпки и т.н. | **1.** Reģistrējies **2.** Pelni punktus par pirkumiem **3.** Izmanto punktus, lai saņemtu balvas, izklaides iespējas, atlaides un daudz ko citu | **1.** Registreeru **2.** Teeni ostude eest punkte **3.** Lunasta punktide eest preemiad, elamused, allahindlused ja muu | **1.** Užsiregistruokite **2.** Pelnykite taškų už pirkinius **3.** Panaudokite taškus atlygiui, funkcijoms, nuolaidoms ir ne tik





"En nuestra época,
pasar tiempo en
la naturaleza se
está convirtiendo
en algo

bastante inusual. Formamos parte de
una sociedad urbana y dependiente
de la tecnología. Pero necesitamos la
naturaleza para relacionarnos con los
demás y entendernos a nosotros mismos.
Inspirado en los jardines japoneses, el
Jardín Meditativo LEGO® lleva a tu mente
la naturaleza de manera simbólica, un
ejercicio que resulta fundamental para la
vida en los tiempos modernos".

HOICHI KURISU

Diseñador y constructor de jardines japoneses



Creado para vivir la atención plena

● Sigue el sendero de piedras que conduce a tu pabellón privado, siéntete como en casa, relájate y sé uno con la naturaleza por un instante. O, si así lo deseas, prolonga el momento tanto como quieras.

Inspirado en los elementos esenciales de las milenarias tradiciones de la jardinería japonesa, este set se ha creado en colaboración con Hoichi Kurisu, que cuenta con años de experiencia diseñando jardines para la práctica de la atención plena. Un refugio de serenidad donde puedes reflexionar y recargar las pilas sin distracciones. Cada componente del jardín te permite sumergirte en las coloridas maravillas y la alegre belleza de la madre tierra. Mientras pasas tiempo en tu jardín, deja que se sucedan las estaciones. Siente tu creatividad florecer con cada visita, reorganiza el paisaje, planta nueva vegetación LEGO® o añade elementos decorativos que signifiquen algo para ti. Prepara una taza de tu té matcha favorito, reproduce una relajante banda sonora inspirada en la naturaleza, ponte tus zapatillas más suaves y reserva tiempo para disfrutar del espacio de tu mente.





"Dale al set tu toque personal según tu estado de ánimo".

MICHAEL PSIAKI Y CARL MERRIAM
Modelistas de LEGO® Icons

Cuida de tu jardín

● "Construir un set LEGO® tiene mucho en común con leer un libro extraordinario: es una experiencia inmersiva que lleva tu mente lejos del aquí y el ahora. Te permite centrarte en algo divertido y te da la oportunidad de sentir satisfacción y orgullo, incluso largo tiempo después de haberlo completado. Puedes volver a este jardín tan a menudo como quieras. Cuida de cada uno de los elementos que lo componen y haz cambios en el paisaje tal como lo harías en un jardín de verdad o con un bonsái. Poda o trasplanta los cerezos en flor, los exuberantes árboles de hoja perenne y el bambú, o mueve a otro lugar los faroles de piedra según tu estilo y estado de ánimo. También puedes contemplar las vibrantes carpas koi y los nenúfares en el burbujeante estanque y dejarte llevar por tu libertad creativa".



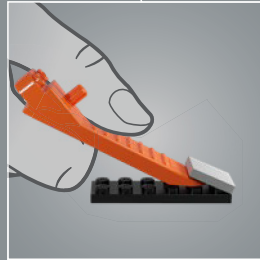
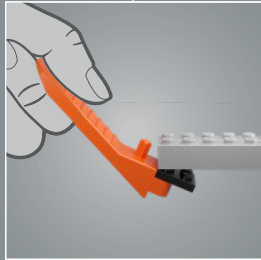
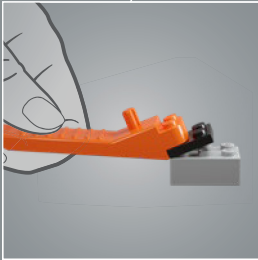
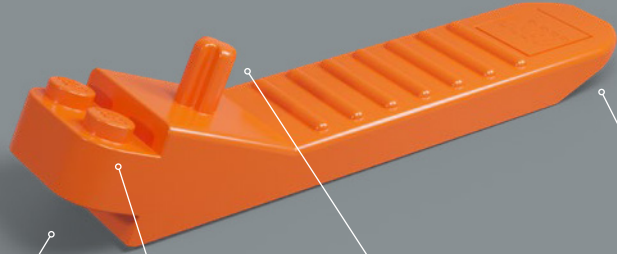

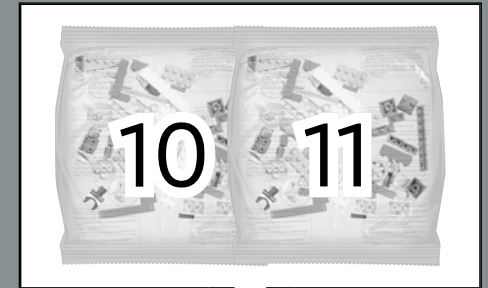
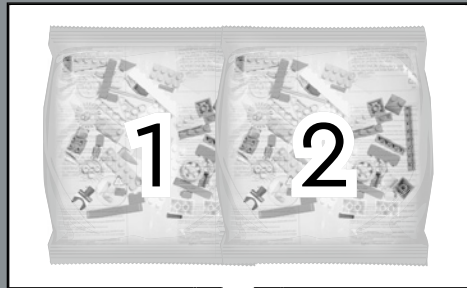

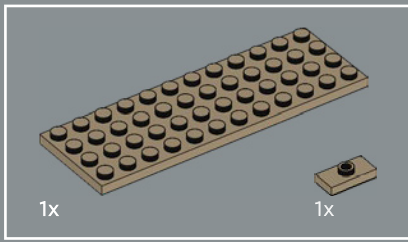
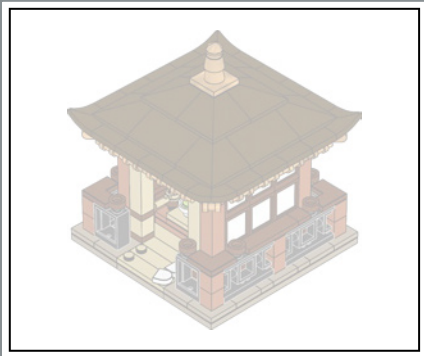

1

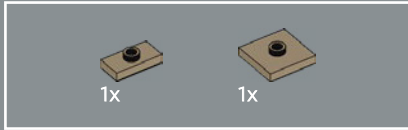
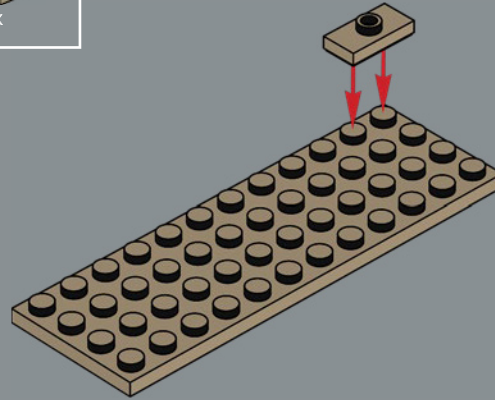

2

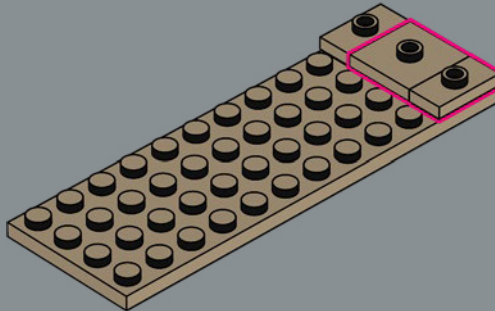

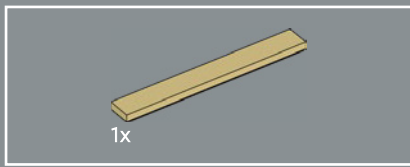

3

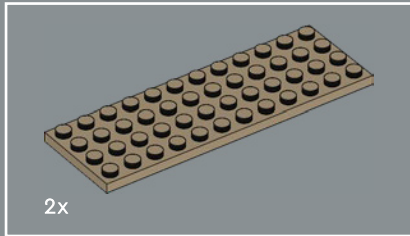
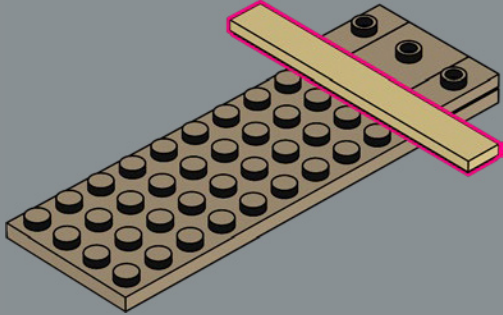

4

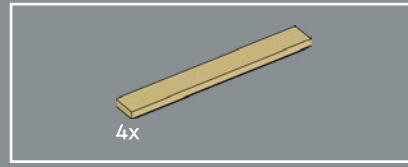
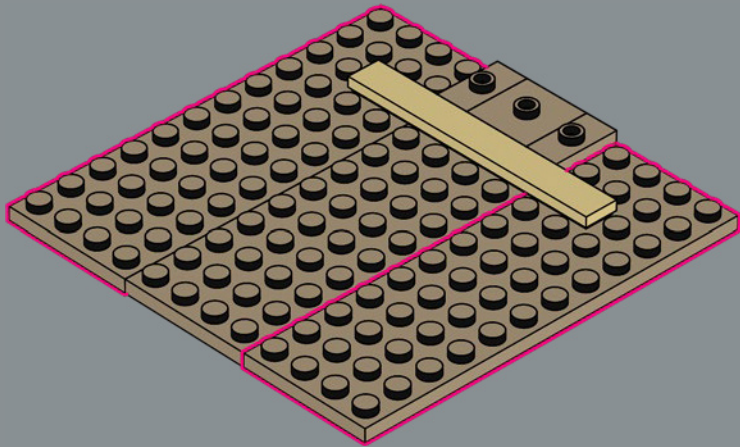

5

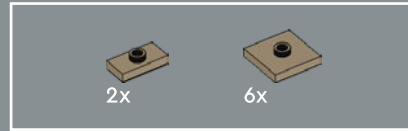
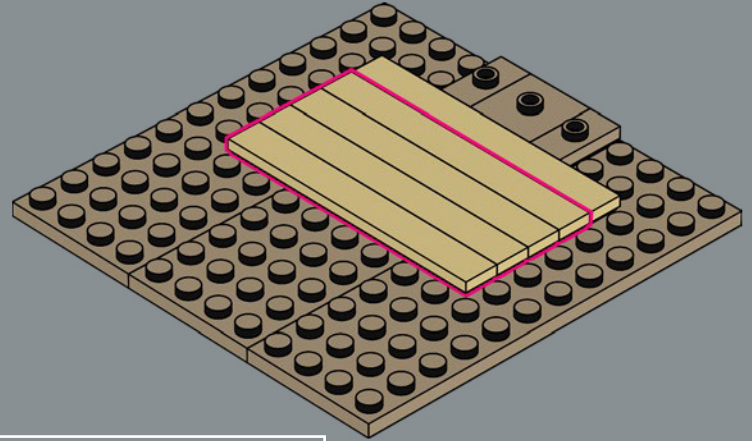

6

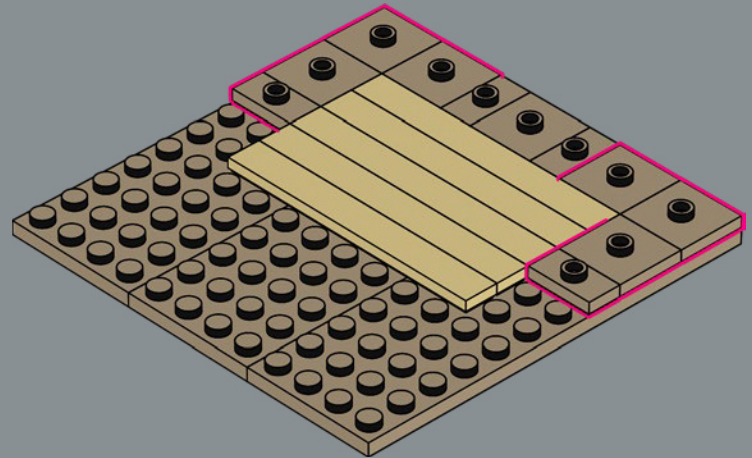

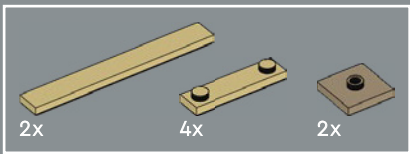

7

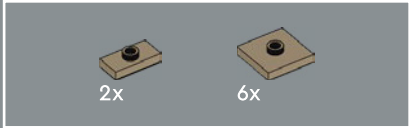
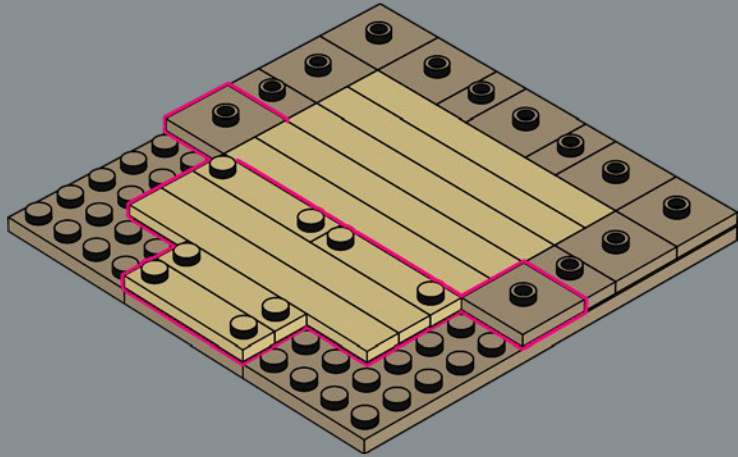

8

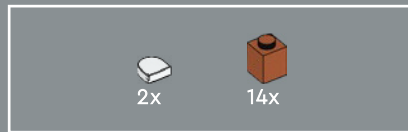
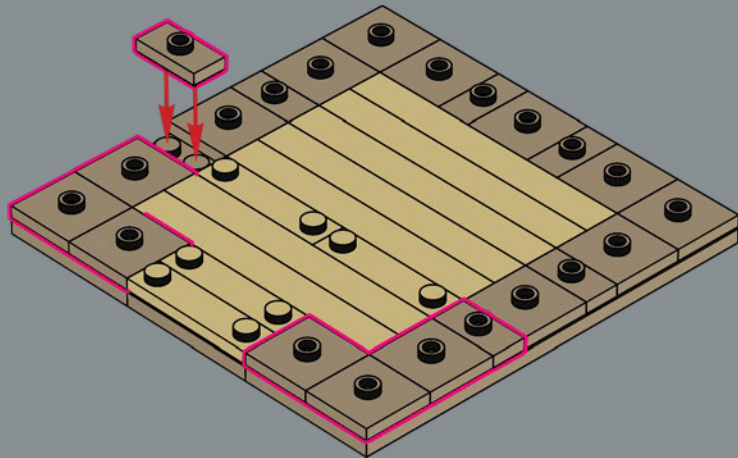

9

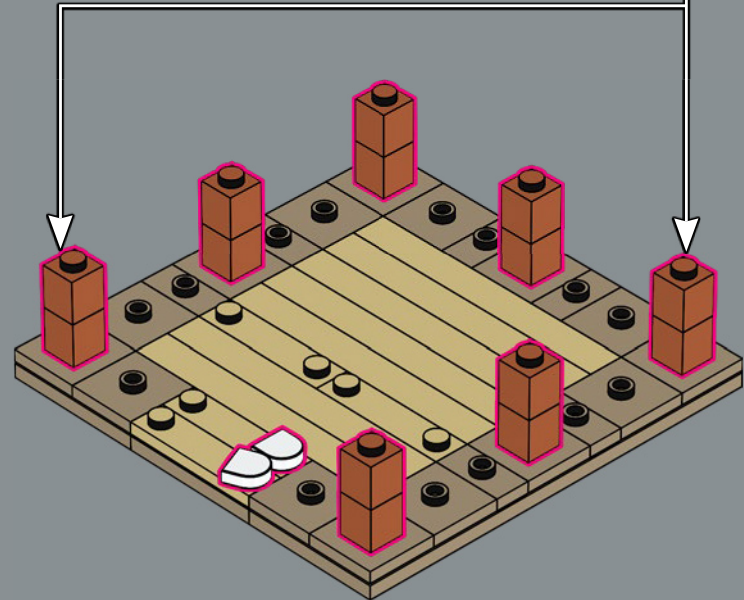
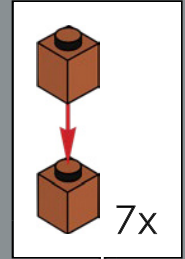

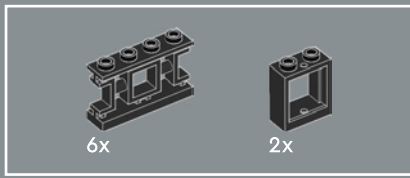

10

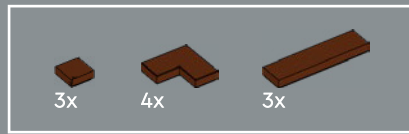
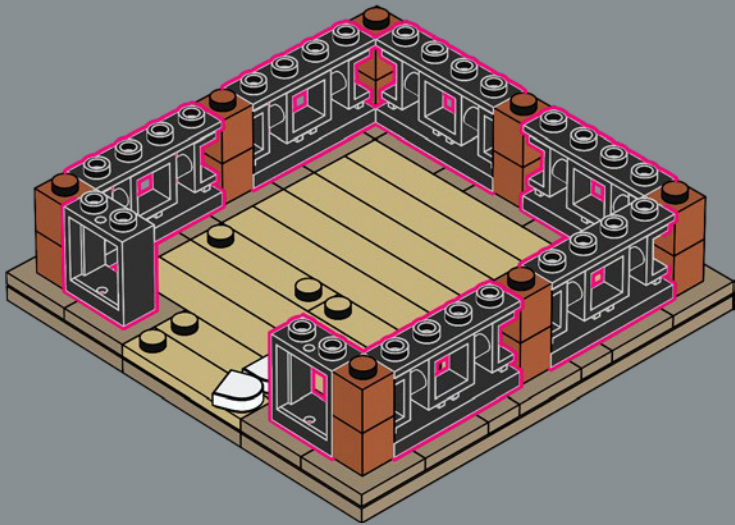

11

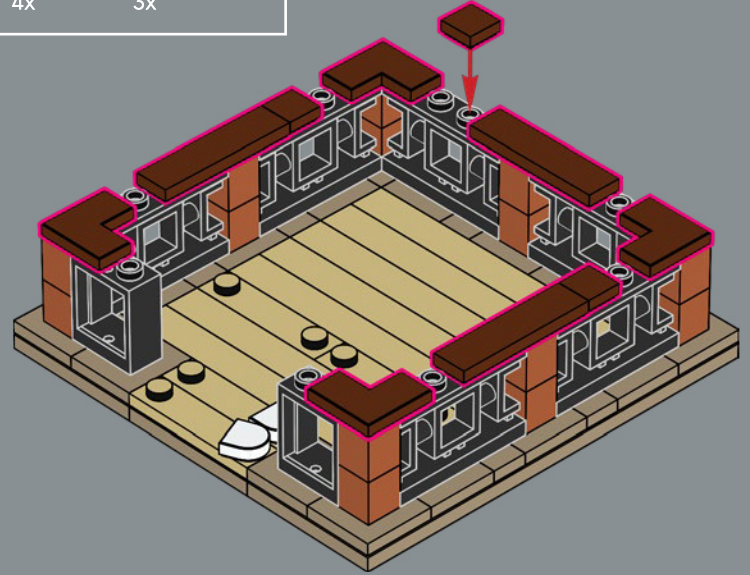

12

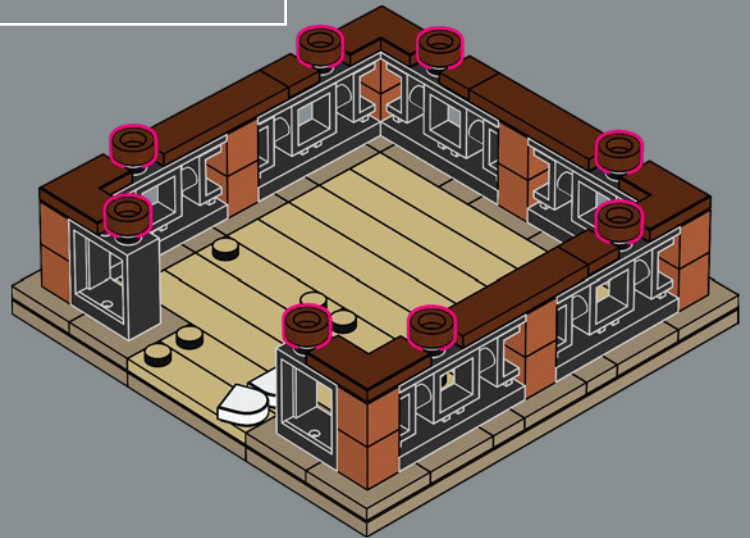

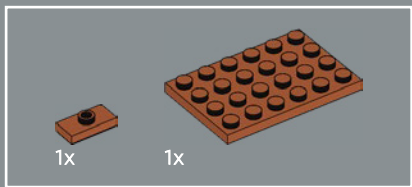

13

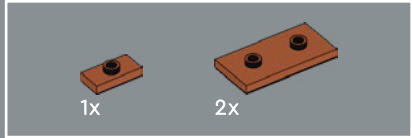
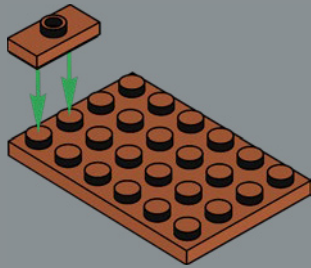

14

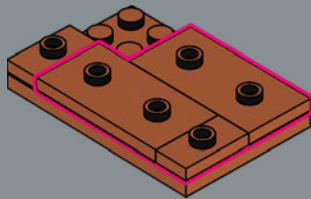

15

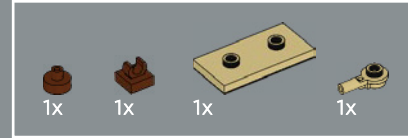
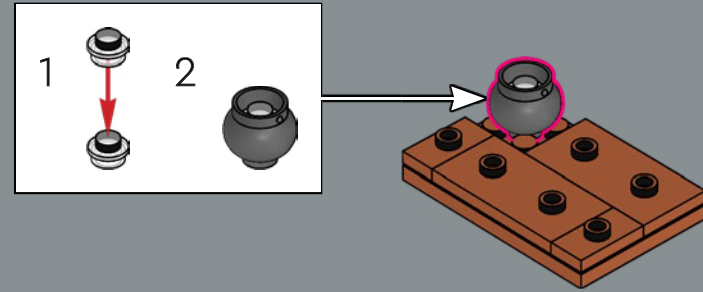

16

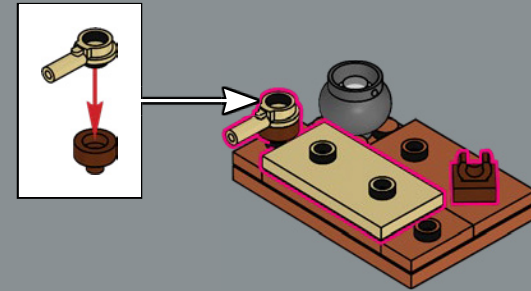

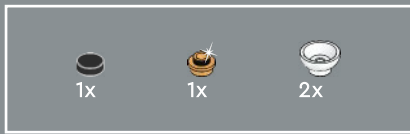

17

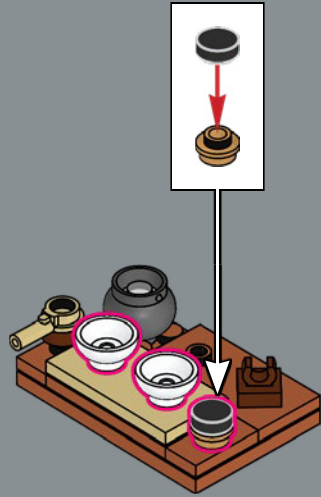

18

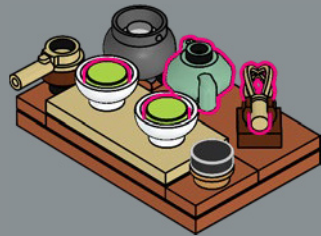

19



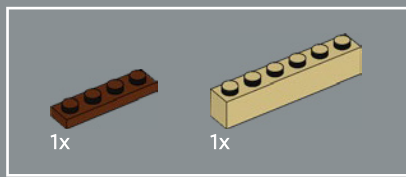

20

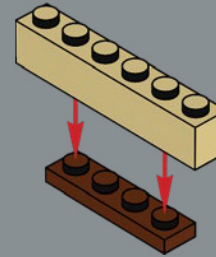

21

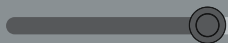
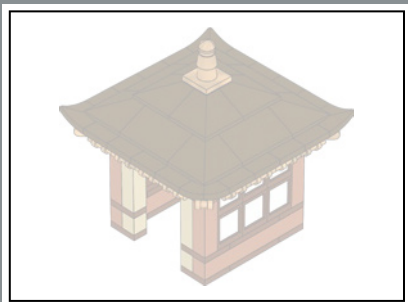
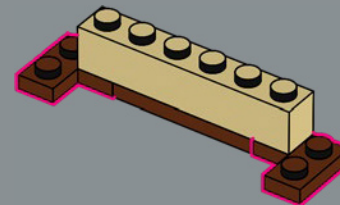

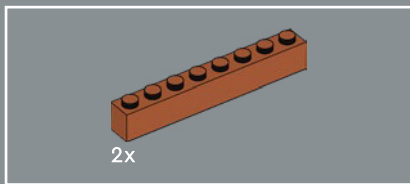

22

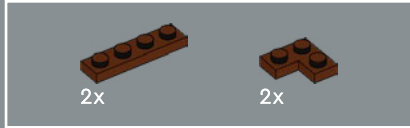
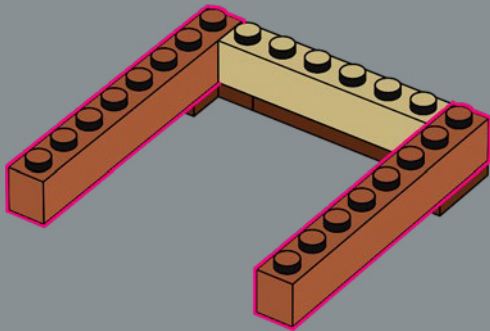

23

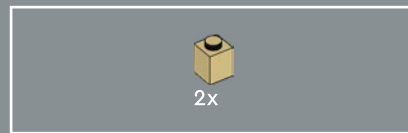
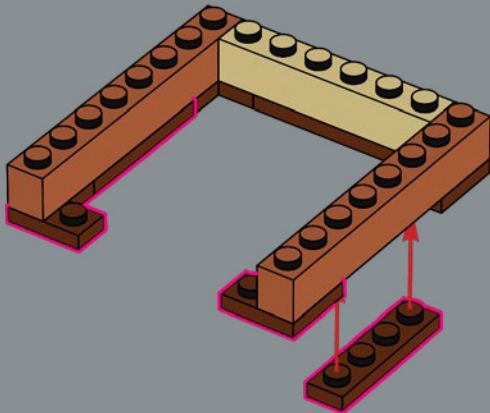

24

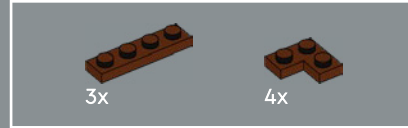
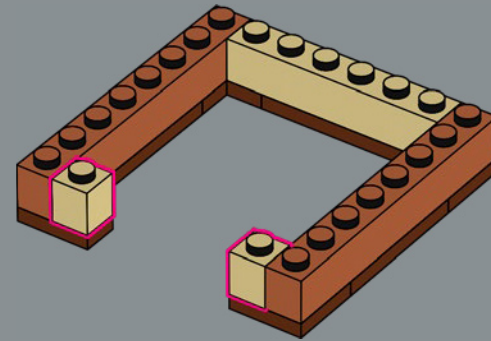

25

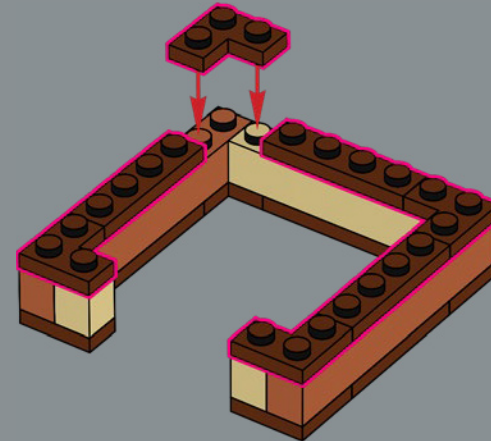

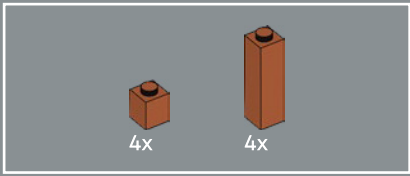

26

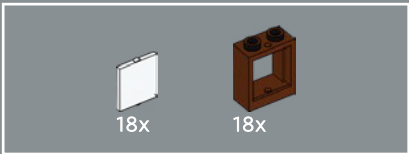
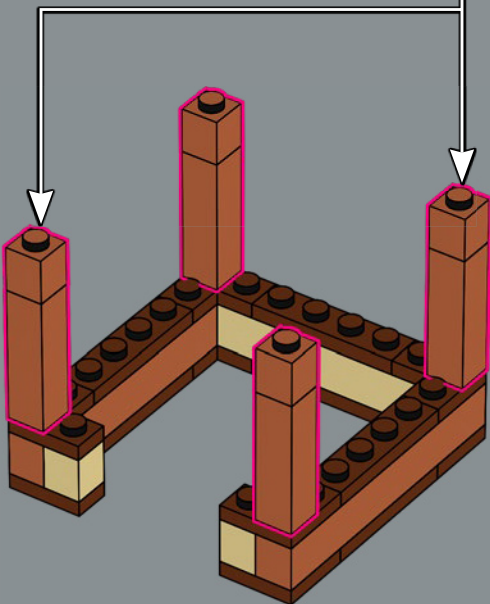
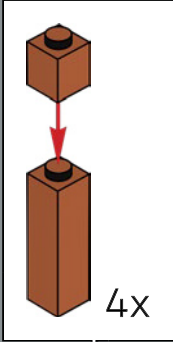

27

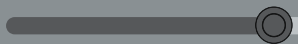
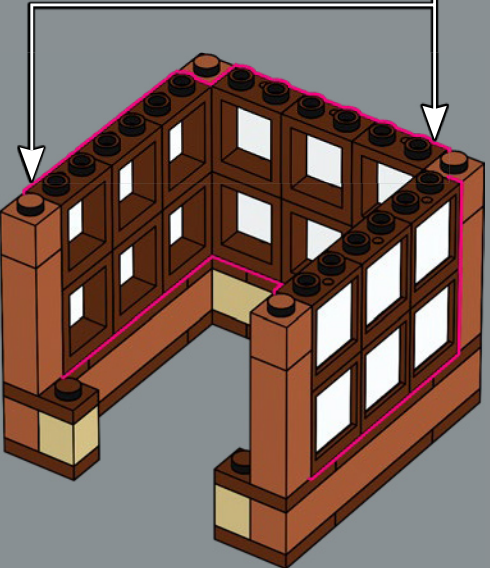
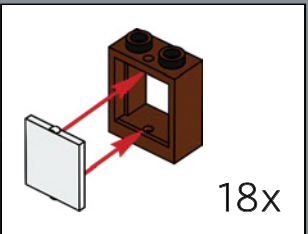

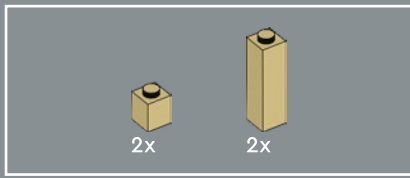

28

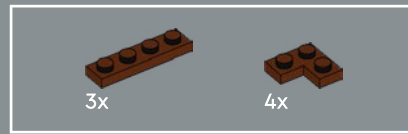
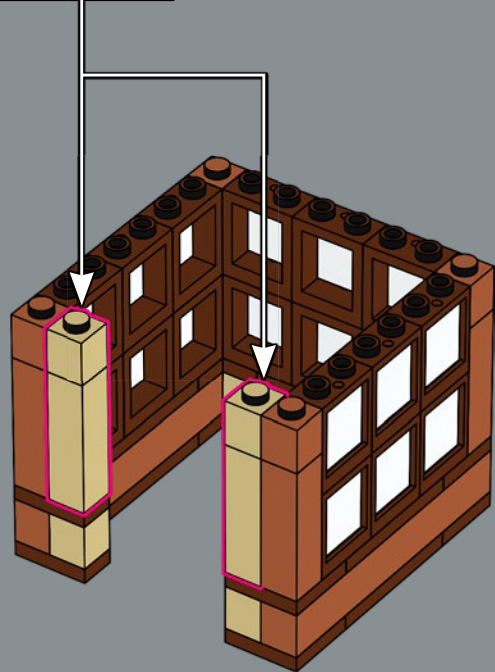
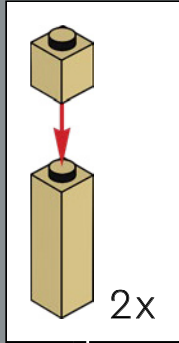

29

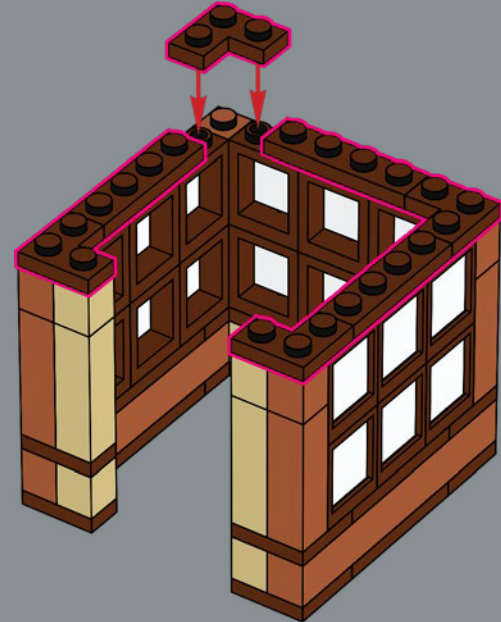

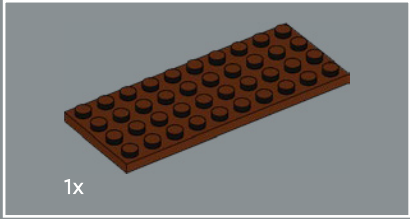
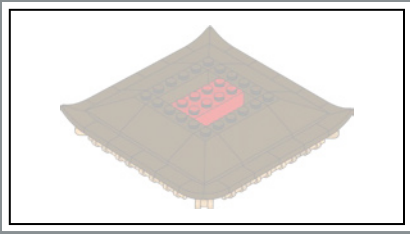

30

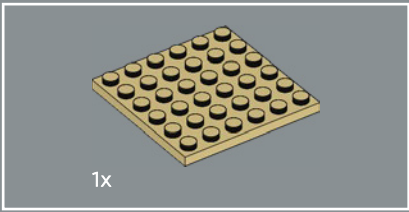
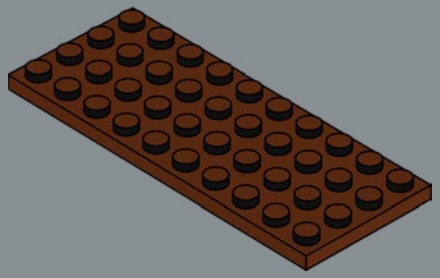

31

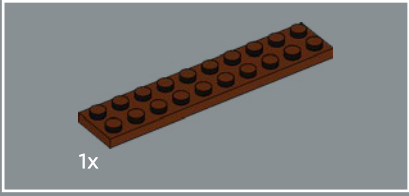
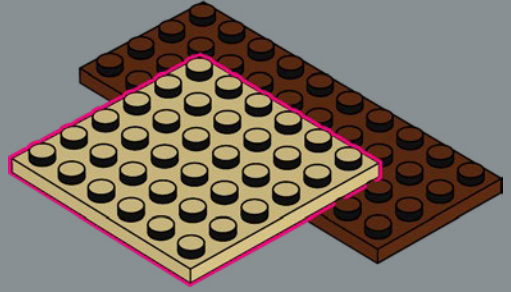

32

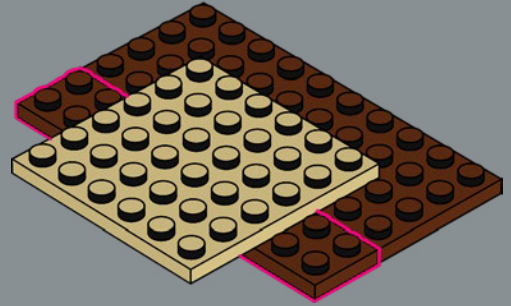

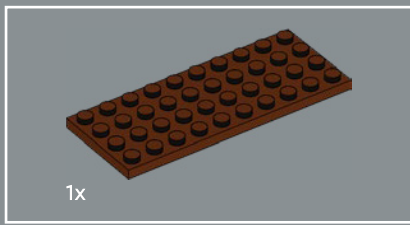

33

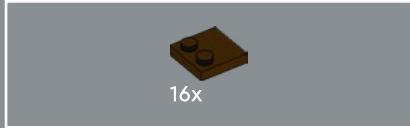
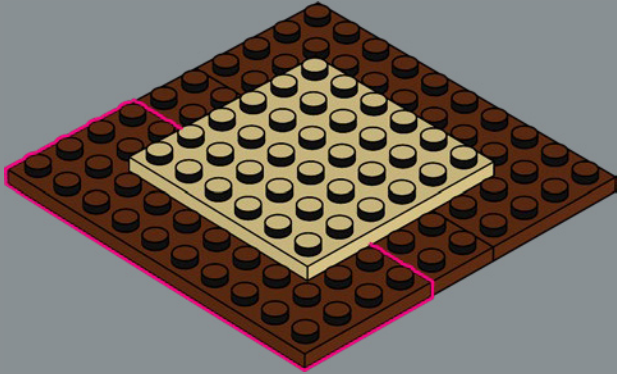

34

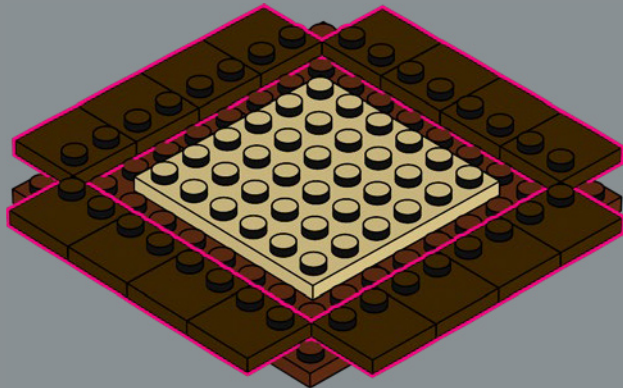

35

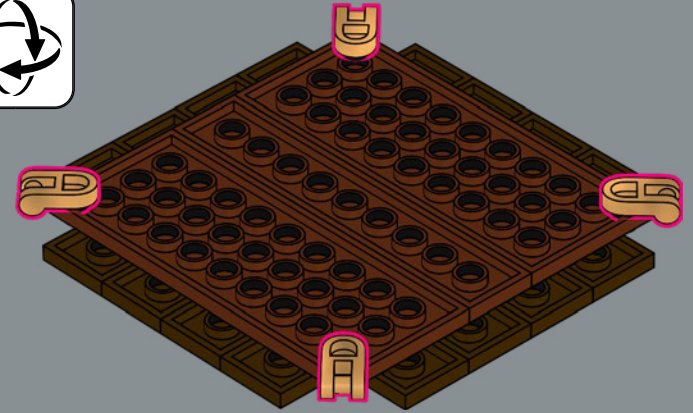

36

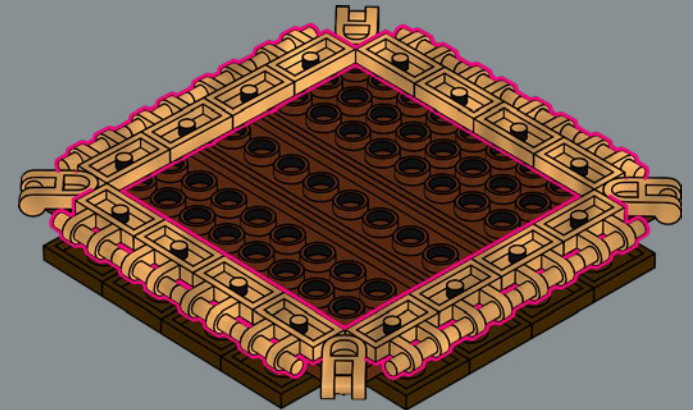

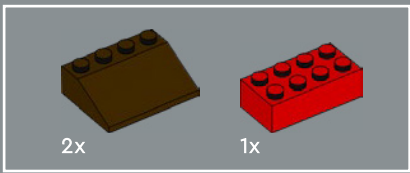

37

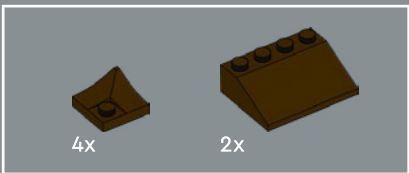
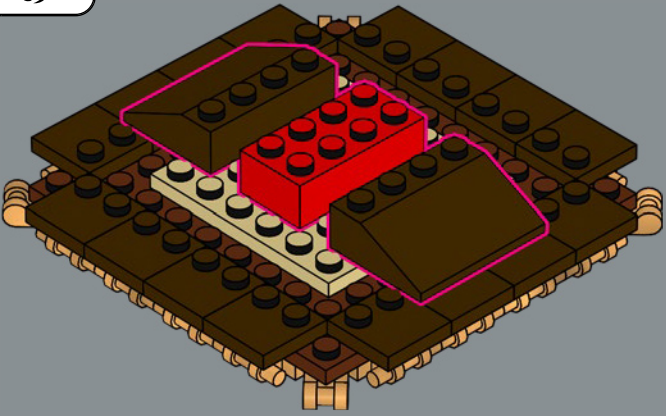

38

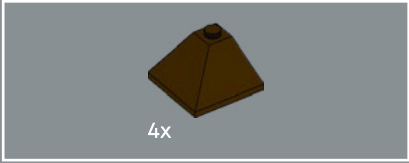
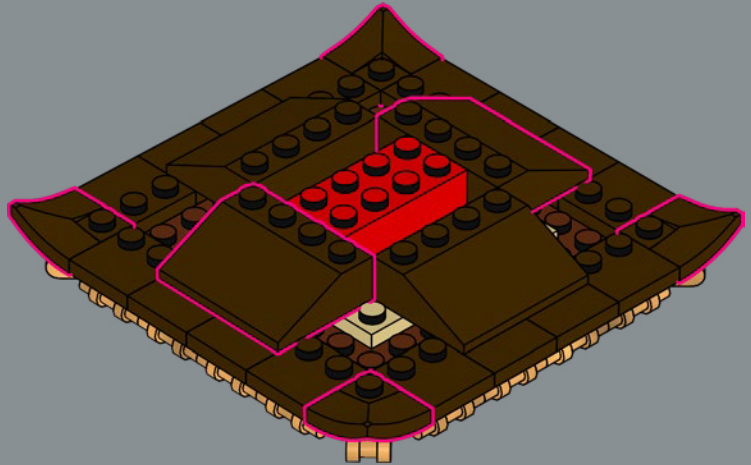

39

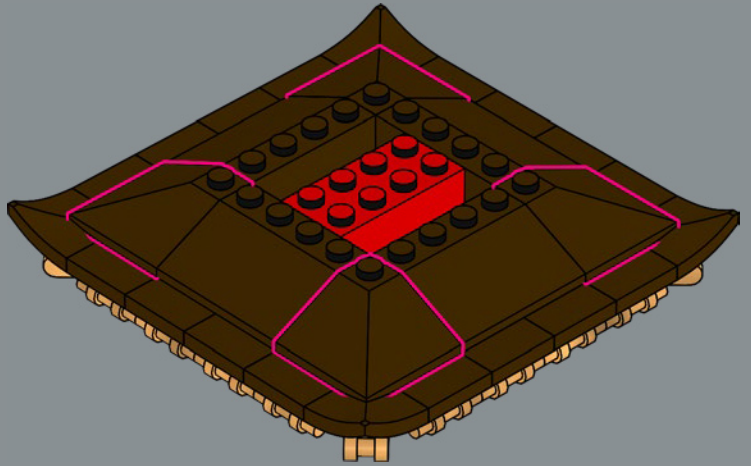

40



41

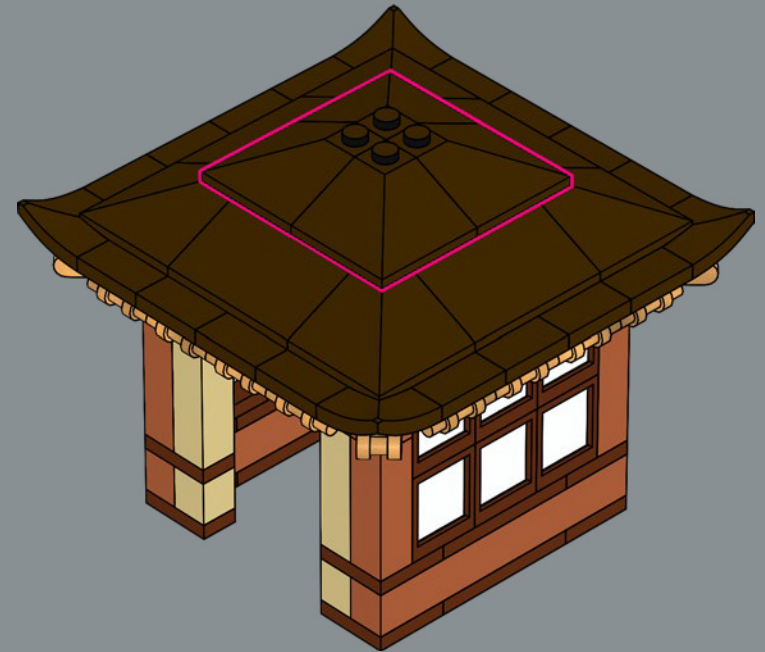
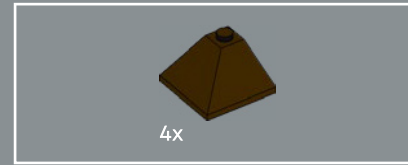



42

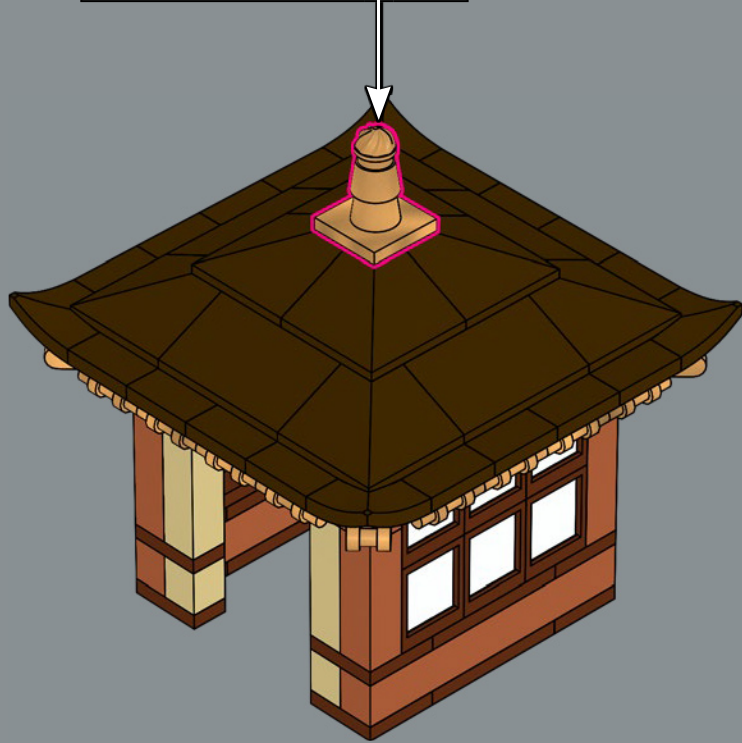
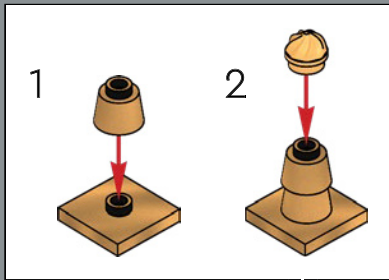

La mayoría de los pabellones de los jardines meditativos están hechos de madera para que se integren armoniosamente en el entorno.

43

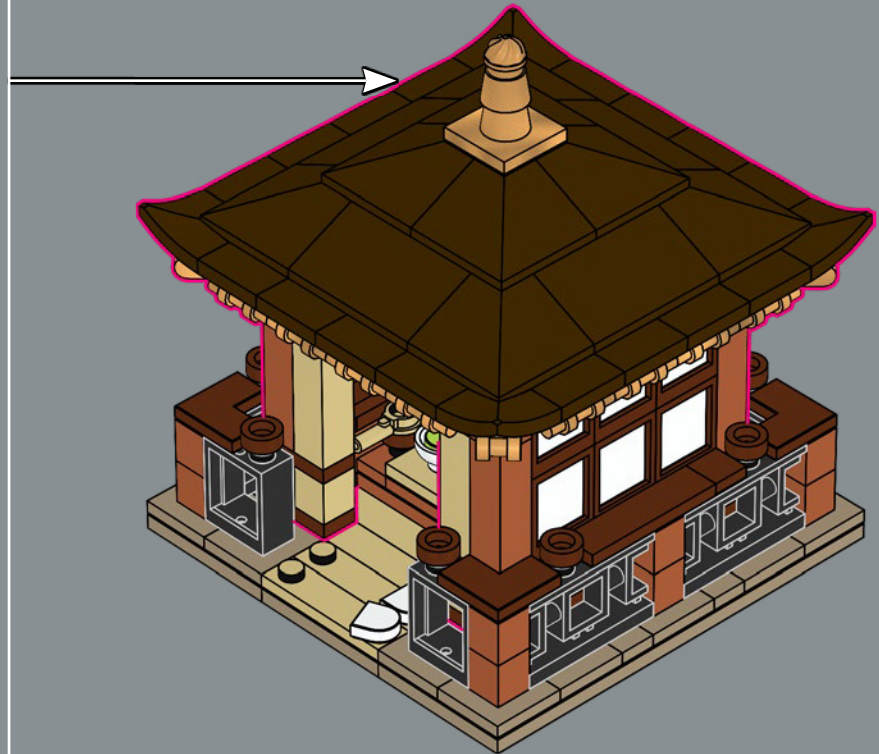

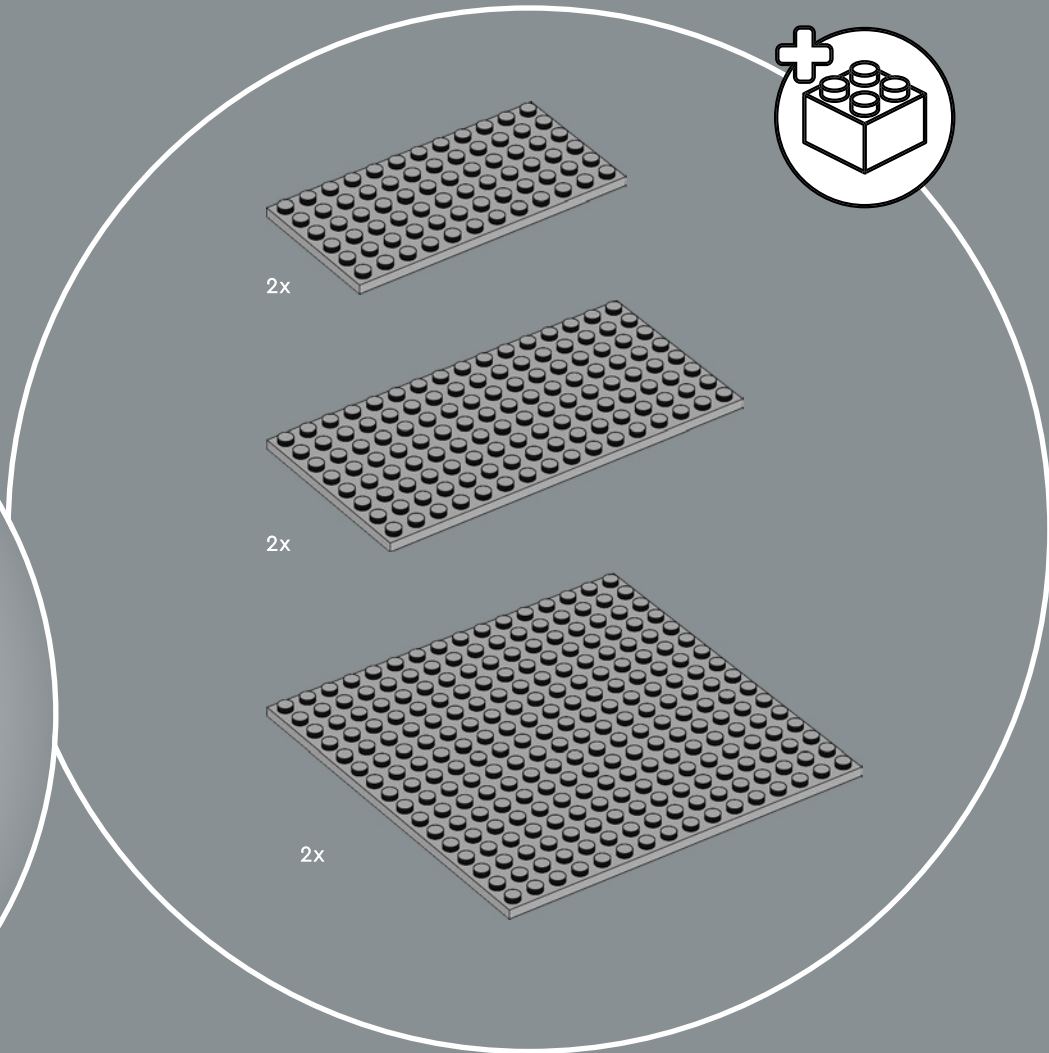

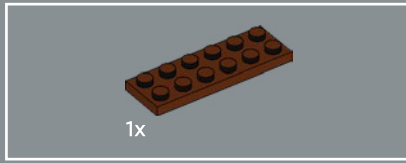
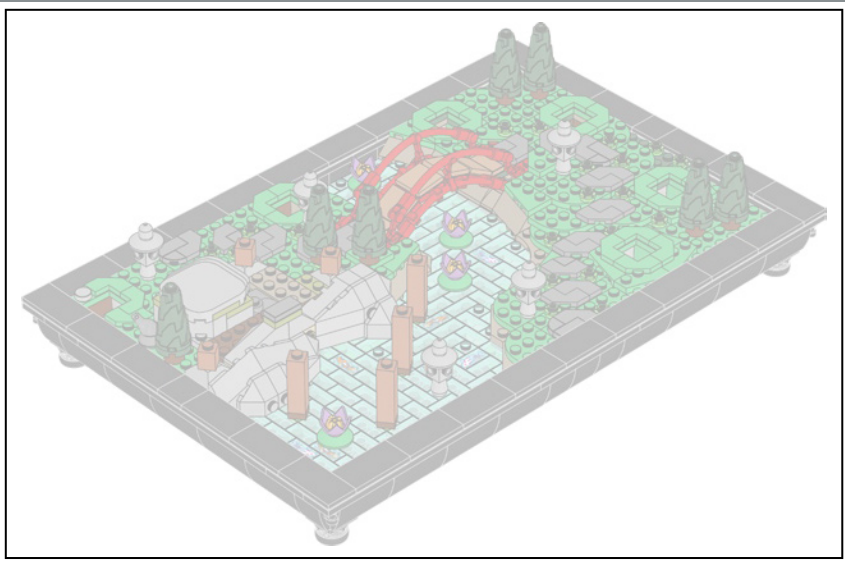

44

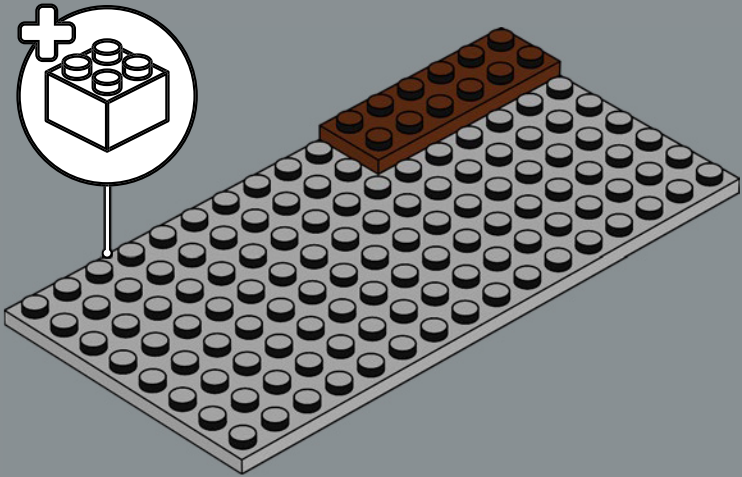

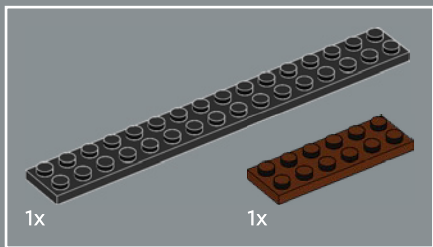

45

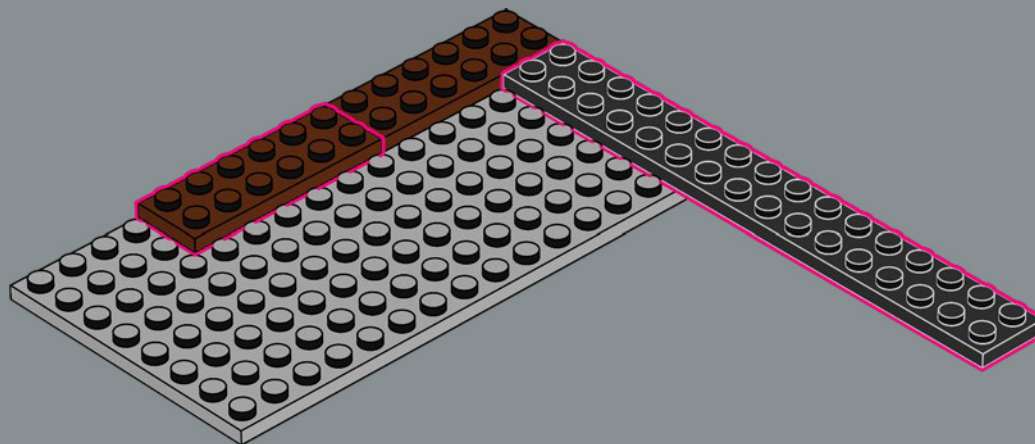

46

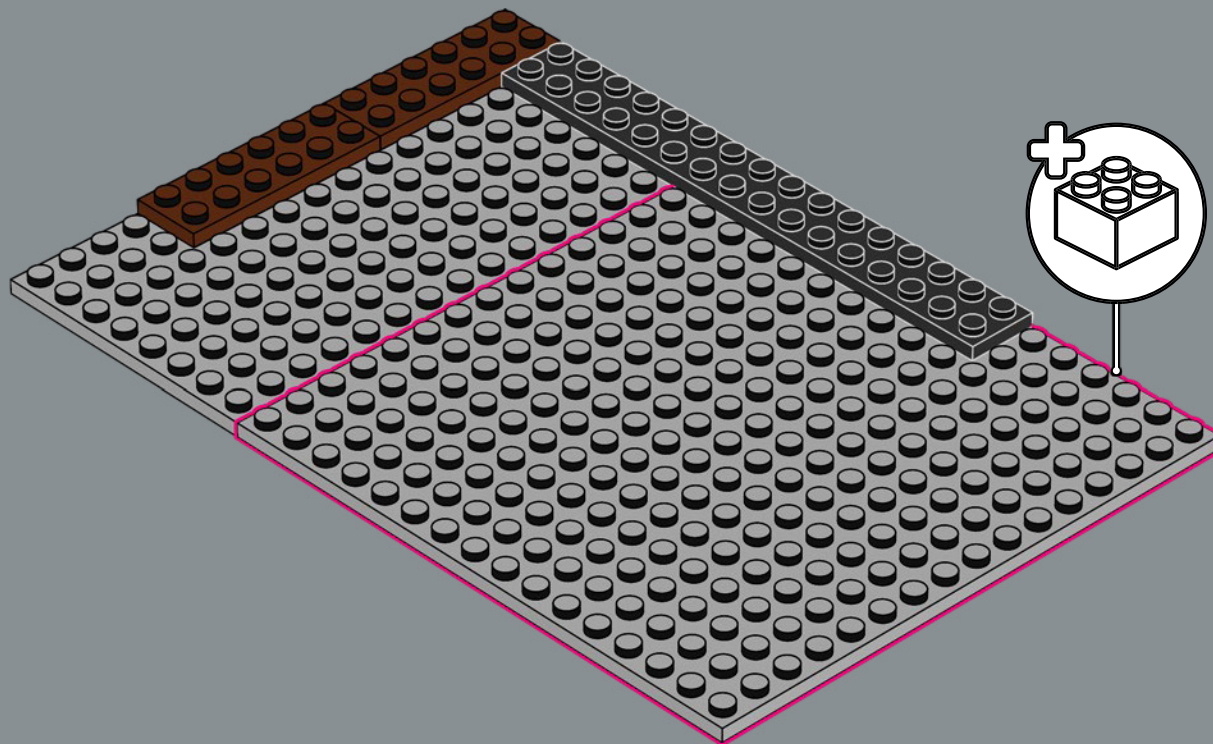

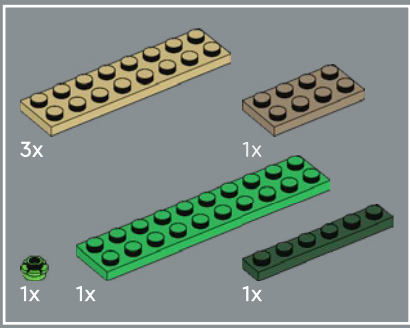

47

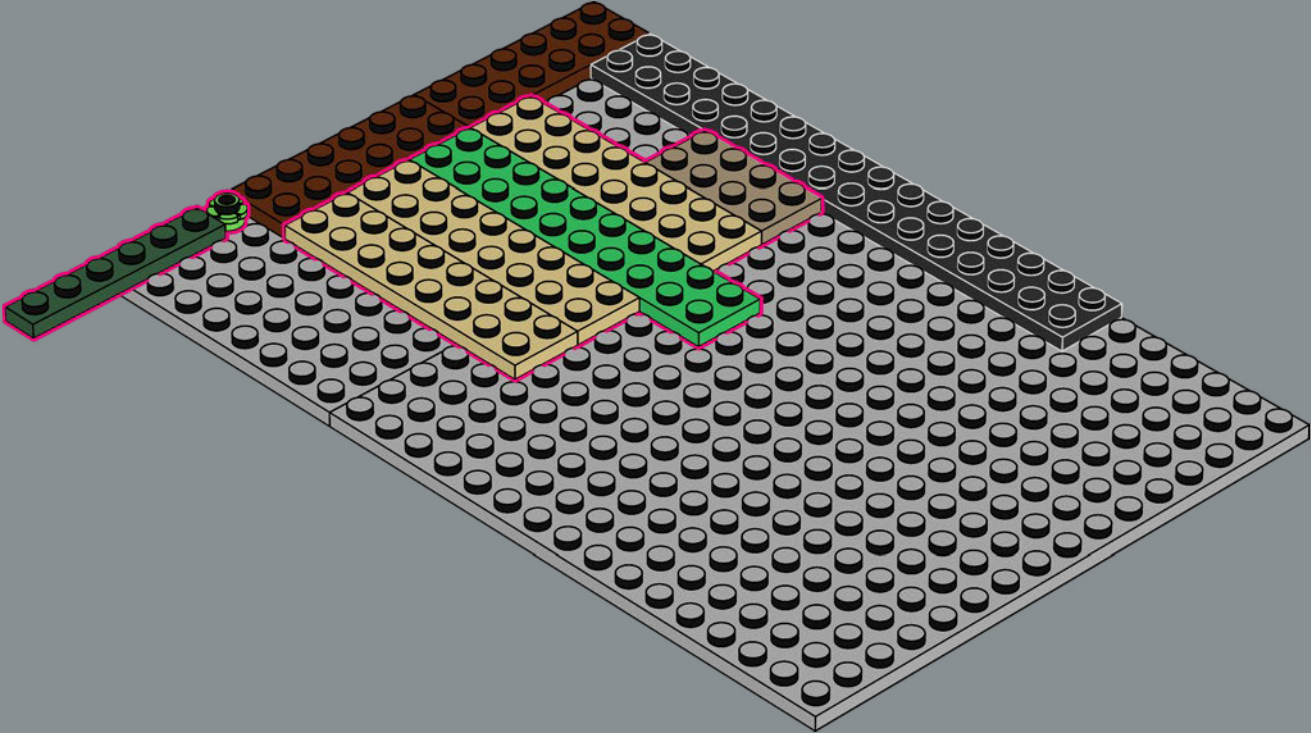

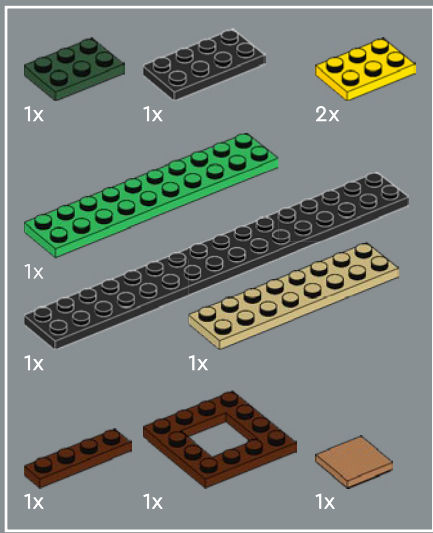

48

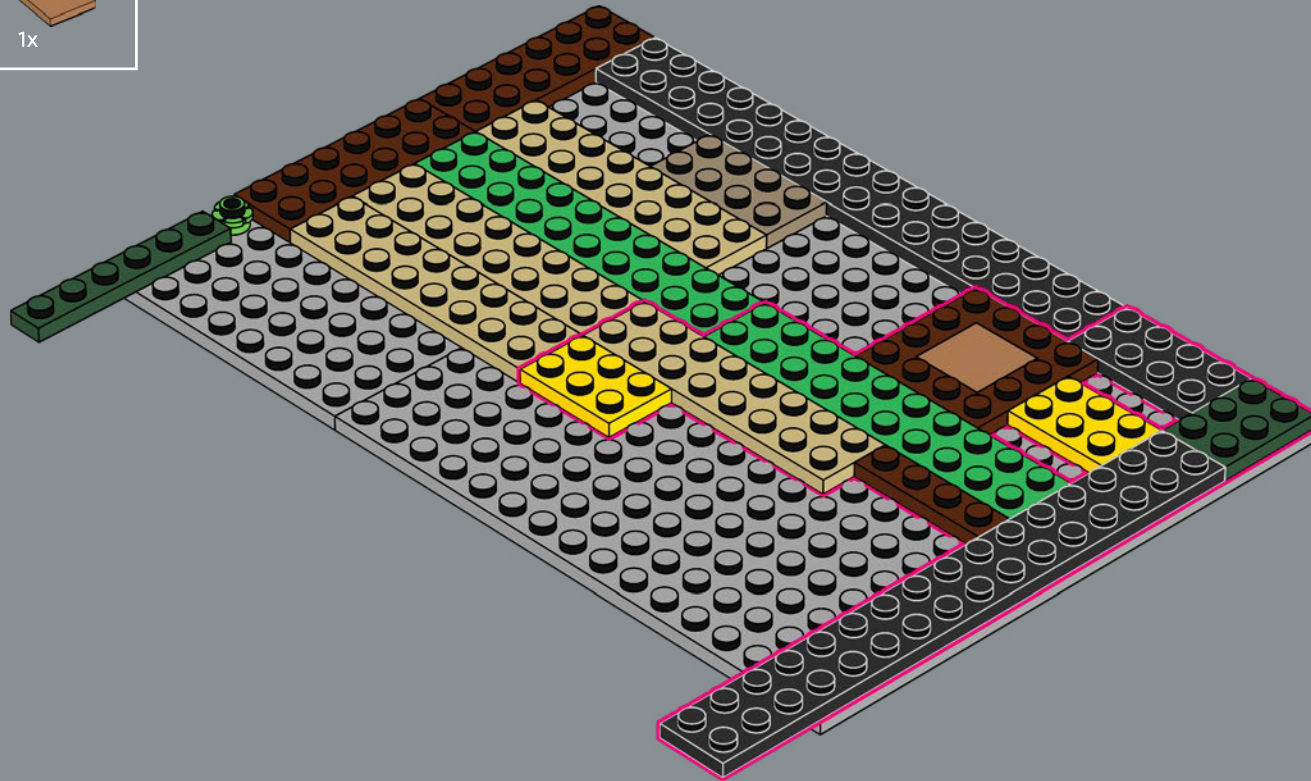

49

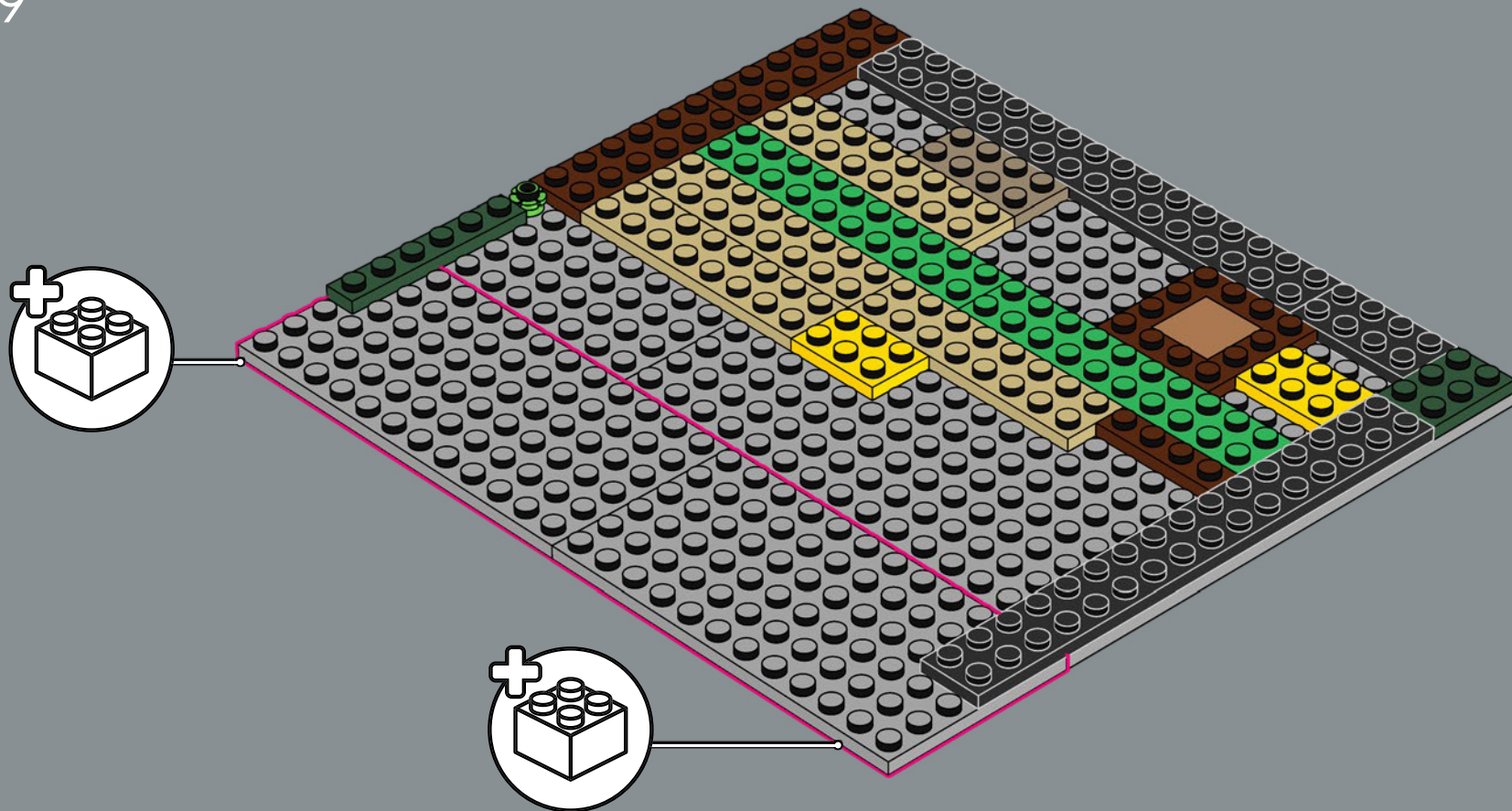

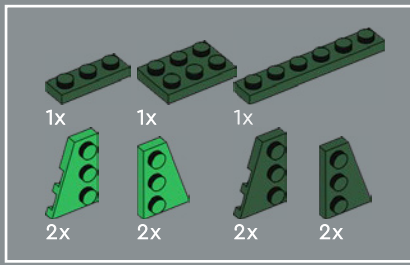

50

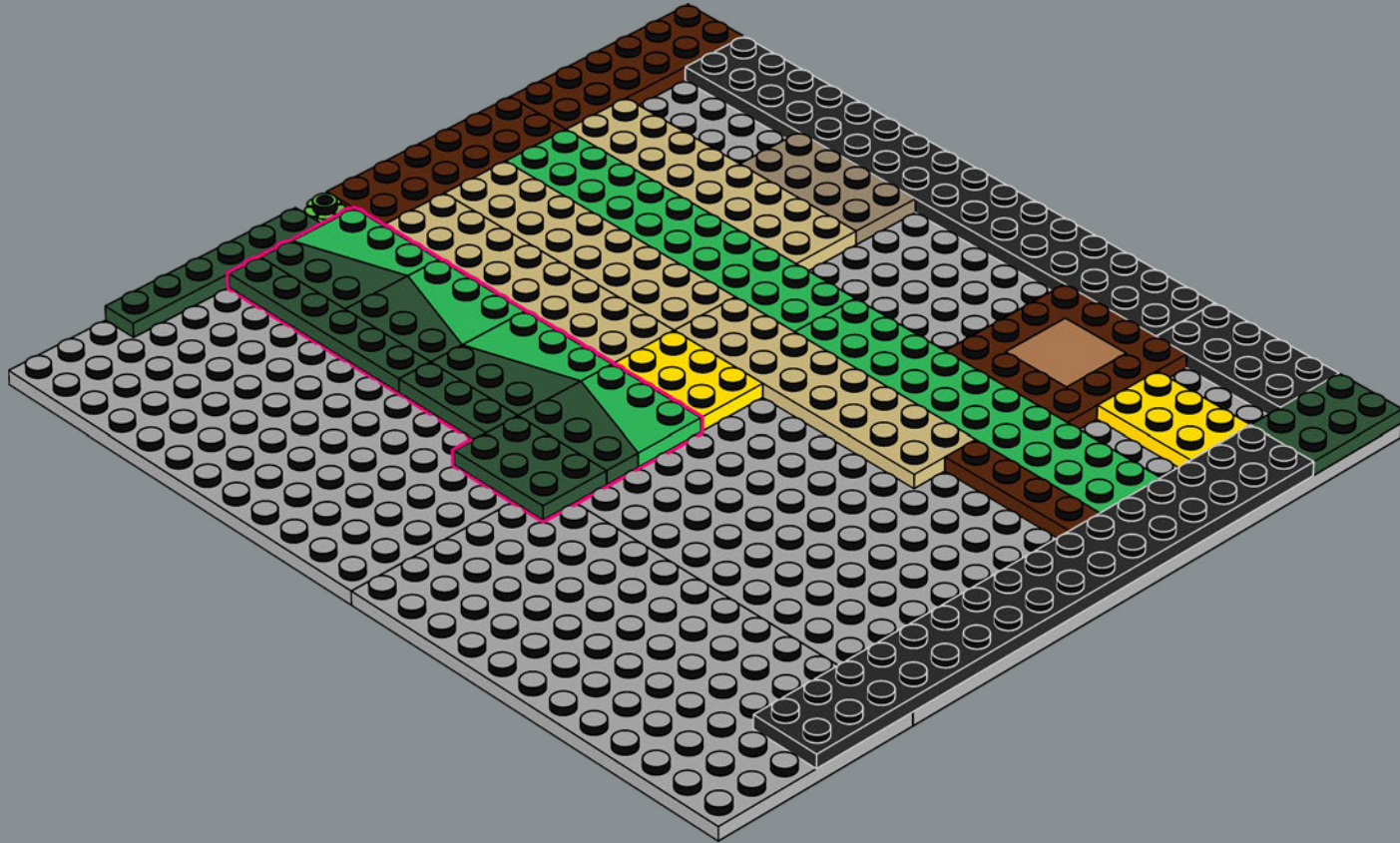

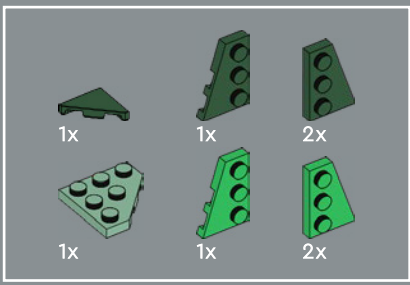

51

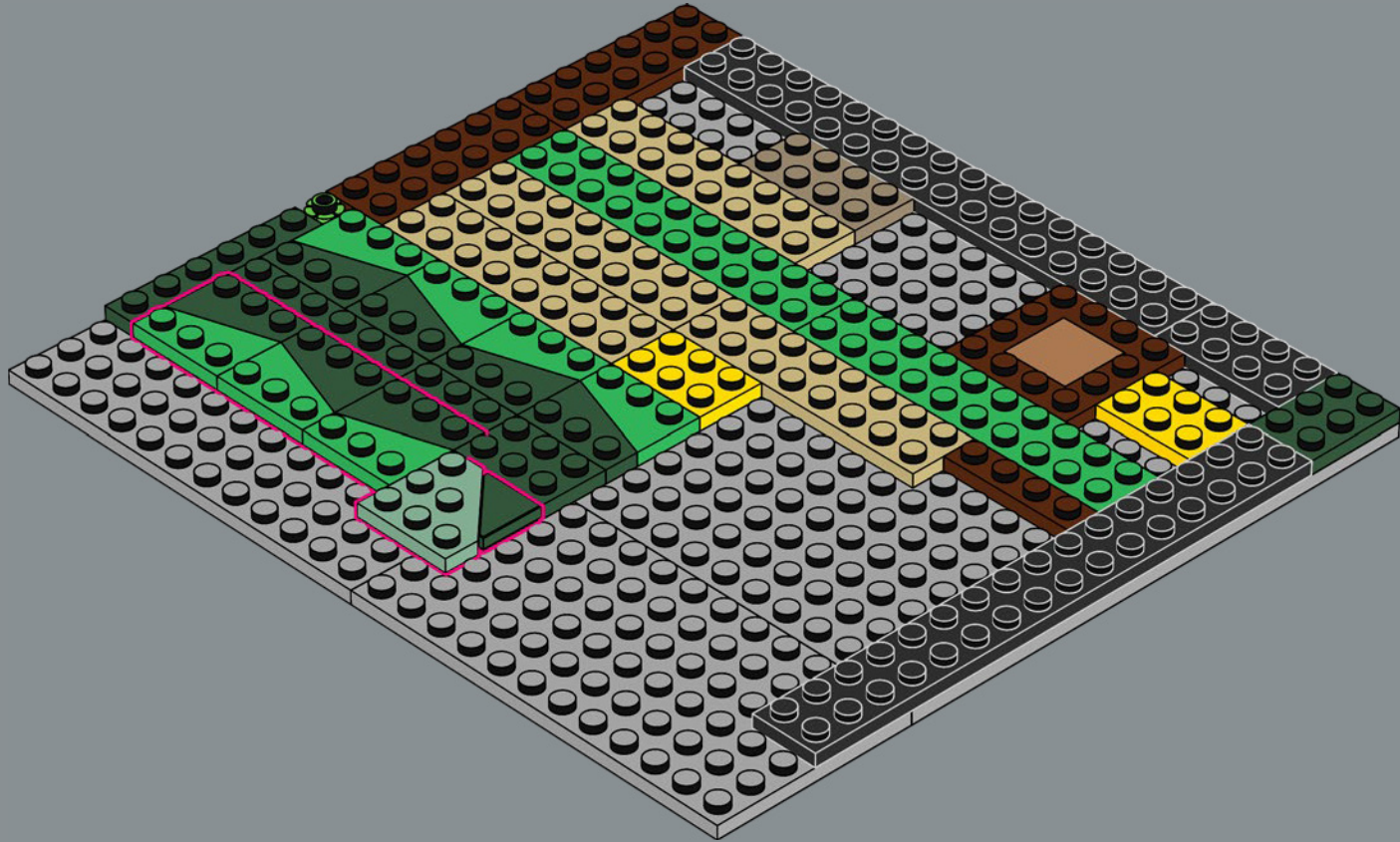

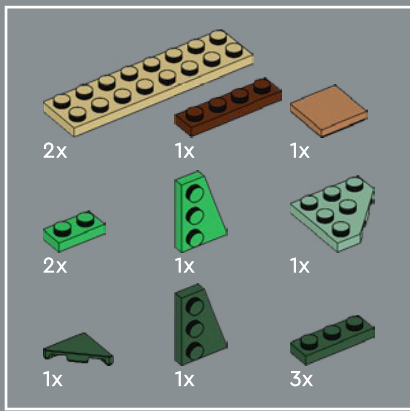

52

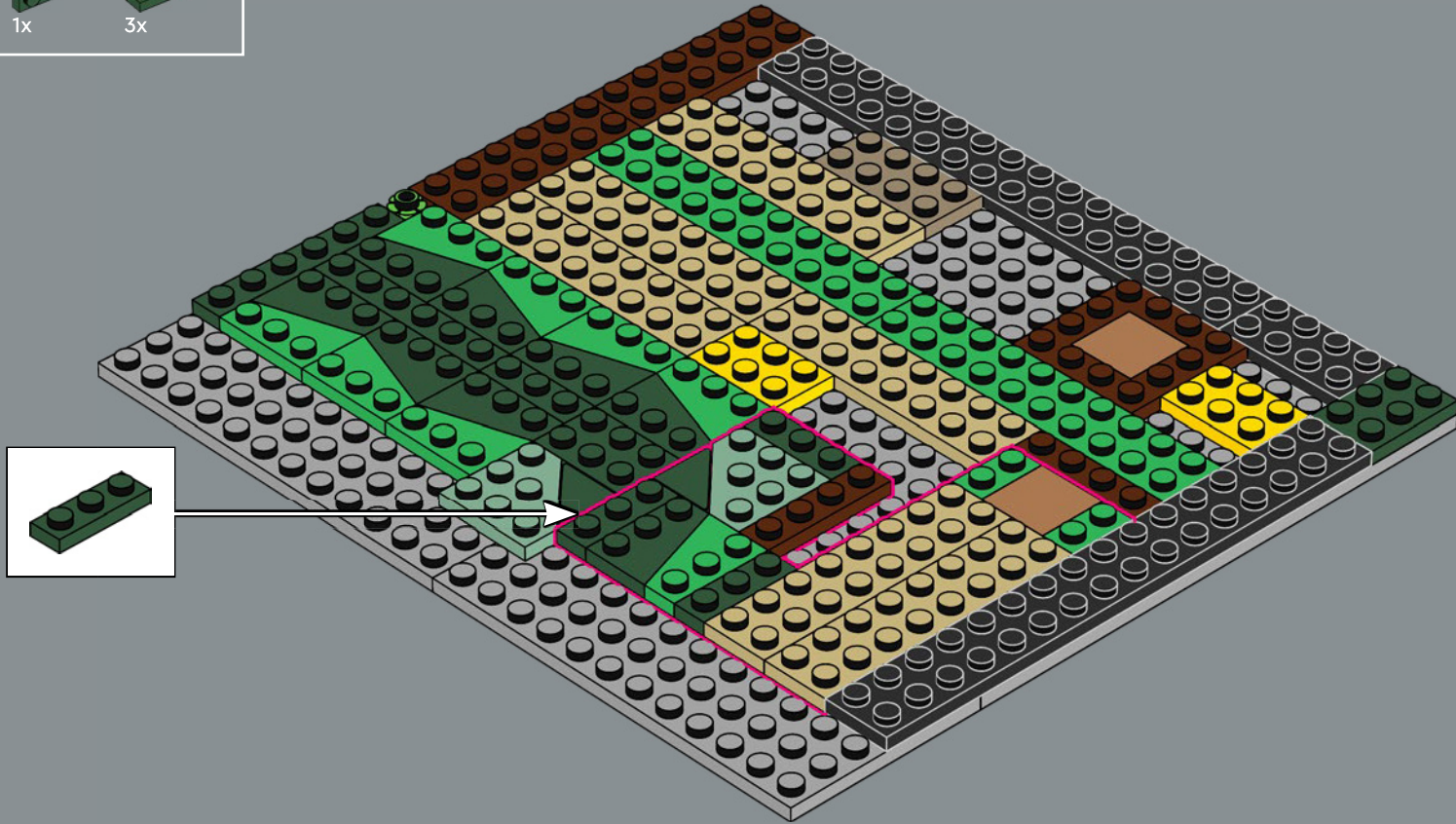

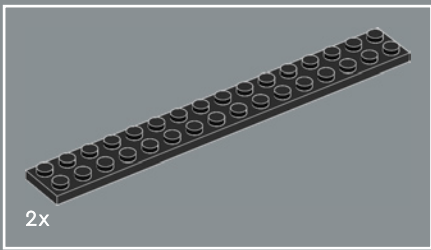

53

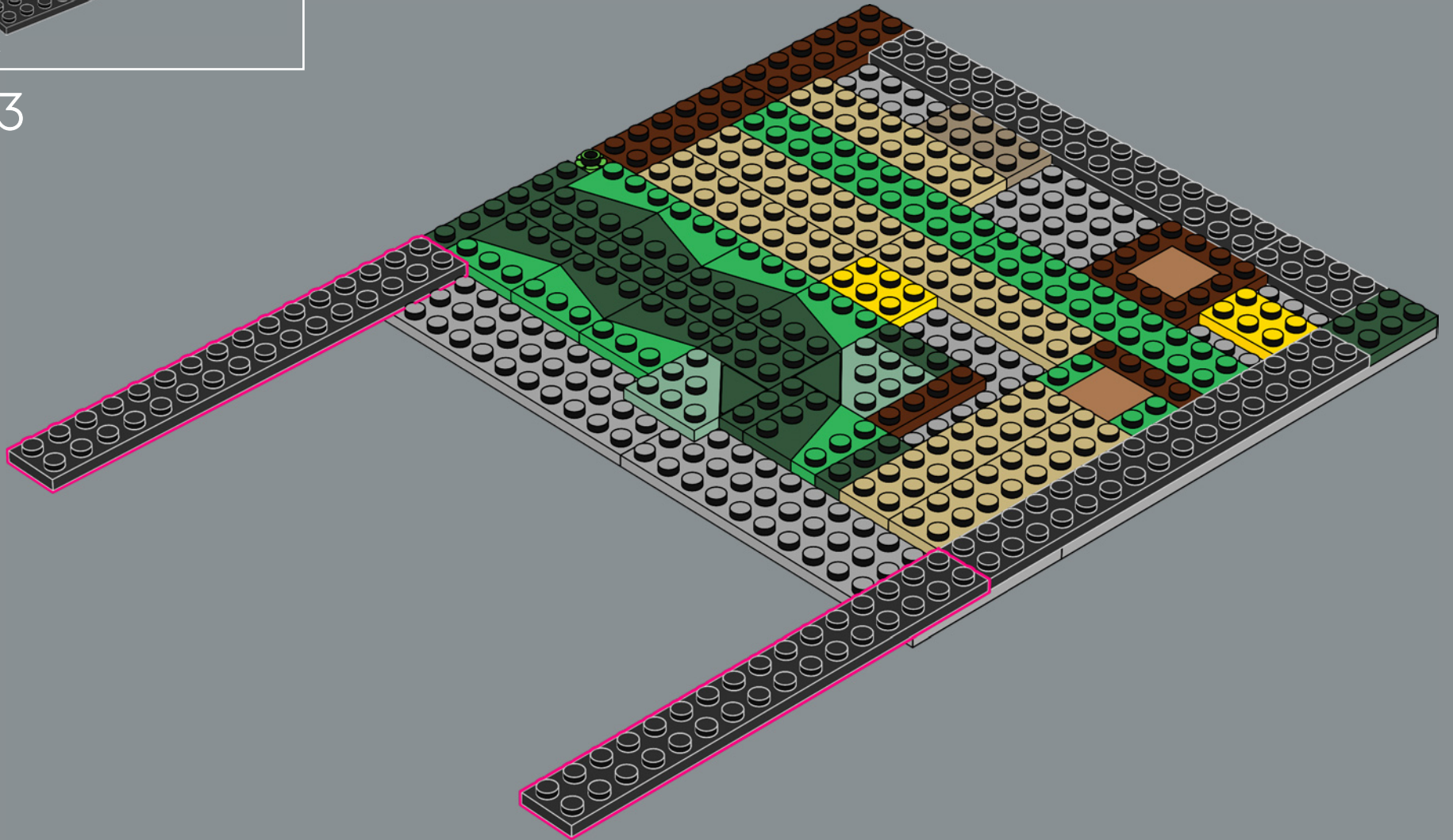

54

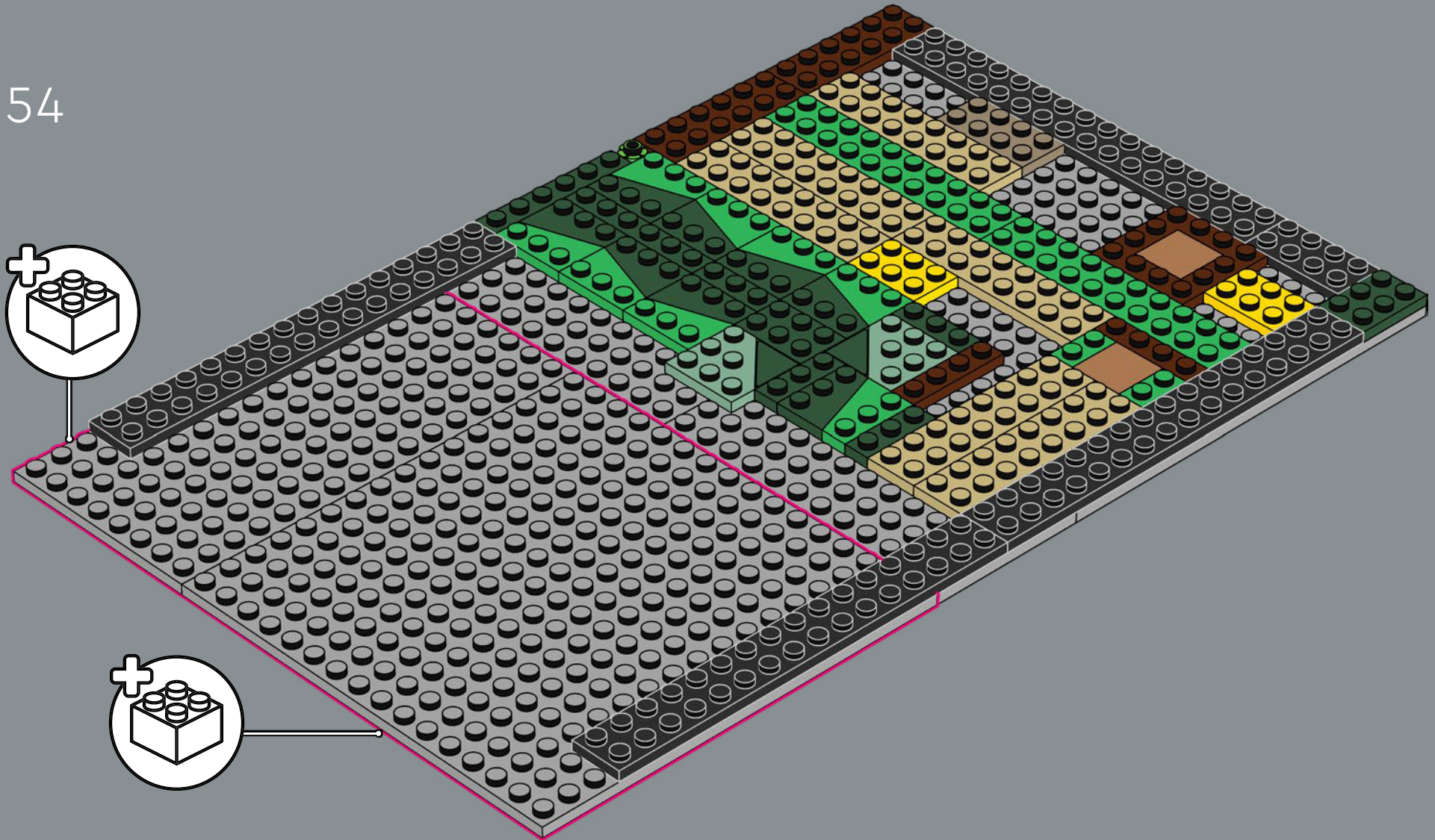

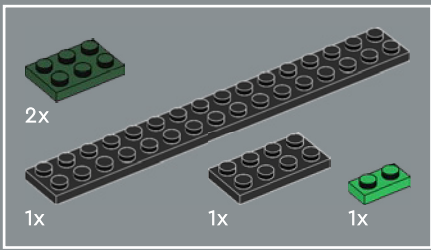

55

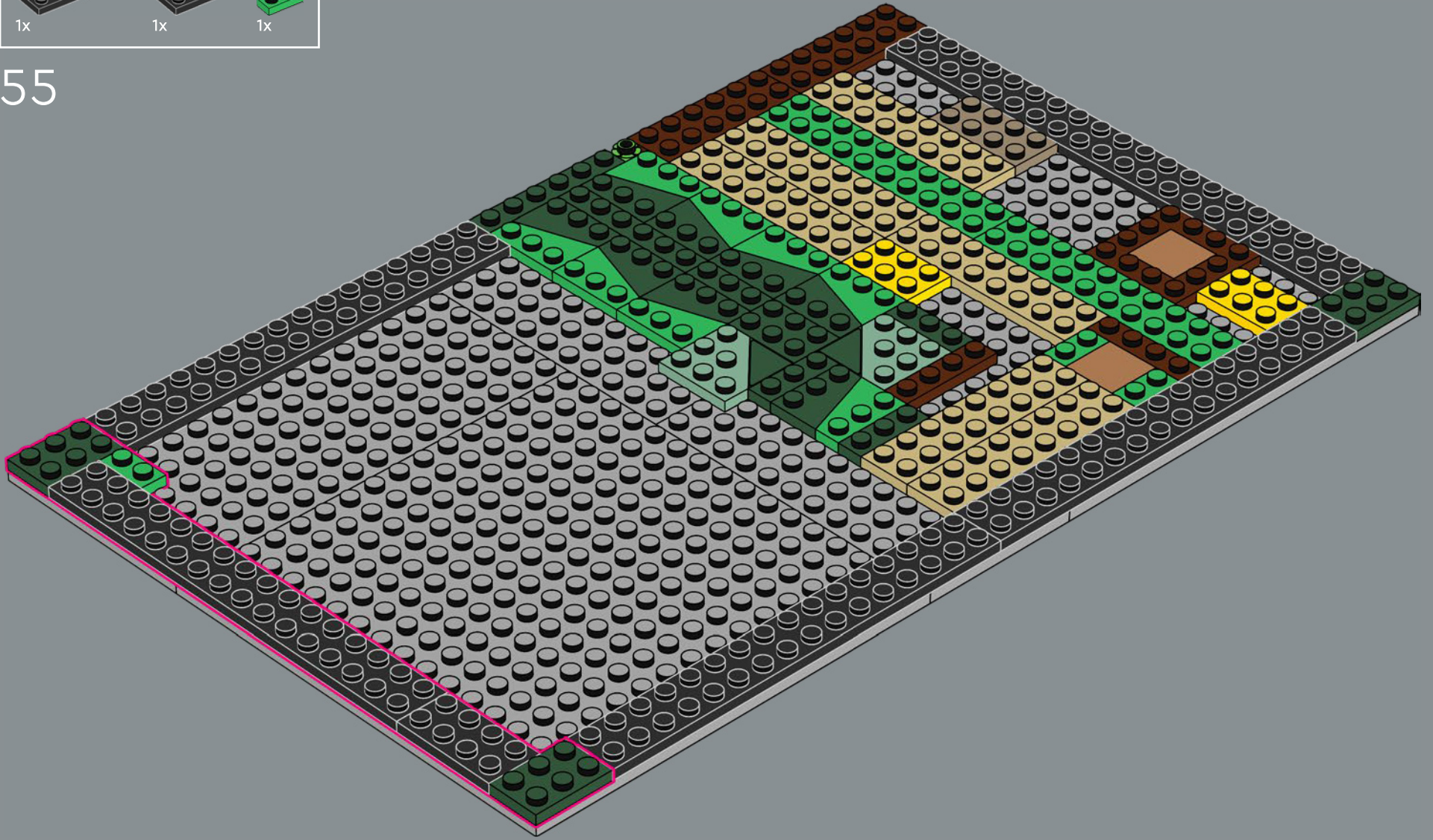

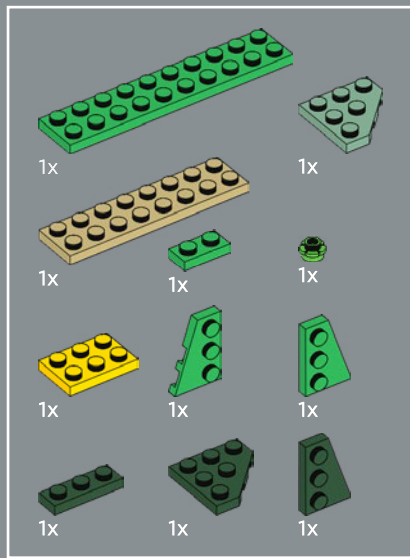

56

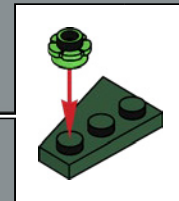
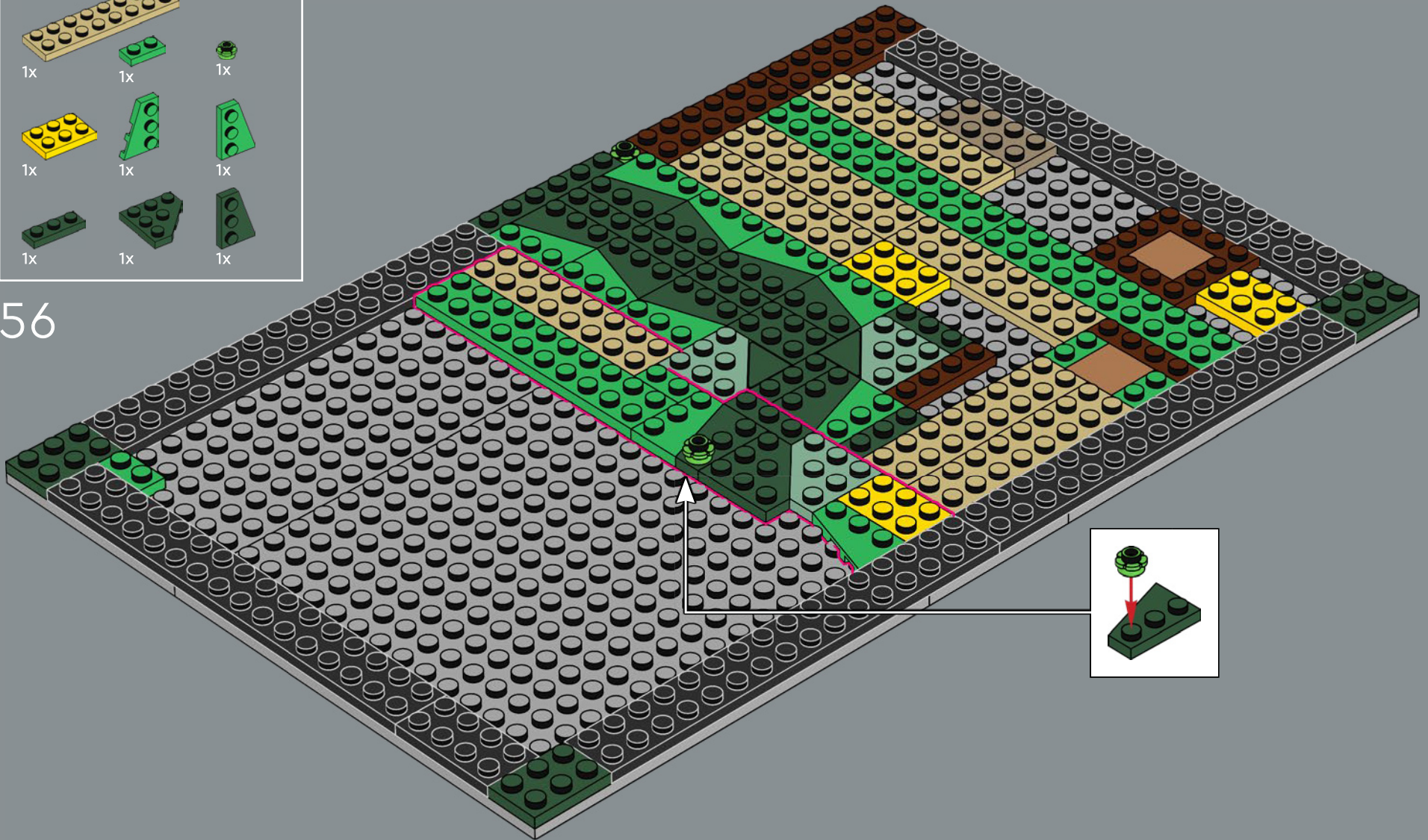

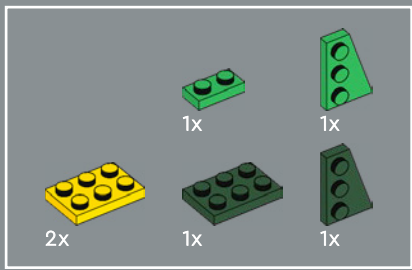

57

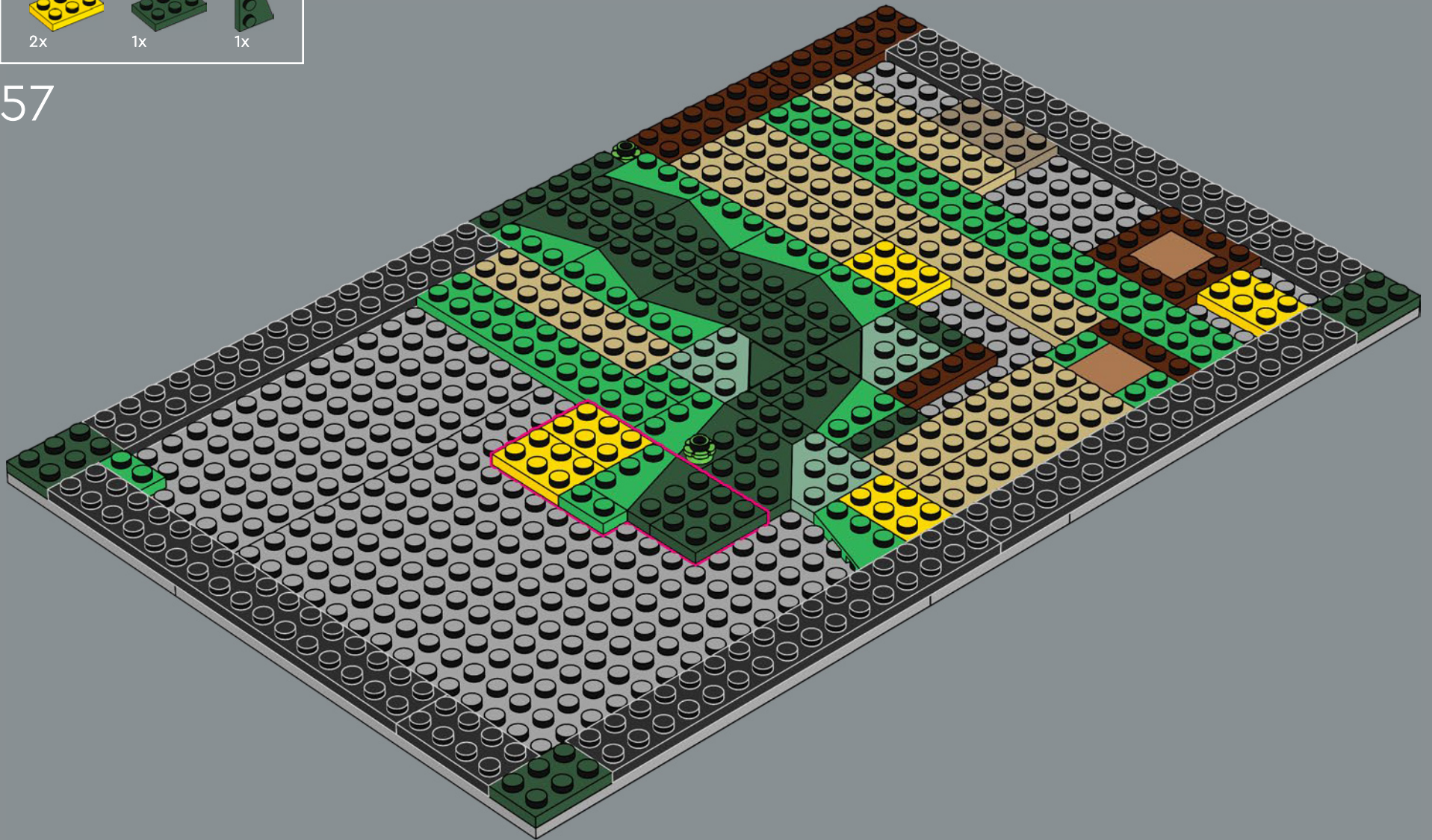

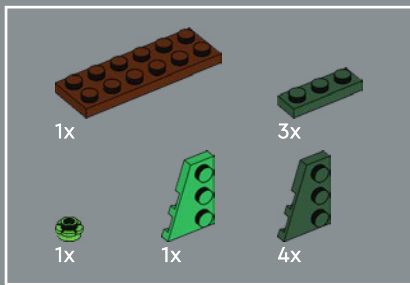

58

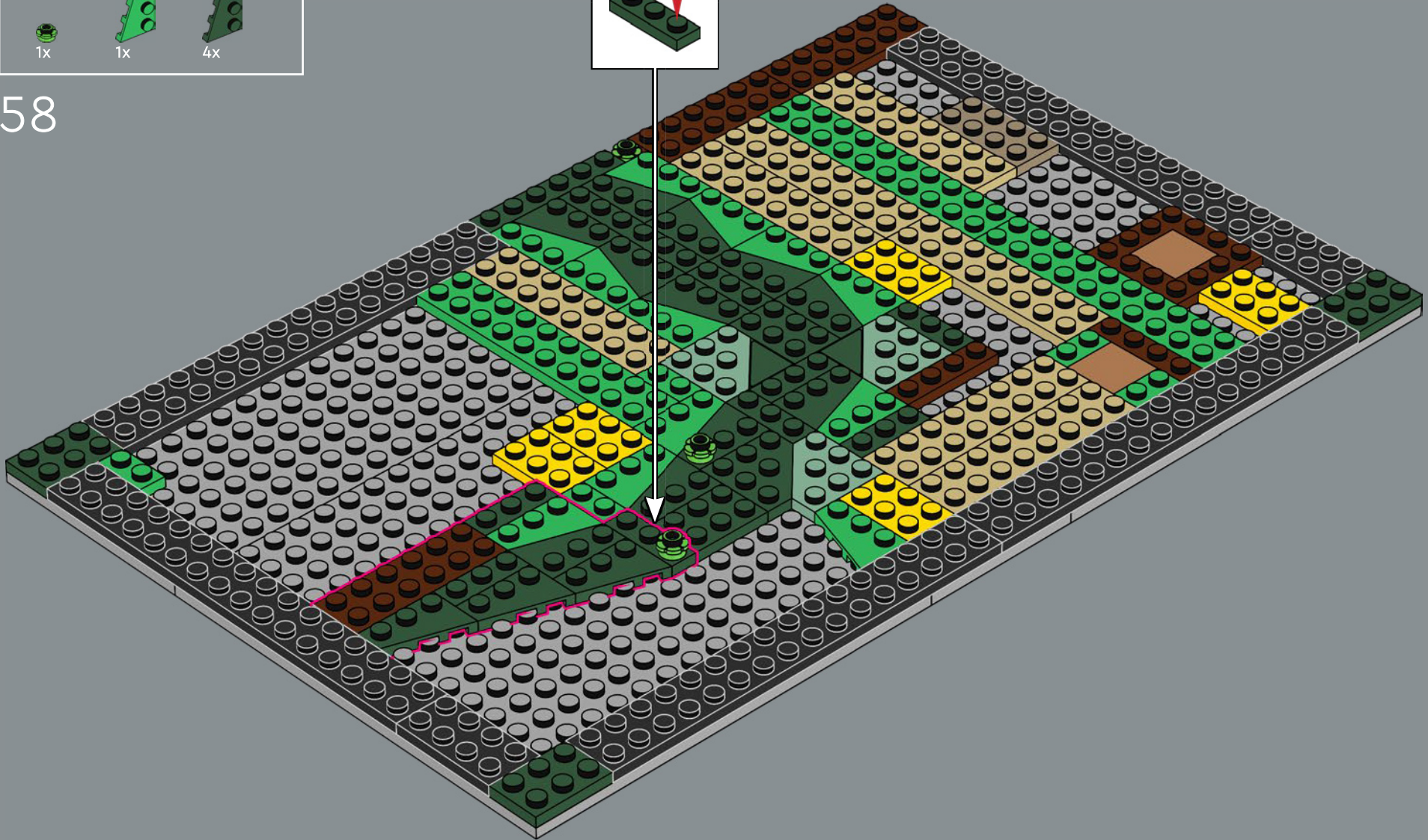
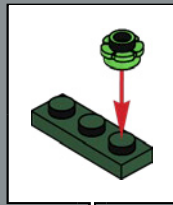

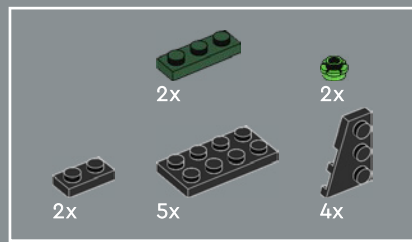

59

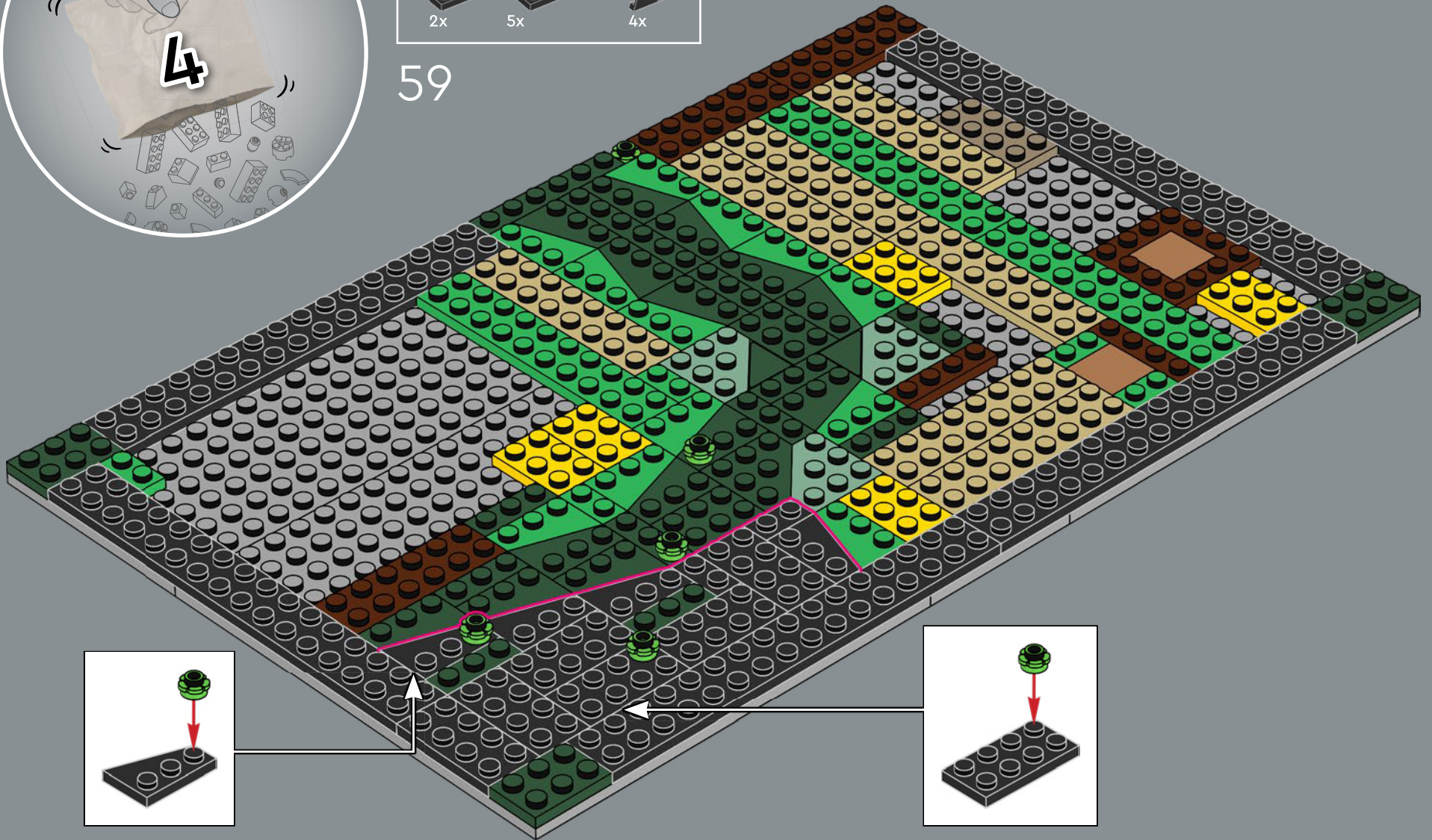

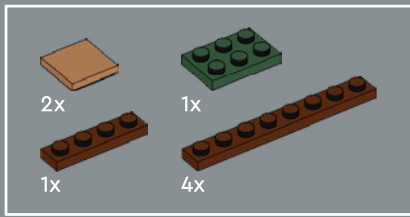

60

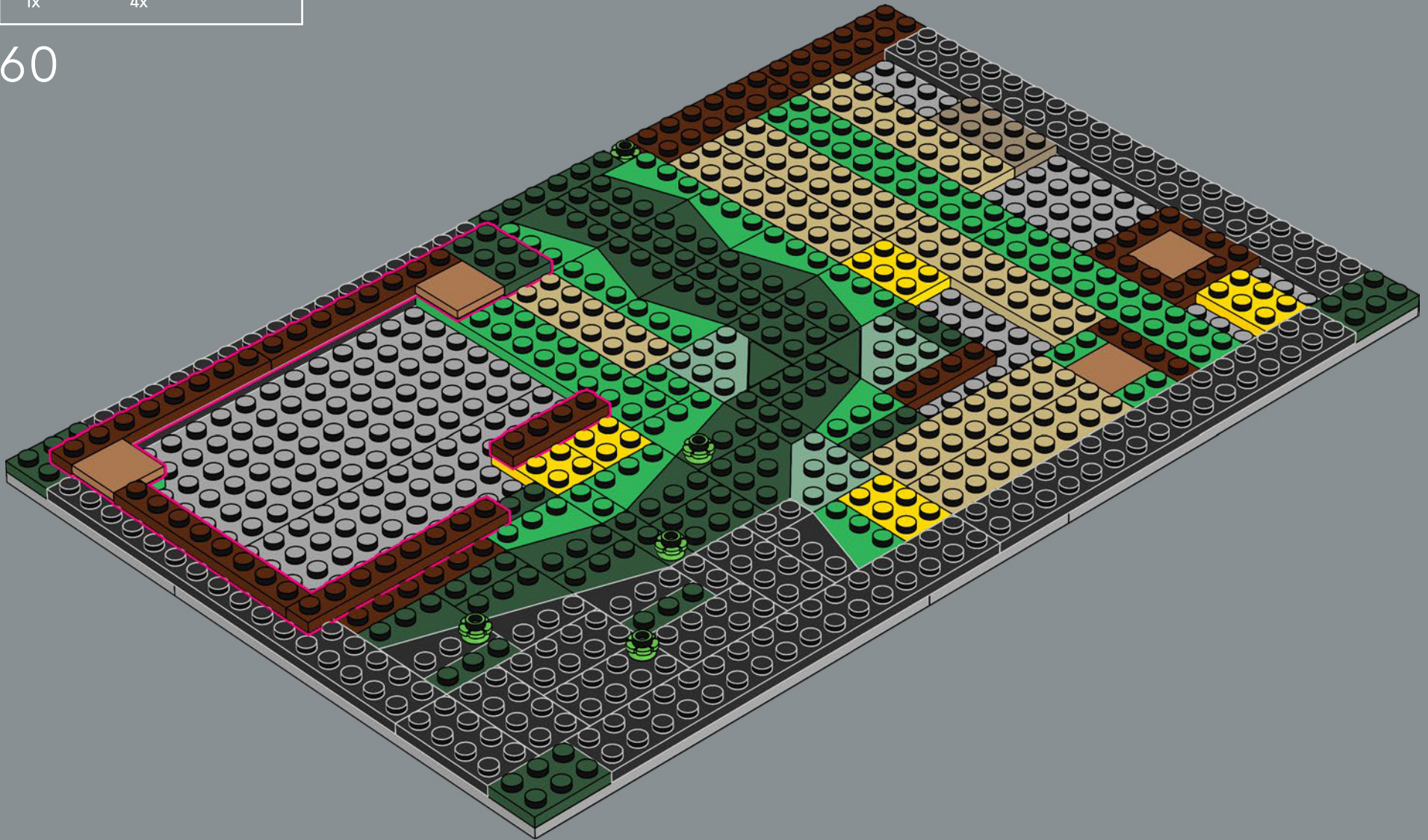

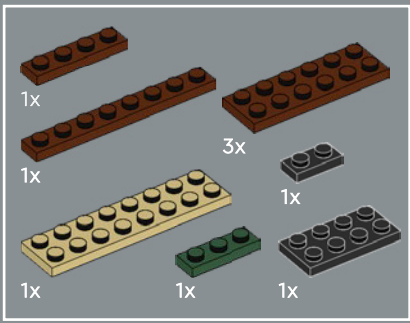

61

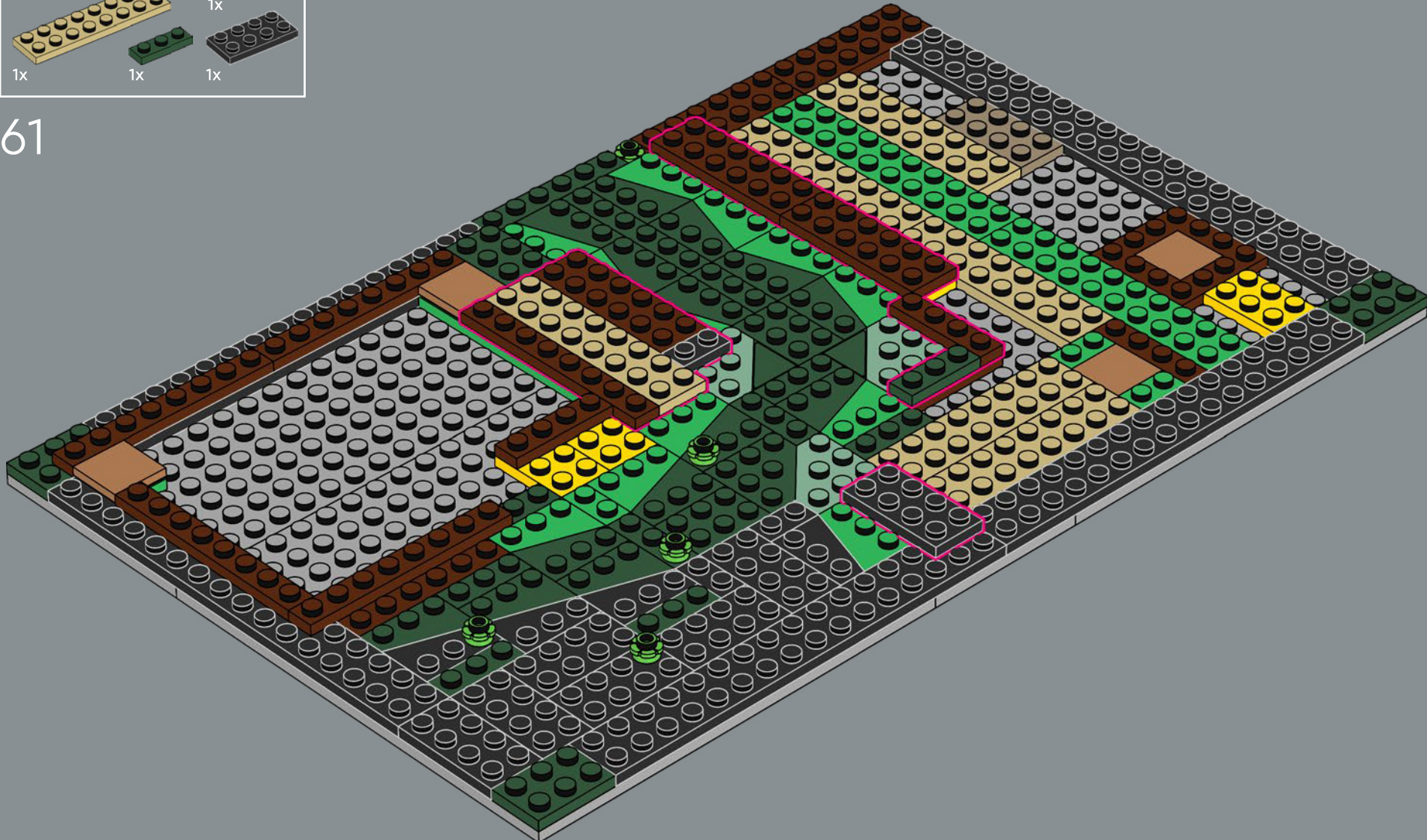

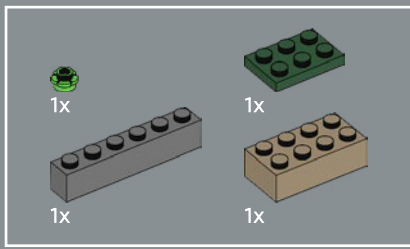

62

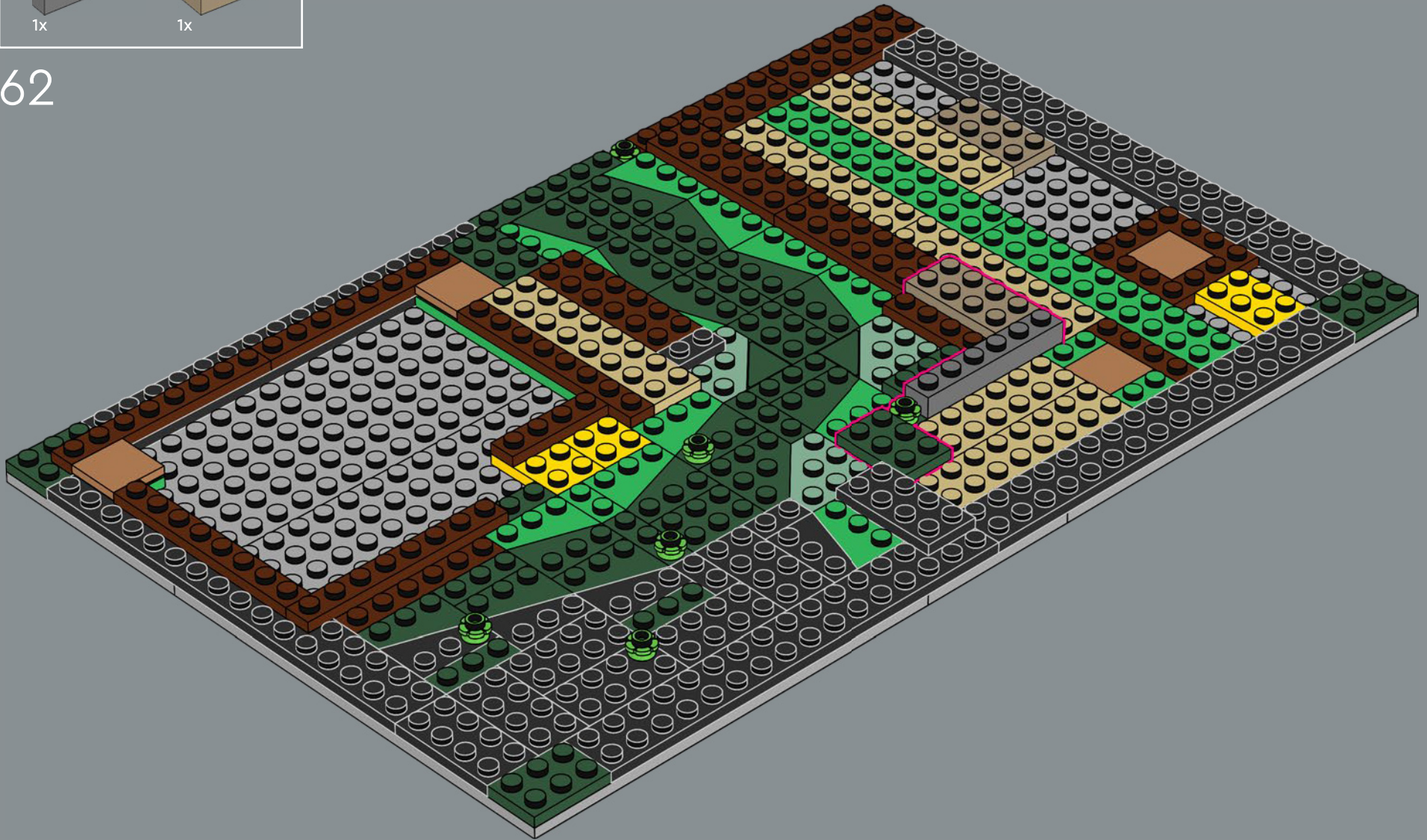

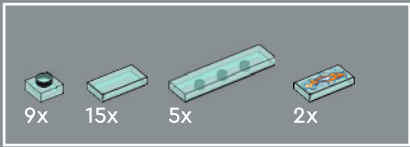

63

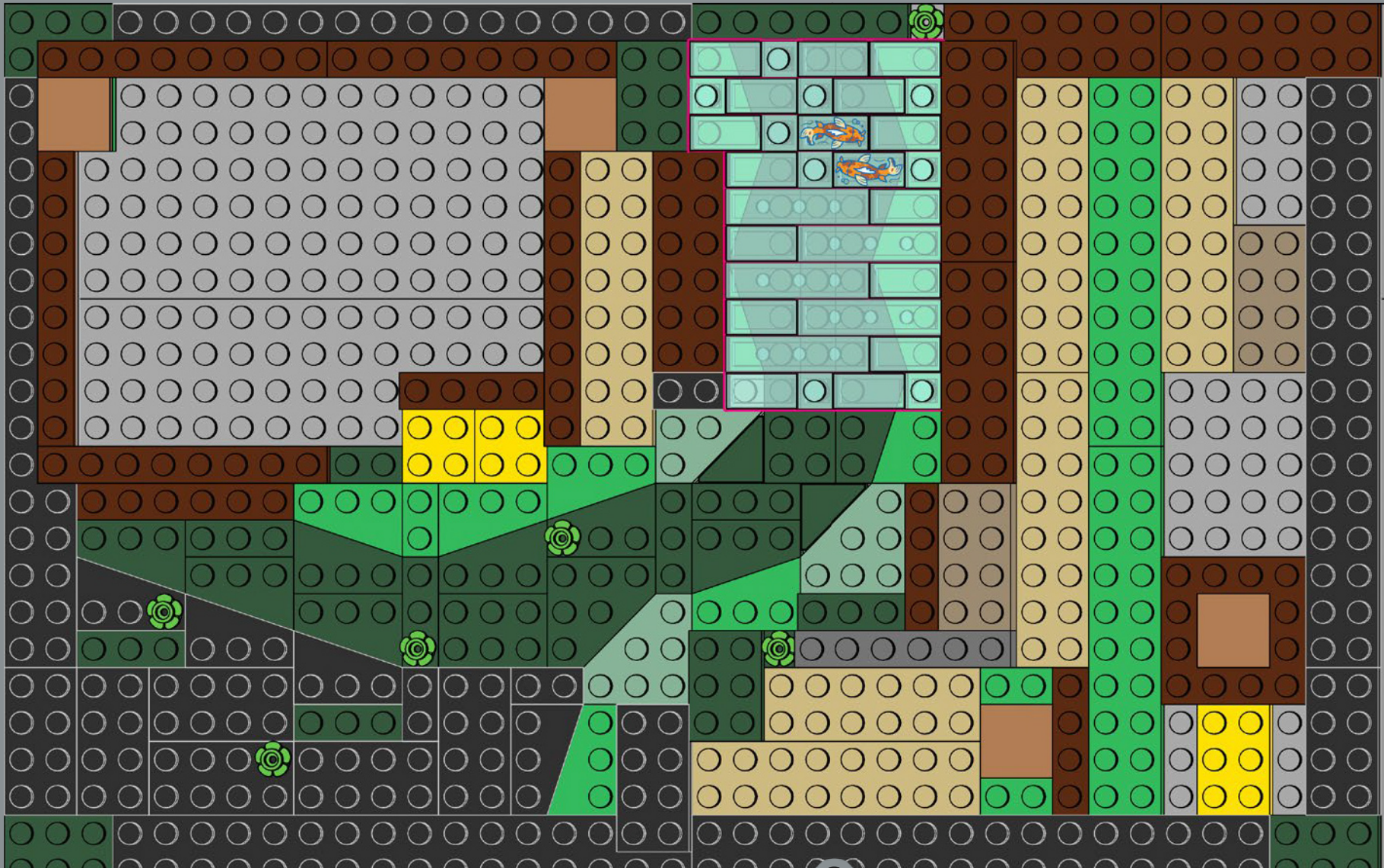



64

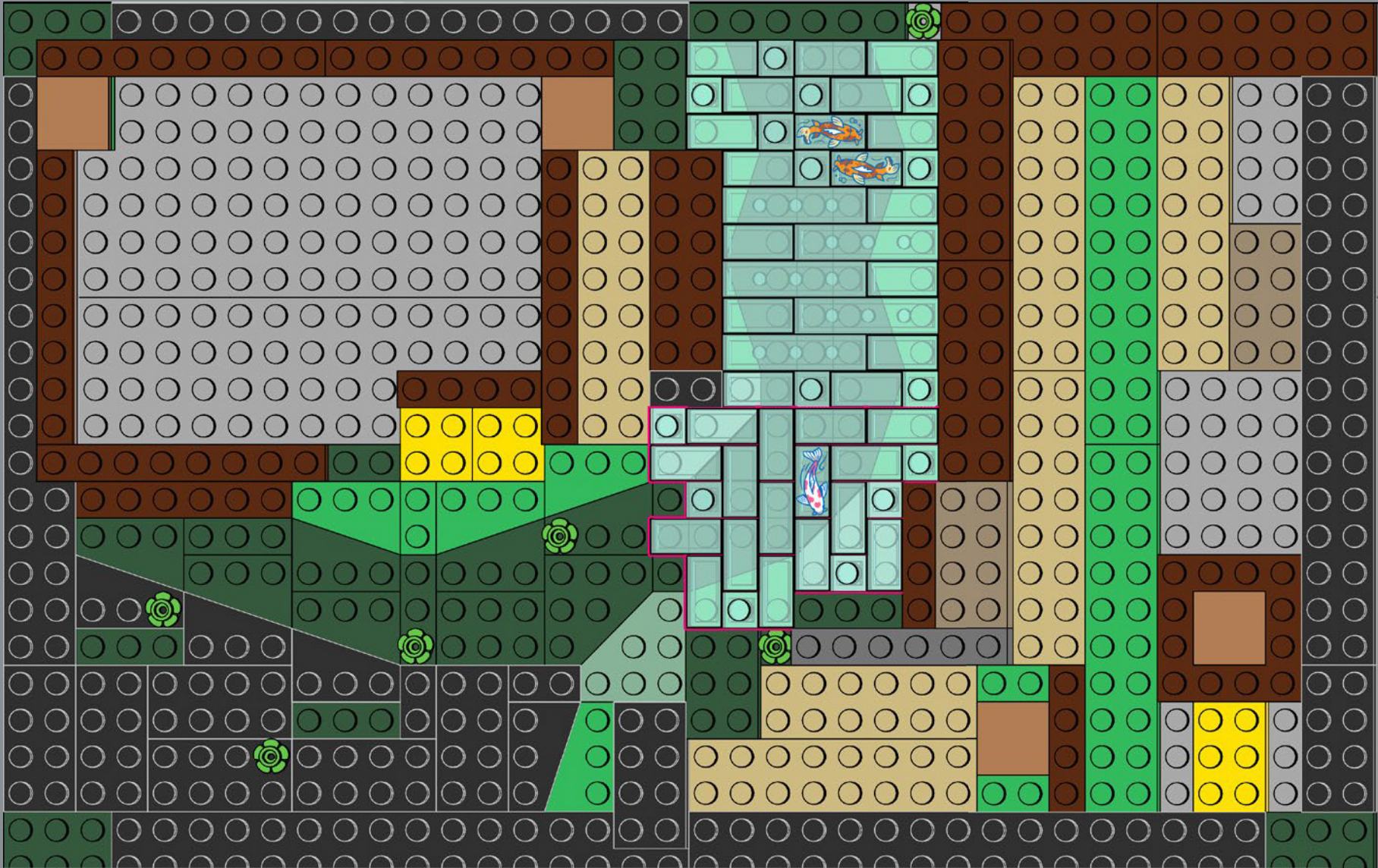

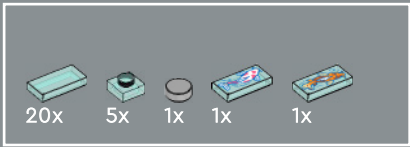

65

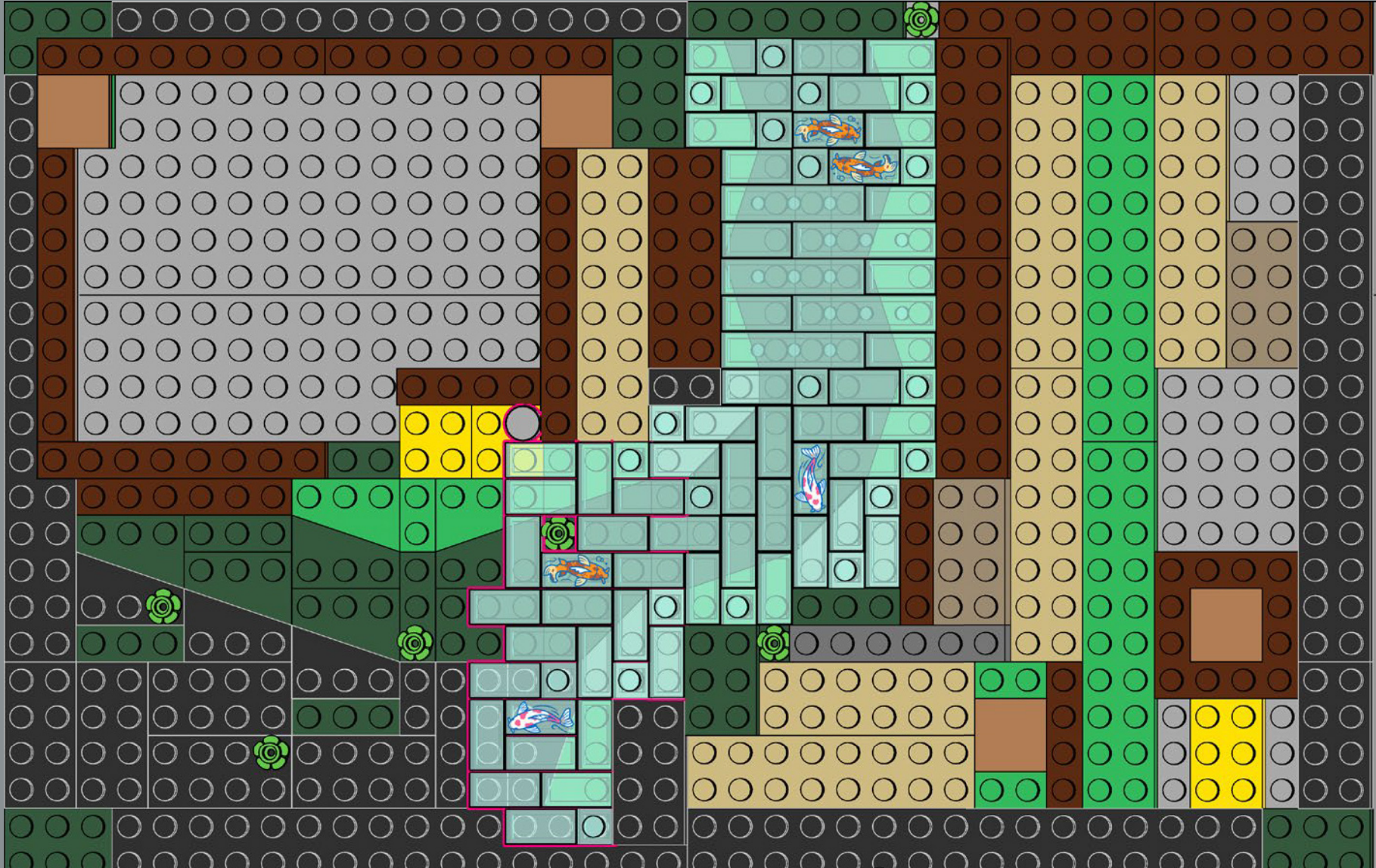

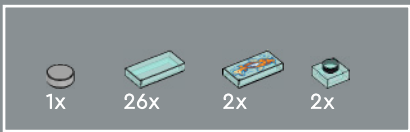

66

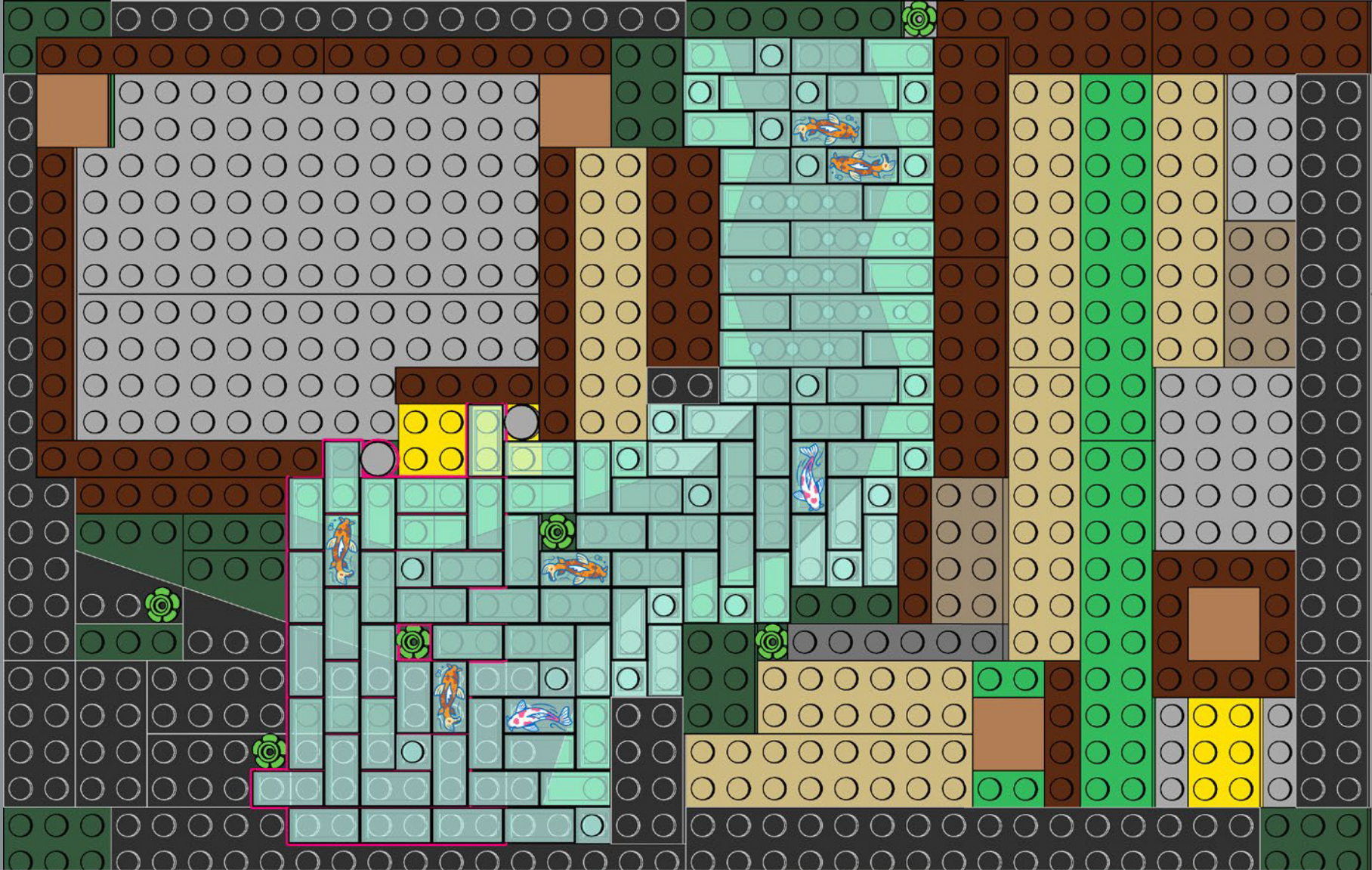

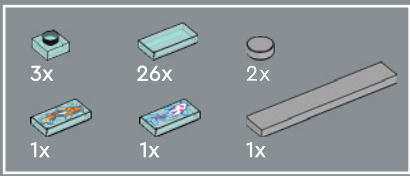

67

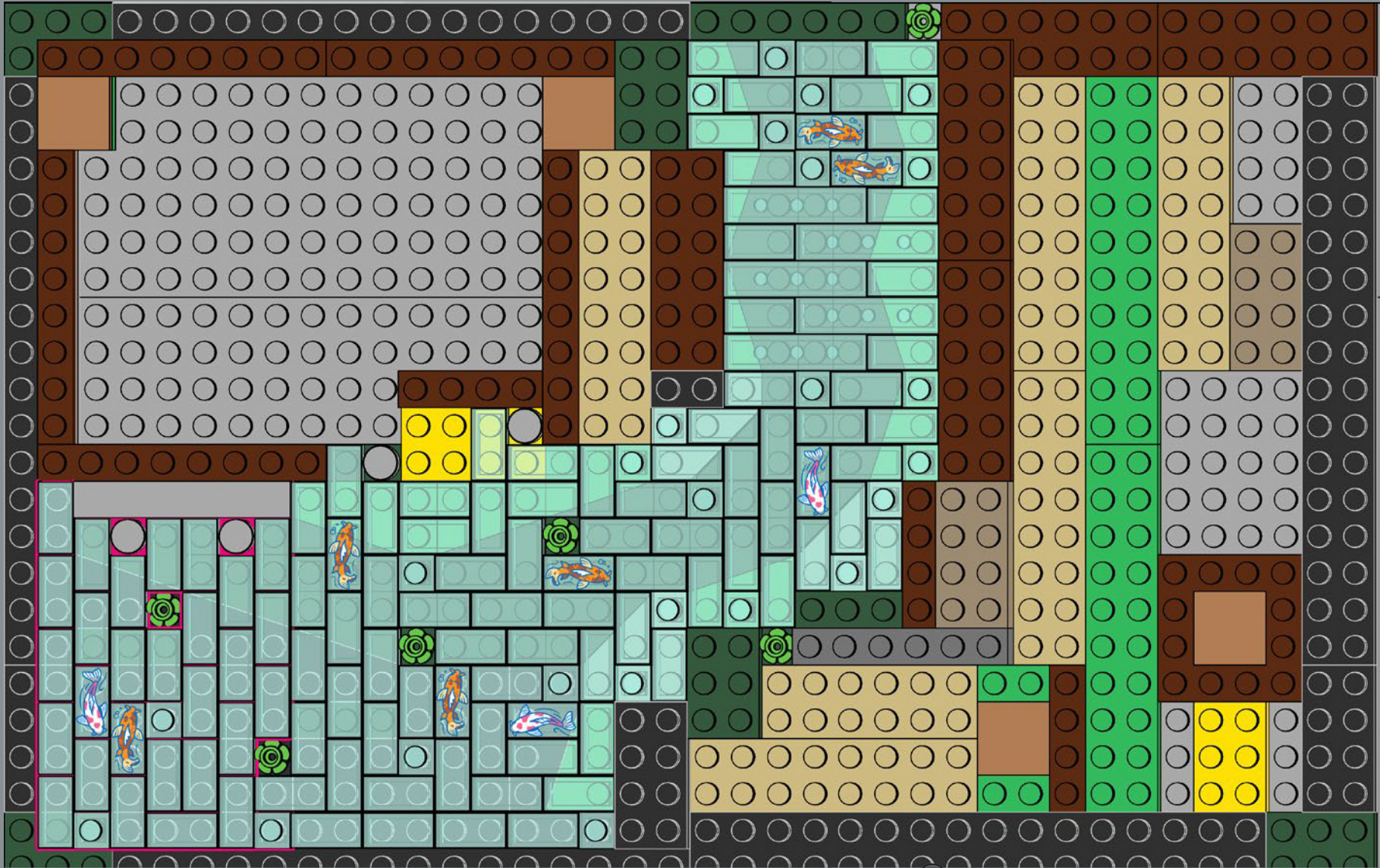



Con frecuencia, las formas de los estanques representan *kanjis* (caracteres de un sistema de escritura japonés) con significados trascendentes, como el de la palabra *kokoro*, que quiere decir "corazón".

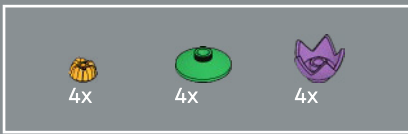

68

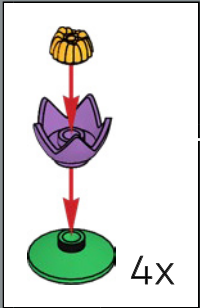

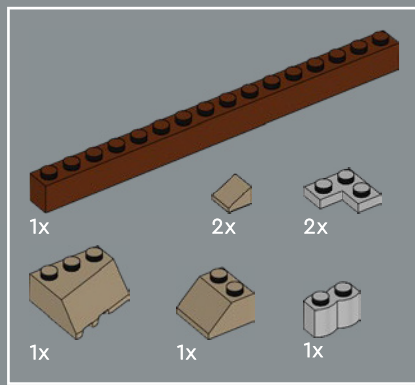

69



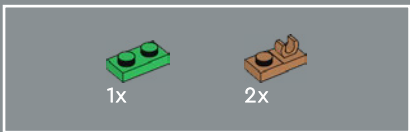

70



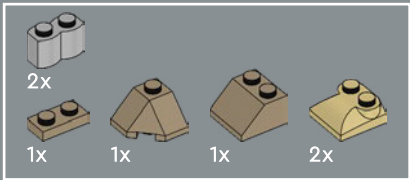

71

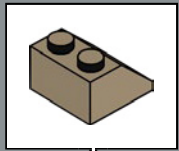
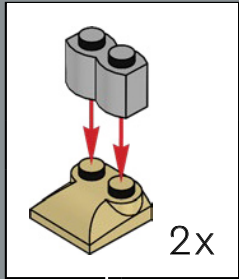

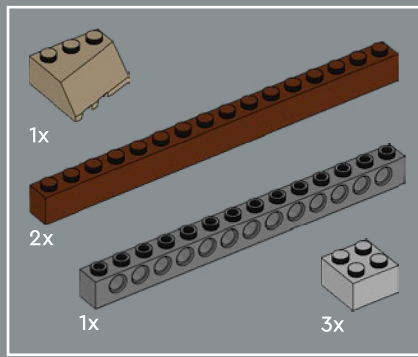

72



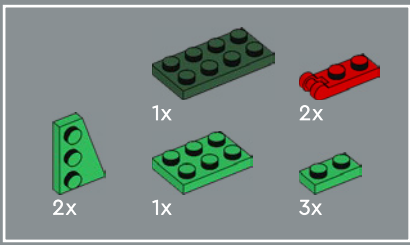

73

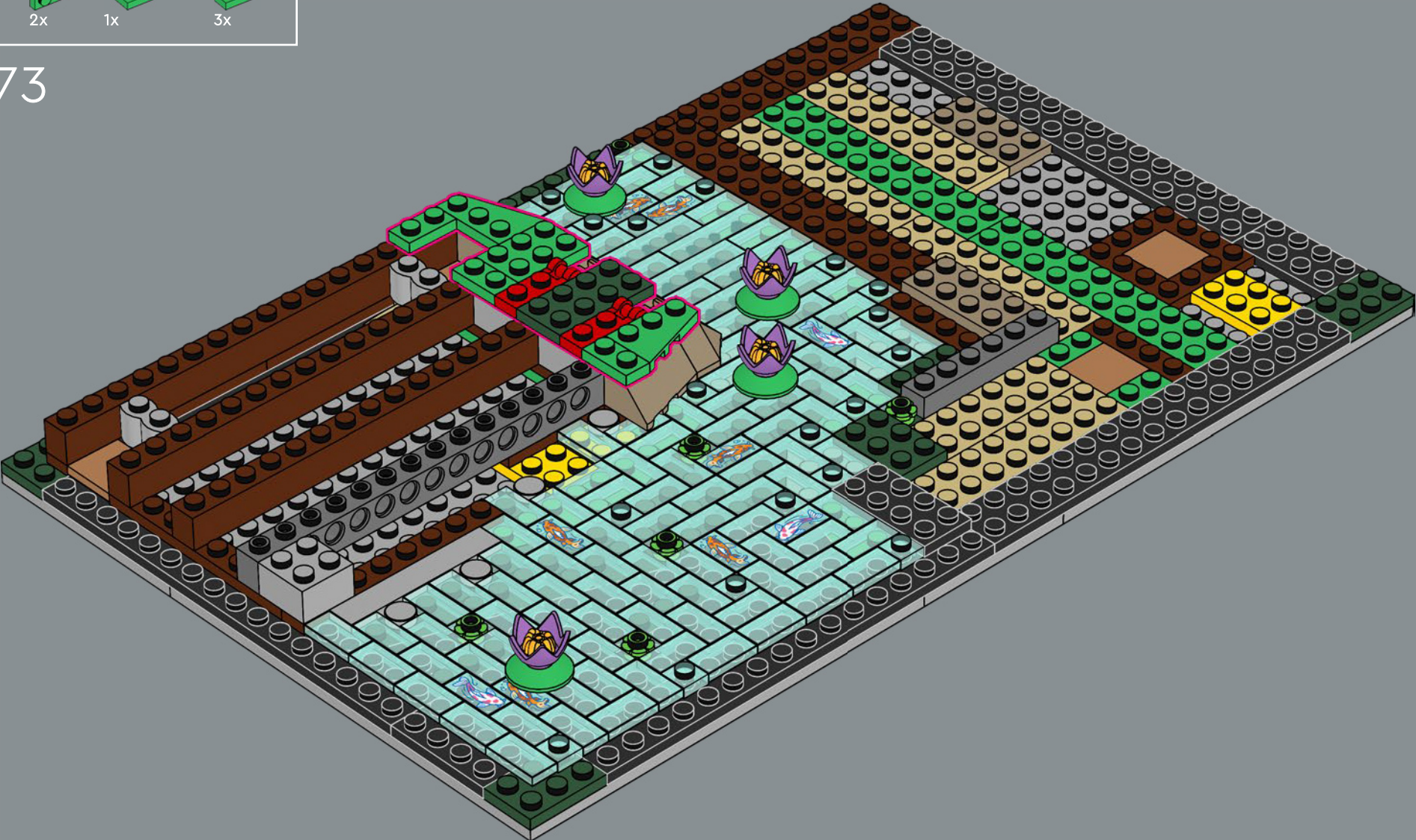

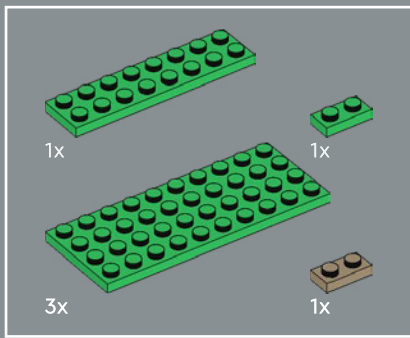

74



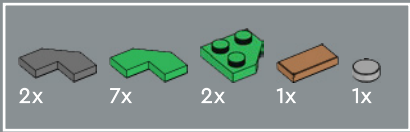

75



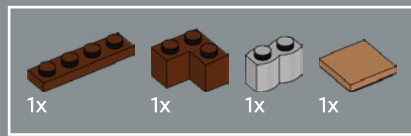

76



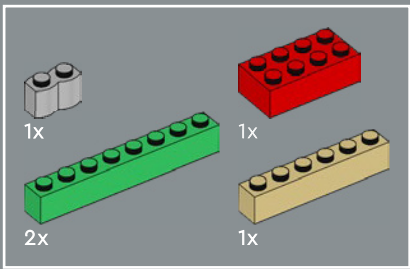

77



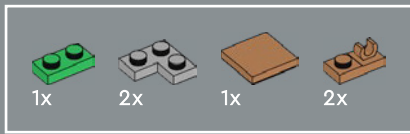

78

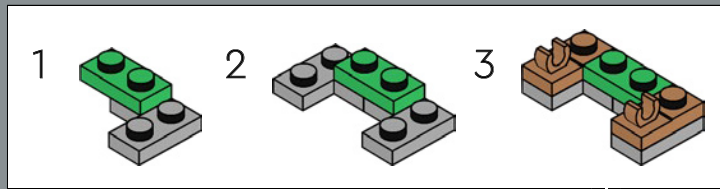

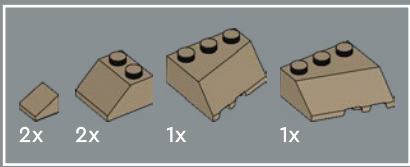

79

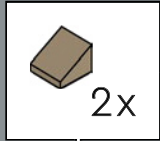

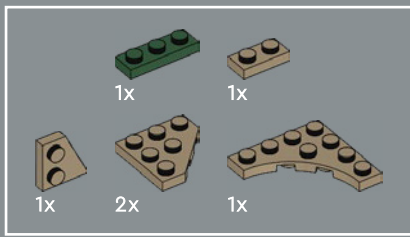

80



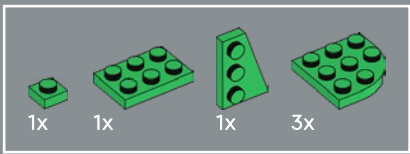

81



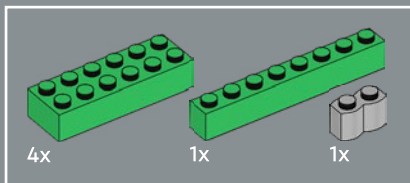

82



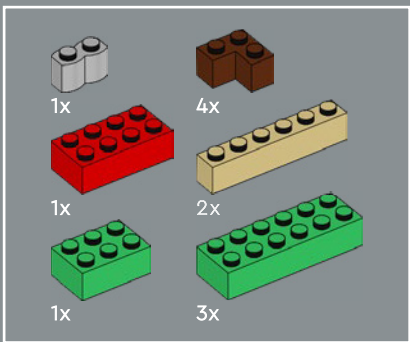

83



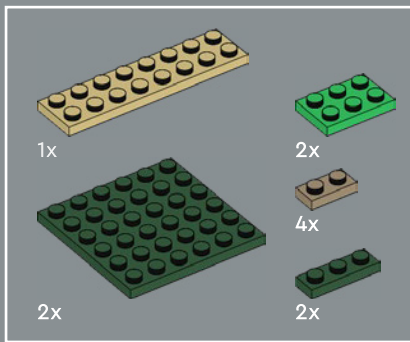

84



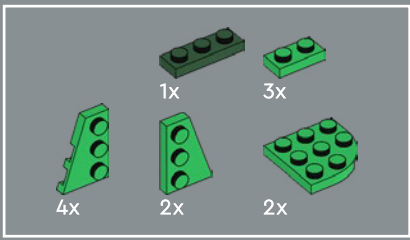

85



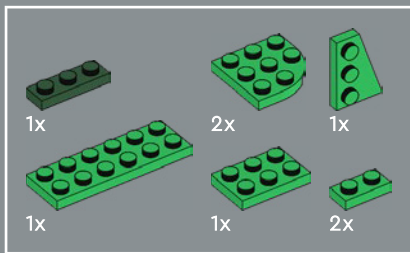

86



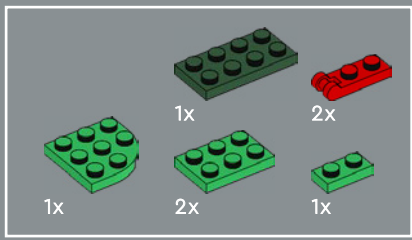

87



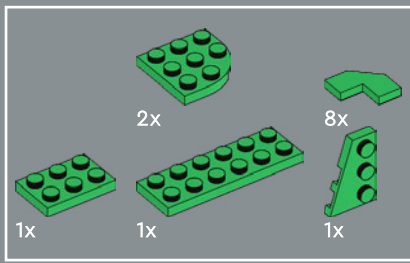

88





Las islas de los jardines meditativos pueden ser símbolos de montañas, tortugas o grullas (a menudo asociadas con la longevidad) místicas o de la mitología.

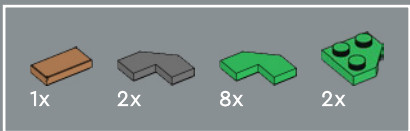

89



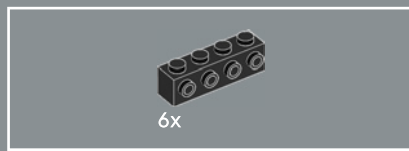

90



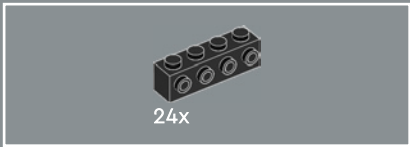

91



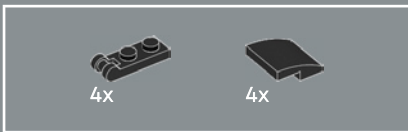

92

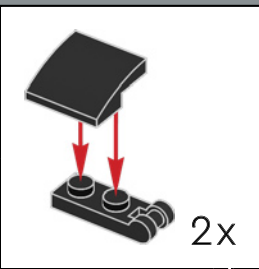
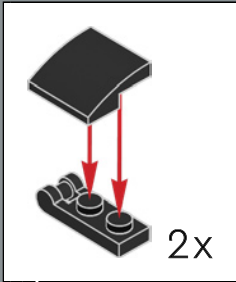

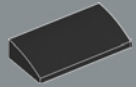

26x

93



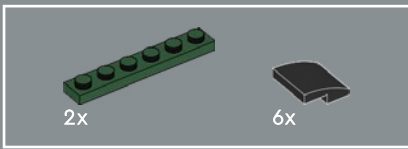

94

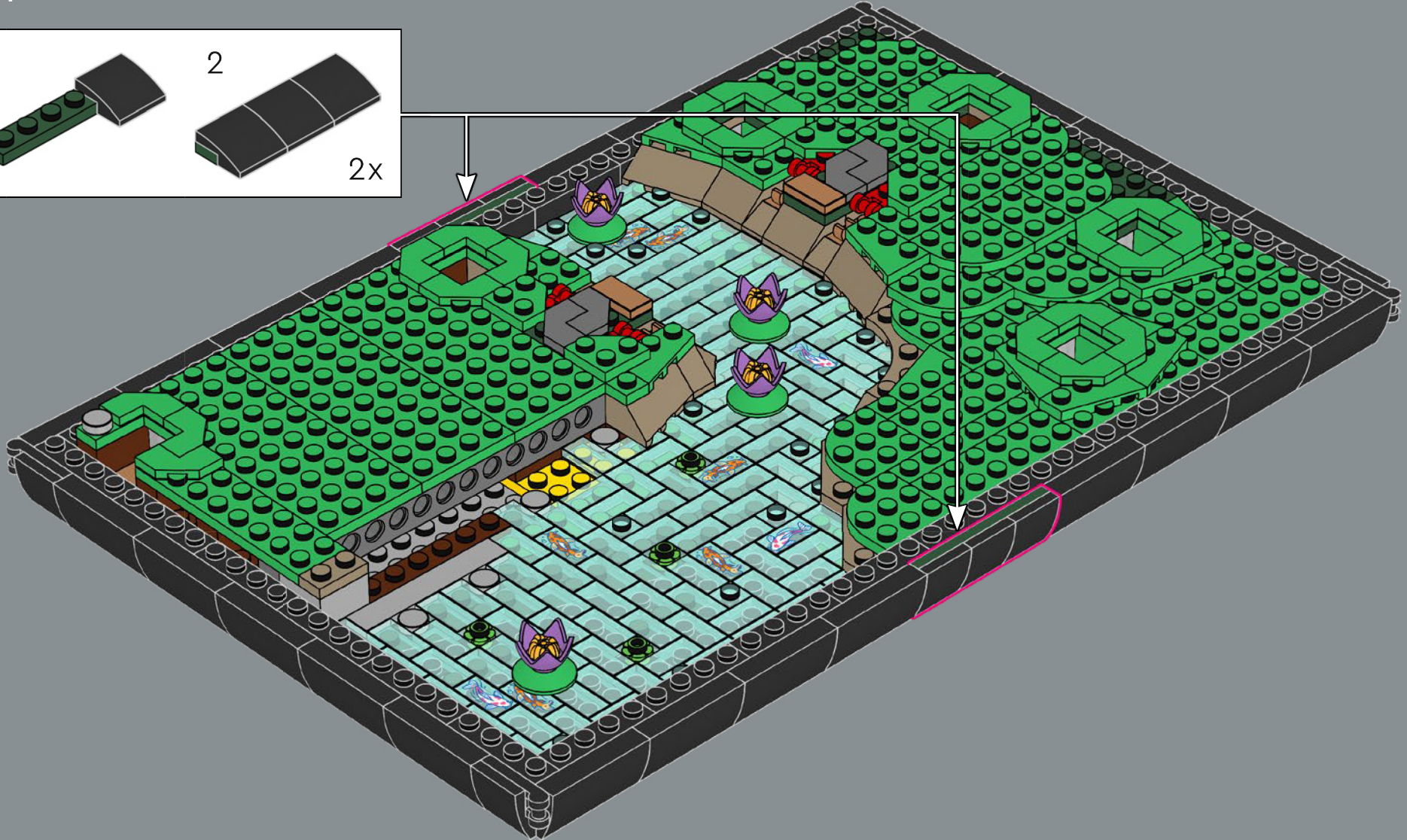
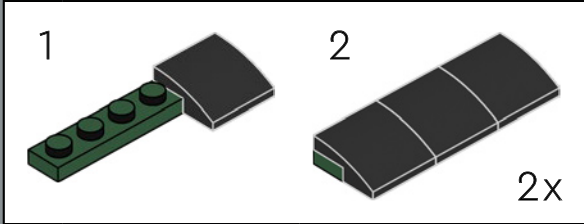

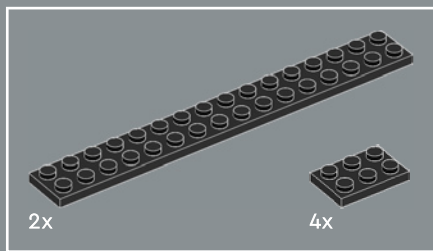

95



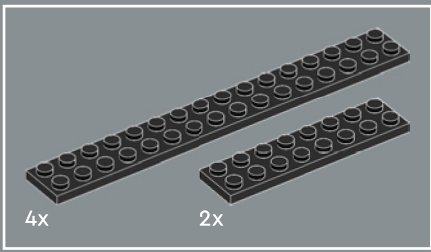

96



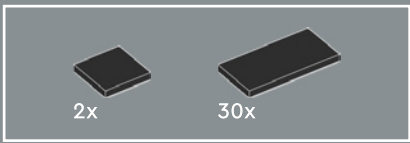

¿Reconoces el diseño de la base de este modelo?
Reutilizamos el diseño de la maceta del set
LEGO® Icons Bonsái (10281) para emular su
aparición y la sensación que inspira.

97

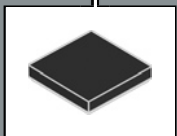
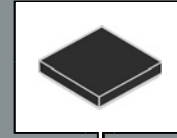

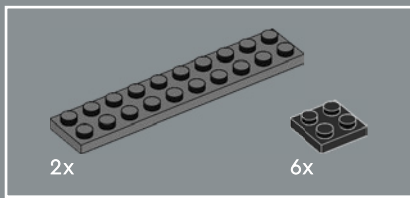

98

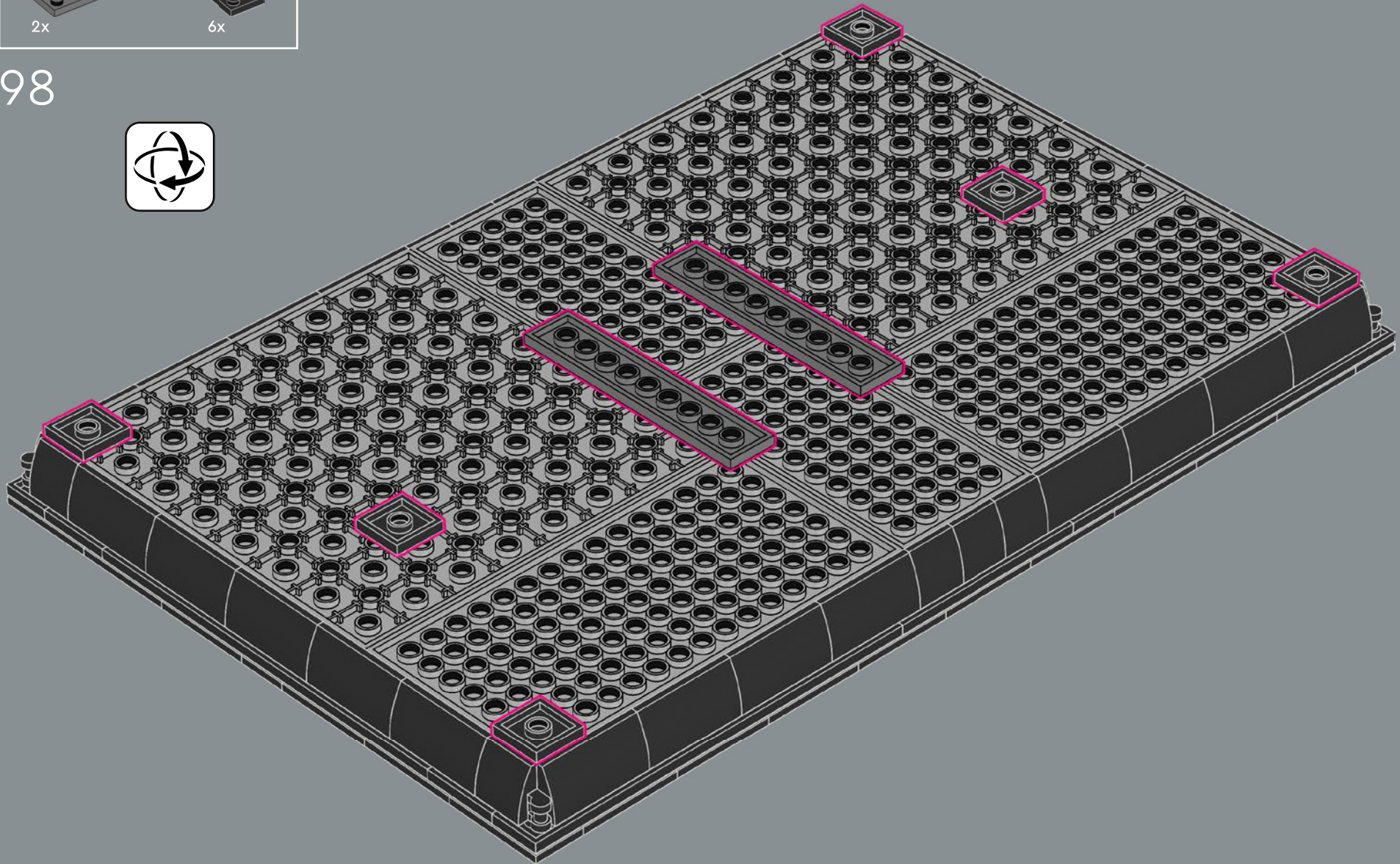



99

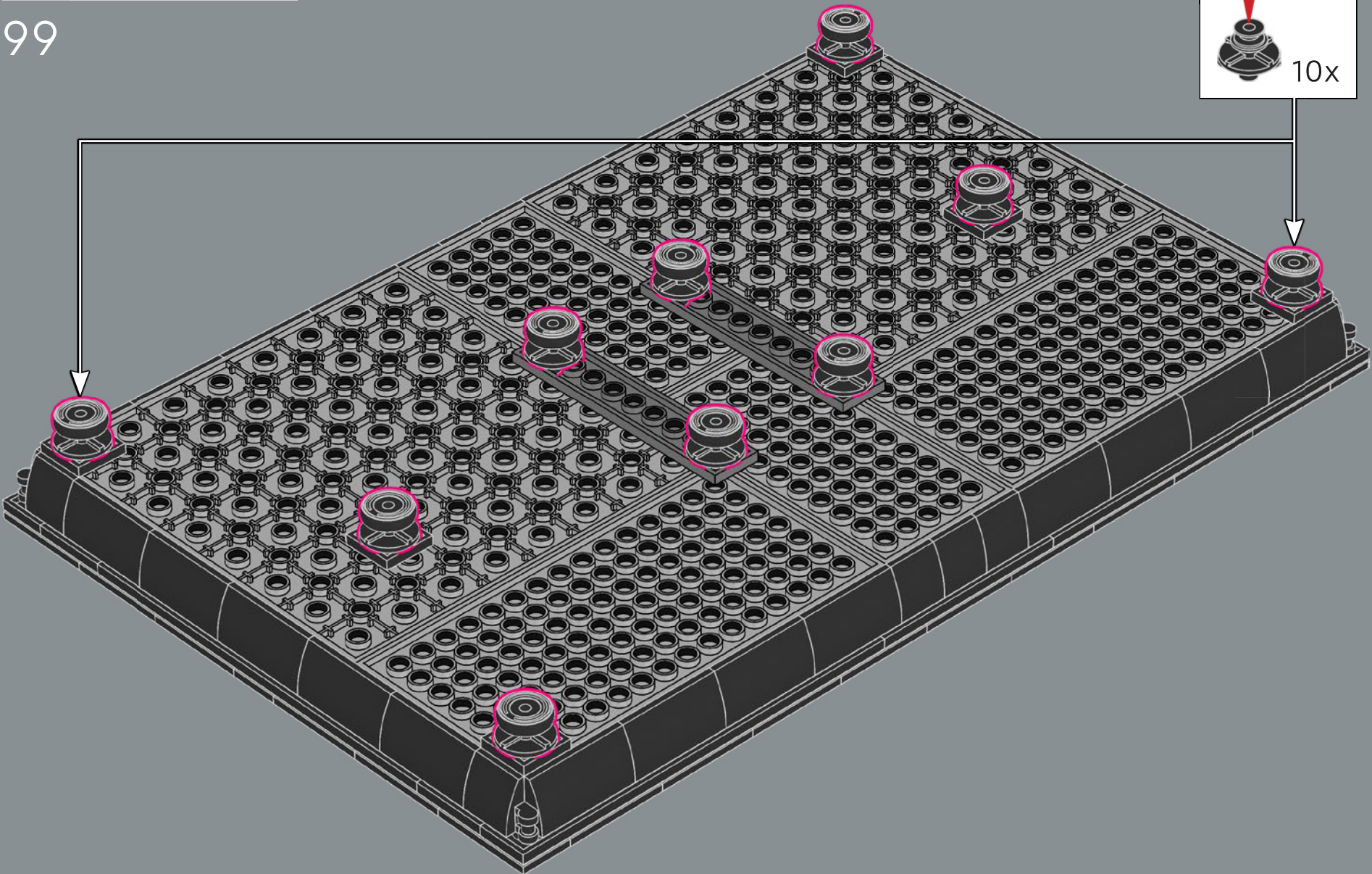
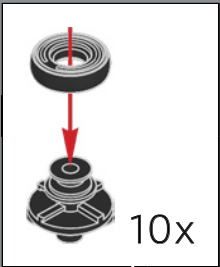



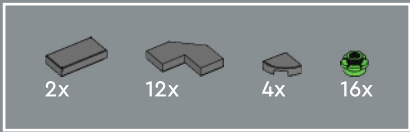

100

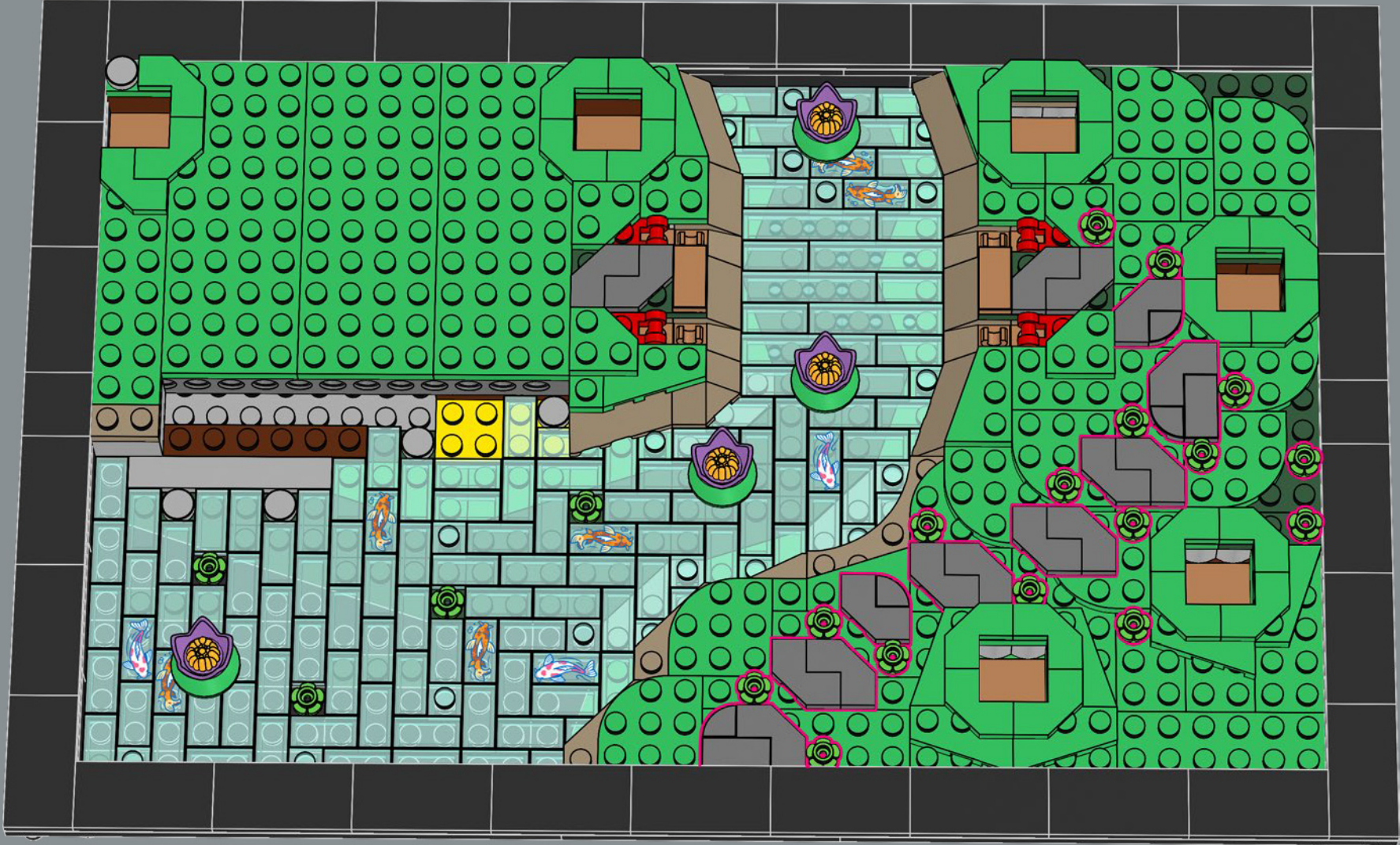

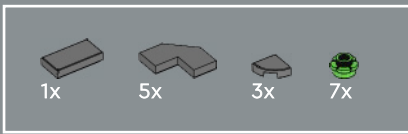

Los sinuosos senderos te invitan a mirar el jardín
(y quizá otras cosas) desde distintas perspectivas.

101

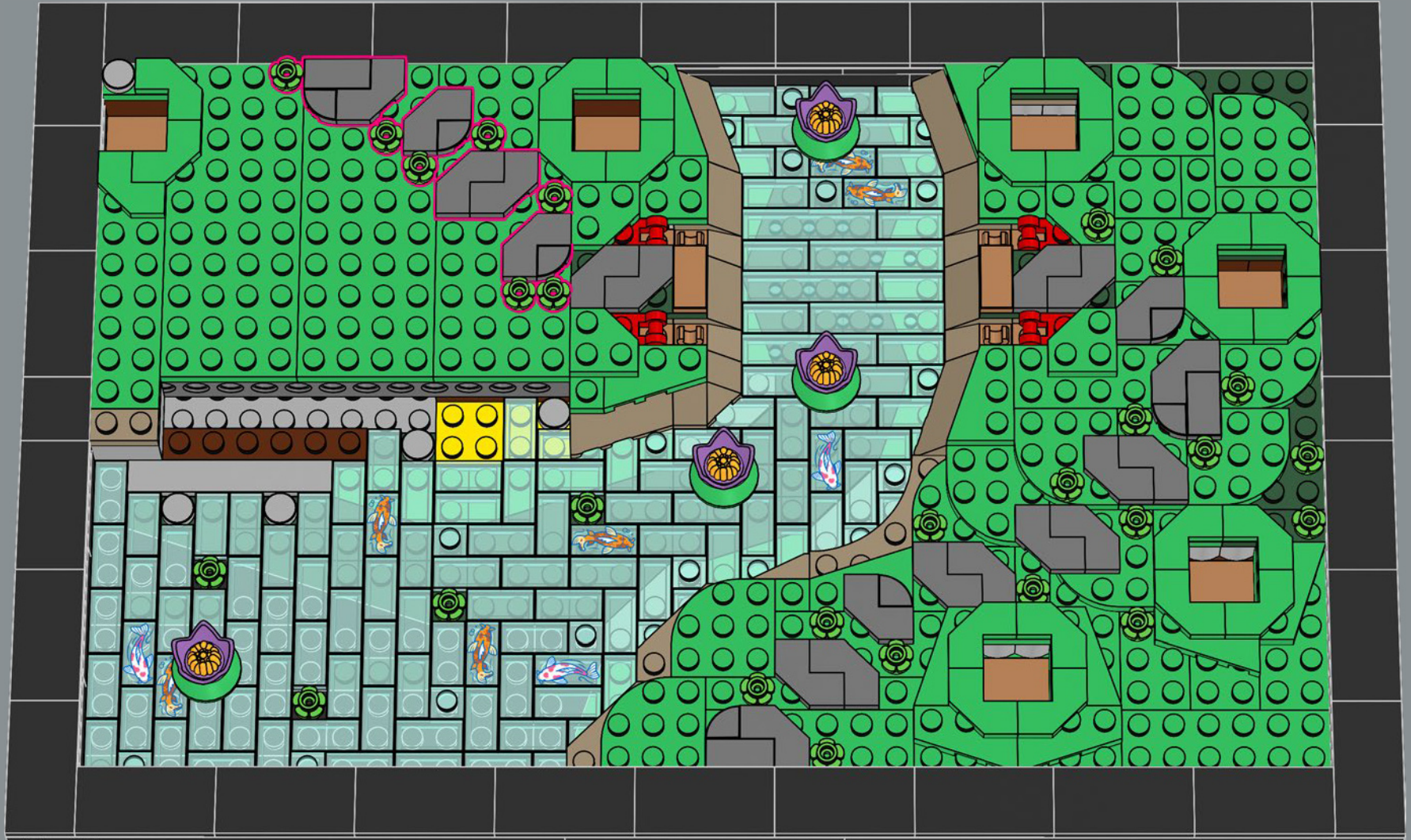

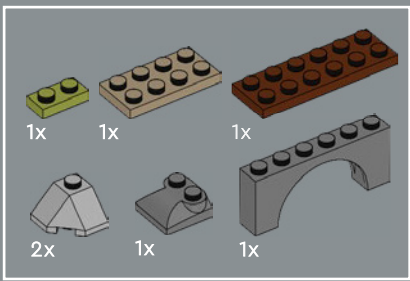

102

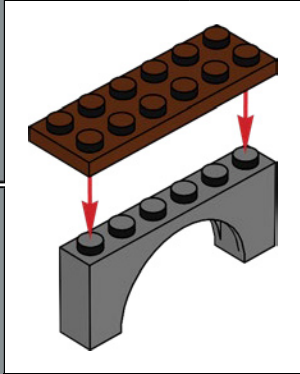

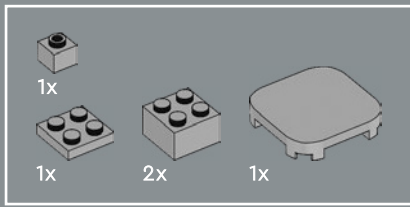

103

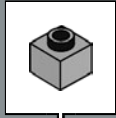

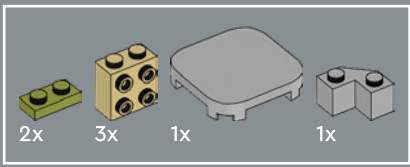

104

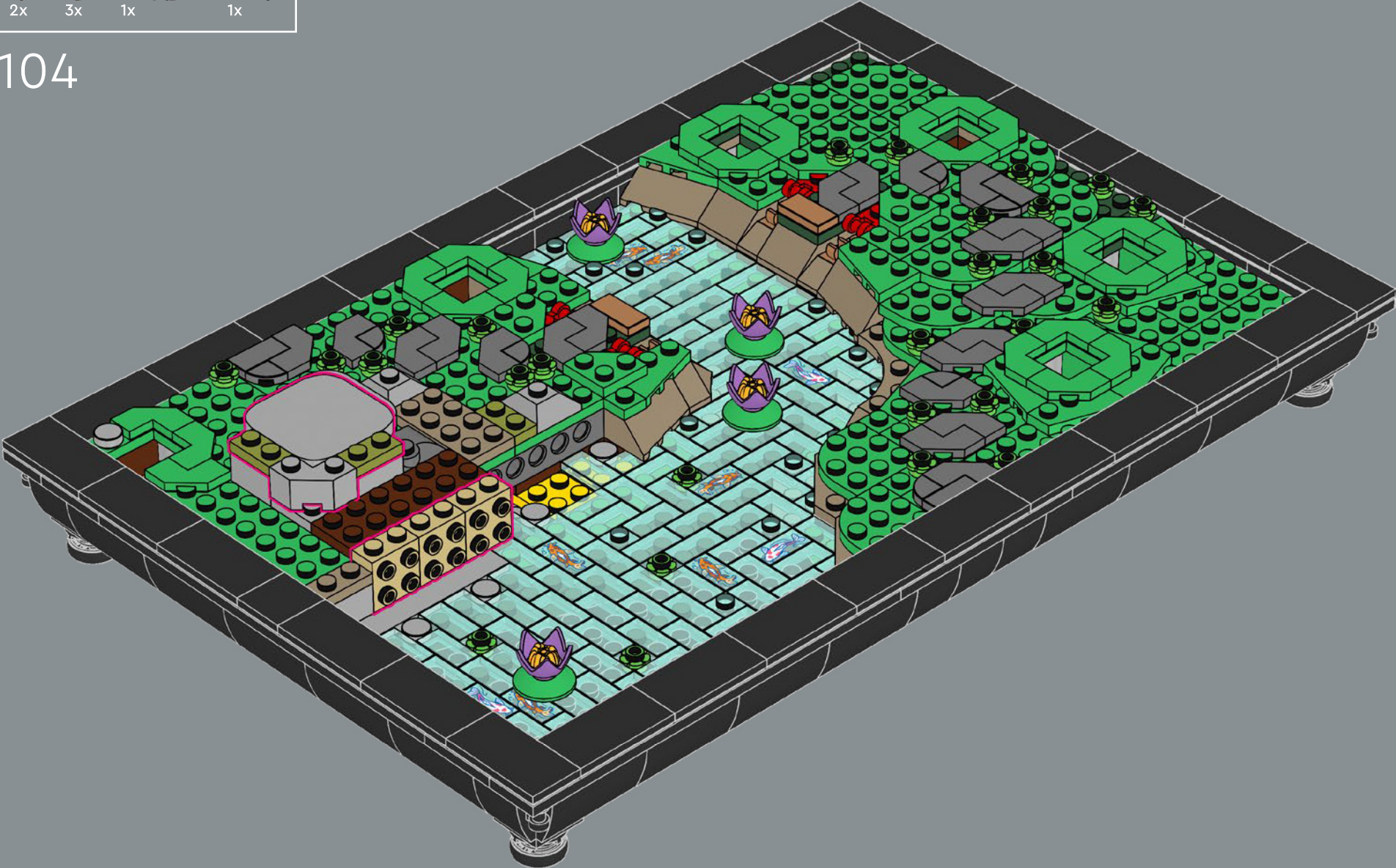

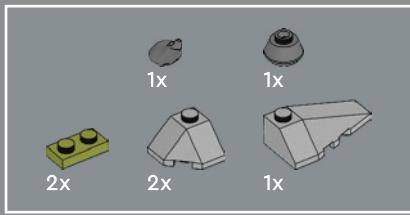

105

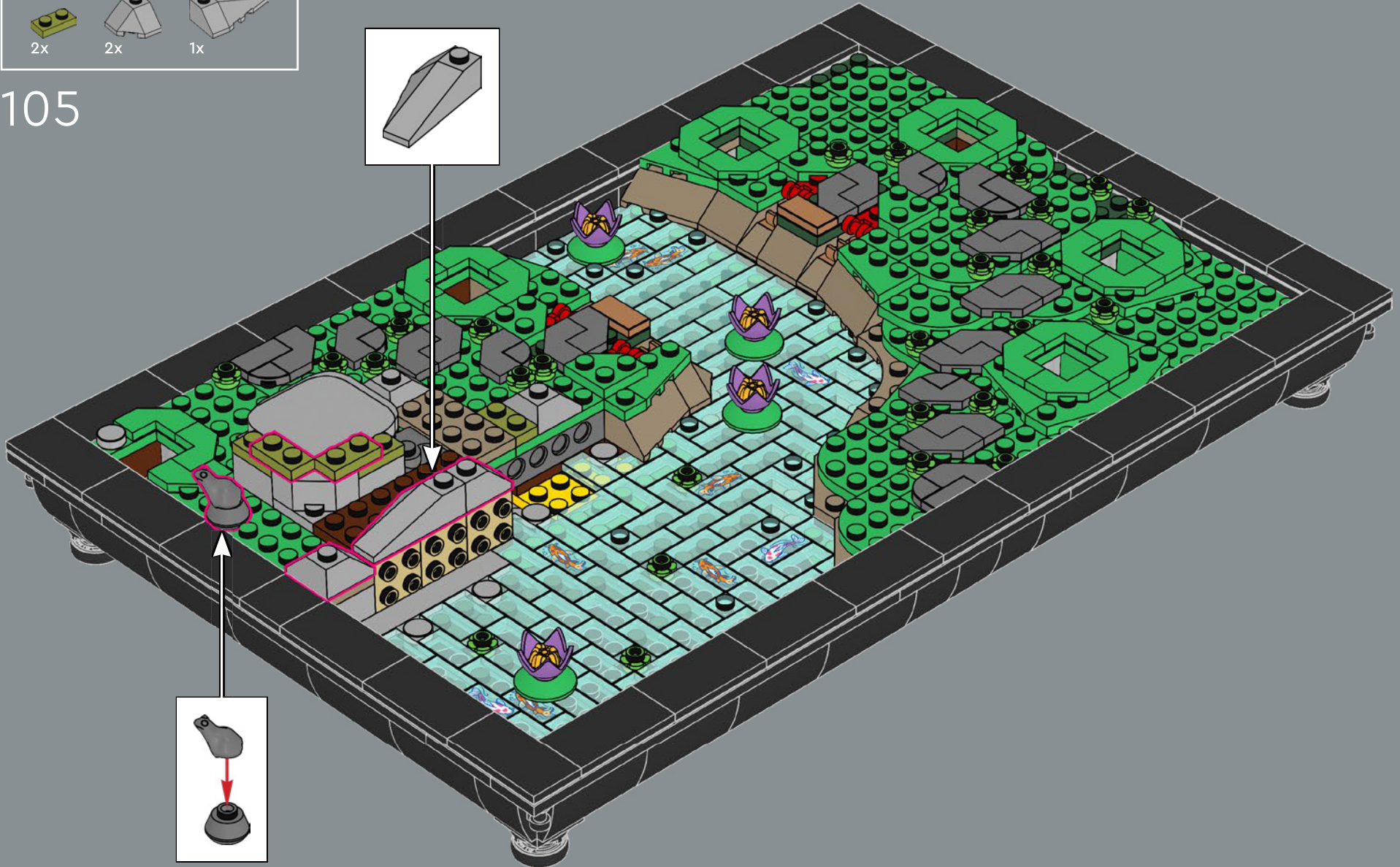
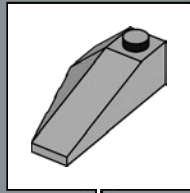

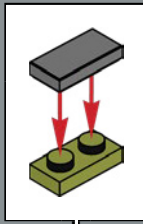
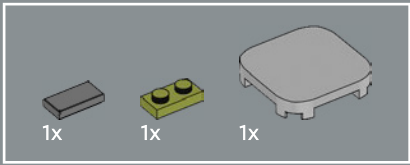

106



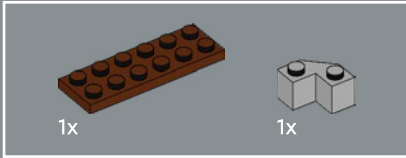
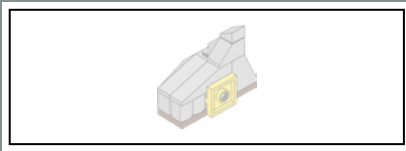

107

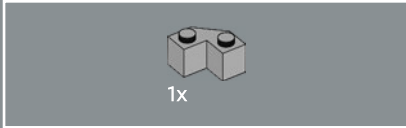
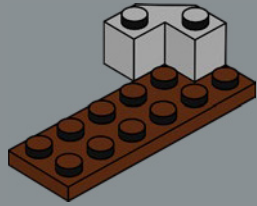

108

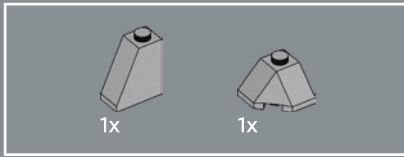
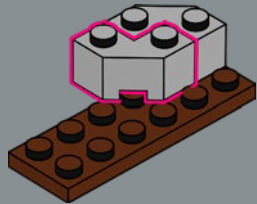

109

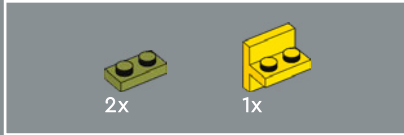
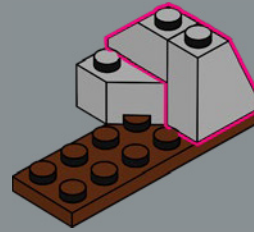

110

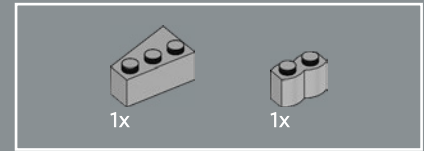
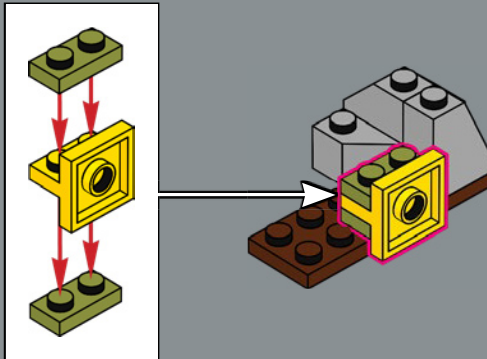

111

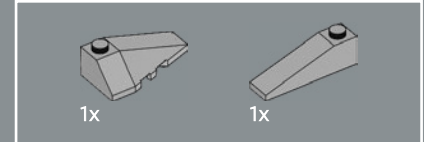
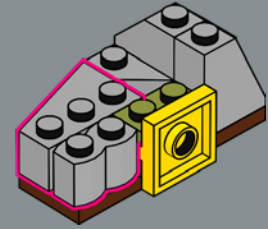

112

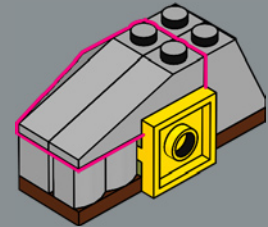

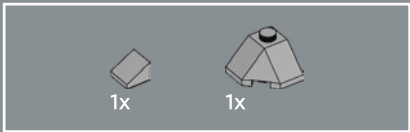

113

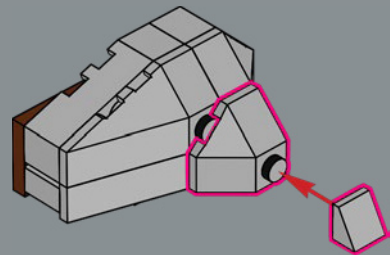

114



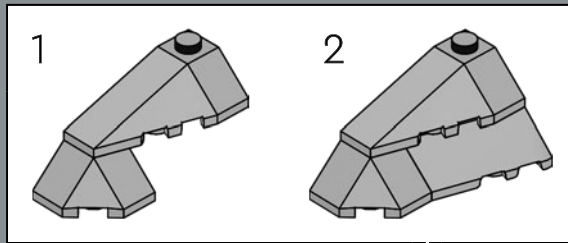
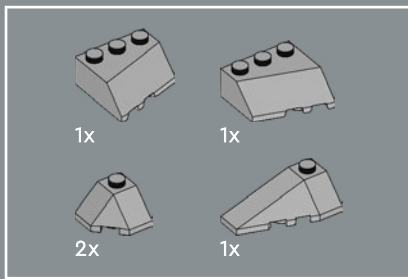

115

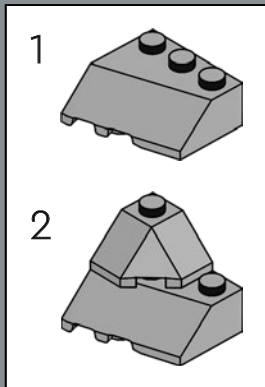

Las piedras, las rocas y la arena suelen conferir una significación más profunda a los espacios.

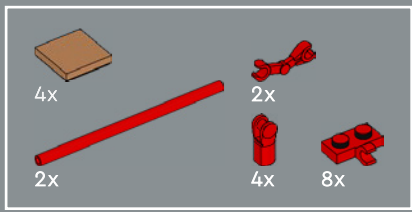

116

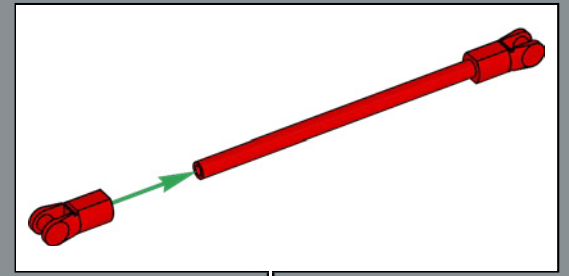
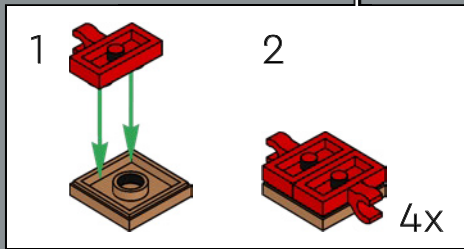
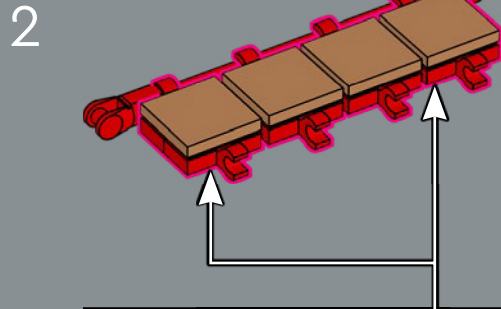
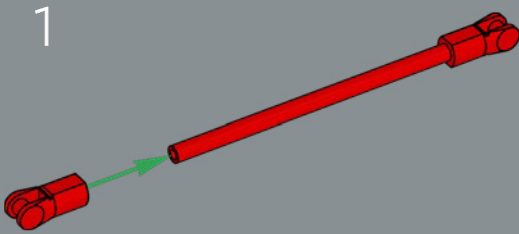

3

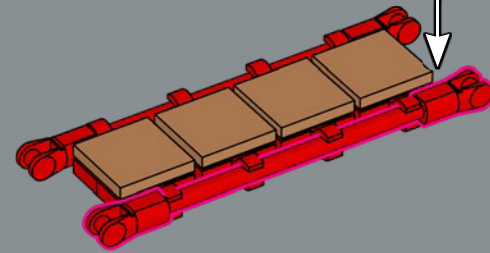

4

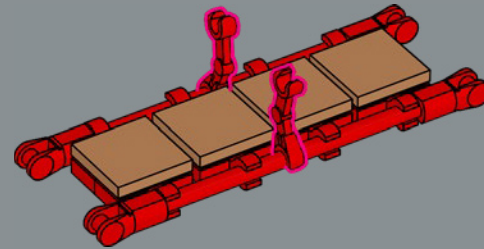

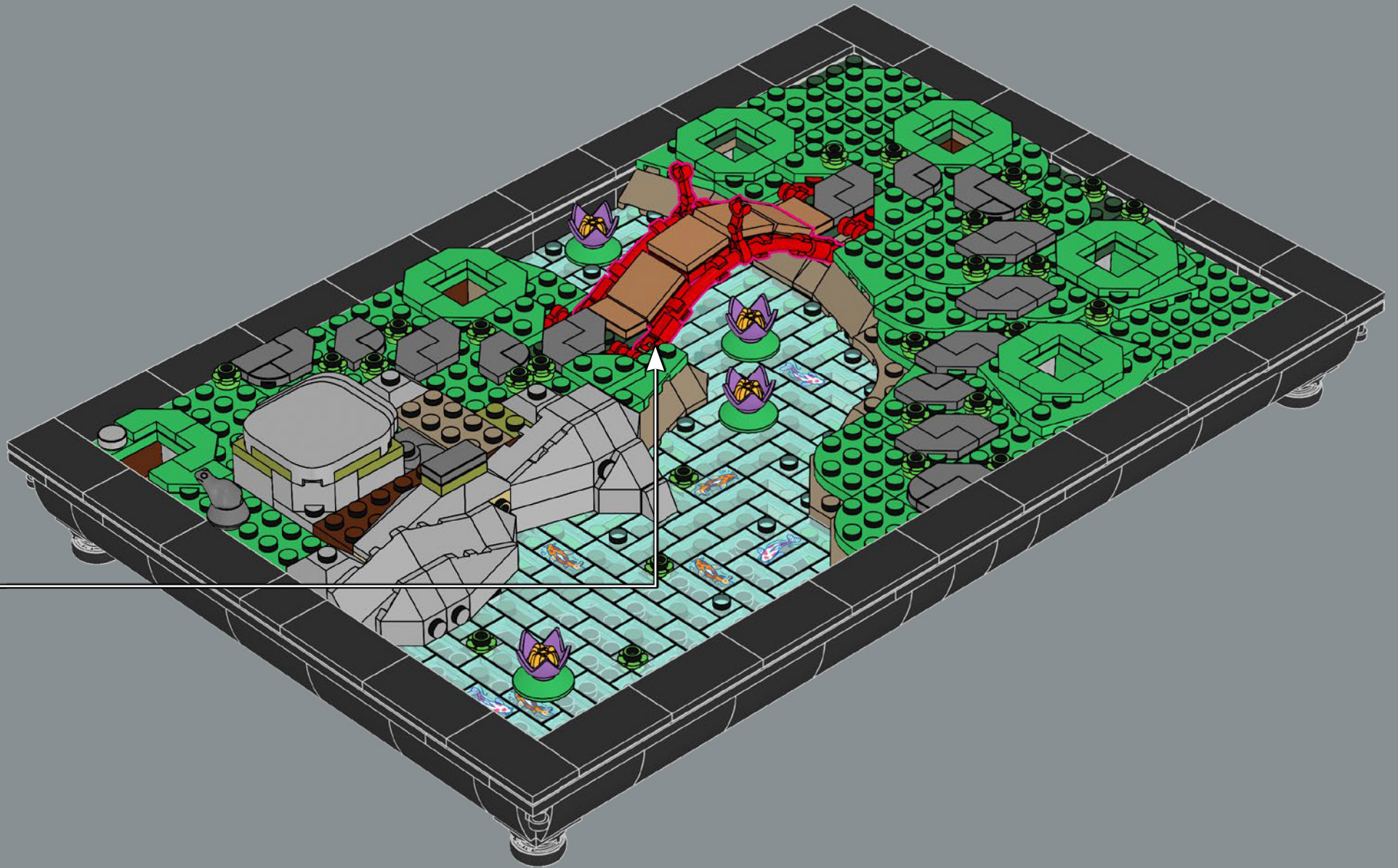

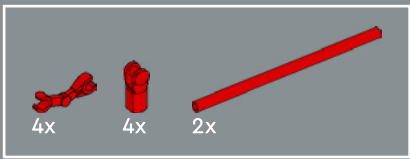

117

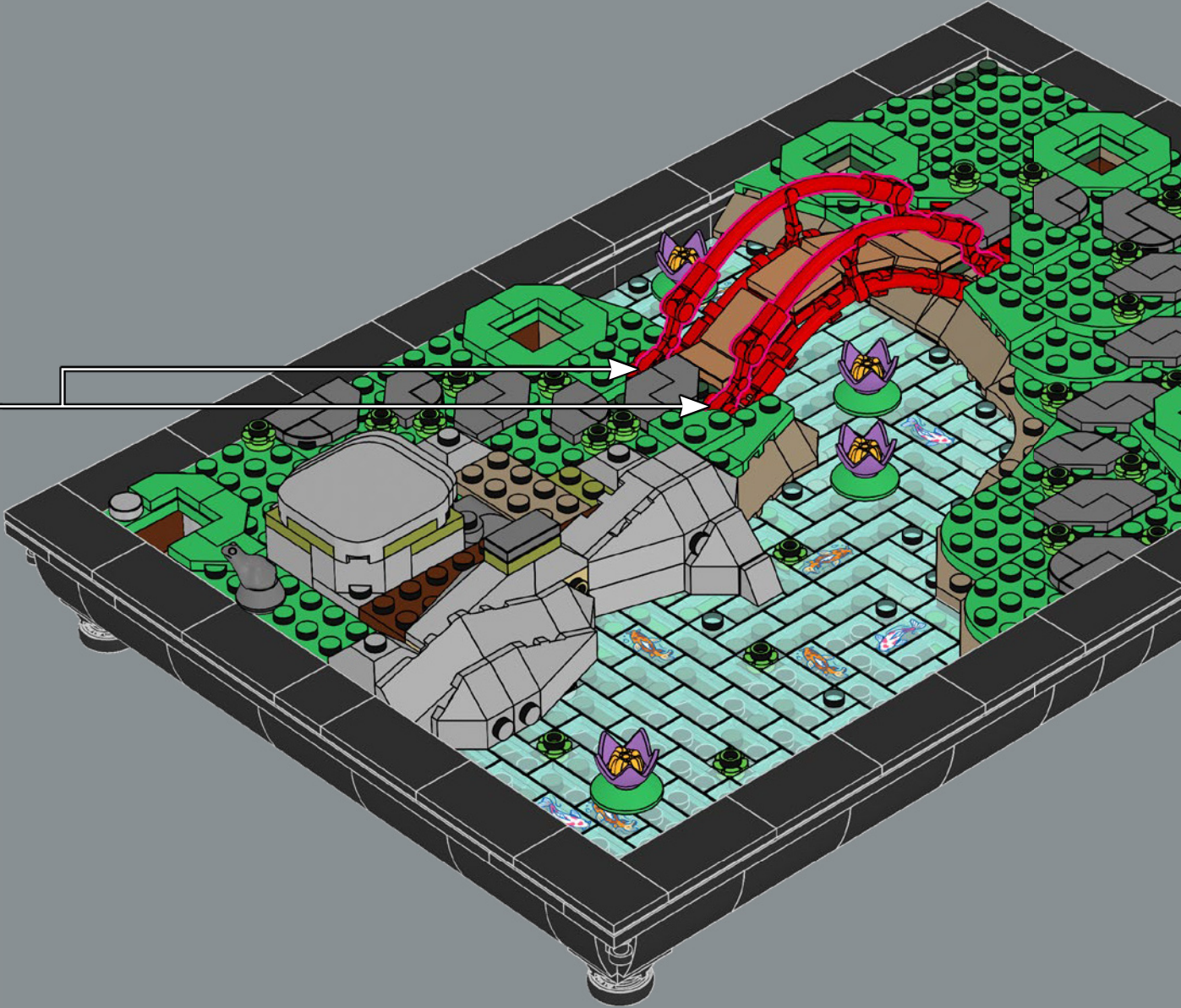
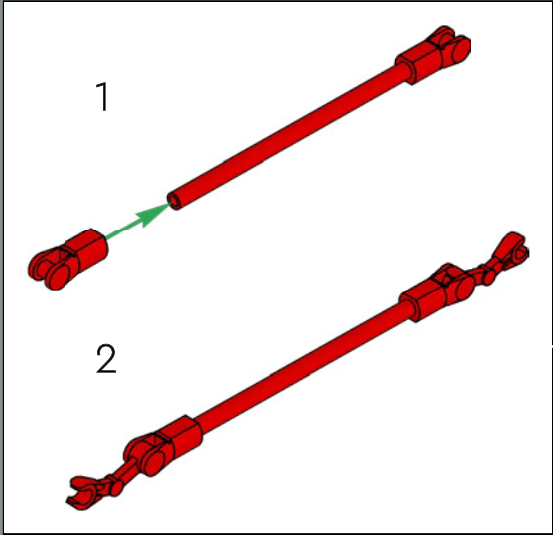



118

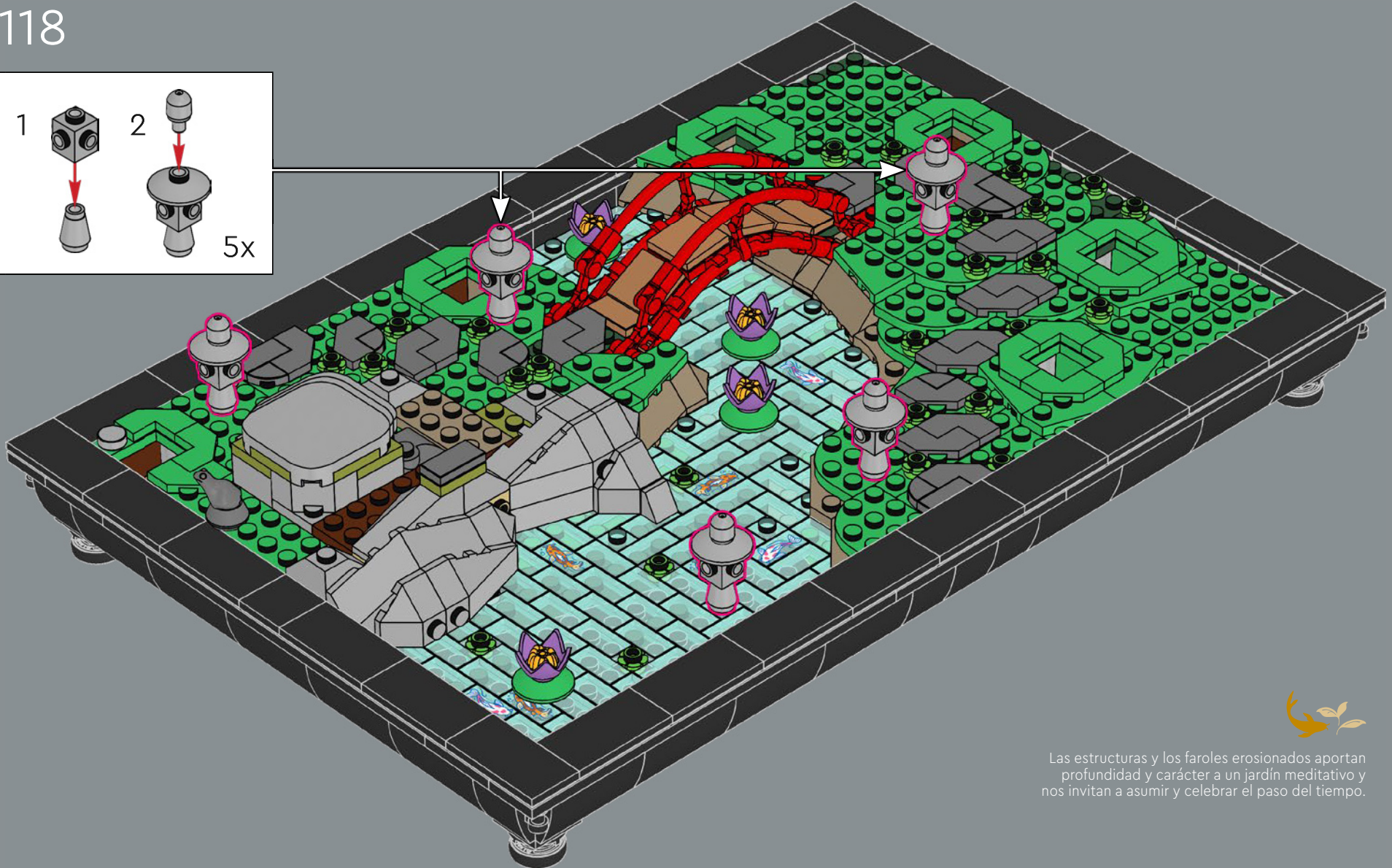
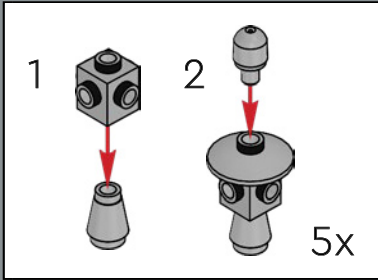

Las estructuras y los faroles erosionados aportan profundidad y carácter a un jardín meditativo y nos invitan a asumir y celebrar el paso del tiempo.

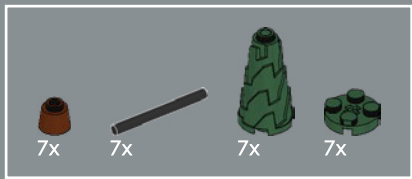

119

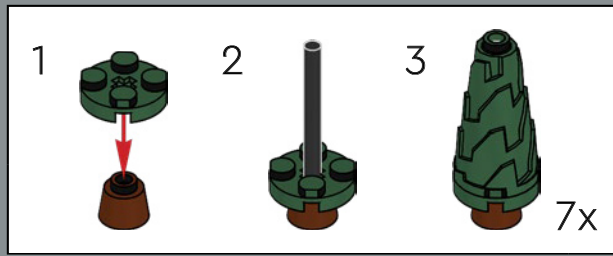

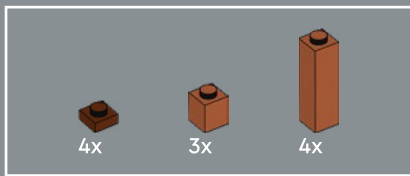

120

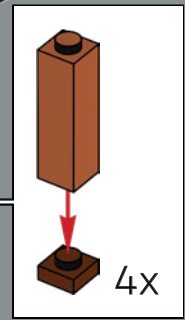
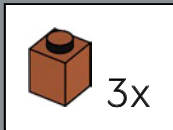

121



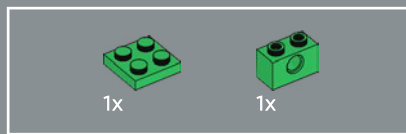
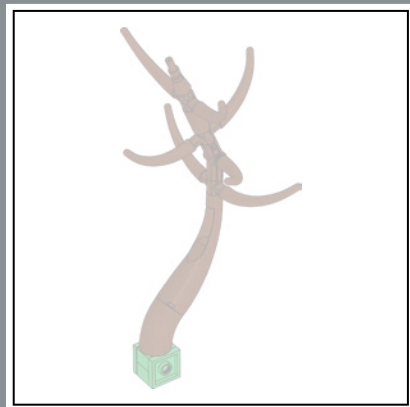

122

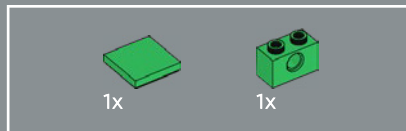
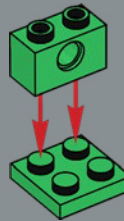

123

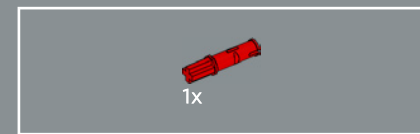
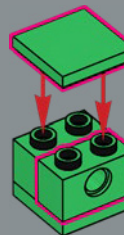

124

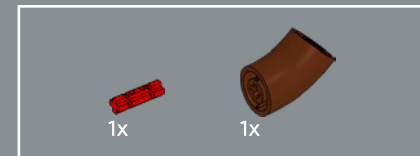
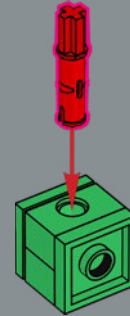

125

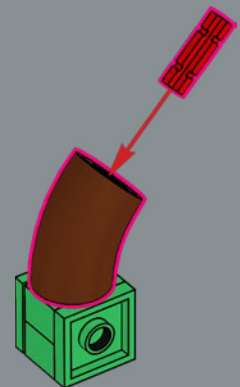

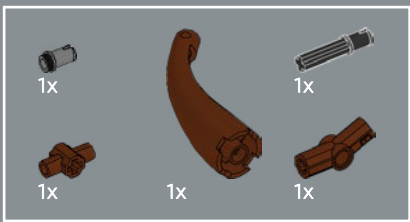

126

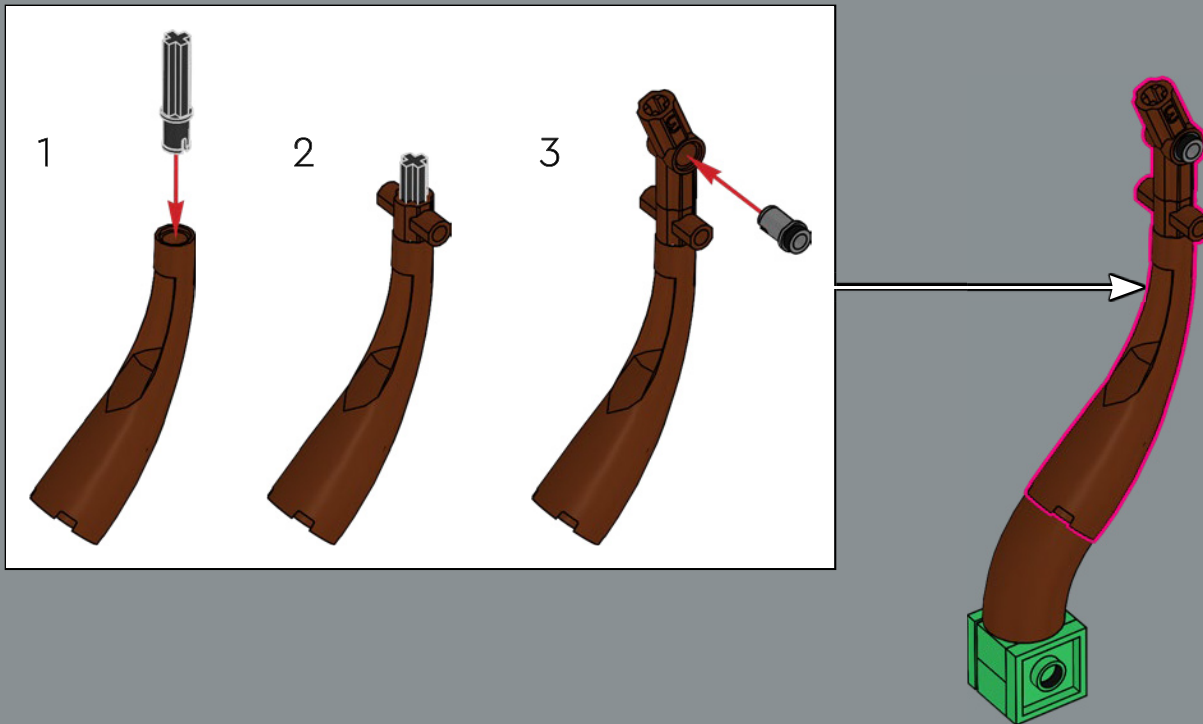

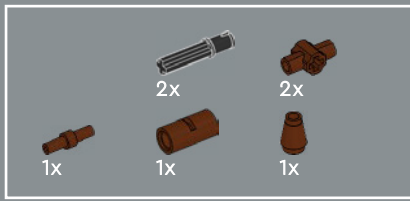

127

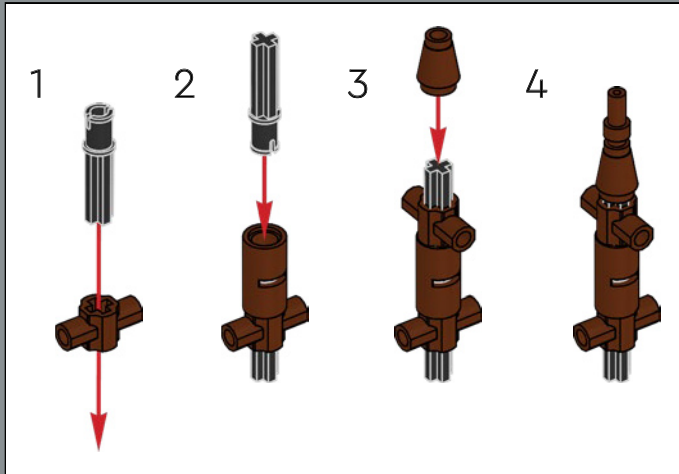

128





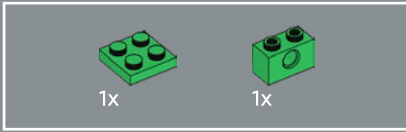
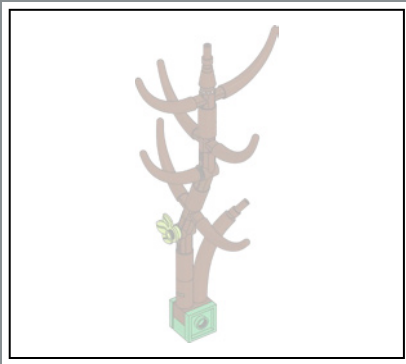

130

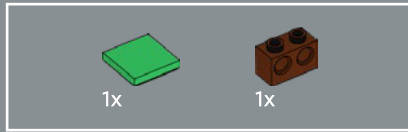
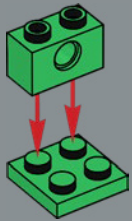

131

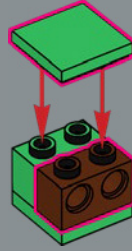

132

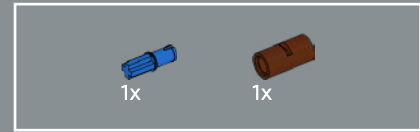

133

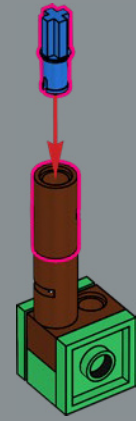

134

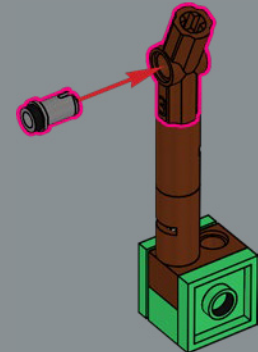

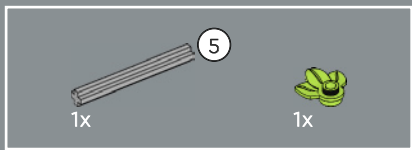

135

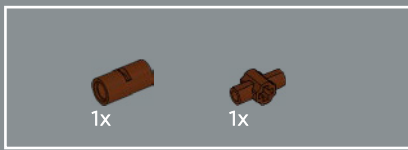
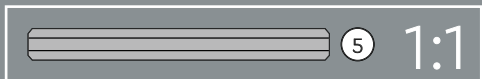

136

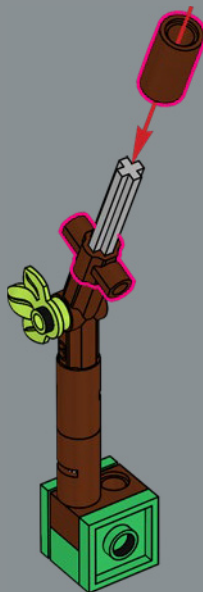

137



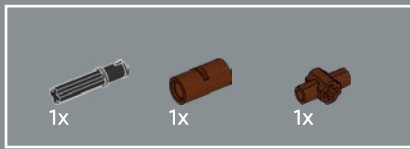

138

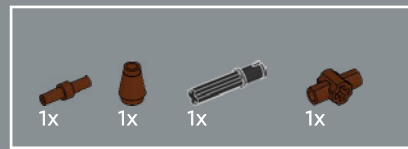
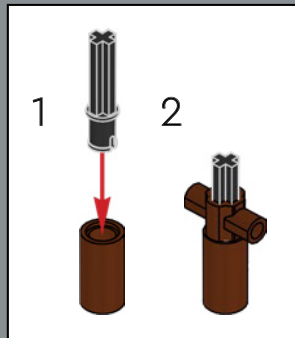

139

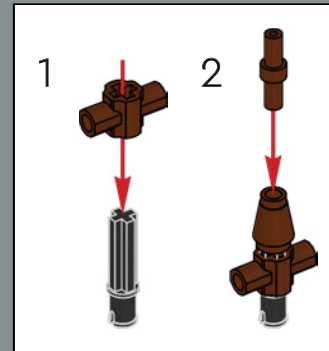

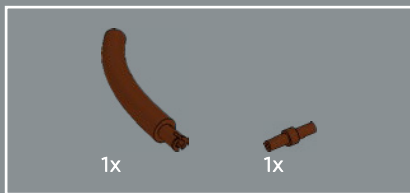

140

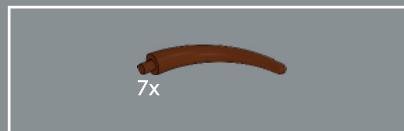
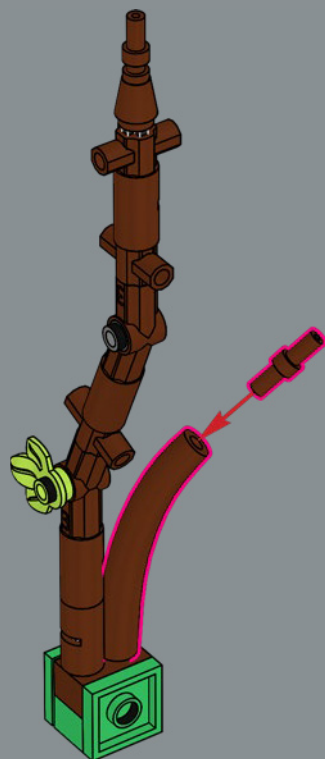

141

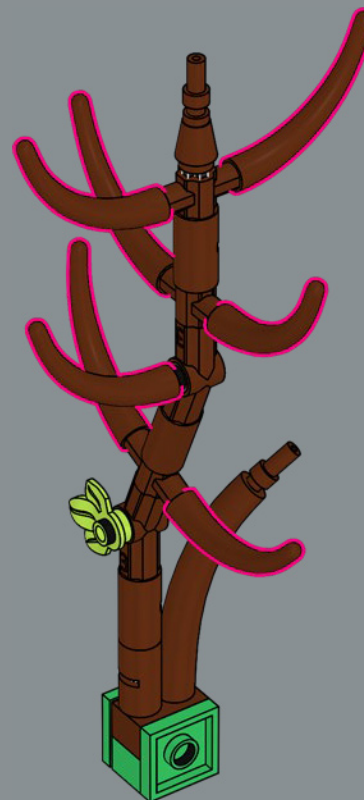

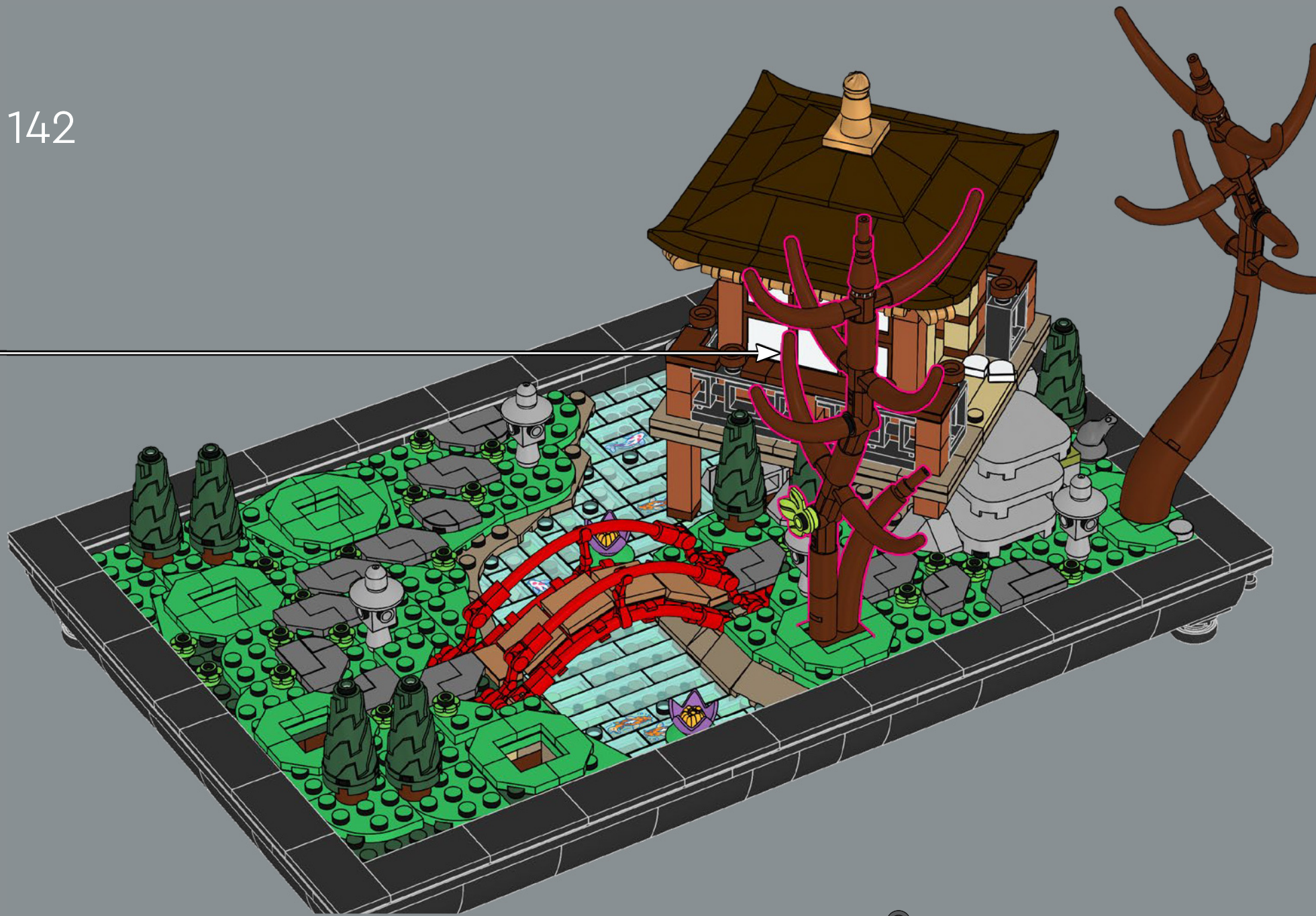

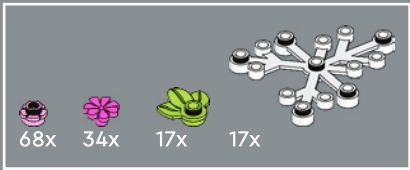

143

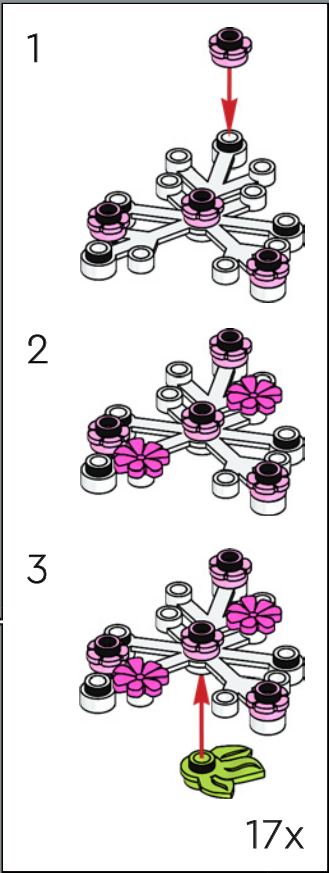

El equilibrio entre elementos como el agua, las plantas cuidadosamente seleccionadas y las rocas utilizadas de formas diversas crea un entorno sereno en tu jardín.

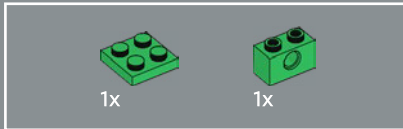
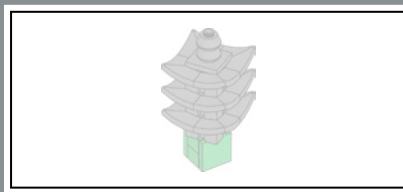

144

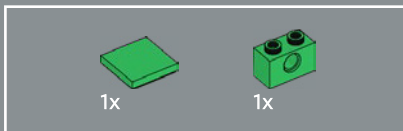
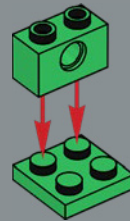

145

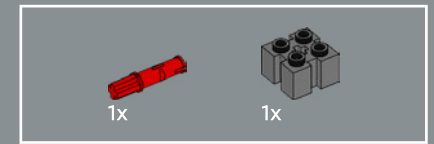
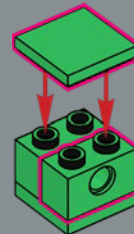

146

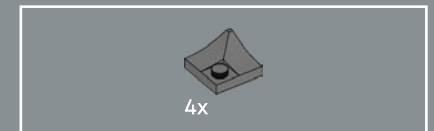
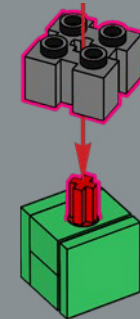

147

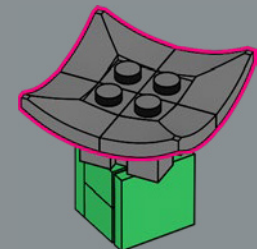

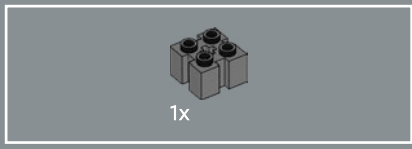

148

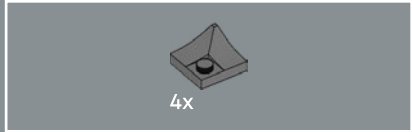
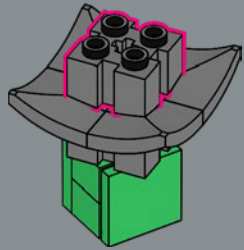

149

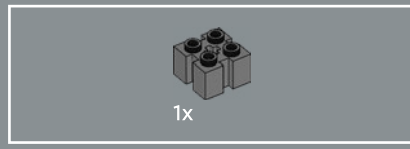
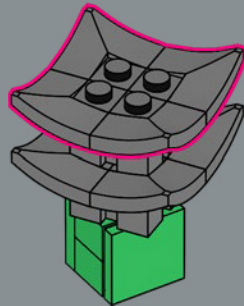

150

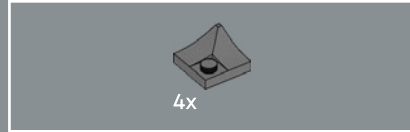
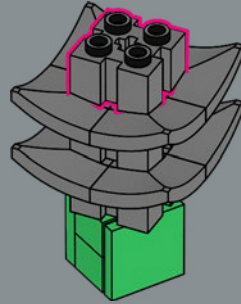

151

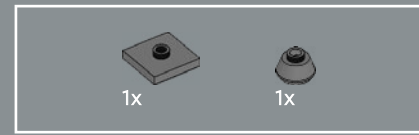
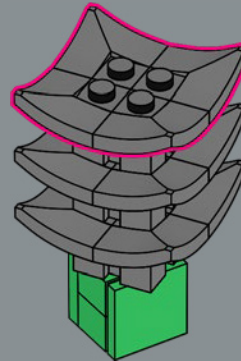

152

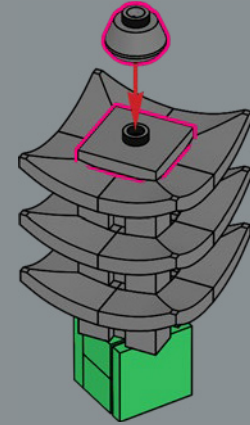

153

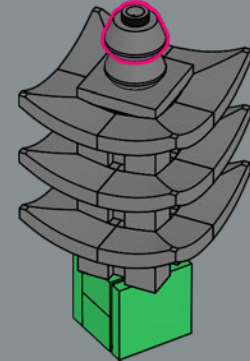

154

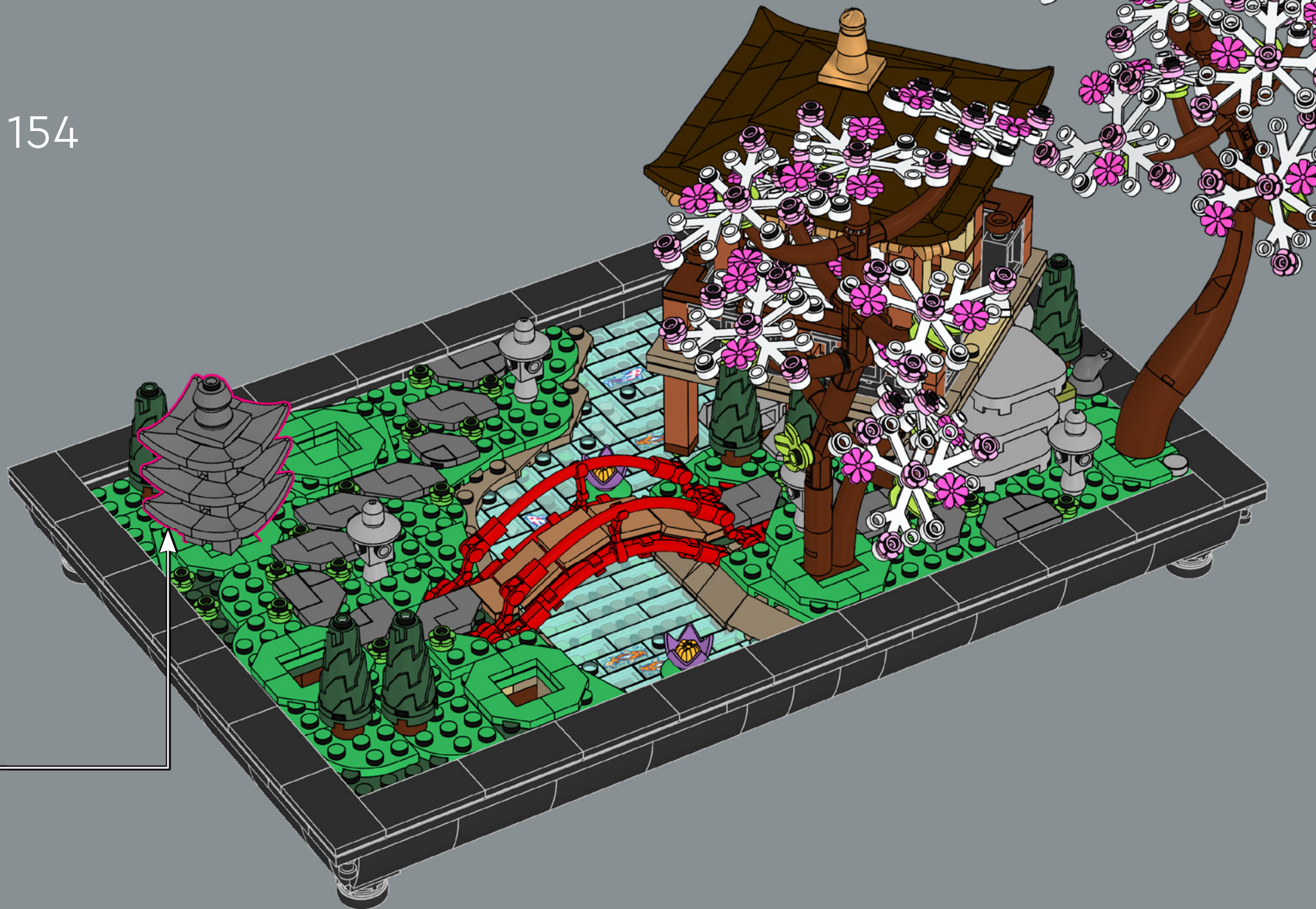

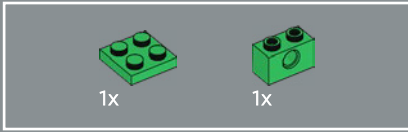
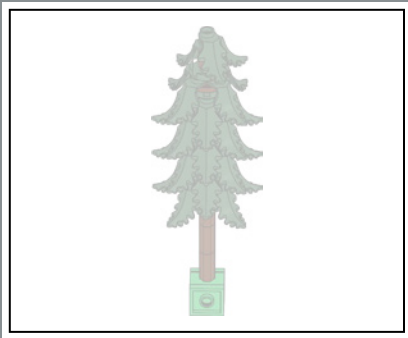

155

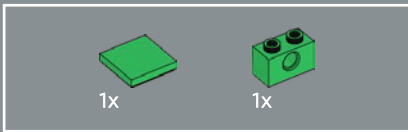
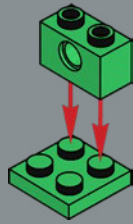

156

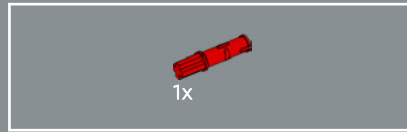
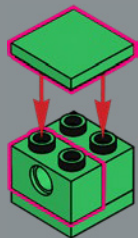

157

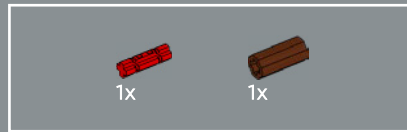
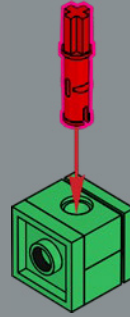

158

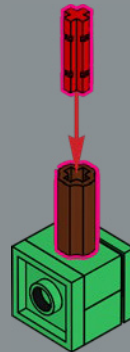

159

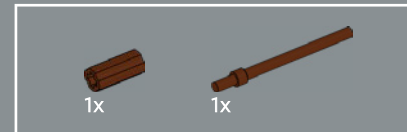
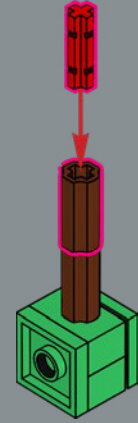

160

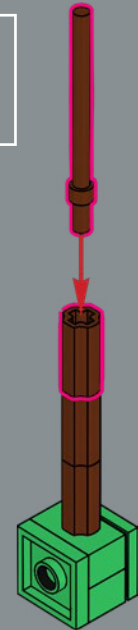



161

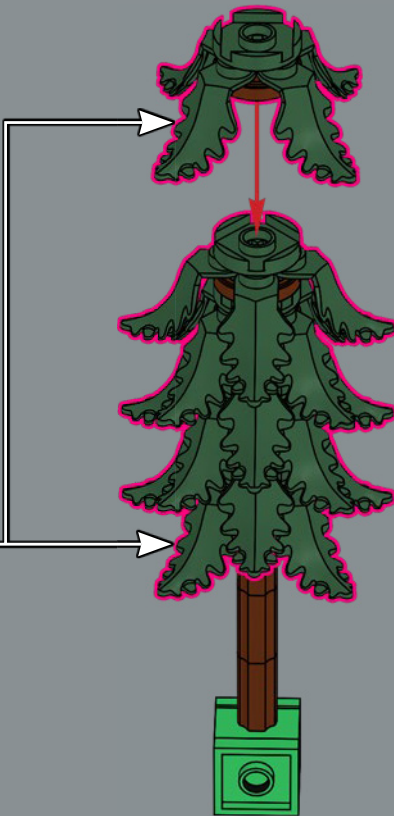

162

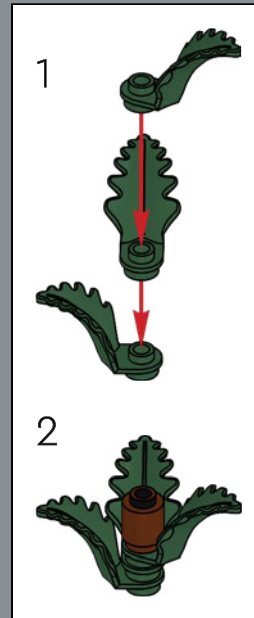



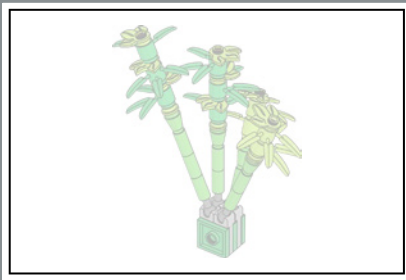

164

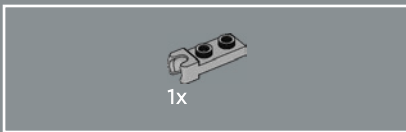
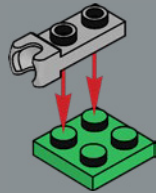

165

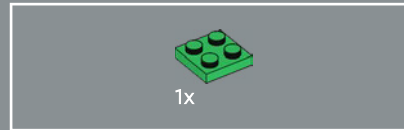
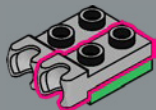

166

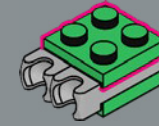

167

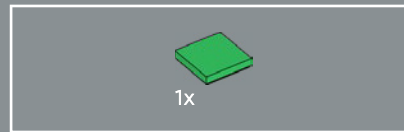
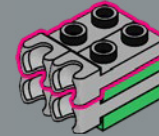

168

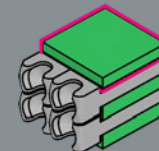



169

1



2



3

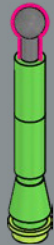

4



5

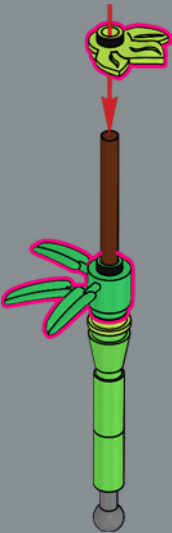

6

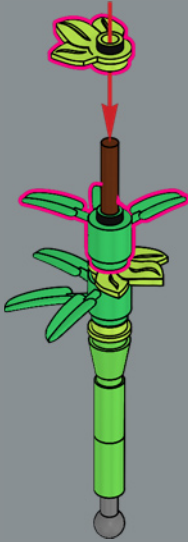

7

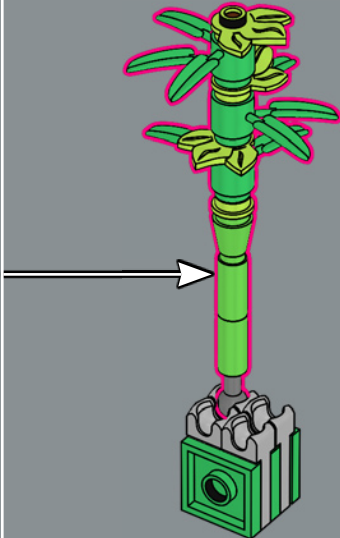
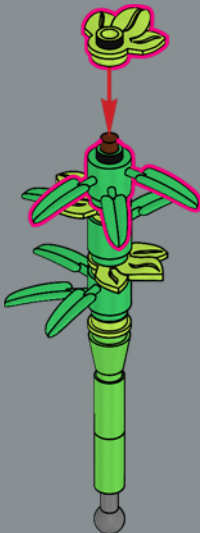



170 1

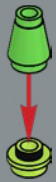

2

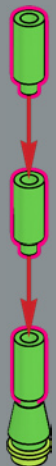

3



4



5

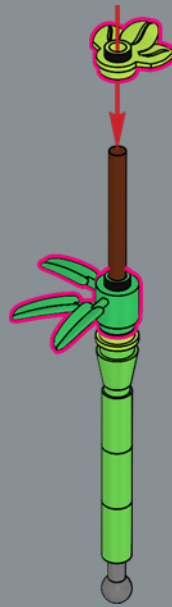

6

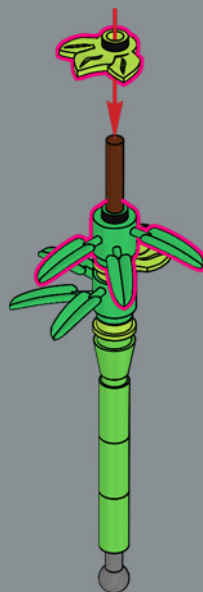

7

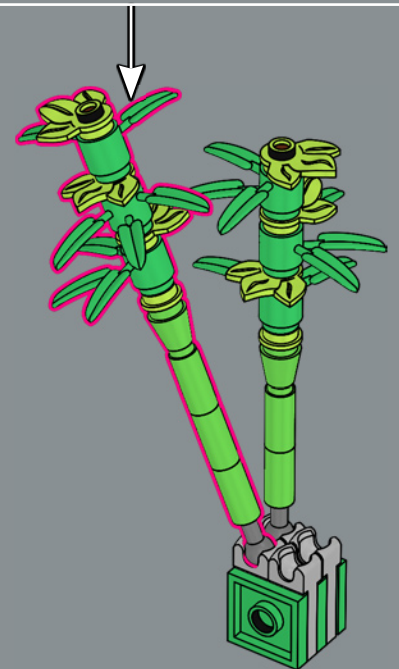

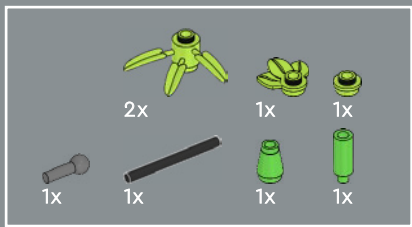

171

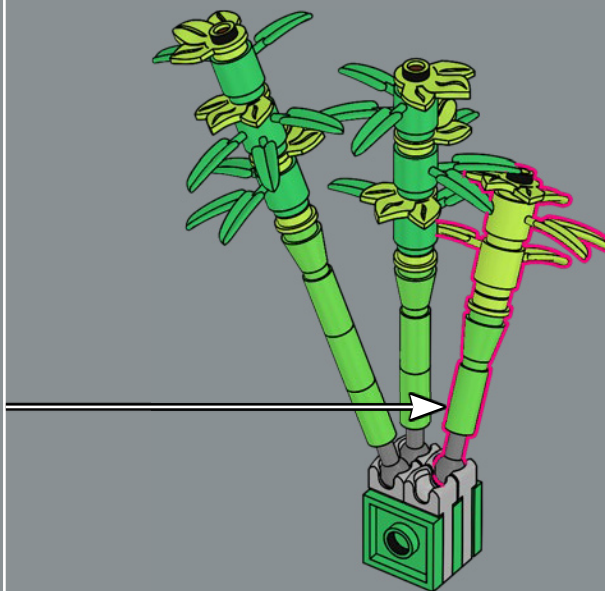
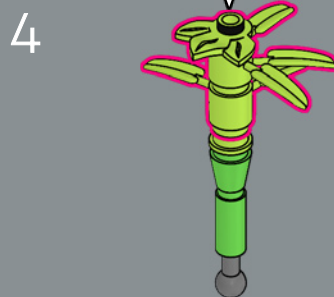
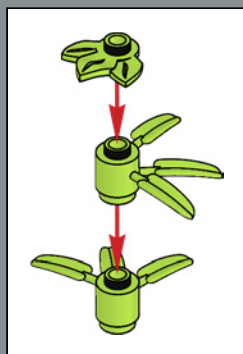
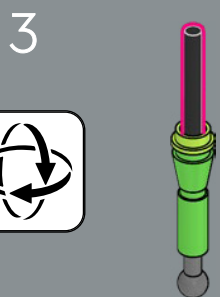
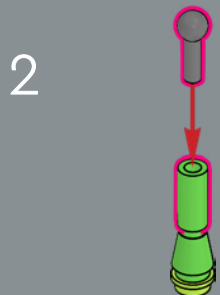
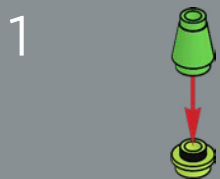

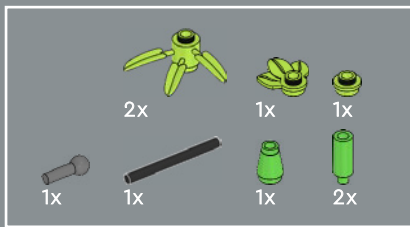

172

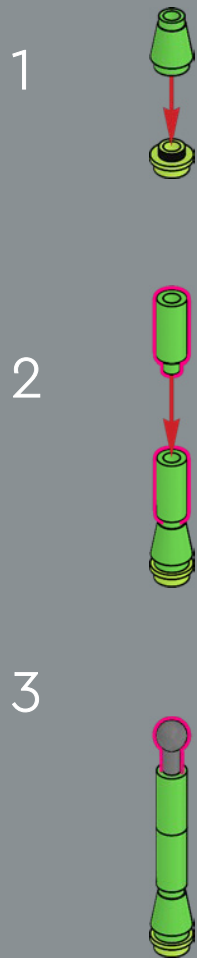

4

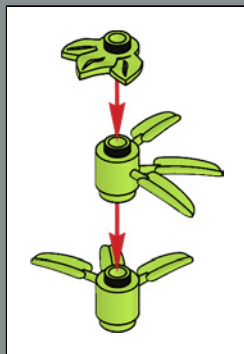

5

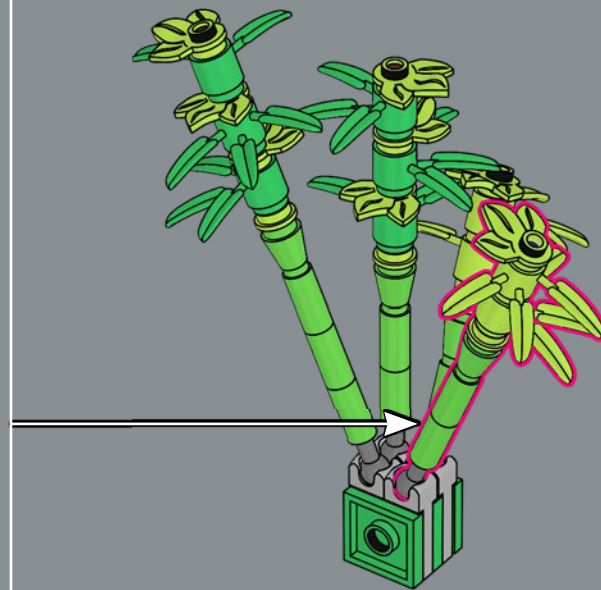
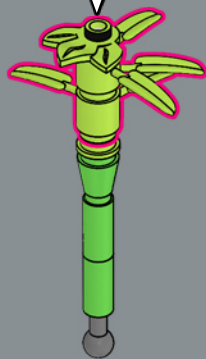



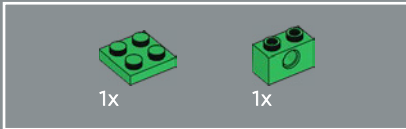

174

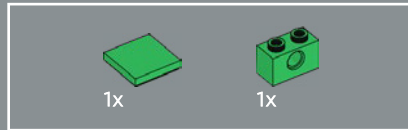
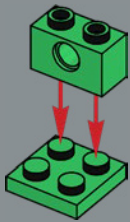

175

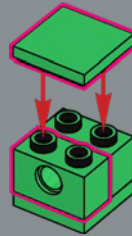

176

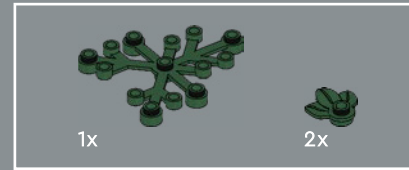
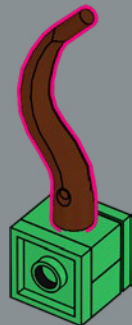

177

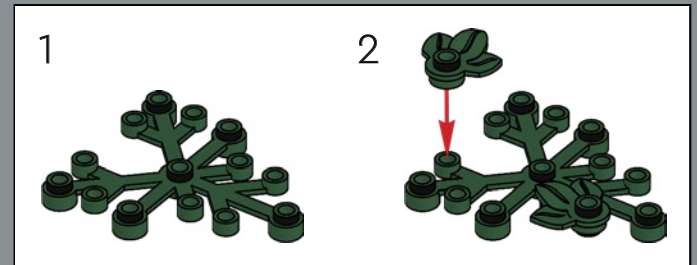

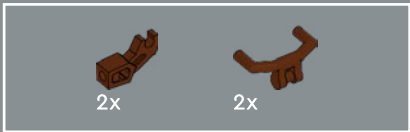

178

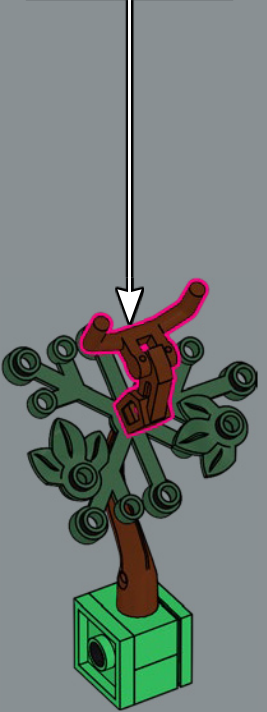
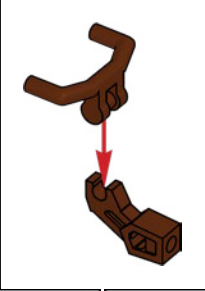

179

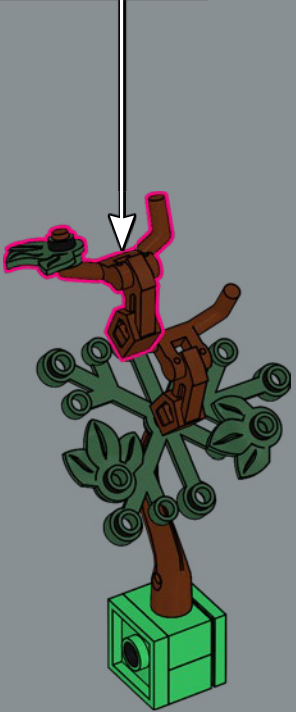
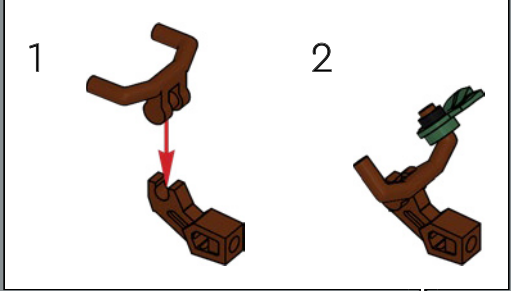

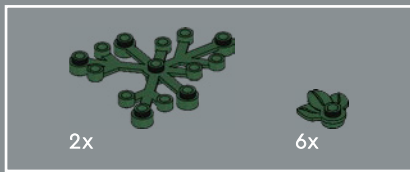

180

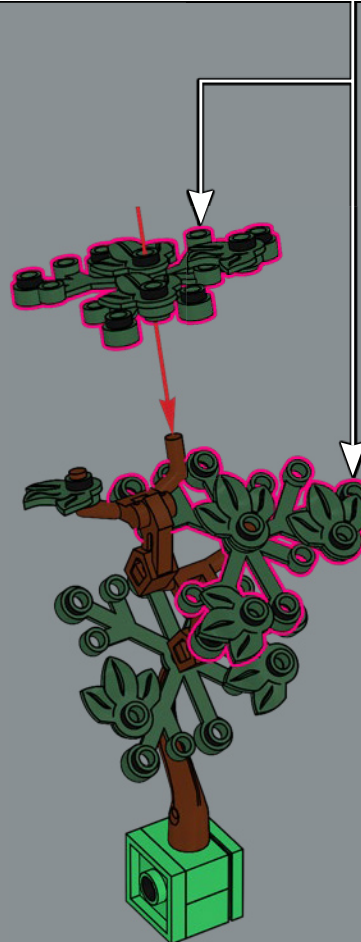
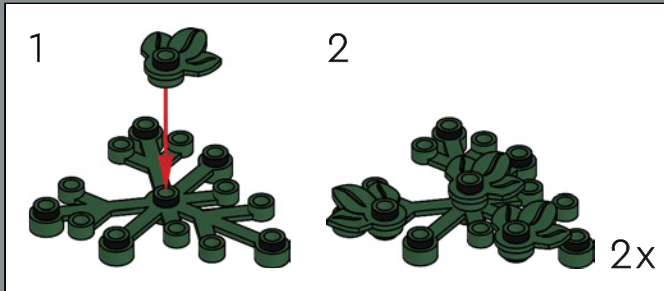



¿Quieres añadir un toque personal a tu modelo?
Déjate inspirar por los cinco principios de los jardines meditativos:
recogimiento, equilibrio, paisaje prestado, simbolismo y asimetría.

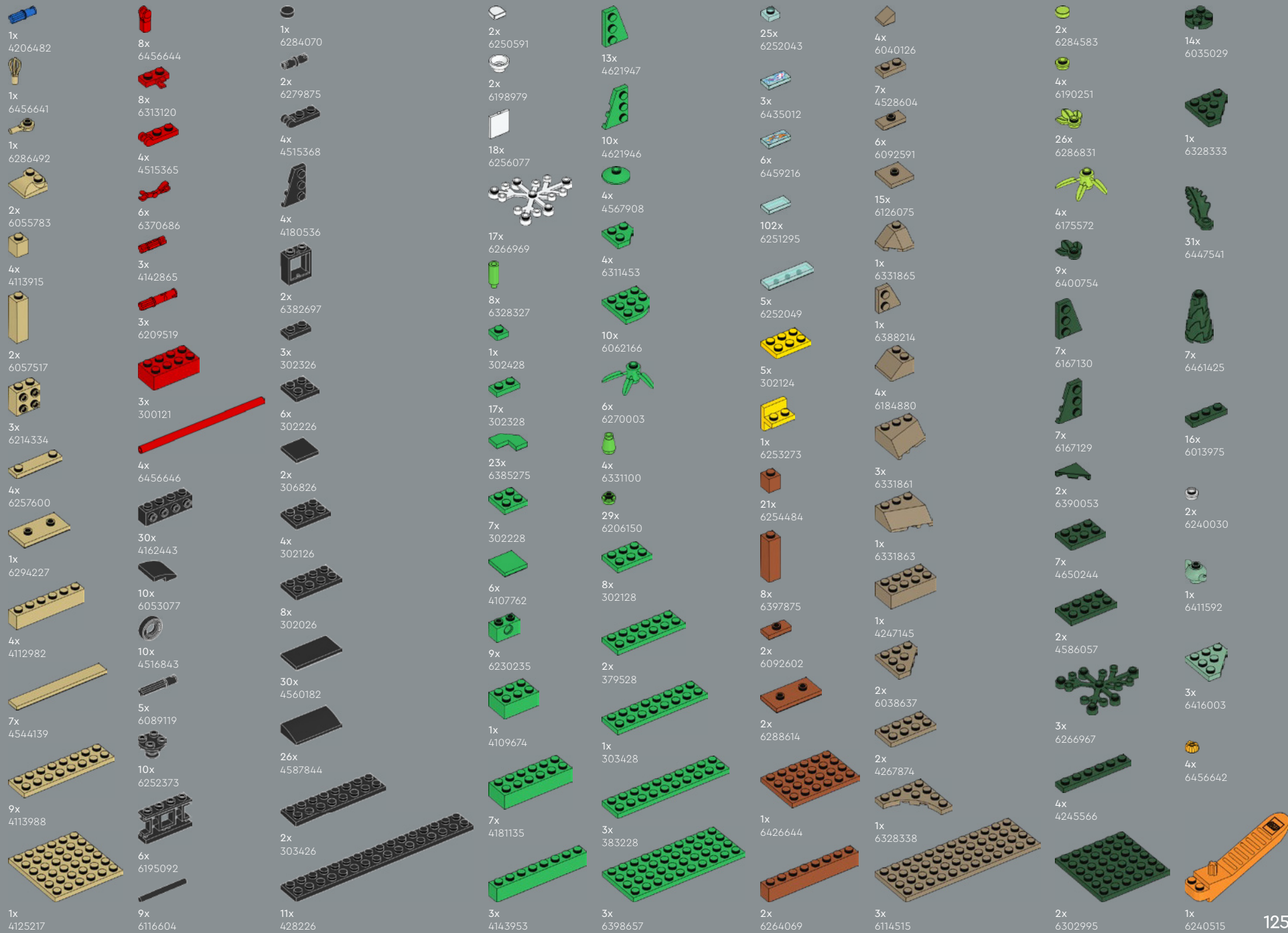

- 1x 4211183
- 3x 4211288
- 4x 4221744
- 1x 6151461
- 14x 4211190
- 5x 4216945
- 1x 4211214
- 2x 4225715
- 3x 6258989

- 1x 6348057
- 2x 4529242
- 7x 6173143
- 7x 6102360
- 3x 6451002
- 3x 4531751
- 2x 6276868
- 18x 6382102
- 1x 6326087
- 1x 6383996
- 1x 6327811

- 9x 6186673
- 12x 4211257
- 4x 6221608
- 2x 6327818
- 5x 6173132
- 3x 6261388
- 5x 4211200
- 3x 4211194
- 6x 6459423
- 3x 6170468
- 1x 6292952
- 14x 6372430
- 1x 6070442
- 8x 4211247

- 8x 4550325
- 5x 4211387
- 5x 4211511
- 3x 4651063
- 1x 4526932
- 1x 4521921
- 1x 4515374
- 8x 6034676
- 1x 6013497
- 1x 6315580
- 2x 4180418
- 1x 6315579

- 1x 4180408
- 1x 6401023
- 1x 4211397
- 1x 4211549
- 1x 4211639
- 5x 4211512
- 2x 4211400
- 2x 4598522
- 2x 4620130

5

- 5x 6284071
- 5x 6212288
- 5x 4529241
- 4x 4211353
- 4x 6043639
- 3x 6354325

- 3x 6395635
- 4x 6364352
- 7x 6199549
- 3x 6340333
- 1x 6171103
- 1x 4218696
- 1x 6126083
- 4x 4211052
- 21x 6177079
- 3x 6236949
- 12x 6447212
- 1x 4211100
- 1x 6106191
- 2x 4210678
- 1x 4211137

- 8x 6016483
- 34x 6206151
- 68x 6212501
- 1x 6186383
- 4x 6212377
- 16x 6279731
- 1x 6190252
- 2x 6173139
- 1x 6050916

- 8x 6456639
- 4x 6456643
- 4x 6456663
- 16x 6347604
- 2x 6021997
- 10x 6102990
- 4x 6347304
- 1x 6363146
- 4x 6456640



LEGO.com/service



YOU COULD WIN



YOU COULD WIN

Your feedback will help shape the future development of this product series.

Visit:

DU KÖNNTEST GEWINNEN

Dein Feedback trägt zur Weiterentwicklung dieser Produktreihe bei.

Geh auf:

VOUS POURRIEZ GAGNER

Vos commentaires nous aideront à concevoir les futurs produits de cette gamme.

Visitez :

POTRESTI VINCERE TU

La tua opinione ci aiuterà a migliorare la creazione futura di questa linea di prodotti.

Visita:

PUEDES GANAR

Tu opinión contribuirá al futuro de esta serie de productos.

Visita:

轻松获奖

您的反馈将有助于我们在今后改进本产品系列。

请访问:

LEGO.com/productfeedback

You also have the chance to win a LEGO® set.

Terms and conditions apply.*

Außerdem hast du die Chance, ein LEGO® Set zu gewinnen.

Es gelten die Teilnahmebedingungen.*

Vous pourriez également gagner un ensemble LEGO®.

Des conditions s'appliquent.*

Hai anche la possibilità di vincere un set LEGO®.

Termini e condizioni sono applicabili.*

También tienes la oportunidad de ganar un set LEGO®.

Aplican términos y condiciones.*

您还有机会赢取乐高®套装。

条款和条件适用。*

*LEGO.com/productfeedback-terms



LEGO and the LEGO logo are trademarks of the LEGO Group.
©2023 The LEGO Group.