



EWIGE FASZINATION, EWIGE BLÜTE

Schon Theophrastus, ein Schüler von Aristoteles, liebte Orchideen. Konfuzius, der große Philosoph, widmete ihnen sogar Gedichte. Schon seit Jahrhunderten faszinieren Orchideen viele Menschen. Und heute wirst auch du ihrer Faszination erliegen. Die meisten Orchideen erfordern große Zuwendung und Pflege, um immer wieder eindrucksvoll zu blühen. Doch die LEGO® Orchidee gedeiht sogar in der dunkelsten Kammer ohne extreme Luftfeuchtigkeit prächtig.





Die drei Modelle lassen sich nicht gleichzeitig bauen.

BLUMEN GANZ NACH DEINEM GESCHMACK

Die Pflanze besteht aus sechs vollen Blüten und zwei kleineren Knospen. Die Stängel lassen sich auf unterschiedliche Längen „zuschneiden“, und die Wurzeln und Blätter kann man drehen. Außerdem kannst du die Blüten immer wieder anders arrangieren.



ANMERKUNGEN DES DESIGNTEAMS

Mike entwirft bereits seit mehr als 9 Jahren LEGO® Produkte. Die faszinierende Geometrie des Blumentopfes war für Mike eine ebenso knifflige wie reizvolle Aufgabe. „Es war eine spannende Herausforderung, Orchideen zu entwickeln, die in einen geriffelten sandblauen Blumentopf passen, Bauspaß bieten und schön anzusehen sind. Als Vorbild wurden mir echte Orchideen ins Zimmer gestellt. Aber ehrlich gesagt ist die LEGO Orchidee viel pflegeleichter und ein wirklich angenehmer Mitbewohner.“

Michael Psiaki, Design Master

ERWEITERE DEINE LEGO® BOTANIK KOLLEKTION



10280
Blumenstrauß



10289
Paradiesvogelblume



10281
Bonsai Baum



10309
Sukkulenten

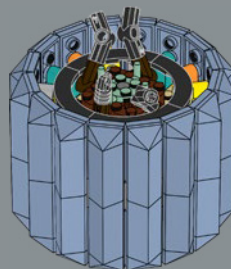
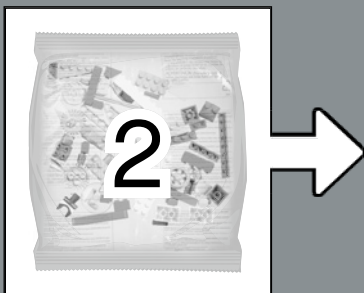
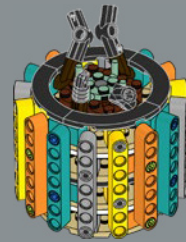
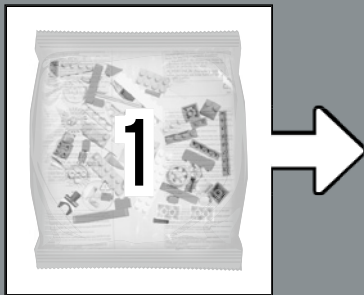
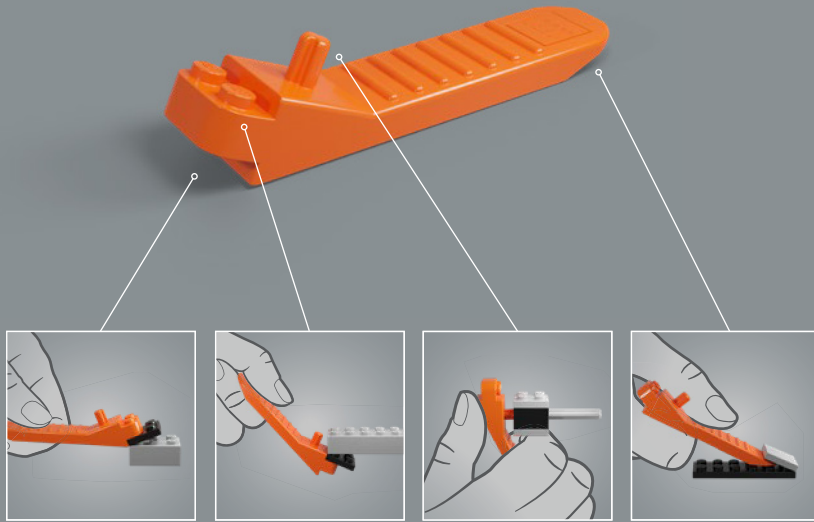

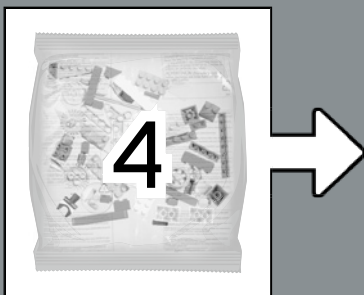
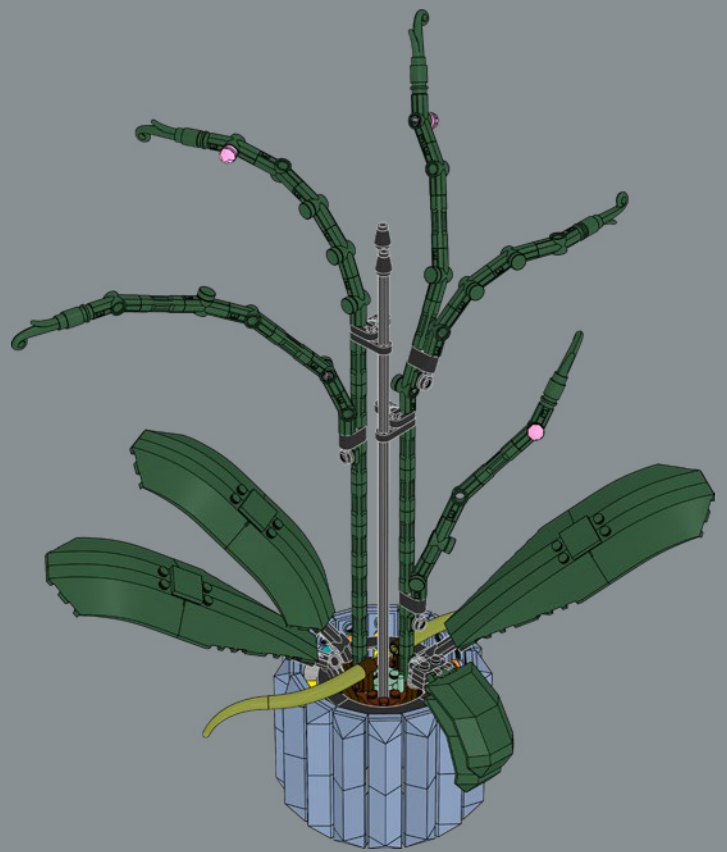
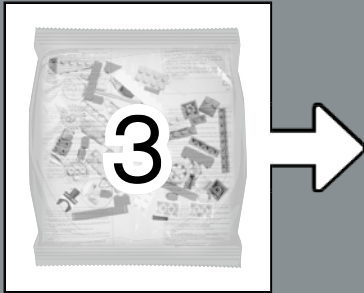

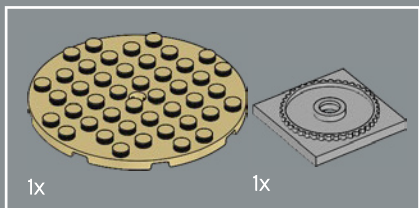

1

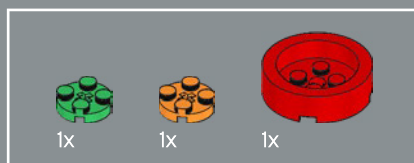
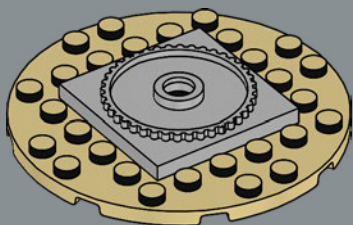

2

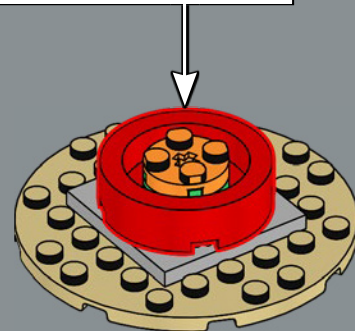
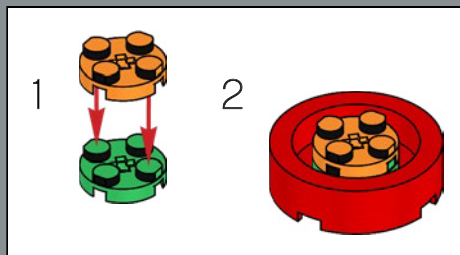



3

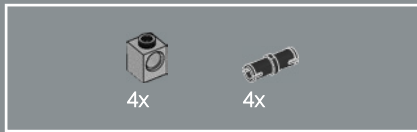
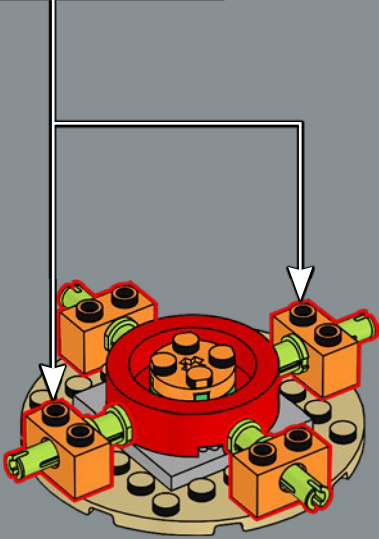
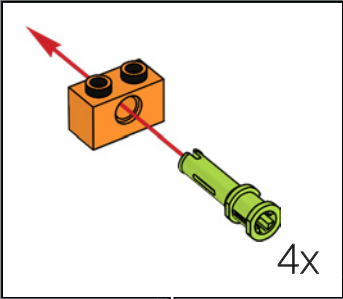

4

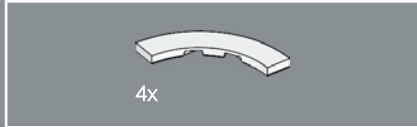
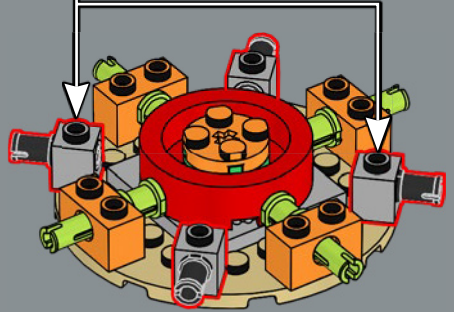
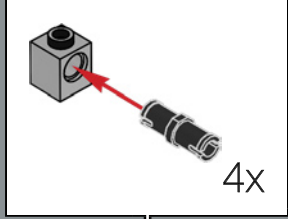

5



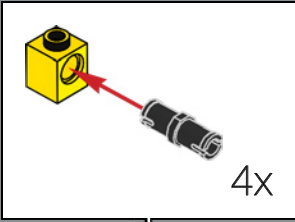

4

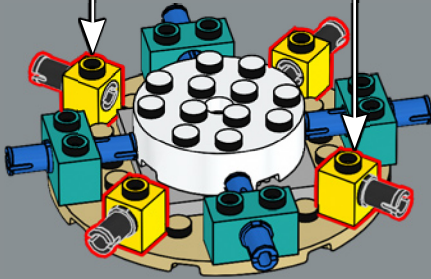

5

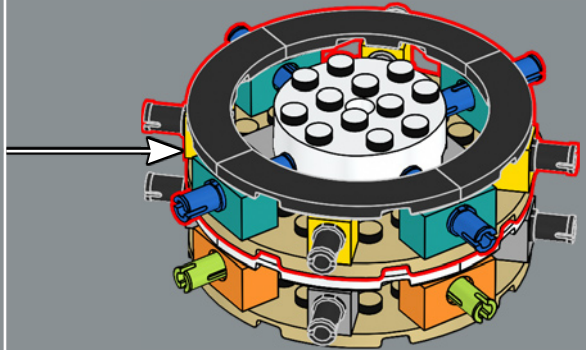
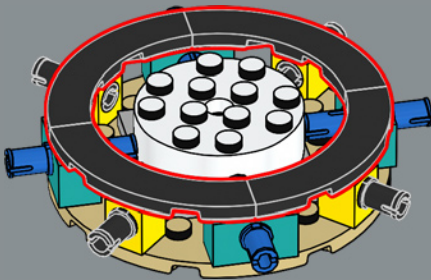

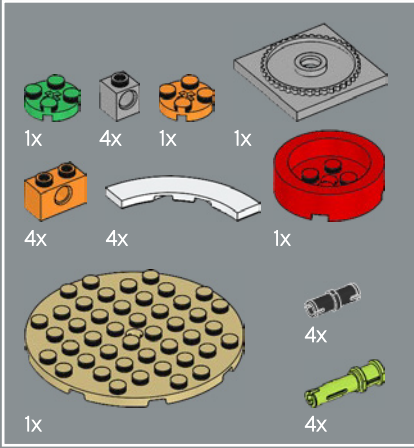
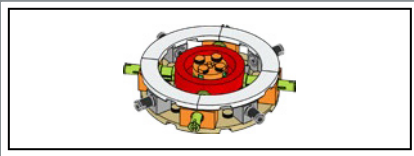

7

1

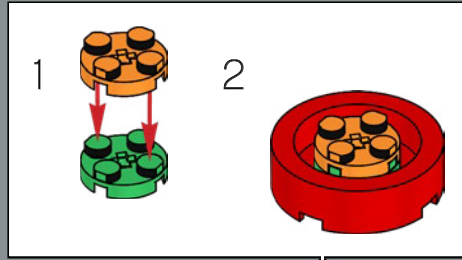
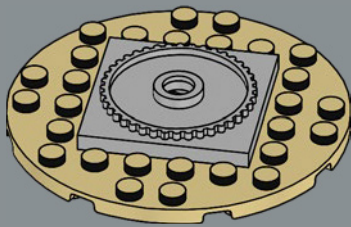

2

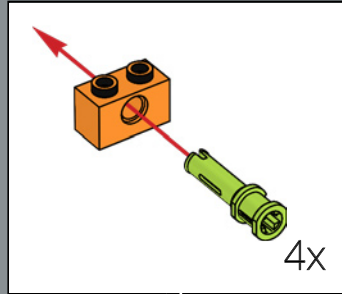
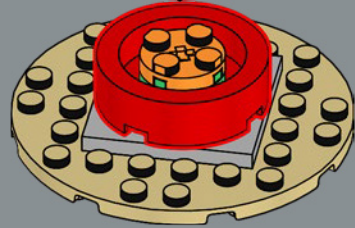

4x

3

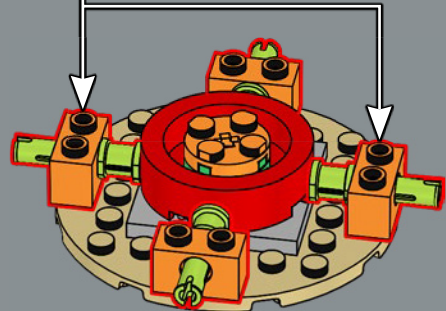



Der Kern des Topfes ist eine modifizierte Version des Kerns, der für den großen Turm aus dem LEGO® Set „Schloss Hogwarts“™ benutzt wurde. Professor Sprout hätte ihre helle Freude daran.

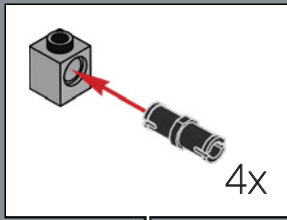

4

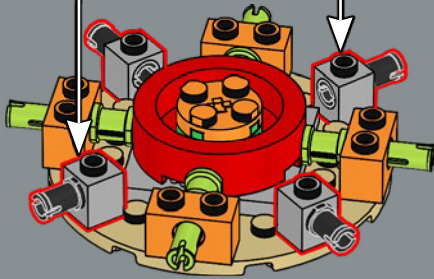

5

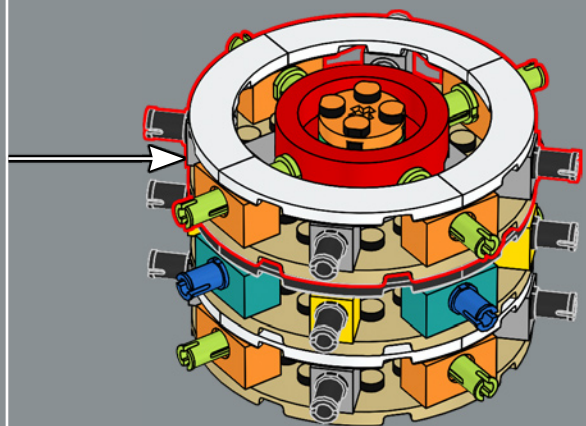

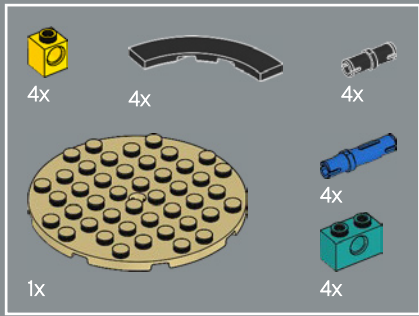

8

1

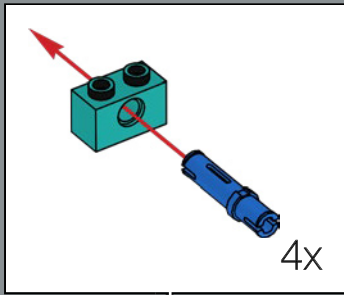
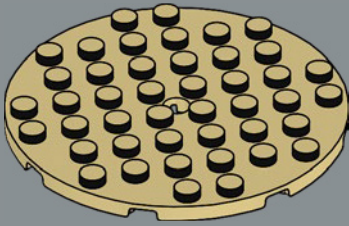

2

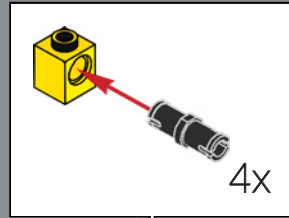
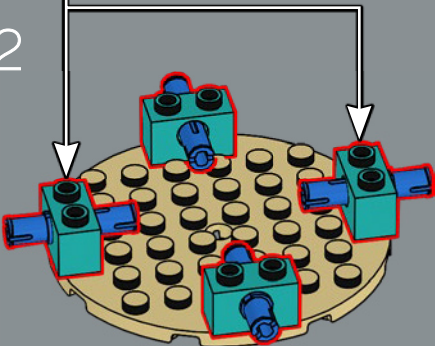

3

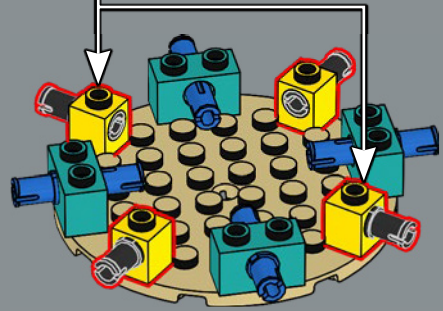

4

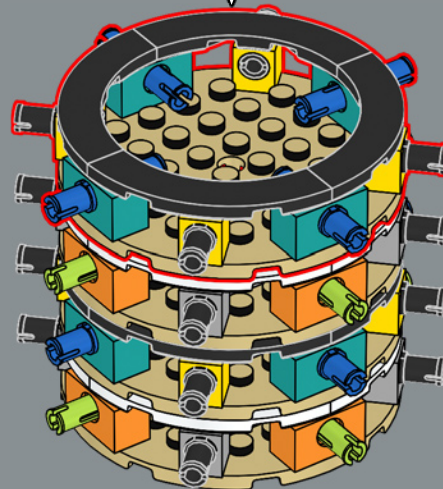
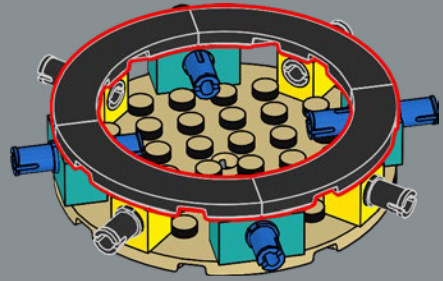

9

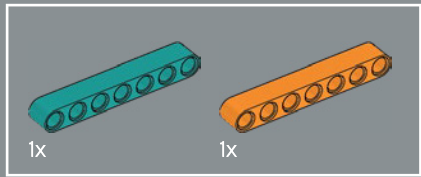
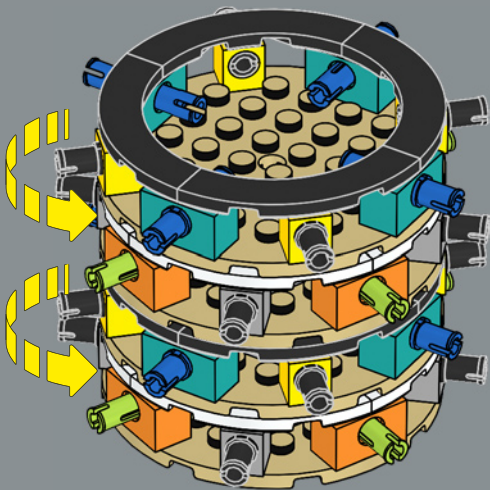

10

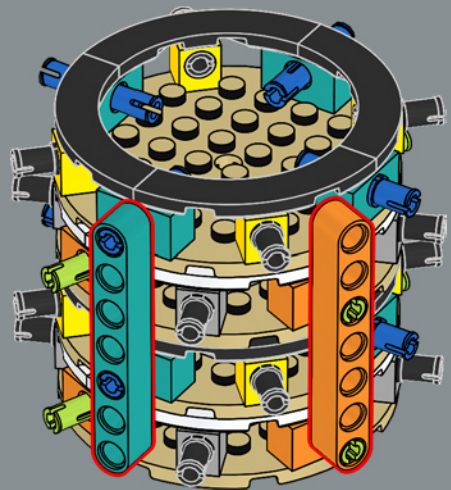

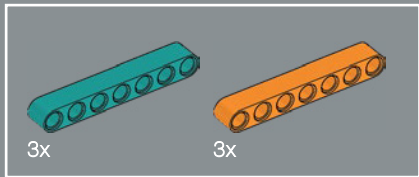

11

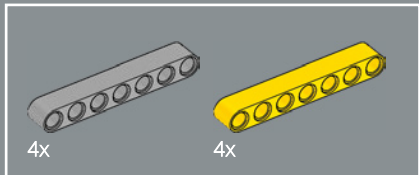
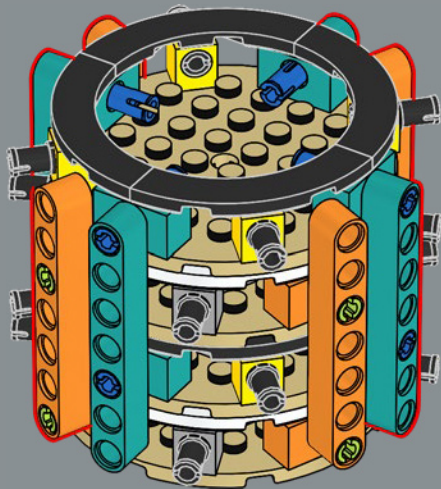

12

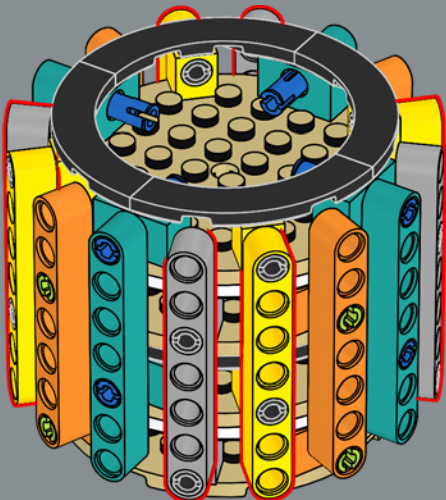

13

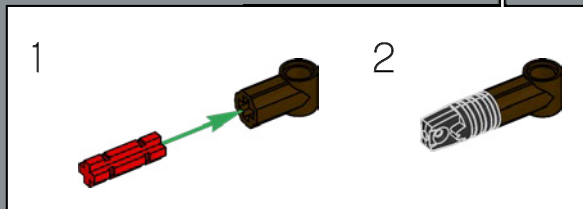
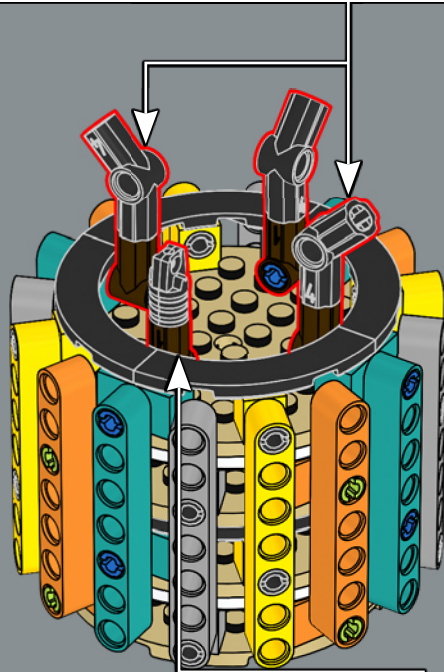
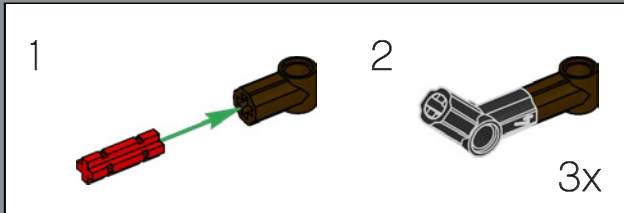



14

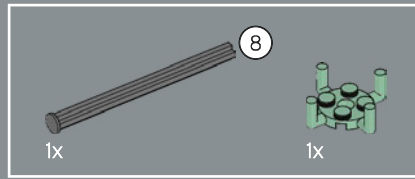
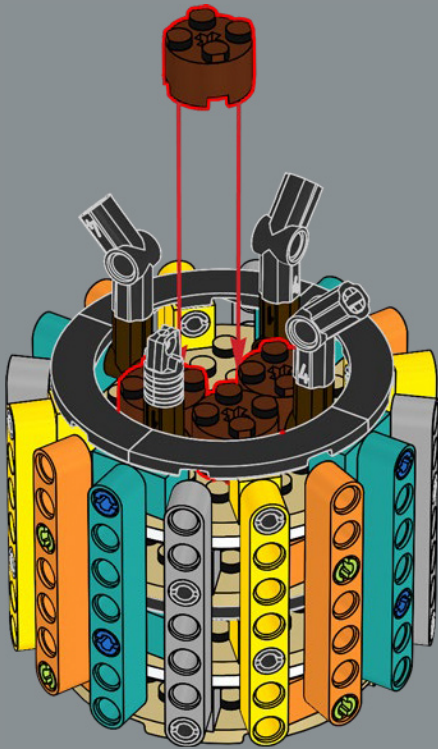

15

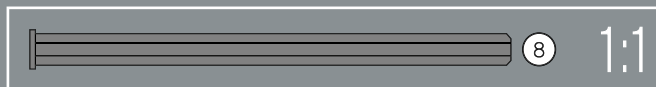
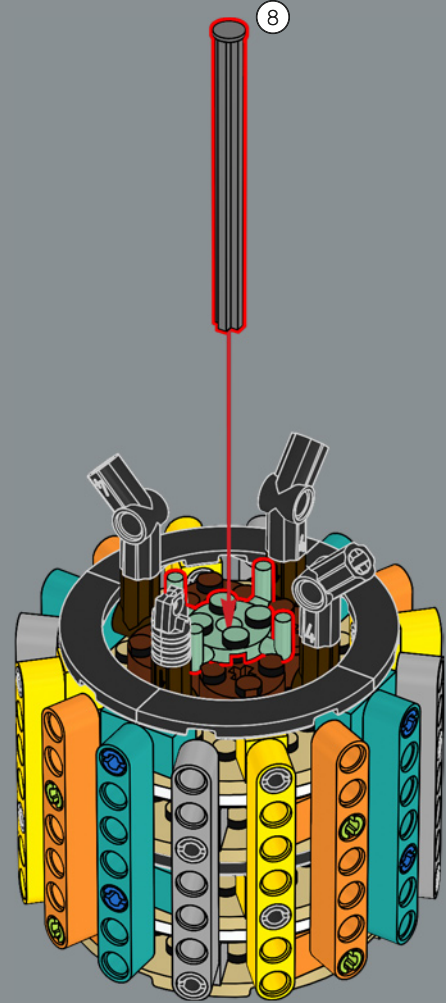

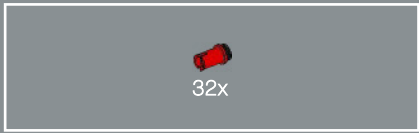

16

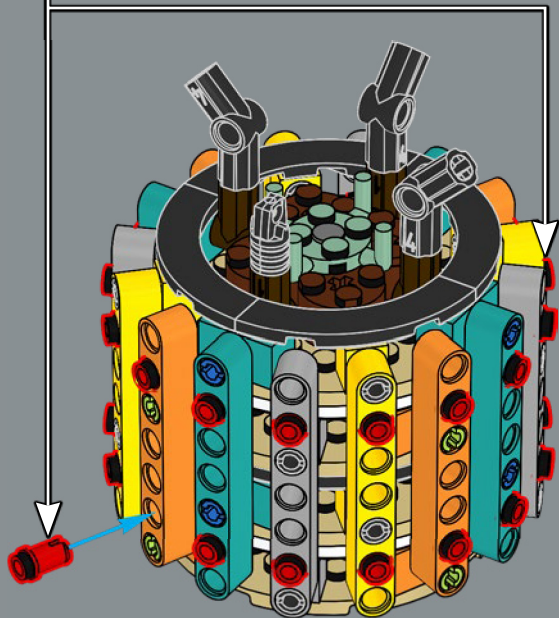

18

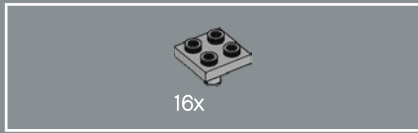

17

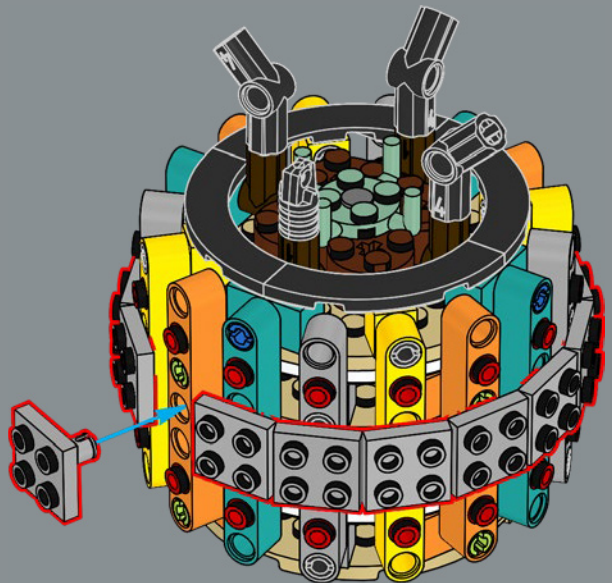

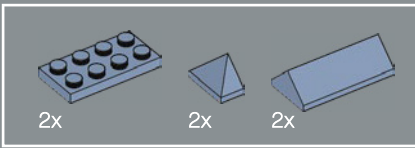

18

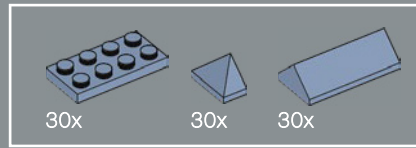
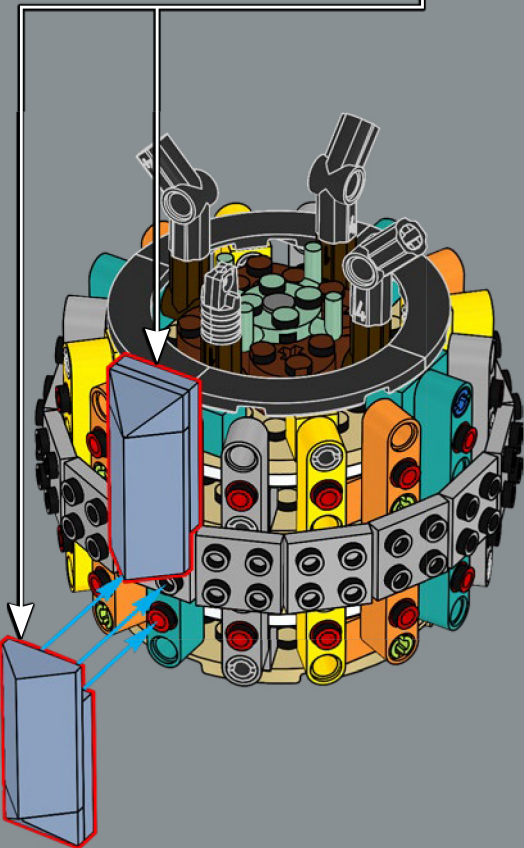
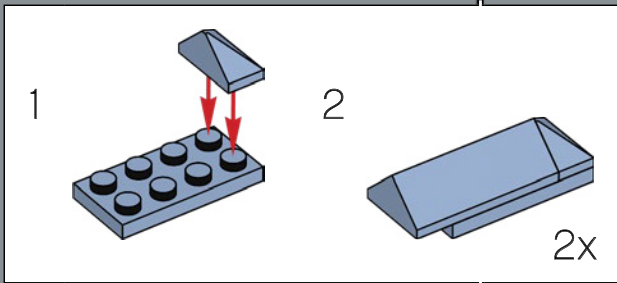

19

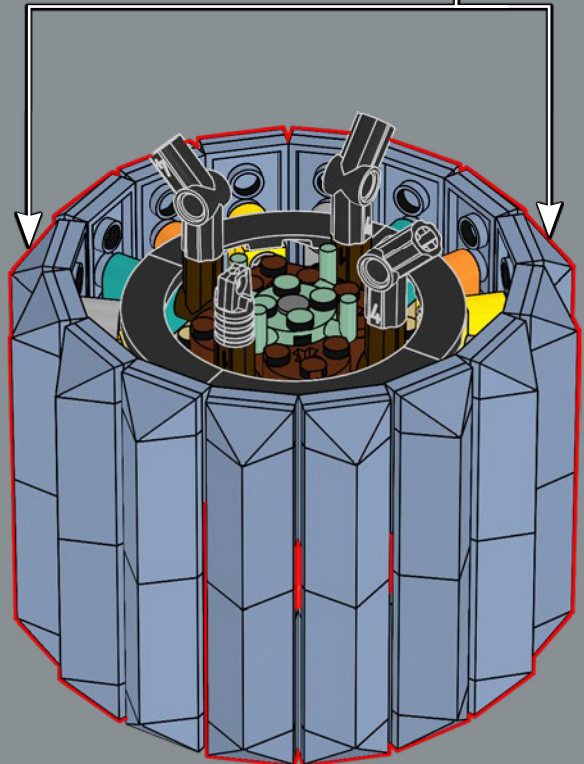
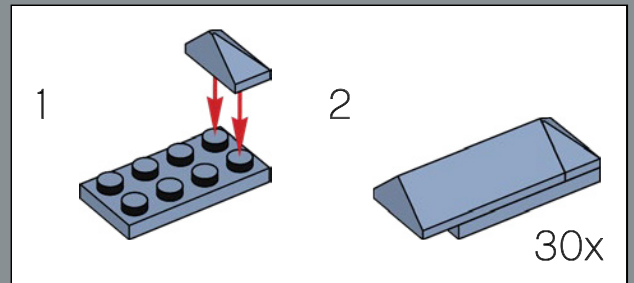

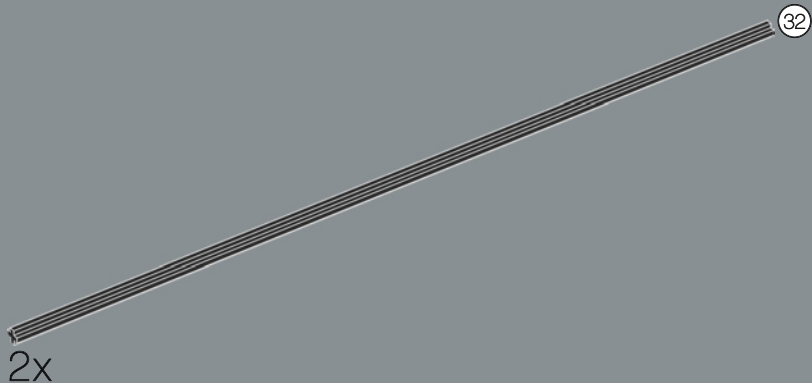
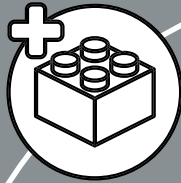



20

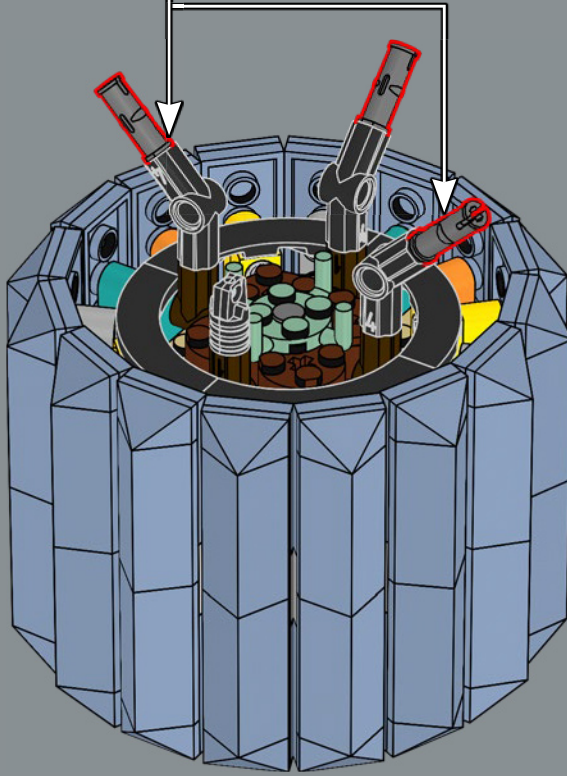
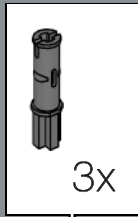

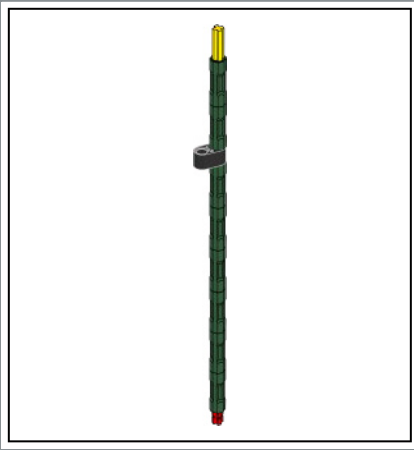

21



22

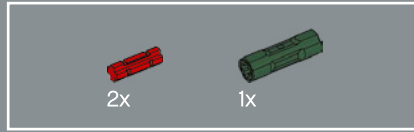
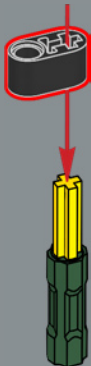

23

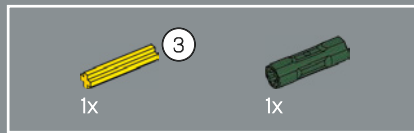
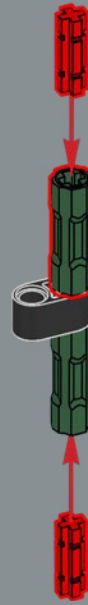

24

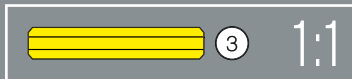

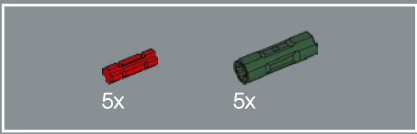

25

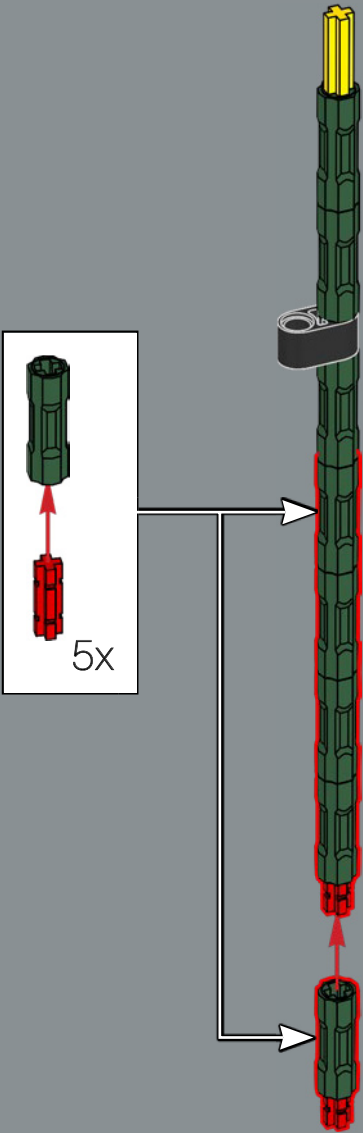

26

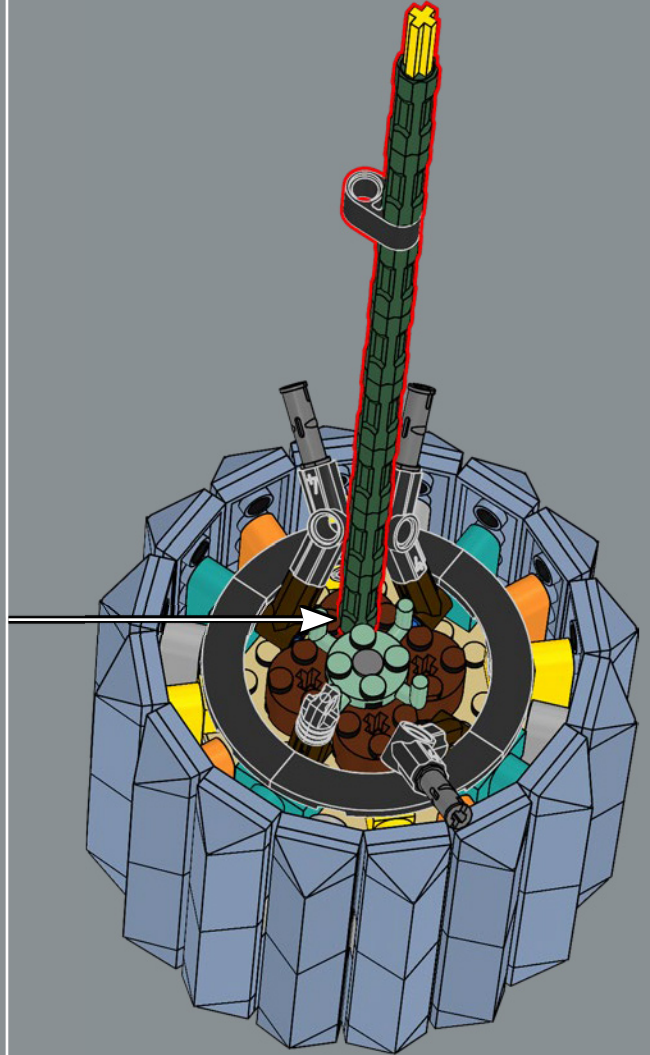

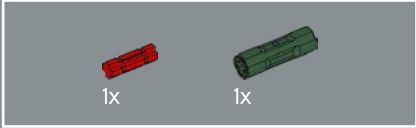
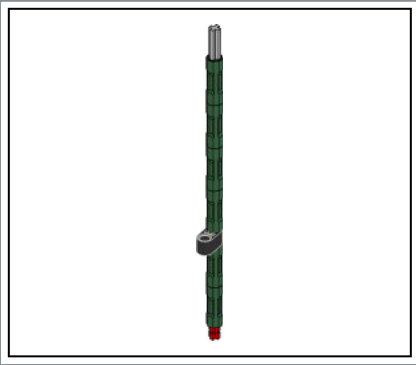

27

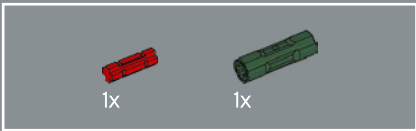
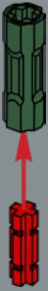

28

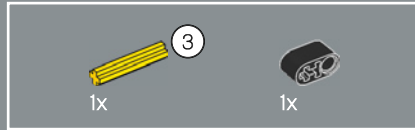

29

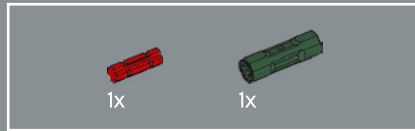
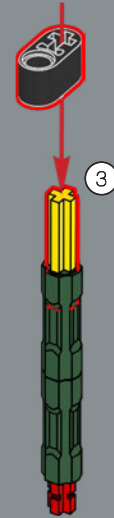

30

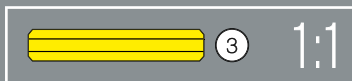

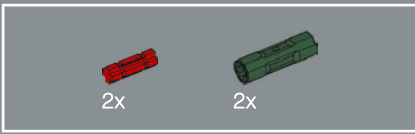

31

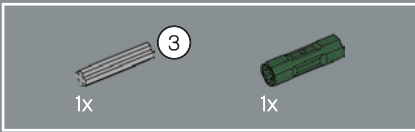
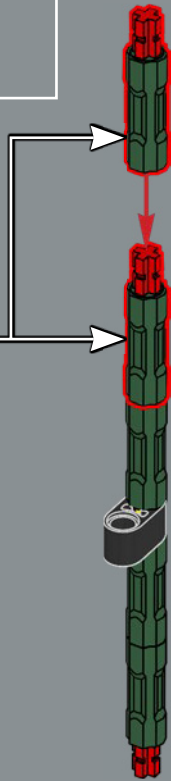
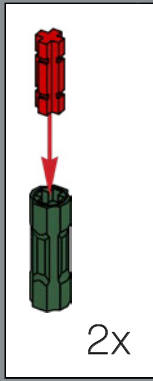

32

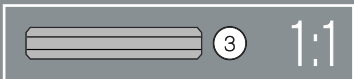

33

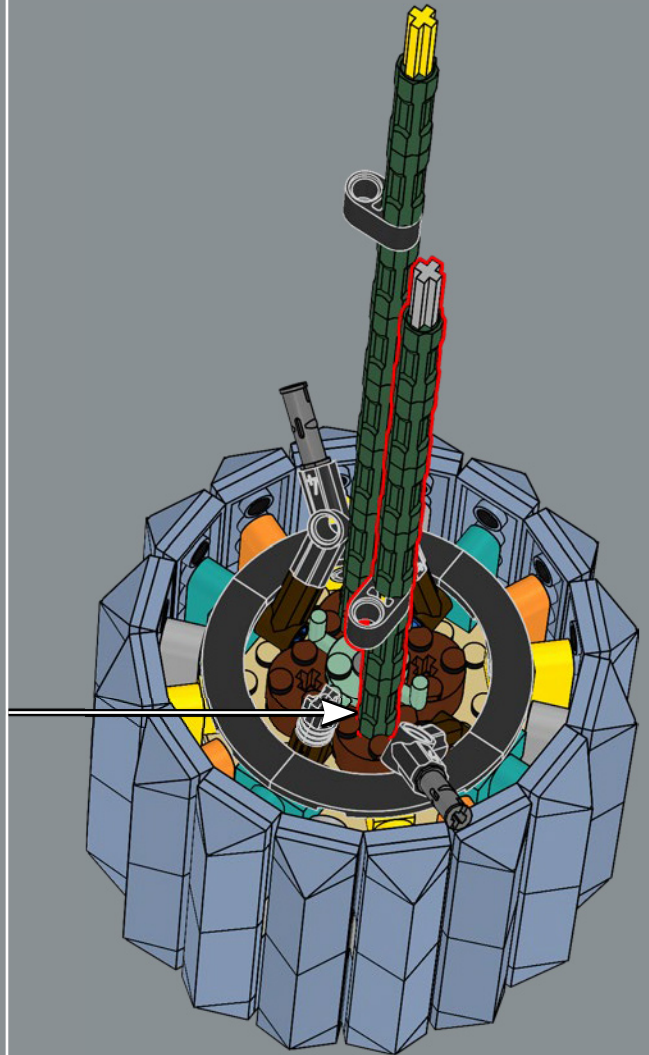

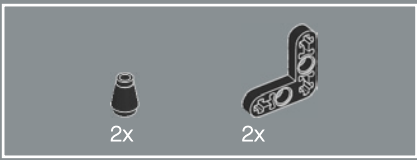

34

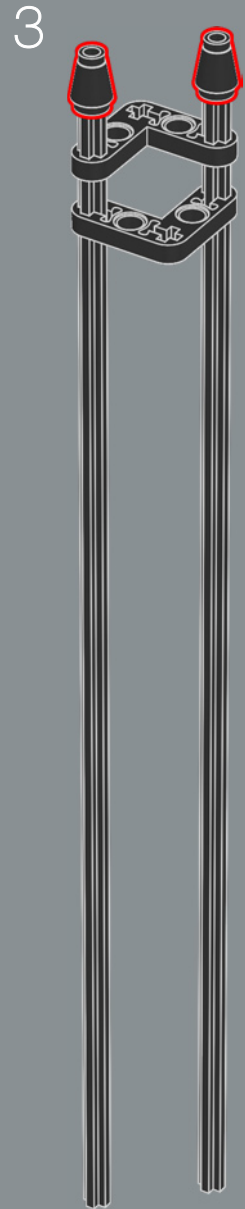
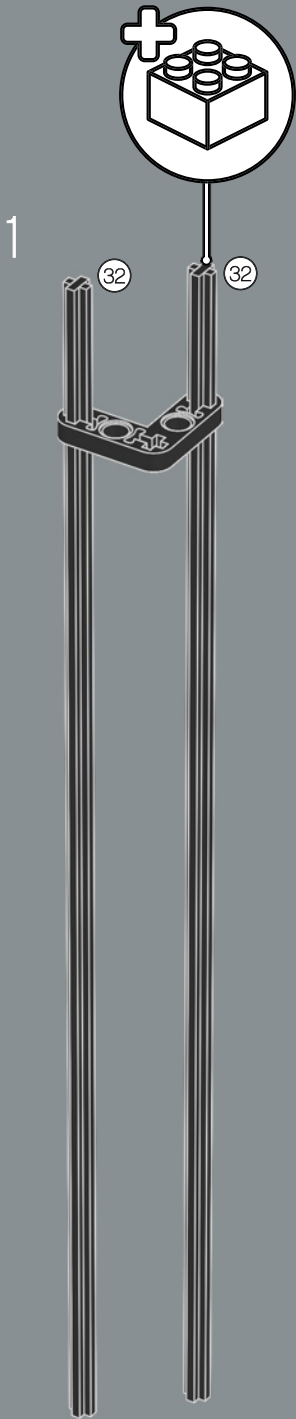

35

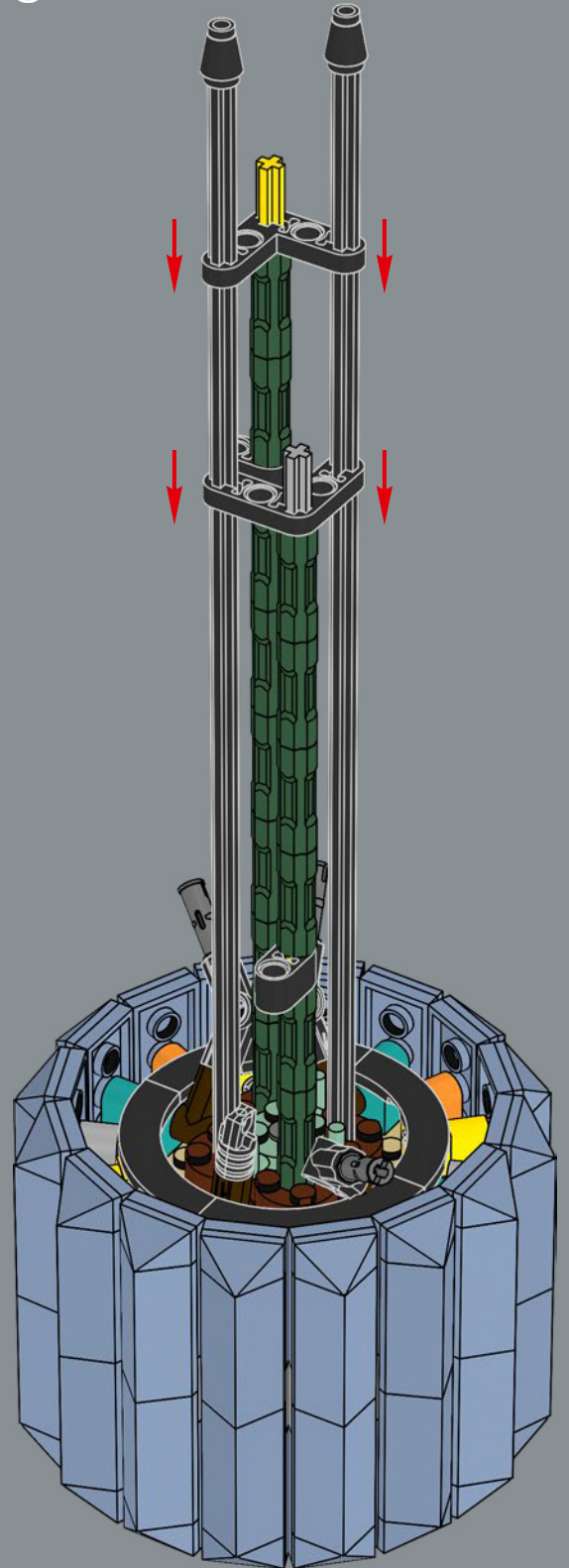
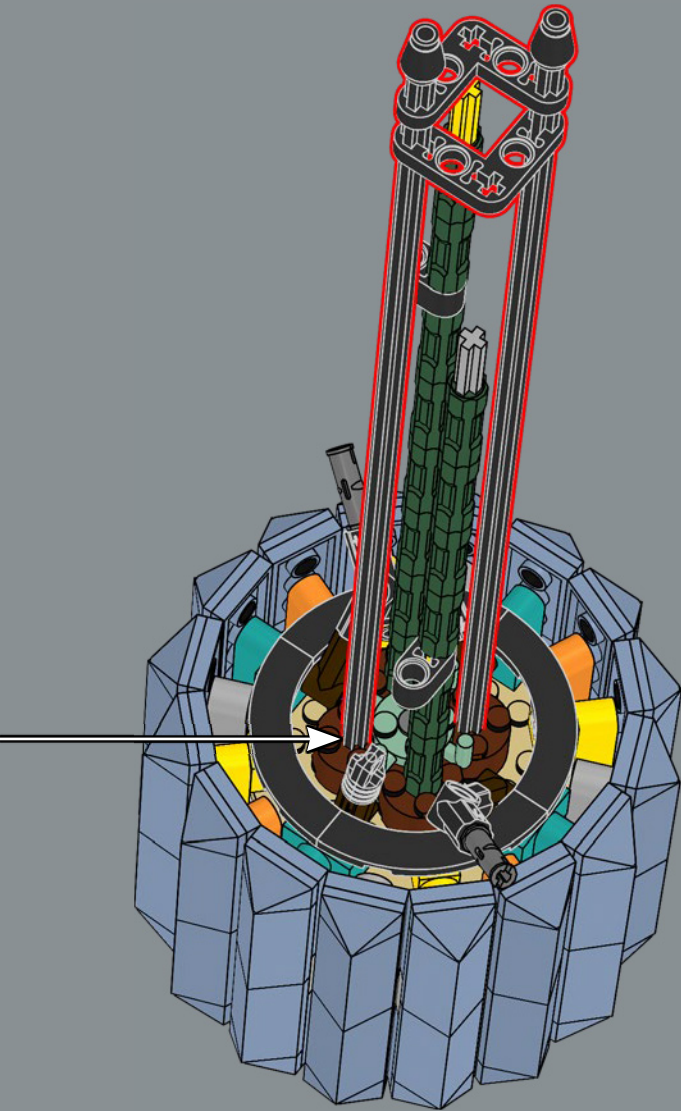



36

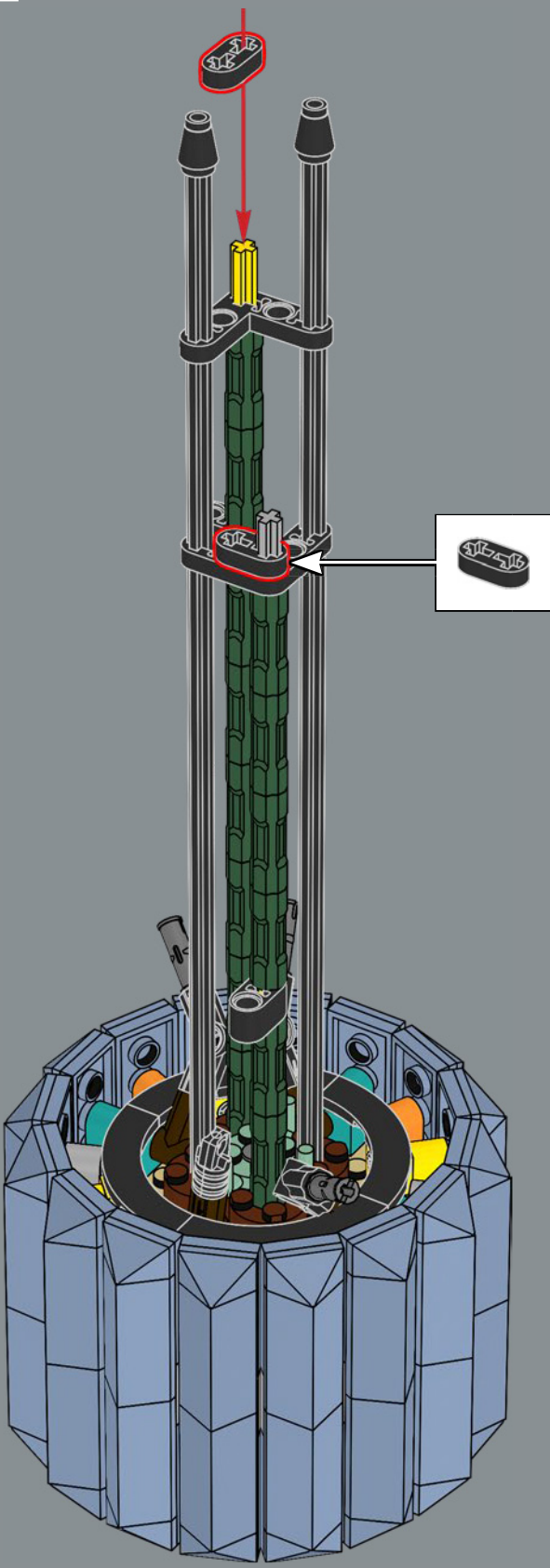

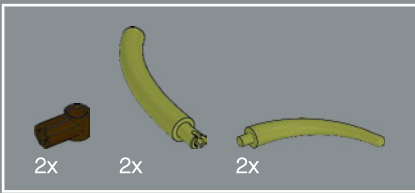

37

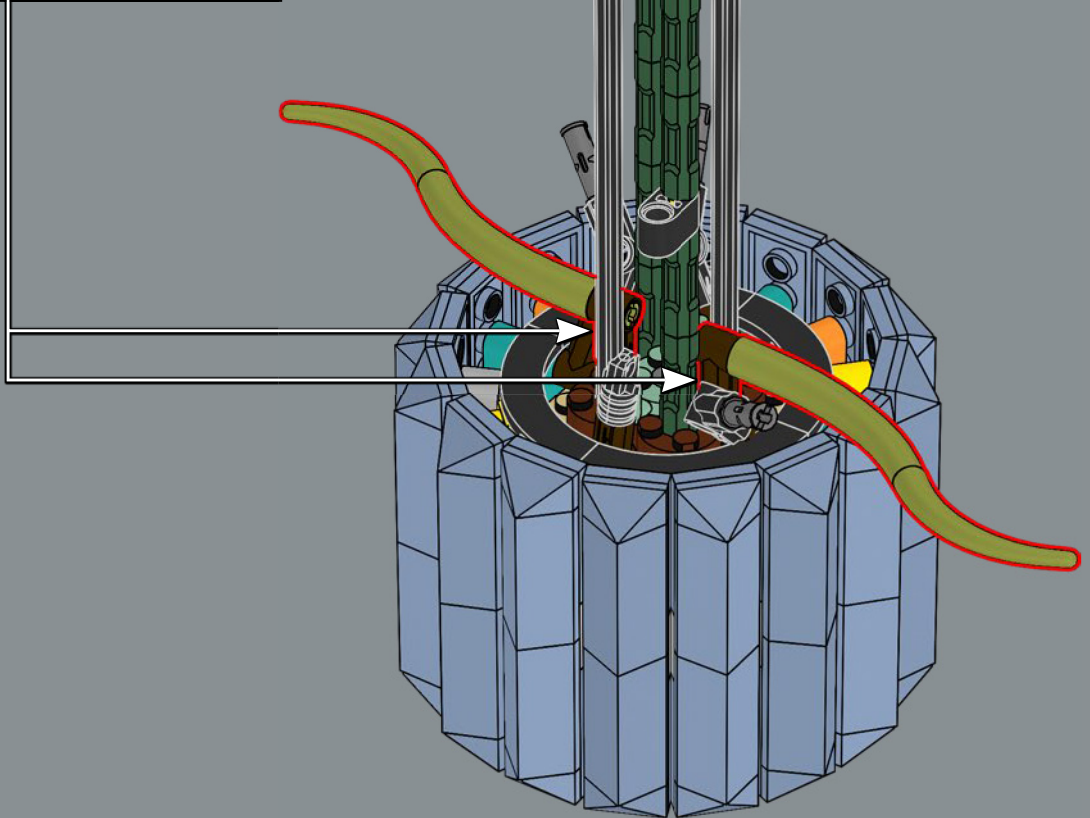
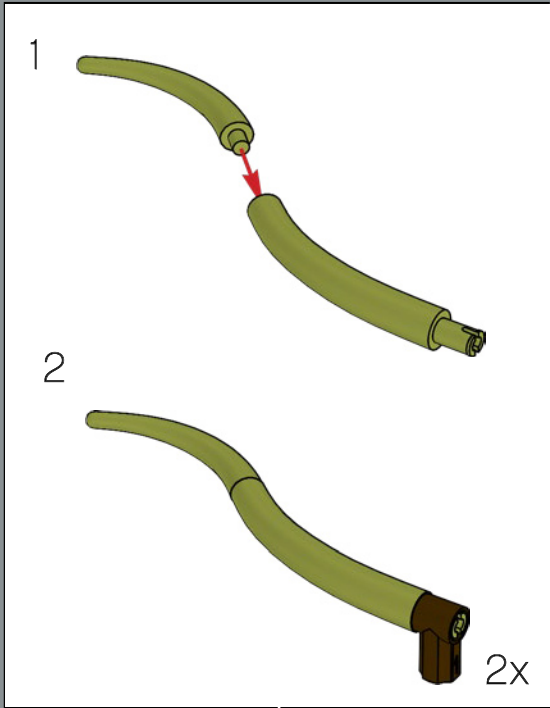

Die freiliegenden Wurzeln der Orchidee bestehen aus den Elementen eines Dinosaurierschwanzes.

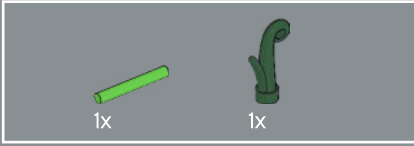
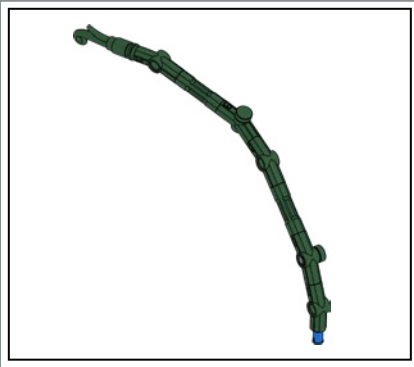

38

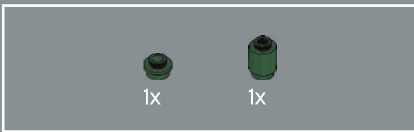
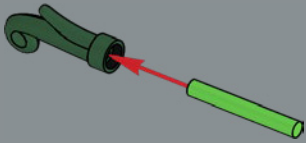

39

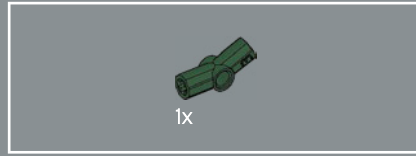
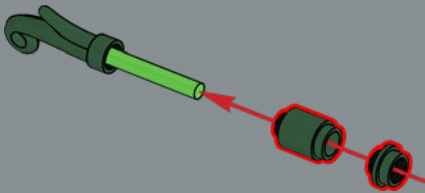

40

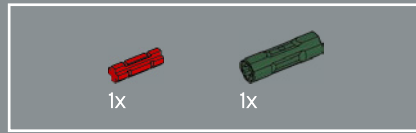
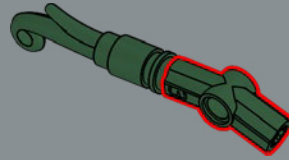

41

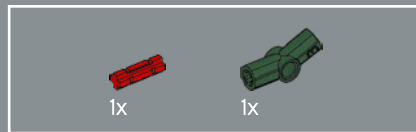
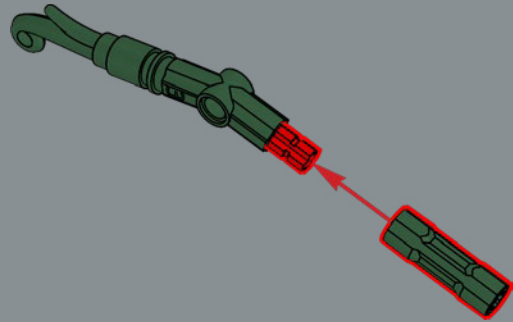

42

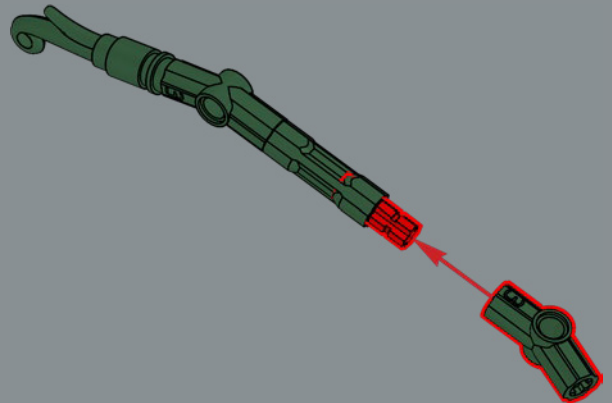

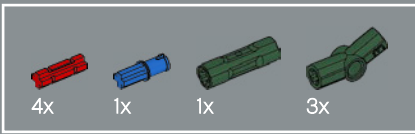

43

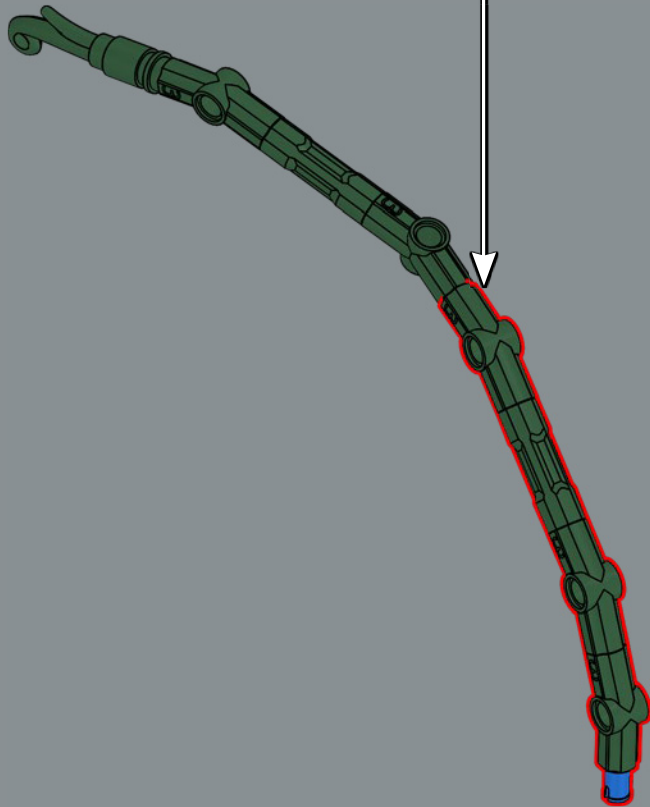
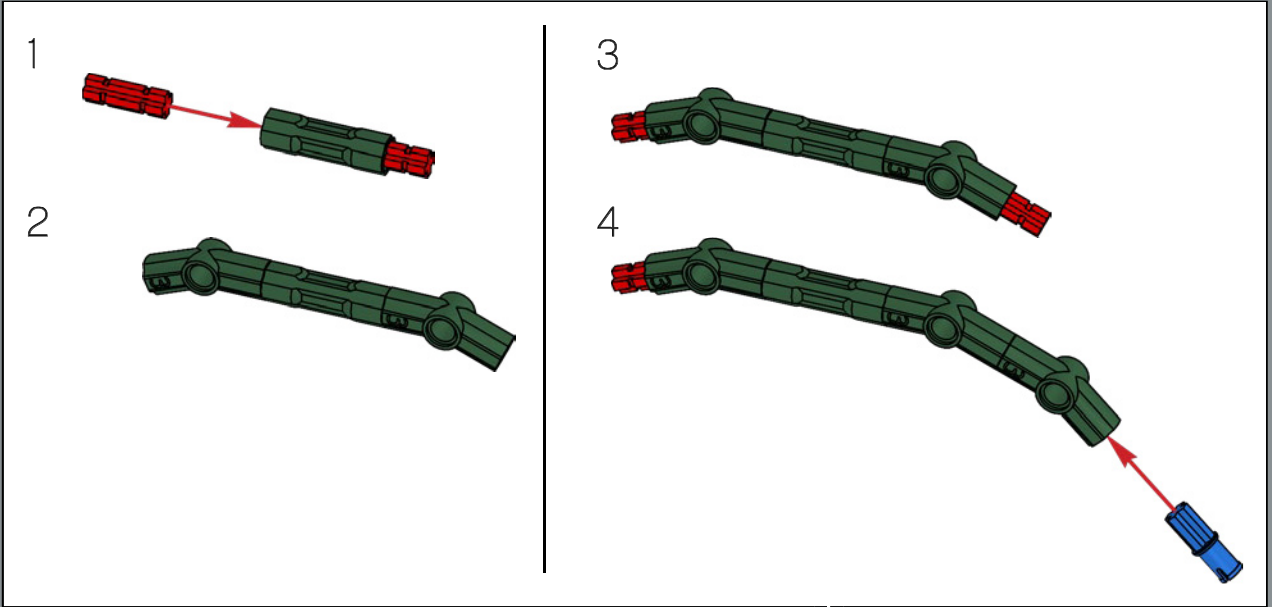



44

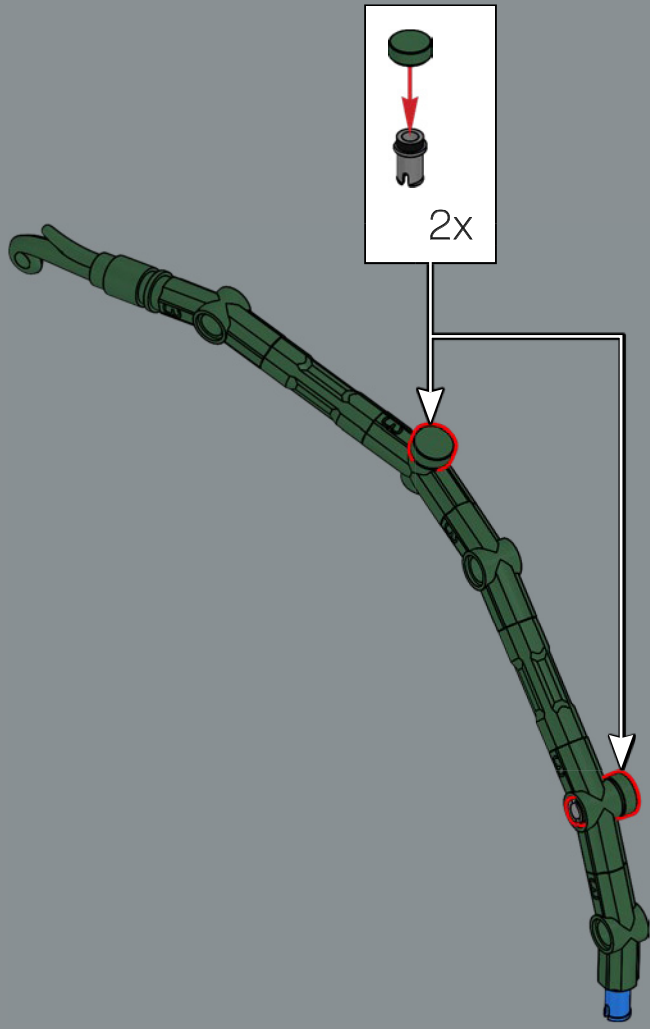

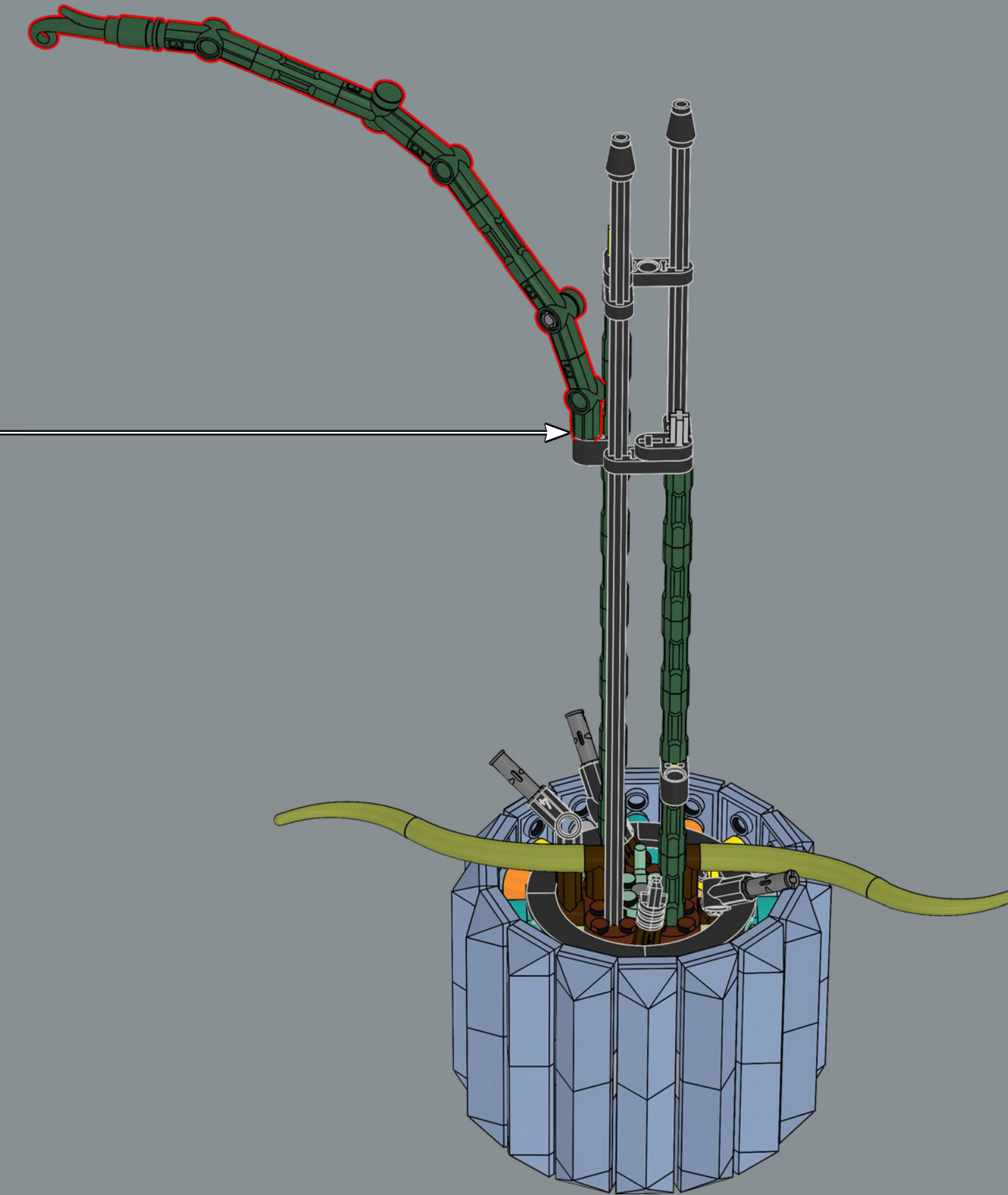

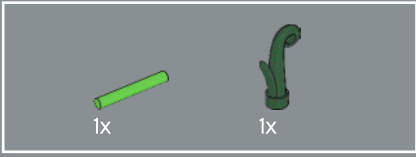
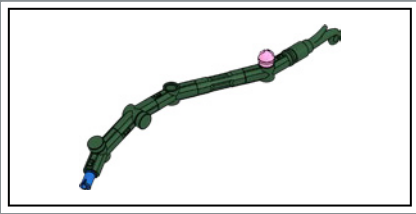

46

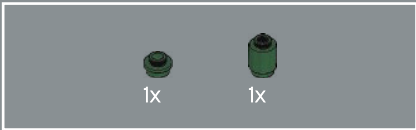
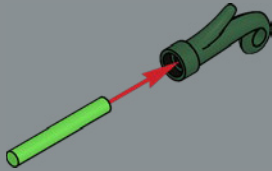

47

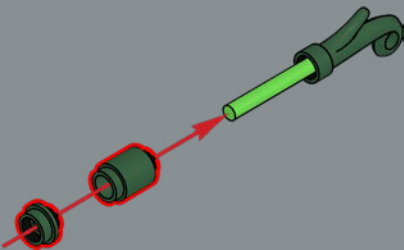

48

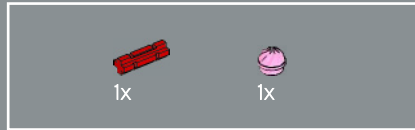
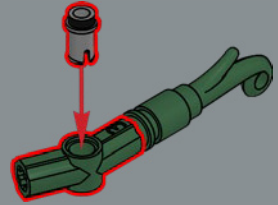

49

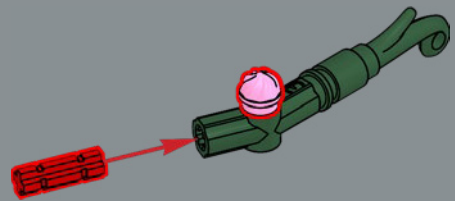

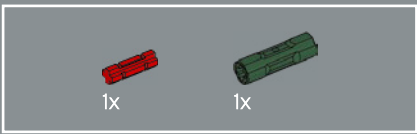

50

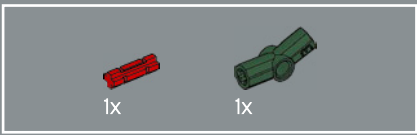
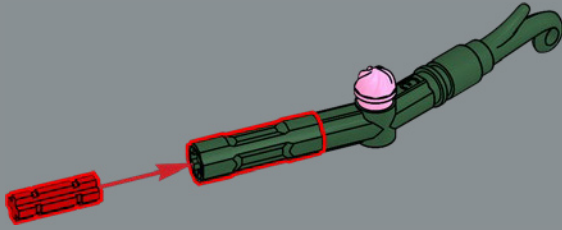

51

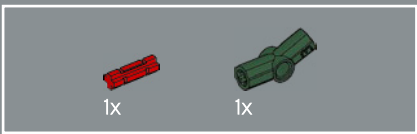
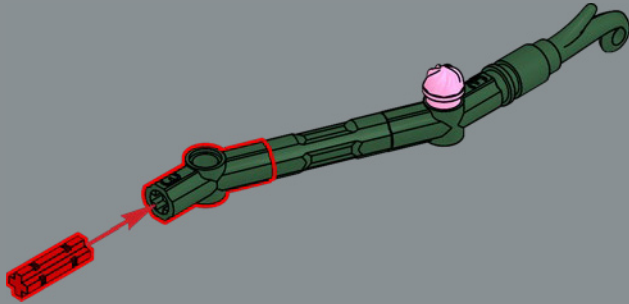

52

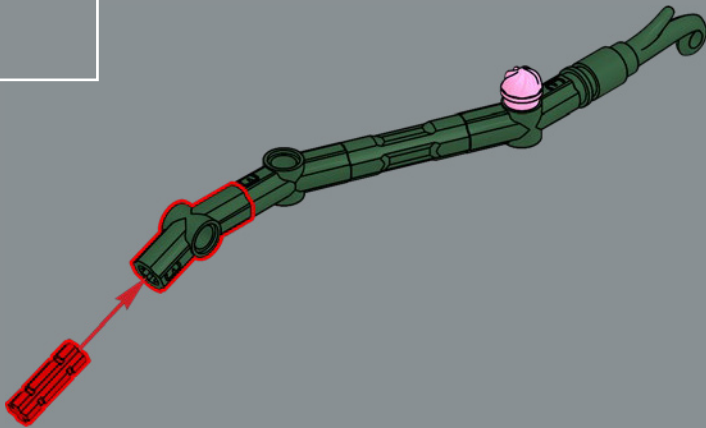

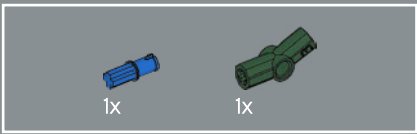

53

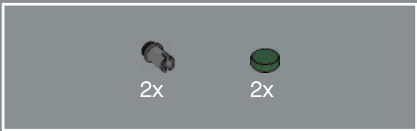
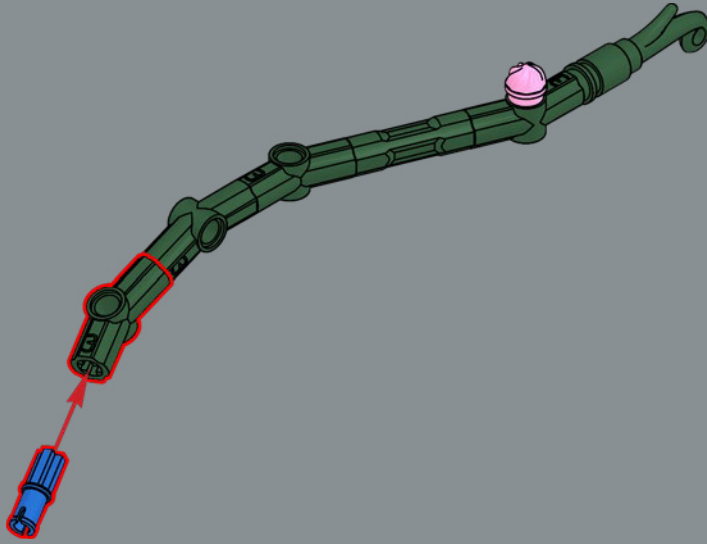

54

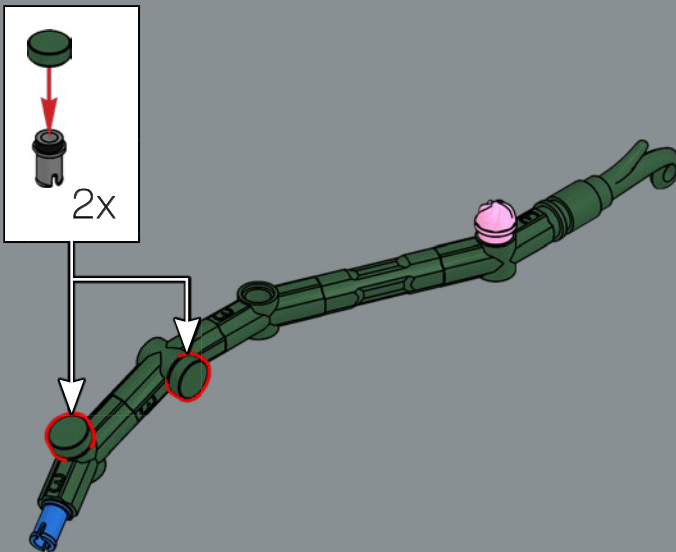



Die Stängel der Orchidee sind aus LEGO® Technic Elementen gebaut, damit deine Orchidee nicht nur ganzjährig blüht, sondern auch immer wieder neu arrangiert werden kann.

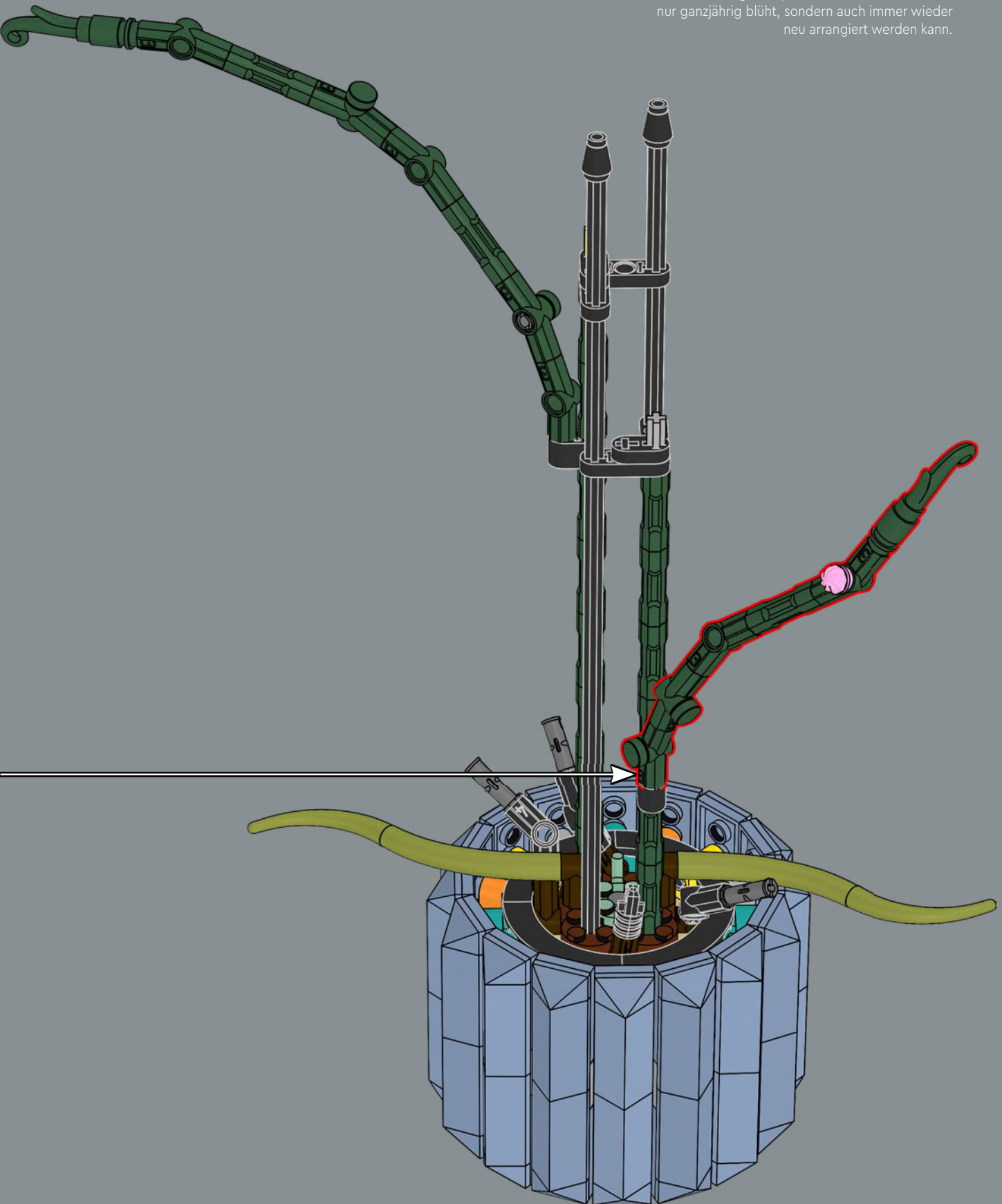

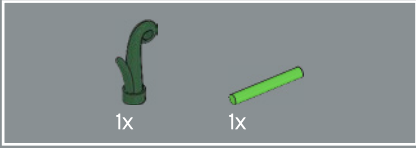
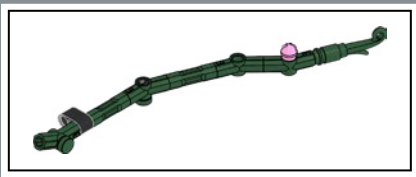

56

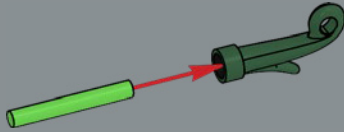

57

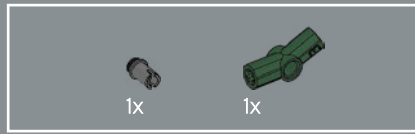
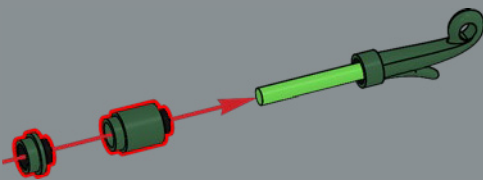

58

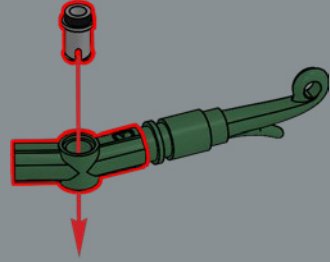

59

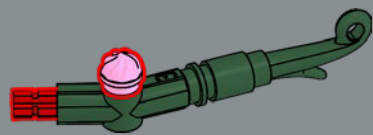

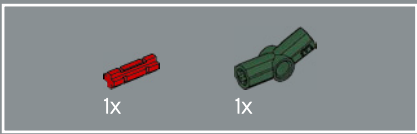

60

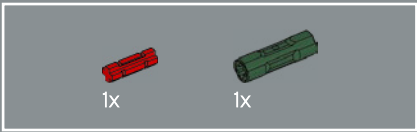
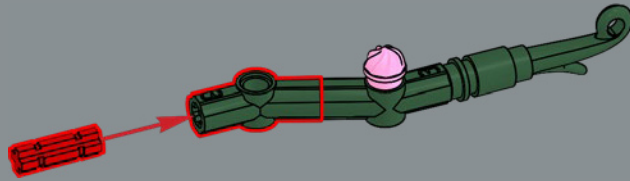

61

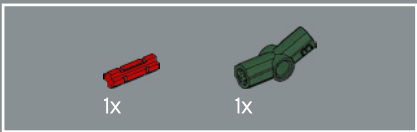
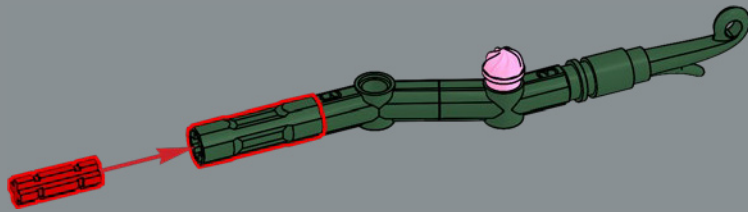

62

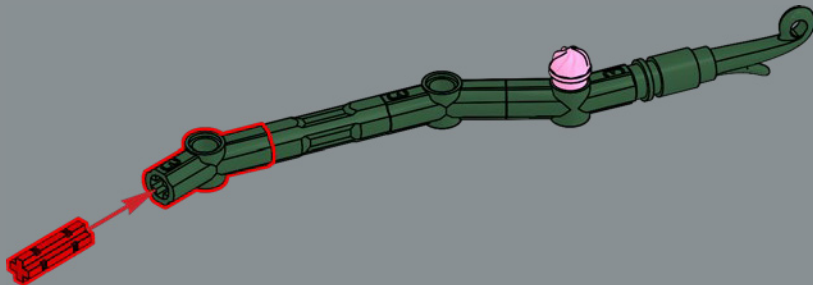

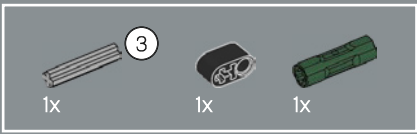

63

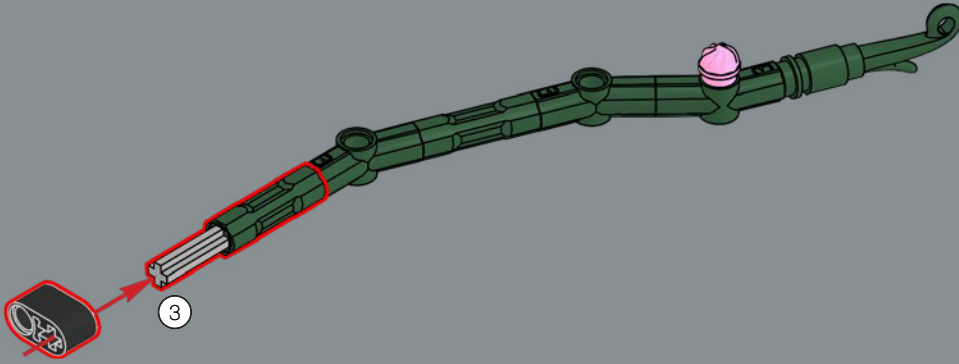

64

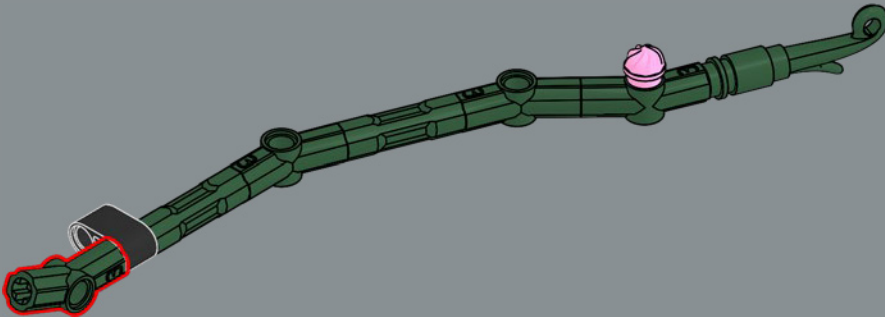

65

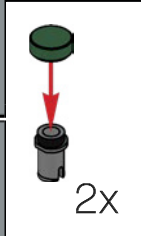
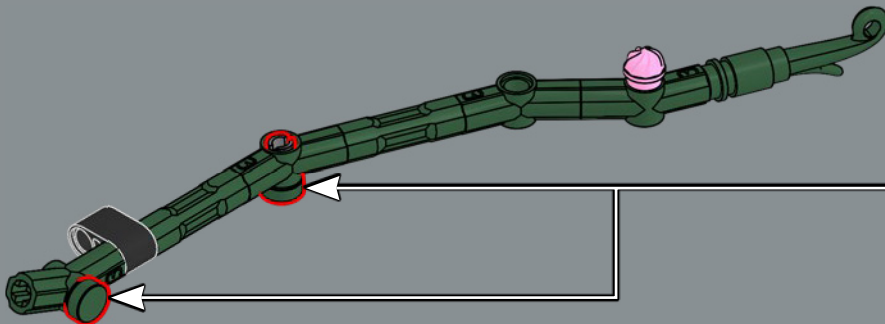

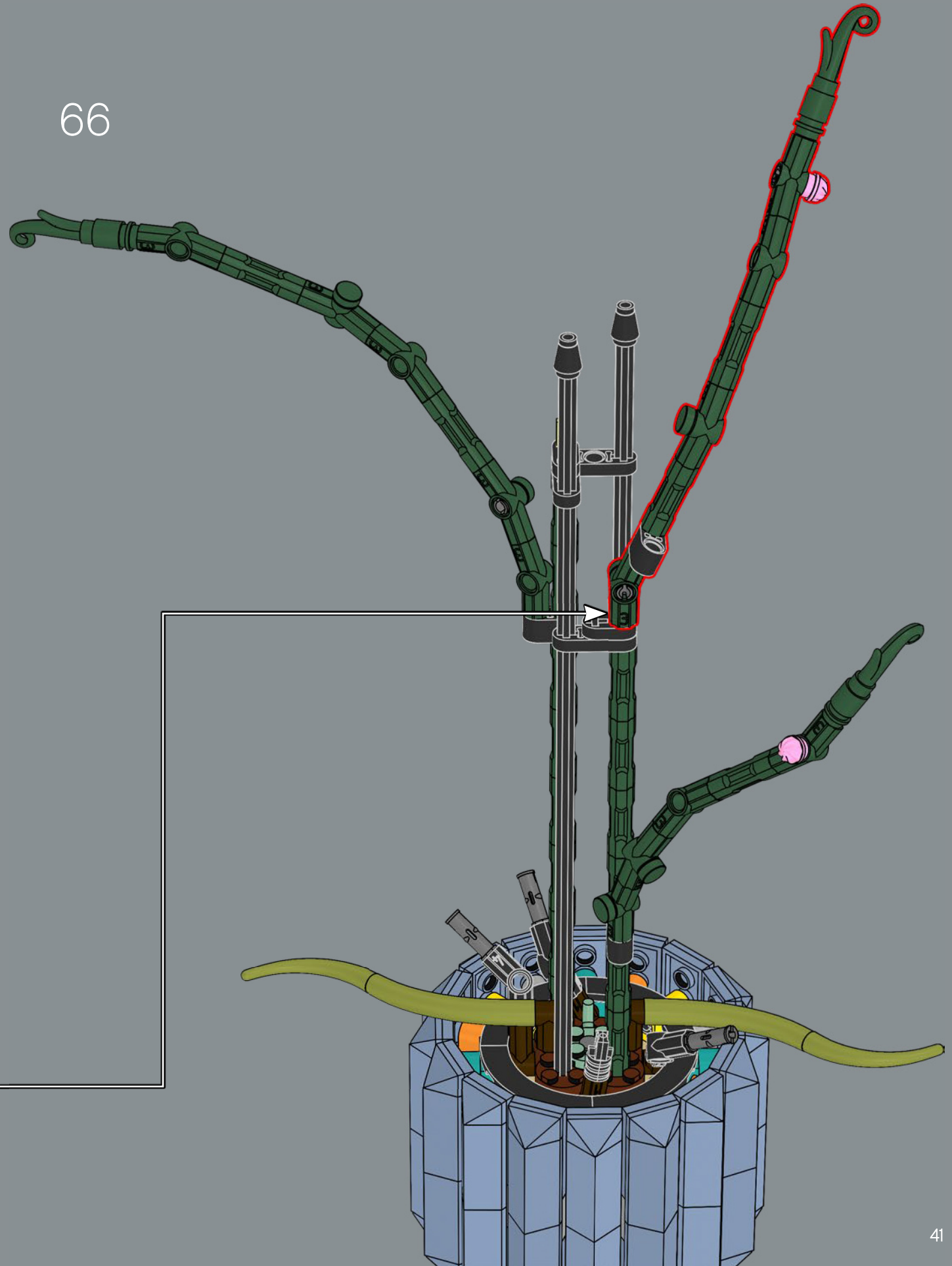

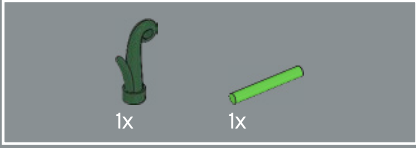
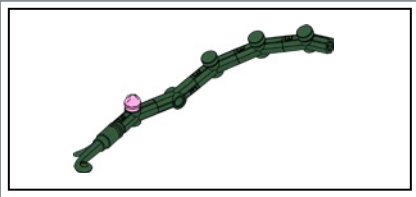

67

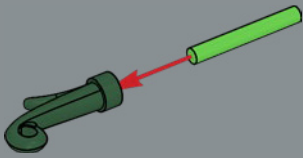

68

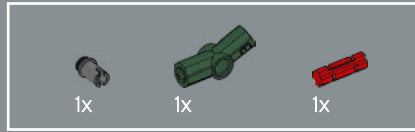
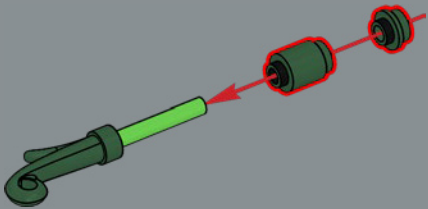

69

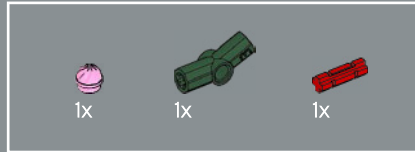
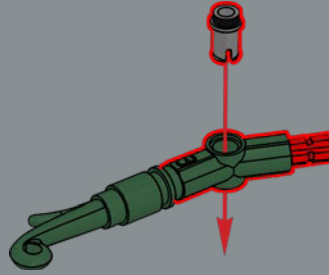

70

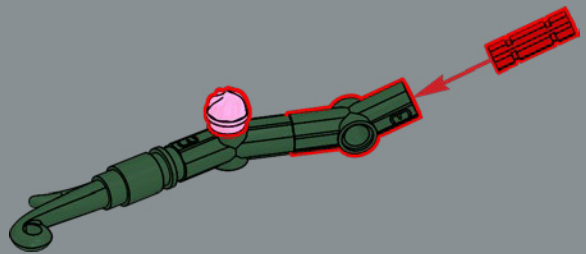

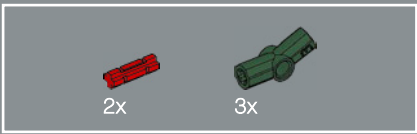

71

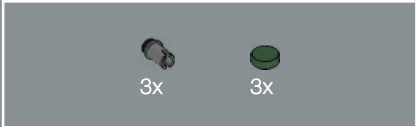
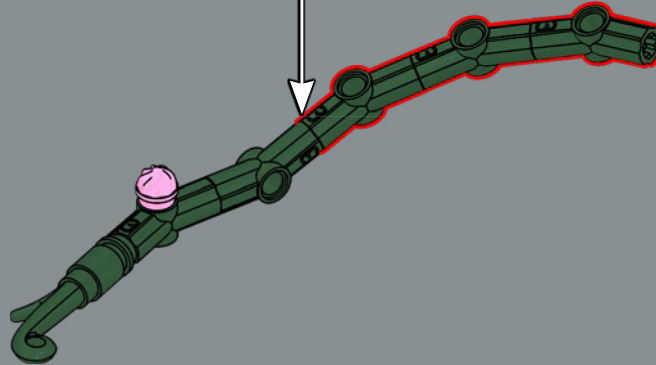
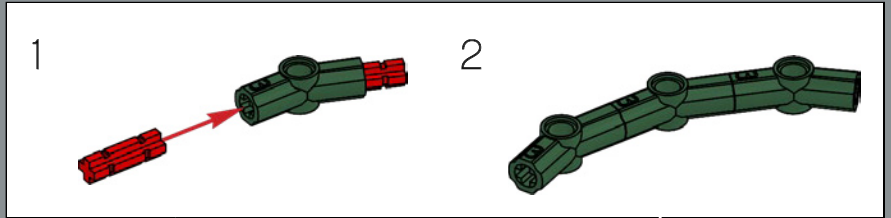

72

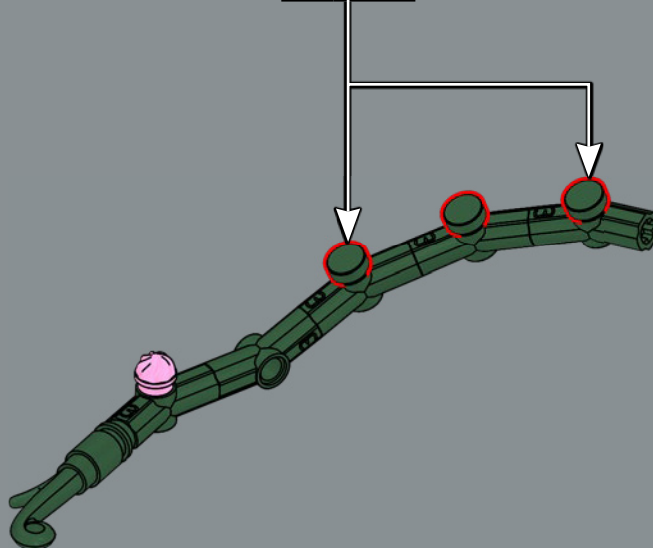
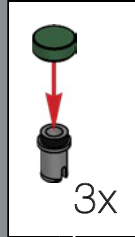

73

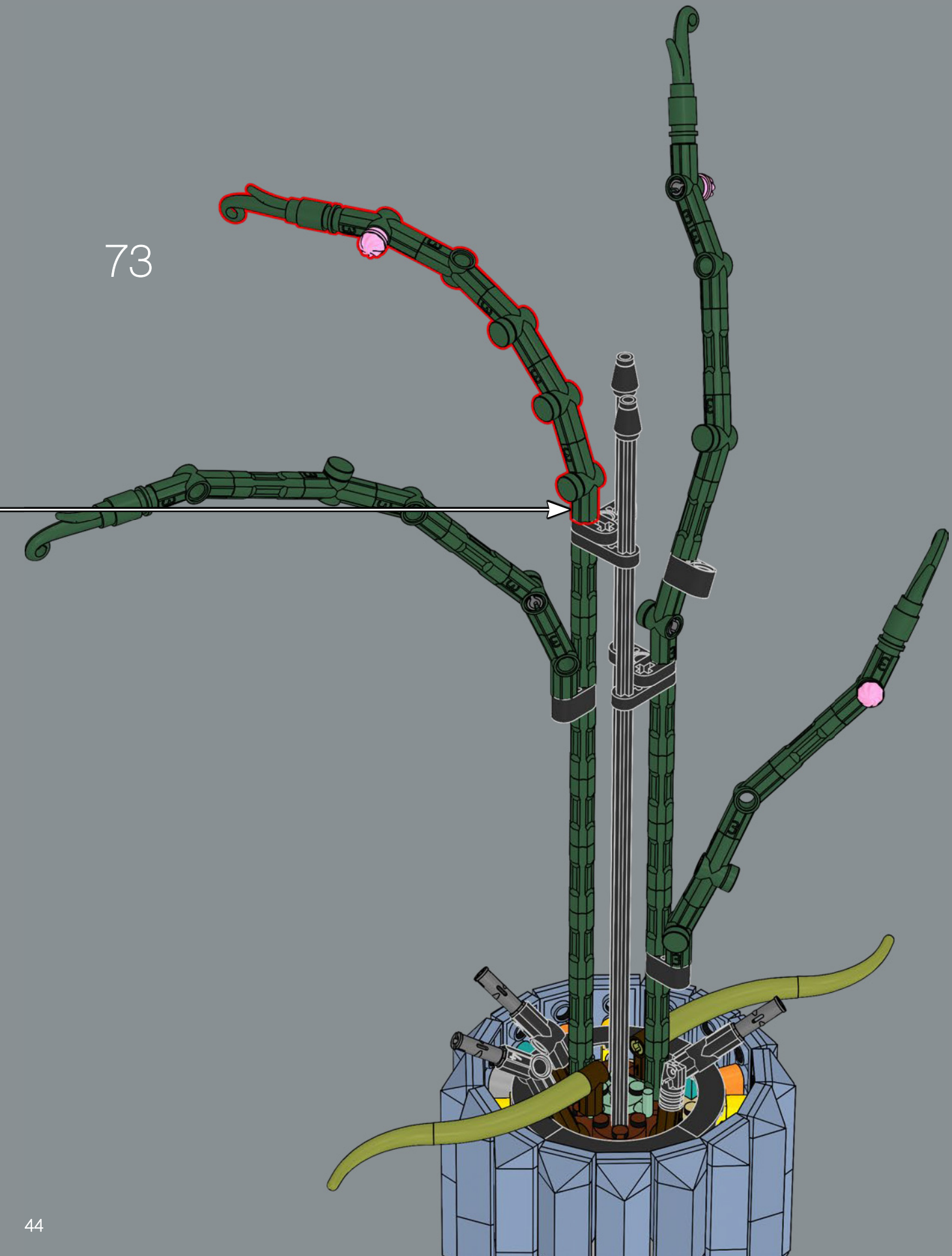

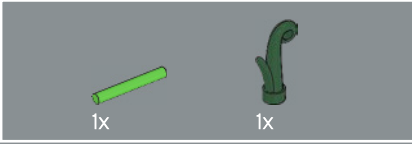
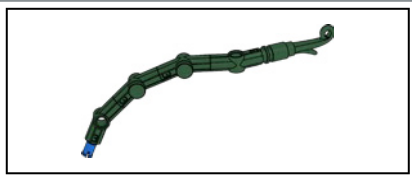

74

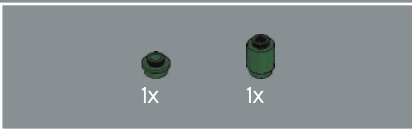
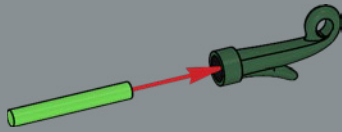

75

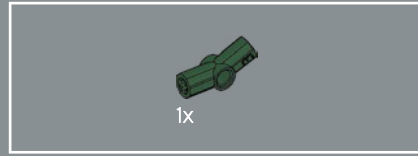
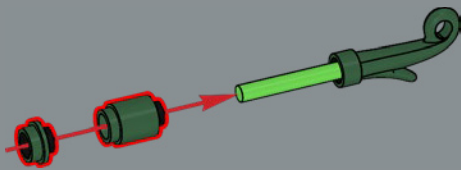

76

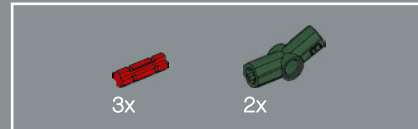
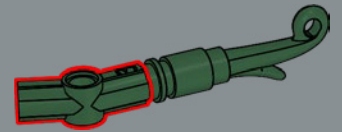

77

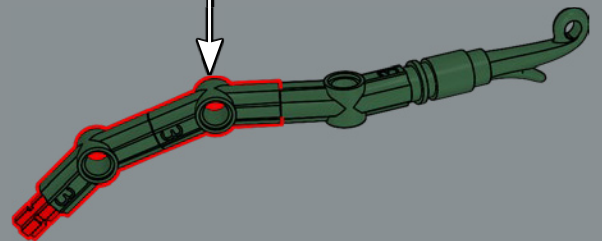
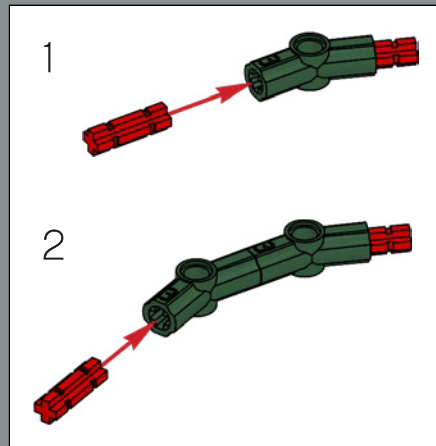

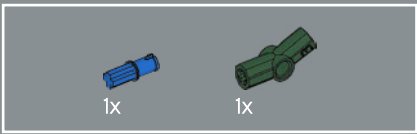

78

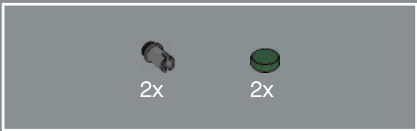
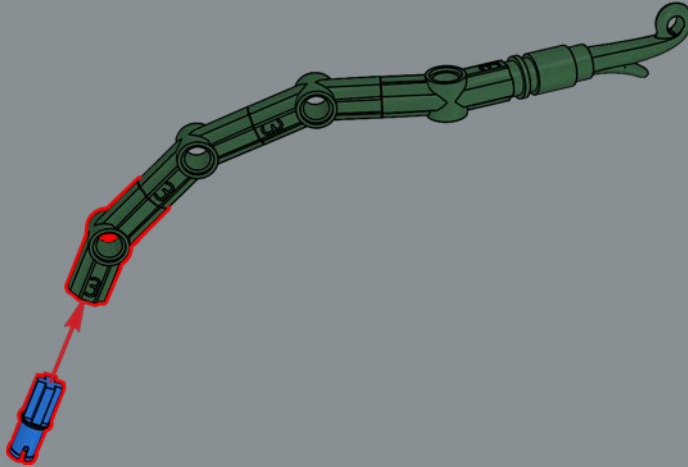

79

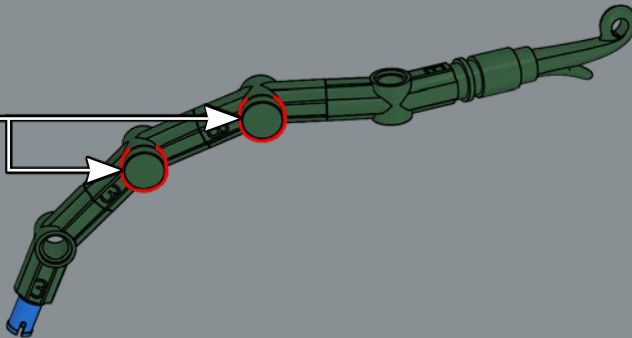
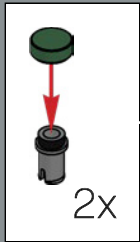

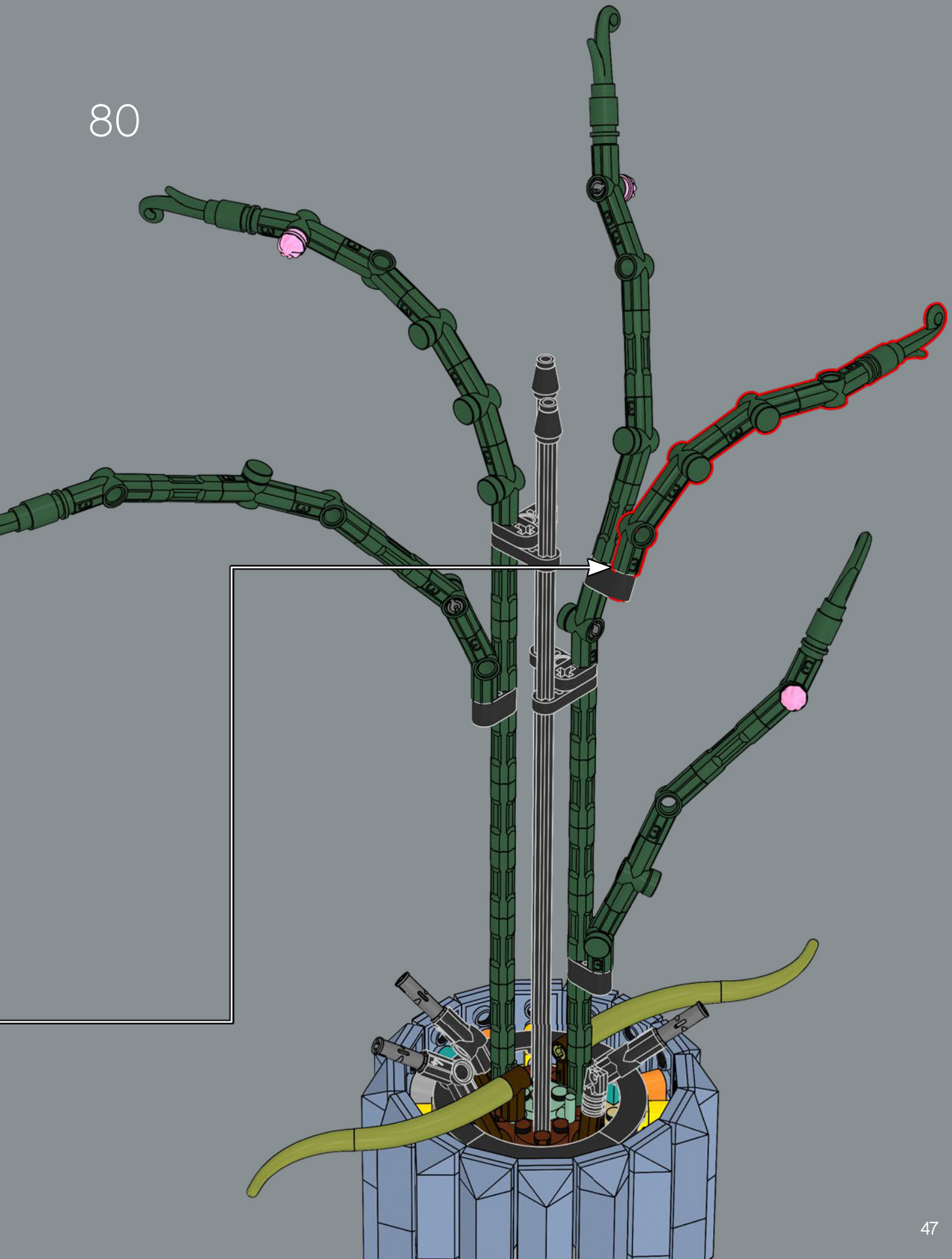



81

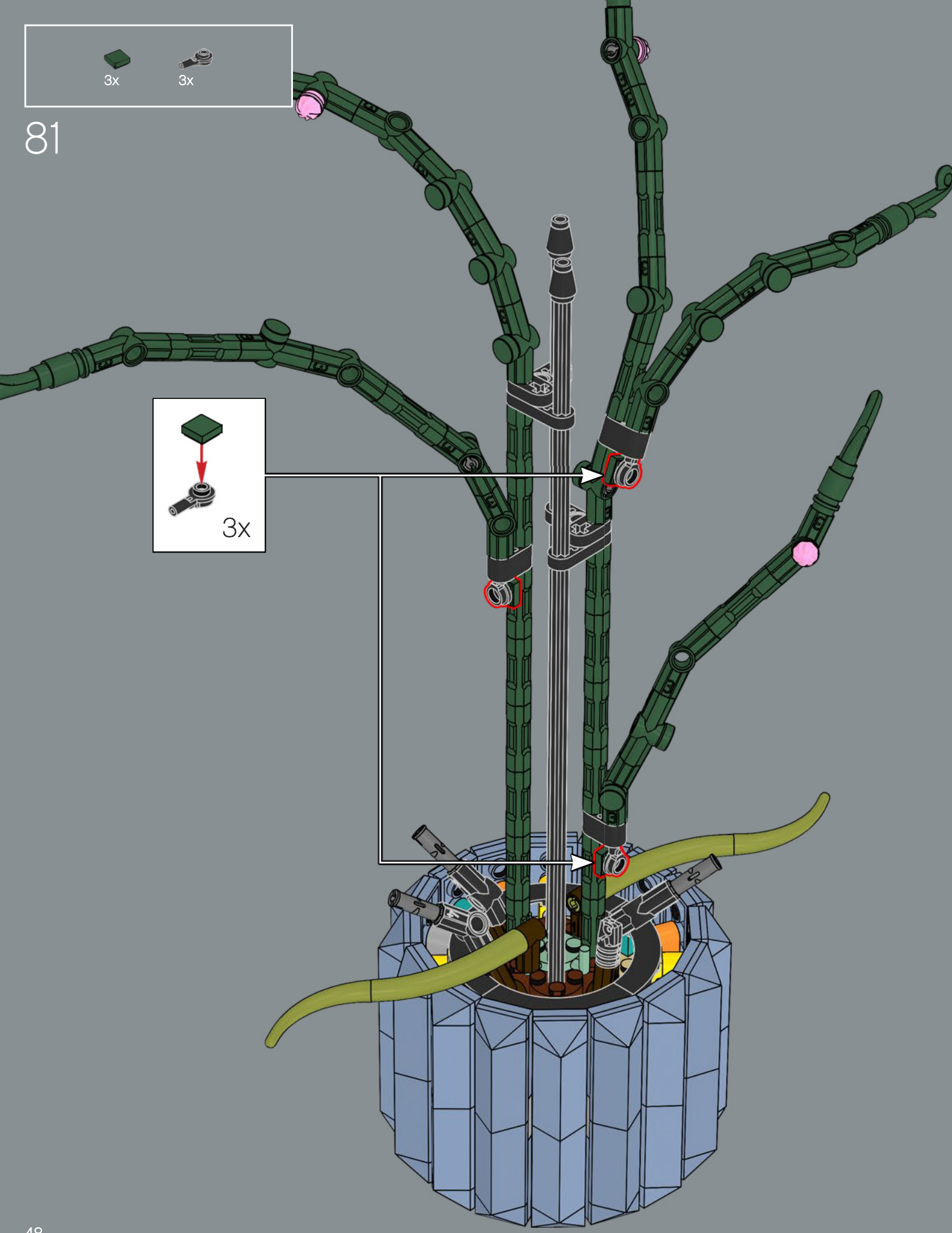
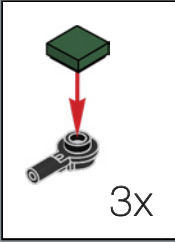

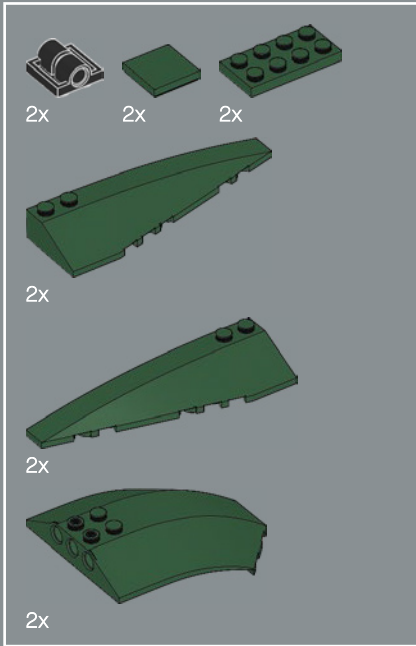
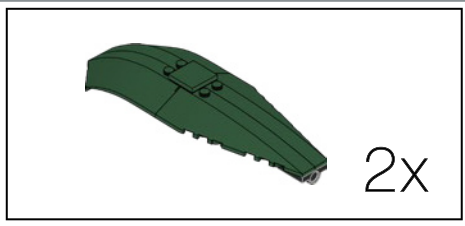

82

1

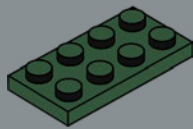

2

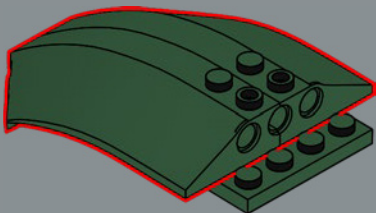

3

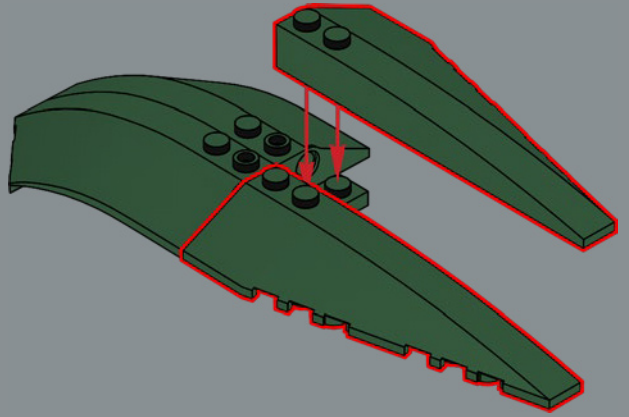

4

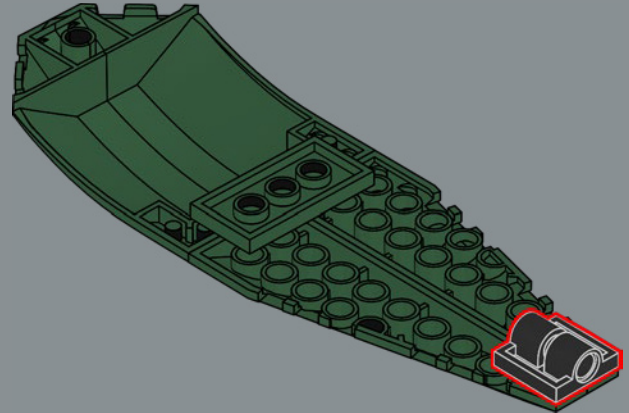

5

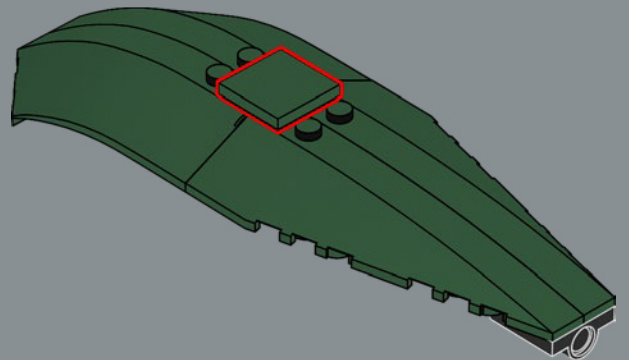

2x

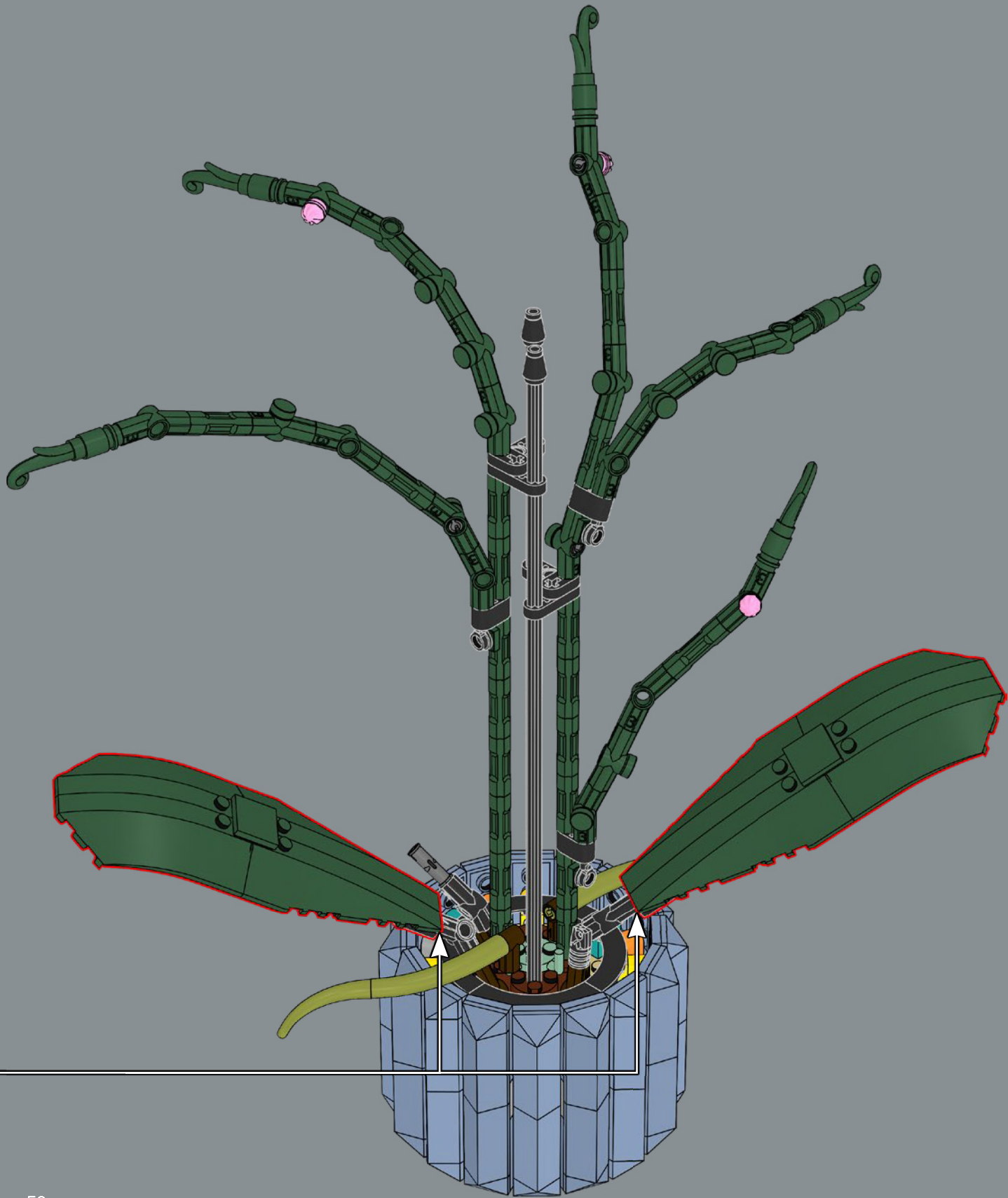

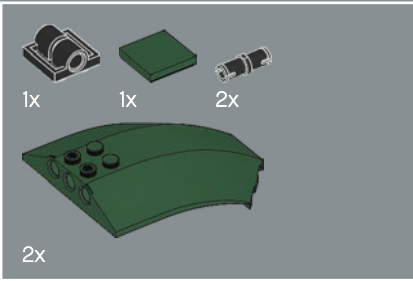
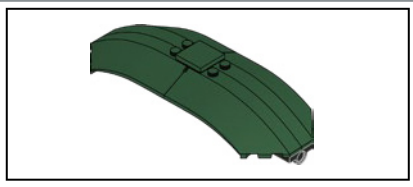

83

1

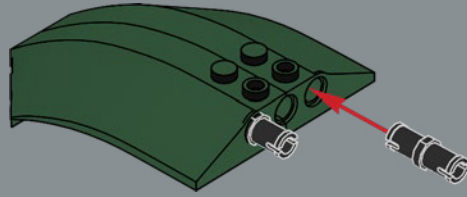

2

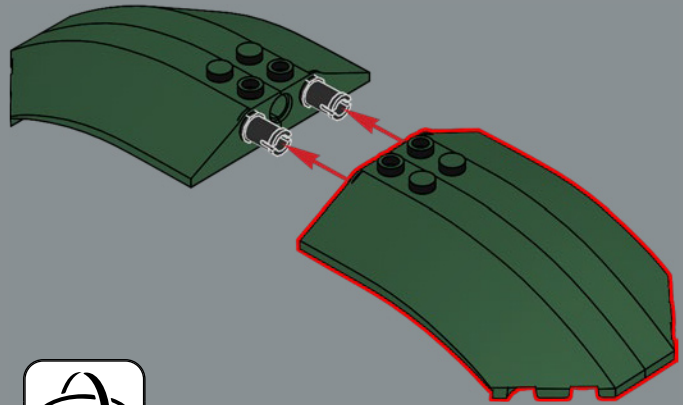

3

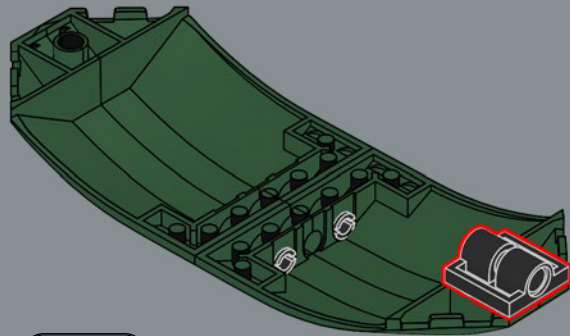

4

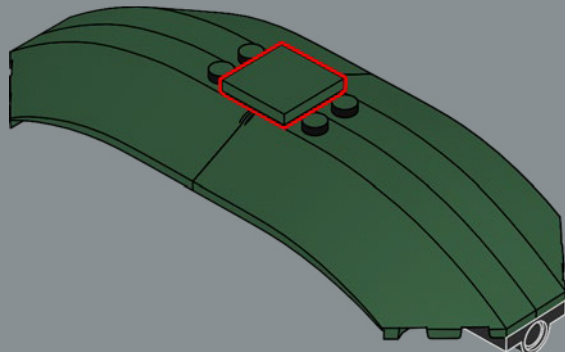

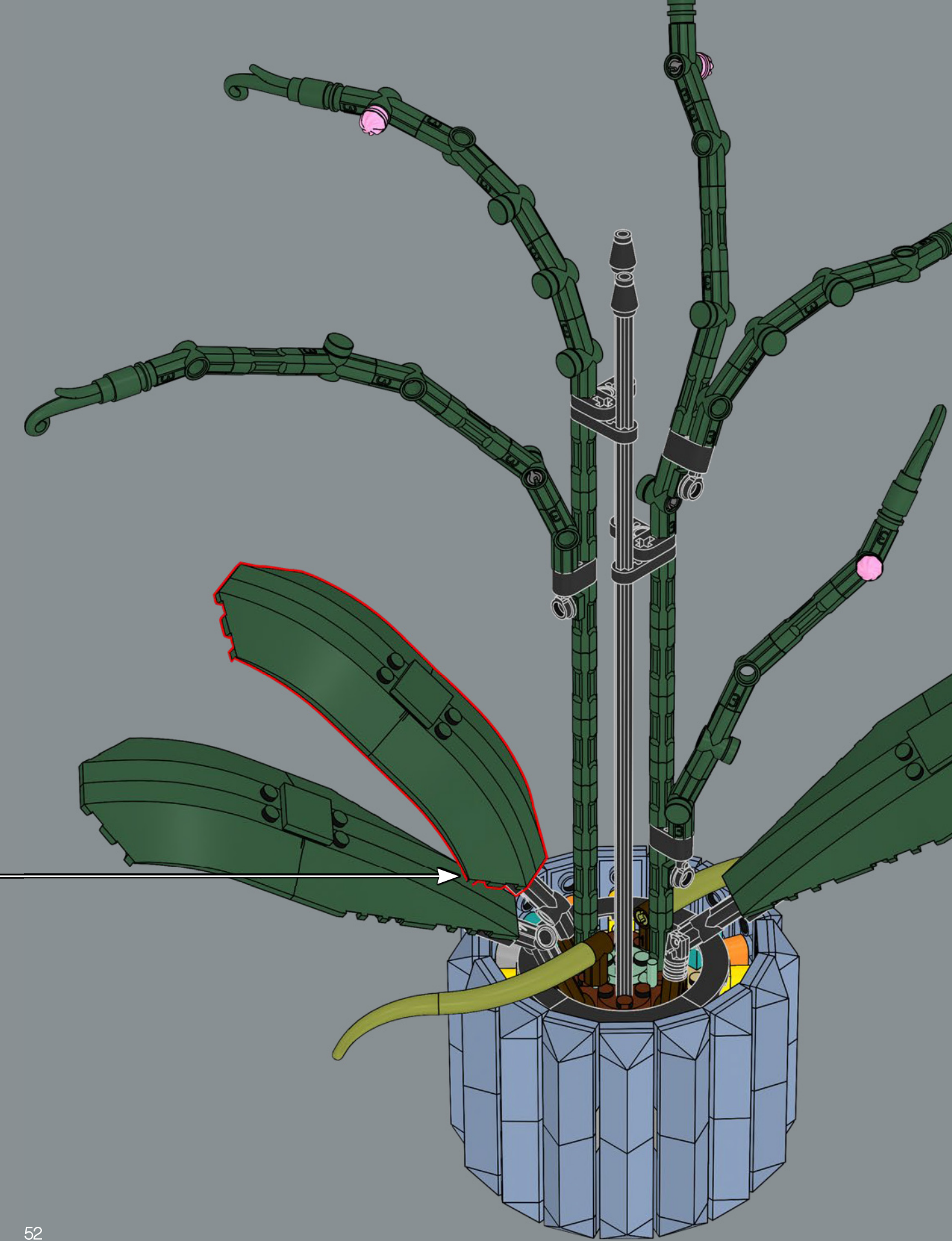

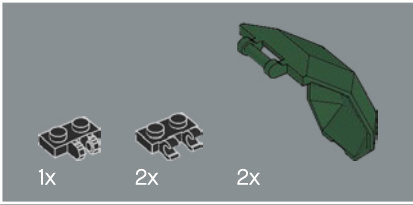

84

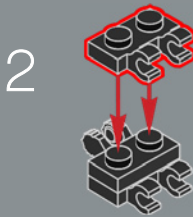
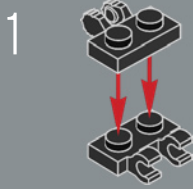

3

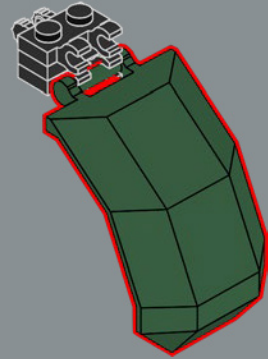

4

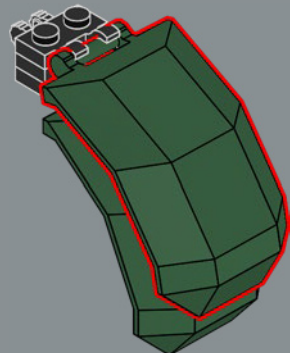

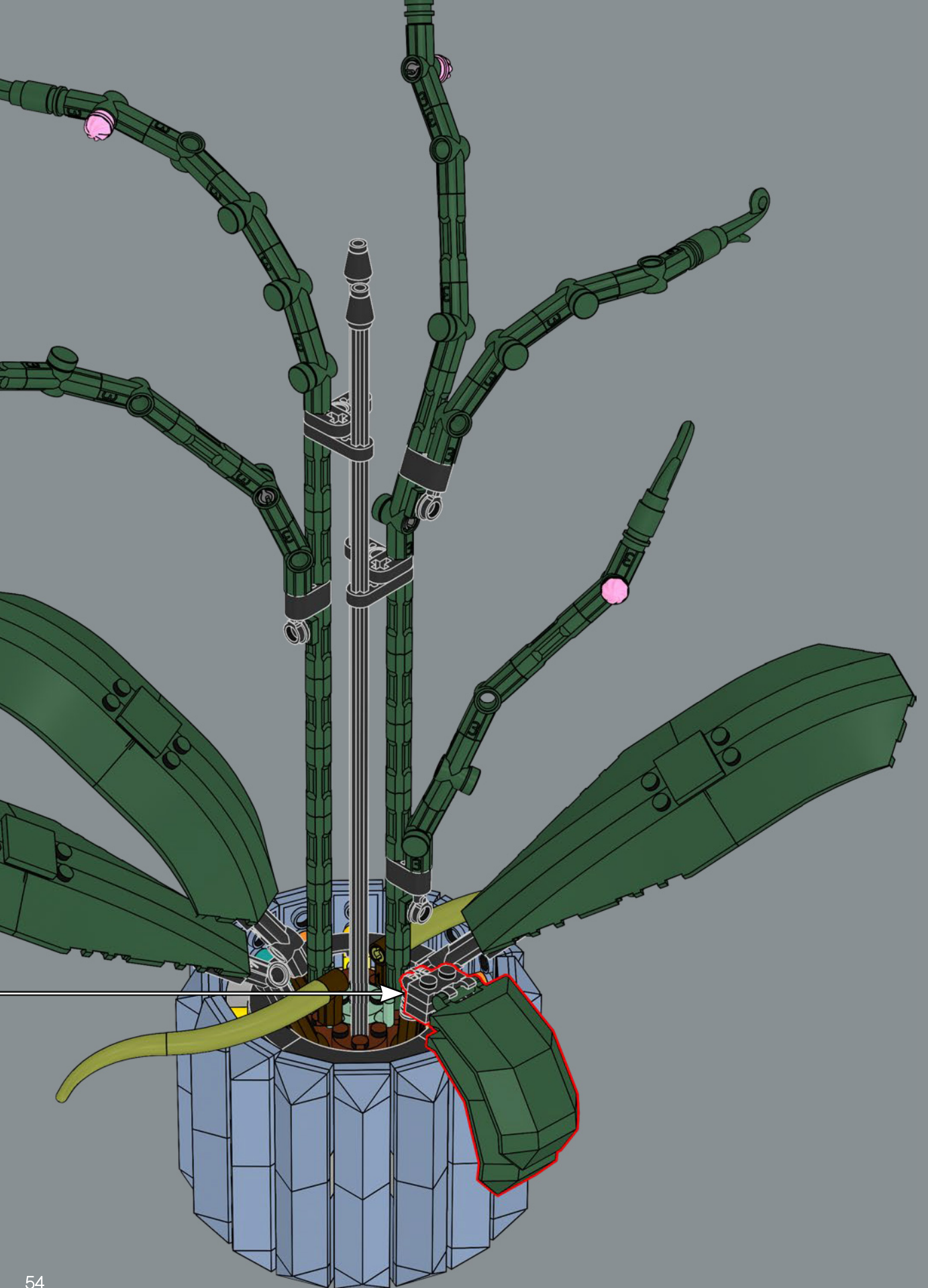



Demogorgon-Köpfe aus dem LEGO® Set zu „Stranger Things“ dienen als kleine Blüten an diesem Modell.





85

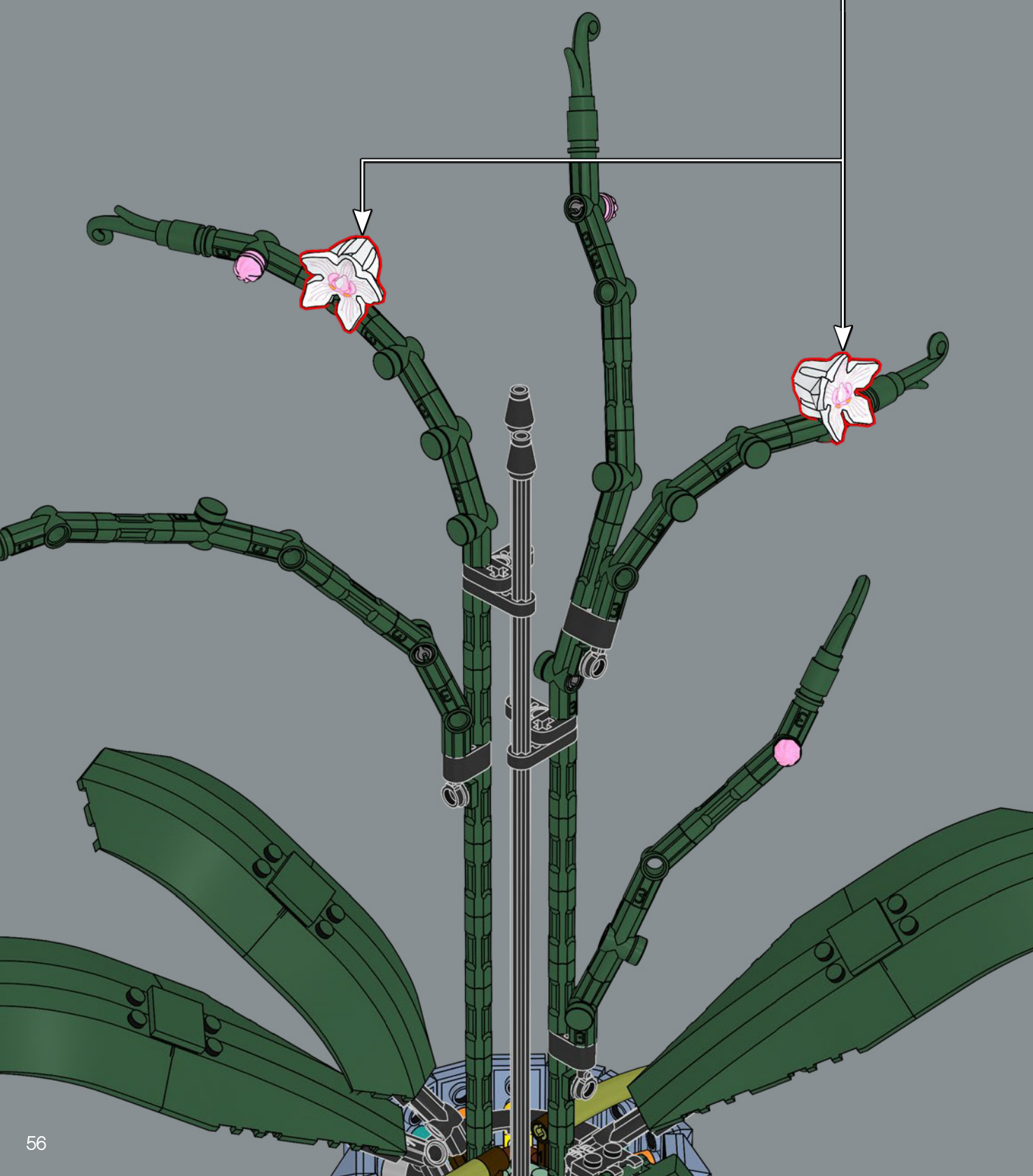
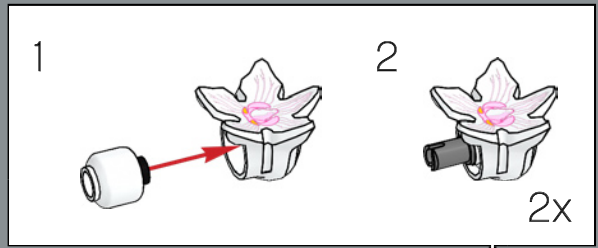

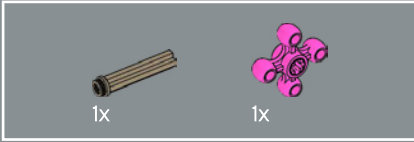

86

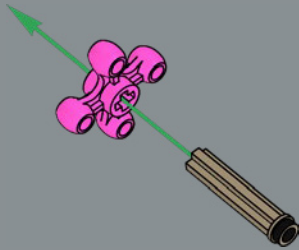

87

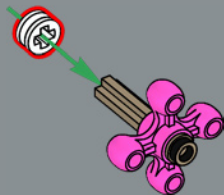

88

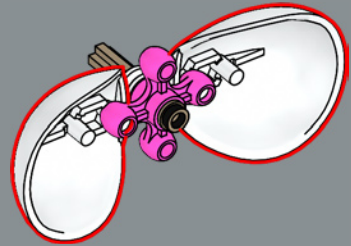

89

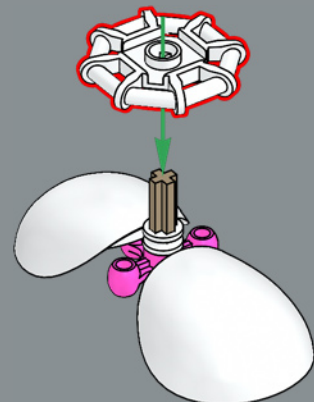

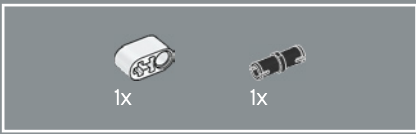

90

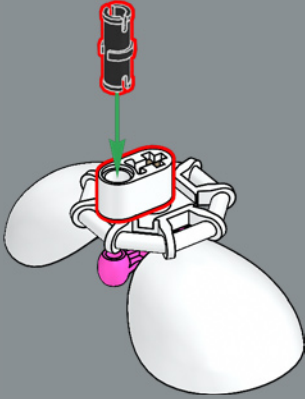

91

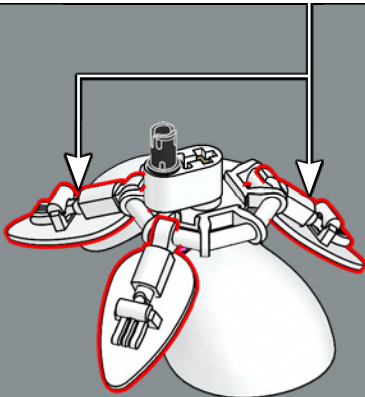
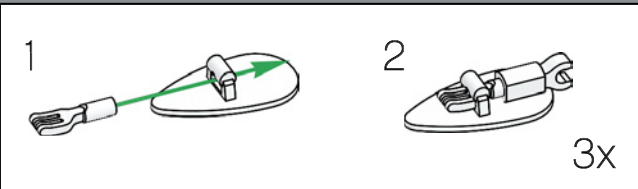

92

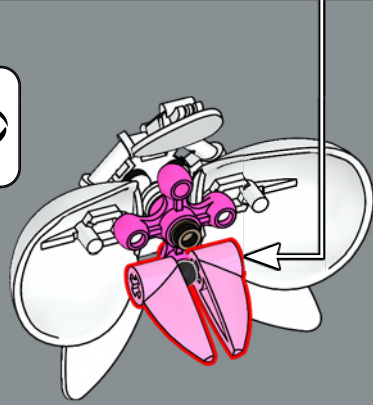
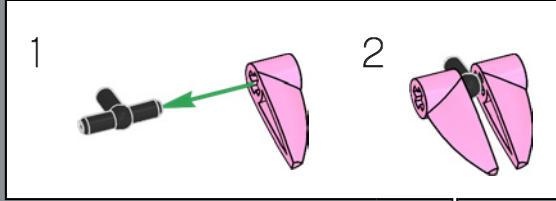

93

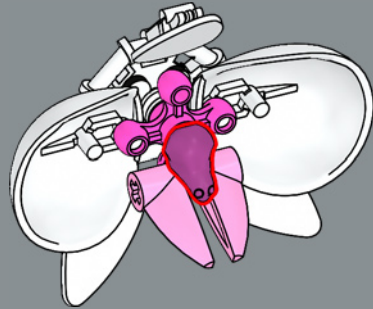

6x



In der Mitte der Blüten befinden sich LEGO® Frösche – eine Hommage an die rosafarbenen Frösche aus dem LEGO Set „Bonsai Baum“.

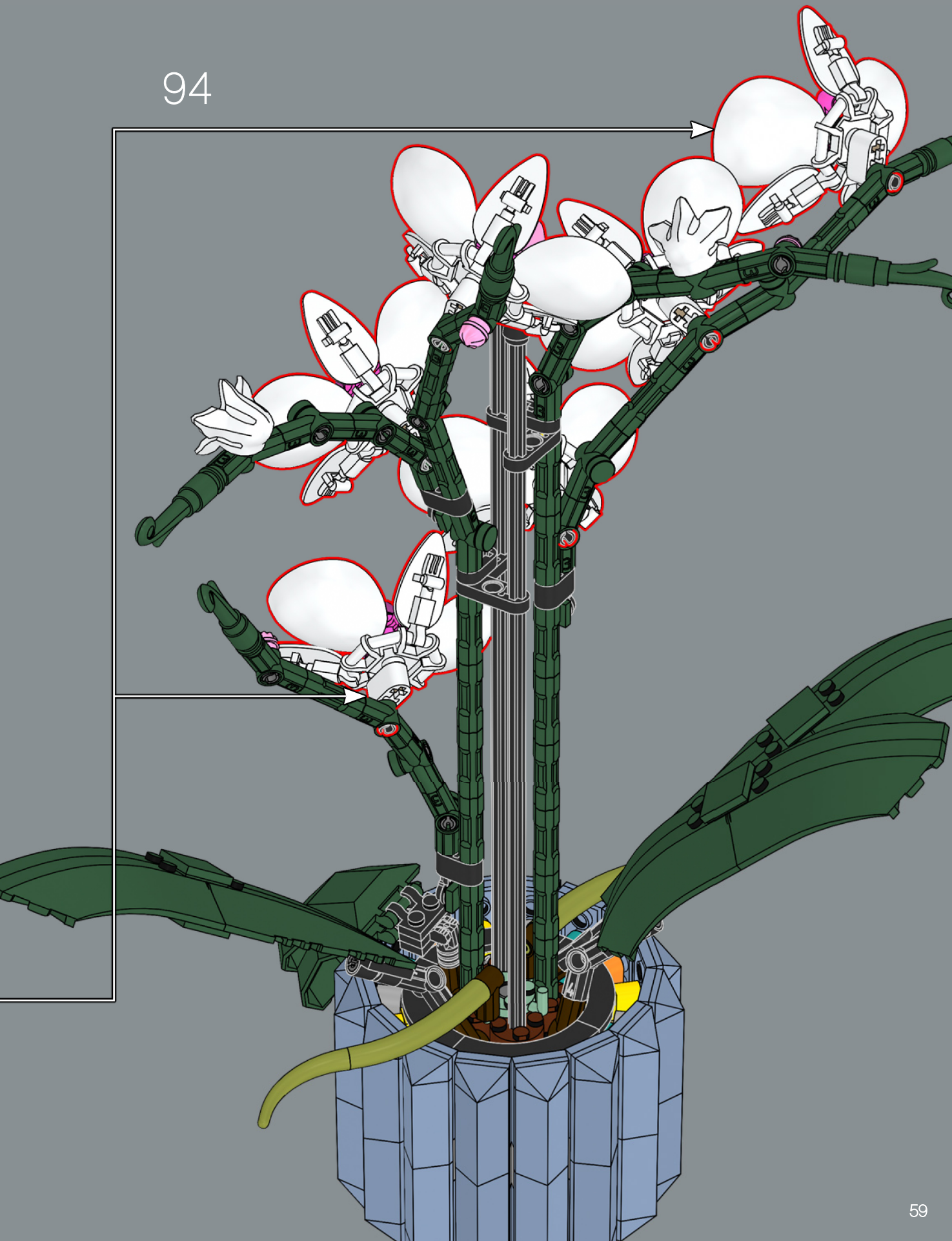



Minifiguren-Schilde, die ursprünglich für die LEGO® Burgen-Modelle aus dem Jahr 1995 entwickelt wurden, bilden die Kelchblätter der Blume.

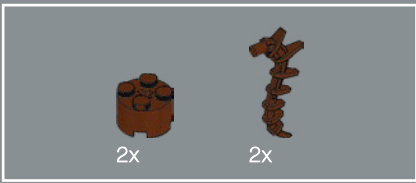

2x

2x

95

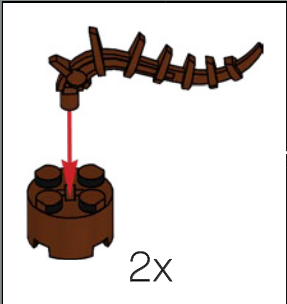
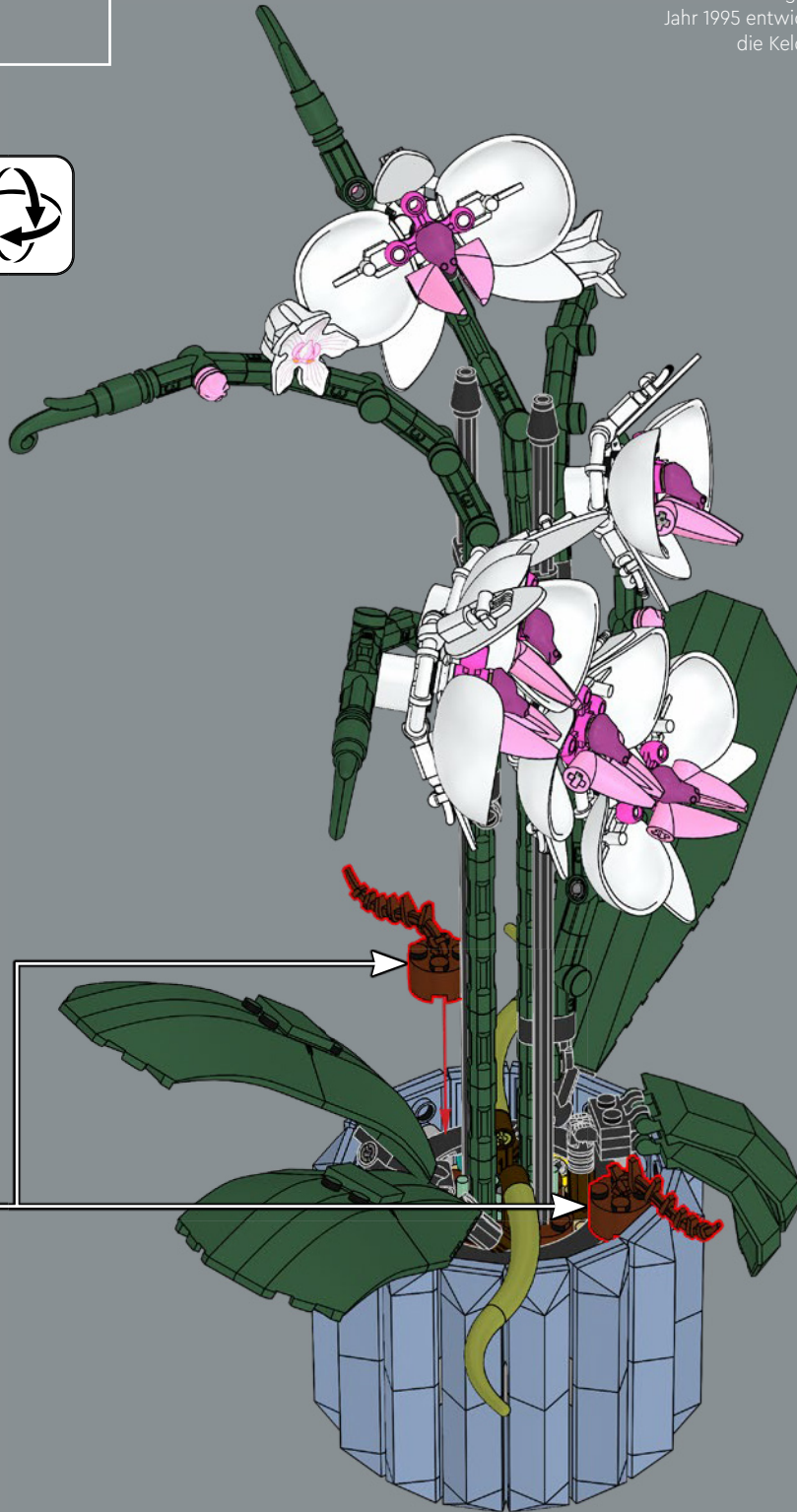

2x



Orchideen werden häufig in Rindenmulch eingetopft. So kann die Luft zirkulieren, das Wasser läuft ab und die Wurzeln faulen nicht. Der Rindenmulch bei diesem Modell wird mit Klauen aus den LEGO® NEXO KNIGHTS™ Sets dargestellt.



96





1x
4558956



6x
6265135



6x
6009016



8x
6195358



2x
362601



2x
6302214



18x
6395857



18x
6395620



12x
6390377



18x
6341465



6x
6360263



4x
6378358



3x
4206482



8x
6299413



8x
654124



4x
4495934



3x
6130007



2x
4529236



3x
6265091



3x
6196548



1x
6266207



2x
6310268



3x
281726



8x
6171264



2x
6338428



2x
6271810



1x
6265699



24x
6279875



3x
6262897

7

3

7

7



6x
6104209



2x
403228



5x
6161772



8x
6136553

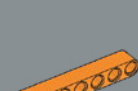

4x
6339024



2x
6030521



1x
6240515



8x
6345402

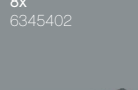

4x
6323477



8x
6325515



32x
6392959



32x
6395798



32x
6248957



32x
6248957

3.2



6x
6031821



5x
6253282

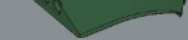

4x
6392976



2x
6392970



2x
6392971



3x
6055171



3x
4528778



2x
4586057

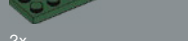

11x
6397157



5x
6230571



5x
6396754



2x
6392972



22x
6344177



19x
6330196



1x
6329274



6x
6395622

8x

4211535



4x
4495930



16x
6276848



2x
4211815



3x
6045718



16x
6395635



3x
6015356



1x
4499858



6x
6380668



3x
6060795



12x
6395623



2x
6313597



32x
6378120



37x
4142865



6x
6395622



6x
6395622

7

3

8



6x
4211166



6x
6075213



2x
6270052



7x
6251403



7x
6353396



6x
6332586



2x
6351430



2x
6351434



2x
6351434



2x
6351434



2x
6351434



2x
6351434



2x
6351434



2x
6351434



2x
6351434



2x
6351434



2x
6351434



2x
6351434



2x
6351434



2x
6351434



2x
6351434



Customer Service

Kundenservice

Service Consommateurs

Servicio Al Consumidor

LEGO.com/service or dial



00800 5346 5555 :



1-800-422-5346 :



2x
6210821

32



FEEDBACK AND WIN

FEEDBACK AND WIN

Your feedback will help shape the future development of this product series.

Please visit:

FEEDBACK UND GEWINNEN

Dein Feedback trägt zur Weiterentwicklung dieser Produktreihe bei.

Geh auf:

COMMENTEZ ET GAGNEZ

Vos commentaires nous aideront à concevoir les futurs produits de cette gamme.

Rendez-vous sur :

COMENTA Y GANA

Tu opinión nos ayudará a dar forma al desarrollo de esta serie de productos en el futuro.

Visita:

反馈有奖

您的反馈将有助于我们在今后改进本系列产品。

请访问：

[LEGO.com/productfeedback](https://www.lego.com/productfeedback)

By completing, you will automatically enter a drawing to win a LEGO® set.

Terms & Conditions apply.

Durch Ausfüllen nimmst du automatisch an der Verlosung eines LEGO® Preises teil.

Es gelten die Teilnahmebedingungen.

En envoyant vos commentaires, vous serez automatiquement inscrit(e) à un tirage au sort qui vous permettra de remporter un prix LEGO®.

Offre soumise à conditions.

Al contestar, participarás automáticamente en el sorteo y podrás ganar un set LEGO®.

Sujeto a Términos y Condiciones.

完成我们的反馈调查，即可自动进入抽奖环节，赢取乐高®套装。

适用《条款和条件》。

