

libretto 1



## Piante grasse LEGO®

Alcune hanno le spine, eppure sono adorabili: Altre sono paffutelle eppure molto eleganti. I guru del design dicono che sono perfette per rallegrare ogni angolo della casa. E sono le piante d'appartamento ideali, di cui persino un principiante può prendersi cura. Vi presentiamo le Piante grasse LEGO®.

Le piante grasse, il cui nome corretto è piante succulente, sono favolosi centrotavola, perfette sui davanzali delle finestre e in grado di trasformare ogni ambiente in una cartolina da Instagram.



Si dice che avere delle  
piante grasse in casa aiuti a  
concentrarsi, e ci auguriamo  
che la costruzione di questo set  
abbia lo stesso effetto! E poi non  
bisogna annaffiarle!

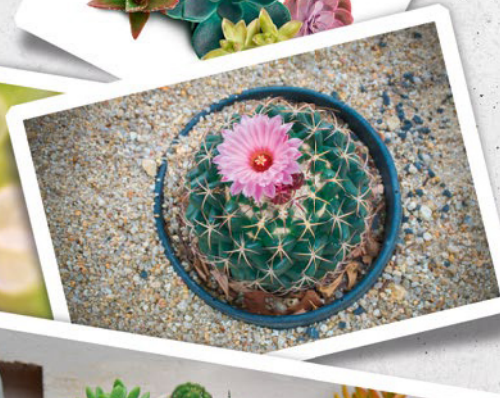



*Costruiscite vaso dopo  
vaso, o raggruppale  
tutte insieme... non  
riuscirai a smettere di  
sorridere!*

## **Una pianta grassa per tutti**

A differenza di altre piante della serie LEGO® Botanical, ogni pianta grassa LEGO può essere costruita nel suo piccolo vaso individuale e tutti i vasi possono essere quindi collegati per formare un bell'insieme o può essere messo in mostra separatamente. Le istruzioni per la costruzione sono contenute in libretti separati, in modo che familiari e amici possano cimentarsi insieme con l'esperienza di costruzione LEGO.

## Il Design Team

Andy è originario della California meridionale, dove i giardini di piante grasse prosperano e sono famosi per la loro bellezza. "I miei amici sono tutti esperti coltivatori di questi gioielli del deserto mentre io, invece, non ho mai avuto questa fortuna. Quindi, poter progettare questo set LEGO® è stato davvero un sogno diventato realtà. Nessuna pianta grassa è stata maltrattata nella realizzazione di questo set!" ha affermato Andy, una cosa che non si sarebbe mai aspettato di dire!

*Anderson Ward Grubb*  
*Senior Designer*



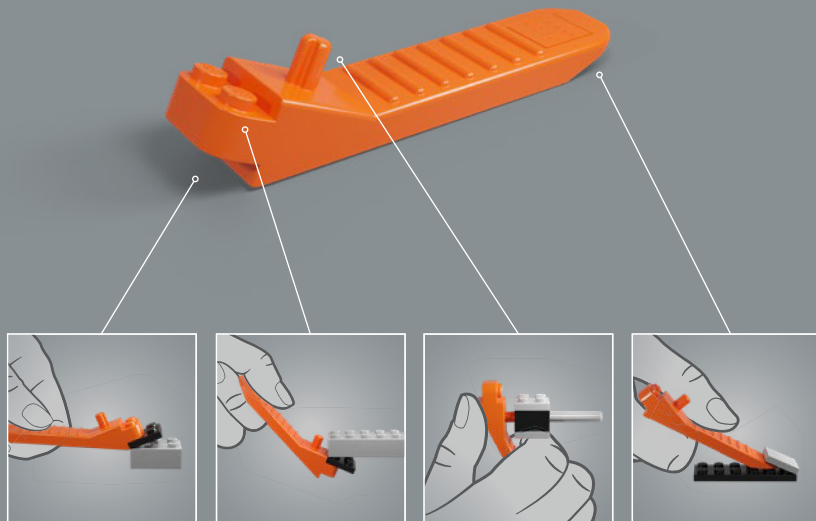



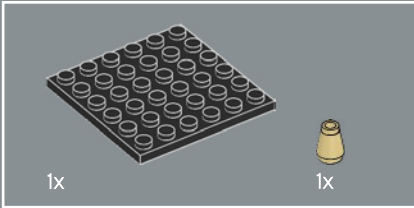
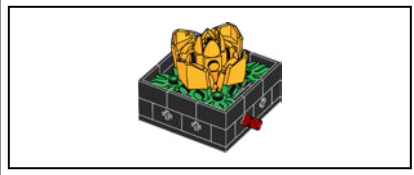

1

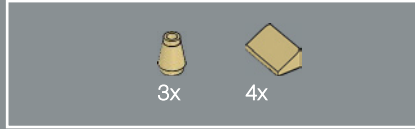
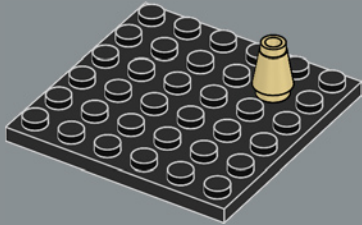

2

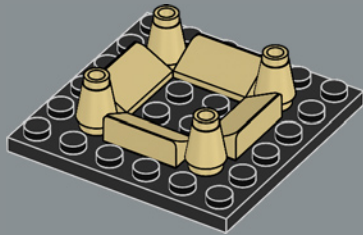



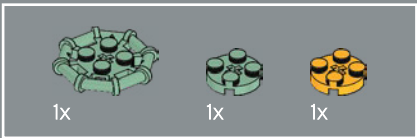

3

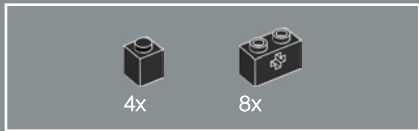
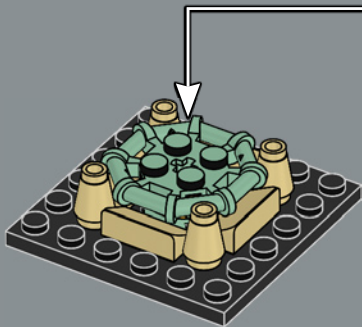
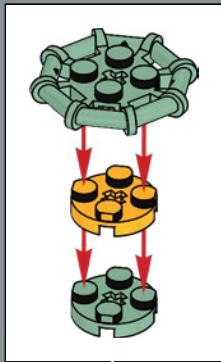

4

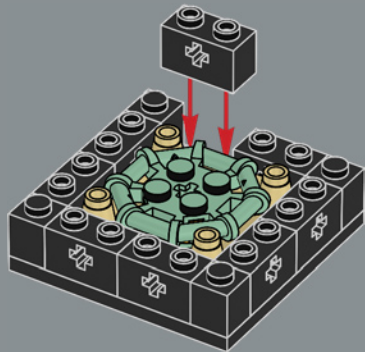

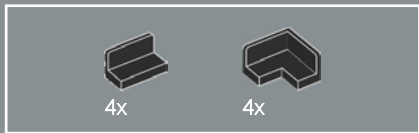

5

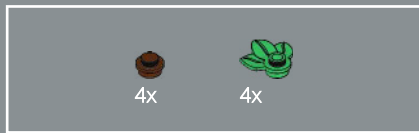
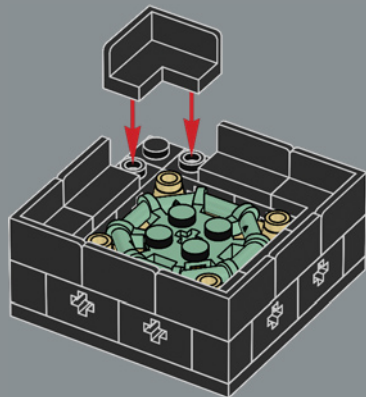

6

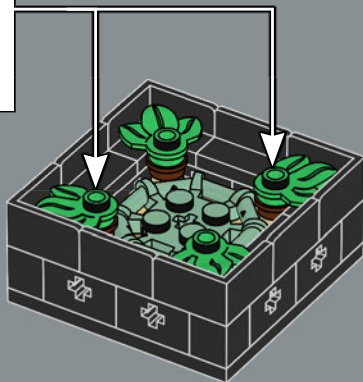
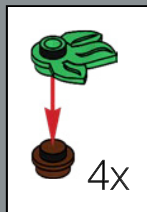

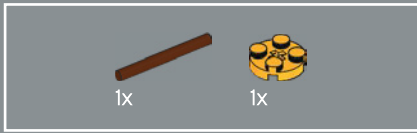

7

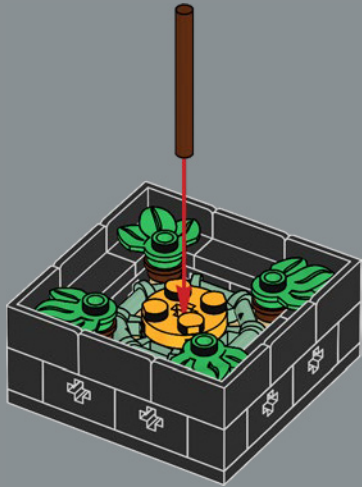

8

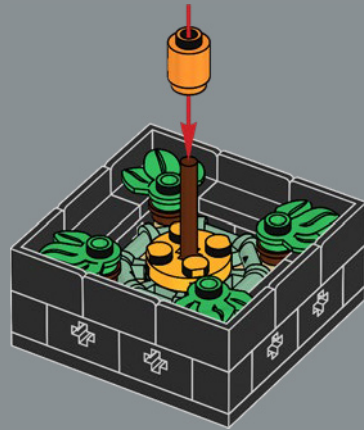



9

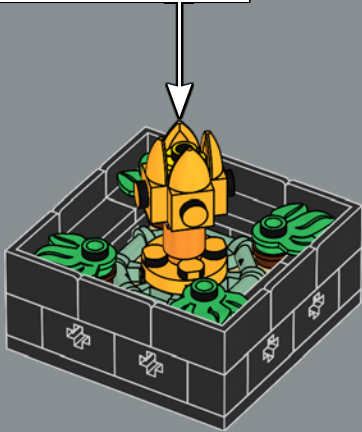
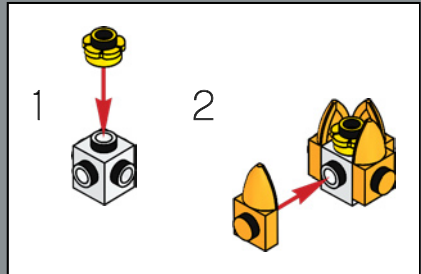

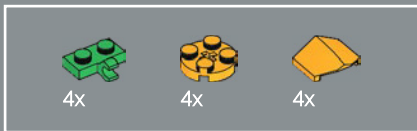

10

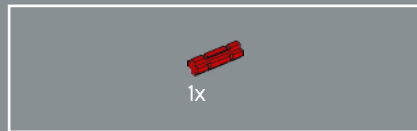
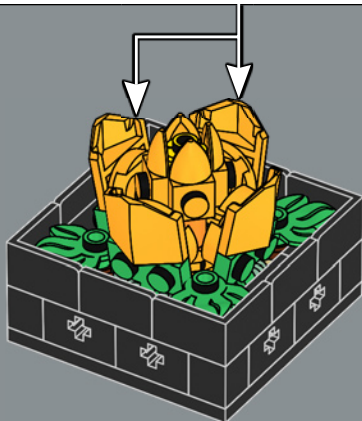
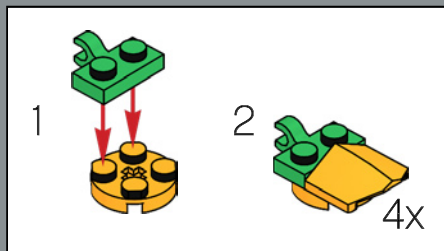

11

*Echeveria agavoides*  
Questa pianta grassa presenta adorabili foglie  
in varie tonalità di verde e arancio.

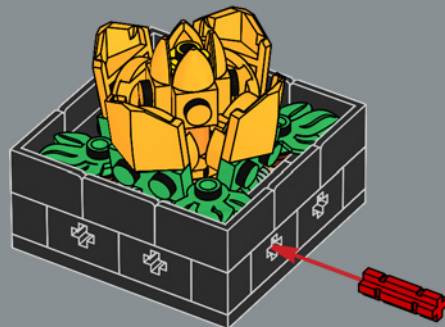

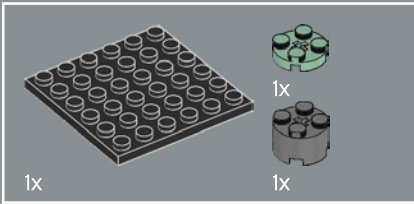
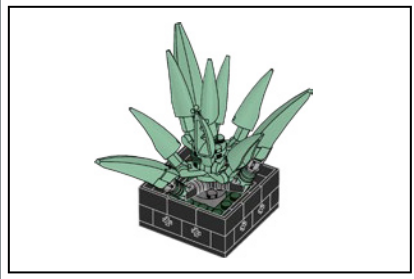

1

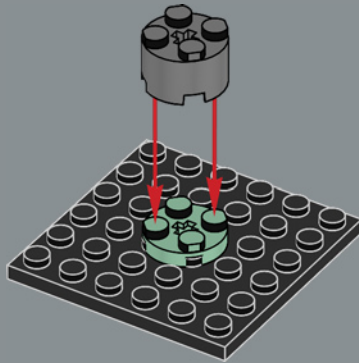

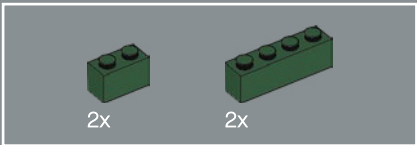

2

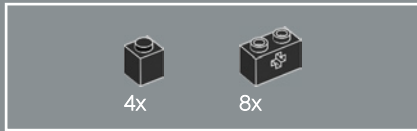
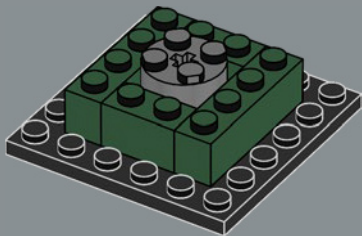

3

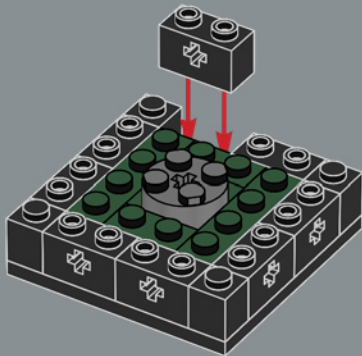

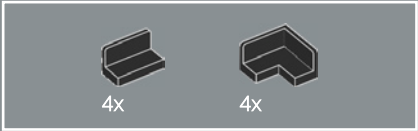

4

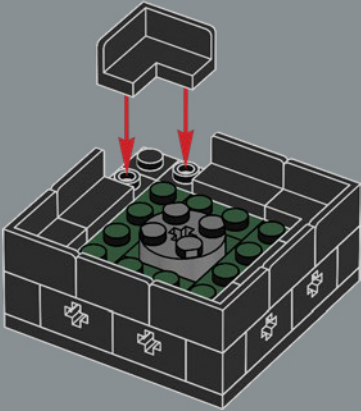





5

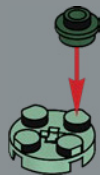

6



7

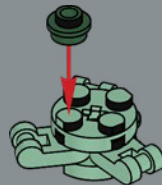



8



9



18

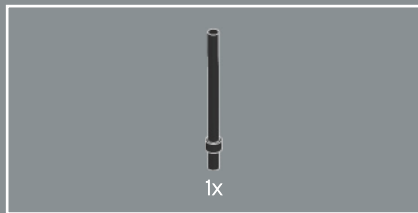

10

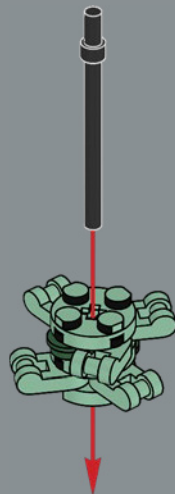

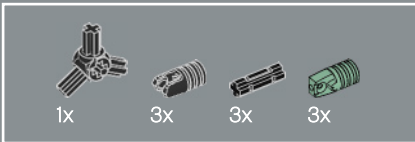

11

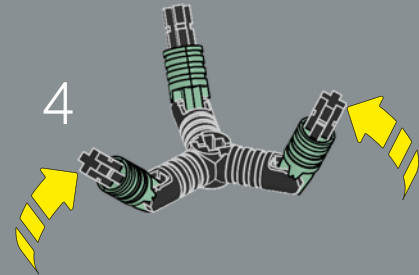
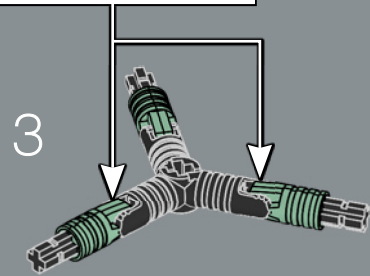
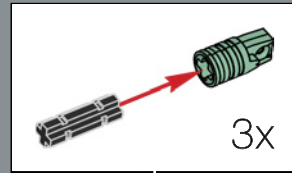
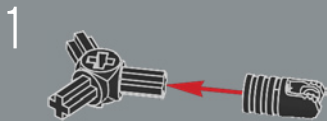

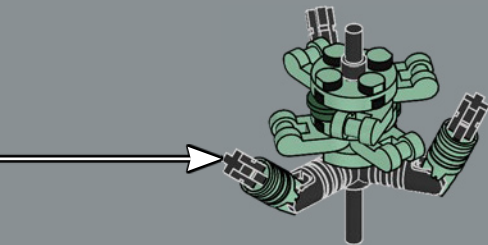

12

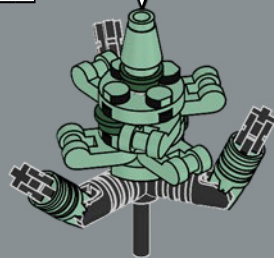
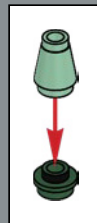

13

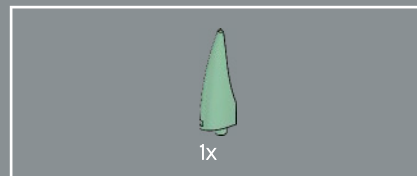
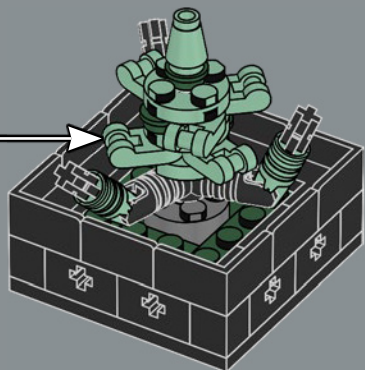

14

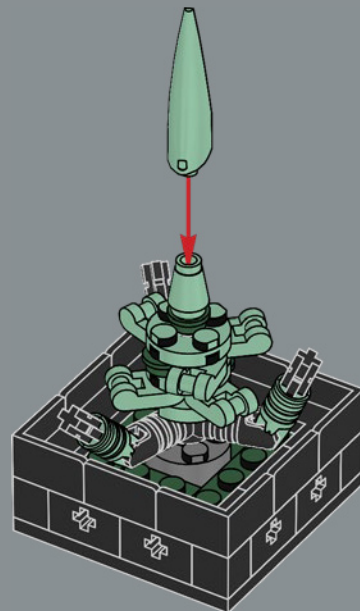

Artigli per le succulente.  
Gli artigli LEGO® di creature fantastiche  
compongono ora la spinosa Aloe.

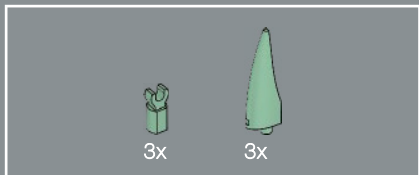

15

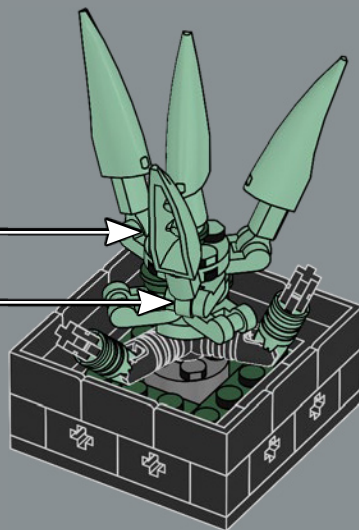
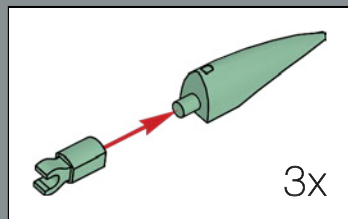

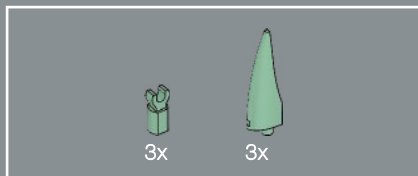

16

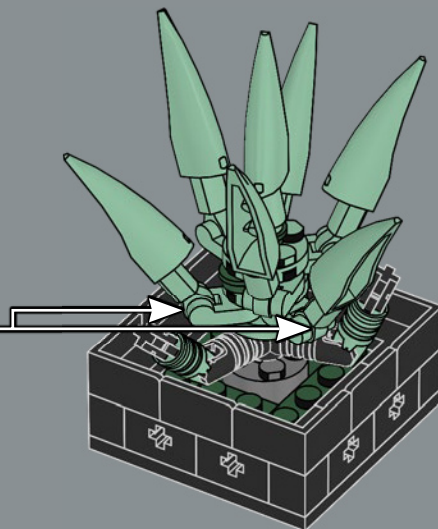
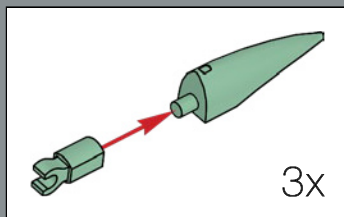

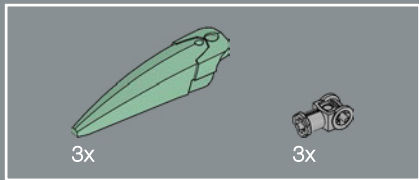

17

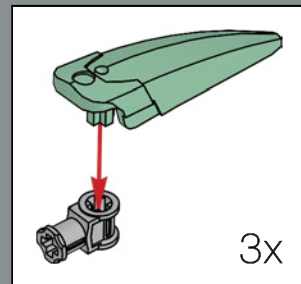
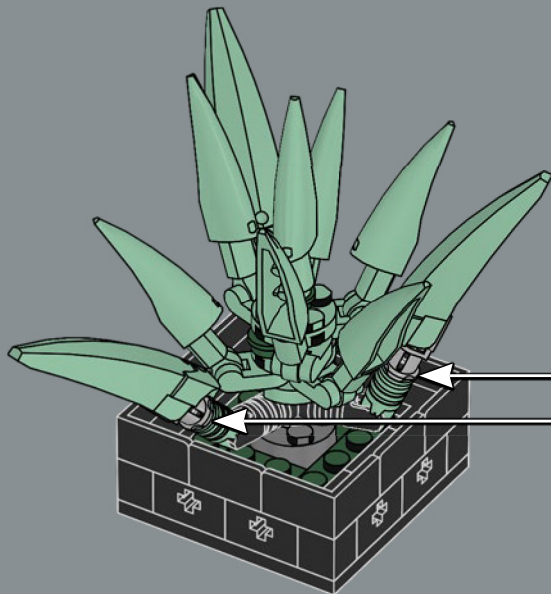



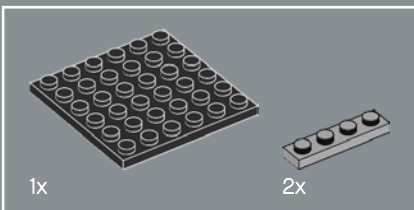
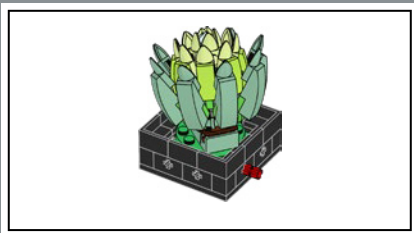

1

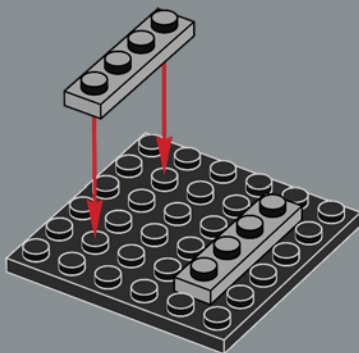

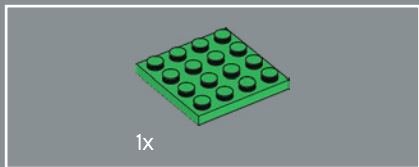

2

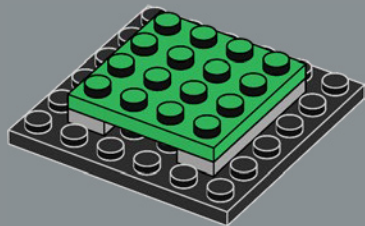

3

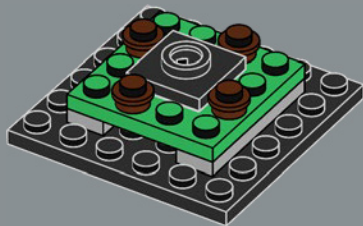

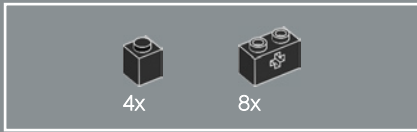

4

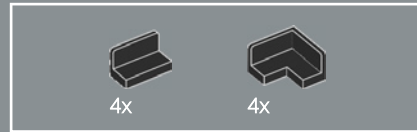
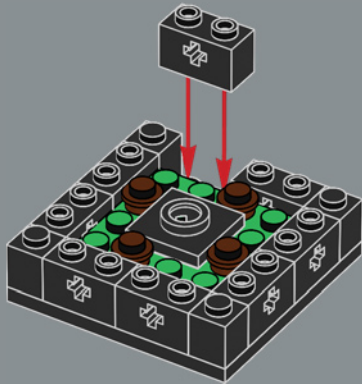

5

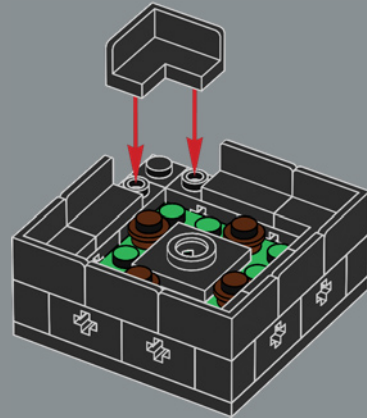

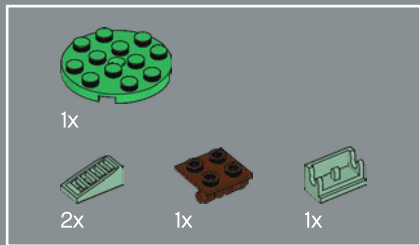

6

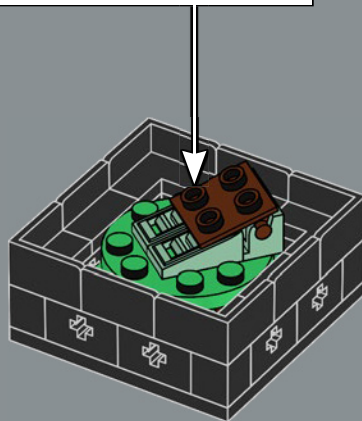
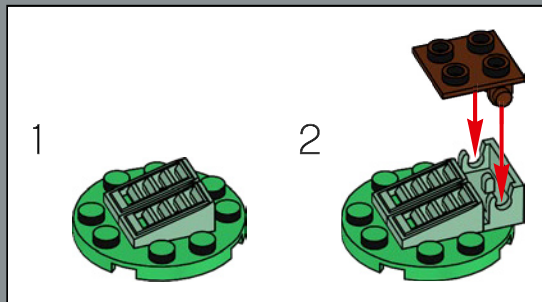

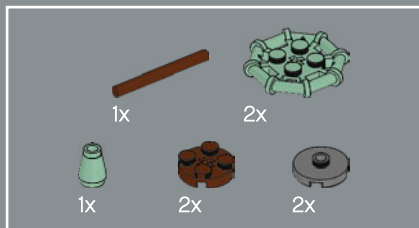

7

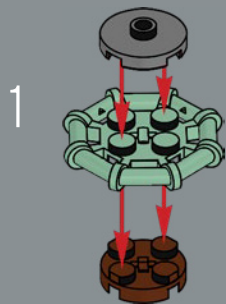

2

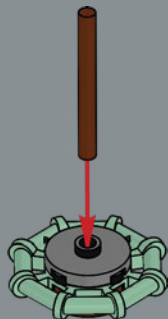

3

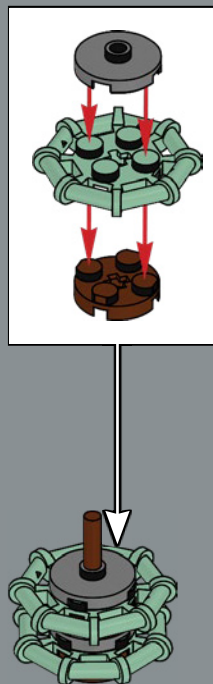

4

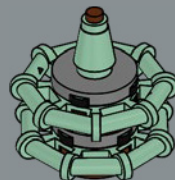

Foglie realizzate con coni gelato  
Ispirate alle piante grasse della famiglia  
*Sempervivum*, le foglie di questo modello sono  
disposte secondo un motivo a rosetta e hanno  
origine dalla cima spiraleggiante di un cono gelato.

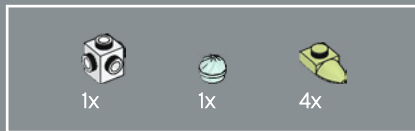
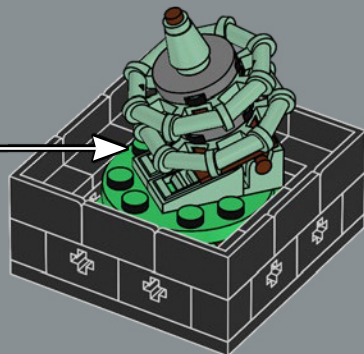

8

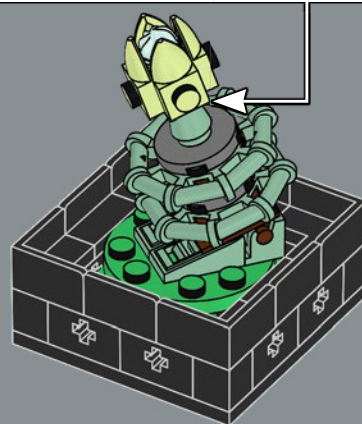
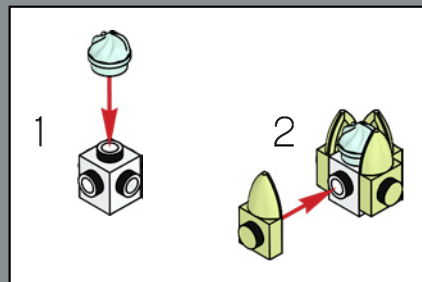



9

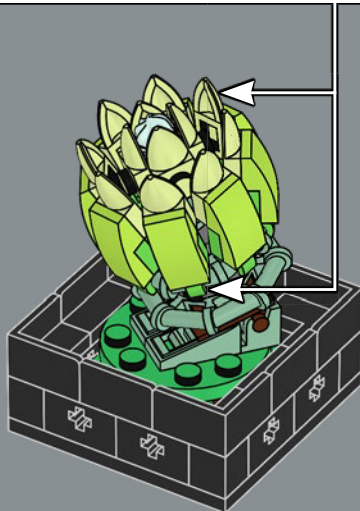
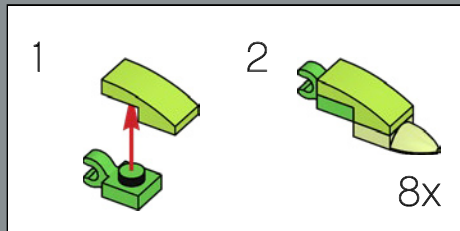



10

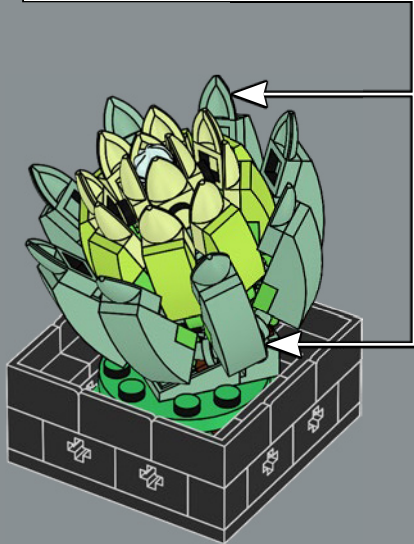
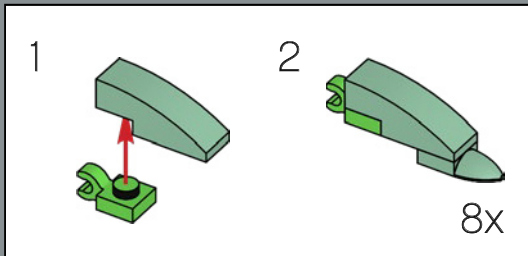



### *Sempervivum*

Le piante *Sempervivum* (sempre vivo) riescono a sopravvivere per lunghi mesi anche sotto la neve per merito della loro particolare forma a rosetta che preserva le foglie dal completo congelamento durante i mesi più rigidi.



1x

11

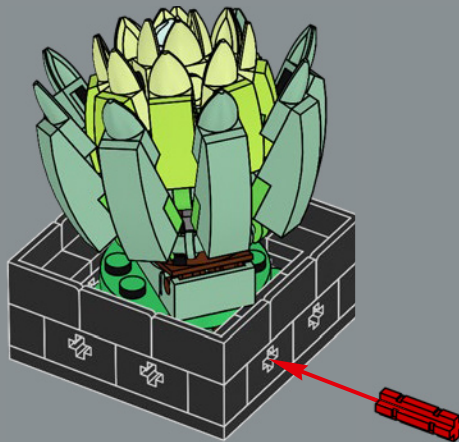

12

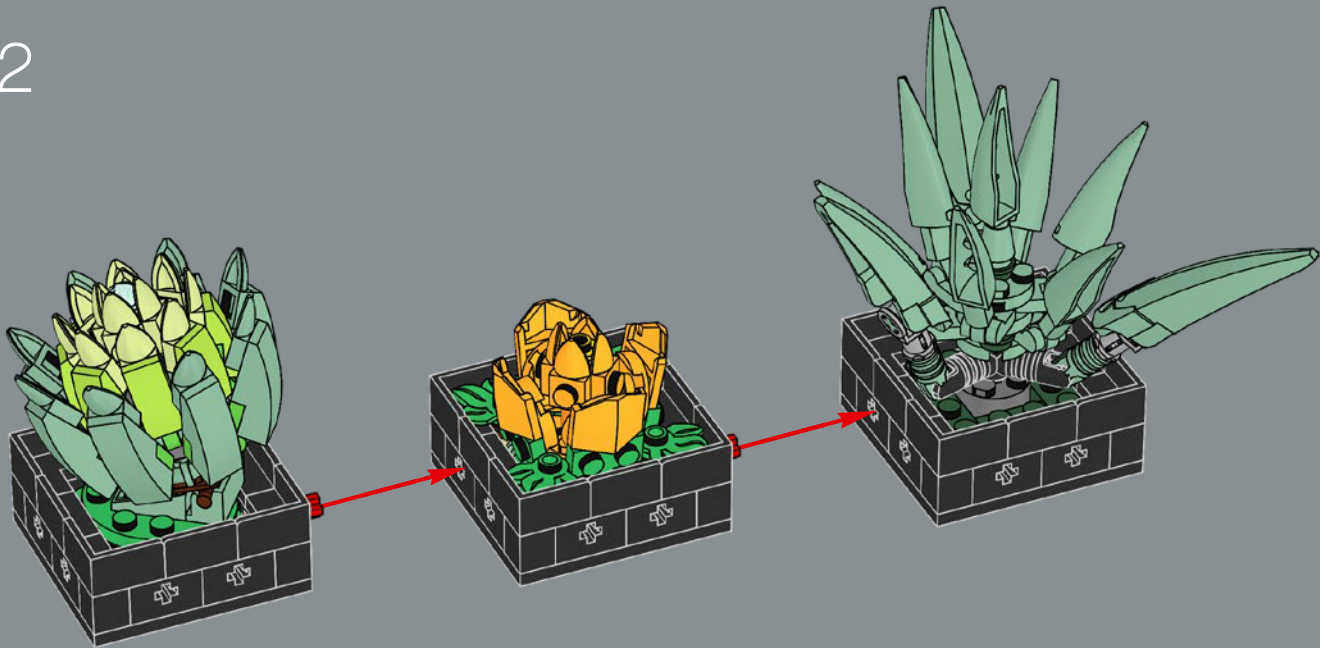

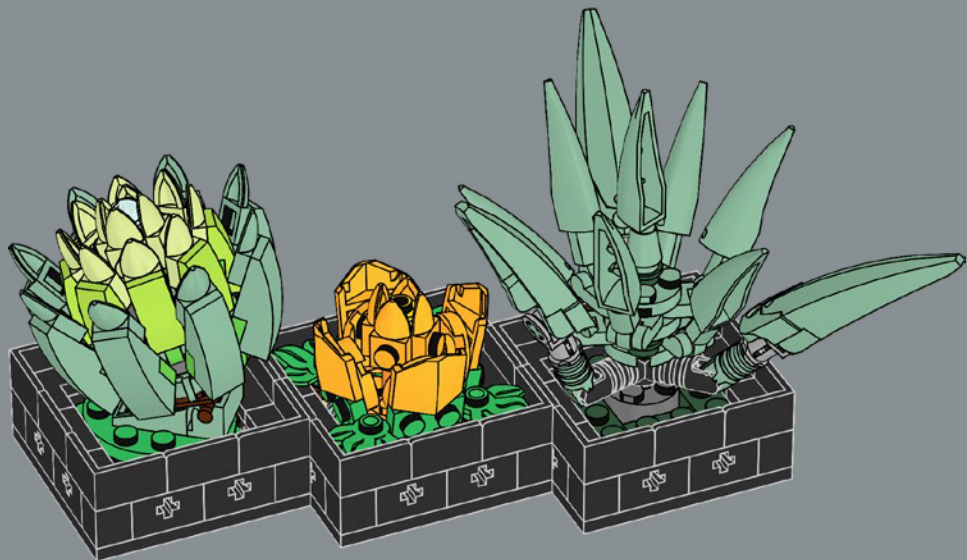

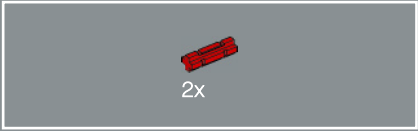

13

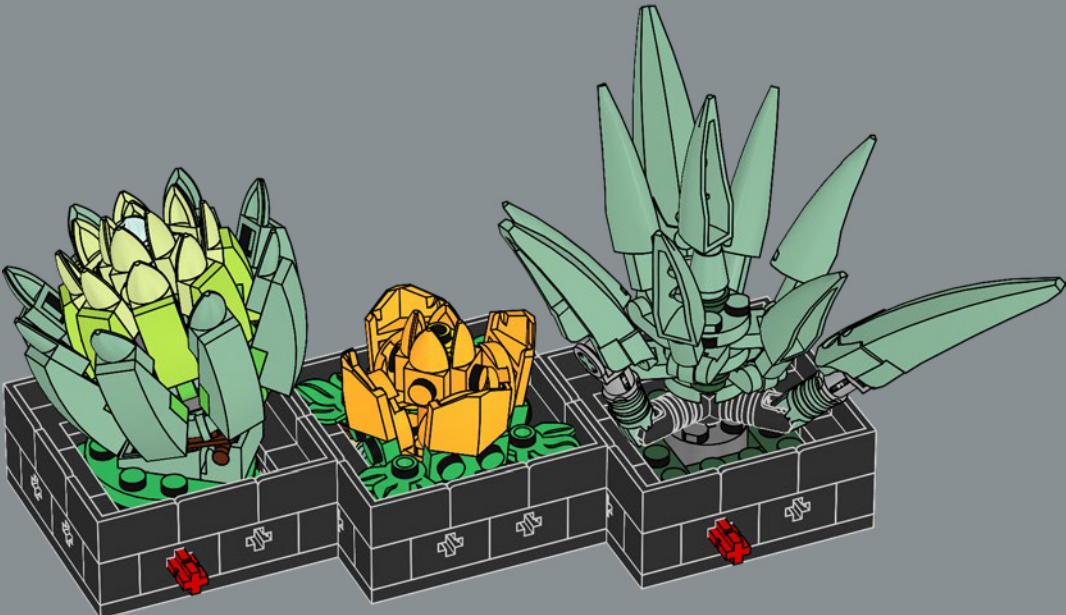

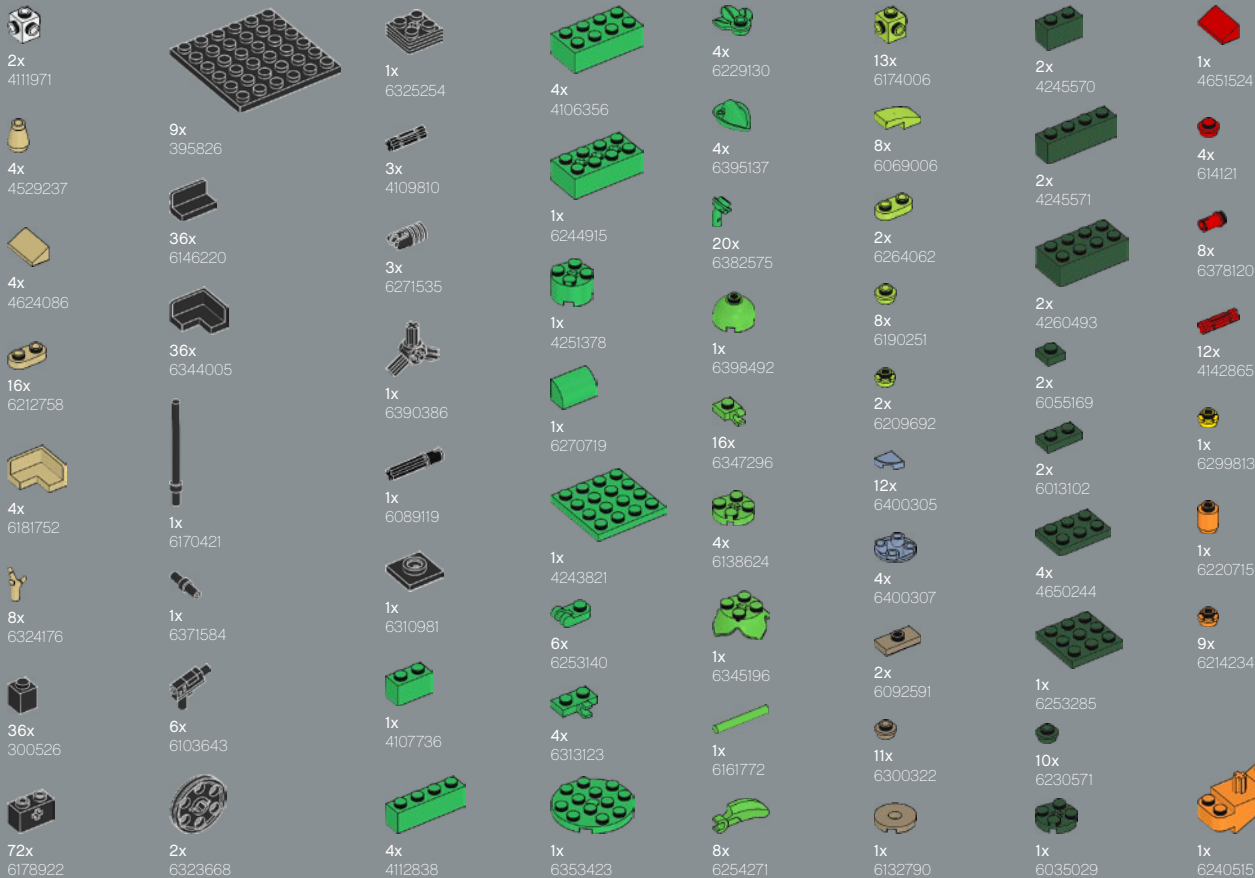

|   |  |   |   |   |  |   |  |
|---|--|---|---|---|--|---|--|
| <br>1x<br>6349342    | <br>1x<br>6400309   | <br>10x<br>6341975   | <br>12x<br>6000752   | <br>2x<br>4211159    | <br>2x<br>4211445    | <br>4x<br>6347780    | <br>12x<br>6031787  |
| <br>2x<br>6134280  | <br>3x<br>6329298 | <br>3x<br>6348250  | <br>12x<br>4539097 | <br>2x<br>6102360  | <br>1x<br>6116608  | <br>1x<br>6206151  | <br>4x<br>6058245 |
| <br>8x<br>6100237 | <br>7x<br>6398464 | <br>1x<br>6223234  | <br>4x<br>6313126  | <br>3x<br>6170468  | <br>3x<br>6380605  | <br>1x<br>6249118  | <br>4x<br>6278089 |
| <br>6x<br>6278550  | <br>8x<br>6186079 | <br>12x<br>6311108 | <br>2x<br>6219658  | <br>2x<br>6116613  | <br>1x<br>4211881  | <br>8x<br>6398491  | <br>8x<br>6258091 |
| <br>5x<br>6223219 | <br>6x<br>6223237 | <br>7x<br>6398466  | <br>6x<br>6385485  | <br>1x<br>6349130  | <br>1x<br>4249139  | <br>4x<br>6223506  | <br>8x<br>6258075 |
|                   | <br>2x<br>6155256 | <br>6x<br>6312350  | <br>4x<br>4282860  | <br>1x<br>6186045  | <br>3x<br>6115080  | <br>35x<br>6398468 | <br>8x<br>6258098 |
| <b>Customer Service</b>   | <br>2x<br>6155256 | <br>4x<br>6400434  | <br>4x<br>6400434  | <br>1x<br>6186045  | <br>2x<br>6278155  | <br>12x<br>6267420 | <br>8x<br>6258094 |
| <b>Kundenservice</b>  | <br>4x<br>4211183 | <br>4x<br>4211183  | <br>16x<br>4216581 | <br>1x<br>6167644  | <br>4x<br>6316692  | <br>7x<br>6398465  | <br>8x<br>6258095 |
| <b>Service Consommateurs</b>  | <br>1x<br>6278155 | <br>1x<br>6167644  | <br>1x<br>6167644  | <br>4x<br>6316692 | <br>8x<br>6398465 | <br>1x<br>6398490  |  |
| <b>Servicio Al Consumidor</b>   | <br>1x<br>6278155 | <br>1x<br>6167644  |   |   |  |   |  |
| <b>LEGO.com/service or dial</b>   |  |   |   |   |  |   |  |
| <b>00800 5346 5555 :</b>  |                   |                    |                    |                    |                     |   |  |
| <b>1-800-422-5346 :</b>   |                   |                    |   |   |  |   |  |



# FEEDBACK AND WIN



## FEEDBACK AND WIN

Your feedback will help shape the future development of this product series.

Please visit:

## FEEDBACK UND GEWINNEN

Dein Feedback trägt zur Weiterentwicklung dieser Produktreihe bei.

Geh auf:

## COMMENTEZ ET GAGNEZ

Vos commentaires nous aideront à concevoir les futurs produits de cette gamme.

Rendez-vous sur :

## COMENTA Y GANA

Tu opinión nos ayudará a dar forma al desarrollo de esta serie de productos en el futuro.

Visita:

## 反馈有奖

您的反馈将有助于我们在今后改进本系列产品。

请访问：

---

[LEGO.com/productfeedback](https://LEGO.com/productfeedback)

---

By completing, you will automatically enter a drawing to win a LEGO® set.

Terms & Conditions apply.

Durch Ausfüllen nimmst du automatisch an der Verlosung eines LEGO® Preises teil.

Es gelten die Teilnahmebedingungen.

En envoyant vos commentaires, vous serez automatiquement inscrit(e) à un tirage au sort qui vous permettra de remporter un prix LEGO®.

Offre soumise à conditions.

Al contestar, participarás automáticamente en el sorteo y podrás ganar un set LEGO®.

Sujeto a Términos y Condiciones.

完成我们的反馈调查,即可自动进入抽奖环节,赢取乐高®套装。

适用《条款和条件》。

