

livret 2

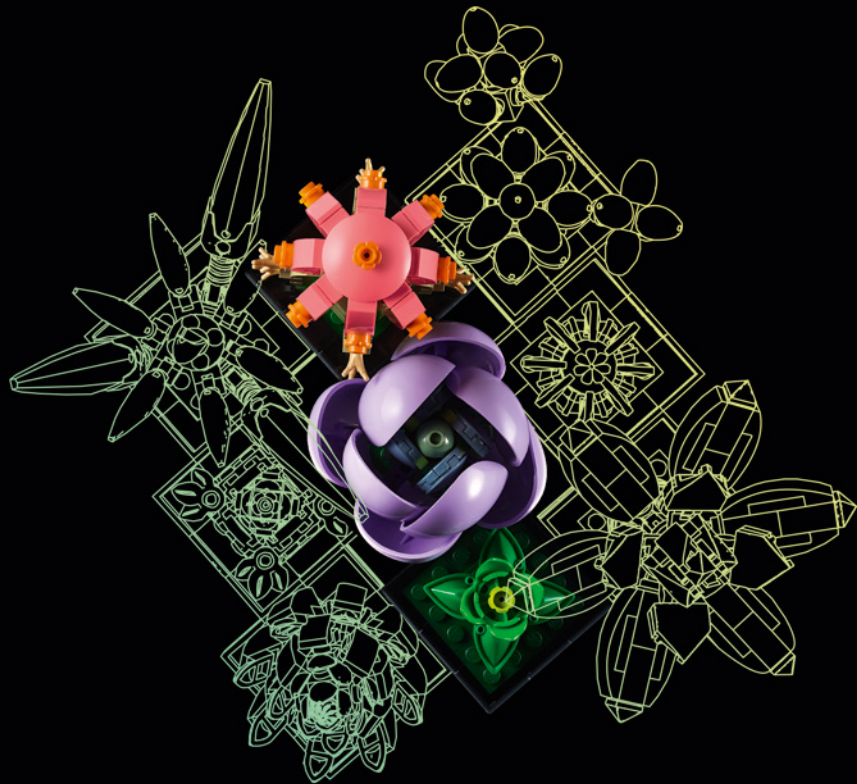

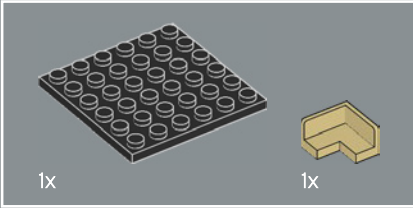

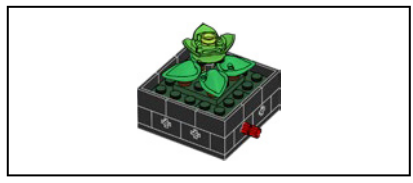

1

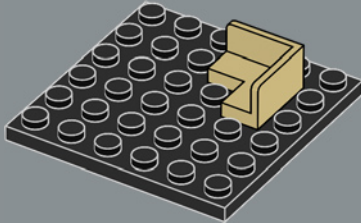

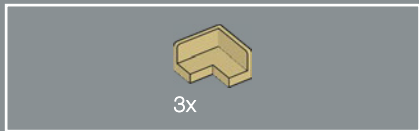

2

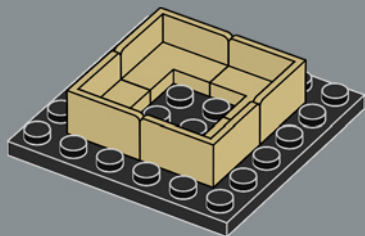

4

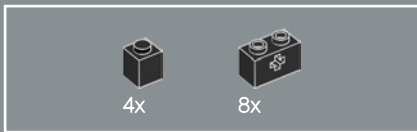

3

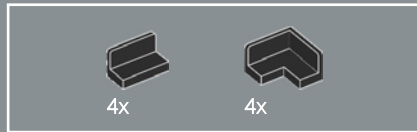
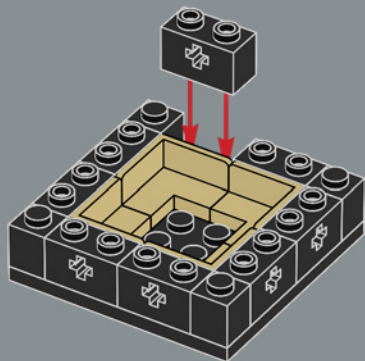

4

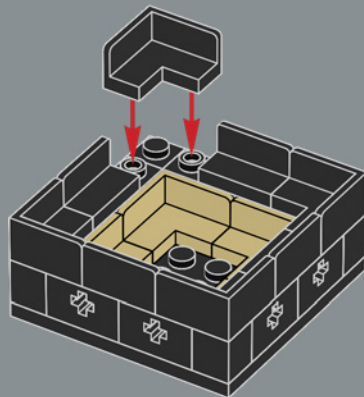

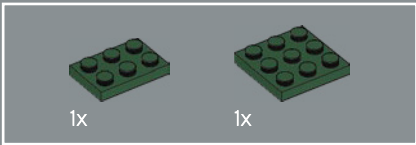

5

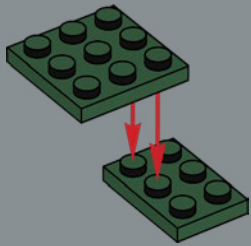

6

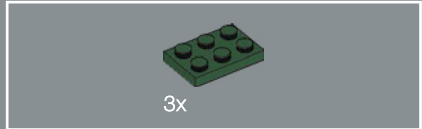

6

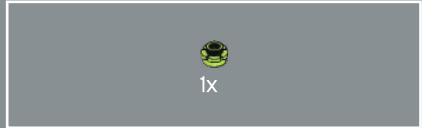
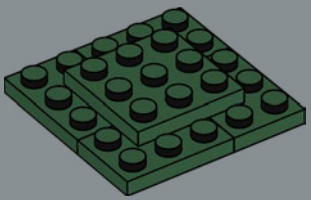

7

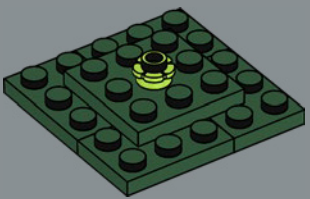



8

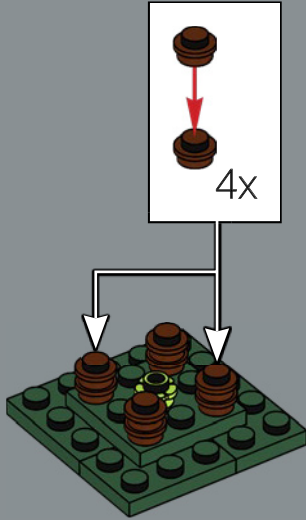

9

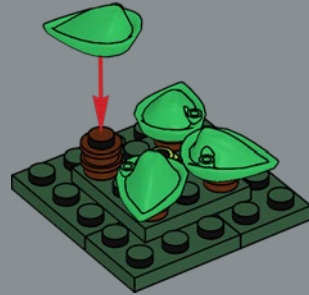



10

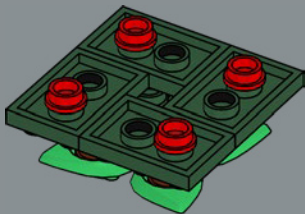

11

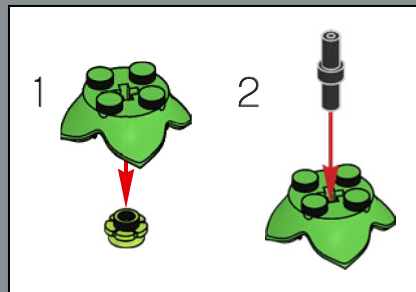

12

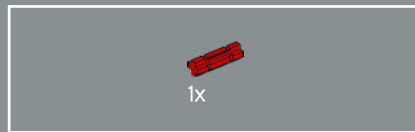
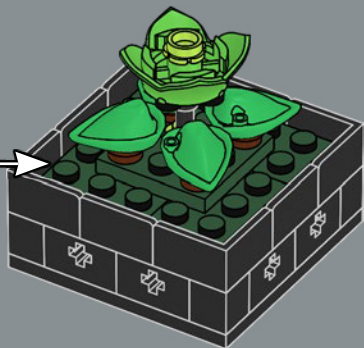

13

Il existe environ 10 000 types de succulentes cultivables. Les incroyables succulentes LEGO® sont un excellent moyen de commencer votre collection.

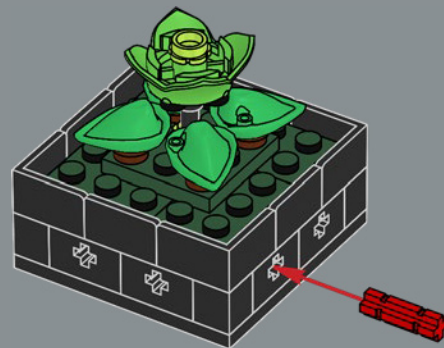

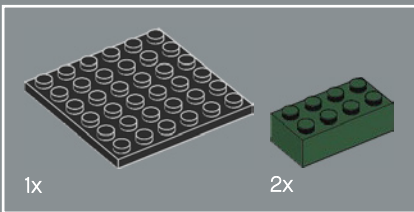
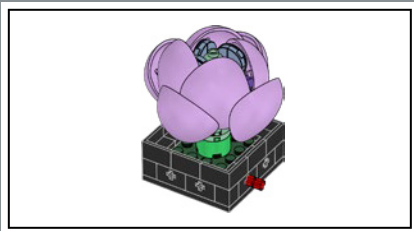

1

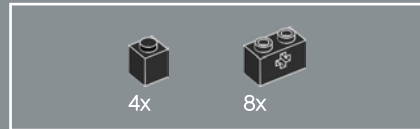
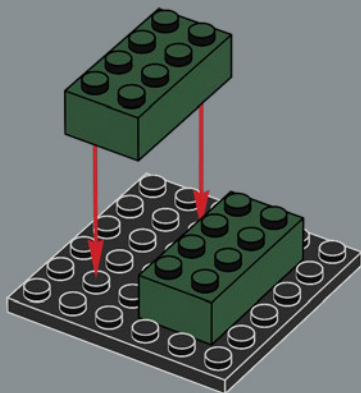

2

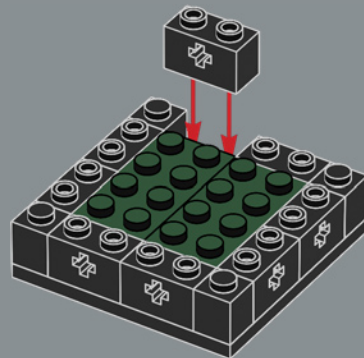

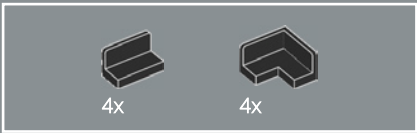

3

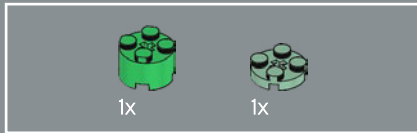
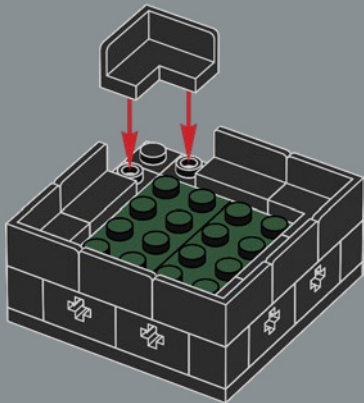

4

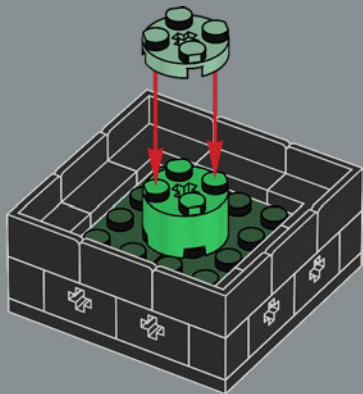

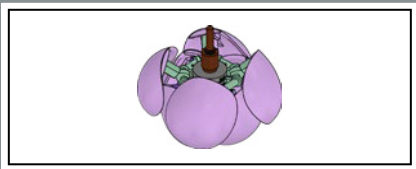

5

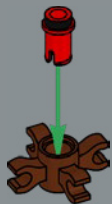

12

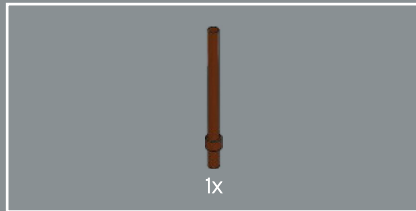

6

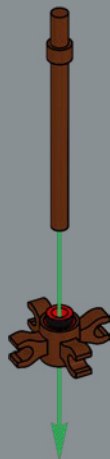

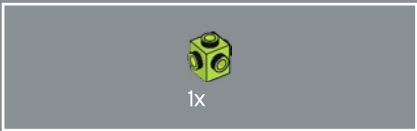

7

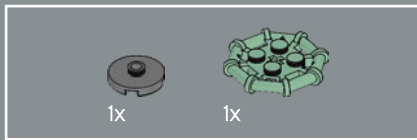

8

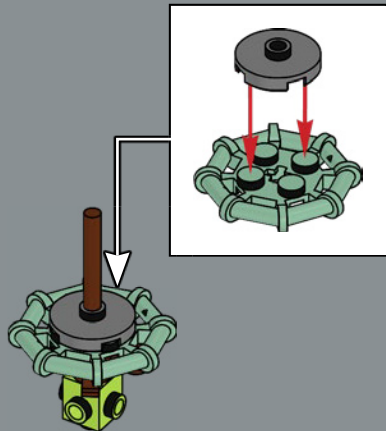



9

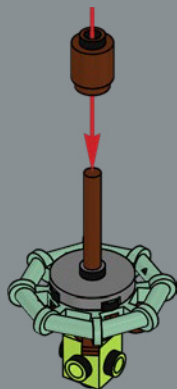

10

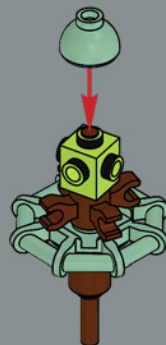



11

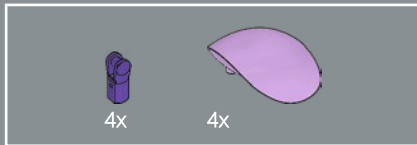
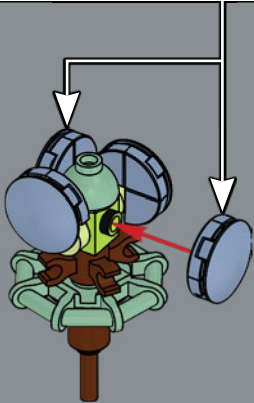
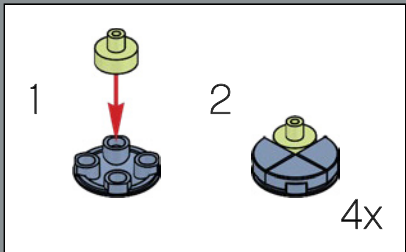

12

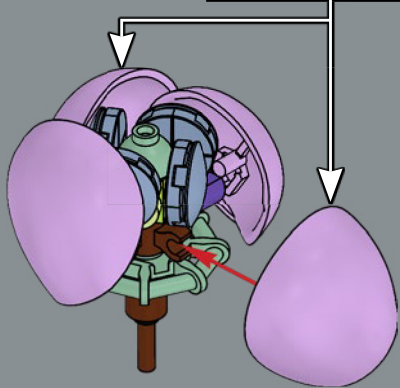
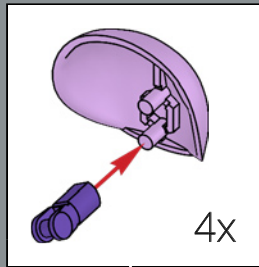

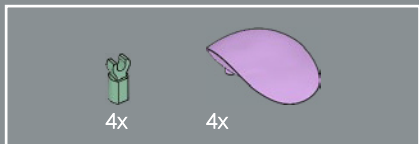

13

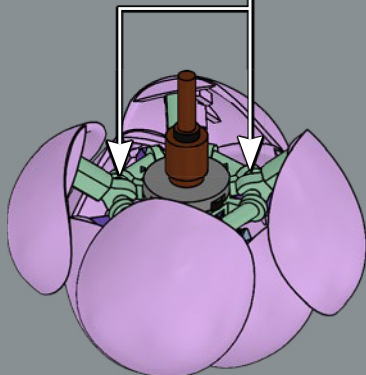
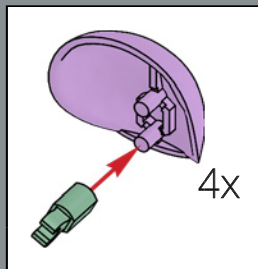

Echeveria lavande
Les variétés lavande de l'Echeveria ont de drôles de noms, comme « Afterglow » (derniers reflets) et « Cubic Frost » (gelée cubique).
Quel nom donneriez-vous à la vôtre ?

14

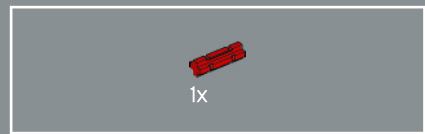
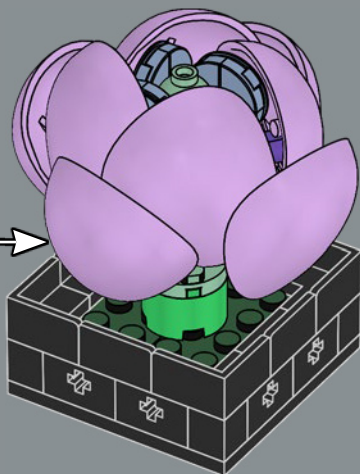

15

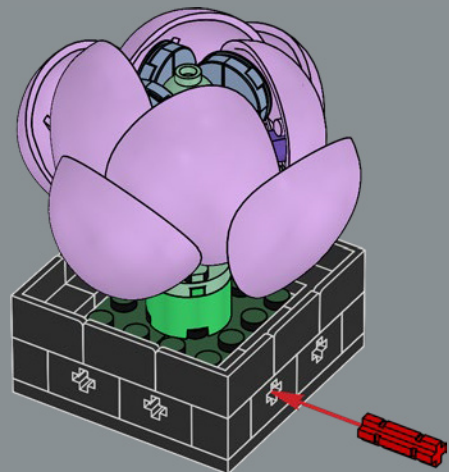

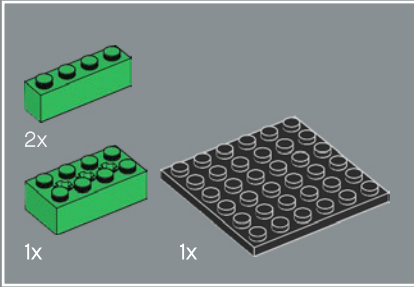
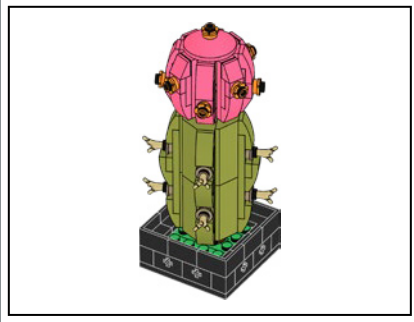

1

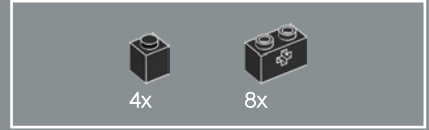
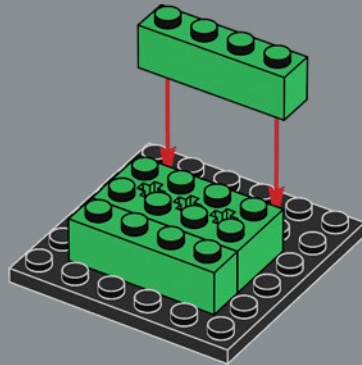

2

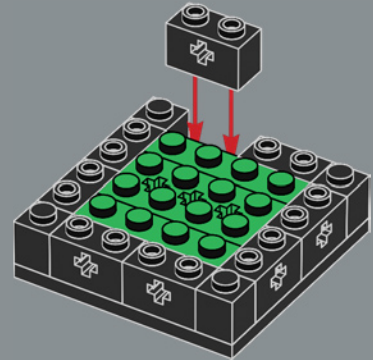

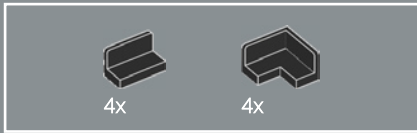

3

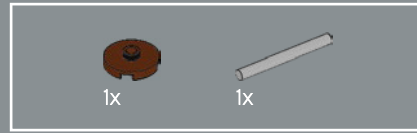
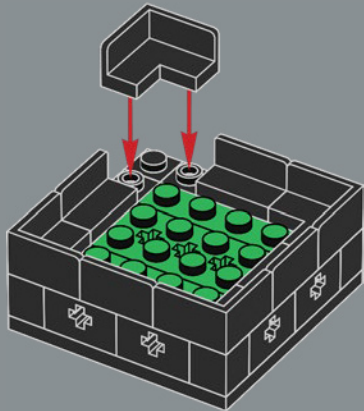

4

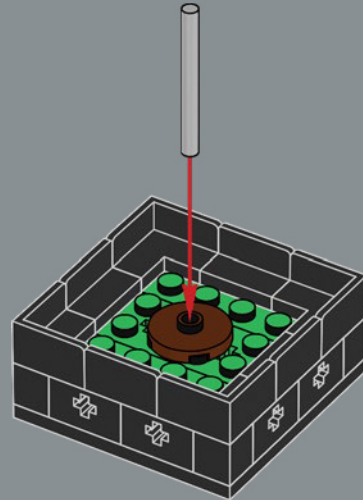

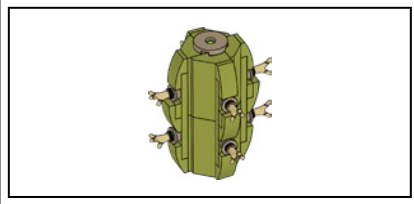

1x

1x

5

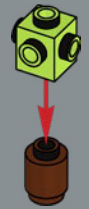

2x

6

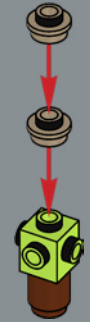



7



8



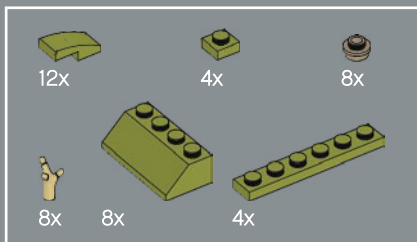
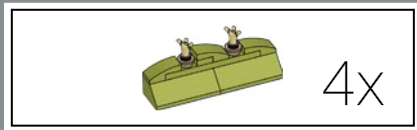

9

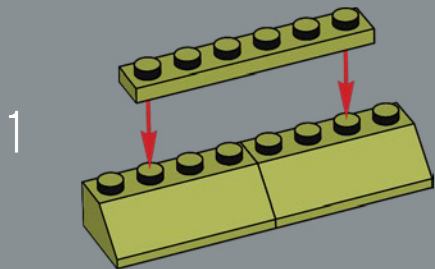

22

2

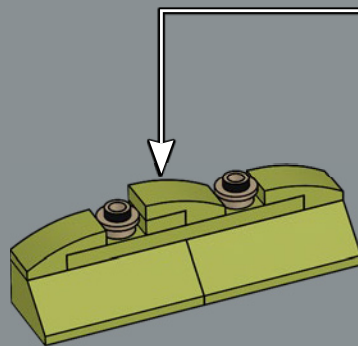

3

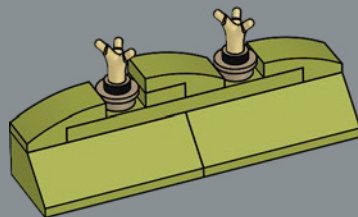

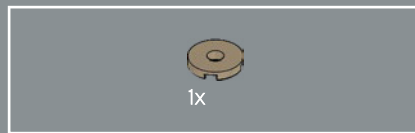
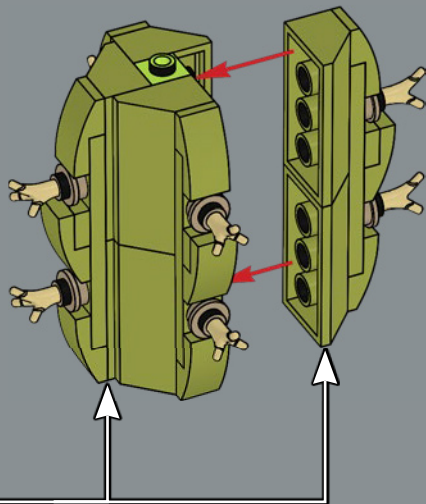

10

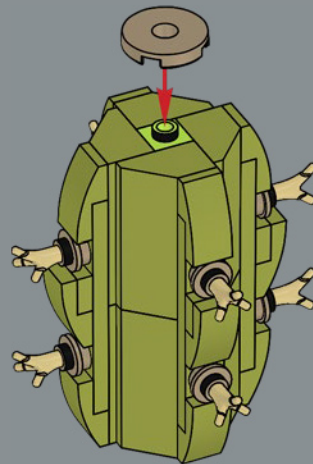

11

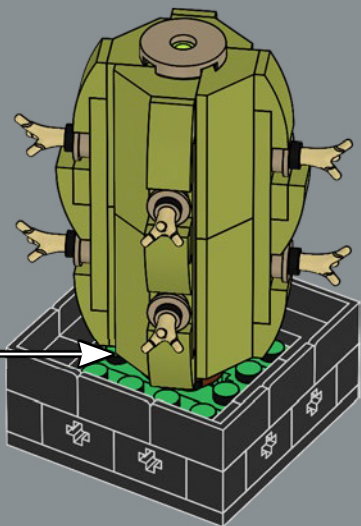

24

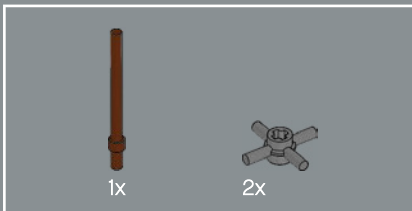
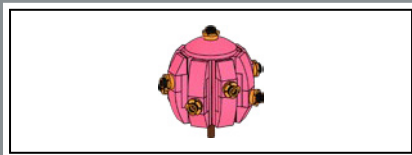

12

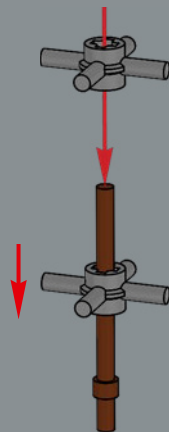



13

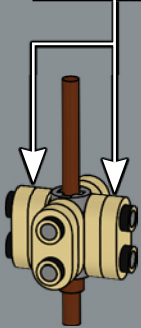
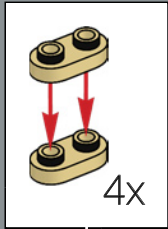

14

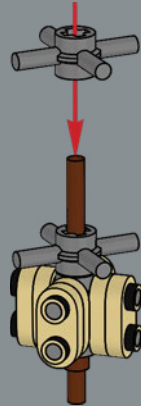

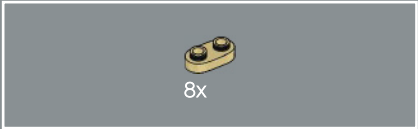

15

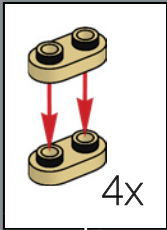

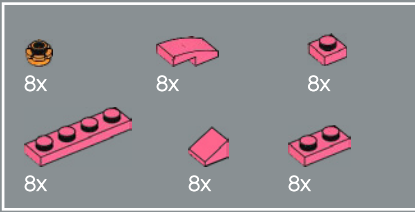

16

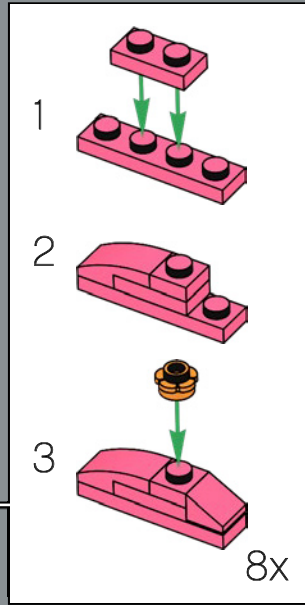
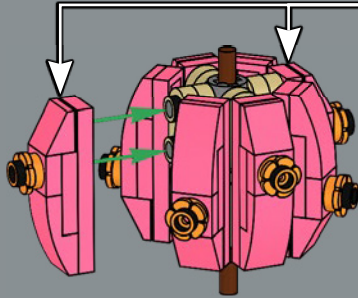



17

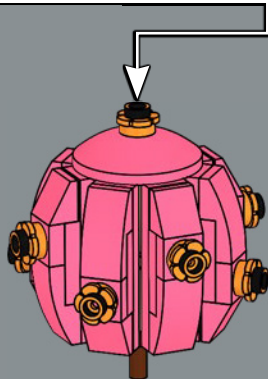
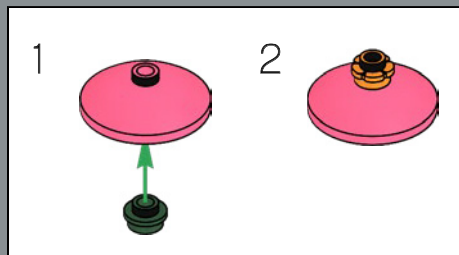

Le cactus fraise arbore une magnifique teinte rouge parce qu'il manque de chlorophylle et doit être greffé sur d'autres cactus pour se développer.

18

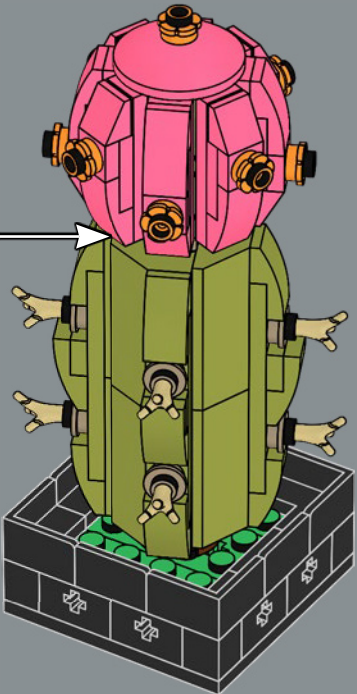

19

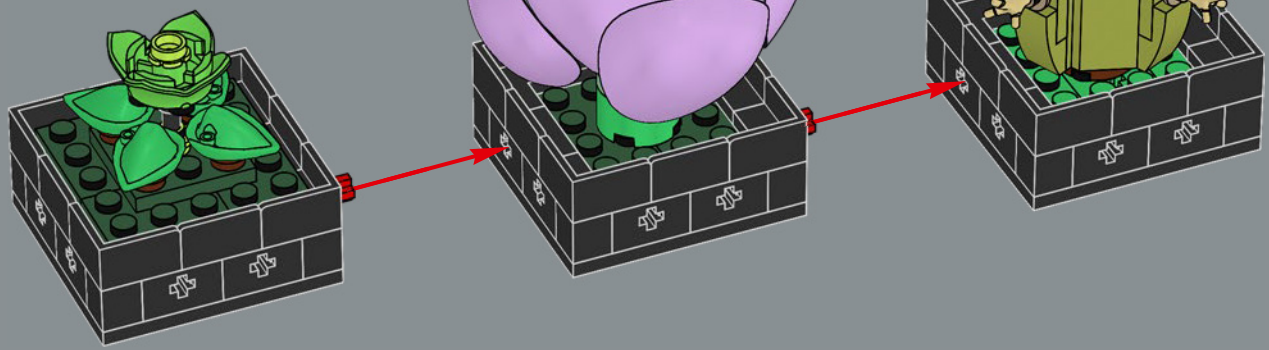



2x

20

